



by Schneider Electric

# Installation and Operation Manual

## Back-UPS™ BR1200G-GR/BR1500G-GR

### Inventory

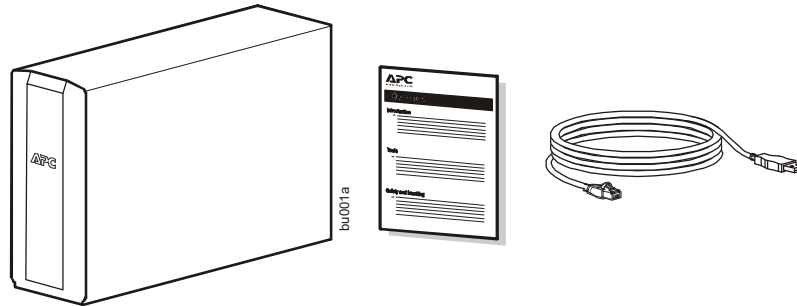

### Important Safety Messages

SAVE THESE INSTRUCTIONS - This manual contains important instructions that should be followed during installation and maintenance of the UPS and batteries.

- This UPS is intended for indoor use only.
- Do not operate this UPS in direct sunlight, in contact with fluids, or where there is excessive dust or humidity.
- Be sure the air vents on the UPS are not blocked. Allow adequate space for proper ventilation.
- The battery typically lasts for three to five years. Environmental factors impact battery life. Elevated ambient temperatures, poor quality AC power, and frequent short duration discharges will shorten battery life.
- Connect the UPS power cable directly to a wall outlet. Do not use surge protectors or extension cords.

#### CAUTION

##### **RISK OF HYDROGEN SULPHIDE GAS AND EXCESSIVE SMOKE**

- Replace the battery at least every 5 years or at the end of its service life, whichever is earlier.
- Replace the battery immediately when the UPS indicates battery replacement is necessary.
- Replace batteries with the same number and type of batteries as originally installed in the equipment.
- Replace the battery immediately when the UPS indicates a battery over-temperature condition, or when there is evidence of electrolyte leakage. Power off the UPS, unplug it from the AC input, and disconnect the batteries. Do not operate the UPS until the batteries have been replaced.

**Failure to follow these instructions can result in minor or moderate injury and equipment damage.**

For the recycling battery information, please go to [apc.com/recycle](http://apc.com/recycle)

- CAUTION: Servicing of batteries should be performed or supervised by personnel knowledgeable about batteries and the required precautions.
- CAUTION: Do not dispose of batteries in a fire. The batteries may explode.
- CAUTION: Do not open or mutilate batteries. Released material is harmful to the skin and eyes. It may be toxic.
- CAUTION: Before replacing batteries, remove conductive jewelry such as chains, wrist watches, and rings. High energy through conductive materials could cause severe burns.
- CAUTION: Failed batteries can reach temperatures that exceed the burn thresholds for touchable surfaces.
- CAUTION: A battery can present a risk of electrical shock and high short-circuit current. The following precautions should be observed when working on batteries:
  - Disconnect the charging source prior to connecting or disconnecting battery terminals.
  - Do not wear any metal objects including watches and rings.
  - Do not lay tools or metal parts on top of batteries.

- Use tools with insulated handles.
- Wear rubber gloves and boots.
- Determine if battery is either intentionally or inadvertently grounded. Contact with any part of a grounded battery can result in electric shock and burns by high short-circuit current. The risk of such hazards can be reduced if grounds are removed during installation and maintenance by a skilled person.
- This manual can be downloaded from APC by Schneider Electric Website [www.apc.com](http://www.apc.com).

## Connect the Battery

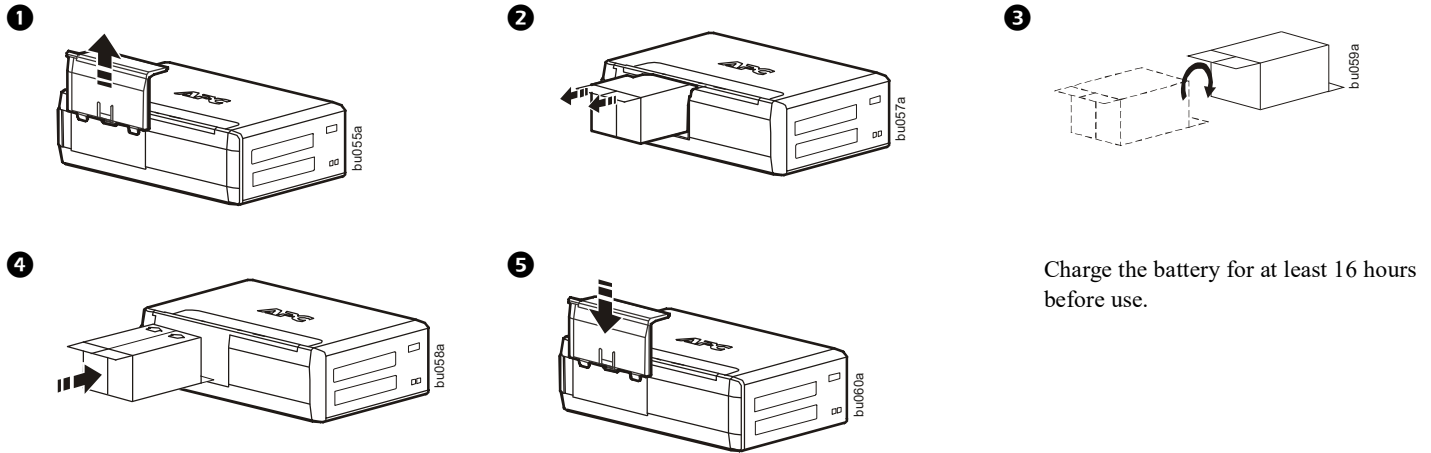

## PowerChute™ Personal Edition Software

### Overview

PowerChute Personal Edition Software allows you to use your computer to access additional power protection and management features of the Back-UPS.

Using PowerChute, you can:

- Preserve work in progress during a power outage by putting your computer into Hibernate mode. When the power returns, the computer will appear exactly as it did before the power outage.
- Configure the Back-UPS management features, such as power-saving outlets, shutdown parameters, audible alarms, and more.
- Monitor and view the status of the Back-UPS, including the estimated runtime, power consumption, power event history, and more.

Available features will vary by Back-UPS model and operating system.

If you choose not to install PowerChute, the Back-UPS will still provide backup power and power protection to connected equipment. However, you will only be able to configure a limited number of features using the display interface.

### Compatibility

PowerChute is compatible with Windows operating systems only. For a detailed list of supported operating systems, go to [www.apc.com](http://www.apc.com), select **Software & Firmware**.

For Mac operating systems, we recommend using the native shutdown application (within System Preferences) which recognizes your battery backup and allows you to configure shutdown of your system during power outages. To access this application, connect a USB cable from the Back-UPS DATA PORT (POWERCHUTE PORT) to a USB port on your computer, and see the documentation provided with your computer.

### Installation

Use the USB cable to connect the Data port on the UPS to the USB and Serial port on your computer. Download PowerChute™ Personal Edition Software from [www.apc.com/pcpe](http://www.apc.com/pcpe). Select the appropriate operating system and follow directions to download and install the software.

# Connect the Equipment

## Battery Backup and Surge Protected outlets

When the Back-UPS is receiving input power, the Surge Protection only outlets and the Battery Backup with Surge Protection outlets will supply power to connected equipment. During a power outage or other utility problems, only the Battery Backup outlets receive power for a limited time from the Back-UPS.

Connect equipment such as printers, FAX machines, scanners, or other peripherals that do not need battery backup power to the Surge Protection Only outlets. These outlets provide full time protection from surges even if the Back-UPS is switched off.

## Master and Controlled outlets

To conserve electricity, when the device connected to Master Outlet goes into Sleep or Standby mode, or turns off, the Controlled by Master device(s) will shut down as well, saving electricity.

Connect a master device, such as a desktop computer or audio/visual receiver to the Master outlet. Connect peripheral devices such as a printer, speakers, or a scanner to the Controlled by Master outlets.

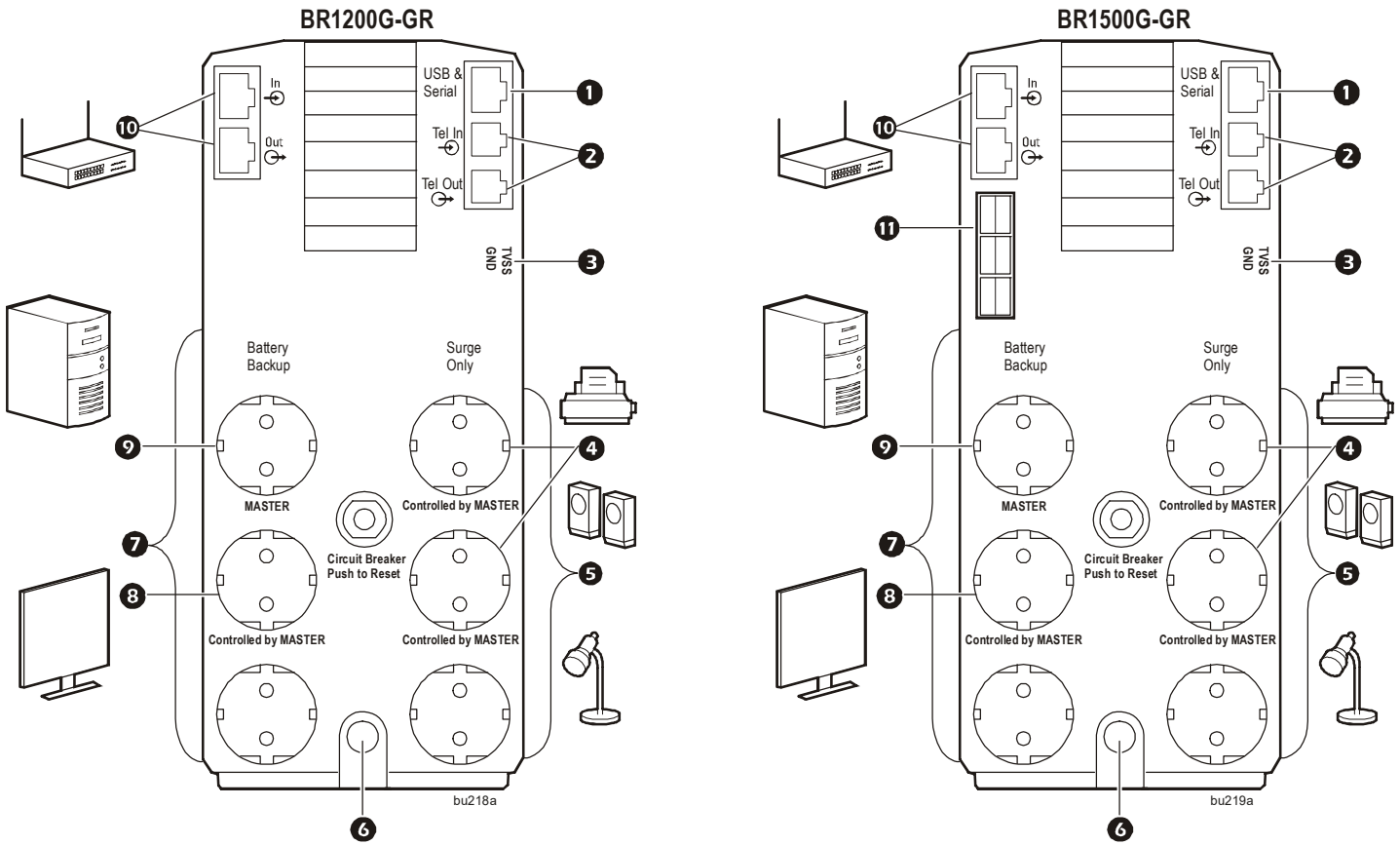

- |   |  |
|---|--|
| ❶ USB and Serial Data port                              | To use PowerChute Personal Edition, connect the supplied USB software cable or serial cable.   |
| ❷ Telephone ports                                       | Connect a telephone cable to the In port, and a modem to the Out port.   |
| ❸ Ground screw  | Connect the ground wire from another surge suppression device such as a network or data line surge protector to the ground screw on the Back-UPS.  |
| ❹ Surge Protection outlets, Controlled by Master outlet | These outlets provide surge protection during a power outage. These outlets will disconnect from A/C power during a power outage, or in the event that the Master outlet goes into Sleep mode. |
| ❺ Surge Protection outlets                              | These outlets provide full-time surge protection, when the unit is turned on or off. Connect a printer, scanner or other devices that do not require battery backup protection.                |
| ❻ AC Power Cable  | Connect the Back-UPS to A/C power.   |

<b>7 Battery Backup outlets with Surge Protection</b>	During a power outage or other utility problems, these outlets provide power from the Back-UPS battery. Connect essential equipment such as desktop computer, computer monitor, modem or other data sensitive devices to these outlets.
<b>8 Battery Backup, Controlled by Master outlet with Surge Protection</b>	During a power outage or other utility problems, these outlets provide power from the Back-UPS battery.
	These outlets will disconnect from A/C power during a power outage, or in the event that the Master outlet goes into Sleep mode.
	Connect essential equipment such as desktop computer, computer monitor, modem or other data sensitive devices to these outlets.
<b>9 Master outlet</b>	Connect the master device to this outlet, in most scenarios, this will be the main computer.
<b>10 Gigabit Ethernet surge-protected ports</b>	Use an Ethernet cable to connect a modem to the IN port, and a computer to the OUT port.
<b>11 External Battery Pack connector BR1500G-GR model only</b>	Connect an external battery pack to provide additional battery backup runtime.

# Operation

## Power-Saving Function



To conserve electricity, configure the Back-UPS to recognize a Master device, such as a desktop computer or an A/V receiver, and Controlled peripheral devices, such as a printer, speakers, or a scanner. When the Master device goes into Sleep or Standby mode, or is switched OFF, the Controlled device(s) will be switched off as well, saving electricity.

**Enable the Power-Saving function.** Press and hold MUTE and DISPLAY simultaneously for two seconds. The Back-UPS will beep to indicate that the feature is enabled. The leaf icon on the display will illuminate.

**Disable the Power-Saving function.** Press and hold MUTE and DISPLAY simultaneously for two seconds. The Back-UPS will beep to indicate that the feature is disabled. The leaf icon on the display will go dark.

**Setting the threshold.** The amount of power used by a device in Sleep or Standby mode varies between devices. It may be necessary to adjust the threshold at which the Master outlet signals the Controlled outlets to shut down.

1. Be sure a master device is connected to the Master outlet. Put that device into Sleep or Standby mode, or turn it OFF.
2. Press DISPLAY and MUTE simultaneously and hold for six seconds, until the leaf icon flashes three times and the Back-UPS beeps three times.
3. The Back-UPS will now recognize the threshold level of the Master device and save it as the new threshold setting.

## Power-Saving Display

The display interface can be configured to be continuously illuminated, or to save energy, it can be configured to go dark after a period of inactivity.

1. Full Time Mode: Press and hold DISPLAY for two seconds. The display will illuminate and the Back-UPS will beep to confirm the Full-Time mode.
2. Power-Saving Mode: Press and hold DISPLAY for two seconds. The display will go dark and the Back-UPS will beep to confirm the Power-Saving mode. While in Power-Saving Mode, the display will illuminate if a button is pressed, it goes dark after 60 seconds of no activity.

## Unit sensitivity

Adjust the sensitivity of the Back-UPS to control when it will switch to battery power; the higher the sensitivity, the more often the Back-UPS will switch to battery power.

1. Be sure the Back-UPS is connected to A/C power, but is OFF.
2. Press and hold the POWER button for six seconds. The LOAD CAPACITY bar will flash on and off, indicating that the Back-UPS is in programming mode.
3. Press POWER again to rotate through the menu options. Stop at selected sensitivity. The Back-UPS will beep to confirm the selection.

Low sensitivity



156-300 Vac

*Input voltage is extremely low or high. (Not recommended for computers.)*

Medium sensitivity (Default)



176-294 Vac

*The Back-UPS frequently switches to battery power.*

High sensitivity



176-288 Vac

*The connected equipment is sensitive to voltage fluctuations.*

Use the three buttons on the front panel of the Back-UPS and the display interface to configure the Back-UPS.

**Front panel**

- ① Mute button
- ② Power On/Off button
- ③ Display button
- ④ Display interface

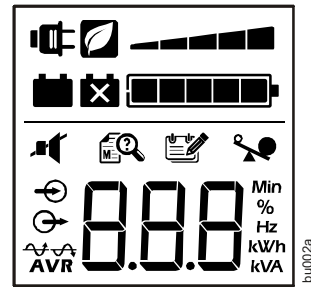
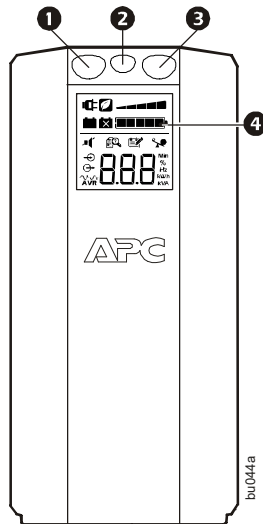

**On Line:** The Back-UPS is supplying conditioned A/C power to connected equipment



**Power-Saving:** Master and Controlled outlets are enabled, saving power when the master device goes into sleep or standby mode



**Load Capacity:** The load is indicated by the number of sections illuminated, one to five. Each bar represents 20% of the load.



**Battery Charge:** The battery charge level is indicated by the number of sections illuminated. When all five blocks are illuminated, the Back-UPS is at full charge. When one block is filled, the Back-UPS is near the end of its battery capacity, the indicator will flash and the Back-UPS will beep continuously.



**Overload:** The power demand from the load has exceeded the capacity of the Back-UPS.



**Event:** The event counter shows the number of events that occurred that caused the Back-UPS to switch to on-battery operation.



**Automatic Voltage Regulation:** The Back-UPS can compensate for high or low input voltage.



When illuminated, the Back-UPS is compensating for low input voltage.



When illuminated, the Back-UPS is compensating for high input voltage.



Input voltage.



Output voltage.



**System Events:** The system has a detected fault. The event number will illuminate on the display interface. See “System Events” on page 7.



**Mute:** If the line through the speaker icon is illuminated, the audible alarm has been turned off.



**Replace Battery:** The battery is not connected or is nearing the end of its useful life. Replace the battery.





**On Battery:** The Back-UPS is supplying battery backup power to the connected equipment, it will beep four times every 30 seconds.

# Alerts and System Events

## Audible Alerts

<b>Four Beeps Every 30 Seconds</b>	Back-UPS is running on battery. You should consider saving any work in progress.
<b>Continuous Beeping</b>	Low battery condition and battery run-time is very low. Promptly save any work in progress, exit all open applications, and shut down the operating system.
<b>Continuous tone</b>	Battery Backup outputs are overloaded.
<b>Chirps for 1 Minute every 5 hours</b>	Battery is not able to pass the automatic diagnostic test and should be replaced.

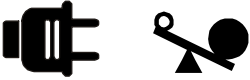
## Event Icons

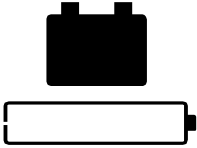
If these icons are illuminated	This may be the problem
	The Back-UPS is operating on A/C power, but is overloaded. Disconnect one of the items connected to the Back-UPS. If the Overload icon stops flashing, the Back-UPS is no longer overloaded and will continue to operate normally.
	The Back-UPS is operating on battery power, but is overloaded. Disconnect one of the items connected to the Back-UPS. If the Overload icon stops flashing, the Back-UPS is no longer overloaded and will continue to operate normally.
	The Back-UPS is operating on A/C power, but the battery is not functioning properly. Contact APC Customer Service to order a replacement battery. See “Replace Battery” on page 10.
	The Back-UPS is operating on battery power and the battery power is getting low. Shut down all connected equipment to avoid losing unsaved data. When possible, connect the Back-UPS to A/C power to recharge the battery.





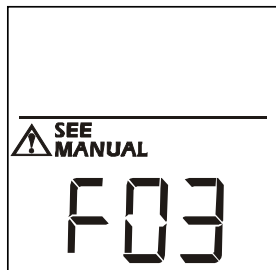







## System Events

The Back-UPS will display these event messages. Contact APC Technical Support.



<b>F01</b>	On-Battery Overload	Turn the Back-UPS off. Disconnect non-essential equipment from the Battery Backup outlets and the turn Back-UPS on.
<b>F02</b>	On-Battery Output Short	Turn the Back-UPS off. Disconnect non-essential equipment from the Battery Backup outlets and the turn Back-UPS on.
<b>F03</b>	On-Battery Xcap Overload	Events F03-F09 cannot be corrected by the user. Contact APC Technical Support for assistance.
<b>F04</b>	Clamp Short	
<b>F05</b>	Charge Status	
<b>F06</b>	Relay Welding	
<b>F07</b>	Temperature	
<b>F08</b>	Fan Condition	
<b>F09</b>	Internal Event	

# Function Button Quick Reference

Function	Button	Timing (seconds)	UPS Status	Description
<b>Power</b>				
Power On		0.2	Off	Press POWER to start receiving input A/C power. If A/C input power is not available, the Back-UPS will run on battery power.
Power Off		2	On	The Back-UPS is not receiving input A/C power, but is providing surge protection.
<b>Display</b>				
Status Inquiry		0.2	On	Verify the status or condition of the Back-UPS. The LCD will illuminate for 60 seconds.
Full-Time/Power-Saving mode		2	On	The LCD will illuminate and the Back-UPS will beep to confirm the Full-Time mode. The LCD will go dark and the Back-UPS will beep to confirm the Power-Saving mode. While in Power-Saving Mode, the LCD will illuminate if a button is pressed, then goes dark after 60 seconds of no activity.
<b>Mute</b>				
Event Specific		0.2	On	Disable any audible alarms caused by an event.
General Status Enable/Disable		2	On	Enable or disable the audible alarms. The Mute icon will illuminate and the Back-UPS will beep one time. The Mute function will not activate unless the Back-UPS is operating on battery power.
<b>Sensitivity</b>				
		6	Off	The Load Capacity icon will blink, indicating that the Back-UPS is in programming mode. Use the POWER button to scroll through Low, Medium, and High, stop at selected sensitivity. The Back-UPS will beep to confirm selection. See Configuration for details.
<b>Master/Controlled outlet Enable/Disable</b>				
		2	On	The leaf icon will go dark indicating that the Master Outlet feature is disabled or illuminate to indicate the Master Outlet feature is enabled. The Back-UPS will beep once.
<b>Master/Enable Threshold Calibration</b>				
		6	On	While calibrating the threshold setting, the device connected to the Master Outlet should be turned off or placed in Standby or Sleep mode. Upon completion, Power-Saving icon will flash 3 times and beep 3 times.
<b>Self-Test (manual)</b>				
		6	On	The Back-UPS will perform a test of the internal battery. Note: This will happen automatically when the Back-UPS is turned ON.
<b>Event Reset</b>				
		0.2	On	When the Event screen is visible, press and hold DISPLAY, then press POWER, to clear the utility event counter.
<b>Status Reset</b>				
		2	Event detected	After an event has been detected and identified, press POWER to remove the visual indication and return to standby status.



# Troubleshooting

Problem	Possible Cause	Corrective Action
<b>Back-UPS will not turn on.</b>	The Back-UPS is not connected to A/C power.	Be sure that the Back-UPS is securely connected to an A/C outlet.
	The circuit breaker has been tripped.	Disconnect non-essential equipment from the Back-UPS. Reset the circuit breaker. Re-connect equipment one item at a time. If the circuit breaker is tripped again, disconnect the device that caused the trip.
	The internal battery is not connected.	Connect the battery.
	The A/C input voltage is out of range.	Adjust the transfer voltage and sensitivity range.
<b>The Back-UPS does not provide power during an A/C power outage.</b>	Be sure that essential equipment is not plugged into a SURGE ONLY outlet.	Disconnect equipment from the SURGE ONLY outlet and re-connect to a Battery Backup outlet.
<b>The Back-UPS is operating on battery power, while connected to A/C power.</b>	The plug has partially pulled out of the wall outlet, the wall outlet is no longer receiving A/C power, or the circuit breaker has been tripped.	Be sure that the plug is fully inserted into the wall outlet. Be sure that the wall outlet is receiving A/C power by checking it with another device.
	The Back-UPS is performing an automatic self test.	No action is necessary.
	The A/C input voltage is out of range, the frequency is out of range, or the waveform is distorted.	Adjust the transfer voltage and sensitivity range.
<b>The Back-UPS does not provide the expected amount of backup time.</b>	Battery Backup outlets may be fully or improperly loaded.	Disconnect non-essential equipment from the Battery Backup outlets and connect the equipment to SURGE ONLY outlets.
	The battery was recently discharged due to a power outage and has not fully recharged.	Charge the battery cartridge for 16 hours.
	The battery has reached the end of its useful life.	Replace the battery.
<b>The REPLACE BATTERY indicator is illuminated.</b>	The battery has reached the end of its useful life.	Replace the battery.
<b>The OVERLOAD indicator is illuminated.</b>	The equipment connected to the Back-UPS is drawing more power than the Back-UPS can provide.	Disconnect non-essential equipment from the Battery Backup outlets and connect the equipment to SURGE ONLY outlets.
<b>The SYSTEM EVENT indicator is illuminated, all the front panel indicators are flashing.</b>	There is an internal fault detected.	Determine which internal detected fault message is displayed by matching the number displayed on the LCD with the corresponding event Message (see System Events) and contact APC Technical Support.
<b>Power is not supplied to some outlets.</b>	Power to the Controlled outlets has intentionally been turned off.	Confirm that the correct peripherals are connected to Controlled outlets. If this feature is not desired, disable the Power-Saving Master and Controlled outlets.
<b>The Controlled outlets are not supplying power, even though the Master device is not in sleep mode.</b>	The Master Outlet threshold may be incorrectly set.	Adjust the threshold when the Master outlet signals the Controlled outlets to shut down.

# Specifications

Model	BR1200G-GR	BR1500G-GR
VA	1200 VA	1500 VA
Maximum Load	720 W	865 W
Nominal Input Voltage	230 V	
Online Input Voltage Range	176 V- 294 V	
Automatic Voltage Regulation	188 V- 216 V +11.2% 252 V- 282 V -11.2%	
Frequency Range	50/60 Hz ± 1 Hz	
On-battery wave shape	Step-approximated sine-wave	
Typical Recharge Time	8 hours	
Transfer Time	10 ms, maximum	
Operating Temperature	0° to 40° C (32° to 104° F)	
Storage Temperature	5° to 45° C (23° to 113° F)	
Unit Dimensions	30.1 × 11.2 × 39 cm (11.9 × 4.4 × 15.3 in)	
Unit Weight	12.8 kg (28.2 lbs)	13.4 kg (29.5 lbs)
Interface	Serial, USB	
On-Battery Runtime	Go to: <a href="http://www.apc.com">www.apc.com</a>	
Replacement Battery	The battery cartridge typically lasts 3 to 6 years. Environmental factors impact battery life. High temperatures, poor quality A/C power, and frequent, short deration discharges will shorten battery life. To order replacement battery cartridge, see <i>Replace Battery</i> .	
Humidity	0 to 95% relative humidity, non-condensing	
Pollution Degree	2	
Overvoltage category	II	
Applicable power grid distribution system	TN Power system	
Applicable standards	IEC 62040-1	
International Protection Code	IP20	

## Replace Battery

Deliver the used battery to a recycling facility.



Replace the used battery with an APC by Schneider Electric approved battery. Replacement batteries can be ordered through the APC by Schneider Electric Web site, [www.apc.com](http://www.apc.com). Battery replacement part for Back-UPS BR1200G-GR and BR1500G-GR is **APCRBC124**.



# APC by Schneider Electric IT Customer Support Worldwide

For country specific customer support, go to the APC by Schneider Electric Web site, [www.apc.com](http://www.apc.com).

## Warranty

The standard warranty is two (2) years from the date of purchase. APC standard procedure is to replace the original unit with a factory reconditioned unit. Customers who must have the original unit back due to the assignment of asset tags and set depreciation schedules must declare such a need at first contact with an APC Technical Support representative. APC will ship the replacement unit once the defective unit has been received by the repair department, or cross-ship upon the receipt of a valid credit card number. The customer pays for shipping the unit to APC. APC pays ground freight transportation costs to ship the replacement unit to the customer.

## Service

If the unit requires service, do not return it to the dealer. Follow these steps:

1. Review the TROUBLESHOOTING section of the manual to eliminate common problems.
2. If the problem persists, contact APC Customer Support through the APC Web site, [www.apc.com](http://www.apc.com).
  - a. Note the model number and serial number and the date of purchase. The model and serial numbers are located on the rear panel of the unit and are available through the LCD display on select models.
  - b. Call APC Customer Support and a technician will attempt to solve the problem over the phone. If this is not possible, the technician will issue a Returned Material Authorization Number (RMA#).
  - c. If the unit is under warranty, the repairs are free.
  - d. Service procedures and returns may vary internationally. Refer to the APC Web site for country specific instructions.
3. Pack the unit properly to avoid damage in transit. Never use foam beads for packaging. Damage sustained in transit is not covered under warranty. **For the UPS, always DISCONNECT THE BATTERY before shipping in compliance with U.S. Department of Transportation (DOT) and IATA regulations.** The battery may remain in the unit.
4. Write the RMA# provided by Customer Support on the outside of the package.
5. Return the unit by insured, pre-paid carrier to the address provided by Customer Support.