



P/N: 15G065124000AK V1.0

# Quick Installation Guide 2U4G-C621WS



## Cable List

Item	Description
A	GPU Power Cable (Red & Orange / L=800mm ; Blue & Green / L=500mm)
B	PMBus Cable (L=390mm)
C	Power ATX Cable (8PIN) (L=350mm)
D	Power ATX Cable (24 PIN TO 24 PIN ) (L=150mm)
E	SWB Power Cable (SWB CABLE 2*6P(3.0)PWR; L=400mm)
F	HDD Power Cable (HDD PWR 2*4P TO 2*6P; L=800mm)
G	MINISAS HD to OcuLink (S/T) Cable (L=710mm)
H	SLIMLINE Cables (L=800mm / 500mm)
I	USB Cable (25P 2.54HSG TO 2.0HSG) (L=1.25M)
J	Front Control Cable (2*10P(2.0)TO 2*10P+2*5P(2.54))
K	SATA 6G Cable (L=820mm)
L	MNG Cable (L=960mm)
M	SGPIO Cable (L=615mm)

## Power Cable Connection

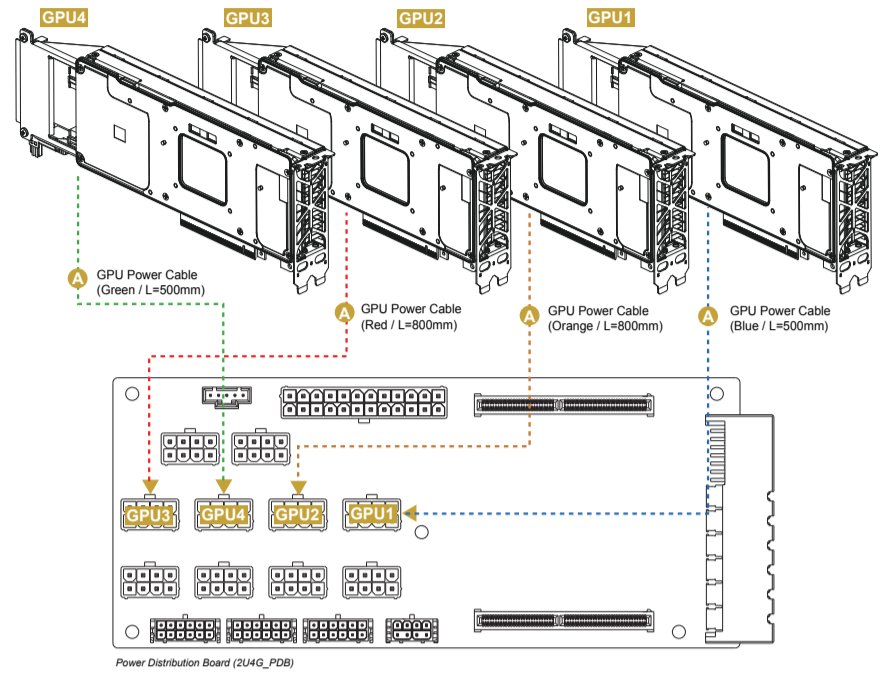

## Board Connection

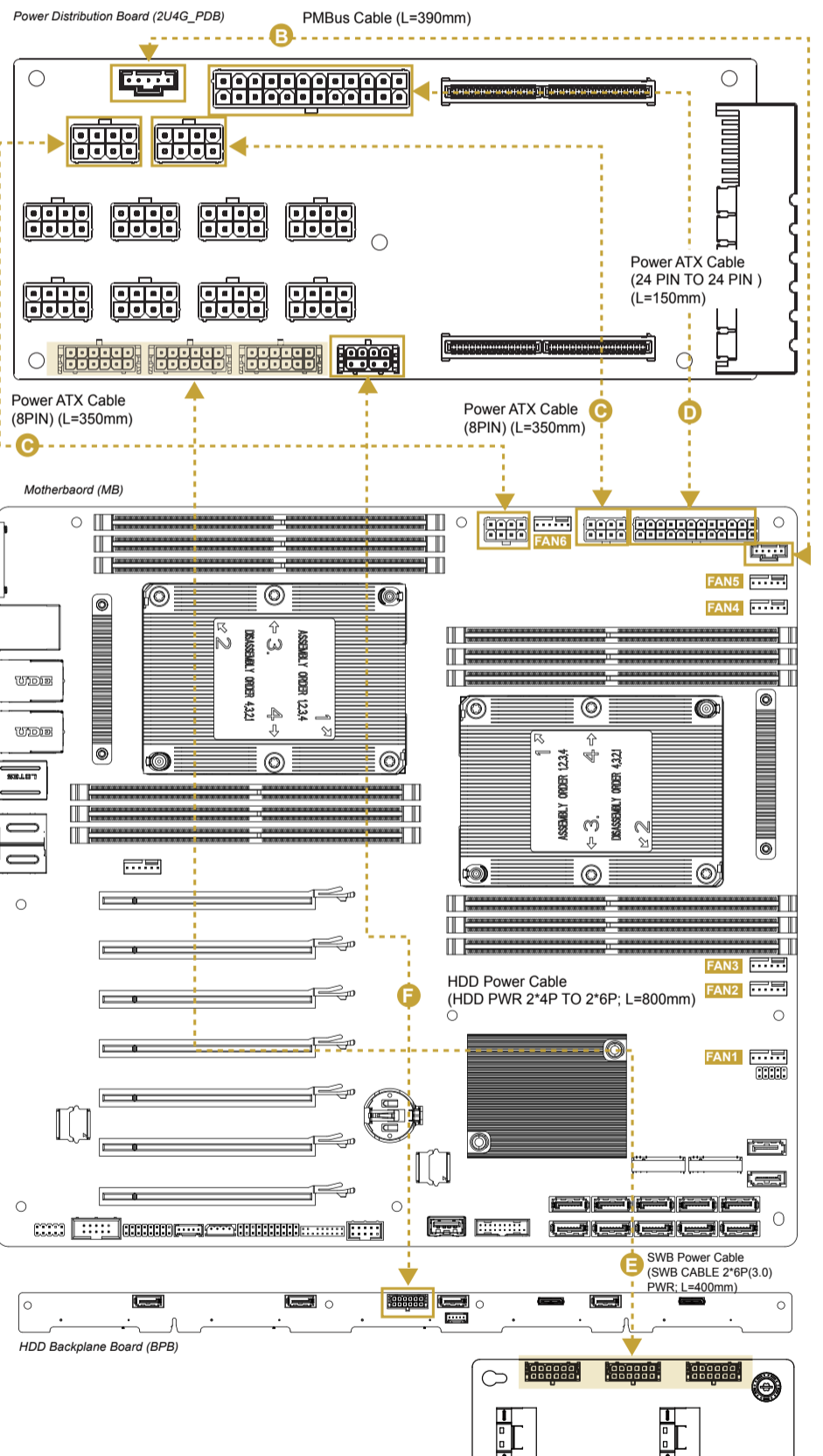
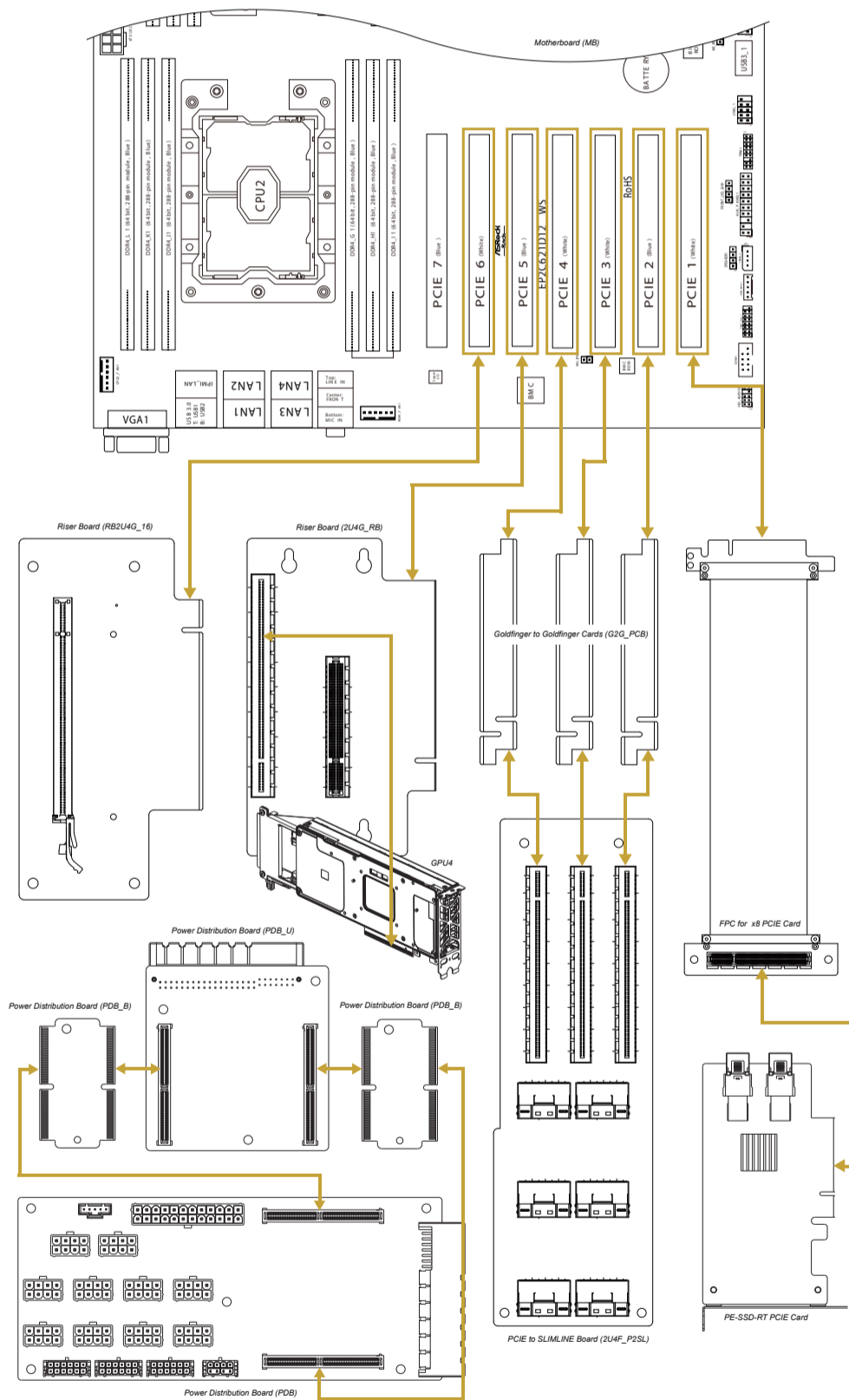

## System Front View (HDD Slots)

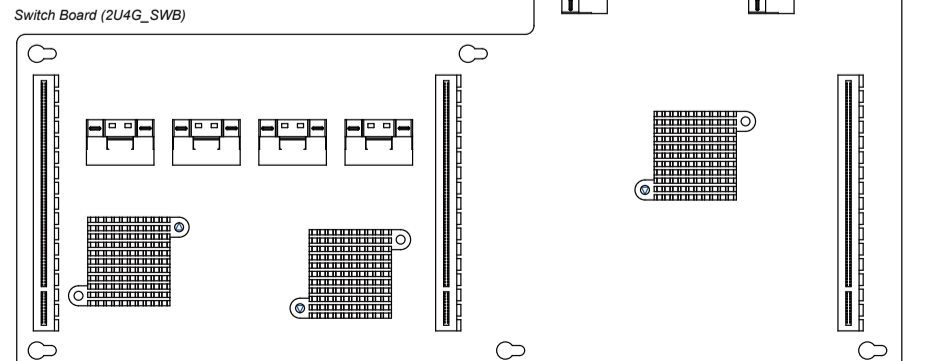
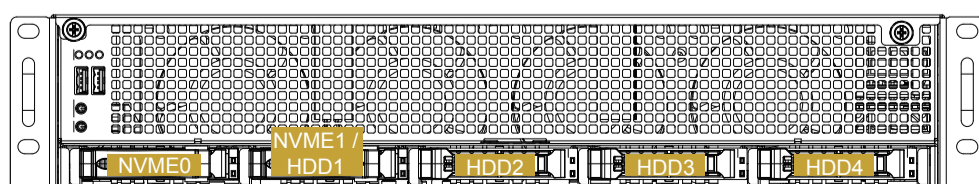

### Riser Card Connection

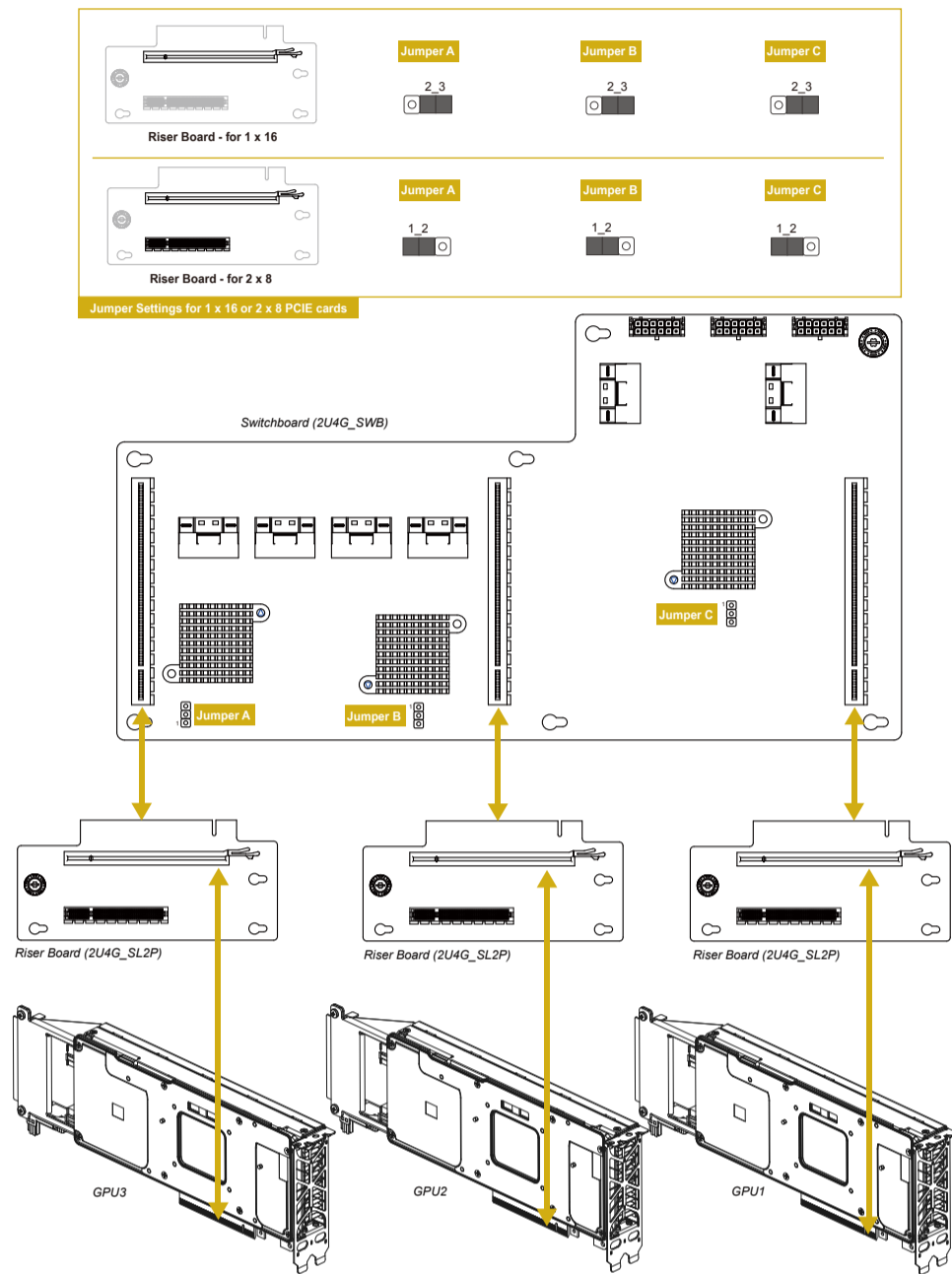

### Front Panel Cable Connection

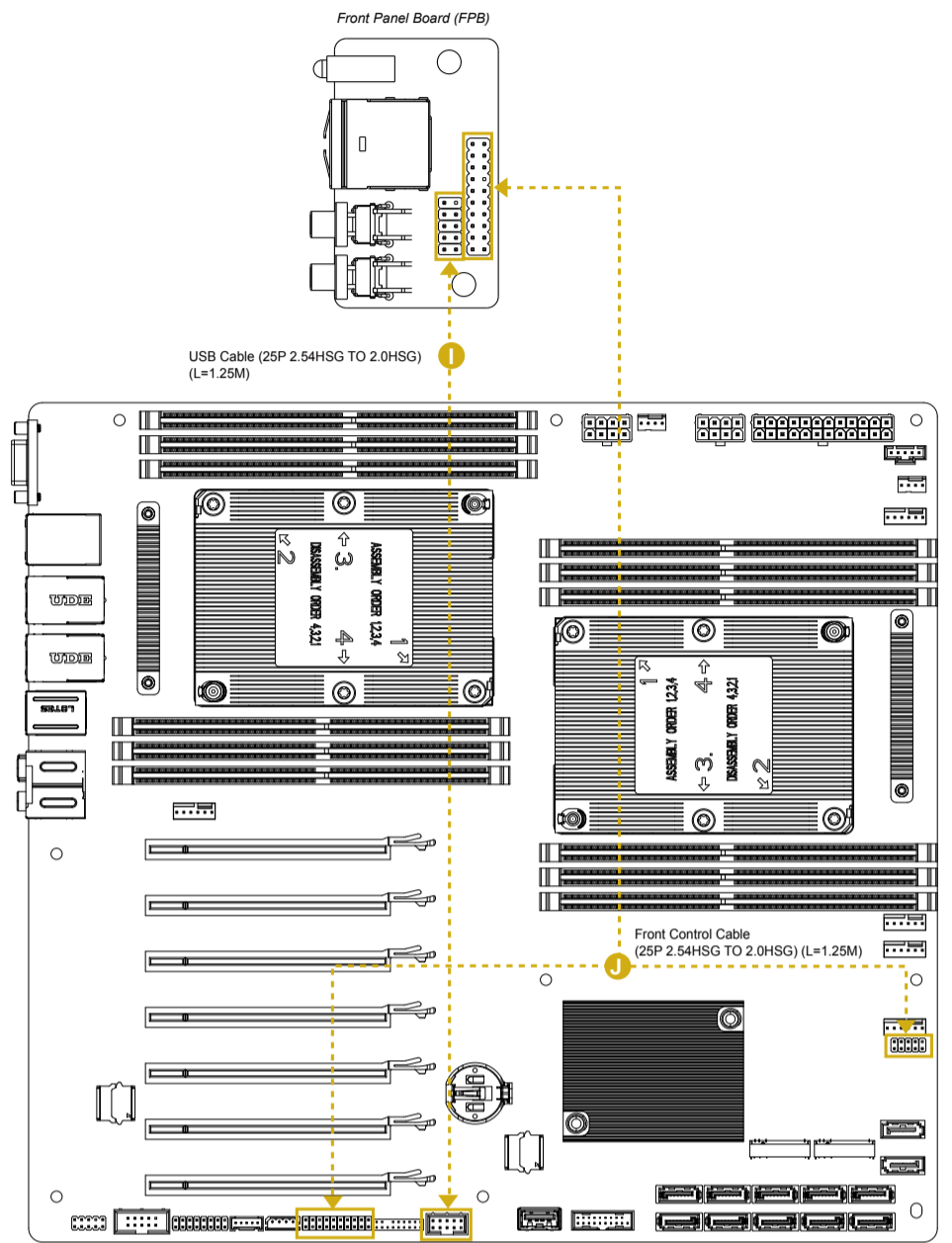

### Slimline Cable Connection

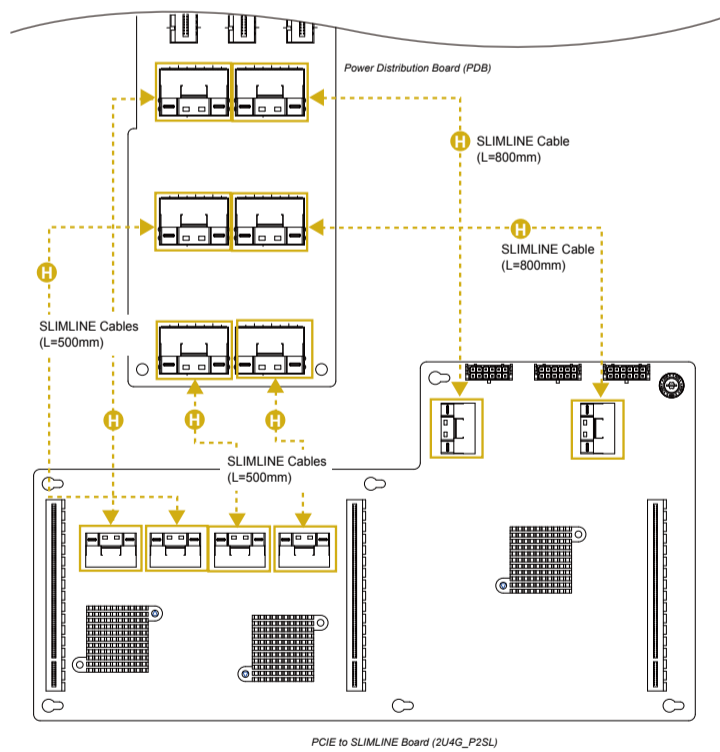

### OcuLink Cable Connection

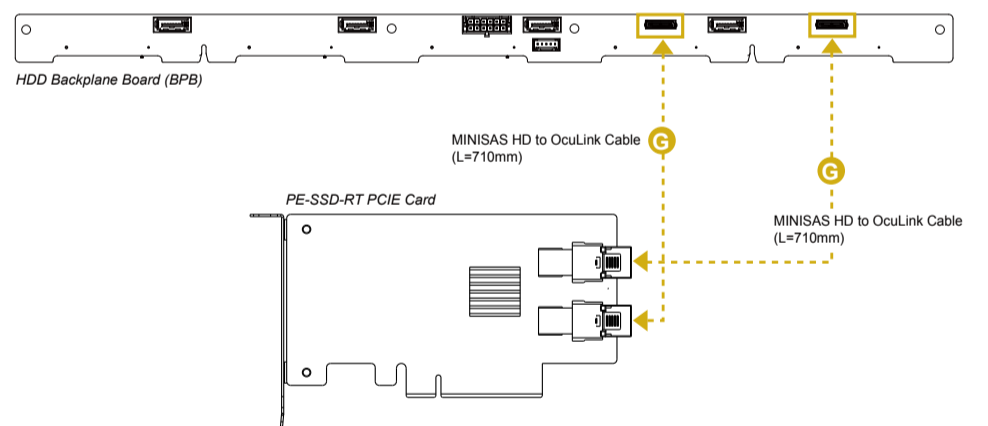

### SATA Cable Connection

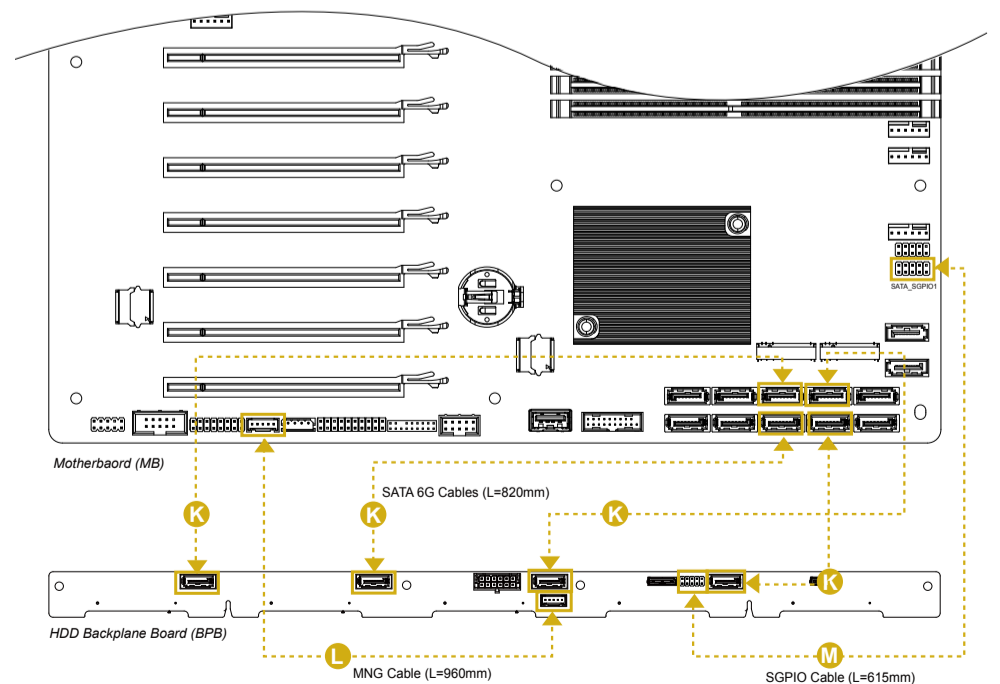

### Air Duct Installation (Only for Passive GPU Cards)

