

avocorTM

AVF-6550

Large Format Interactive Display



Model AVF-6550 Installation and Operation Manual

COPYRIGHT AND TRADEMARKS:

©Copyright 2018. This document contains proprietary information protected by copyright, trademark and other intellectual property laws. All rights are reserved. No part of this manual may be reproduced by any mechanical, electronic or other means, in any form, without our prior written permission.

The trademarks reproduced in this document and used on the products are either owned or licensed by us, or by their respective holders. You may not reproduce or use the trademarks without our prior written consent.

Important Safety Instructions

- Before using this display, please read this user manual thoroughly to help protect against property damage and to ensure your personal safety and the safety of others.
- Be sure to observe the following instructions.
- For your safety, be sure to observe the warnings located in this manual.
- For installation or adjustment, please follow the instructions in this manual and refer all servicing to qualified service personnel.

Safety Precautions

- If smoke or a peculiar smell comes from the display, remove the power plug from the outlet immediately.
- Failure to do so may result in fire or electrical shock. Contact your dealer for inspection.
- If the display has been turned on but there isn't a picture, remove the power plug from the outlet immediately.
- Failure to do so may result in fire or electrical shock. Contact your dealer for inspection.
- If water is spilled or objects are dropped inside the display, remove the power plug from the outlet immediately.
- Failure to do so may result in fire or electrical shock. Contact your dealer for inspection.
- If the display is dropped or the cabinet is damaged, remove the power plug from the outlet immediately.
- Failure to do so may result in fire or electrical shock. Contact your dealer for inspection.
- To turn off the power of the display, press "O" on the main power switch at side of display.
- The power standby/on indicator will go off and the display cannot to be turned on/off by using the POWER button on the remote control. (To turn on/off the display by the remote control, press the main power switch again and light the power standby/on indicator.)
 - ◆ When turning off the display by pressing the POWER button on the remote control, the main power of the display is not turned off completely.
 - ◆ To disconnect power completely, remove the power plug from the outlet.
- If the power cord or plug is damaged or becomes hot, turn off the main power switch of the display, make sure the power plug has cooled down and remove the power plug from the outlet.
- If the display is still used in this condition, it may cause fire or electrical shock. Contact your dealer for replacement.

Installation

- Don't install in a high-temperature environment.
- If the display is used in high-temperature or in direct sunlight, it may cause the case or other parts to become distorted or damaged, resulting in overheating or electrical shock.
- Don't install in a high-humidity environment.
- This may cause overheating or electrical shock.
- Don't install near any heat sources such as radiators, heat registers, stoves, or other apparatus that produce heat.
- This may cause fire or electrical shock.
- Don't overload outlets or cables beyond electrical capacity.
- Don't use extension cords as it may cause fire or electrical shock.
- Don't insert the power plug into an outlet other than 100~240V AC.
- This may cause fire or electrical shock.
 - ◆ Don't use a damaged power plug or worn outlet.
 - ◆ Don't insert an improper power plug it may cause fire or electric shock.
- Don't place the display on an unstable shelf or surface.
- The display may fall, causing injury. Please install on a horizontal, stable, level surface.
- Don't place objects on the display.
 - ◆ If the display is covered or the vents are blocked, the display could overheat and cause a fire.
 - ◆ If metal or liquid gets into the display, it may cause fire or electrical shock.
 - ◆ Do not put heavy objects on the display as they may fall, causing injury.
 - ◆ Please keep a 10 cm minimum distance between the display and the wall for sufficient ventilation.
- Don't move the display when it is connected to the power cord and AV cables.
 - ◆ When moving the display, make sure to remove the power plug and cables from the outlet or source.
 - ◆ When unpacking or carrying the display, at least 2 people are needed. Make sure the display is carried upright.
 - ◆ Transport the display upright. Avoid placing the display face up or down.
 - ◆ Handle the display gently. Do not drop.

Use

- If you encounter a problem during installation, please contact your dealer for assistance. Don't repair or open the display by yourself.
- Failure to do so may result in fire or electrical shock. Contact your dealer for inspection.
- Protect and correctly use the power cord/plug.
 - ◆ Don't pinch the power cord/plug between hard surfaces.
 - ◆ Don't step on the power cord/plug.
 - ◆ Before inserting the power plug into the wall outlet, connect the power cord to the display.
 - ◆ Don't operate the display with a damaged power cord or it may damage the display.
- Using extension cords (not recommended)
- If an extension cord must be used, ensure the voltage rating exceeds the max power consumption of the display. If the voltage rating is less than the display, it will cause the extension cord to overheat.
- If there is thunder or lightning, don't touch the display or the power plug.
- This may cause an electric shock.
- Don't use any kind of liquid on the display.
 - ◆ If liquid is spilled on the display, remove the power and ask qualified service personnel to check the display.
 - ◆ If the liquid gets on the display's screen, please clean it with a dry and soft cloth immediately.
 - ◆ Don't use any harsh chemical on the display.
 - ◆ If metal or liquid gets into the display, it may cause a fire or an electrical shock.
- Don't install or remove the power plug with wet hands.
- This may cause an electrical shock.
- If the display will not be used for a long period of time, unplug the display.
- This may cause premature wear of electrical components or fire.
- Don't press on the LCD panel.
- This may cause personal injury or panel damage.
- Don't push or shake the display.
- This may cause damage or injury.
 - ◆ If the glass of the display panel is broken, liquid may escape. Please don't touch the liquid.
 - ◆ If liquid get into your eyes or touches your skin, wash with the clean water and seek medical attention immediately.
 - ◆ Precautions with the remote control batteries
 - ◆ Please only use approved AAA type batteries.
 - ◆ Please be sure to insert batteries by matching the + and -.

- ◆ Don't recharge, heat, disassemble, short or throw batteries into a fire.
- ◆ Don't mix a new battery with a used one.
- ◆ Don't mix different types of batteries together (only use the specified type). it may cause burn and injury.

Cleaning

- If dust has collected on the power plug, remove the plug from the outlet and clean off the dust.
- Dust build-up may cause a fire.
- Take off the power plug before cleaning.
- Failure to do so may result in electrical shock or damage.
- Cleaning the surface of the display
 - ◆ When the surface of the display becomes dirty, please wipe the surface lightly with a soft clean cloth.
 - ◆ If the surface requires additional cleaning, lightly moisten the cloth.
 - ◆ Do not to let any kind of liquid enter the display as it may cause electrical shock or damage.
 - ◆ Do not clean the display with alcohol, solvents or ammonia, as this could damage the display.

Warnings

Use

- Do not use the display lying flat on its back.
- Transport the display upright with proper packaging. Avoid placing the display face up or down. Be careful not to bump into the display.
- Do not send a static (non-moving) image to the display, or it may cause image 'burn-in' or image retention.
- "Burn in" and/or image retention is not covered under warranty.
- Make sure to change the image on the display periodically. It is recommended to (1) turn off the display for at least 6 hours after 18 hours of usage in a 24 hour period to help avoid image retention and (2) to turn the "IRFM" function to "ON" in the OSD menu (under "Advanced Settings").

Exemptions

- This product isn't warranted for any damage caused by natural disaster (such as earthquake, thunder, etc.), fire, acts by third parties, accidents, owner's intentional misuse and fault, or use in other improper conditions.
- This product isn't warranted for incidental damages (such as profit loss or interruption in business, modification or erasure of record data, etc.) caused by use or inability to use of this product.
- This product isn't warranted for any damage caused by inappropriate operation, or from not following the user manual.
- This product isn't warranted for any damage caused by misuse or malfunction through simultaneous use of this product and the connected equipment or software.
- This product isn't warranted for any damage caused by neglect of the instructions described about installation.
- This product isn't warranted for any damage caused by improper installation.
- This product isn't warranted for any damage caused by disassembly, modification or repair by non-authorized service centre or people.

Compliance Information

DECLARATION OF CONFORMITY:

AVOCOR hereby declares that the Product's Model Numbers:

AVF-6550

Conform with the provisions of:

- FCC:

FCC CFR Title 47 Part 15 Subpart B Class A, CISPR 22

ANSI C63.4

ICES-003

- CE:

EN 55032

EN 55024

EN 61000-3-2

EN 61000-3-3

- cTUVus:

UL 60950-1

CAN/CSA-C22.2 No. 60950-1

- CB:

IEC 60950-1

- CEC:

California Code of Regulations, Title 20:Division 2, Chapter 4, Article 4, Sections 1601-1609

FCC PART 15:

This equipment has been tested and found to comply with the limits for a Class A digital device, pursuant to part 15 of the FCC Rules. These limits are designed to provide reasonable protection against harmful interference when the equipment is operated in a commercial environment. This equipment generates, uses, and can radiate radio frequency energy and, if not installed and used in accordance with the instruction manual, may cause harmful interference to radio communications. Operation of this equipment in a residential area is likely to cause harmful interference in which case the user will be required to correct the interference at his own expense.

CAUTION

Any changes or modifications not expressly approved by the grantee of this device could void the user's authority to operate the equipment.

INDUSTRY CANADA (ICES-003):

CAN ICES-3 (A)/NMB-3(A)

PRODUCT DISPOSAL:

The Product contains small amounts of tin, lead and/or mercury. Disposal of these materials maybe regulated due to environmental considerations.

DISPOSAL OF OLD ELECTRICAL AND ELECTRONIC EQUIPMENT (Applicable throughout the European Union and other European countries with separate collection programs)



This symbol found on your product or on its packaging, indicates that this product should not be treated as household waste when you wish to dispose of it. Instead, it should be handed over to an applicable collection point for the recycling of electrical and electronic equipment. By ensuring this product is disposed of correctly, you will help prevent potential negative consequences to the environment and human health, which could otherwise be caused by inappropriate disposal of this product.

The recycling of materials will help to conserve natural resources. This symbol is only valid in the European Union. If you wish to discard this product, please contact your local authorities or dealer and ask for the correct method of disposal.

Notes

Table of Contents

Important Safety Instructions	3
Safety Precautions	3
Installation	4
Use	5
Cleaning.....	6
Warnings	7
Use	7
Exemptions.....	7
Compliance Information	8
Table of Contents	11
List of Figures	13
1. Introduction	15
About This Manual	15
Target Audience.....	15
Textual and Graphic Conventions.....	15
Using This Manual	16
Description, Features and Benefits	17
Key Features and Benefits.....	17
Touch Capability.....	17
Parts List.....	17
2. Controls and Functions	18
Display at a Glance	18
Input Panel	20
Remote Control Unit	22
3. Installation	24
Remote Control	24
Notes on Batteries	24
Notes on Remote Control Operation.....	24
Quick Setup	25
Installation Considerations	25
Ambient Light.....	25
Ambient Heat.....	25
Ventilation	26
Mounting the Display	26
Connections to the Display	27
Connecting a Control System or PC	27
Connecting Source Components to the Display	29
Turning on the Power	31
Changing the OSD Language	32
Enabling the Touch Screen	32
Software Installation	33
4. Operation	37
Using the On-Screen Menus	37
Input Menu.....	39

Display Settings	41
Audio Menu	42
Basic Settings.....	43
Advanced Settings.....	44
Information	47
5. Maintenance and Troubleshooting	48
Maintenance.....	48
Troubleshooting	48
6. External Control.....	51
Serial Communications.....	51
RS-232 Connection and Port Configuration	51
Command and Response Format	51
Command and Response Examples	52
Serial Command List	52
Using Discrete IR Codes.....	58
IR Command Protocol.....	58
IR Control Code List.....	58
7. Specifications	59
Supported Timings	60
Overall Dimensions	62
Appendix I: Moving and Carrying Notice	65
Moving the Display.....	65
Carrying the Display	65
Appendix II: Installing a Wall Mount.....	66
Appendix III: Installing an OPS Module	67
Appendix IV: Wall Mount Safety Notes	67
Appendix V: Ethernet Remote Control Settings.....	70
Configurations	70
Administrator	70
TCP Mode.....	73
UDP Mode	74
UART	75
SMTP	76
Reset Device	77

List of Figures

- Figure 2-1. Display Rear/ Side / Front View 18
- Figure 2-2. Display Input Panel View 21
- Figure 2-3. Display Remote Control Unit 22
- Figure 3-1. Ventilation Requirements for Enclosure Mounting..... 26
- Figure 3-2. RS-232 Control System Connection 27
- Figure 3-3. Ethernet Connection 28
- Figure 3-4. DisplayPort Source Connection 30
- Figure 3-5. HDMI Source Connections 30
- Figure 3-6. VGA Source Connections 31
- Figure 3-7. Touch Screen Controller (USB) Connection..... 33
- Figure 4-1. OSD Menu Structure..... 38
- Figure 7-1. AVF-6550 Display Dimensions (inch) 62
- Figure 7-2. AVF-6550 Display Dimensions (mm) 62

Notes

1. Introduction

About This Manual

This Owner's Manual describes how to install, set up and operate the AVOCOR Series LED Display.

Throughout this manual, the AVOCOR Series LED Display is referred to as the "display".

Target Audience

The manufacturer has prepared this manual to help installers and end users get the most out of the display.

The manufacturer has made every effort to ensure that this manual is accurate as of the date it was printed. However, because of ongoing product improvements and customer feedback, it may require updating from time to time.

Textual and Graphic Conventions

Text Conventions: The following conventions are used in this manual, in order to clarify the information and instructions provided:

- Remote and built-in keypad button identifiers are set in upper-case bold type; for example, "Press **EXIT** to return to the previous menu."
- Computer input (commands you type) and output (responses that appear on-screen) is shown in monospace (fixed-width) type; for example: "To change the aspect ratio to Letterbox, type 07 00 02 41 53 50 03 08 <OK>."
- All keys with functional names are initial-capped, set in bold type and enclosed in angle brackets. These keys are the following: <OK>, <Spacebar>, <Control>, <Esc> and <Tab>. <OK> indicates that you may press either the EXIT or OK key on your keyboard if it has both keys.
- In addition to these conventions, underlining, bold face and / or italics are occasionally used to highlight important information, as in this example:



NOTE A carriage return must be used after each command or string.

Graphic Conventions: These symbols appear in numerous places throughout the manual, to emphasise points that you must keep in mind to avoid problems with your equipment or injury:



TIP

TIPS highlight time saving short cuts and helpful guidelines for using certain features.



NOTE

NOTES emphasise text with unusual importance or special significance. They also provide supplemental information.



CAUTION

CAUTIONS alert users that a given action or omitted action can degrade performance or cause a malfunction.



WARNING

WARNINGS appear when a given action or omitted action can result in damage to the equipment, or possible non-fatal injury to the user.



DANGER!

DANGER appears when a given action can cause severe injury or death.

Using This Manual

Use the following table to locate the specific information you need in this manual.

If you need...	... Turn to page:
General information about the AVOCOR Series LED Display	17
Installation instructions	24
First-time configuration instructions	31
Advanced configuration instructions	44
Troubleshooting tips	48
Product specifications	59

Description, Features and Benefits

The AVOCOR AVF-6550 Displays are ultra-high definition touch displays that support a full 3840x2160 @60Hz(4K) resolution and can display 8 bits, 1.07 billion colours.

They combine ultra-high resolution and unparalleled image quality with configurable I/O in a large-format display for a wide range of digital signage and control-room applications.

Key Features and Benefits

The display offers these key features and benefits:

- Up to 3840x2160 @60 Hz(4K) resolution
- High-speed InGlass™ touch sensing for up to 20 points and 4 passive pens (for Windows system)
- Diverse video connectivities including (5) HDMI 2.0 inputs and DisplayPort 1.2 input with HDCP, and VGA
- Multiple control connectors including RS-232, USB 2.0/3.0, Touch USB, and LAN connections
- OPS (Open Pluggable Specification) slot
- MIC array
- Full-range internal speakers modules
- Compliance with windows 7/8/10, and Mac OS
- Flexible ON/OFF scheduler
- Long lifetime with high reliability

Touch Capability

- Precise, highly responsive touch technology
- High touch sensitivity – no pressure required
- Any touch: finger, gloved hand or pointer
- Calibrated easily by provided software tools
- Compliant with Windows 7/8/10 and Mac OS
- Supports 4 passive pens in Windows system
- One USB cable for easy Plug-and-Play operation

Parts List

Your display is shipped with the following items. If any items are missing or damaged, please contact your dealer or Customer Service.

- AVOCOR UHD LED Display
- Remote Control Unit and Batteries
- AC Power Cord (US, UK, and Europe)
- 2 Touch Styluses
- 5 cable clips
- USB Key – User Manual
- USB Cable - 3 Metres
- HDMI Cable - 3 Metres
- QSG

2. Controls and Functions

Display at a Glance

Figure 2-1 shows the key display components, and the paragraphs that follow describe them.

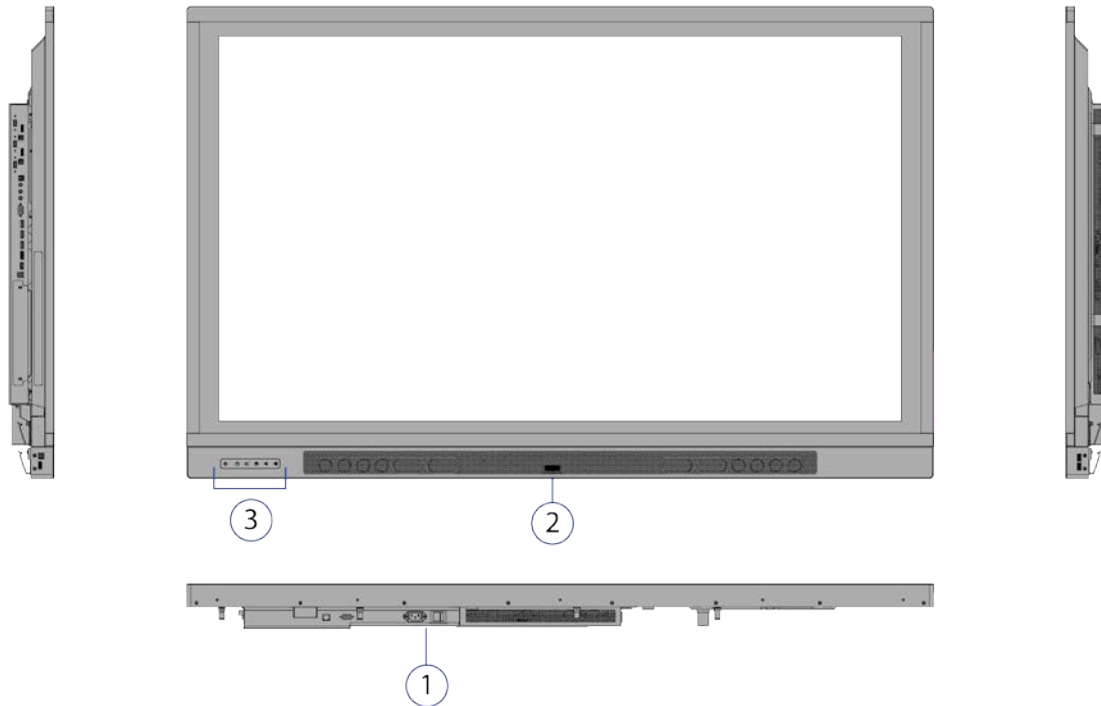

Figure 2-1. Display Front/ Side /Rear View

1. MAIN POWER SWITCH

Connects or disconnects the display panel from the AC power source.

2. Status LED

Solid green: display on, input detected

Blinking orange: display on, no input detected

Solid orange: display in power saving mode

Off: main power switched off

3. KEYPAD



You can use the keypad instead of the remote control unit to operate the on-screen display (OSD) controls. The keypad operates as follows:

LED light of inductive keys

Blue: light on for 5 seconds when the keys are pressed

Power key breathing light: display go to sleep at digital mode (Digital, RS232, Ethernet)

POWER 

Press the button to turn on/off the monitor screen.

Home 

Press the button to select OPS.

SOURCE 

Press the button to select a media source.

Press and hold the button to go through the input sources.

WPS 

Press the button to select WPS input.

VOLUME DOWN  / UP 

Press these two buttons to lower or increase the volume.

Press and hold the button to continuously lower or increase the volume.

Input Panel

Figure 2-2 shows the display input panel.

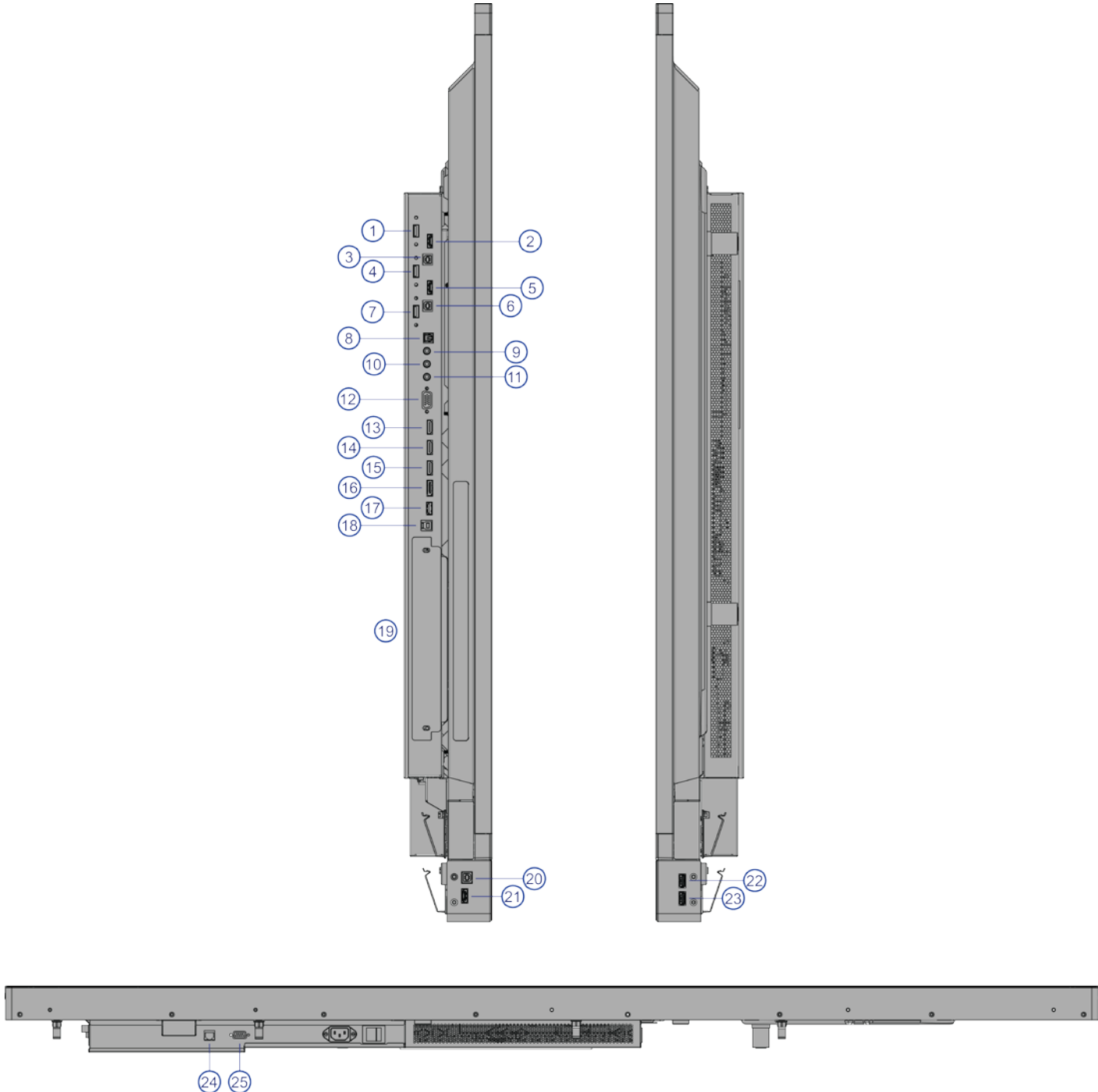

Figure 2-2. Display Input Panel View

No.	Connector
1	OPS USB 3.0 A standard USB connector of the OPS slot for connecting external multimedia player devices.
2	WPS WPS(HDMI) input for connecting Wireless Presentation sources to the display.
3, 6, 20	Touch USB Standard, Type-B USB 2.0 ports for connecting touch sources to the display.
4, 7	HUB USB 3.0 Standard USB 3.0 type A connectors for connecting external media, keyboard, keyboard or mouse.
5, 14, 15, 21	HDMI 1, 2, 3, 4 HDCP-compliant HDMI 2.0 digital video input for connecting HDMI sources.
8	SPDIF Connects external and powered digital speakers or audio receiver/amplifier.
9	Audio Out Connects external, powered speakers or an external audio receiver/amplifier.
10	IR Connects an IR Extender cable from this input.
11	Audio In Connects the audio output from a personal computer here.
12	VGA Connects components that have RGB or component output jacks, such as a personal computer or external DTV decoder (a break-out cable is needed for BNC-type connection).
13	HDMI Out HDCP-compliant HDMI output that will support inputs HDMI 1, HDMI 3, DisplayPort, & WPS
16	DisplayPort DisplayPort 1.2 and DisplayPort-HDCP 1.1 compliant, SD/HD input for connecting SDTV, EDTV or HDTV component video sources.
17	Service Port A standard USB Type A connector for connecting the USB stick that comes with the package to upgrade firmware.
18	Touch USB HUB 3.0 in Type-B USB 3.0 port for connecting touch and media sources to the display for ports 14, 16, 17 & 18.
19	OPS (Open Pluggable Specification) Slot An optional OPS slot for connecting an internal PC to display 4K content.
22	OPS USB A standard USB 2.0 connector of the OPS slot for connecting external multimedia player devices.
23	HUB USB Standard USB 2.0 type A connectors for connecting external media, keyboard, keyboard or mouse.
24	LAN An RJ-45 connector for interfacing with a PC or home theater automation/control system via a Cat 5 cable.
25	RS232C A female, 9-pin D-sub connector for interfacing with a PC or home theatre automation/control system.









Remote Control Unit

Figure 2-3 shows the display remote control, and Table 2-1 describes its functionality.



Figure 2-3. Display Remote Control Unit

Table 2-1. Remote Control Button Descriptions

Button	Description
	Power Turns the display screen on and off
	Home/OPS Selects OPS input
	Source Selects a media source
	Navigation arrows Navigates through submenus and settings
	OK Confirms the selection
	Exit Exits the OSD menu
	Volume down Turns down the volume
	Volume up Turns up the volume
	Menu Opens the OSD menu

Hot keys for lock and unlock the remote control and built-in keypad

- **Lock:** To lock the remote control and built-in keypad, press **OK, OK, Exit, Exit, OK** and **Exit** on the remote control. (This will not lock RS232 and Power On control.)
- **Unlock:** To unlock the remote control and built-in keypad, press **OK, OK, Exit, Exit, OK** and **Exit** on the remote control.

3. Installation



NOTE Installation must be performed by a qualified custom video installation specialist.

Remote Control

To install batteries in the remote control:

1. Press down the tab on the cover and pull the cover up.
2. Insert the included batteries. Ensure that the polarities correctly match the \oplus and \ominus markings inside the battery component.
3. Insert the lower tab of the cover into the opening, and press down the cover until it clicks in place.

Notes on Batteries

Make sure that the battery polarities are correct when installing the batteries.

- Do not mix an old battery with a new one or different types of batteries.
- If you will not use the remote control for a long time, remove the batteries to avoid damage from battery leakage.
- Do not expose batteries to excessive heat such as from sunshine, fire or the like.

Notes on Remote Control Operation

- Make sure that there is nothing obstructing the infrared beam between the remote control and the IR receiver on the display.
- If the effective range of the remote control decreases, or it stops working, replace the batteries with new ones.
- The remote control may fail to operate if the infrared remote sensor is exposed to bright sunlight or fluorescent lighting.
- Ambient conditions may possibly impede the operation of the remote control. If this happens, point the remote control at the display, and repeat the operation.

Quick Setup

Table 3-1 gives a quick overview of the display installation process. The sections following this one provide detailed instructions.

Table 3-1. Installation Overview

Step	Procedure	For Details Refer to page...
1	Mount the display(s) on a wall (optional)	26
2	Connect other external equipment to the display (optional): Automation/control system (RS232, Ethernet)	27
3	Connect signal sources to the display	29
4	Apply power to the display	31
5	Change the OSD language (optional)	32
6	Perform touch screen-specific installation and configuration tasks (AVOCOR): Connect touch screen controller host computer to the display	33
7	Display calibration - adjust the following <i>for each input</i> : <ul style="list-style-type: none">• Aspect ratio• Brightness• Contrast• Colour temperature and white balance• Color level• Tint• Input position	39

Installation Considerations

Proper installation of your display will ensure a satisfying viewing experience. Whether a display is installed temporarily or permanently, the following should be taken into account to ensure the best performance of the display.

Ambient Light

In general, minimise or eliminate light sources directed at the screen. Contrast ratio in your images will be noticeably reduced if light directly strikes the screen, such as when a shaft of light from a window or floodlight falls on the image. Images may then appear washed out and less vibrant. Direct sunlight may affect touch operation.

Ambient Heat

Keep the ambient temperature constant and below 40°C (104°F). Keep the display away from heating and/or air conditioning vents.

Ventilation

If you are mounting the display in an enclosure, leave sufficient space on all sides between it and surrounding objects, as shown in Figure 3-1. This allows heat to disperse, maintaining the proper operating temperature.

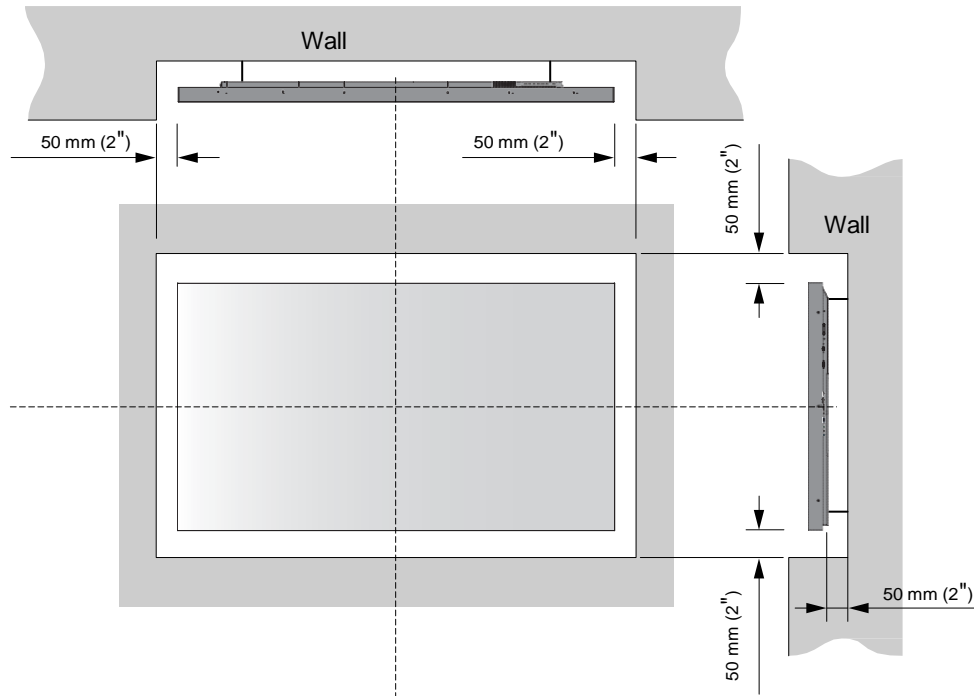

Figure 3-1. Ventilation Requirements for Enclosure Mounting

Mounting the Display

You can mount the display on a wall.

If you do decide to wall-mount the display, ensure that the wall-mount bracket is installed according to the instructions included with it. The wall must be capable of supporting a redundant weight factor three (3) times the weight of the display, or be reinforced.

We recommend that this be done by a custom installation specialist.



NOTE

To safely mount the display on a wall, Avocor recommends:

- Use only the approved wall-mount kit designed for the display.
- Make sure the tilt degree of the wall does not exceed 10 degrees.

Connections to the Display

Proceed as follows to connect the display to your video sources, external controller(s) – if present – and AC power.

When connecting your equipment:

- Turn off all equipment before making any connections.
- Use the correct signal cables for each source.
- For best performance and to minimise cable clutter, use high-quality cables that are only as long as necessary to connect two devices. (Don't use a 7m cable when a 1.8m cable will suffice.)
- Ensure that the cables are securely connected. Tighten the thumbscrews on connectors that have them.

Connecting a Control System or PC

RS-232 Connection

Use a straight-through RS-232 cable with a 9-pin male connector to connect a PC or control/ automation system (if present) to the RS-232 port on the display; see **Figure 3-2**.

For more information about using this connection, refer to **External Control** on page 50.

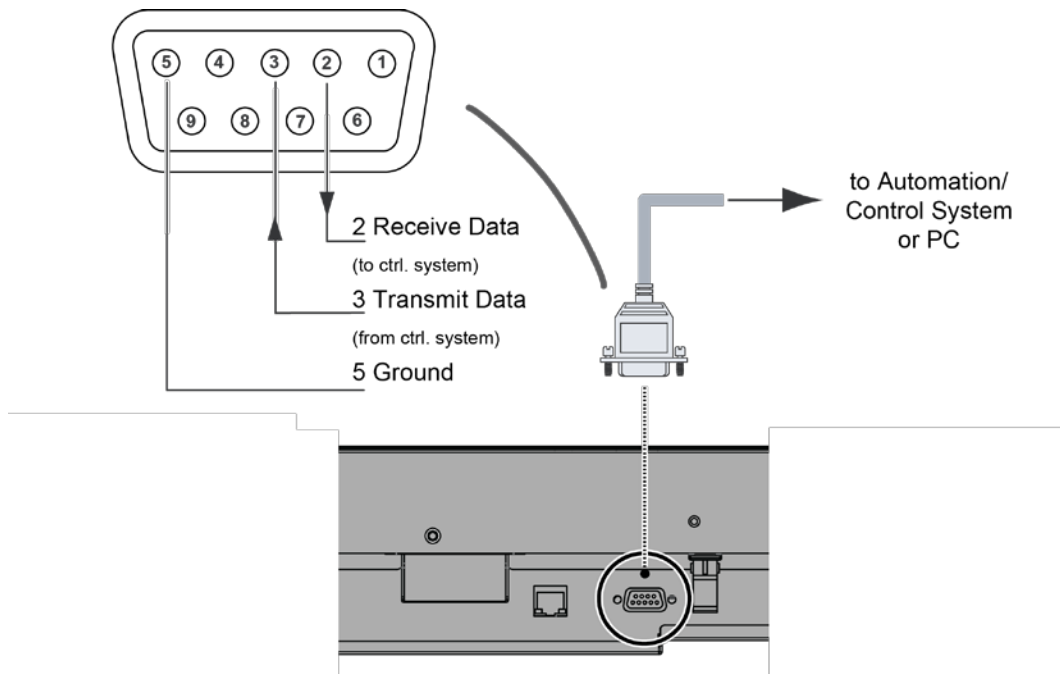

Figure 3-2. RS-232 Control System Connection



NOTE

The RS-232 connection may vary with different control system. If there is any problem regarding the connection, please contact our customer service for further assistance.

Ethernet Connection

Use a standard Ethernet cable with an RJ-45 male connector to connect a PC or control/automation system (if present) to the Ethernet port on the display.

For more information about using this connection, refer to *External Control* on page 50.

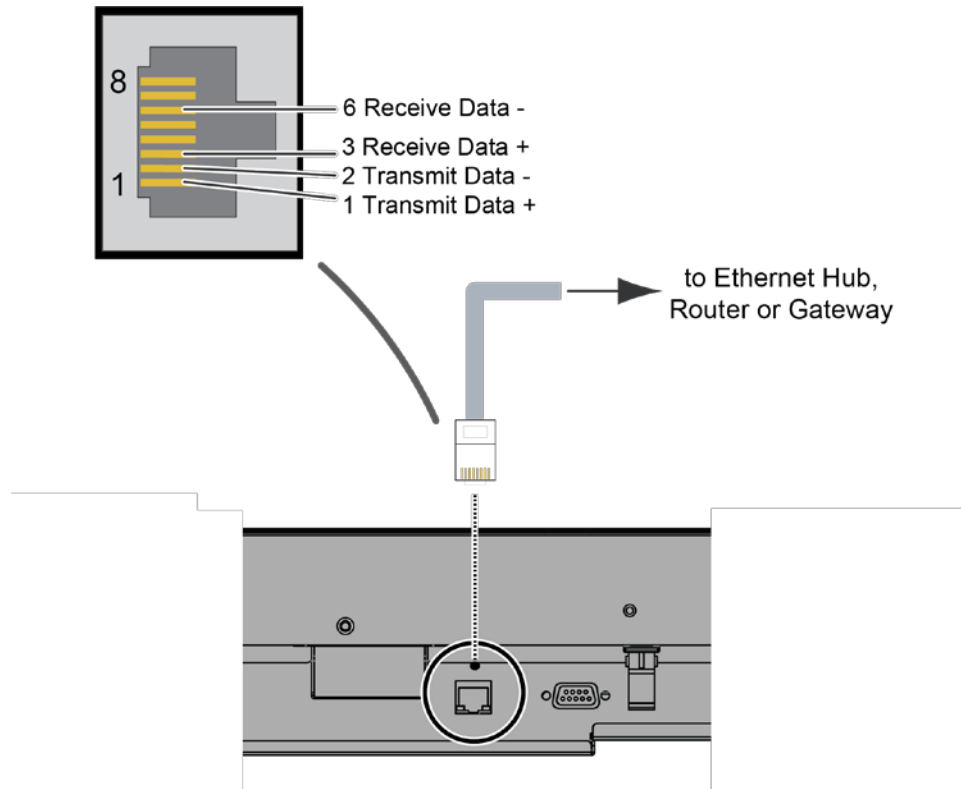

Figure 3-3. Ethernet Connection

Connecting Source Components to the Display

Connect your video sources to the display as shown and described in the sections that follow.

DisplayPort Source Connection: See Figure 3-4.

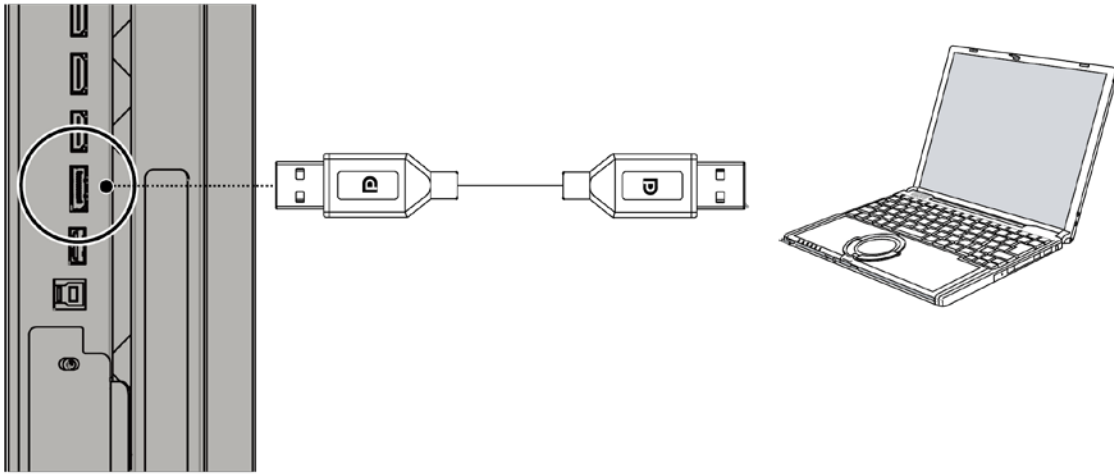

Figure 3-4. DisplayPort Source Connection

HDMI Source Connections: See Figure 3-5.



TIP

Use the HDMI inputs whenever possible. This ensures the highest video quality because the signal is carried in the digital domain throughout the entire signal path, from source component output into the display.



NOTE

This display supports the VESA Display Data Channel (DDC) standard. This standard provides "Plug and Play" capability; the display and a VESA DDC-compatible computer communicate their setting requirements, allowing for quick and easy setup.

For Plug and Play to work correctly, you must turn on the display before you turn on the connected computer.

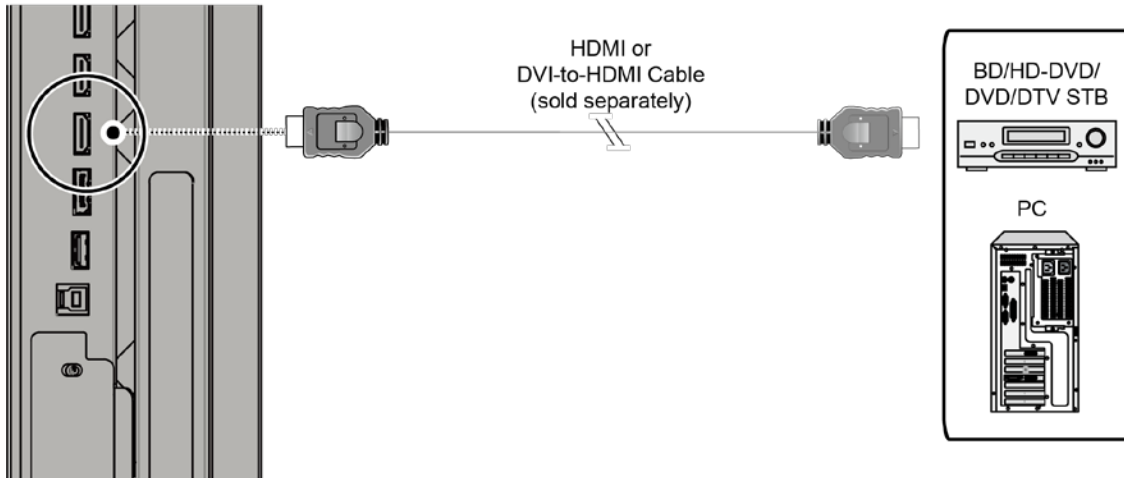

Figure 3-5. HDMI Source Connections

VGA Source Connection:

Connect a personal computer or other RGB source to the VGA input as shown in Figure 3-6.



NOTE Refer to **Supported Timings** on page 59 for a list of compatible input signals.

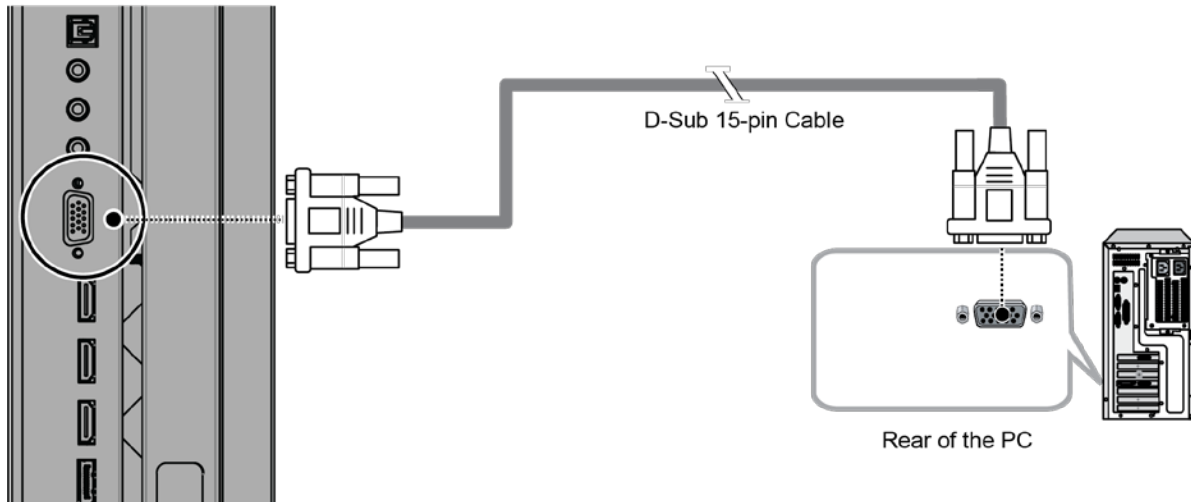



Figure 3-6. VGA Source Connections

Turning on the Power

1. Turn on your source components.
2. Plug the female end of the supplied power cord into the AC receptacle on the side of the display (AC 100V ~ 240V). See Figure 2-2.
3. Connect the other end to your AC power source.
4. Turn on the main power switch at the side of the display (see Figure 2-1). The power indicator lights orange to indicate that the display is in "standby" mode.
5. Press the power button () on the remote control to turn on the display or press the power button () on the keypad.
6. After a brief warm-up period, the display will display an image.



NOTE If there's no input signal for a period of time, the display will automatically go into power saving (sleep) mode.



Changing the OSD Language

The display OSD language is initially set to English, but can also display the menus in different languages.

To change the OSD language:

1. Press MENU.
2. Select Basic Settings from the Main Menu.
3. Select OSD Language from the Basic Settings Menu.
4. Press ◀ or ▶ to select the desired language and press OK. The change takes effect immediately.

Enabling the Touch Screen

Before setting up your display to support touch screen capability, ensure that:

- Your computer is turned on and connected to the display using the provided USB cable. See Figure 3-7.
- The video output from the computer is connected to a video input on the display. See Figure 3-4, Figure 3-5 or Figure 3-6.
- The display is turned on.

Use the provided USB cable to connect the computer to the USB input on the display as shown in Figure 3-7.

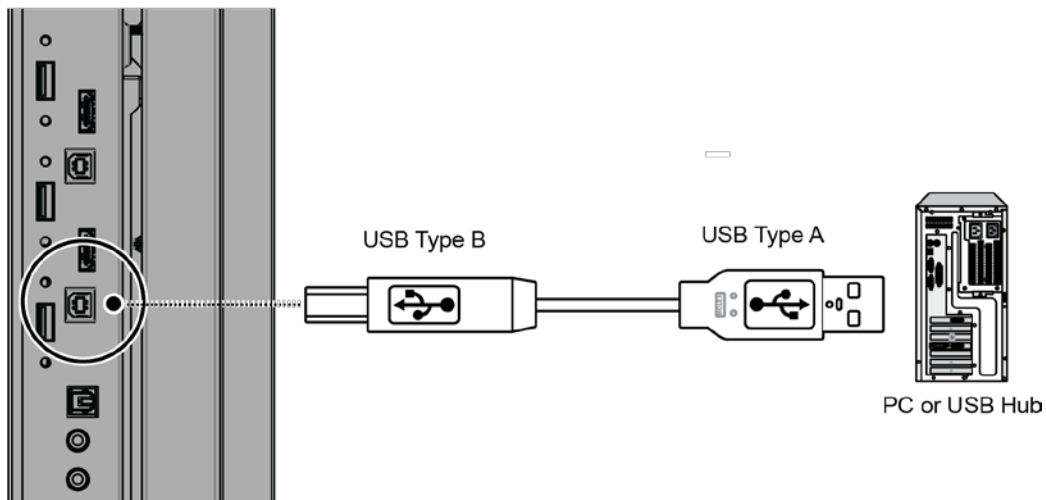

Figure 3-7. Touch Screen Controller (USB) Connection



NOTE

If the touch screen is not working, please turn off your computer or the display and enabling the touch screen again following the steps above.

Software Installation

This driver is not needed for any touch functionality, but is needed in order to perform firmware upgrade.

Automatic Driver Installation

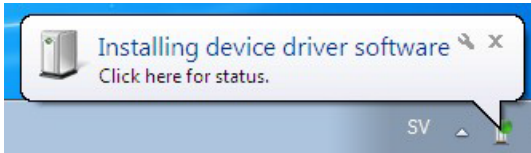

If the automatic driver installation starts, please allow it to run until completion in order to not disrupt the automatic process. Note that the icon may be hidden in the notification area, and that the procedure may take several minutes.

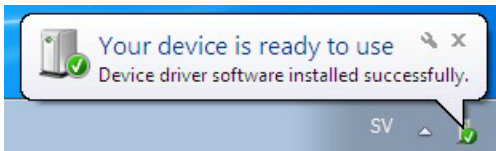

Clicking on the pop-up ballon at this point would show

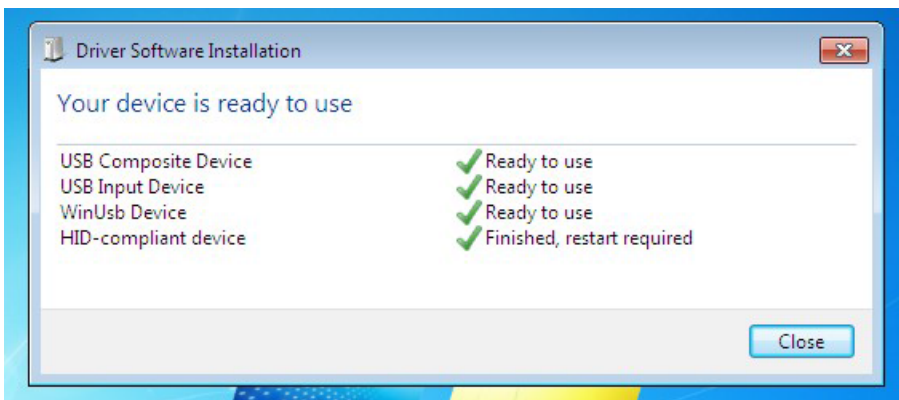

Fully expanded, the view in the Device Manager should look like this (View --> Devices by connection):

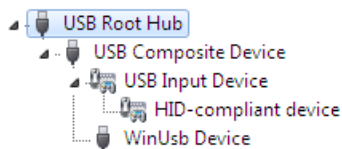

If the automatic installation fails to find the driver, or if automatic driver installation is disabled, or if there is no Internet connection, this is what you will typically see when connecting a FlagFrog touch device.

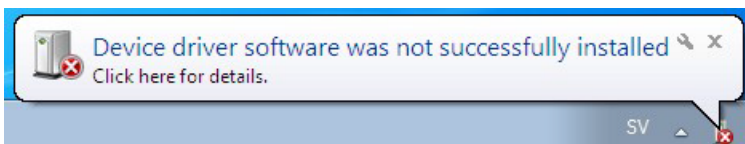

Clicking on the pop-up ballo would show

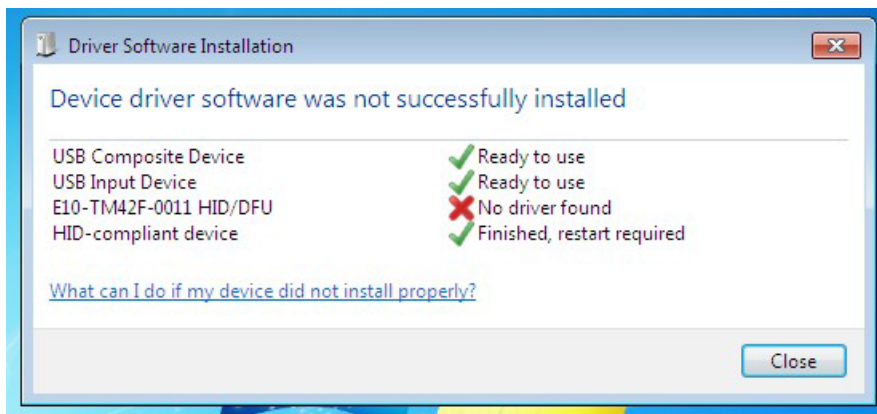

In the Device Manager, the view would be (again, use View --> Devices by connection):

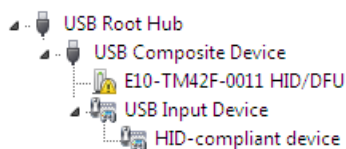

In this case, please proceed with Manual Driver Installation.

Manual Driver Installation

If the automatic driver installation failed for any of the reasons listed above, or if you would like to install the driver without having a FlatFrog touch device connected to the computer, the driver can be installed manually.

The driver provided with this upgrade package was downloaded from <http://catalog.update.microsoft.com> (requires Internet Explorer) and is called "Microsoft – Other hardware – WinUsb Device" (version 1.1.0.0 from 2012-08-30).

Manual Driver Installation - Device Connected

1. Extract the firmware upgrade .zip file (right-click --> Extract all...) to the Desktop.
2. Open the Device Manager and locate the "HID/DFU" device with the yellow exclamation mark.
3. Right-click and select "Update Driver Software..."

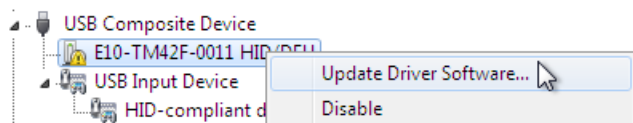

4. Select "Browse my computer for driver software" and select the extracted folder from step 1 and follow the instructions.

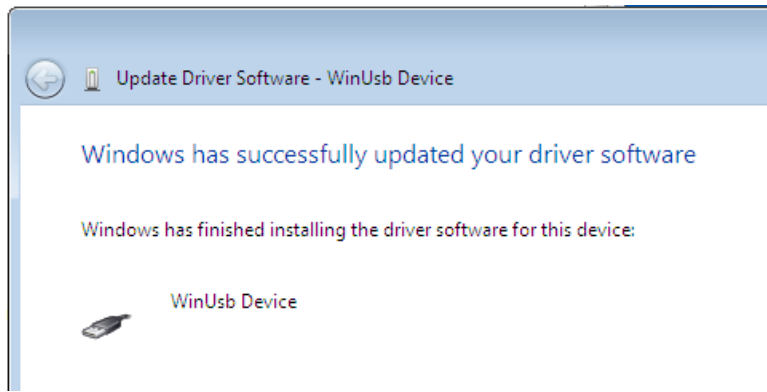

5. If step 4 was unsuccessful, then Windows failed to automatically associate the driver with the device.

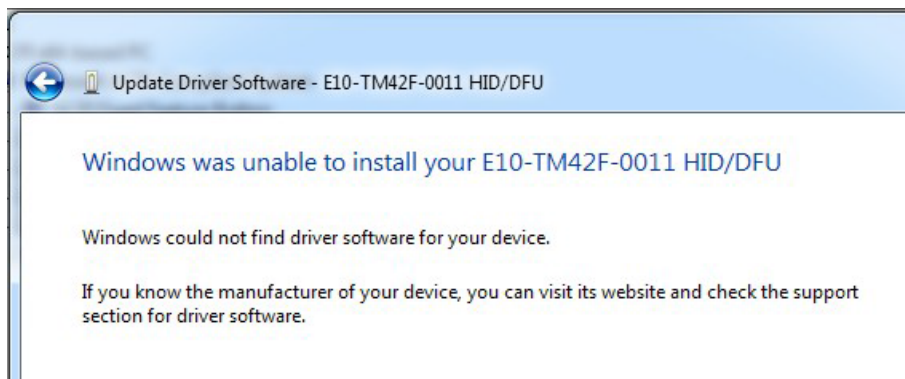

6. Choose "Let me pick from a list if device drivers on my computer" in step 4, scroll all the way down to "Universal Serial Bus devices" and click Next.

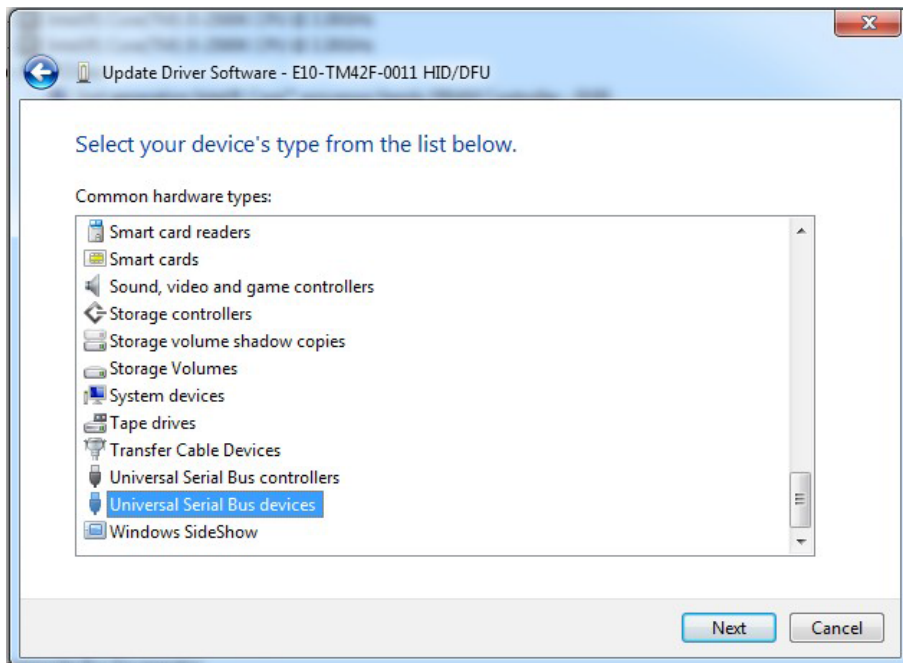

7. Select the WinUsb device driver, and click Next. (If the WinUsb device driver is not in the list, please follow the steps under "Manual Driver Installation - Device Not Connected" first).

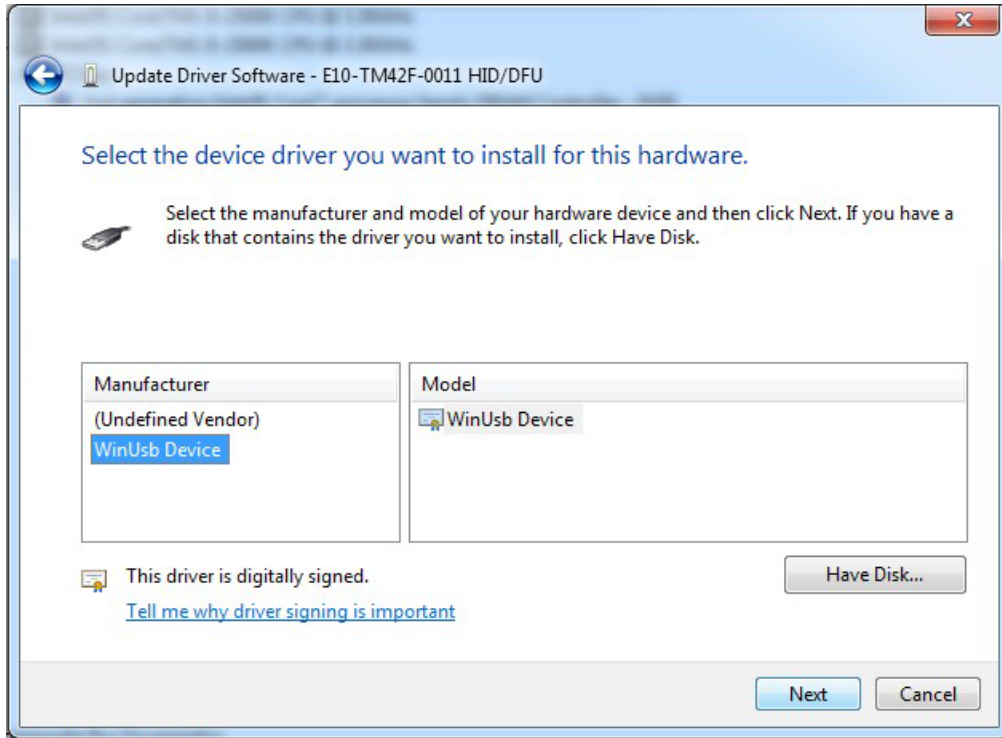

Manual Driver Installation - Device Not Connected

1. Extract the firmware upgrade .zip file (right-click --> Extract all...) to the Desktop.
2. Navigate to the "support" folder.
3. Right-click on the **install_driver.bat** file and select "Run as administrator" and follow the instructions.

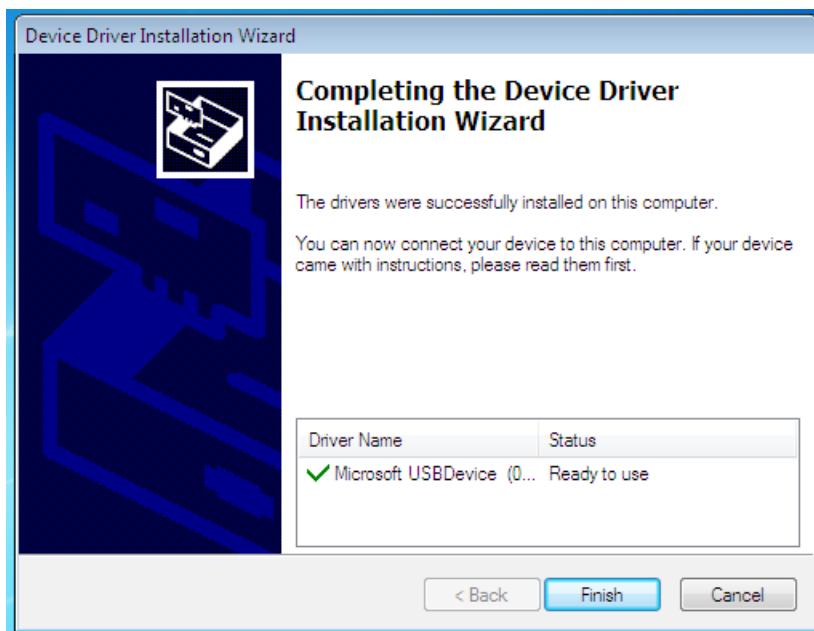

4. Operation

Using the On-Screen Menus

To display the on-screen menus, press MENU on the remote control (Figure 2-3) or built-in keypad (Figure 2-1).

To select a sub-menu, use the ▲ and ▼ buttons to highlight it. Then, press ► to enter that sub-menu.

To select a menu item, use the ▲ and ▼ buttons to highlight it. Then, press ◀ or ▶ to adjust that setting and press OK.

The OSD menus are arranged hierarchically, as shown in Figure 4-1. The default values appear in bold type. Depending on the selected input source and signal characteristics, some menu options may not be available.

Main Menu	SubMenu	Value
Image Settings	Scheme	User, Vivid, Cinema, Game, Sport
	Brightness	0, 1, 2, ..., 50 ,100
	Contrast	0, 1, 2, ..., 50 ,100
	Sharpness	0, 1, 2, ..., 50 ,100
	Saturation	0, 1, 2, ..., 50 ,100
	Hue	0, 1, 2, ..., 50 ,100
	Backlight	0, 1, 2, ..., 50, ..., 80 ,100
	Colour Temp & Gamma	Color Temp: 5000K; 6500K; 7500K; 9300K ; User Gamma: 2.2 ; off
	HDMI RGB Range	Auto ; 0-255; 16-235
Display Settings	Input Source	VGA; DisplayPort; HDMI1 ; HDMI2; HDMI3; HDMI4; OPS; WPS
	Aspect Ratio	16:9 ; 4:3; Auto; Point To Point; Letterbox
	OverScan	0% ~ 10%
	Auto Scan	On; Off
	Source Renaming	Rename the input source.
	Auto Adjust	-
	VGA Position	0 ~ 100 (50)
	VGA Phase	0 ~ 255
	VGA Clock	0 ~ 100 (50)
Audio	Volume	0 ~ 100 (50)
	Treble	-10 ~ 10 (0)
	Bass	-10 ~ 10 (0)
	Balance	-10 ~ 10 (0)
	Internal Speaker	On ; Off
	Audio Source	Line-In; DisplayPort; HDMI1~4; OPS; Front HDMI; PC

Main Menu	SubMenu	Value
Basic Settings	Horizontal Pos.	0 ~ 100 (50)
	Vertical Pos.	0 ~ 100 (50)
	OSD Transparency	0 ~ 4 (0)
	OSD Timeout	5 ~ 60 seconds (30)
	OSD Language	English , French, Spanish, German, Dutch, Swedish, Portuguese, Danish, Italian
	Splash Screen	On ; Off
	Power LED	On ; Off
	RTC & Schedule	User Mode ; Workday Mode; Everyday Mode
Adv. Settings	Smart Light Control	Off ; DCR; By Time
	IRFM	On; Off
	Noise Reduction	Off ; Low; Medium; High
	Wake Up from Sleep	VGA Only ; Digital, RS232, Ethernet; Never Sleep
	EDID Switch	1080p; 4K2K@30; 4K2K@60
	Touch Input Mapping	Auto ; WPS; HDMI4; OPS; HDMI3; Rear USB
	Network Configuration	-
	Software Update (USB)	Yes; No
	Restore Factory Default	Yes; No
Information	Source	Shows the Name of Input Source
	Resolution	Shows the Current Resolution
	Model Name	AVF-6550
	Firmware Version	Shows the Firmware Version of the Monitor
	SubMCU Version	Shows the Firmware Version of the Monitor
	Serial Number	Shows the Serial Number of the Monitor
	Load Default	Yes; No
	Device MAC	Shows the MAC address of the device



NOTE Default settings appear in bold type.

Figure 4-1. OSD Menu Structure

Input Menu

This menu is used for making common image adjustments.

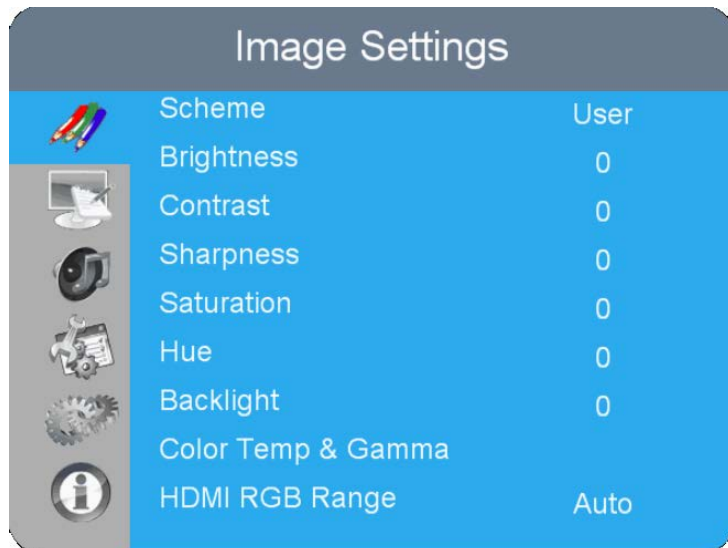

Scheme

Press ◀ or ▶ to select one of the follows:

Options: User, Vivid, Cinema, Game, Sport; **Default:** User

Brightness

Increase or decrease the brightness of picture.

Press ◀ or ▶ to select the desired level, and then press OK.

Range: 0-100; **Default:** 50

Contrast

Increase or decrease the contrast of picture.

Press ◀ or ▶ to select the desired level, and then press OK.

Range: 0-100; **Default:** 50

Saturation

Adjust the brilliance and brightness.

Press ◀ or ▶ to select the desired level, and then press OK.

Range: 0-100; **Default:** 50

Note: This function is not available when displaying PC or graphics sources

Hue

Increase or decrease the green hue.

Press ◀ or ▶ to select the desired level, and then press OK.

Range: 0-100; **Default:** 50

Note: This function is not available when displaying PC or graphics sources

Backlight

Increase or decrease the intensity of the LCD backlight.

Press ◀ or ▶ to select the desired level, and then press OK.

Range: 0-100; **Default:** 80

Color Temp & Gamma

Set Color Temperature and Gamma. See next page.

HDMI RGB Range

Select an RGB range for the HDMI input.

Options: Auto, 0-255, 16-235; **Default:** Auto

Colour Temperature Settings

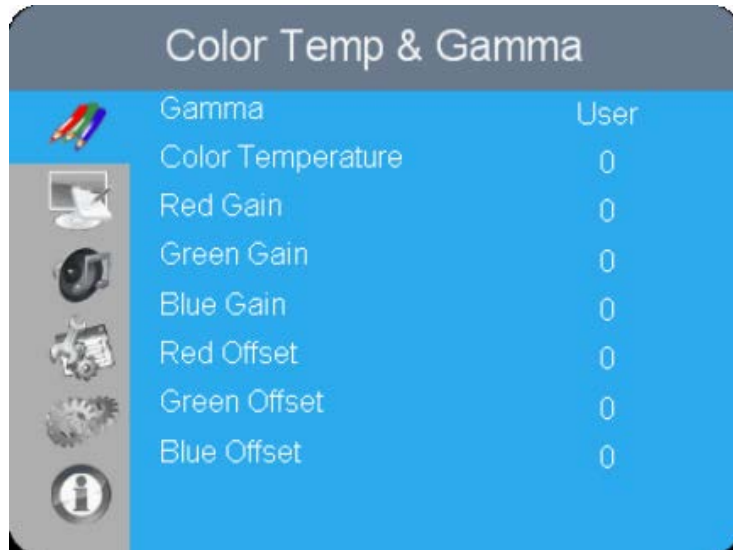

Gamma

Select gamma curve

Options: Off, 2.2; **Default:** 2.2

Color Temperature

Select a colour temperature or select User to make RGB adjustments.

Options: User, 5000K, 6500K, 7500K and 9300K; **Default:** 9300K

Red Gain

Set Colour Temperature to "User Mode" in order to adjust this setting.

Range: 0~100; **Default:** 100

Green Gain

Set Colour Temperature to "User Mode" in order to adjust this setting.

Range: 0~100; **Default:** 100

Blue Gain

Set Colour Temperature to "User Mode" in order to adjust this setting.

Range: 0~100; **Default:** 100

Red Offset

Set Colour Temperature to "User Mode" in order to adjust this setting.

Range: 0~100; **Default:** 50

Green Offset

Set Colour Temperature to "User Mode" in order to adjust this setting.

Range: 0~100; **Default:** 50

Blue Offset

Set Colour Temperature to "User Mode" in order to adjust this setting.

Range: 0~100; **Default:** 50

Display Settings

This menu is used for making general display settings.

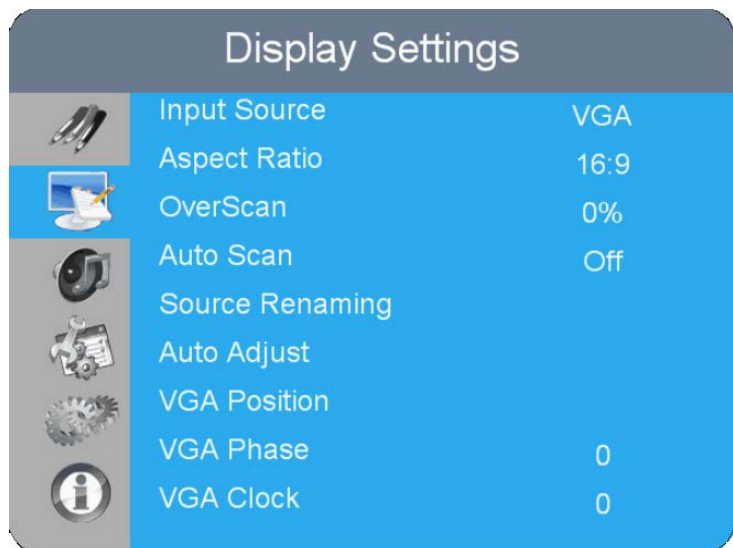

Input Source

Select the main input source

Options: VGA; DisplayPort; HDMI1~4; OPS; WPS

Default: HDMI 1

Aspect Ratio

Select aspect ratio

Press ◀ or ▶ to select the aspect ratio, and then press OK.

Range: 16:9; 4:3; Auto; Point To Point; Letterbox

Default: 16:9

OverScan

Adjust the overscan of the image.

Press ◀ or ▶ to select the desired level, and then press OK.

Range: 0% ~ 10%; **Default:** 0%

Auto Scan

Select whether the display will automatically scan for a main input source

Options: On, Off; **Default:** Off

Source Renaming

Rename the input source.

Press OK to select the input source you want to rename. Using ▲ or ▼ to change the character and ◀ or ▶ to move forward/back a position. Then press OK button to save the name.

Auto Adjust

Force the display to reacquire and lock to the input signal (VGA source only). This is useful when the signal quality is marginal.

Options: No, Yes; **Default:** No

Note: This feature does not continually reacquire the signal.

VGA Position

Adjust the position of the image (VGA source only). Press ◀ or ▶ to select the desired level, and then press OK.

Range: 0~100; **Default:** 50

VGA Phase

Adjust the phase of the displayed signal (VGA source only). Press ◀ or ▶ to select the desired level, and then press OK.

Range: 0~100

VGA Clock

Adjust the clock of the displayed signal (VGA source only). Press ◀ or ▶ to select the desired level, and then press OK.

Range: 0~100

Audio Menu

This menu is used for adjusting volume settings.

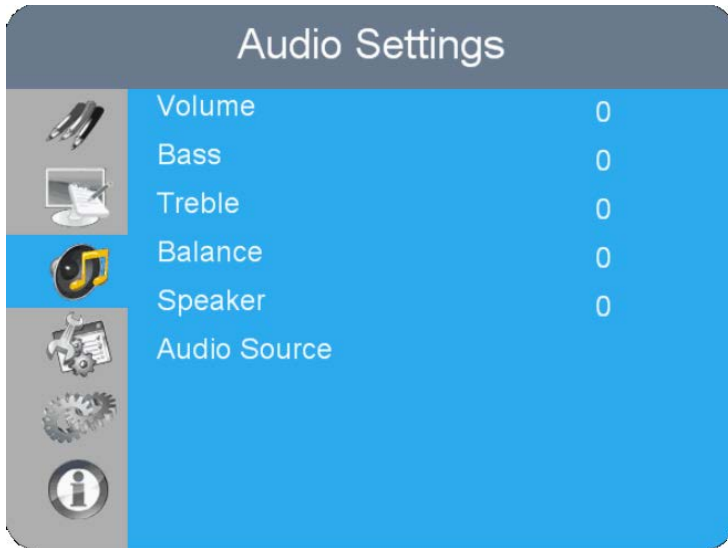

Volume

Adjust the sound. Press ◀ or ▶ to select the desired level, and then press OK.

Range: 0~100; **Default:** 50

Bass

Adjust the sound in low tones (bass). Press ◀ or ▶ to select the desired level, and then press OK.

Range: -10~10; **Default:** 0

Treble

Adjust the sound in high tones (treble). Press ◀ or ▶ to select the desired level, and then press OK.

Range: -10~10; **Default:** 0

Balance

Adjust the balance of the left and right speakers. Press ◀ or ▶ to select the desired level, and then press OK.

Range: -10~10; **Default:** 0

Speaker

Turn the internal speaker on or off

Default: On

Audio Source

Select the audio source for the Main input

Options: Line-In, DisplayPort, HDMI1~4, OPS, WPS

Basic Settings

This menu is used to make basic settings.

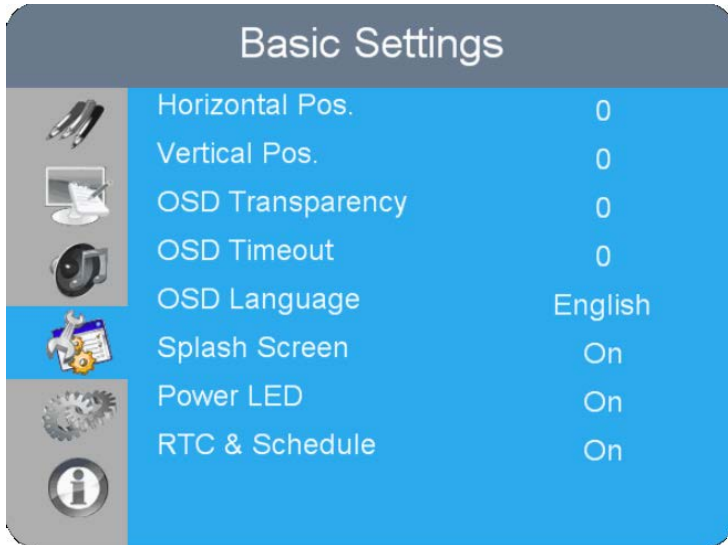

Horizontal Pos.

Adjust the horizontal position of the OSD menu. Press ◀ or ▶ to select the desired level, and then press OK.

Range: 0~100; **Default:** 50

Vertical Pos.

Adjust the vertical position of the OSD menu. Press ◀ or ▶ to select the desired level, and then press OK.

Range: 0~100; **Default:** 50

OSD Transparency

Adjust the transparency of the OSD menu. Press ◀ or ▶ to select the desired level, and then press OK.

Range: 0~4; **Default:** 0

OSD Timeout

Adjust the time in seconds before the OSD menu disappears. Press ◀ or ▶ to select the desired level, and then press OK.

Options: 5s~60s; **Default:** 30s

OSD Language

Select the OSD language

Options: English, French, Spanish, German, Dutch, Swedish, Portuguese, Danish, Italian; **Default:** English

Splash Screen

Select whether a splash screen appears when the monitor is powered up

Options: On, Off; **Default:** On

Power LED

Enable or disable the status LED

Options: On, Off; **Default:** On

RTC & Schedule

Set the internal clock of the display, and to power on and off the display at preset times if desired.

Options: User mode, Workday mode, Everyday mode

Default: User mode

Advanced Settings

This menu is used to make advanced settings.

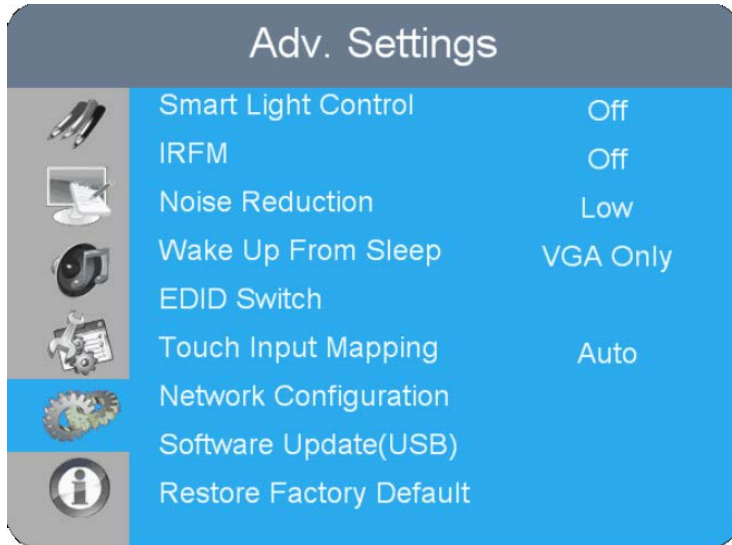

Smart Light Control

Enable dynamic contrast (DCR) or ambient light sensor

Options: Off, DCR, By Time; **Default:** Off

IRFM

Create slight frame motion to help avoid image retention

Options: On, Off; **Default:** Off

Noise Reduction

Reduce random noise in the video content

Options: Off, Low, Medium, High; **Default:** Off

Wake Up From Sleep

Options: VGA Only, Digital, RS232, Ethernet; Never Sleep

Default: VGA Only

EDID Switch

Select EDID (Extended Display Identification Data) of the HDMI 1-4, OPS, and WPS inputs. **Options:** 1080p, 4K2K@30, 4K2K@60; **Default:** 4K2K@60

Note: Use the 1080p setting for the broadest support of lower resolution sources. Use 4K2K setting to support high resolution sources such as 3840x2160.

Touch Input Mapping

Select one of the touch connections or choose auto detection.

Options: Auto, WPS, HDMI3-4, OPS, Rear USB; **Default:** Auto

Network Configuration

Configures the network settings.

Software Update(USB)

Plug in the USB flash drive and select Yes to proceed with firmware update. To start updating firmware, select Yes to continue.

Options: No, Yes; **Default:** Yes

Factory Reset

Restore all settings to their default value.

Options: No, Yes; **Default:** No

Smart Light Control – By Time

By Time settings allow the user to set the brightness level of the display to a free range in % (between 0-100%) during specific times of the day.

Weekday	Active	BL Saving	Time to Enable	Duration
MON	0	0	0 : 0	0 : 0
TUE	0	0	0 : 0	0 : 0
WED	0	0	0 : 0	0 : 0
THU	0	0	0 : 0	0 : 0
FRI	0	0	0 : 0	0 : 0
SAT	0	0	0 : 0	0 : 0
SUN	0	0	0 : 0	0 : 0

Wake Up from Sleep

By default, the display will enter power saving (Sleep Mode) if no signal is received for 5 minutes. Normally, the RS-232, DisplayPort, and HDMI inputs are inactive in Sleep Mode, to save power.

To change the behavior of Sleep Mode, change the “**Wake up from Sleep**” setting in the “**Adv. Setup**” menu.

- **VGA Only** (default) – The RS-232, DisplayPort, and HDMI inputs are inactive when the display is in sleep mode. The display will wake up when it receives a signal at the VGA input.
- **Digital, RS232, Ethernet** – The RS-232, DisplayPort and HDMI inputs stay active when the display is in sleep mode. The display will wake up when it receives a signal at either of the DisplayPort, HDMI, or RS-232 inputs, or via LAN connection.

Network Configuration

By default, the display will enter power saving (Sleep Mode) if no signal is received for 5 minutes. Normally, the RS-232, DisplayPort, and HDMI inputs are inactive in Sleep Mode, to save power.

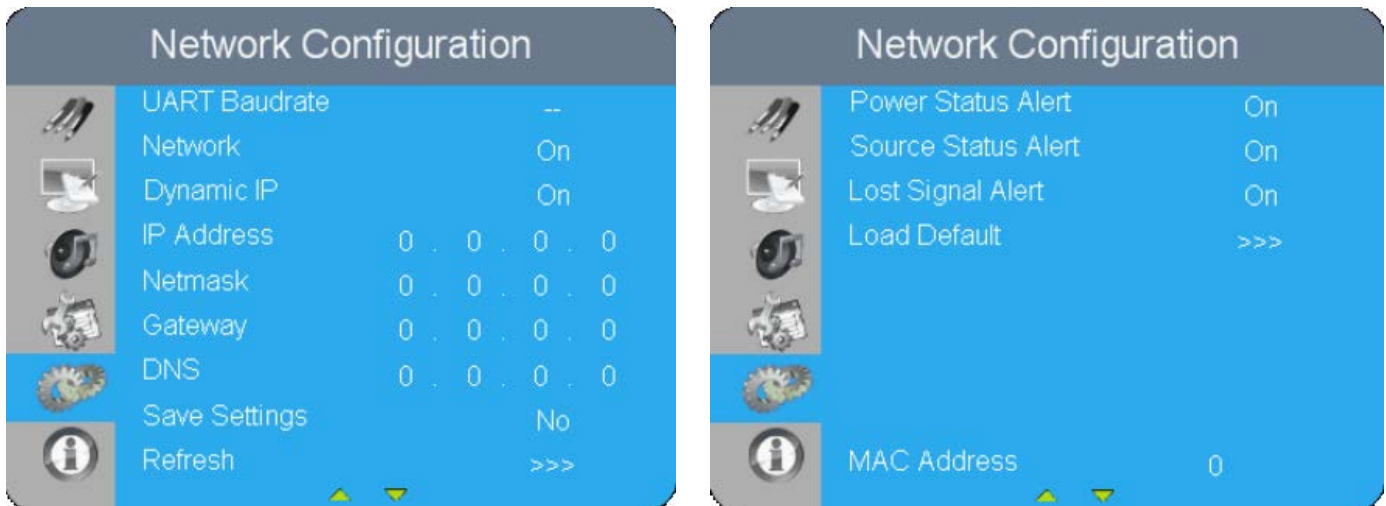

This menu configures the display's RS232 and Ethernet communication ports.

UART Baudrate	Select the baud rate of the display's RS232 port Options: 115200, 38400, 19200, 9600; Default: 115200
Network	Enable the display's built-in Ethernet port Options: No, Yes; Default: No
IP Address	Enable Dynamic IP mode or set the static IP address of the display's Ethernet port Default: 0.0.0.0
Netmask	Set the subnet mask address. Default: 0.0.0.0
Gateway	Set the Gateway mask address. Default: 0.0.0.0
DNS	Set the DNS mask address. Default: 0.0.0.0
Save Settings	Save the network settings and apply to device.
Refresh	Refresh dynamic IP information.
Power Status Alert	Enable an automatic alert when the display is powered down Options: On, Off; Default: Off
Source Status Alert	Enable an automatic alert when the source is changed Options: On, Off; Default: Off

Signal Lost Alert	Enable an automatic alert when the video signal is lost Options: On, Off; Default: Off
Load Default	Load default communication settings Options: No, Yes
Device MAC	Display the MAC address of the device.

Information

This read-only menu provides information on the active source, the latest firmware version, and the serial number.

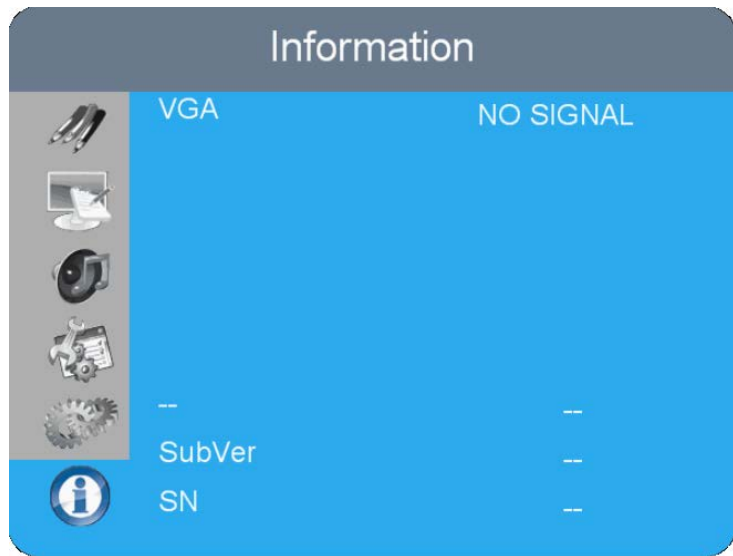

5. Maintenance and Troubleshooting

Maintenance

The AVOCOR Series LED Displays does not require any routine maintenance other than occasional cleaning with a non-abrasive cloth. There are no user-serviceable or replaceable parts. Unless you are a qualified, factory-trained technician, do not attempt to repair or replace any system component yourself. You will void the product warranty if you do so.

Troubleshooting

Table 5-1 provides some general guidelines for troubleshooting problems you may encounter with the AVOCOR Series LED Display. If the suggested solutions fail to resolve the problem or if you encounter an issue not described here, please contact your dealer.

Table 5-1. Troubleshooting Chart

Symptom	Possible Cause(s)	Solution
The display does not turn on.	<p>The display is not plugged in or the AC outlet is not active.</p> <p>The main power switch is off.</p> <p>The remote control batteries have run out.</p>	<p>Ensure that the display is plugged in and that the AC outlet is active.</p> <p>Set the main power switch (see Figure 2-1) to the on position.</p> <p>Replace the batteries.</p>
The display is on and menus appear, but there is no picture.	<p>Incorrect source selection.</p> <p>Source component is not turned on.</p> <p>Source component is connected incorrectly or not at all.</p>	<p>Select the correct source.</p> <p>Turn on the source component.</p> <p>Check connections from the source component to the display.</p>
The remote control does not work.	<p>The remote control batteries have run out.</p> <p>The buttons are locked.</p>	<p>Replace the batteries.</p> <p>Unlock the buttons by pressing OK, OK, EXIT, EXIT, OK and EXIT, in sequence.</p>
Image geometry is incorrect.	<p>Incorrect aspect ratio selection.</p>	<p>Select a different aspect ratio.</p>
The display is jittery or unstable.	<p>Poor-quality or improperly connected source.</p> <p>The horizontal or vertical scan frequency of the input signal may be out of range for the display.</p>	<p>Ensure that the source is properly connected and of adequate quality for detection.</p> <p>Correct at the source.</p>

Table 5-1. Troubleshooting Chart (continued)

Symptom	Possible Cause(s)	Solution
Image is too bright and / or lacks definition in the bright areas of the image.	Contrast is set too high.	Decrease the contrast setting.
Image appears "washed out" and / or dark areas appear too bright.	Brightness is set too high.	Decrease the brightness setting.
Image is too dark.	Brightness and / or Backlight are set too low.	Increase the brightness and / or backlight settings.
Images from an HDMI source do not display.	The resolution and frequency of the video card in the computer are not compatible with the display.	Select a compatible resolution and vertical frequency (refer to Supported Timings on page 59).
	HDMI cable from source to display is either defective or too long.	Try a known-good and / or shorter HDMI cable.
Computer images do not display correctly.	The resolution and frequency of the video card in the computer are not compatible with the display	Select a compatible resolution and vertical frequency (refer to Supported Timings on page 59).
	Clock and Phase settings need adjustment.	Adjust Clocks and Phase settings (refer to Setup Settings page 41).
Touch screen doesn't work.	Multi-touch controller host computer is not connected correctly.	See Figure 3-7.
	Host computer hardware or OS incompatibility.	Refer to Enabling the Touch Screen on page 32.

Should you require assistance with a suspected hardware fault, please contact the support line below. You will require your unit serial number. The operator will attempt to diagnose any fault and will take action as appropriate.

The Avocor logo is displayed in a large, bold, black sans-serif font. The letters are lowercase, and a small trademark symbol (TM) is positioned at the top right of the letter 'r'. The logo is centered within a white rectangular box that has a thin black border.

Warranty Support

UK & EMEA. Tel +44 (0) 1276 804 654 - service@avocor.co.uk

US & ROW. Tel. 858-268-7999 - service@avocor.com

6. External Control

In addition to using the display keypad or remote control unit, you can control the display using a serial (RS-232) link to send ASCII commands and receive responses to those commands.

You also use discrete infrared (IR) control codes to program a third-party remote control unit. For more information, refer to Using Discrete IR Codes on page 57.

Serial Communications

The display uses a simple text-based control protocol to take requests from control devices and to provide responses to such devices. This section describes how to send control messages over a serial link between the display and an automation/control system or a PC running a terminal emulation program such as Windows® HyperTerminal or Tera Term.

RS232 Connection and Port Configuration

Connect your control system or PC to the RS232 input of the display as shown in Figure 3-2.

Configure the RS232 controller or PC serial port as follows: no parity, 8 data bits, 1 stop bit and no flow control. Set the baud rate to 115200, to match that of the display RS232 port.

Command and Response Format

Commands sent from an automation/control system or PC to the display must have the following format:

[STX] [IDT] [TYPE] [CMD] ([VALUE] or [REPLY]) [ETX] [CR]

Where:

- [STX] indicates the start of the command data (always 07).
- [IDT] is the display ID (always 01).
- [TYPE] is the command type:
 - 00 = return to host (response from the LCD panel)
 - 01 = read / action
 - 02 = write
- [VALUE] is the parameter setting for the command.
- [REPLY] is the parameter setting for the command, acknowledged by the display in its response to a command.
- [ETX] indicates the end of the command data (always 08).
- [CR] is the ASCII carriage return key (0x0D).

Command and Response Examples

Here are some examples of serial commands and their responses:

Table 6-1. Serial Command/ Response Examples

Description	Command sent to LCD Panel	Response Received from LCD Panel
Turn LCD panel power off.	07 01 02 50 4F 57 00 08	07 01 00 50 4F 57 00 08
Turn LCD panel power on.	07 01 02 50 4F 57 01 08	07 01 00 50 4F 57 01 08
Request LCD panel power status.	07 01 01 50 4F 57 08	07 01 00 50 4F 57 XX 08 (XX = 0 when off or 1 when on)
Set the LCD panel contrast to 30 (1E hex).	07 01 02 43 4F 4E 1E 08	07 01 00 43 4F 4E 1E 08
Reset the LCD panel display settings.	07 01 02 41 4C 4C 00 08	07 01 00 41 4C 4C 00 08
Request LCD panel serial number.	07 01 01 53 45 52 08	07 01 00 53 45 52 S(0)...S(12) 08 S(0) ...S(12) = the serial number in ASCII
Request LCD panel firmware version.	07 01 01 47 56 45 08	07 01 00 47 56 45 S(0)...S(5) 08 S(0)...S(5) = the firmware version in ASCII

Serial Command List

Table 6-2 lists all supported commands.

Table 6-2. Serial Commands

Main Item	Control Item	CMD	Type	Value (HEX)	Reply (HEX)	Content	CMD (HEX)
Power Control and Input Source	Power Control	POW	W/R	0	0	Off (soft power)	50 4F 57
				1	1	On (soft power)	
	IPC Control	IPC	W/R	0	0	Off	49 50 43
				1	1	On	
	Input Source	MIN	W/R	0	0	VGA	4D 49 4E
				9	9	HDMI 1	
				0A	0A	HDMI 2	
				0B	0B	HDMI 3	
				0C	0C	HDMI 4	
				0D	0D	Displayport	
0E				0E	IPC/OPS		
13				13	WPS		
Display Adjustment	Display Adjustment	BRI	W/R	00~64	00~64	Back Light Brightness	42 52 49
		BRL	W/R	00~64	00~64	Digital Brightness Level	42 52 4C
		BLC	W/R	0	0	Off (Back Light)	42 4C 43
				1	1	On (Back Light)	
		CON	W/R	00~64	00~64	Contrast	43 4F 4E
		HUE	W/R	00~64	00~64	Hue	48 55 45
		SAT	W/R	00~64	00~64	Saturation	53 41 54
		NOR	W/R	0	0	Noise Reduction: Off	4E 4F 52
				1	1	Noise Reduction: Low	
				2	2	Noise Reduction: Medium	
3	3			Noise Reduction: High			
USR	W/R	00~64	00~64	Red Gain (mapping 0~100)	55 53 52		

Main Item	Control Item	CMD	Type	Value (HEX)	Reply (HEX)	Content	CMD (HEX)	
Display Adjustment	Display Adjustment	USG	W/R	00~64	00~64	Green Gain (mapping 0~100)	55 53 47	
		USB	W/R	00~64	00~64	Blue Gain (mapping 0~100)	55 53 42	
		UOR	W/R	00~64	00~64	Red Offset (mapping 0~100)	55 4F 52	
		UOG	W/R	00~64	00~64	Green Offset (mapping 0~100)	55 4F 47	
		UOB	W/R	00~64	00~64	Blue Offset (mapping 0~100)	55 4F 42	
		COT	W/R	0	0	User	43 4F 54	
				1	1	6500K		
				2	2	9300K		
				6	6	5000K		
		GAC	W/R	7	7	7500K	47 41 43	
	0			0	Gamma Off			
			1	1	Gamma 2.2			
	VGA Adjustment		PHA	W/R	00~FF	00~FF	Phase	50 48 41
			CLO	W/R	00~64	00~64	Clock	43 4C 4F
			HOR	R/W	00~64	00~64	Horizontal Position	48 4F 52
VER			R/W	00~64	00~64	Vertical Position	56 45 52	
ADJ			W	0	0	Auto Adjust	41 44 4A	
Sharpness	SHA	W/R	00~64	00~64	Sharpness	53 48 41		
Other Control	Scaling	ASP	W/R	0	0	Main Window Aspect Ratio Native(PointToPoint)	41 53 50	
				1	1	Full Screen (16:9)		
				2	2	Pillarbox (4:3)		
				3	3	Letterbox		
				4	4	Auto		
	ZOM	W/R	00~0A	00~0A	Adjust overscan ratio	5A 4F 4D		
	Baudrate Adjustment	BRA	W/R	0	0	115200	42 52 41	
				1	1	38400		
				2	2	19200		
				3	3	9600		
	Other Control	RCU	W	0	0	MENU Key	52 43 55	
				1	1	INFO Key		
				2	2	UP Key		
				3	3	DOWN Key		
				4	4	LEFT Key		
				5	5	RIGHT Key		
				6	6	OK Key		
				7	7	EXIT Key		
				8	8	VGA Key		
				0A	0A	HDMI1 Key		
				0B	0B	HDMI2 Key		
				17	17	SCALING Key		
				18	18	FREEZE Key		
19	19	MUTE Key						
1A	1A	BRIGHT Key						
1B	1B	CONTRAST Key						
1C	1C	AUTO Key						
1D	1D	VOLUME+ Key						
1E	1E	VOLUME- Key						

Main Item	Control Item	CMD	Type	Value (HEX)	Reply (HEX)	Content	CMD (HEX)																		
Other Control	Other Control			1F	1F	HDMI3 Key																			
				21	21	OPS Key																			
		ALL	W		0	0	Reset all	41 4C 4C																	
					1	1	Reset all but communication (RS232, LAN)																		
		KLC	W/R		0	0	Un-lock keys	4B 4C 43																	
					1	1	Lock keys																		
		SER	R			13 bytes	Read Serial Number	53 45 52																	
		MNA	R			13 bytes	Read Model Name	4D 4E 41																	
		GVE	R			6 bytes	Read Firmware Version	47 56 45																	
		RTV	R			Current value	Read RS232 table Version	52 54 56																	
		GVS	W		0	[00]+5 byte	Querying main scaler version	47 56 53																	
					1	[00]+5 byte	Querying sub mcu version																		
				2	[00]+5 byte	Querying network module version																			
	Audio	VOL	W/R	00~64	00~64	volume	56 4F 4C																		
		BAS	W/R	00~14	00~14	Bass (-10~10)	42 41 53																		
		TRE	W/R	00~14	00~14	Treble (-10~10)	54 52 45																		
		BAL	W/R	00~14	00~14	Bass (-10~10)	42 41 4C																		
		INS	W/R		0	0	Internal Speaker Off	49 4E 53																	
					1	1	Internal Speaker On																		
		MUT	W/R		0	0	Mute Off	4D 55 54																	
				1	1	Mute On																			
	Scheme selection	SCM	W/R		0	0	User	53 43 4D																	
					1	1	Sport																		
					2	2	Game																		
				3	3	Cinema																			
				4	4	Vivid																			
Other Control	EcoMode WakeUpFromSleep	WFS	W/R		0	0	Set VGA_ONLY	57 46 53																	
					1	1	Set DIGITAL, RS232, Ethernet																		
					2	2	Set Never_Sleep																		
	RTC	RTY	W/R	00~63	00~63	Set Real time Year	52 54 59																		
								RTM	W/R	01~0C	01~0C	Set Real time Month	52 54 4D												
														RTD	W/R	01~1F	01~1F	Set Real time Day	52 54 44						
																				RTH	W/R	00~17	00~17	Set Real time Hour	52 54 48
		TMS	W/R		0	0	Same Settings On All (Everyday)	54 4D 53																	
					1	1	Same Settings On Work Days (Workday)																		
					2	2	User																		
		AEN	W/R		1	1	Sunday Alarm Enable (Note 14)	41 45 4E																	
					2	2	Monday Alarm Enable (Note 14)																		
				4	4	Tuesday Alarm Enable (Note 14)																			

Main Item	Control Item	CMD	Type	Value (HEX)	Reply (HEX)	Content	CMD (HEX)		
Other Control	RTC	AEN	W/R	8	8	Wednesday Alarm Enable (Note 14)			
				10	10	Thursday Alarm Enable (Note 14)			
				20	20	Friday Alarm Enable (Note 14)			
				40	40	Saturday Alarm Enable (Note 14)			
		AEF	W/R	1	1	Sunday Alarm Disable (Note 14)		41 45 46	
				2	2	Monday Alarm Disable (Note 14)			
				4	4	Tuesday Alarm Disable (Note 14)			
				8	8	Wednesday Alarm Disable (Note 14)			
				10	10	Thursday Alarm Disable (Note 14)			
				20	20	Friday Alarm Disable (Note 14)			
				40	40	Saturday Alarm Disable (Note 14)			
		NNH	W/R	00~17	00~17	Monday On Hour		4E 4E 48	
		NNM	W/R	00~3B	00~3B	Monday On Minute		4E 4E 4D	
		NFH	W/R	00~17	00~17	Monday Off Hour		4E 46 48	
		NFM	W/R	00~3B	00~3B	Monday Off Minute		4E 46 4D	
		ENH	W/R	00~17	00~17	Tuesday On Hour		45 4E 48	
		ENM	W/R	00~3B	00~3B	Tuesday On Minute		45 4E 4D	
		EFH	W/R	00~17	00~17	Tuesday Off Hour		45 46 48	
		EFM	W/R	00~3B	00~3B	Tuesday Off Minute		45 46 4D	
		DNH	W/R	00~17	00~17	Wednesday On Hour		44 4E 48	
		DNM	W/R	00~3B	00~3B	Wednesday On Minute		44 4E 4D	
		DFH	W/R	00~17	00~17	Wednesday Off Hour		44 46 48	
		DFM	W/R	00~3B	00~3B	Wednesday Off Minute		44 46 4D	
		UNH	W/R	00~17	00~17	Thursday On Hour		55 4E 48	
		UNM	W/R	00~3B	00~3B	Thursday On Minute		55 4E 4D	
		UFH	W/R	00~17	00~17	Thursday Off Hour		55 46 48	
		UFM	W/R	00~3B	00~3B	Thursday Off Minute		55 46 4D	
		INH	W/R	00~17	00~17	Friday On Hour		49 4E 48	
		INM	W/R	00~3B	00~3B	Friday On Minute		49 4E 4D	
		IFH	W/R	00~17	00~17	Friday Off Hour		49 46 48	
		IFM	W/R	00~3B	00~3B	Friday Off Minute		49 46 4D	
		TNH	W/R	00~17	00~17	Saturday On Hour		54 4E 48	
		TNM	W/R	00~3B	00~3B	Saturday On Minute		54 4E 4D	
		TFH	W/R	00~17	00~17	Saturday Off Hour		54 46 48	
		TFM	W/R	00~3B	00~3B	Saturday Off Minute		54 46 4D	
		SNH	W/R	00~17	00~17	Sunday On Hour		53 4E 48	
		SNM	W/R	00~3B	00~3B	Sunday On Minute		53 4E 4D	
		SFH	W/R	00~17	00~17	Sunday Off Hour		53 46 48	
		SFM	W/R	00~3B	00~3B	Sunday Off Minute		53 46 4D	
		Auto Scan	ATS	W/R	0	0	Off		41 54 53
					1	1	Main		
		IRFM	IRF	W/R	0	0	Off		49 52 46
					1	1	On		

Main Item	Control Item	CMD	Type	Value (HEX)	Reply (HEX)	Content	CMD (HEX)
Other Control	Smart Light Control	SLC	W/R	0	0	Off	53 4C 43
				1	1	DCR	
				3	3	By time	
	Power LED	LED	W/R	0	0	Off	4C 45 44
				1	1	On	
	HDMI EDID	EDH	W/R	0	0	4Kx2K	45 44 48
				1	1	1080P	
	DisplayPort EDID	EDP	W/R	0	0	4Kx2K	45 44 50
				1	1	1080P	
	HDMI RGB Color Range	HCR	W/R	0	0	Auto Detect	48 43 52
				1	1	0-255	
				2	2	16-235	
	Touch Control	TOC	W/R	0	0	Auto (Read Only)	54 4F 43
				1	1	OPS	
				2	2	External Touch1 (HDMI3)	
				3	3	External Touch 2 (Rear USB)	
				4	4	MiniPC(HDMI4)	
				5	3	WPS	
OSD Control	Transparency	OST	W/R	00-04	00-04	OSD Transparency	4F 53 54
	H Position	OSH	W/R	00-64	00-64	OSD H Position	4F 53 48
	V Position	OSV	W/R	00-64	00-64	OSD V Position	4F 53 56
	OSD Language	OSL	W/R	0	0	English	4F 53 4C
				1	1	French	
				2	2	German	
				3	3	Dutch	
				08	08	Danish	
				0D	0D	Italian	
				0E	0E	Swedish	
				0F	0F	Portuguese	
10	10	Spanish					
OSD Timeout	OSO	W/R	05-3C	05-3C	OSD Timeout (5, 10, 20, 30, 60 sec)	4F 53 4F	
Ethernet Setup	Network Enable	NWE	W/R	0	0	No	4E 57 45
				1	1	Yes	
	Dynamic IP	DIP	W/R	0	0	Disable	44 49 50
				1	1	Enable	
	Default	LDS	W	0	0	Load network default settings (It will take about 15 seconds.)	4C 44 53
	E-Mail Alert	PSA	W/R	0	0	Off (Power Status Alert)	50 53 41
				1	1	On (Power Status Alert)	
		SSA	W/R	0	0	Off (Source Status Alert)	53 53 41
				1	1	On (Source Status Alert)	
		SLA	W/R	0	0	Off (Signal Lost Alert)	53 4C 41
1				1	On (Signal Lost Alert)		

Main Item	Control Item	CMD	Type	Value (HEX)	Reply (HEX)	Content	CMD (HEX)
Ethernet Setup	Static IP Settings	IP1	W/R	00~FF	00~FF	Static IP Address 1	49 50 31
		IP2	W/R	00~FF	00~FF	Static IP Address 2	49 50 32
		IP3	W/R	00~FF	00~FF	Static IP Address 3	49 50 33
		IP4	W/R	00~FF	00~FF	Static IP Address 4	49 50 34
		MK1	W/R	00~FF	00~FF	Subnet Mask 1	4D 4B 31
		MK2	W/R	00~FF	00~FF	Subnet Mask 2	4D 4B 32
		MK3	W/R	00~FF	00~FF	Subnet Mask 3	4D 4B 33
		MK4	W/R	00~FF	00~FF	Subnet Mask 4	4D 4B 34
		GW1	W/R	00~FF	00~FF	Gateway 1	47 57 31
		GW2	W/R	00~FF	00~FF	Gateway 2	47 57 32
		GW3	W/R	00~FF	00~FF	Gateway 3	47 57 33
		GW4	W/R	00~FF	00~FF	Gateway 4	47 57 34
		FD1	W/R	00~FF	00~FF	DNS Address 1	46 44 31
		FD2	W/R	00~FF	00~FF	DNS Address 2	46 44 32
		FD3	W/R	00~FF	00~FF	DNS Address 3	46 44 33
		FD4	W/R	00~FF	00~FF	DNS Address 4	46 44 34
		SNS	W	0	0	Save Network Settings	53 4E 53
		MAC	W	00~05	00~FF	Querying MAC ID #0~#5	4D 41 43

Using Discrete IR Codes

The display accepts commands in the form of infrared (IR) signals that conform to the NEC protocol. Each display remote control button has an IR control code associated with it.

You can use these codes to program a third-party, "universal" remote control unit to work with the display. These third-party products usually come with a computer software application for this purpose. For more information, consult the documentation provided with the remote control unit.

IR Command Protocol

The IR control codes have the following characteristics:

Each code consists of the following:

- A leader pulse (a modulated pulse of 9 ms followed by a non-modulated pulse of 4.5 ms);
- 16 address bits (also called a "custom code"): eight (8) bits for the address followed by the logical inverse of the address. The custom code for the display is 16559 decimal (0x40AF, binary 01000000 10101111).
- 16 data bits: eight (8) bits for the command followed by the logical inverse of the command
- An end pulse (a modulated pulse of 0.56 ms, similar to the modulated pulse in the '0' and '1' bits). The end of the modulated pulse constitutes the end of the data transmission.

The carrier frequency is 38 kHz, with the modulated pulses having a 33% duty cycle.

Commands are sent at a maximum rate of 9 Hz.

For example, here is the NEC control code for the POWER button on the display remote control unit:

Hex	40	AF	1C	E3
Binary	01000000	10101111	00011100	11100011
Function	Cust. Code Byte 1	Cust. Code Byte 2	Command	Command (Logical Inverse)

IR Control Code List

Table 6-3 lists the IR control codes for the display.

Table 6-3. Infrared (IR) Control Codes

No.	Customer Code	Data Code	Function
1	40AF	1CE3	POWER
2	40AF	15EA	HOME/OPS
3	40AF	0FF0	SOURCE
4	40AF	02FD	UP
5	40AF	01FE	LEFT
6	40AF	03FC	RIGHT
7	40AF	19E6	DOWN
8	40AF	12ED	OK
9	40AF	05FA	EXIT
10	40AF	1BF4	Volume -
11	40AF	1DE2	Volume +
12	40AF	0EF1	MENU

7. Specifications

Table 7-1 lists the signal types supported by each input on the **AVF-6550** display.

PANEL	
Diagonal Size (Inch)	65"
Backlight	Direct LED
Aspect Ratio	16:9
Input Resolution	3840 x 2160 @ 60 Hz
Response Time	8 (ms)
Brightness	370 (cd/m ²)
Contrast Ratio	4000:1
Viewing Angle	178° (H) / 178° (V)
Supported Colours	1.07 billion colors
Display Orientation	Landscape compatible
TOUCH SYSTEM	
Interface	Touch USB
Touch	High-resolution inGlass™ touch; Up to 20 points
Glass	Chemically strengthened glass with G2&AF finish; 0.1-inch/2mm thickness
Supported Operating System	Windows 7 / 8 / 10; Mac OS 10
AUDIO	
Built-in Speakers	4 KΩ / 2 x 15W
CONNECTIVITY	
Connections	5x HDMI 2.0 / 1 x VGA / 1 x DisplayPort 1.2 / 1 x HDMI Out
Audio	Audio In / Audio Out / SPDIF Out
Control	1x Touch USB 3.0 HUB / 3 x Touch USB 2.0 / RS232 / Ethernet
PHYSICAL SPECIFICATIONS	
Dimensions	61.8 x 36.2 x 3.8 (in) / 1,569 x 919.2 x 95.5(mm)
Weight	Net: 46.5 kg / Gross: 58.5 kg
Wall Mount	23.6 x 15.7 (in) / 600 x 400(mm)
MiniPC Mount	75 x 75, 100 x 100 (mm) / 2.9 x 2.9, 3.9 x 3.9 (in)
Fanless Design	Yes
OSD FUNCTIONS	
OSD Languages	English, French, German, Dutch, Danish, Italian, Swedish, Portuguese, Spanish
Source Auto Detect Function	Yes
POWER	
Power Supply	AC100-240V (Worldwide), Max 3.7A, 50/60Hz
Maximum Power Consumption	200 W (w/o OPS module)
Standby	≤0.5 W
ENVIRONMENTAL	
Operating Temperature	0 °C ~ 40 °C
Storage Temperature	-20 °C ~ 60 °C
Humidity	35% ~ 85%

Supported Timings

Table 7-2 lists the signal types supported by each input on the display.

Table 7-2. Supported Timings By Input

Timing		fH (kHz)	fV (Hz)	Dot clock (MHz)	HDMI	VGA	DisplayPort	
VESA	VGA 640x480	31.469	59.94	25.175	○	○	○	
		37.861	72.809	31.5	○	○	○	
		37.5	75	31.5	○	○	○	
	SVGA 800x600	35.156	56.25	36	○	○	○	
		37.879	60.317	40	○	○	○	
		48.077	72.188	50	○	○	○	
		46.875	75	49.5	○	○	○	
	XGA 1024x768	48.363	60.004	65	○	○	○	
		56.476	70.069	75	○	○	○	
		60.023	75.029	78.75	○	○	○	
	WXGA1366x768	47.712	59.79	85.5	○	○	○	
	1280 x 720	44.444	59.98	64	-	○	○	
		44.772	59.86	74.5	-	○	○	
		56.456	74.78	95.75	-	-	○	
	1280 x 768	47.776	59.87	79.5	-	-	○	
		47.396	59.995	68.25	-	-	○	
	1280 x 800	49.306	59.91	71	○	○	○	
		49.702	59.81	83	○	○	○	
	SXGA	1152x864	67.5	75	108	○	○	○
		1280x1024	63.981	60.02	108	○	○	○
			79.976	75.025	135	○	○	○
	1440 x 900	55.469	59.901	88.75	-	-	○	
		55.935	59.88	106.5	○	○	○	
WSXGA+ 1680 x1050	64.674	59.883	119	○	○	○		
	65.29	59.954	146.25	○	○	○		
UXGA 1600 x 1200	75	60	162	○	○	○		
1920 x 1080	66.587	59.93	138.5	-	○	○		
WUXA 1920 x 1200	74.038	59.95	154	-	○	○		
QHD 2560x1440	88.787	59.951	241.5	○	-	○		
QSXGA 2560x1600	98.713	59.972	268.5	○	-	○		
EDTV	480p	31.5	60	27.03	○	-	○	
	576p	31.25	50	27	○	-	○	
HDTV	720p	37.5	50	74.25	○	-	○	
	1280x720	44.995	59.94	74.176	○	-	○	
		45	60	74.25	○	-	○	
	1080i	28.13	50	74.25	○	-	○	
	1920x1080	33.716	59.94	74.176	○	-	○	
		33.75	60	74.25	○	-	○	
	1080p 1920x1080	27	24	74.25	○	-	○	
		28.125	25	74.25	○	-	○	
		33.75	30	74.25	○	-	○	
		56.25	50	148.5	○	-	○	
67.433		59.94	148.352	○	-	○		
	67.5	60	148.5	○	-	○		

Timing		fH (kHz)	fV (Hz)	Dot clock (MHz)	HDMI	VGA	DisplayPort
4K2K	3840x2160	54	24	297	○	-	○
		56.25	25	297	○	-	○
		67.5	30	297	○	-	○
		112.5	50	594	○	-	○
		133.313	59.997	533.25	○	-	○
		135	60	594	○	-	○

Overall Dimensions

Figure 7-1 shows the display dimensions of **AVF-6550** (all dimensions are in inches).

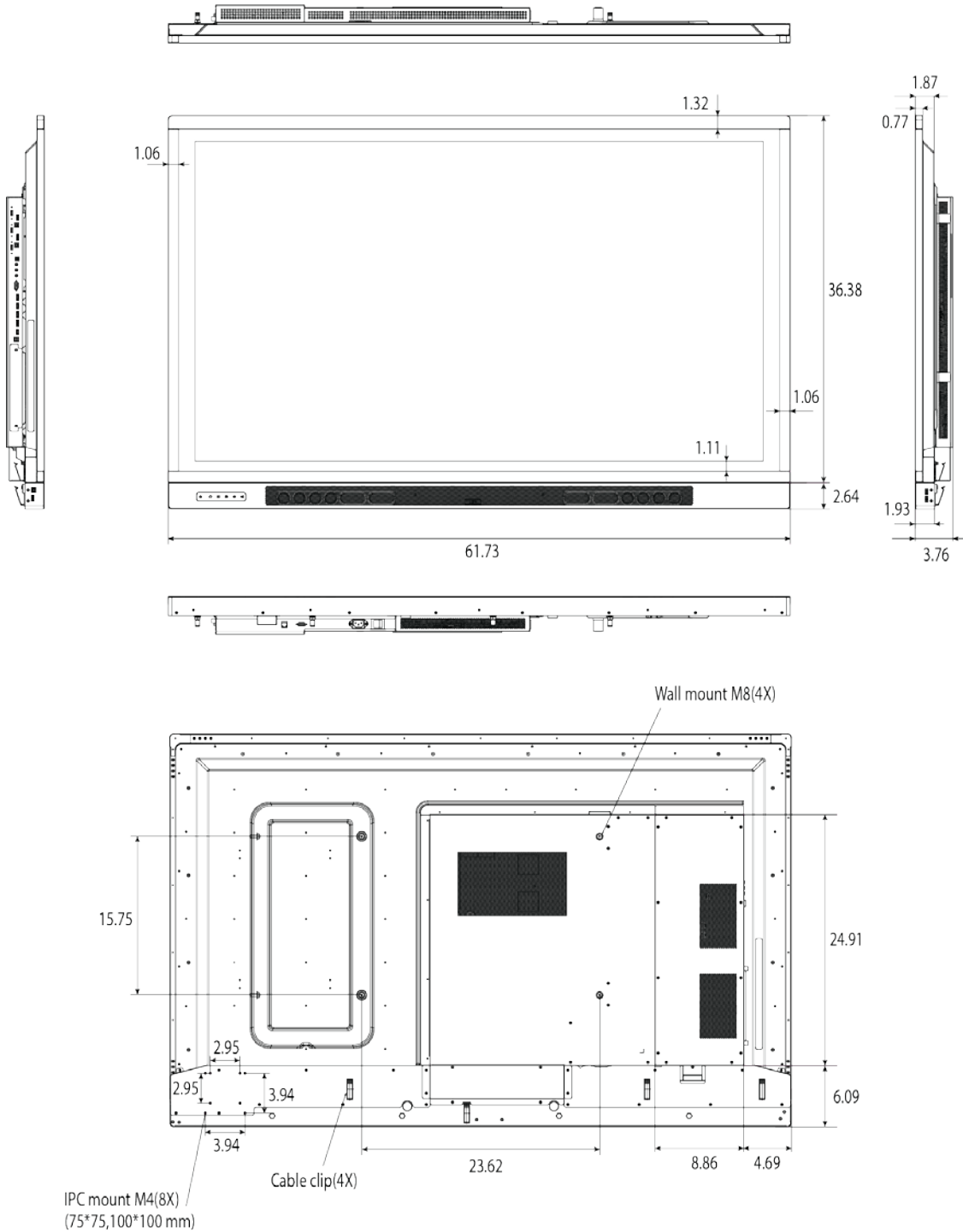

Figure 7-1. AVF-6550 Display Dimensions (inch)

Figure 7-2 shows the display dimensions of **AVF-6550** (all dimensions are in millimeters).

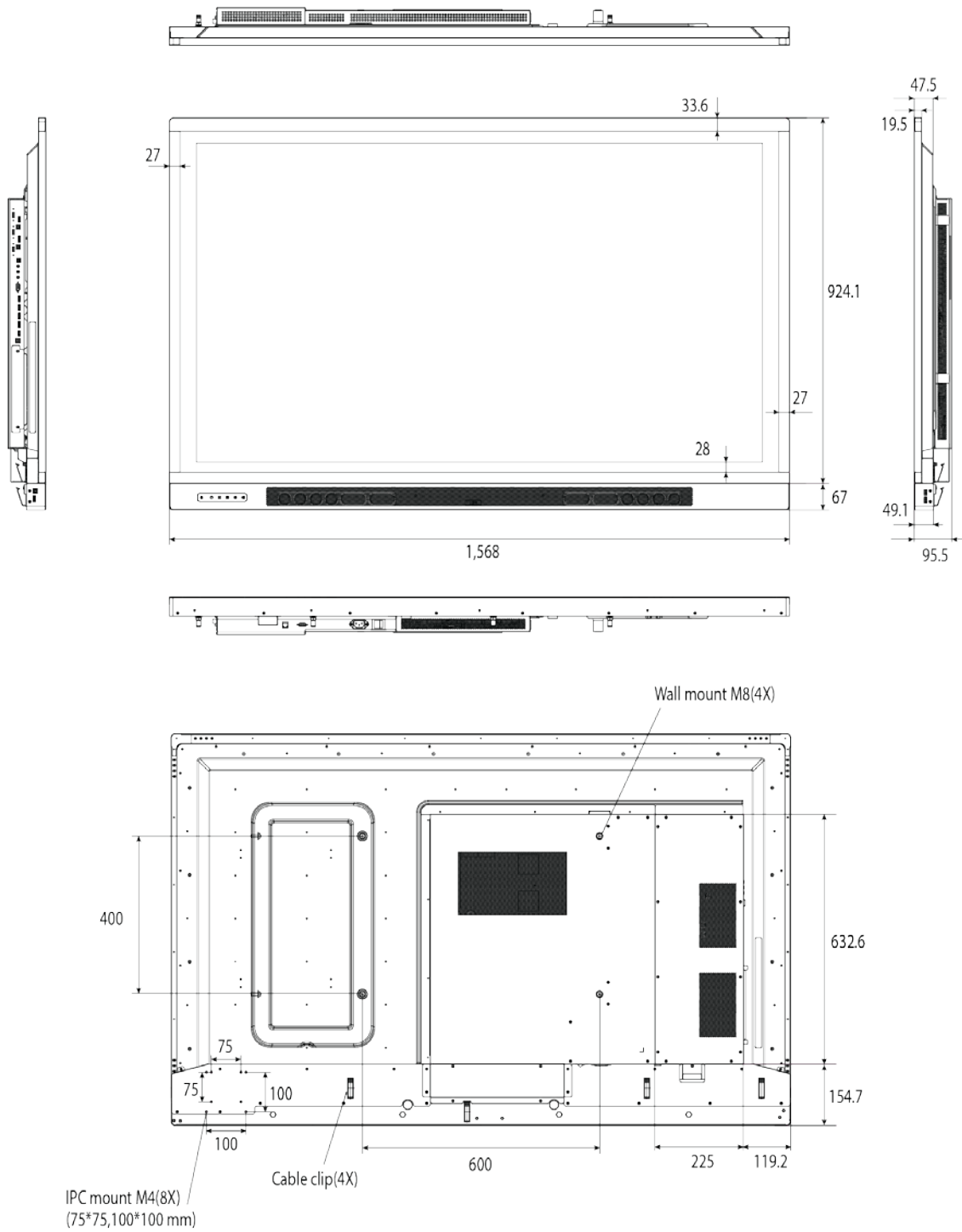

Figure 7-2. AVF-6550 Display Dimensions (mm)

Notes

Appendix I: Moving and Carrying Notice

Moving the Display

Moving the display requires at least two people. Attempting to move the display with one person may result in dropping the display and/or serious injury. When moving a display in its shipping carton, lift the carton using the white handles.

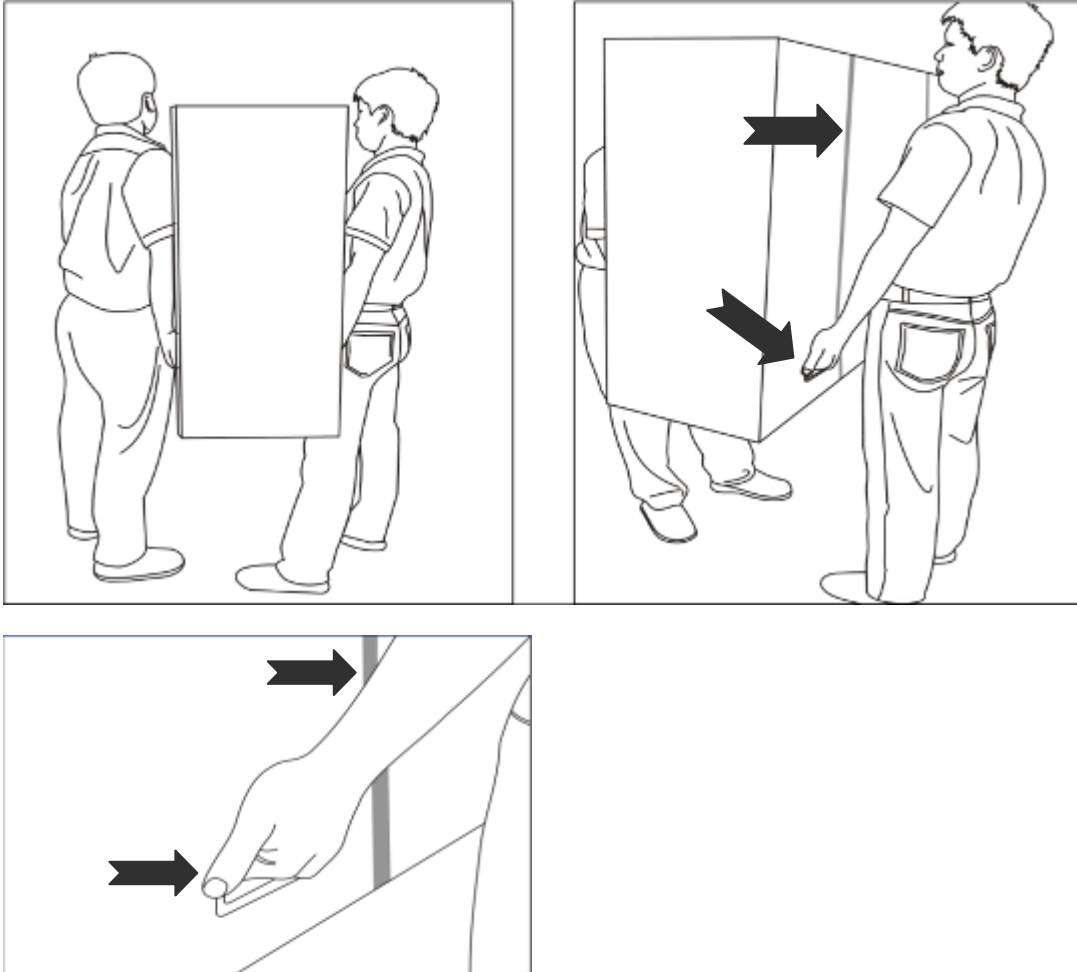

Carrying the Display

This display is heavy; please follow proper lifting technique, as pictured below. Failure to do so may cause injury.



Appendix II: Installing a Wall Mount

Follow the manual instructions for the type of mount you have selected. Refer all servicing to qualified service personnel.

Before installing, please make sure the wall is strong enough to hold the necessary weight of the display and the mount.

Step1. Keep the display facing the ground and place it on a flat object.

Step2. Remove the screws (M8*15) from the back of the display.

Step3. Align the wall brackets with the mounting holes and attach the brackets to the display using the screws removed in Step 2.

Caution: Longer screws will damage the display.

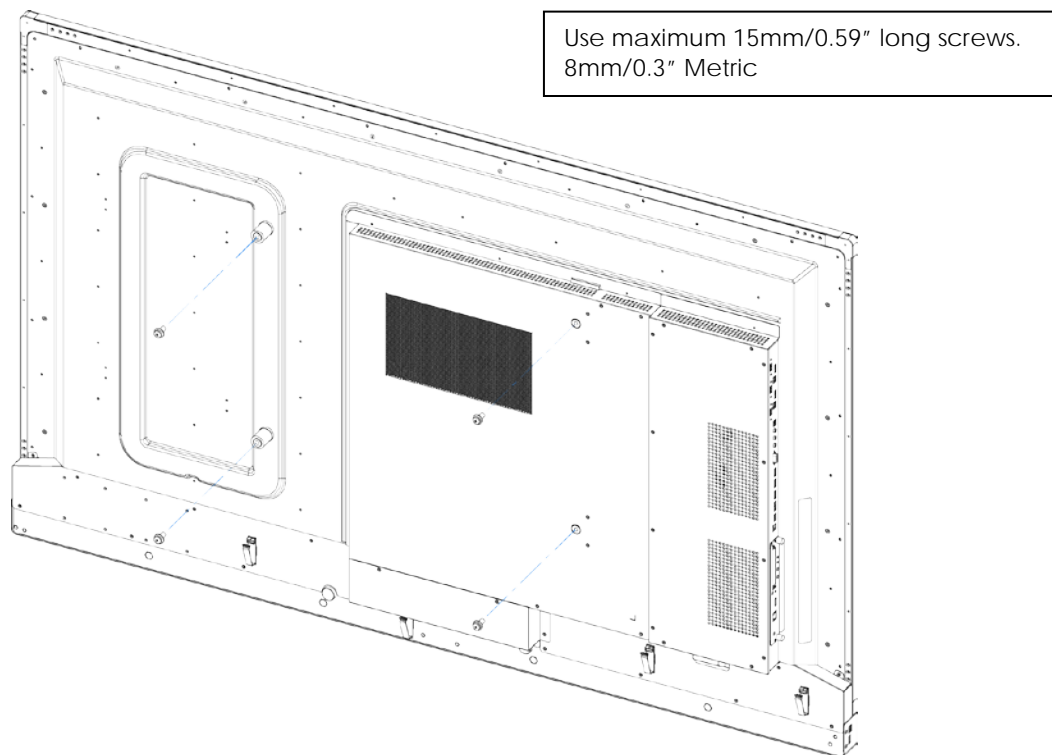

NOTE

To safely mount the display on a wall, Avocor recommends:

- Use only the approved wall-mount kit designed for the display.
- Make sure the tilt degree of the wall does not exceed 10 degrees.

Appendix III: Installing an OPS Module

Follow the steps below to install an OPS module.

- Step 1** Ensure that the display is turned off (power socket on rear of display).
- Step 2** Use a screw driver to unscrew the OPS slot cover on the display input panel. Do not lose the screws (M4*6) that are removed.
- Step 3** Install the OPS module by sliding it gently into the OPS slot until you hear a click, indicating the module is securely inserted. When using an Avocor OPS PC, the fan should be facing to the backside of the display. Do not apply by force.
- Step 4** Secure the OPS module in position, by screwing it onto the display input panel using the screws (M4*6) that were removed earlier.
- Step 5** Turn on the interactive display. When using an Avocor OPS PC a green light on the side of the OPS PC should appear, indicating that the OPS PC is switched on and operational.

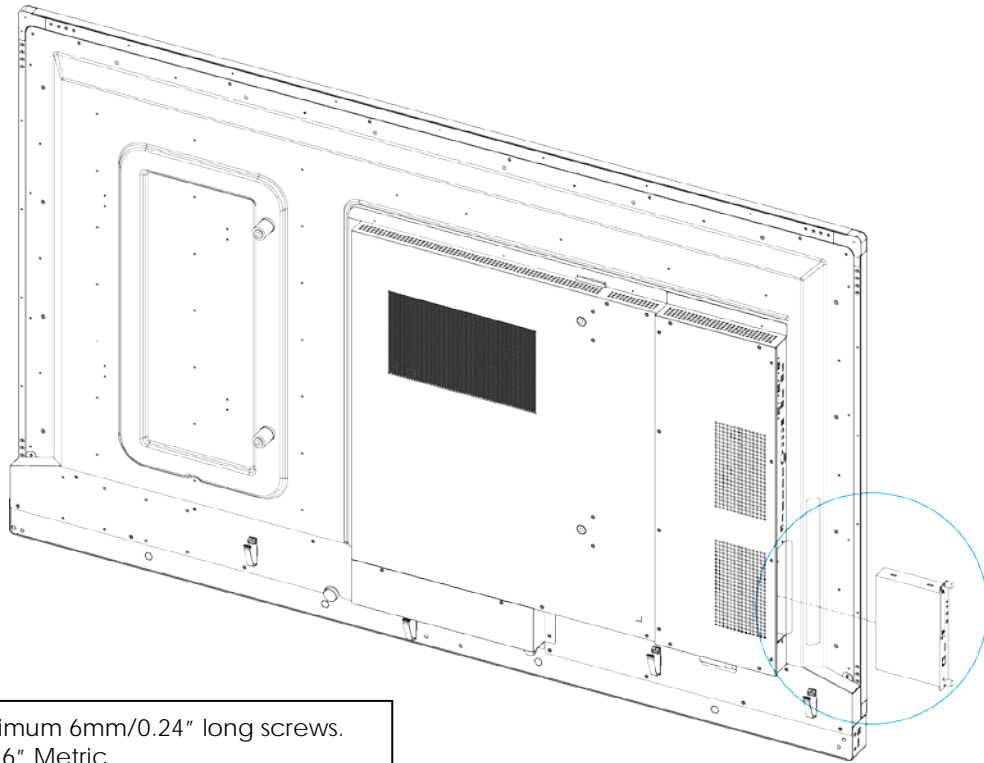

NOTE

- When installing or uninstalling an OPS PC, the display must be switched off. If the display is on when performing the installation or uninstallation of the OPS PC, this could cause damage to either the display or OPS PC invalidating the warranty for both.
- The right bottom handle can be unscrewed for OPS module installation. Please reinstall the handle after inserting the OPS module.

Appendix IV: Wall Mount Safety Notes

1. Please make sure if the bracket is fixed to the solid wall / solid pillar for fear of falling due to heavy weight.

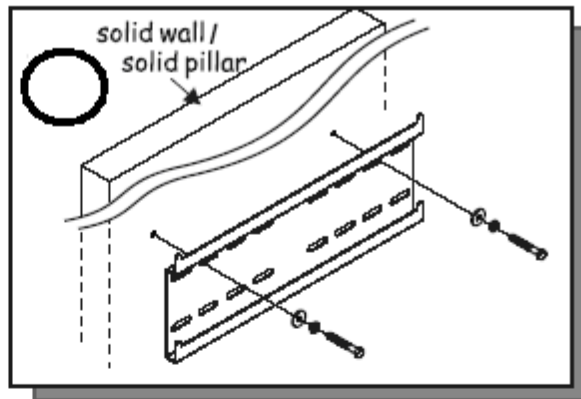
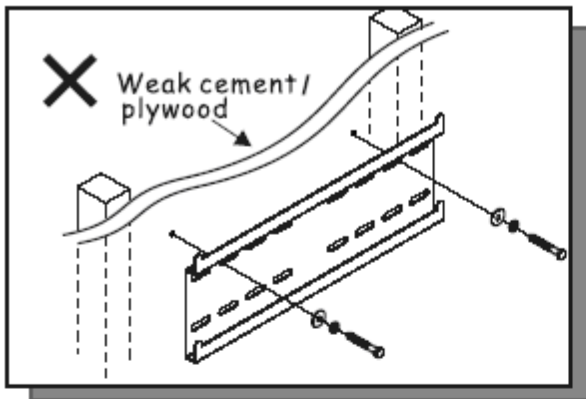

2. After assembling, please don't pull or shake violently.

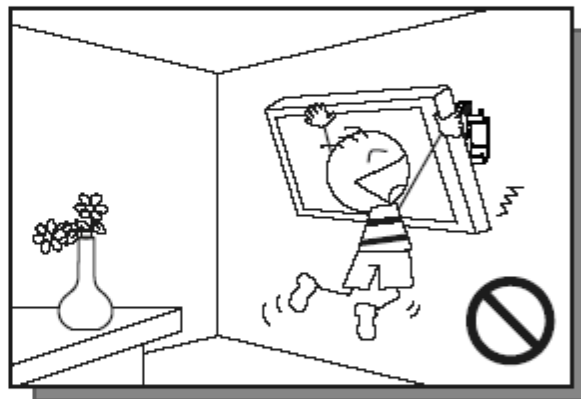
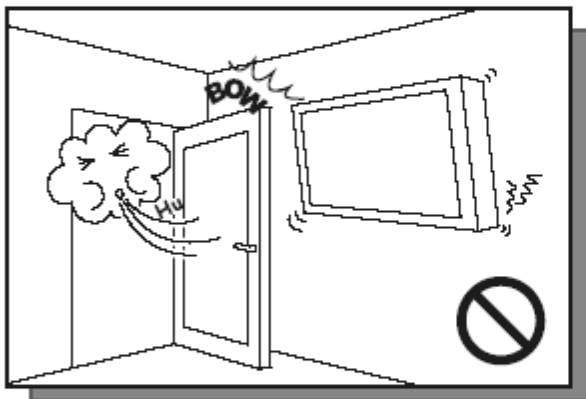

3. Please don't install the bracket directly under the sunshine or humidity / high temperature places for fear that the quality is effected.

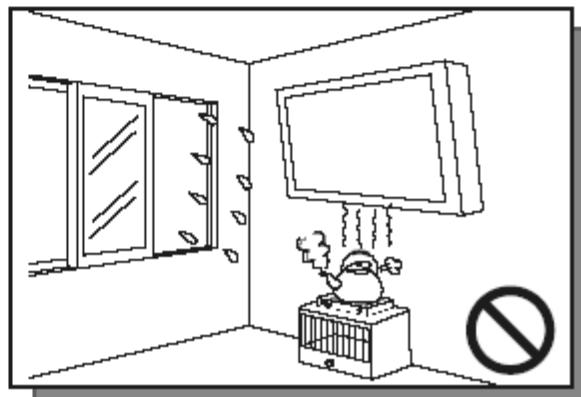
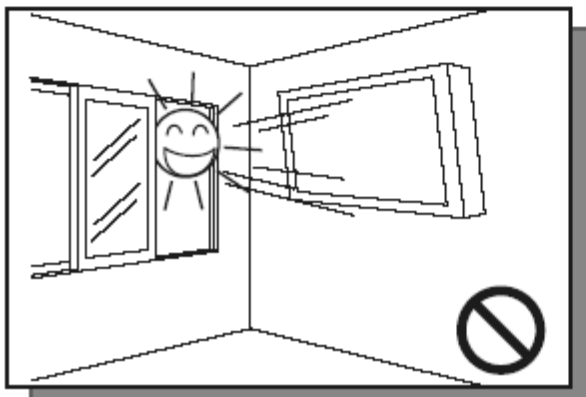

4.

Installing the bracket over 10 cm from each wall side and being vertical to the ground is the suggested installing position.

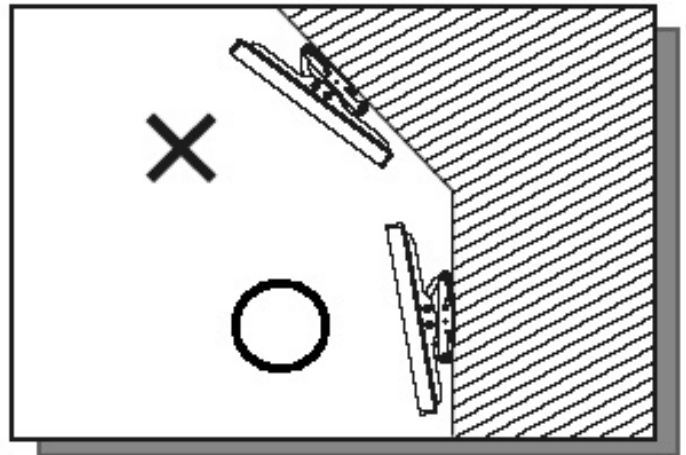
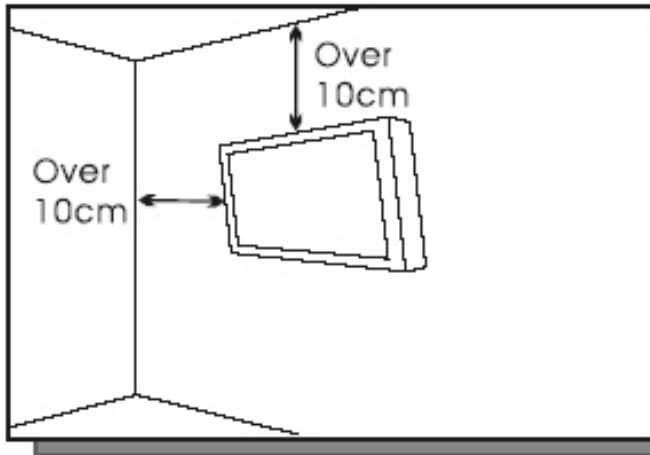

5.

Please make sure to hang on the mounting hooks firmly.

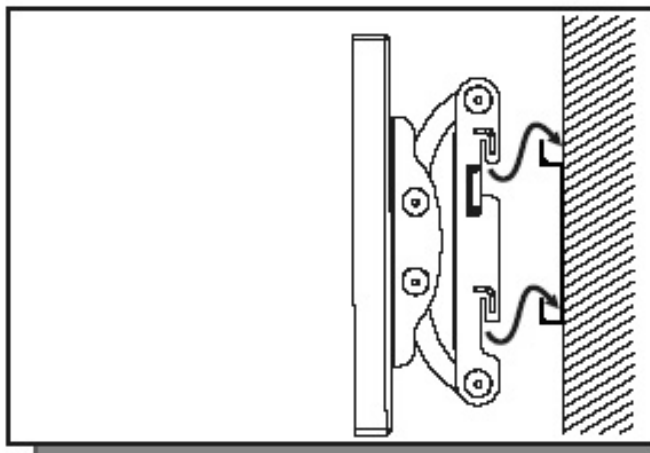

6.

The flat screen must be put in the mid of the bracket for fear of slope.

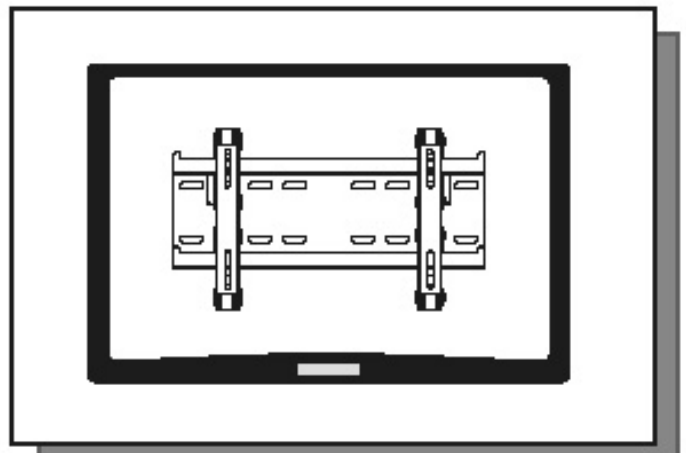

Appendix V: Ethernet Remote Control Settings

The device can be configured by opening a browser and connecting to web server directly.

Use the browser to configure the demo board. Connect the browser to the IP address of NET2UART module, and the Login window will pop up as follows.

USER LOG IN

Site:	10.200.6.78
ID:	<input style="width: 80%;" type="text"/>
Password:	<input style="width: 80%;" type="password"/>
<input type="button" value="OK"/>	

Default IP	192.168.2.1
Default ID	admin
Default Password	system

Configurations

Administrator

Authentication Configuration

Administrator

- [Authentication Configuration](#)
- [System IP Configuration](#)
- [Network Status](#)
- [Display Status](#)
- [Load default setting](#)
- [Firmware update](#)
- [Boot Loader upgrade](#)

TCP Mode

UDP Mode

UART

SMTP

Reset Device

Logout

Authentication Configuration

Setting	Value
Username	<input style="width: 80%;" type="text" value="admin"/> max:15
Password Confirm	<input style="width: 80%;" type="password" value="....."/> max:15 <input style="width: 80%;" type="password" value="....."/>
<input type="button" value="Update"/> Please refresh web page after press "updated" button.	

Note:
Comment name only can use "0-9", "a-z", "A-Z"

System IP Configuration

Administrator

[Authentication Configuration](#)

[System IP Configuration](#)

[Network Status](#)

[Display Status](#)

[Load default setting](#)

[Firmware update](#)

[Boot Loader upgrade](#)

[TCP Mode](#)

[UDP Mode](#)

[UART](#)

[SMTP](#)

[Reset Device](#)

[Logout](#)

System IP Configuration

Setting	Value
IP Address	<input type="text" value="192"/> . <input type="text" value="168"/> . <input type="text" value="2"/> . <input type="text" value="1"/>
Subnet Mask	<input type="text" value="255"/> . <input type="text" value="255"/> . <input type="text" value="255"/> . <input type="text" value="0"/>
Gateway	<input type="text" value="192"/> . <input type="text" value="168"/> . <input type="text" value="2"/> . <input type="text" value="1"/>
DNS	<input type="text" value="192"/> . <input type="text" value="168"/> . <input type="text" value="2"/> . <input type="text" value="1"/>
IP Configure	<input type="radio"/> Static <input checked="" type="radio"/> DHCP
VLAN Tag	<input checked="" type="radio"/> Disable <input type="radio"/> Enable : VLAN ID <input type="text" value="0"/>

Please refresh web page after press "updated" button.

Network Status

Administrator

[Authentication Configuration](#)

[System IP Configuration](#)

[Network Status](#)

[Display Status](#)

[Load default setting](#)

[Firmware update](#)

[Boot Loader upgrade](#)

[TCP Mode](#)

[UDP Mode](#)

[UART](#)

[SMTP](#)

[Reset Device](#)

[Logout](#)

Network Status

Kernel Version	V3021 (Feb 17 2014 14:42:18)
MAC Address	00:1F:B6:00:01:DB
Nickname	<input type="text" value="NetUART"/> <input type="button" value="Update"/> Please refresh web page after press "updated" button.

Note:

Comment name only can use "0-9","a-z","A-Z","_","-"

Load Default Setting

Administrator

[Authentication Configuration](#)

[System IP Configuration](#)

[Network Status](#)

[Display Status](#)

[Load default setting](#)

[Firmware update](#)

[Boot Loader upgrade](#)

[TCP Mode](#)

[UDP Mode](#)

[UART](#)

[SMTP](#)

[Reset Device](#)

[Logout](#)

Load Default Setting to EEPROM

Firmware Update

Administrator

- [Authentication Configuration](#)
- [System IP Configuration](#)
- [Network Status](#)
- [Display Status](#)
- [Load default setting](#)
- [Firmware update](#)
- [Boot Loader upgrade](#)

[TCP Mode](#)

[UDP Mode](#)

[UART](#)

[SMTP](#)

[Reset Device](#)

[Logout](#)

Firmware update

Load

Boot Loader Upgrade

Administrator

- [Authentication Configuration](#)
- [System IP Configuration](#)
- [Network Status](#)
- [Display Status](#)
- [Load default setting](#)
- [Firmware update](#)
- [Boot Loader upgrade](#)

[TCP Mode](#)

[UDP Mode](#)

[UART](#)

[SMTP](#)

[Reset Device](#)

[Logout](#)

Upgrade the Boot Loader

Load

TCP Mode

Administrator

[Authentication Configuration](#)

[System IP Configuration](#)

[Network Status](#)

[Display Status](#)

[Load default setting](#)

[Firmware update](#)

[Boot Loader upgrade](#)

[TCP Mode](#)

[UDP Mode](#)

[UART](#)

[SMTP](#)

[Reset Device](#)

[Logout](#)

TCP Control

Item	Value
Telnet Server/Client	<input checked="" type="radio"/> Server <input type="radio"/> Client <input type="radio"/> Disable
Data Port Number	<input type="text" value="23"/>
Remote Server IP Address	<input checked="" type="radio"/> IP <input type="text" value="210"/> . <input type="text" value="200"/> . <input type="text" value="181"/> . <input type="text" value="102"/> <input type="radio"/> Domain Name <input type="text" value="0"/>
Client mode inactive timeout	<input type="text" value="20"/> minute (1~99,0=Disable)
Server mode protect timeout	<input type="text" value="60"/> minute (1~98,0=Disable,99=Can't replace)
<input type="button" value="Update"/> Please refresh web page after press "updated" button.	

Telnet Server/Client

Set the device to be a Telnet Server or Client.

Port Number

When in Server mode, assign the port number used to connect remotely. When in Client mode, assign the port number for the device to connect to the remote site.

Remote Server IP Address

When in Client mode, the device will connect to the remote server with the IP address set here.

Client mode inactive timeout

When NET2UAR is operating in TCP client mode, it will always try to connect with the remote server. The time configured here is for NET2UART to rebuild connection after timeout.

Server mode protect timeout

When NET2UART is operating in TCP server mode, it would protect the TCP connection from getting replaced in the period of the time set here.

UDP Mode

Administrator

- [Authentication Configuration](#)
- [System IP Configuration](#)
- [Network Status](#)
- [Display Status](#)
- [Load default setting](#)
- [Firmware update](#)
- [Boot Loader upgrade](#)

TCP Mode

UDP Mode

UART

SMTP

Reset Device

Logout

UDP

Item	Value	
Mode	<input type="radio"/> Listen <input type="radio"/> Normal <input checked="" type="radio"/> Disable	
Local Port	21	
Remote Address	IP	Port
	<input checked="" type="radio"/> 0 . 0 . 0 . 0 IP <input type="radio"/> Domain Name	0
	<input checked="" type="radio"/> 0 . 0 . 0 . 0 IP <input type="radio"/> Domain Name	0
	<input checked="" type="radio"/> 0 . 0 . 0 . 0 IP <input type="radio"/> Domain Name	0
	<input checked="" type="radio"/> 0 . 0 . 0 . 0 IP <input type="radio"/> Domain Name	0
	<input checked="" type="radio"/> 0 . 0 . 0 . 0 IP <input type="radio"/> Domain Name	0
	<input checked="" type="radio"/> 0 . 0 . 0 . 0 IP <input type="radio"/> Domain Name	0
	<input checked="" type="radio"/> 0 . 0 . 0 . 0 IP <input type="radio"/> Domain Name	0
	<input checked="" type="radio"/> 0 . 0 . 0 . 0 IP <input type="radio"/> Domain Name	0
	<input checked="" type="radio"/> 0 . 0 . 0 . 0 IP <input type="radio"/> Domain Name	0
<input type="button" value="Update"/>		
Please refresh web page after press "updated" button.		

Status

When TCP mode is set as Server mode or Client mode, the UDP mode would be disabled automatically, and vice versa.

Local Port

Assign the port number here to allow the device to open for the remote site to send data via UDP. The IP address of the remote site must be set in the Remote Address table, or NET2UART will ignore its data.

Remote Address

The Remote Address table allows 10 entries of remote site IP addresses and ports. When NET2UART is sending data to network, the data will be sent to the each remote IP address entered in the table simultaneously. The port number is the remote site port number that NET2UART will send data to via UDP.

If the port number is set as "0", the NET2UART will use the port number that the remote site sends data from as the destination port number, or use the local port number as the destination port number if the remote site has not sent data to NET2UART.

UART

Administrator

[Authentication](#)

[Configuration](#)

[System IP](#)

[Configuration](#)

[Network Status](#)

[Display Status](#)

[Load default setting](#)

[Firmware update](#)

[Boot Loader upgrade](#)

TCP Mode

UDP Mode

UART

SMTP

Reset Device

Logout

UART Control

Item	Setting
Mode	RS232
Baudrate	115200
Character Bits	8
Parity Type	none
Stop Bit	1
Hardware Flow Control	none
Uart Memory Overflow count	0M,0K,0Byte
Uart FIFO Overflow count	0times
Delimiter	<input type="checkbox"/> Character 1: 00, <input type="checkbox"/> Character 2: FF <input type="checkbox"/> Silent time: 5 (1~255)*200ms <input type="checkbox"/> Drop Character
<input type="button" value="Update"/> Please refresh web page after press "updated" button.	

Mode

Select the UART interface.

Baud rate

Select the baud rate of UART interface.

Character Bits

Select the number of character bits of UART interface.

Parity Type

Select the parity type of UART interface.

Stop Bit

Select the stop bit type of UART interface.

Hardware Flow Control

Select the flow control type of UART interface. The hardware flow control will use CTS/RTS for the control signals.

Uart Memory Overflow count

Shows the number of overflow bytes in network buffer.

Uart FIFO Overflow count

Shows the number of overflow times in UART RX buffer.

Delimiter

- Character 1 & 2:

Set Character 1 and/or Character 2 to be the delimiter.

Once the delimiter is active, NET2UART would monitor all data received from UART. All data received from UART will be stored in NET2UART internal buffer first, and will only be sent to Ethernet once the delimiter is detected. If the delimiters have not been detected and the internal buffer of NET2UART is stuffed, the incoming data will overwrite the previous data stored in NET2UART.

- Drop Character:

The Drop Character is set to drop delimiter or not. If Drop Character is active, the delimiter received from UART will not be sent out to Ethernet.

- Silent time:

Once the Silent time is active, NET2UART will keep all data received from UART in its internal buffer and check the time period of no data received from UART. It will then send out the internal data once the time is out.

SMTP

Administrator

[Authentication](#)

[Configuration](#)

[System IP](#)

[Configuration](#)

[Network Status](#)

[Display Status](#)

[Load default setting](#)

[Firmware update](#)

[Boot Loader upgrade](#)

[TCP Mode](#)

[UDP Mode](#)

[UART](#)

[SMTP](#)

[Reset Device](#)

[Logout](#)

SMTP setup

Enable SMTP	<input type="checkbox"/> Enable, Port: 25
SMTP server address	smtp.xxx.yyy
SMTP Login Information	<input type="checkbox"/> Enable Username: username, Password: ●●●●●●
Mail to	xxx@yyy.zzz max: 200
Mail from	xxx@yyy.zzz
SMTP 01 Warning	
Subject	Power Status Change Alert
Message Body	SMTP 01 body max: 100
SMTP 02 Warning	
Subject	Source Change Alert
Message Body	SMTP 02 body max: 100
SMTP 03 Warning	
Subject	Signal Lost Alert
Message Body	SMTP 03 body max: 100

Reset Device

Reset NET2UART module.

Administrator

TCP Mode

UDP Mode

UART

SMTP

Reset Device

Logout

Reset Device

Reset