

VC520 Pro2

User Manual



Federal Communications Commission Statement



NOTE: This equipment has been tested and found to comply with the limits for a Class A digital device, pursuant to part 15 of the FCC Rules. These limits are designed to provide reasonable protection against harmful interference when the equipment is operated in a commercial environment. This equipment generates, uses, and can radiate radiofrequency energy and, if not installed and used in accordance with the instruction manual, may cause harmful interference to radio communications. Operation of this equipment in a residential area is likely to cause harmful interference in which case the user will be required to correct the interference at his own expense.

FCC Caution: Any changes or modifications not expressly approved by the party responsible for compliance could void the user's authority to operate this equipment.

This device complies with part 15 of the FCC Rules.

Operation is subject to the following two conditions:

- (1) This device may not cause harmful interference, and
- (2) this device must accept any interference received, including interference that may cause undesired operation.

Warning:

This is a class A product. In a domestic environment this product may cause radio interference in which case the user may be required to take adequate measures.

DISCLAIMER

No warranty or representation, either expressed or implied, is made with respect to the contents of this documentation, its quality, performance, merchantability, or fitness for a particular purpose. Information presented in this documentation has been carefully checked for reliability; however, no responsibility is assumed for inaccuracies. The information contained in this documentation is subject to change without notice.

In no event will AVer Information Inc. be liable for direct, indirect, special, incidental, or consequential damages arising out of the use or inability to use this product or documentation, even if advised of the possibility of such damages.

TRADEMARKS

"AVer" is a trademark owned by AVer Information Inc. Other trademarks used herein for description purpose only belong to each of their companies.

COPYRIGHT

©2021 AVer Information Inc. All rights reserved.

All rights of this object belong to AVer Information Inc. Reproduced or transmitted in any form or by any means without the prior written permission of AVer Information Inc. is prohibited. All information or specifications are subject to change without prior notice.

NOTICE

- SPECIFICATIONS ARE SUBJECT TO CHANGE WITHOUT PRIOR NOTICE. THE INFORMATION CONTAINED HEREIN IS TO BE CONSIDERED FOR REFERENCE ONLY.
- THE CONTENTS ARE SUBJECT TO CHANGE WITHOUT PRIOR NOTICE. IF THE CONTENT IS WRONG, PLEASE INFORM US TO MAKE CORRECTIONS.

WARNING

- To reduce risk of fire or electric shock, do not expose this appliance to rain or moisture. Warranty will be void if any unauthorized modifications are done to the product.
- Do not drop the camera or subject it to physical shock.
- Use correct power supply voltage to avoid damaging camera.
- Do not place the camera where the cord can be stepped on as this may result in fraying or damage to the lead or the plug.
- Hold the bottom of the camera with both hands to move the camera. Do not grab the lens or lens holder to move the camera.

Remote Control Battery Safety Information

- Store batteries in a cool and dry place.
- Do not throw away used batteries in the trash. Properly dispose of used batteries through specially approved disposal methods.
- Remove the batteries if they are not in use for long periods of time. Battery leakage and corrosion can damage the remote control. Dispose of batteries safely and through approved disposal methods.
- Do not use old batteries with new batteries.
- Do not mix and use different types of batteries: alkaline, standard (carbon-zinc) or rechargeable (nickel-cadmium).
- Do not dispose of batteries in a fire.
- Do not attempt to short-circuit the battery terminals.

CAUTION

- Risk of explosion if battery is replaced by an incorrect type.
- Dispose of used batteries in a safe and proper manner.

MORE HELP

For FAQs, technical support, software and user manual download, please visit:

Global: <https://www.aver.com/HelpCenter/conferencing-collaboration>

USA: <https://www.averusa.com/business/support/>

European Headquarters: <https://www.aver.com/download-center/>

Technical Support:

Global: <https://aver.com/technical-support>

USA: <https://averusa.force.com/support/s/contactsupport>

European Headquarters: <https://www.avereurope.com/technical-support/>

Contact Information

Global

AVer Information Inc.

<https://www.aver.com>

8F, No.157, Da-An Rd.,

Tucheng Dist.,

New Taipei City 23673,

Taiwan

Tel: +886 (2) 2269 8535

USA

AVer Information Inc.

<https://www.averusa.com>

668 Mission Ct.,

Fremont, CA 94539

Tel: +1 (408) 263 3828

Toll-free: +1 (877) 528 7824

Technical support:

support.usa@aver.com

European Headquarters

AVer Information Europe B.V.

<https://www.avereurope.com>

Westblaak 140, 3012KM,

Rotterdam, Netherlands

Tel: +31 (0) 10 7600 550

Technical support:

eu.rma@aver.com

Contents



Package Contents.....	1
Optional Accessory.....	1
Product Introduction.....	2
Overview	2
Expansion Speakerphone/Microphone Connection	3
Phone In Connection.....	4
Pan and Tilt Angle	4
Audio Signal Receive Range	5
Speakerphone LED Indicator	6
Remote Control	7
Installation.....	10
Device Connection	10
RS232 Connection	12
Wall Mount Installation	18
Operating the Camera	21
Make a Video Call	21
Make a Connection through the Browser	21
Web Settings	24

First Time Login.....	24
Set Up the Preset.....	26
Select the Preset Position.....	27
Camera Settings.....	27
Tracking Mode.....	28
Framing Speed.....	30
Smart Frame Preset Point.....	31
Auto Focus.....	32
Home Position.....	32
Sleep Position.....	33
Sleep Timer.....	33
On Screen Menu.....	34
Camera Binding.....	34
Save Preset.....	35
Image Settings.....	36
Image Flip.....	36
Image Mirror.....	36
True WDR.....	37
Frequency.....	37

White Balance	38
Noise Reduction	38
Brightness.....	39
Sharpness	39
Saturation	40
Low Light Compensation	40
RS232 Setting	41
Video Format Settings.....	42
H.264 Profile.....	42
IP Stream Resolution.....	43
Frame Rate.....	44
Bit Rate.....	44
RTSP	45
RTMP.....	47
Network Settings	48
DHCP.....	48
Static IP.....	49
System Settings	50
Language.....	50

Firmware Update	51
Factory Default	52
Camera Reboot	53
Change Password	54
SSL Certificate.....	55
Date Format.....	56
Time Format	56
Time Correction Mode	57
Audio Settings	60
Noise Suppression	60
Automatically Gain Control.....	61
Echo Cancellation.....	61
Keyboard Noise Suppression	62
Phone In Jack.....	63
PTZApp 2.....	64
Install PTZApp 2.....	64
Use PTZApp 2 with USB Devices	64
Install EZLive.....	73
Use EZLive.....	73

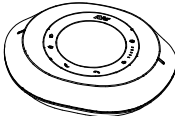
Package Contents

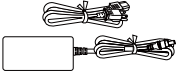
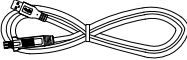
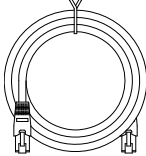
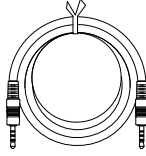
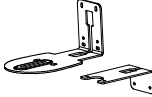
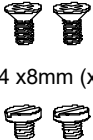
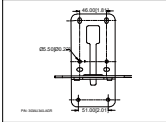
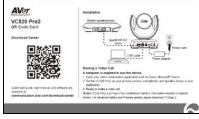
Camera Unit	Speakerphone Unit	Remote Control	Power Adapter & Power Cord*	
				
USB 2.0 Type-B to Type-A Cable (5m)	Speakerphone Cable (10m)	3.5 mm Audio Cable (0.9m)	L-Mount Brackets	Screws for Mount
				 M4 x8mm (x2) 1/4"-20 L=7.5mm (x2)
Drilling Paper	QR Code Card			
				

*The power cord will vary depending on the standard power outlet of the country where it is sold

Optional Accessory

Mini DIN9 to Mini DIN8 RS232 Adapter Cable

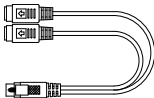

Product Introduction

Overview

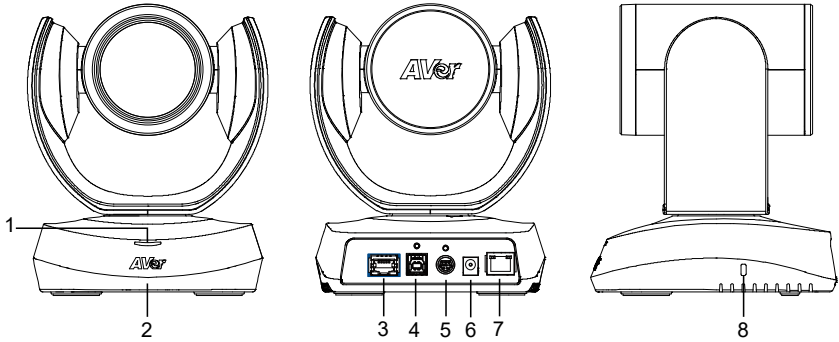

- | | | | |
|---|---|---|--------------------|
| 1 | Status LED
Power on: Blue light
Standby: Orange light | 4 | USB3.1 Type B Port |
| 2 | IR Sensor | 5 | RS232 In/Out Port |
| 3 | Speakerphone Port (Blue cable) | 6 | DC 12V Power Jack |
| | | 7 | Ethernet Port |
| | | 8 | Kensington Lock |

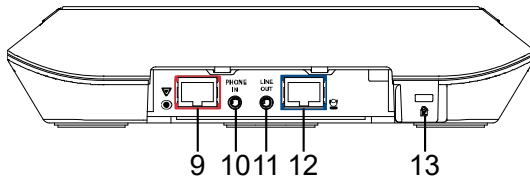

- | | | | |
|---|---|----|--------------------------|
| 9 | Speakerphone Port
(Red Cable, for extended
speakerphone and
microphone connection) | 10 | Phone In Port |
| | | 11 | Line Out Port |
| | | 12 | Camera Port (Blue Cable) |
| | | 13 | Kensington Lock |

Expansion Speakerphone/Microphone Connection

There are 2 types of expansion solutions that can be extended from the VC520 Pro2 speakerphone. Please purchase the expansion speakerphone and/or microphone directly from AVer or an AVer reseller.

Expansion Speakerphone Requirements:

- **VC520 Pro2 Firmware version:** 7200.00 or later
- **FONE540 Firmware version:** 7000.44 or later

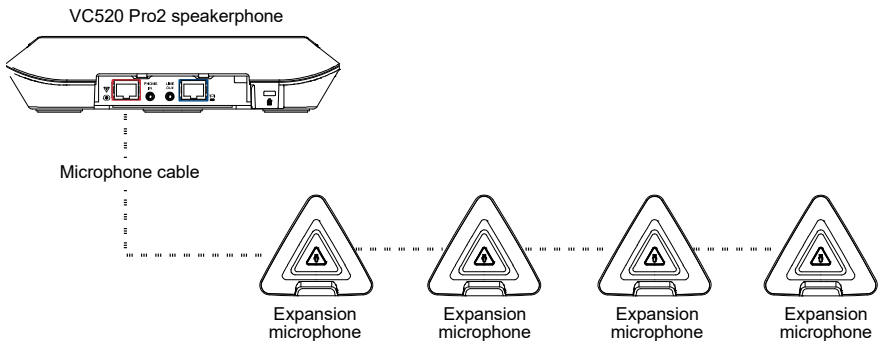
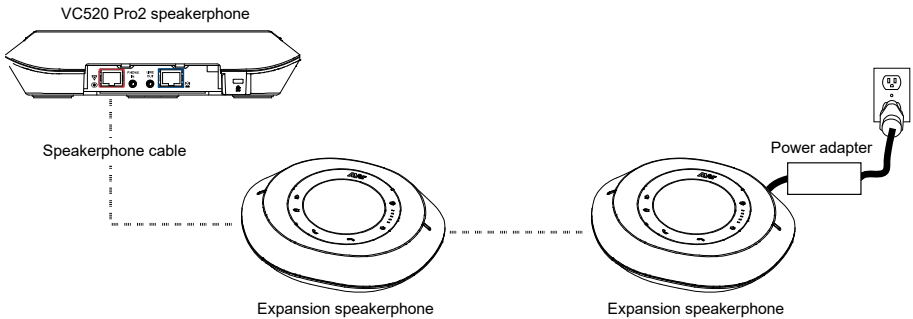

[Note]

- The VC520 Pro2 can support up to two expansion speakerphones, however, the daisy-chain expansion cable cannot exceed over 40m in total.
- Please connect the power supply for the expansion speakerphone when daisy-chaining over 20m.
- Please connect the power supply when upgrading the firmware for the expansion speakerphone.
- The expansion speakerphone cannot be used as the main speakerphone; it can only be used with the VC520 Pro2.
- The speakerphone/microphone cables will be included in the package contents when the user purchases the expansion speakerphone/microphone.



[Note] The VC520 Pro2 can support up to four expansion microphones, however, the daisy-chain expansion cable cannot exceed over 40m in total.

Phone In Connection

Users can connect a mobile phone to the Phone in port on the speakerphone as a hands-free speaker. When the device connects with the speakerphone, the  icon will light up in blue. Touching the  icon will temporarily disconnect the connection of the device with the speakerphone; touching the  icon again will resume the connection.

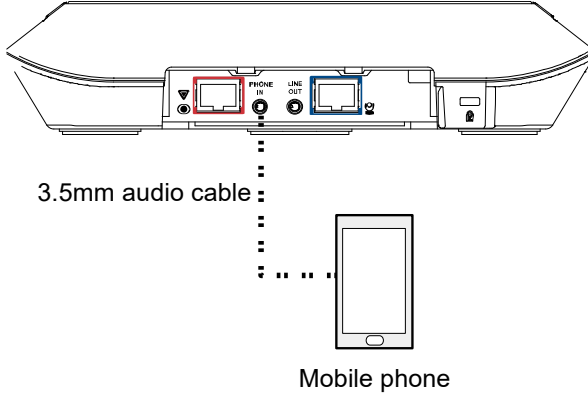

Pan and Tilt Angle

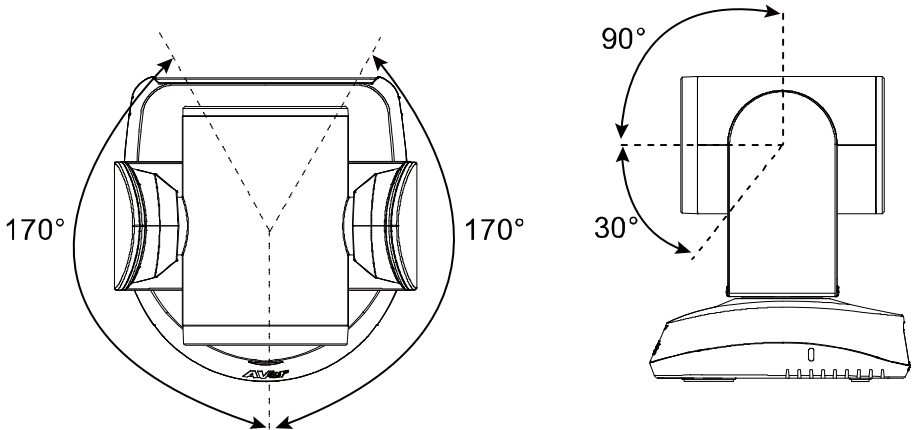

Audio Signal Receive Range

The best distance for the speakerphone to receive audio signal is within 7.5ft (2.3m) in radius. When connecting two or more speakerphones, the distance between the speakerphones must be 9ft (2.7m).

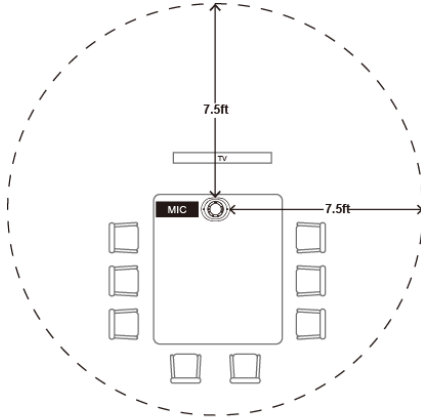



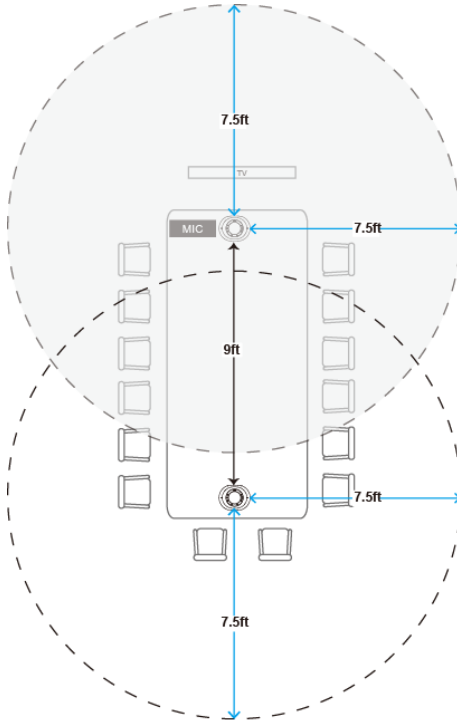

One speakerphone



Two speakerphones

Speakerphone LED Indicator

Button	LED Indicator	Status
	White light	Adjust the volume up and down. When adjusting the volume up and down, the volume LED indicator will light up in blue.
	White/Blue light	Touch to mute/un-mute the speakerphone volume. In mute status, the LED indicator will light up in red.
	Red light	Touch to hang up the call.
	Green light	Touch to answer the incoming call.
	<ul style="list-style-type: none">■ Blue light: Connects with external device■ White light: Temporarily disconnects the connection with the device■ Off: No connection with external devices	When the Phone in port connects with the device, the LED indicator will light up in blue.

Remote Control

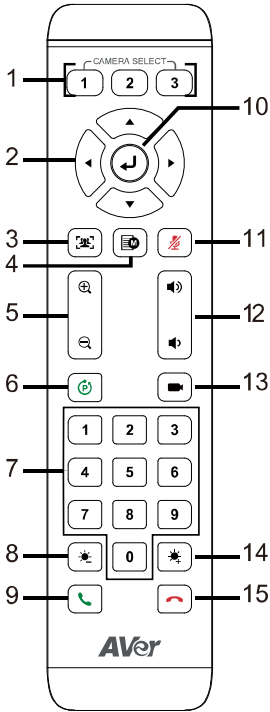

Name	Function
<p>1. Camera Select</p>	<p>One remote can control up to 3 AVer VC/CAM/VB series cameras. You can use AVer PTZApp 2 to set numbers associated with each camera, and then select which camera you would like to control using the remote.</p> <p>[Note] If you only have one camera and don't need to do custom setting, the default is camera 1. If you press camera 2 or 3 on the remote control, you will find your remote can't control your camera. In this case, please press camera 1 on your remote again.</p>
<p>2. Camera Directional Control</p>	<p>Use the directional buttons on the remote to control the direction of the camera. Press the directional button to move the camera or press and hold to continuously pan or tilt.</p>
<p>3. SmartFrame</p>	<p>One-click automatic FOV adjustment to fit all participants.</p> <p>Press for 1 second to switch the SmartFrame function among Manual Framing/Auto Framing/Preset Framing modes. A message (as figures shown) will display on the screen to indicate the mode.</p> <div style="display: flex; justify-content: space-around; margin: 10px 0;"> <div style="background-color: #333; color: white; padding: 2px 5px; border: 1px solid #ccc;">Manual Framing</div> <div style="background-color: #333; color: white; padding: 2px 5px; border: 1px solid #ccc;">Auto Framing</div> <div style="background-color: #333; color: white; padding: 2px 5px; border: 1px solid #ccc;">Preset Framing</div> </div> <p>[Notes]</p> <ul style="list-style-type: none"> ■ SmartFrame deploys face and body defection technology. People wearing masks or in side facial profiles still can be detected. The maximum detection distance is 7~10 meters. ■ Camera will track people while moving. It will start to focus and

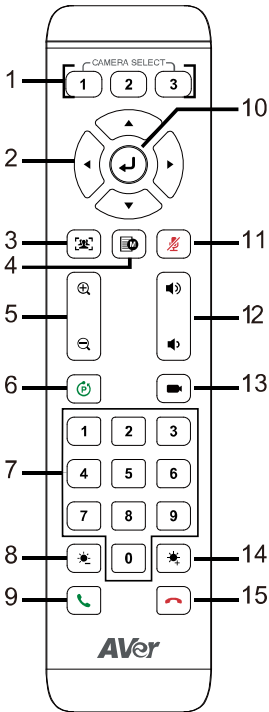

-
- zoom in when people don't move anymore for 1~5 seconds, depending on the framing speed you choose.
- Preset Framing: Set up preset points in advance (Only for Preset points 1~9. Preset 0 is for home position). Camera tracks one presenter and shoots the preset areas instead of focusing and zooming into presenter.
-
- | | |
|-----------------------------------|--|
| 4. OSD Menu | To call out OSD menu. Not support for VC520 Pro2 |
| <hr/> | |
| 5. Zoom In/Zoom Out | Increase/Decrease the camera zoom. |
| <hr/> | |
| 6. Preset | <p>The Preset button on the remote serves 2 functions.</p> <p>To Save a Preset – Move camera to desired position. Press and hold the preset button until you receive the save message on the screen. Select preset position button 0-9 to store the current camera position. Repeat steps if needed.</p> <p>To Load a Preset - Press the preset button and preset position button 0-9 to load a saved camera position. Repeat steps if needed.</p> |
| <hr/> | |
| 7. Preset Position/Number Buttons | <p>Preset position buttons are used in conjunction with the Preset button to save positions. There are a total of 10 presets.</p> <p>Press the preset button first and then press 0~9 for the camera to move to the saved position.</p> <p>[Notes]</p> <ul style="list-style-type: none"> ■ Press and hold the number button “1” for 1 second to turn on or off the WDR function. ■ Press and hold the number button |

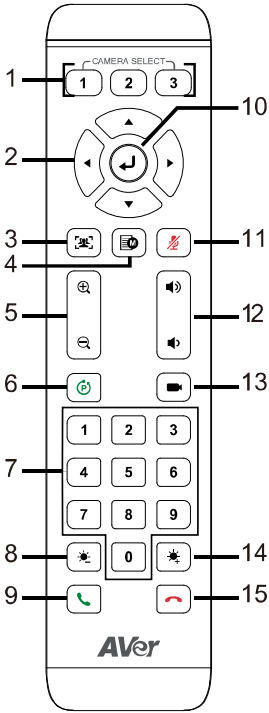

- 8. Brightness - Decrease the brightness.
- 9. Call/answer Answer a call or start a call.
- 10. Enter To confirm selection. Not support for VC520 Pro2
- 11. Mute/Un-mute Speakerphone Mute/Un-mute the speakerphone.
- 12. Volume Up/Down Adjust volume up or down.
- 13. Preset Hot Key Press to move the camera to the preset position the user has set.
- 14. Brightness + Increase the brightness.
- 15. Hang Up End the call.

“ 5 ” for 1 second to turn on or off the SmartFrame function.

- Press and hold the number button “ 8 ” for 1 second to enable or disable RTMP streaming function.
- Press and hold the number button “ 9 ” for 1 second to force camera to enter sleep mode. It will cut all the video streaming off. To wake it up, press the button for 1 second again or press direction button. It's not workable while USB streaming is on.

Installation

Device Connection

1. Connect the camera to power outlet.

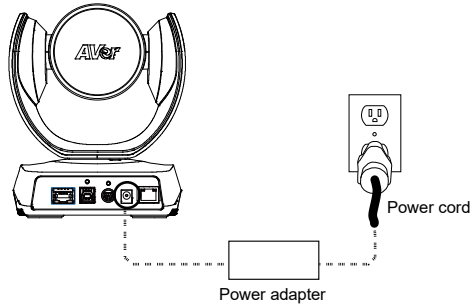

2. Connect the camera to the speakerphone using the included compatible cable.

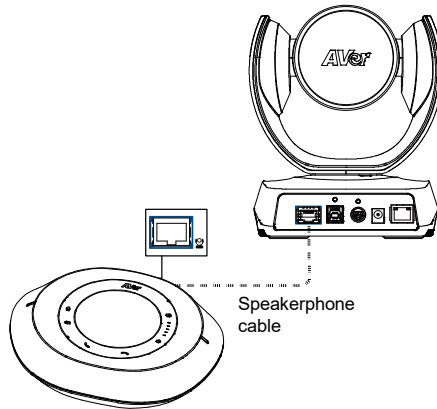

[Notes]

- The speakerphone port of the camera and the camera port of the speakerphone are both marked in blue.
- When connecting to the speakerphone, please remove the back port cover of the speakerphone for successful cable connection. To remove the back port cover, simply pull off from the speakerphone unit.

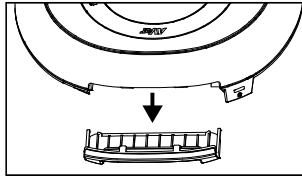

3. Connect other necessary cables.

[Notes]

- Secure the USB and RS232 cables with attached screws. RS232 cable is an optional accessory; please purchase from AVer.
- Make sure the cable is well connected to the connector on the camera before securing the cable.

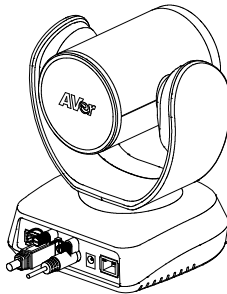

4. Connect the camera to the computer/laptop. Connect the camera to the speakerphone using the included

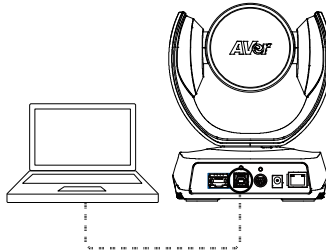

[Notes]

- Use the USB 2.0 cable included in the package.
- VC520 Pro2 has the USB 3.1 port which is USB 2.0 compatible.

Maximum resolution/fps for USB 2.0 and USB 3.1 ports are shown below.

	M-JPEG/fps	NV12/fps	YUV/fps
USB 2.0	1080@60 fps	720p@10 fps 480p@30 fps	720p@10 fps 480p@30 fps
USB 3.1	1080p@60 fps	1080p@30 fps	1080p@30 fps

RS232 Connection

■ Camera RS232 Port Pin Definition

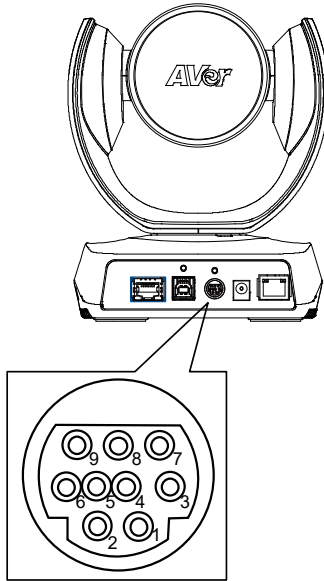

Function	Mini DIN9 PIN #	I/O Type	Signal	Description
VISCA IN	1	Output	DTR	Data Terminal Ready
	2	Input	DSR	Data Set Ready
	3	Output	TXD	Transmit Data
	6	Input	RXD	Receiver Data
VISCA OUT	7	Output	DTR	Data Terminal Ready
	4	Input	DSR	Data Set Ready
	8	Output	TXD	Transmit Data
	9	Input	RXD	Receiver Data
	5	---	---	---

■

■ Computer/Keyboard Controller and Camera Connection

Direct Connection

If users don't buy AVer RS232 adaptor cable, please refer to the pin connection shown below.

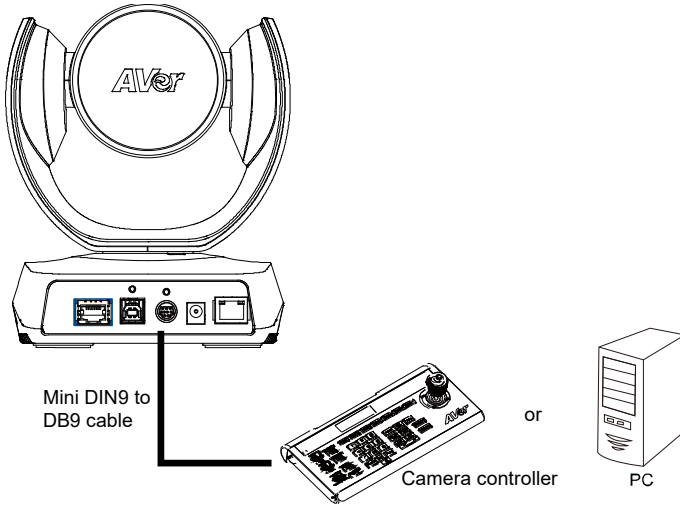

Camera (Mini DIN9)	Camera controller or PC (DB9)
1. DTR (IN)	1. DCD
2. DSR (IN)	2. RXD
3. TXD (IN)	3. TXD
6. RXD (IN)	4. DTR
7. DTR (OUT)	5. GND
4. DSR (OUT)	6. DSR
8. TXD (OUT)	7. RTS
9. RXD (OUT)	8. CTX
	9. RI

Red arrows indicate the following connections: Camera 2 (DSR IN) to PC 2 (RXD), Camera 3 (TXD IN) to PC 3 (TXD), Camera 6 (RXD IN) to PC 4 (DTR), Camera 7 (DTR OUT) to PC 6 (DSR), and Camera 9 (RXD OUT) to PC 8 (CTX).

Use the RS232 mini DIN9 to mini DIN8 cable (Sold separately. Please purchase from AVer.).

Users can purchase AVer RS232 min DIN9 to mini DIN8 adaptor cable* to connect with Computer or keyboard/controller.

* RS232 mini DIN9 to mini DIN8 cable (PN: 064AOTHERCDC)

** Mini DIN8 to D-Sub9 (DB9) cable (PN: 064AOTHERBPK) is an optional item.

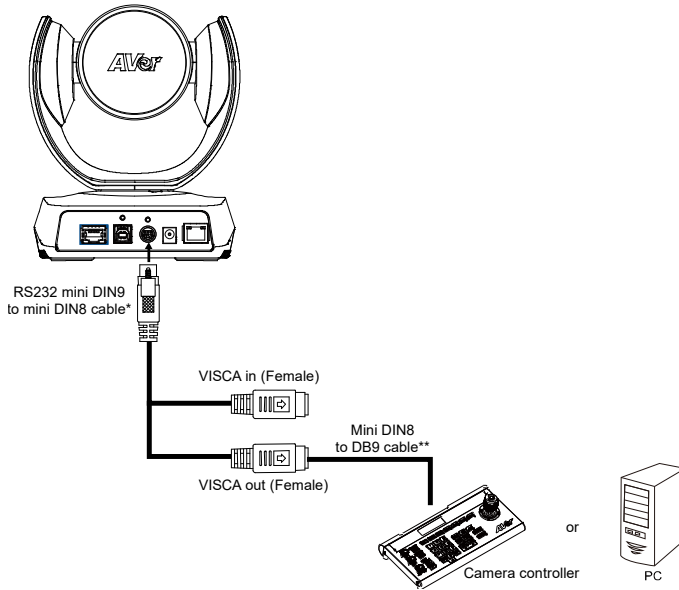

Camera controller or PC
(DB9)

1. DCD
2. RXD
3. TXD
4. DTR
5. GND
6. DSR
7. RTS
8. CTX
9. RI

Camera
(Mini DIN8)

1. DTR (IN)
2. DSR (IN)
3. TXD (IN)
4. GND (IN)
5. RXD (IN)
6. GND (IN)

1. DTR (OUT)
2. DSR (OUT)
3. TXD (OUT)
4. GND (OUT)
5. RXD (OUT)
6. GND (OUT)

*RS232 mini DIN9 to mini DIN8 Cable Pin Definition

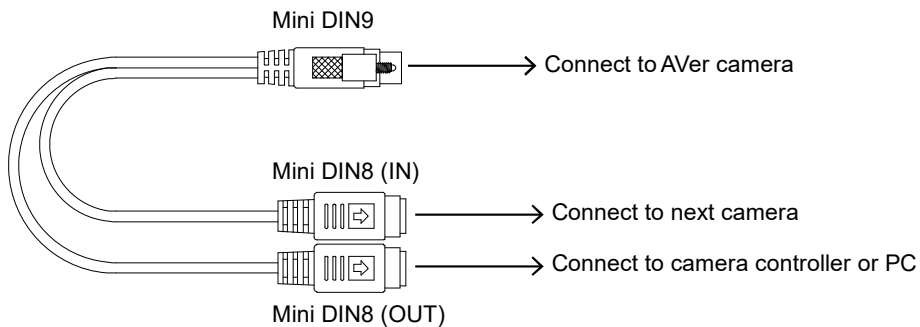

Mini DIN8 Pin Definition

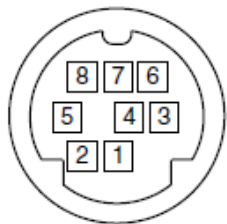

No.	Pin
1	DTR
2	DSR
3	TXD
4	GND
5	RXD
6	GND
7	NC
8	NC

■ Camera Cascade Connection

Direct Connection

If users don't buy AVer RS232 adaptor cable, please refer to the pin connection shown below for cascading cameras.

Total can connect up to 7 cameras.

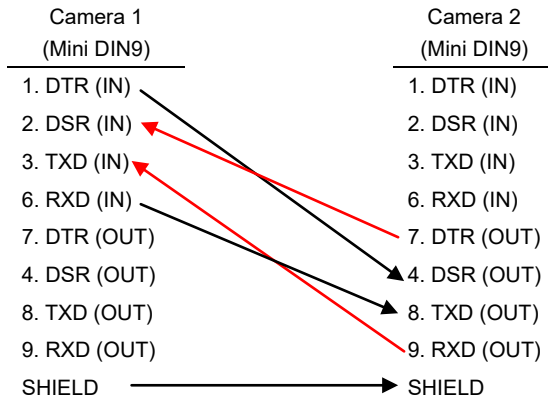
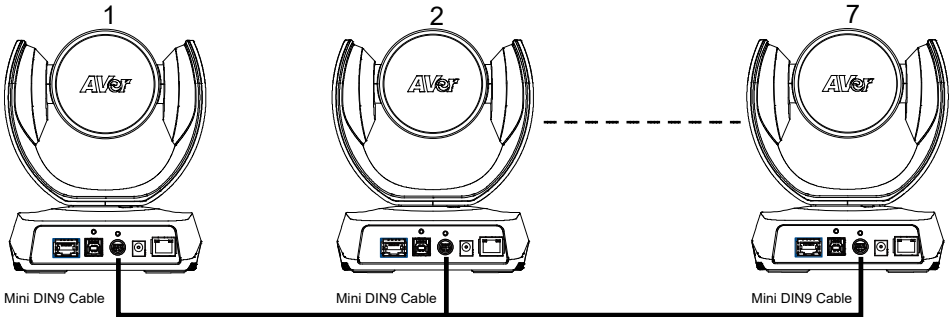

Use the RS232 mini DIN9 to mini DIN8 cable

Total can connect up to 7 cameras.

To facilitate the camera cascade, users can purchase AVer RS232 adaptor cable.

Connect camera with AVer mini DIN9 to mini DIN8 adaptor cable. Connect the mini DIN8 female side to male mini DIN8 Visca cable (Users have to buy it in the market) and then connect AVer mini DIN9 to mini DIN8 adaptor cable again to connect to next camera.

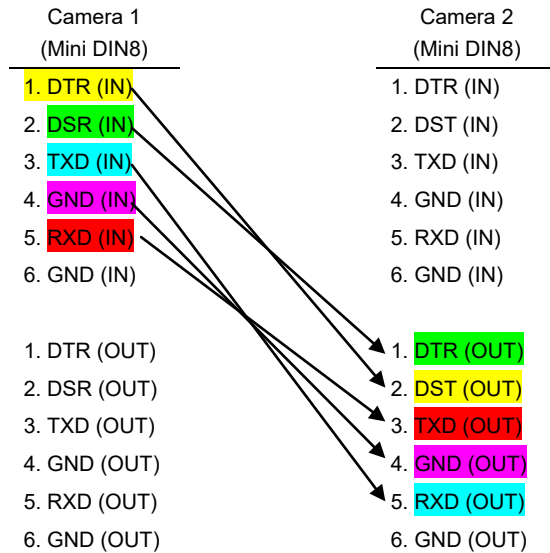
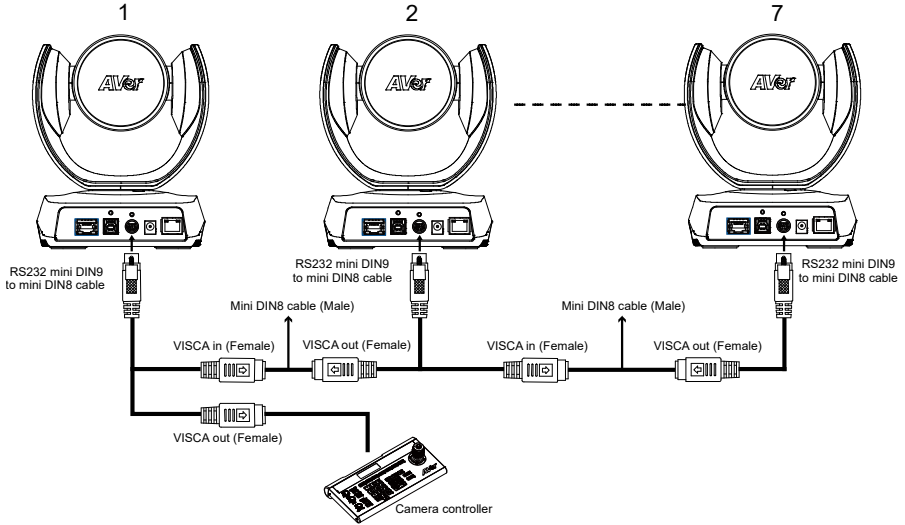

Wall Mount Installation

1. Use the drilling paper included in the package to drill the holes in the wall where the user wants to mount the camera.

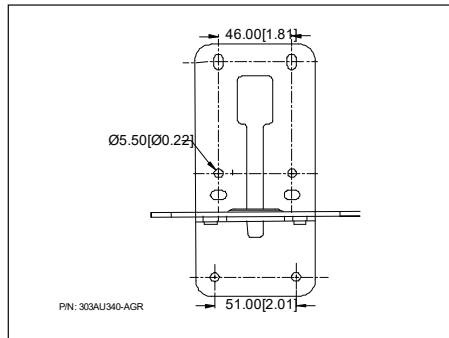

2. Use the screws (not included) to secure the L-mount bracket **A** on the wall.

Screw

For Cement wall: M4 x20mm self-tapping screws (x4) + Plastic conical anchor

For Wooden wall: M4 x20mm self-tapping screws (x4)

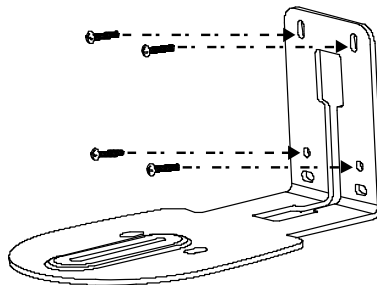

3. Then, assemble the L-mount brackets **A** + **B** with screws (included in package).

Screw:  M4 x8mm (x2)

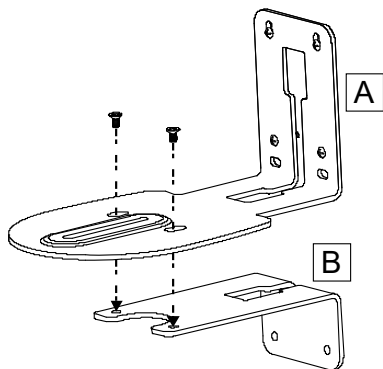

4. After assembling the L-mount brackets, use the screws (not included) to secure the L-mount bracket **B** on the wall.

Screw

For Cement wall: M4 x20mm self-tapping screws (x2) + Plastic conical anchor

For Wooden wall: M4 x20mm self-tapping screws (x2)

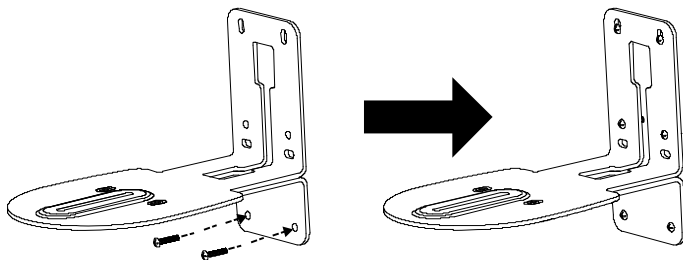

5. Pass the cables through the hole on the L-mount brackets and connect the cables to corresponding connection ports.

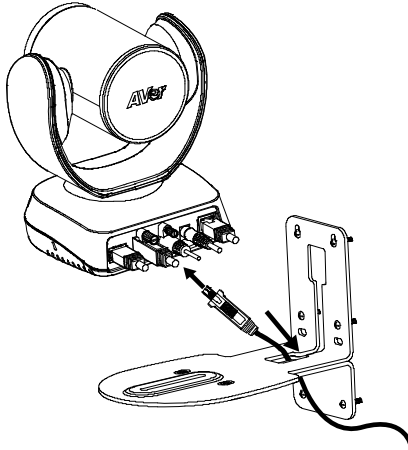

6. Use the remaining screws (included in package) to secure the camera on the L-mount brackets.

Screw:  1/4"-20 L=7.5mm (x2)

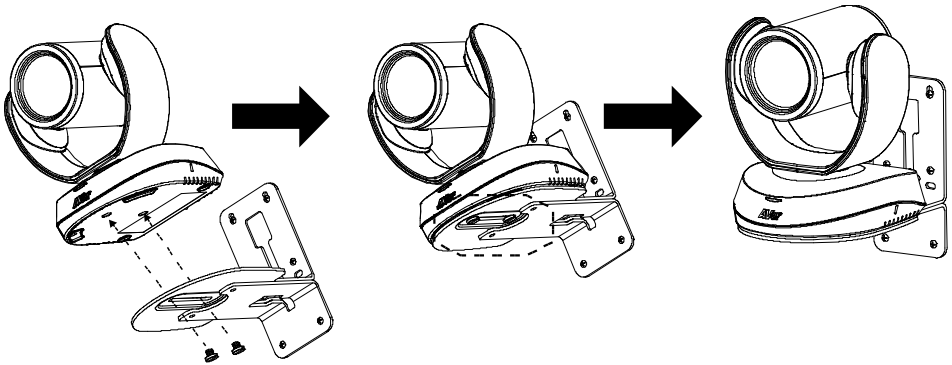

Operating the Camera

Make a Video Call

1. Make sure all devices (VC520 Pro2, speakerphone and PC/laptop) are well connected and power is on.
2. Run your video application (Zoom, Microsoft® Teams, Skype for Business, Skype, Google Meet, Intel® Unite™, RingCentral, BlueJeans, V-Cube, LiveOn, CyberLink U Meeting®, TrueConf, Adobe Connect, Cisco WebEx®, Fuze, GoToMeeting™, Microsoft® Lync™, Vidyo, vMix, WebRTC, Wirecast, XSplit, etc.) on your PC or laptop.
3. Set the VC520 Pro2 camera and speakerphone as the primary camera and speakerphone for your video application (refer to your video application user guide). You can now make your call.

[Note] The VC520 Pro2 is a plug-and-play conference camera. The system requires no special drivers, but we do recommend installing the PTZApp 2 for a better user experience. For information on how to install and use the PTZApp 2, refer to the PTZApp 2 section in this user manual.

Make a Connection through the Browser

VC520 Pro2 has an Ethernet port for IP streaming and allows administrators to remotely control and set up the camera via an internet access. Moreover, VC520 Pro2 also supports RTSP and RTMP functions. For more details, please contact our technical support.

1. Make sure the VC520 Pro2 has an internet access connection.
2. Launch PTZApp 2* (PTZApp 2 icon) and connect VC520 Pro2 to PC with USB cable. The camera default IP address is **192.168.1.168**.



[Note] The browser supports:

- Chrome: version 76.x or above
- Firefox: version 69 or above
- IE: Doesn't support

3. Click pencil icon (✎) to edit IP address**.

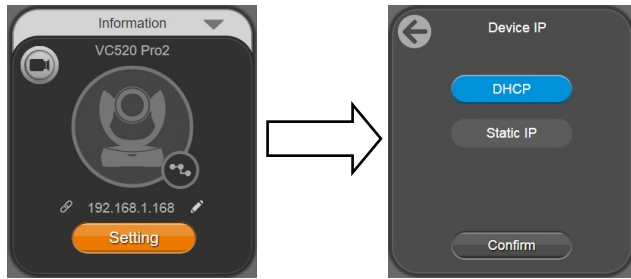

4. Click weblink icon (🔗) to launch Chrome page. Please enter the password (default password is **aver4321**). User will be asked to set a new account and password. (Please enter AVer PTZApp2 software to reset password back to default while password is forgotten.)

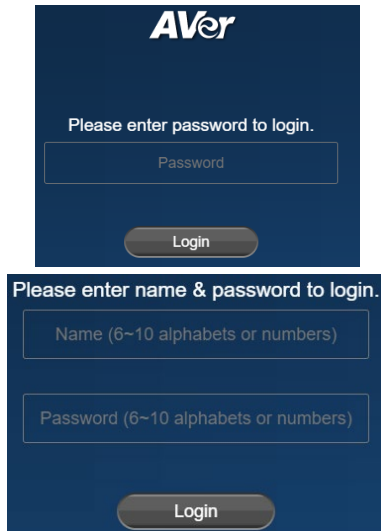

5. After editing IP address, user can access web settings of the camera with only Ethernet cable connection. Unplug the USB cable.

- The main web screen is displayed as below.

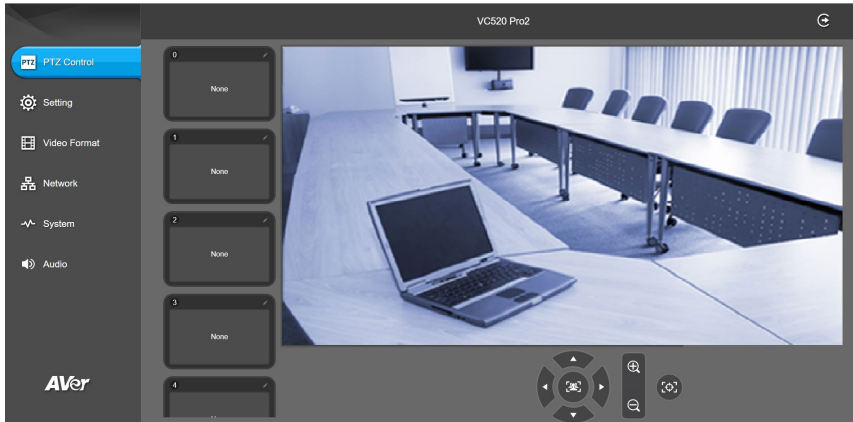

* For information on how to install and use the PTZApp 2, refer to the PTZApp 2 section in this user manual.

** To support IP address changes in groups, user can download AVer IP Finder app.

- Download the IP Finder from <https://www.aver.com/download-center> (Global & European Headquarters) or <https://www.averusa.com/business/support/> (USA).

- Run the IP Finder.

- Click **“Search”**, and all available devices will be listed on the screen.

- Select a camera from the list. The corresponding fields of IP address will display.

- To change the IP address of camera, user can select **“DHCP”** or **“Static IP”**.

The DHCP should get the IP address from local dynamic IP sever. The static IP, user can enter the specific IP address. Click **“Apply”** to apply the setting to the camera. The password is required (default password is **aver4321**).

- Click **“Search”** button to re-scan the camera.

- Double-click on the IP address of camera from the list can connect to camera through the browser.

- Enter the default password (**aver4321**) to login to Web setup screen.

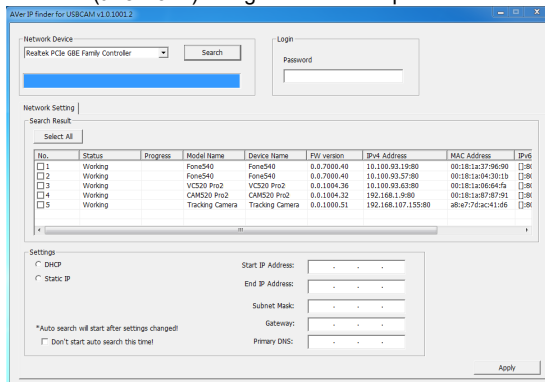

Web Settings

VC520 Pro2 supports Ethernet connection; users can enter the IP address into the web browser to connect to the camera for detail settings.

First Time Login

To find the IP address of the camera, please refer to “**Make a connection through the Browser**” section.

1. Open the browser on your laptop/PC and enter the IP address of the camera.
2. Enter the password at login screen. The default password is “**aver4321**”.
3. The main web screen is displayed.

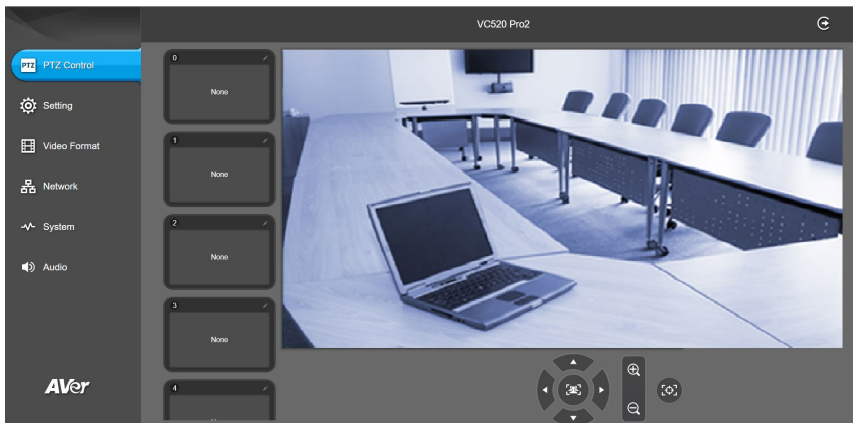

Live Screen Operation

User can control the camera direction, zoom in/out, and preset selection.

[Notes]

1. The system will force the previous login to log out, when there is a second login.
If the web page is idle without any request for more than 4 hours, user will be log out.
2. The resolution of live screen is 480p/5fps.

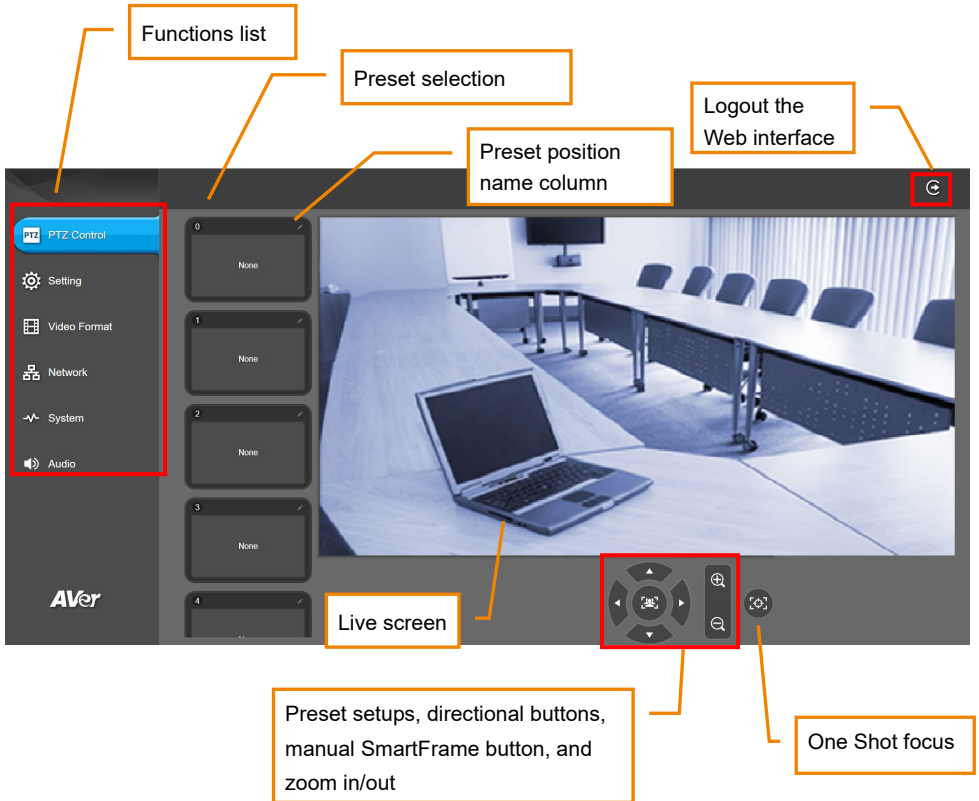

Set Up the Preset

User can set 10 preset positions.

1. In live screen, use mouse to scroll up or down and click the preset number frame (0~9).
2. Use ▲, ▼, ◀, ▶ and zoom in/out buttons to adjust the camera screen view to desired position.
3. Select **“Set Preset”** button to save the preset. The system will capture the preset screen view and display in preset number frame.

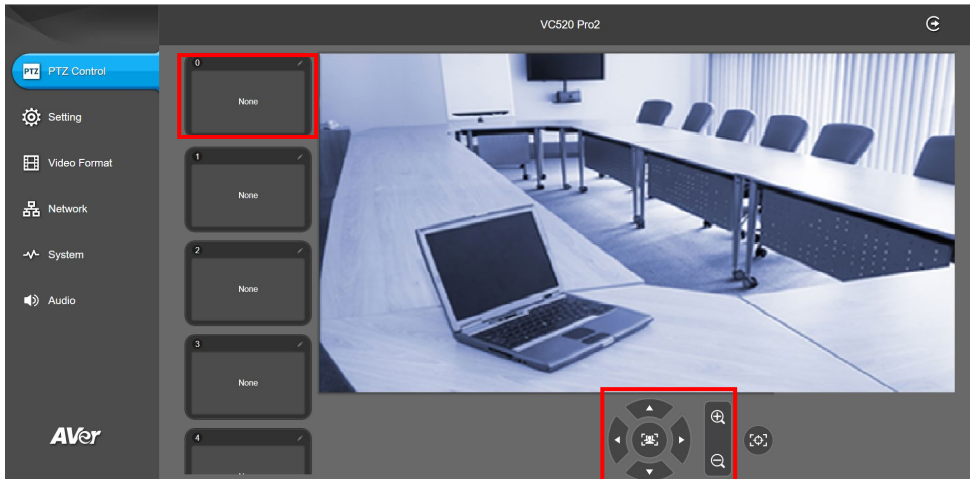

4. Select  icon to edit name of preset frame. Click other Web interface to save the name edited.

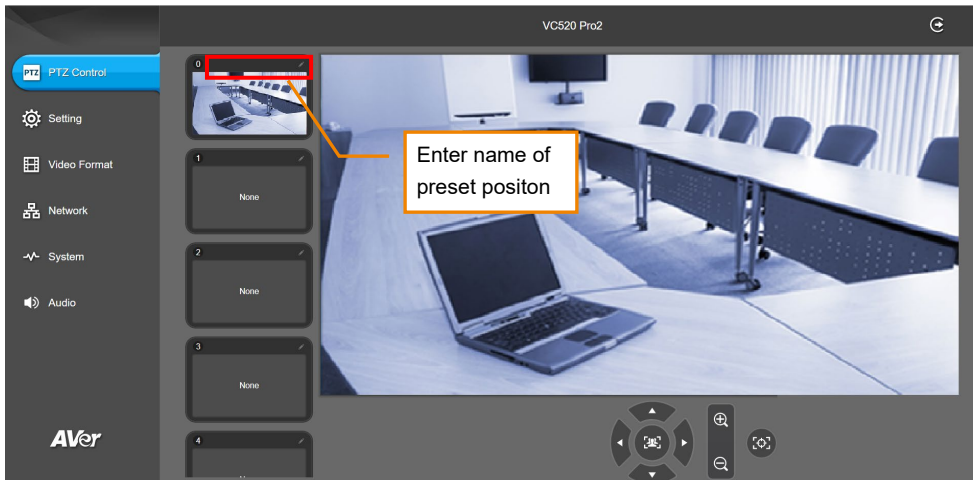

5. To set another preset, repeat the above steps.

Select the Preset Position

Preset positions need to be set.

Use mouse to scroll up or down to select the preset. Select the preset user wants. The live screen will move to the preset screen view.

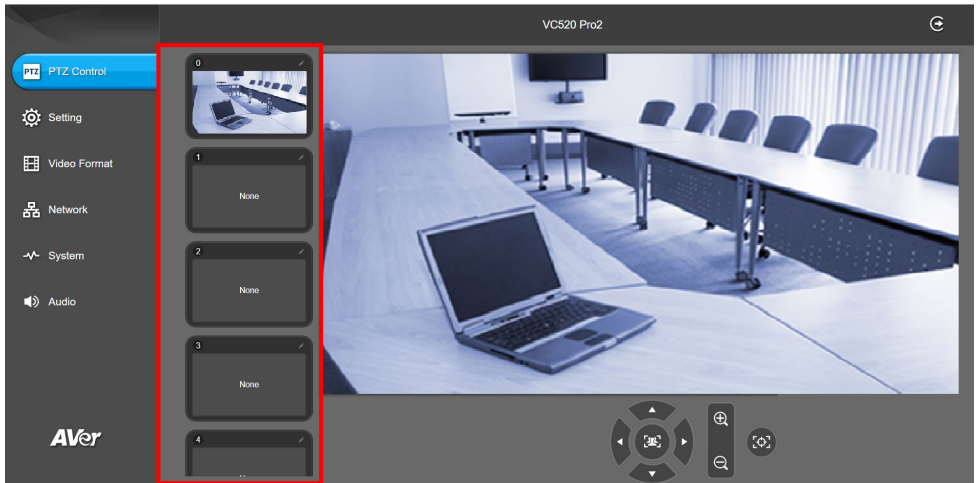

Camera Settings

The video  icon is to turn on camera live view while doing any settings.

IP icon shows the IP address of the camera.

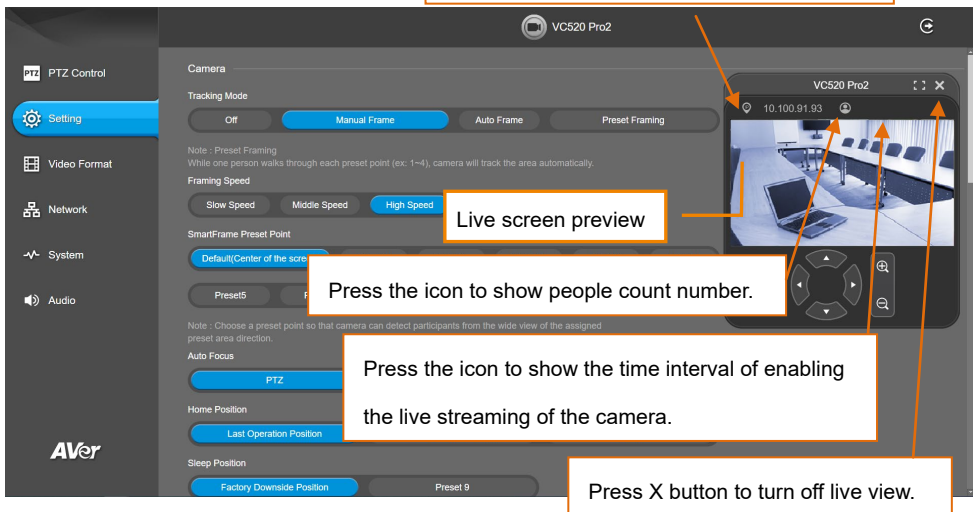

Tracking Mode

Select **Setting > Camera > Tracking Mode > Off, Manual Frame, Auto Frame, or Preset Framing.**

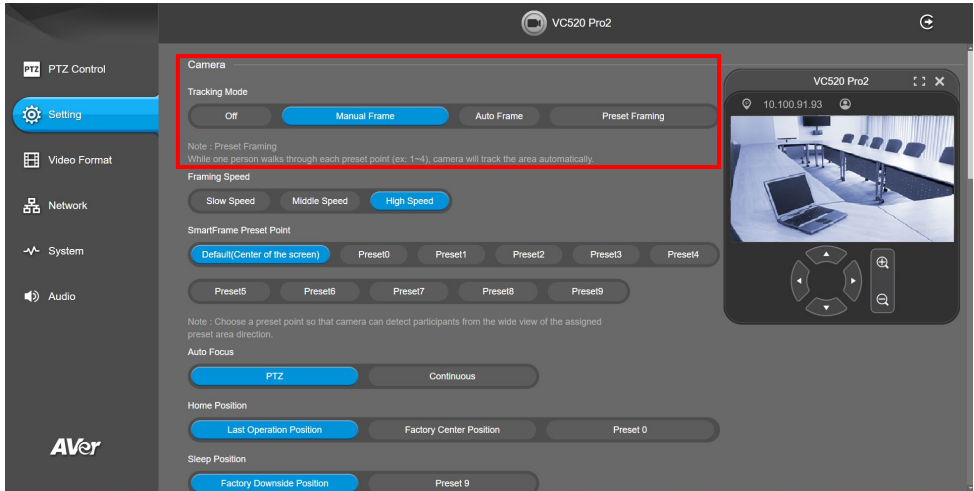

- **Off:** Tracking mode is disabled.
- **Manual Frame:** User one-click SmartFrame button and camera will adjust view angle to fit all participants in screen for once.
- **Auto Frame:** Camera automatically adjusts view angle to frame all participants in screen every time when it detects people's faces or bodies. This action will be activated while people in the room sit or stand still for 1~5 seconds, depending on framing speed you select. Once all the participants are in frame, the camera will keep the image stable by not completing any action until subjects move in or out of the screen. When people touch the sides of the screen, it will trigger the camera and automatically track, detect and frame all the participants again.

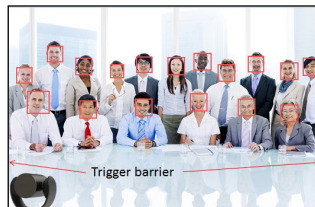

- **Preset Framing:** Set up preset points in advance. (Only for Preset points 1~9. Preset 0 is for home position). This is designed for only one presenter. Camera tracks presenter and shoot the preset areas instead of focusing and zooming into presenter. To ensure smooth transition, please set up areas with interconnection. If the preset areas are not interconnecting, it will activate video tracking function. The camera will follow the presenter until he goes into another preset area.

Overlap area



[Note] VC520 Pro2 frames people in masks or any facial profile up to 7~10 meters away!

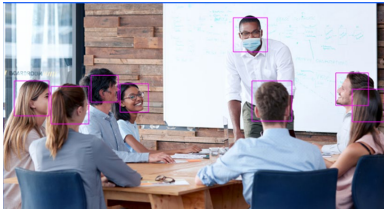

Framing Speed

Select **Setting > Camera > Framing Speed > Slow Speed, Middle Speed, or High Speed** (default).

When in auto framing or preset framing mode, camera will automatically frame people if they stand still without moving for 1~5 seconds.

- **Slow speed:** camera starts to frame people if they don't move for 5 seconds.
- **Middle speed:** camera starts to frame people if they don't move for 3 seconds.
- **High speed:** camera starts to frame people if they don't move for 1 second.

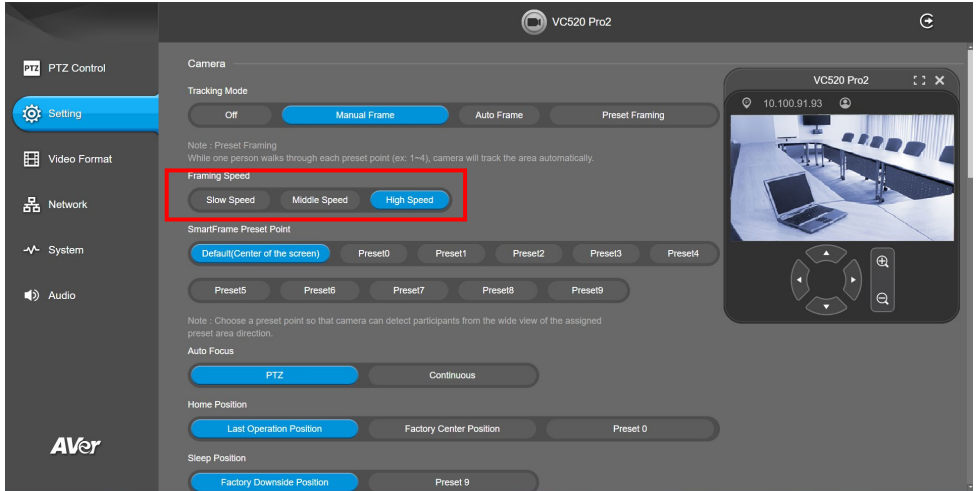

Smart Frame Preset Point

Select **Setting > Camera > Smart Frame Preset Point > Default(Center of the screen) or Preset0 ~ Preset9.**

The default is the central of the image screen. Choose a preset point so that camera can detect participants from the wide view of the assigned preset area direction.

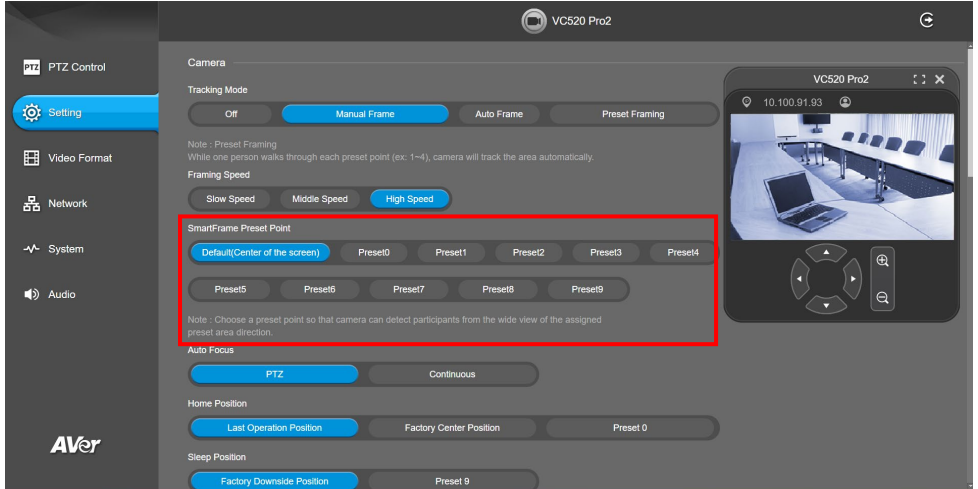

Auto Focus

Set auto focus mode.

Select **Setting > Camera > Auto Focus > PTZ** or **Continuous**.

- **PTZ:** By clicking the button (such as pan, tilt, or zoom in/out) to adjust focus once.
- **Continuous:** The camera will adjust the focus when the objects have moved.

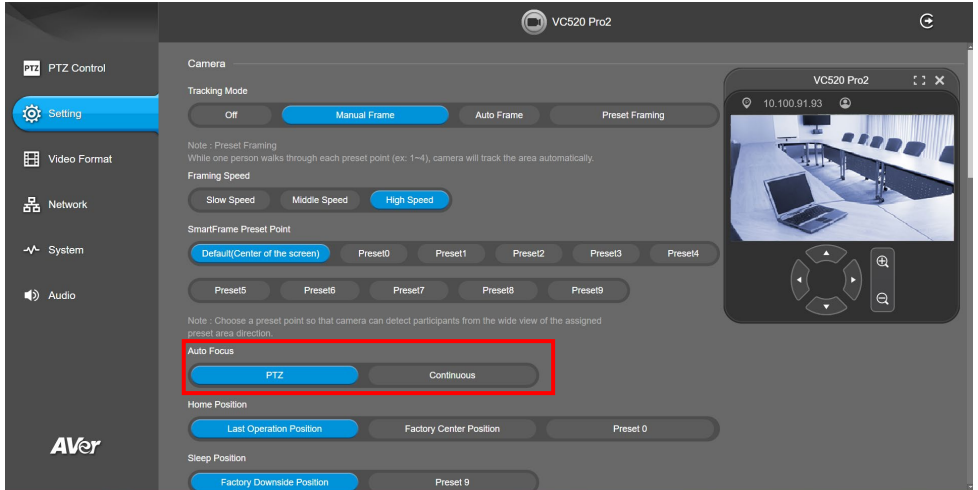

Home Position

Every time when powering on the camera, it will turn to this position.

Select **Setting > Camera > Home Position > Last Operation Position, Factory Center Position, or Preset 0**.

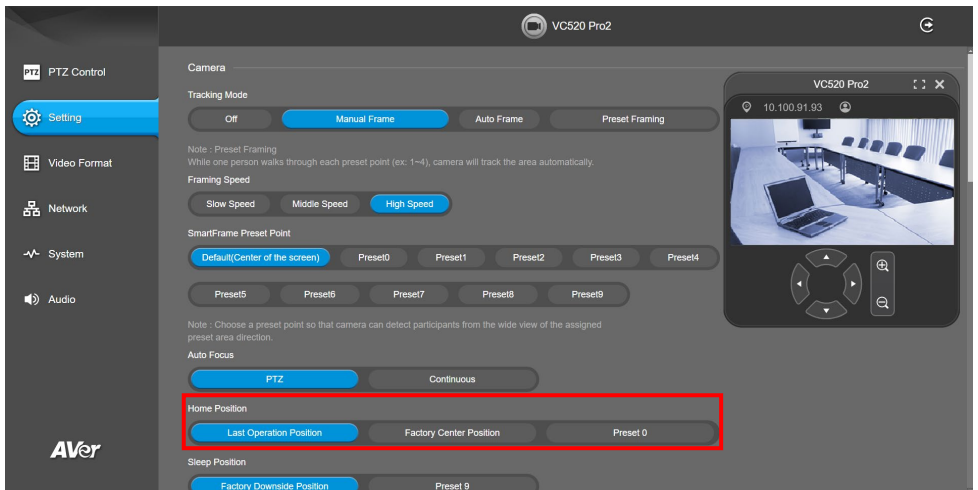

Sleep Position

When the camera idles for certain period, it will enter sleep mode and go to the sleep position. Please set up sleep timer to enable sleep mode.

Select **Setting > Camera > Sleep Position > Factory Downside Position** or **Preset 9**.

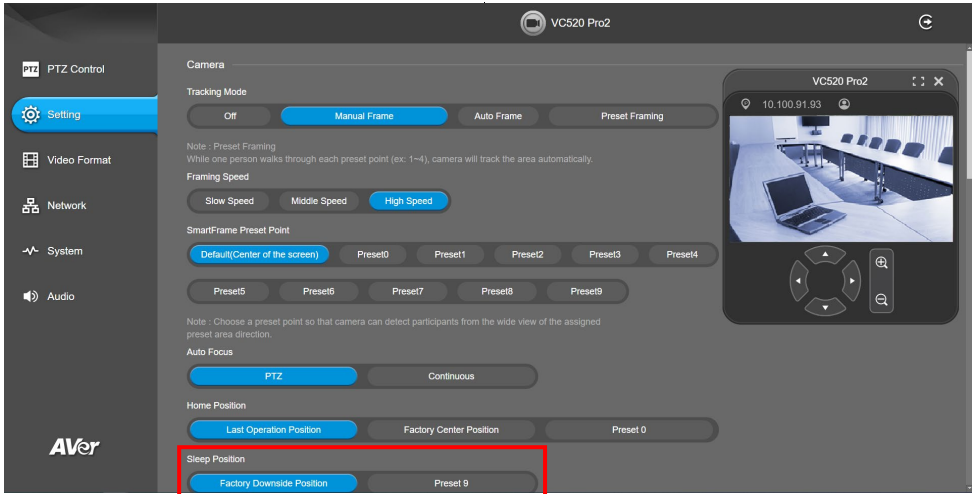

Sleep Timer

Set the camera idle time to enter sleep mode.

Select **Setting > Camera > Sleep Timer > Off, 10 sec, 5 min, 10 min, or 20 min**.

Please notice that whenever there is USB streaming or RTSP/RTMP streaming, the camera won't enter sleep mode.

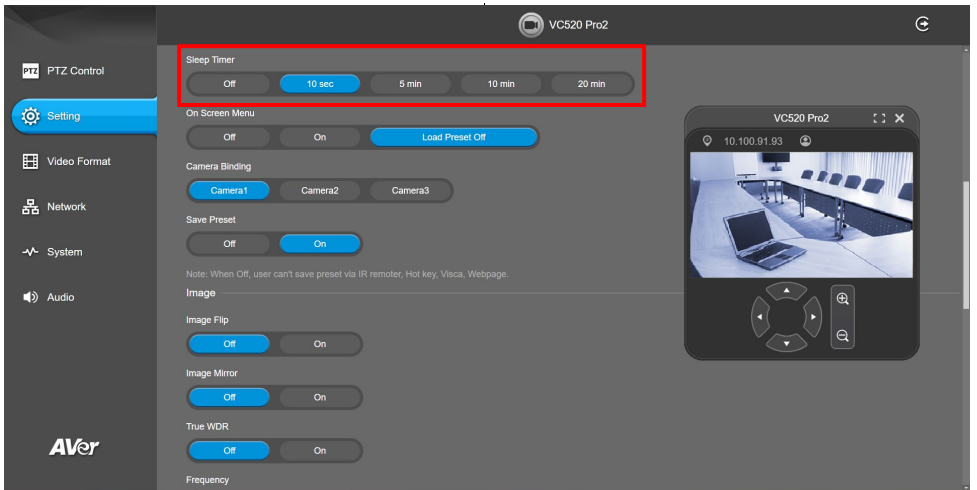

On Screen Menu

Enable/disable on screen display status information. For instance, when it is at auto frame mode, it will appear “Auto framing” on the bottom of the screen. If you don't want to see the words, please select Off.

Select **Setting > Camera > On Screen Menu > Off, On, or Load Preset Off.**

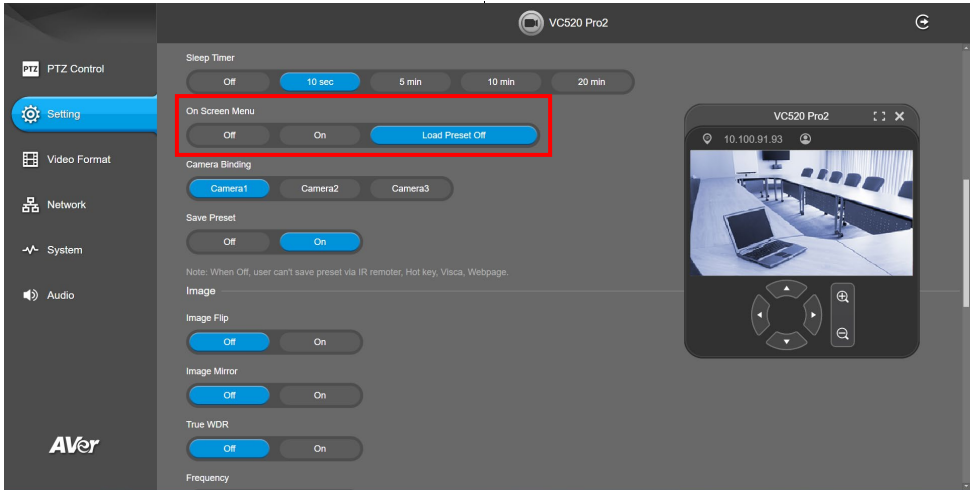

Camera Binding

With multiple cameras connection, users can set each camera to buttons 1 to 3 on the remote control.

Select **Setting > Camera > Camera Binding > Camera1, Camera2, or Camera3.**

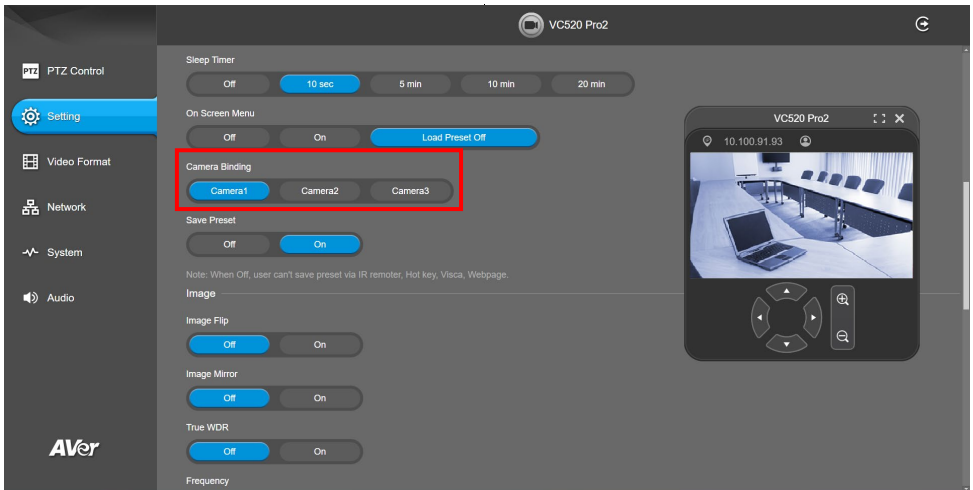

Save Preset

Enable/disable “save preset” function. In some cases, in order not to let end-users change preset points, IT guys can lock “save preset” function by switch this function off.

When it's off, user can't save preset points via IR remoter, Hot key, VISCA, and webpage.

Select **Setting > Camera > Save Preset > Off or On.**

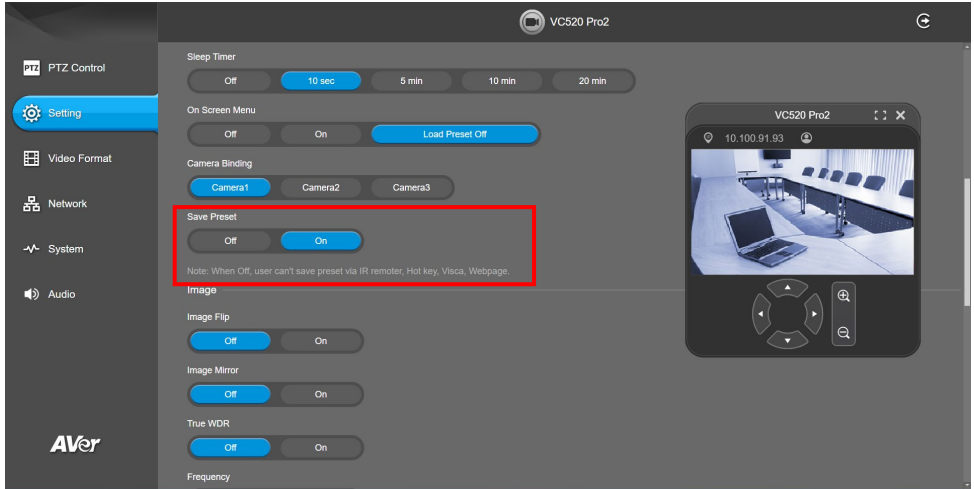

Image Settings

Image Flip

If the VC520 Pro2 is installed in the upside down position, please enable the "Flip".
Select **Setting > Image > Image Flip > Off or On.**

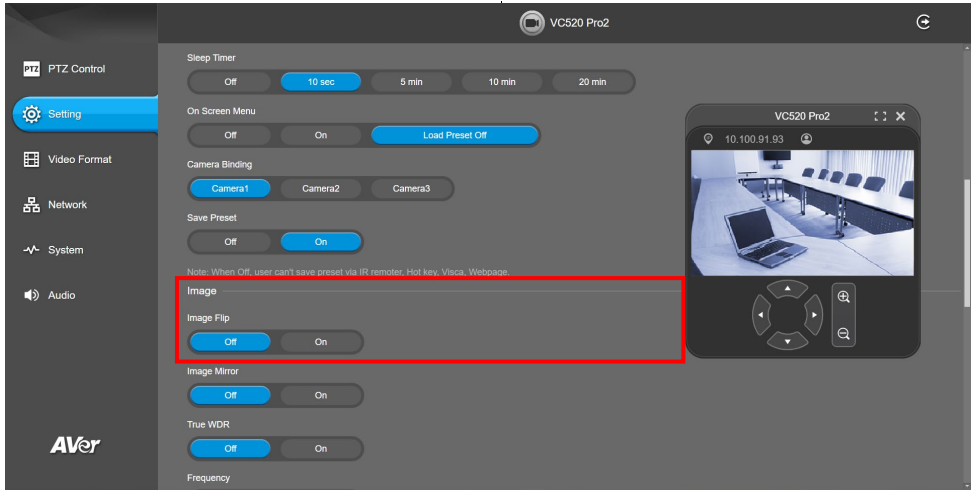
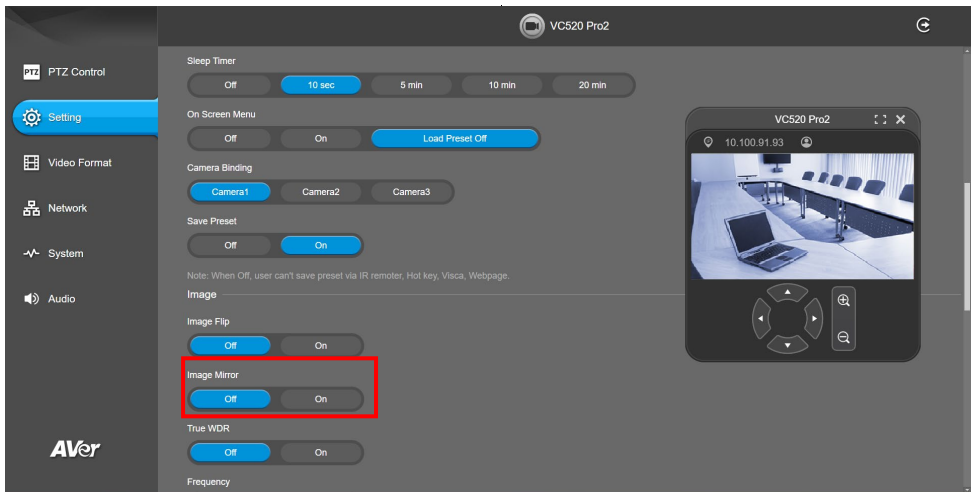

Image Mirror

To mirror the camera image.
Select **Setting > Image > Image Mirror > Off or On.**



True WDR

In back light environment, enabling WDR to improve the brightness of image.

Select **Setting > Image > True WDR > Off or On.**

The frame rate will be limited to 30fps while WDR is on.

If user enables this function in a normal light condition, the image will become over exposure and encounter image blur.

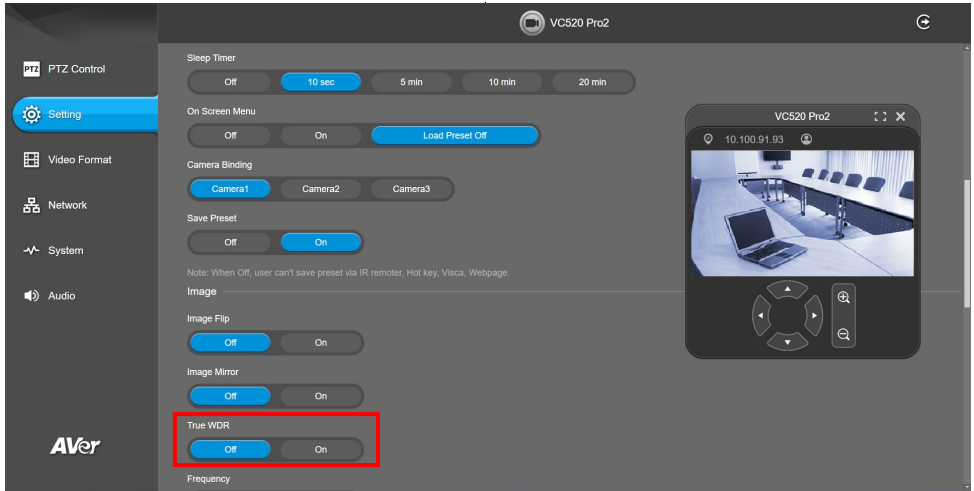

Frequency

Select the frequency of the camera.

Select **Setting > Image > Frequency > 50 HZ or 60 HZ.**

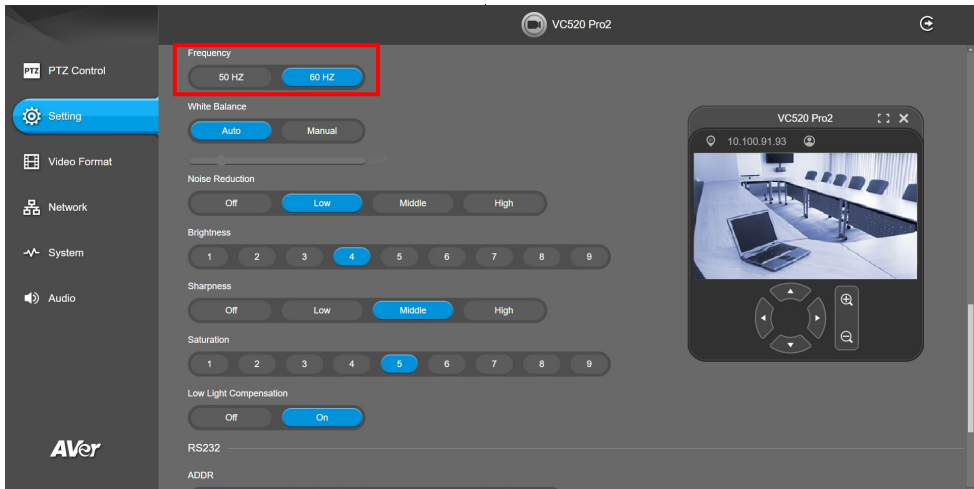

White Balance

Select the white balance setting for various light conditions or color temperature.

Select **Setting > Image > White Balance > Auto or Manual**.

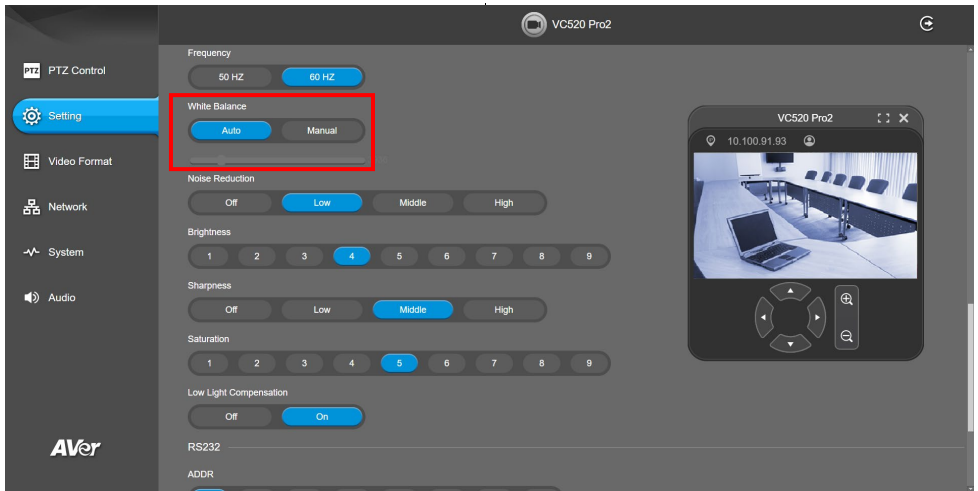

Noise Reduction

To reduce the noise from the signal.

Select **Setting > Image > Noise Reduction > Off, Low, Middle or High**.

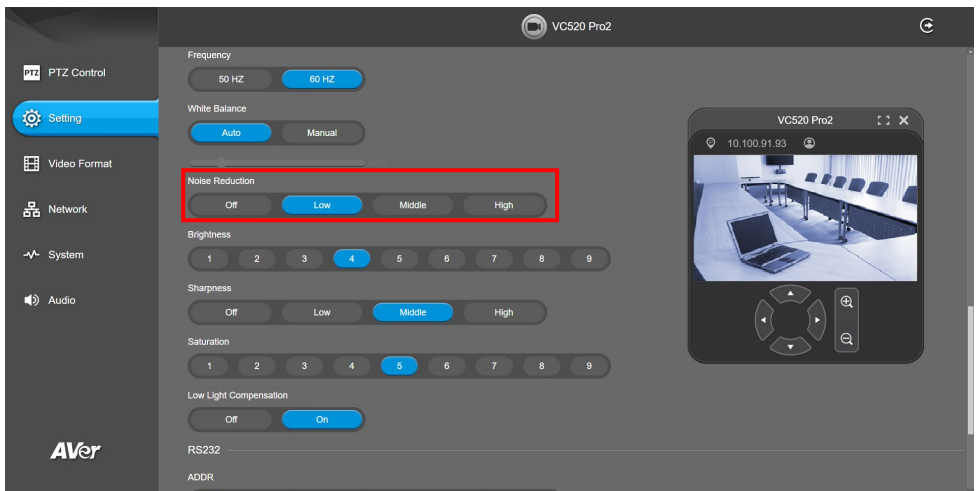

Brightness

Adjust the value of brightness.

Select **Setting > Image > Brightness > 1 ~ 9.**

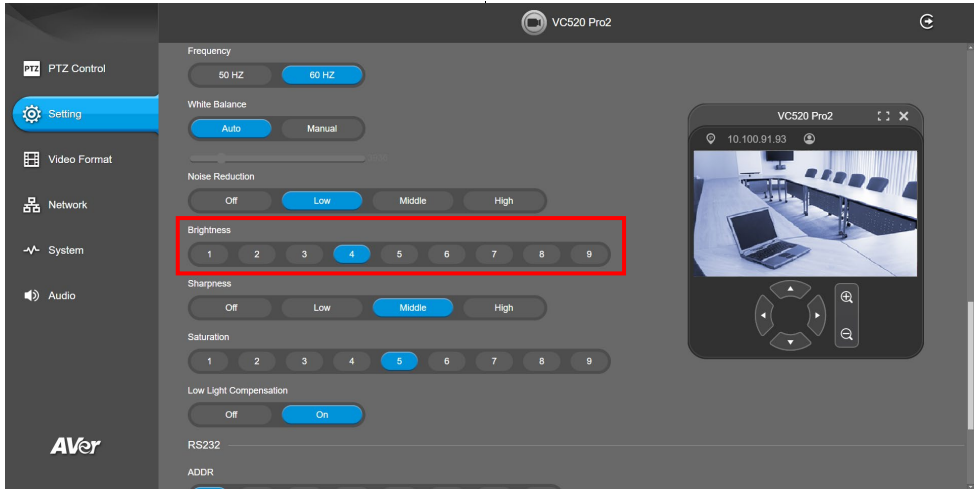

Sharpness

Adjust the value of sharpness.

Select **Setting > Image > Sharpness > Off, Low, Middle or High.**

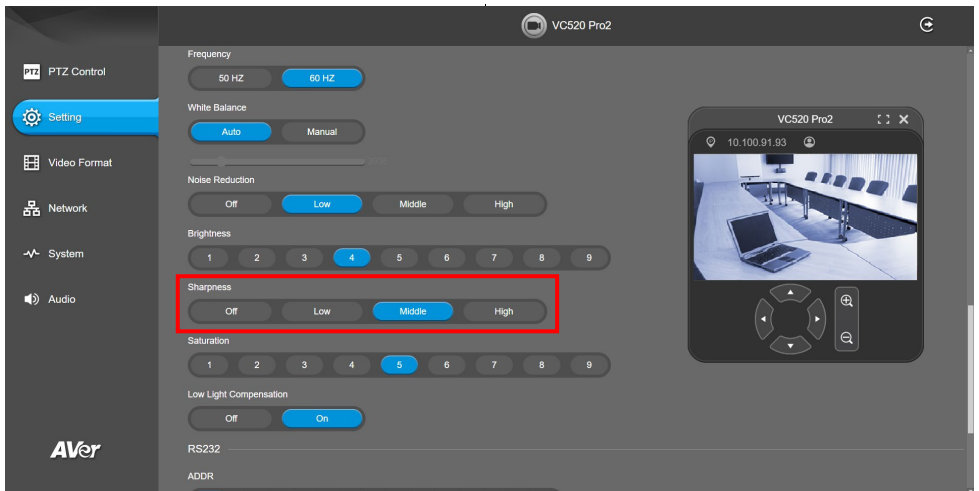

Saturation

Adjust the value of saturation.

Select **Setting > Image > Saturation > 1 ~ 9**.

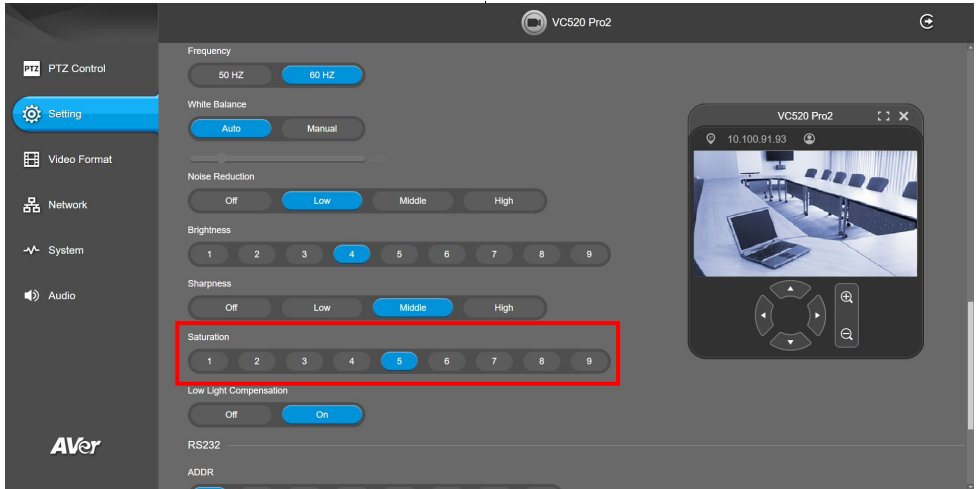

Low Light Compensation

Select **Setting > Image > Low Light Compensation > Off or On**.

Please notice that the frame rate will drop to 10~15 fps.

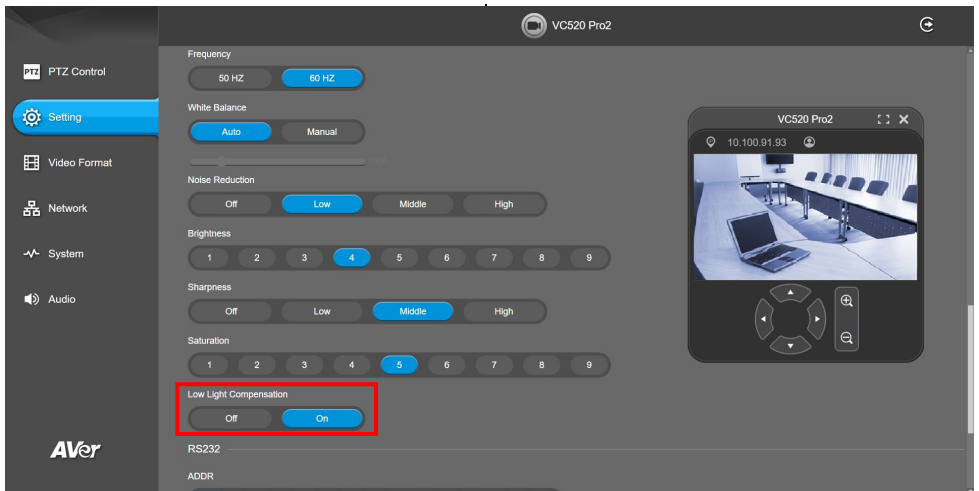

RS232 Setting

When VC520 Pro2 connects with PTZ camera controller through the RS232 port, please setup **ADDR**, **Baud Rate**, **Protocol**, and **Visca Over IP** settings.

Select **Setting > RS232**.

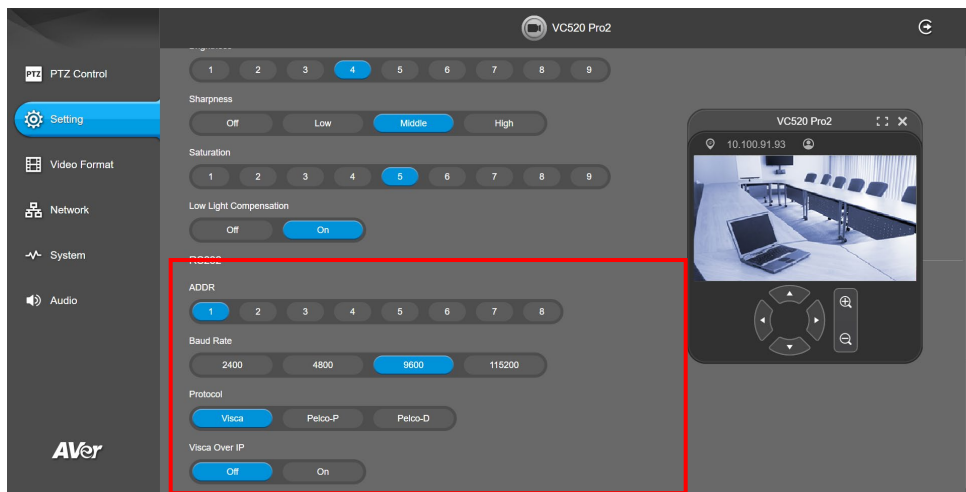

Video Format Settings

H.264 Profile

While in live broadcasting, user can choose preferable profile to get best streaming quality.

Select **Video Format > H.264 Profile > Baseline Profile** or **High Profile**.

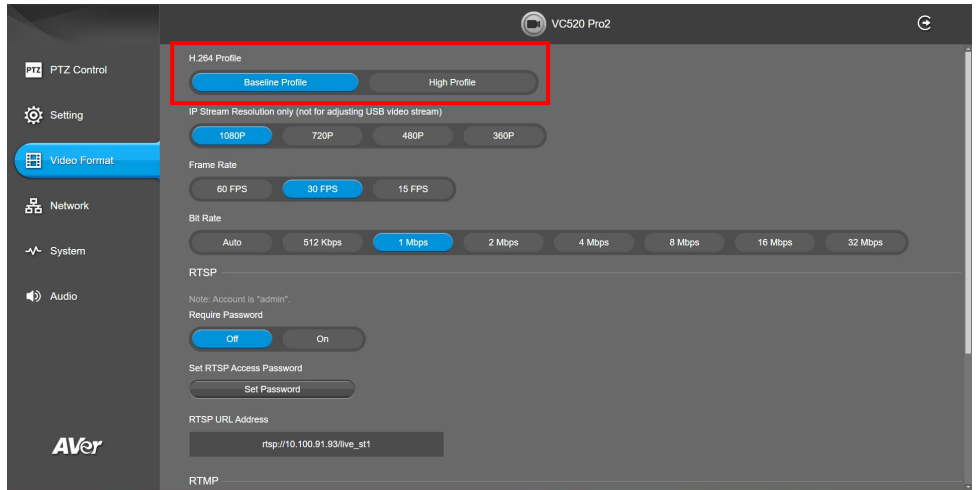

IP Stream Resolution

Set up the resolution for IP stream. Not supported for USB video stream.

Select **Video Format** > **IP Stream Resolution only (not for adjusting USB video stream)** > **1080P**, **720P**, **480P**, or **360P**.

Please notice that if USB streaming (VC software side) is already in use at 1080p/30fps, the IP streaming resolution (RTSP) will be limited to 720p/30fps. It's better to disconnect USB streaming while having RTSP/ RTMP IP streaming to ensure the video transmission quality.

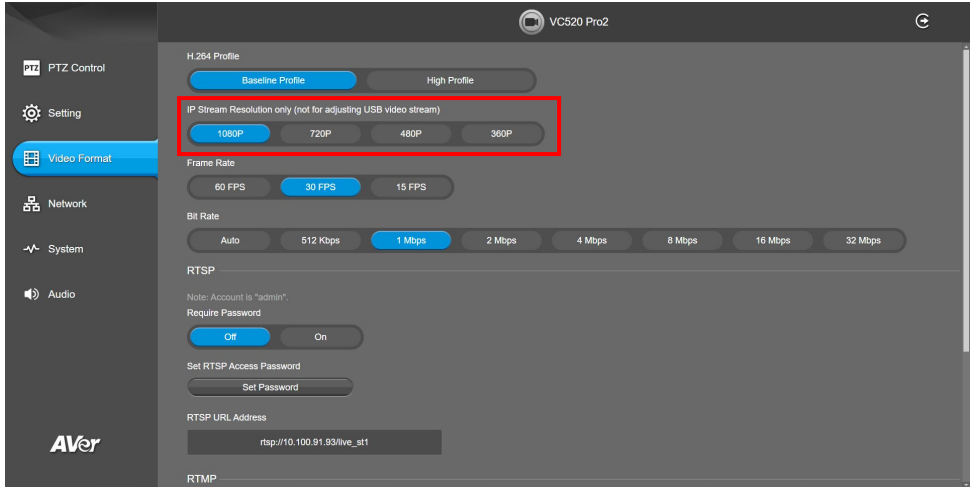

Frame Rate

Set up the frame rate value.

Select **Video Format > Frame Rate > 60 FPS, 30 FPS, or 15 FPS.**

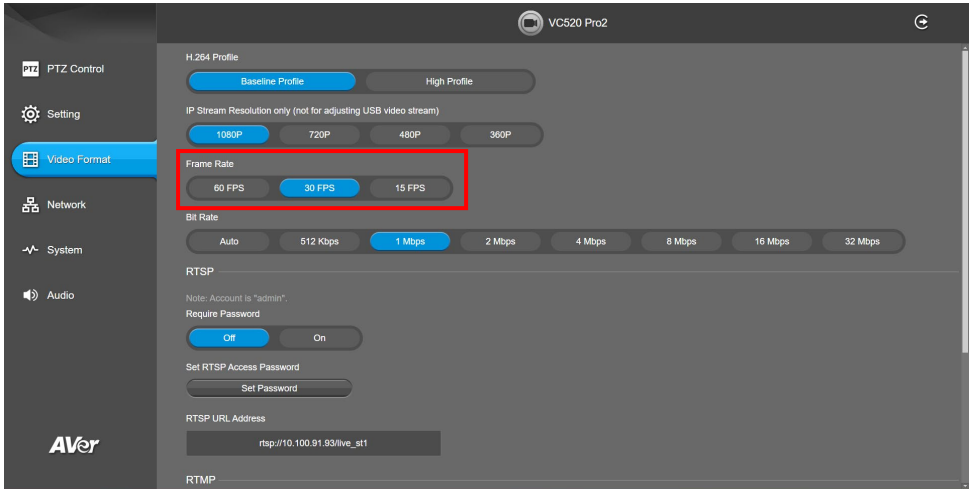

Bit Rate

Set up the bit rate value.

Select **Video Format > Bit Rate > Auto, 512 Kbps, 1 Mbps, 2 Mbps, 4 Mbps, 8 Mbps, 16 Mbps, or 32 Mbps.**

For Facebook live broadcasting, it's suggested to choose less than 4Mbps to ensure smooth streaming.

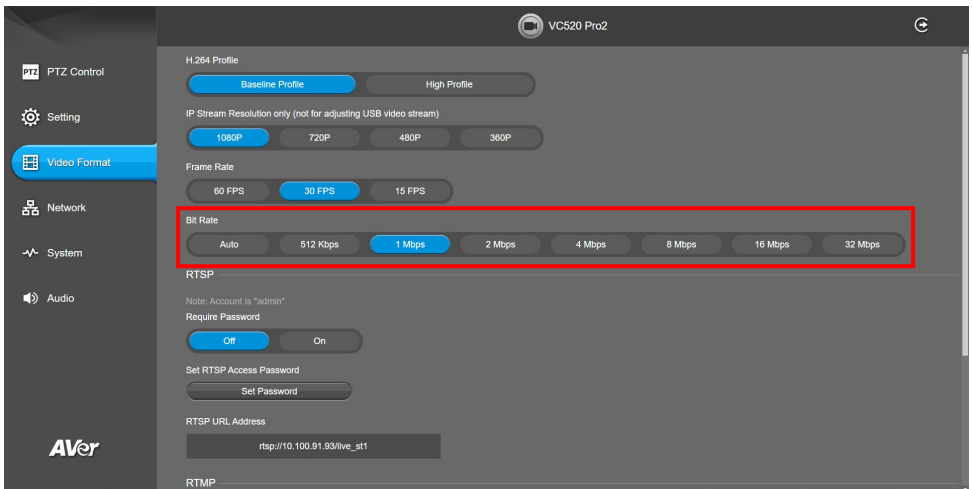

RTSP

To use RTSP player connecting to the camera, please enter the RTSP URL which displays on the web in your application such as VLC, PotPlayer or Quick Time.

Select **On** to enable RTSP function.

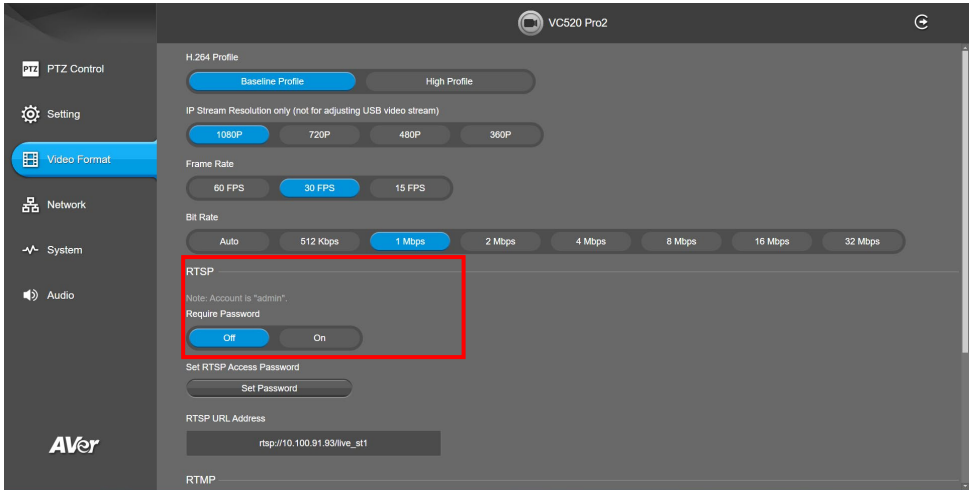

Change RTSP Password

1. Select **Video Format** > **RTSP** > **Change RTSP Access Password**.
2. Enter the new password.
3. Select **Change** to save the new password.

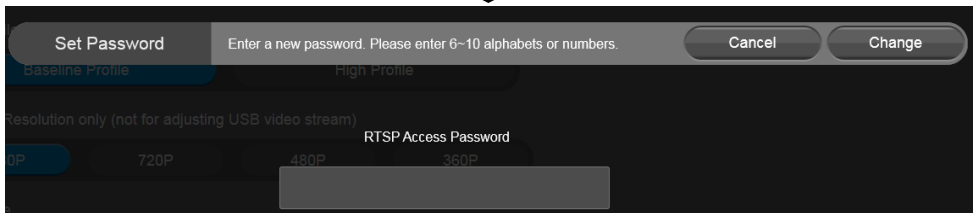
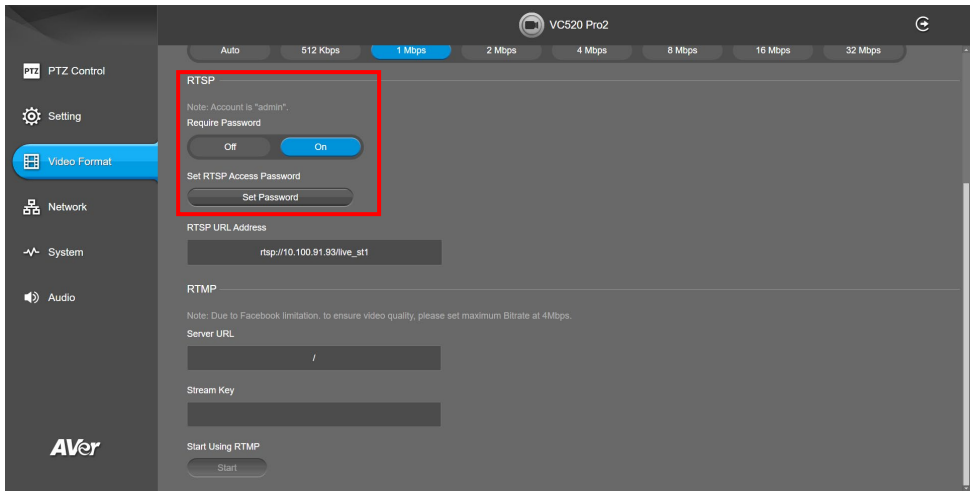

RTMP

Setup for uploading the camera's live view to the broadcasting platform (e.g. YouTube).

Select **Video Format > RTMP**.

1. Locate the RTMP server URL and stream key from the broadcasting platform and enter in **Server URL** and **Stream Key** fields.
2. Select **Start** to begin uploading the live video of the camera to the broadcasting platform.
3. Select **Stop** to stop uploading the video.

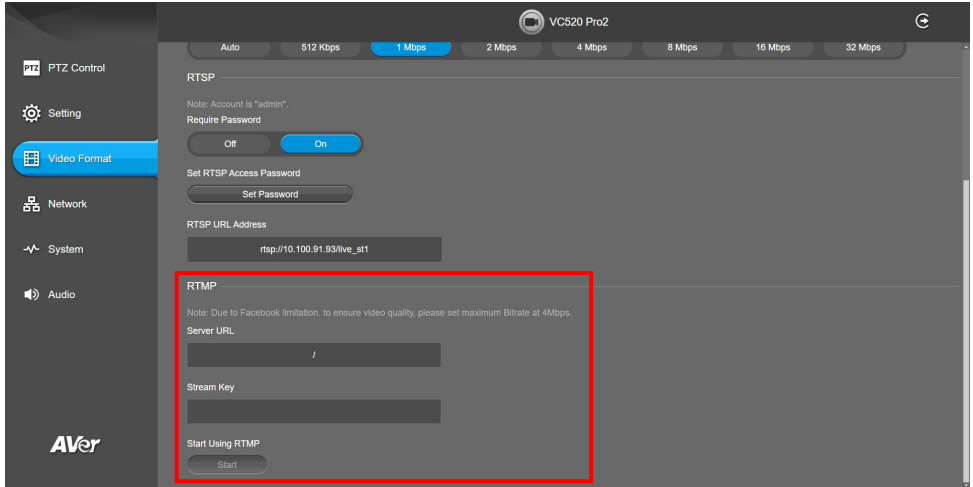

Network Settings

DHCP

Enable/disable DHCP function.

Select **Network** > **DHCP** > **Off** or **On**.

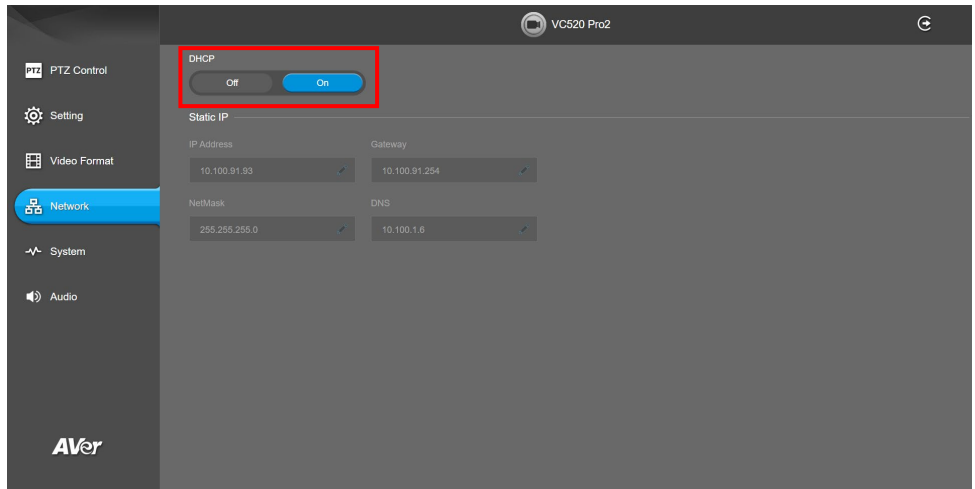

Static IP

Assign a fixed IP address to the camera. Please turn off the DHCP function.

1. Select **Network > Static IP**.
2. Click pencil icon and enter the **IP Address**, **Gateway**, **NetMask**, and **DNS** in the corresponding fields.
3. Select **Confirm** to complete the setting.

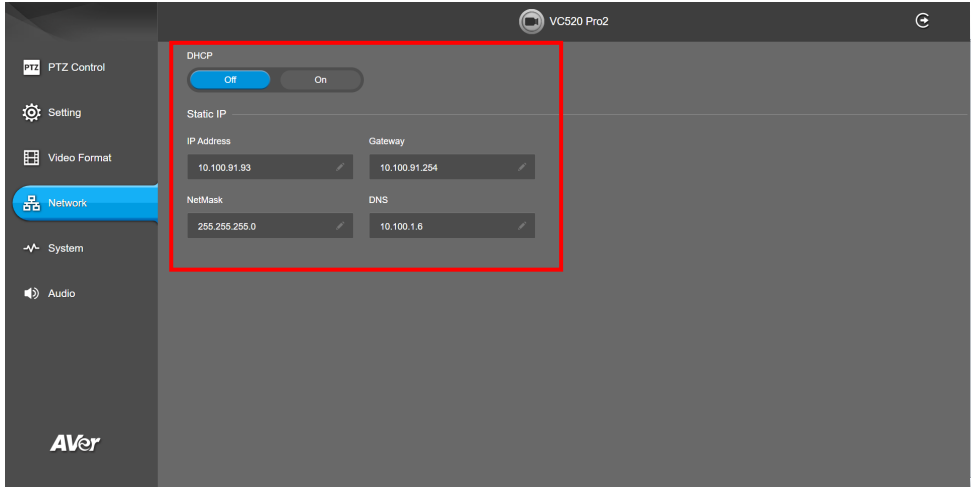

System Settings

Language

Select the language of the system.

Select **System** > **Language** > **English**, **Traditional Chinese**, or **Japanese**.

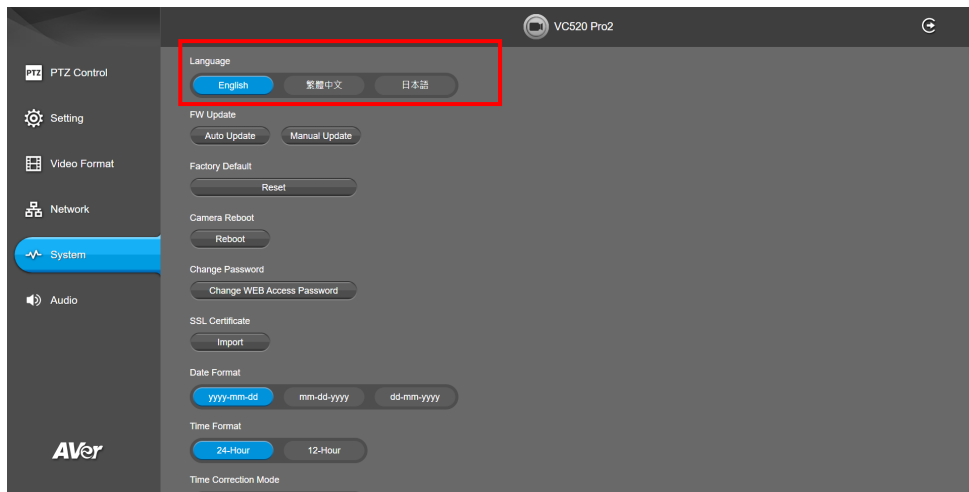

Firmware Update

Update the camera's firmware.

Select **System > FW Update > Auto Update** or **Manual Update**.

- **Auto Update:** The system will check firmware version from AVer server and request to update.
- **Manual Update:** To update the firmware from specific location.

After updating, the camera will **reboot** and the connection will be lost. Please wait for few minutes and always keep the power cable connected. If unplugging the power during this process, it will cause damage of the device.

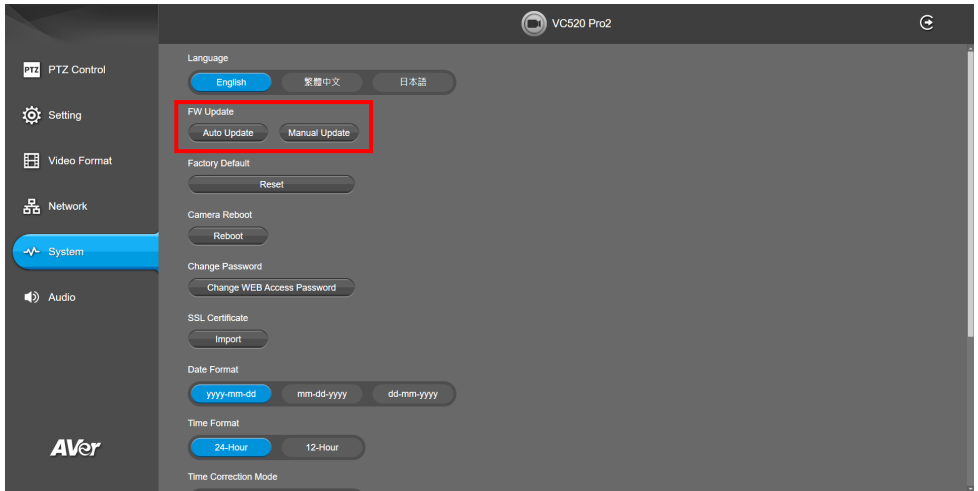

Factory Default

Reset the camera back to factory default setting.

1. Select **System > Factory Default > Reset**.
2. User can choose to keep current IP address or back to default.
3. Select **Continue** to reset back to factory default.

[Note] When factory default is activated, the password of Webpage login will not be set to default. For security concerns, to reset password of webpage access, please download PTZApp 2 to reset it.

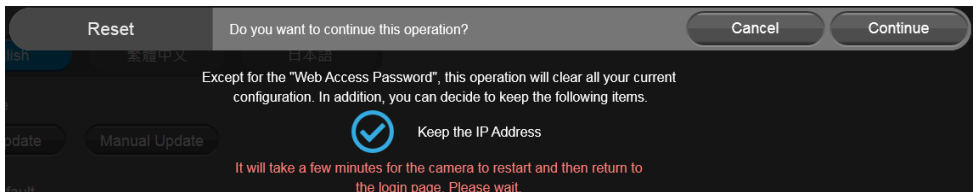
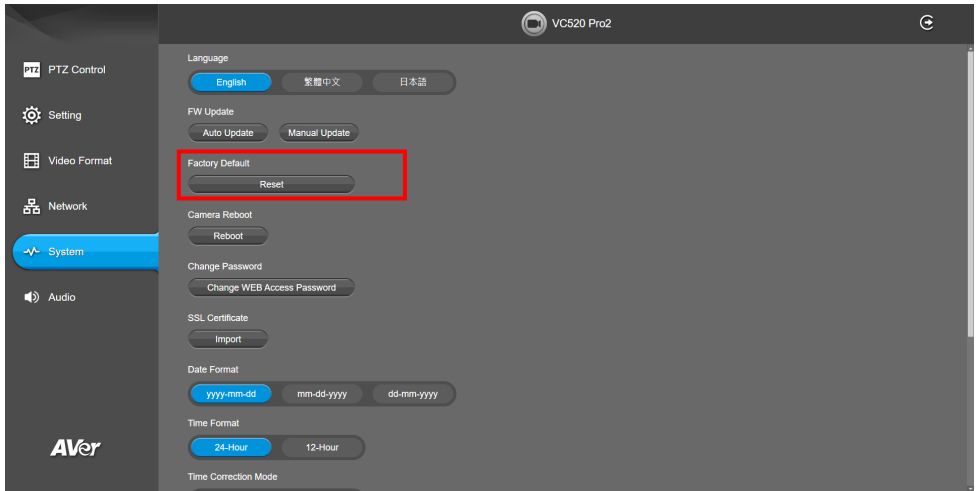

Camera Reboot

Restart the camera manually.

1. Select **System** > **Camera Reboot** > **Reboot**.
2. Select **Continue** to reboot the camera.

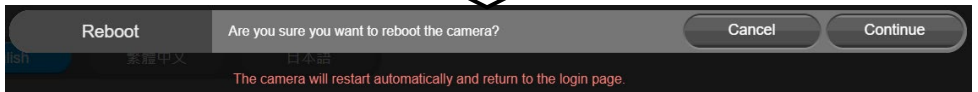
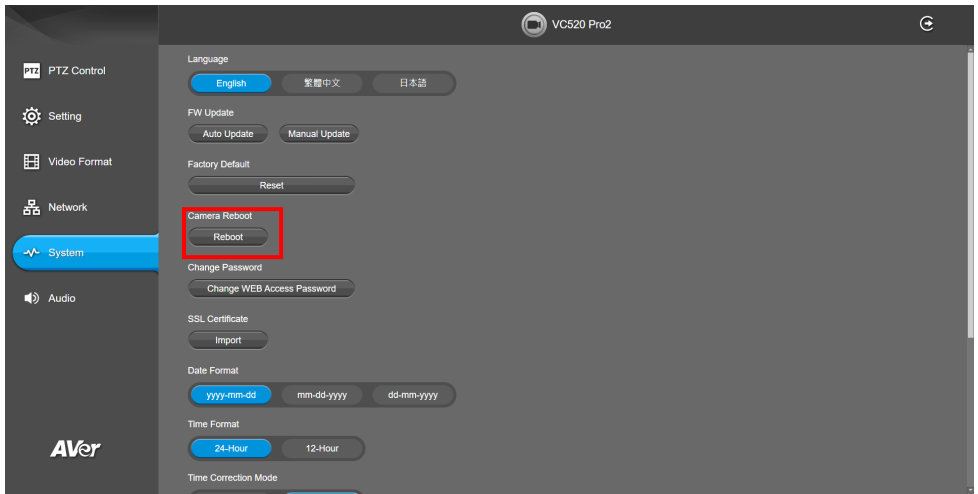

Change Password

Change the web login password. The default password is **aver4321**.

1. Select **System > Change Password > Change WEB Access Password**.
2. Enter the old account and password. Select **Continue**.
3. Enter the new account and password. Select **Continue** to save the new setting.
4. If users forget the password and want to revert back to the default password, please use PTZApp 2 to reset it.

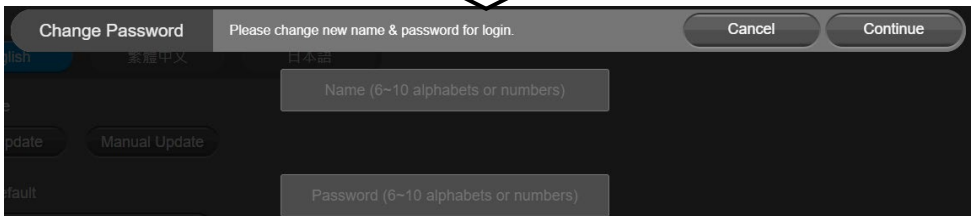
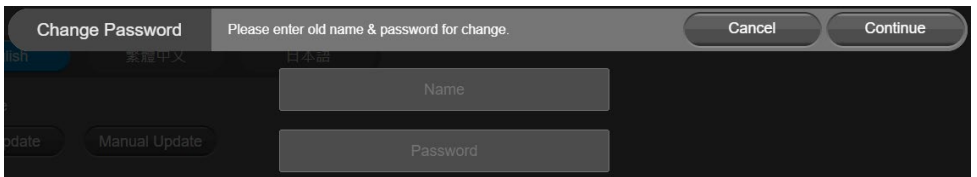
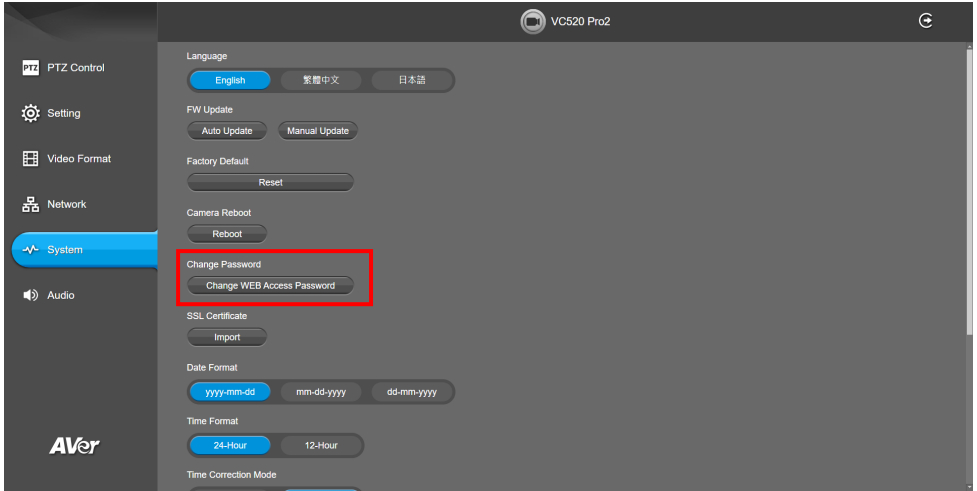

SSL Certificate

Import the SSL certificate from specific location.

1. Select **System** > **SSL Certificate** > **Import**.
2. Select the type by clicking “+”.
3. Direct the file location.
4. Select **Import**.

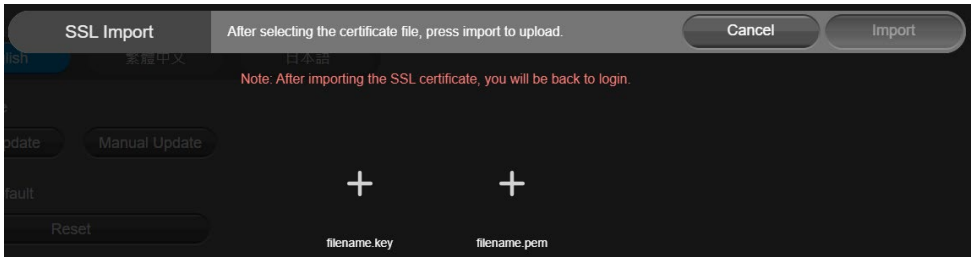
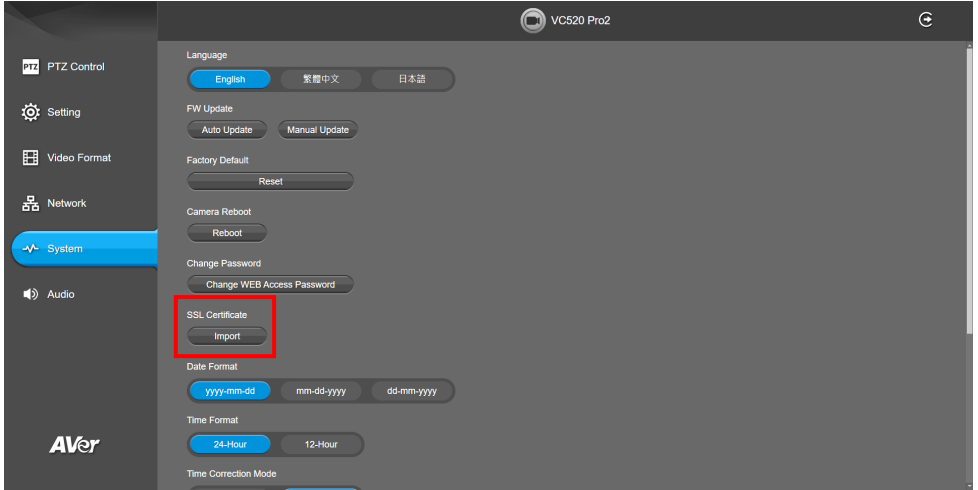

Date Format

Select the date format.

Select **System** > **Date Format** > **yyyy-mm-dd**, **mm-dd-yyyy**, or **dd-mm-yyyy**.

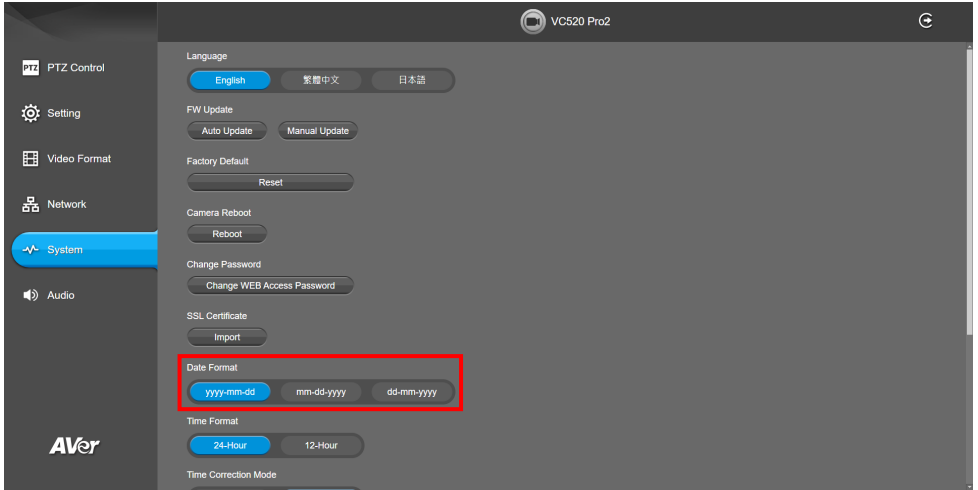

Time Format

Set up the time format.

Select **System** > **Time Format** > **24-Hour** or **12-Hour**.

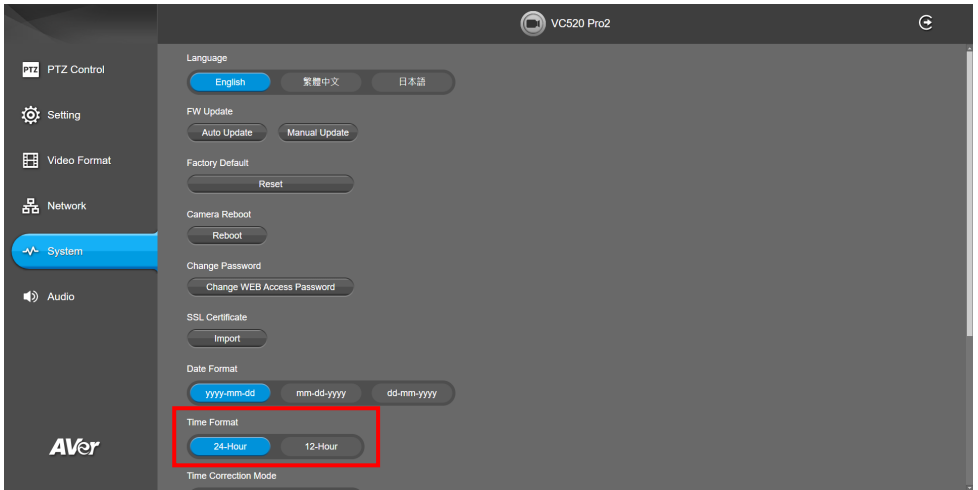

Time Correction Mode

Adjust time automatically or manually.

Select **System > Time Correction Mode > Auto** or **Manual**.

- **Auto:** The system time will be set by NTP server on the network. Click the pencil icon of NTP Server and enter the IP address of NTP server. Select the **Time Zone**. Select **NTP Update** to save setting. Select **Activate** to start auto time adjustment.

[Note] Our default NTP server is located in the USA. If this does not work in your country, please manually key in the desired NTP server.

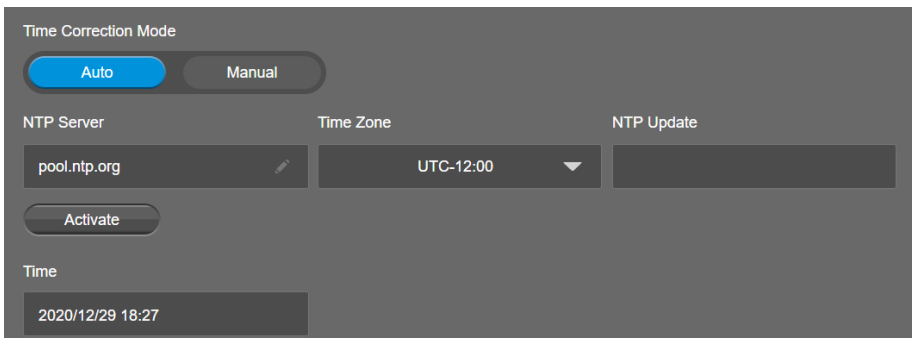
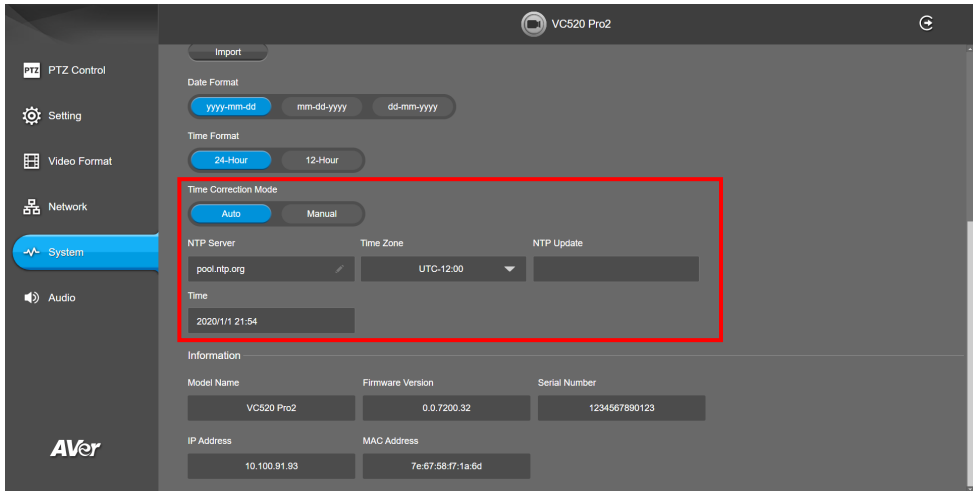

- **Manual:** User can set up time manually. Click the pencil icon and enter the **Year, Month, Day, Hour, and Minute**. Select **Confirm** to save the settings.

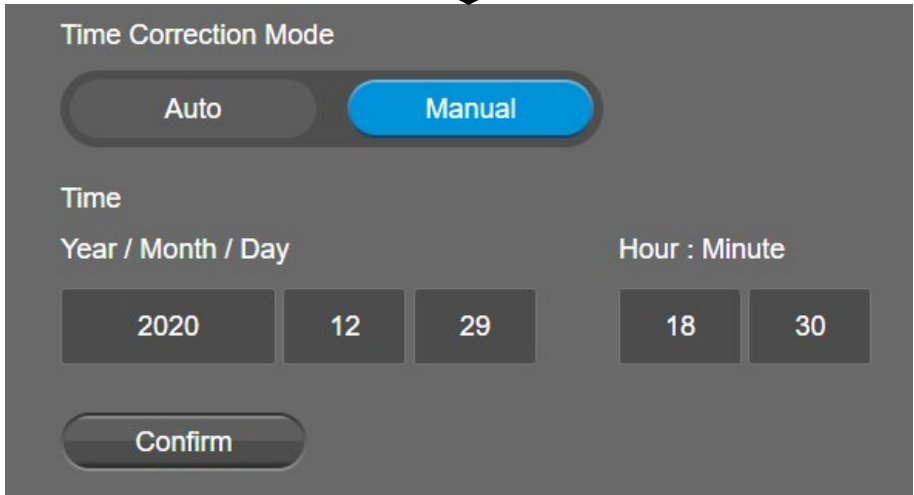
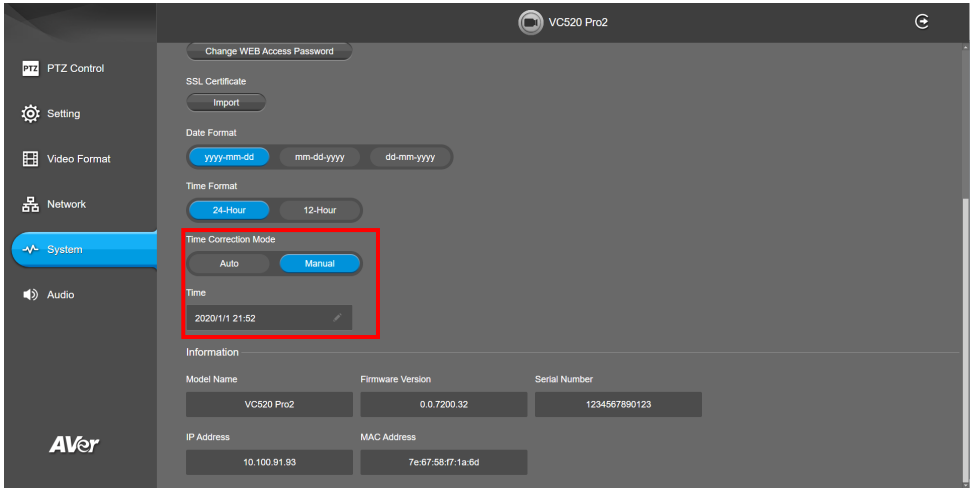

Information

Display the information of **Model Name**, **Firmware Version**, **Serial Number**, **IP Address**, and **MAC Address**.

Select **System > Information**.

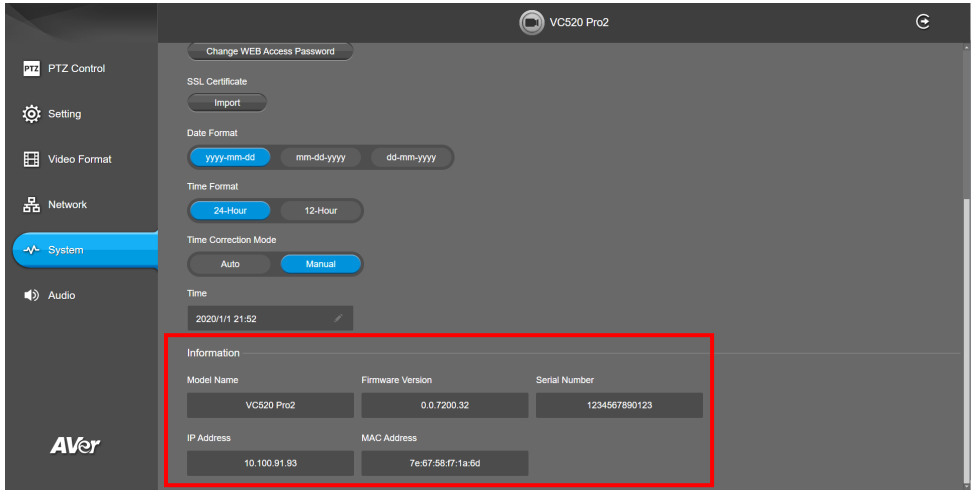

The screenshot shows the web interface for the VC520 Pro2 device. The left sidebar contains navigation options: PTZ Control, Setting, Video Format, Network, System (highlighted), and Audio. The main content area shows various system settings, including SSL Certificate, Date Format, Time Format, Time Correction Mode, and Time. A red box highlights the 'Information' section, which displays the following details:

Model Name	Firmware Version	Serial Number
VC520 Pro2	0.0.7200.32	1234567890123
IP Address	MAC Address	
10.100.91.93	7e:67:58:f7:1a:6d	

Audio Settings

Noise Suppression

It is to reduce ambient noise.

Select **Audio > Noise Suppression > Off** or **On**.

When enabling the noise suppression function, please set value of noise suppression (1~40).

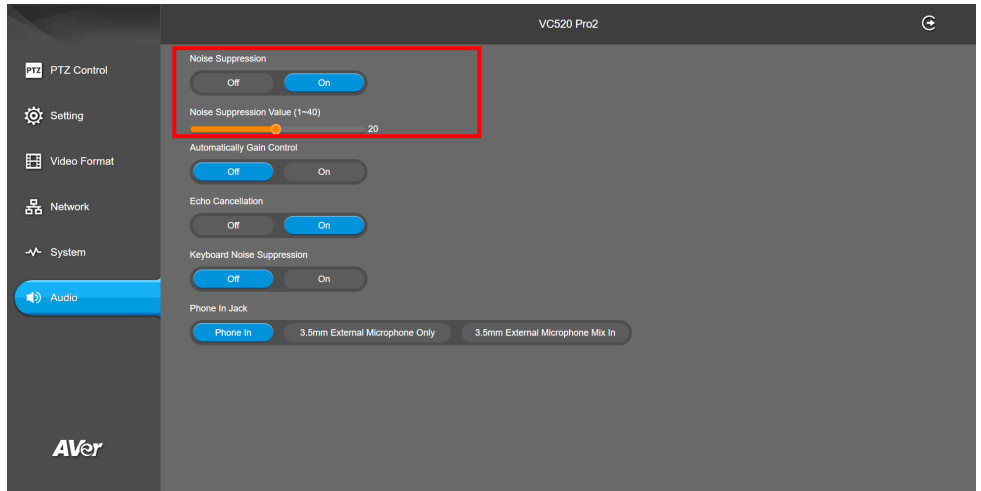

Automatically Gain Control

Enable/disable the auto gain control. It is to control ambient sound level and maintain a suitable output, despite variation of the one at the input.

Select **Audio > Automatic Gain Control > Off** or **On**.

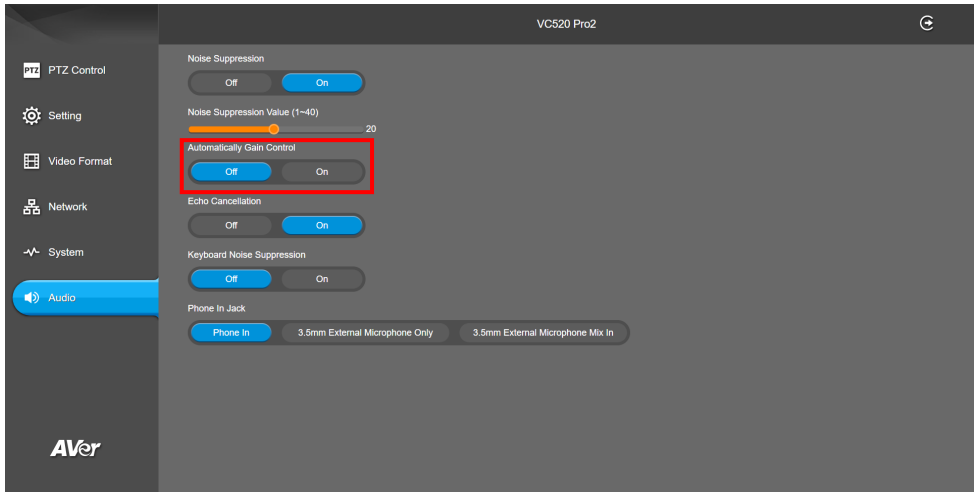

Echo Cancellation

Enable/disable echo situation.

Select **Audio > Echo Cancellation > Off** or **On**.

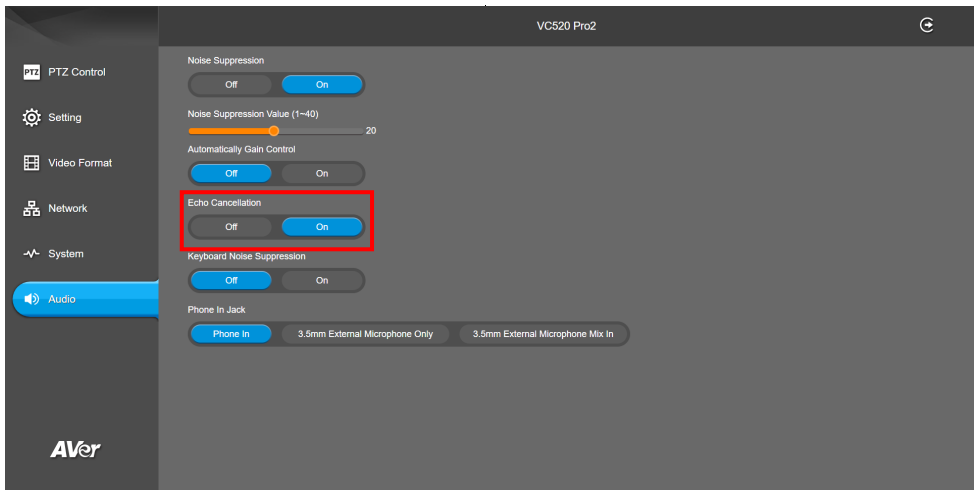

Keyboard Noise Suppression

Enable/disable keyboard noise reduction.

Select **Audio > Keyboard Noise Suppression > Off** or **On**.

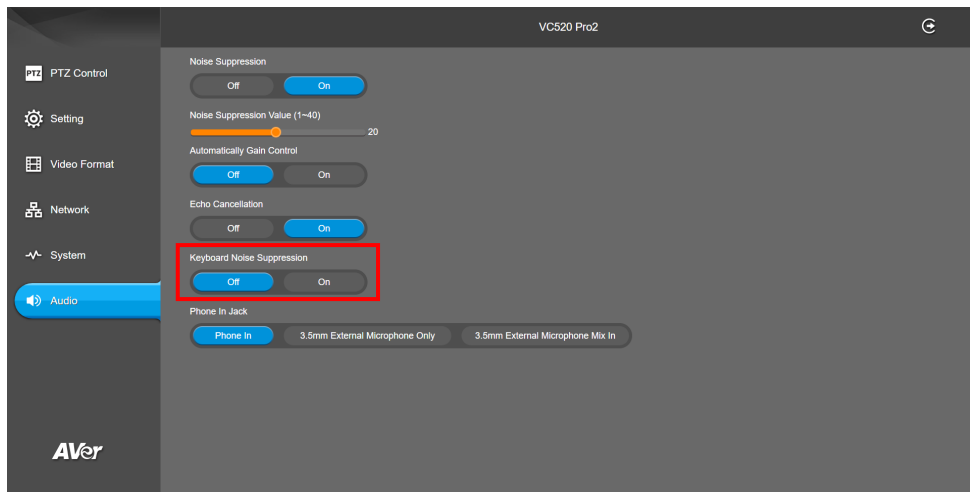

Phone In Jack

Set Phone in input source.

Select **Audio > Phone In Jack > Phone In, 3.5mm External Microphone Only, or 3.5mm External Microphone Mix In.**

- **Phone In:** When the mobile phone is connecting to Phone in port, please select “Phone In” option.
- **3.5mm External Microphone Only:** The speakerphone will transfer the sound that it receives from the external microphone (connected on phone in port) to far site.
- **3.5mm External Microphone Mix In:** The speakerphone will transfer the sound that it receives from the external microphone (connected on phone in port) and speakerphone to far site.

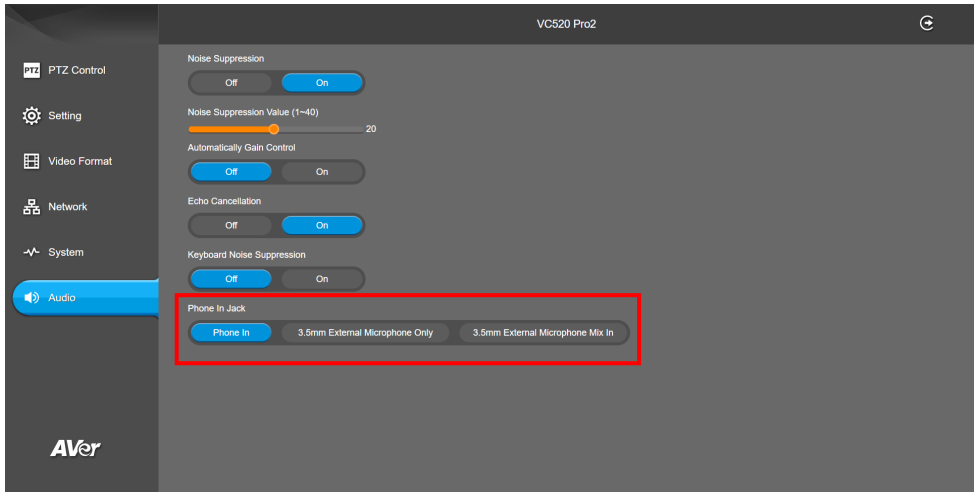

PTZApp 2

In PTZApp 2, user can change the IP address setting of VC520 Pro2, configure the parameters of the camera, set up AI tracking functions and some advanced image and audio settings, pan, tilt, and zoom the camera.

Install PTZApp 2

Please go to <https://www.aver.com/download-center> (Global & European Headquarters) or <https://www.averusa.com/business/support/> (USA) to download the PTZApp 2. After downloading, double-click on the file and follow the on-screen instructions to complete the installation. After installing the PTZApp 2, double-click on the PTZApp 2 icon to run the application.

Use PTZApp 2 with USB Devices

1. Run your video application and make a video call.
2. During your video call, you can use the PTZApp 2 to pan, tilt and zoom the camera in/out and enable/disable the true WDR, brightness, and sharpness feature.
3. Launch PTZApp 2 () and it will open in Chrome browser automatically.

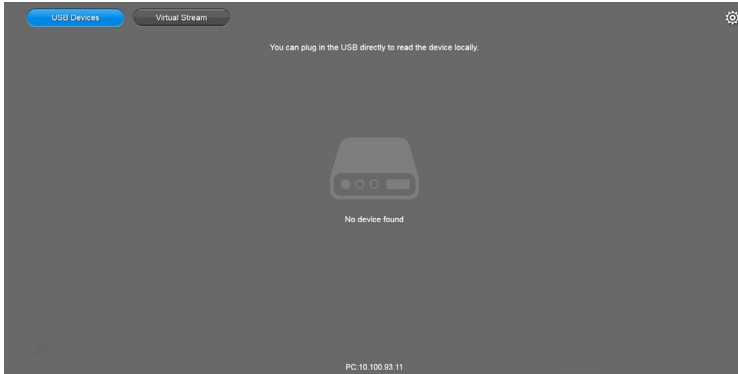

4. Choose “USB devices” and connect VC520 Pro2 to PC/laptop with USB cable. When the camera is detected, the product card will show up.



5. Set up IP address. The camera default IP address is **192.168.1.168**. Click pencil icon (✎) to edit IP address.

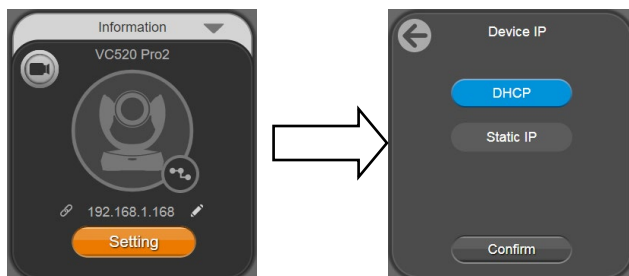

6. Click the setting icon to change Language, Hotkey Control, and Software Version.

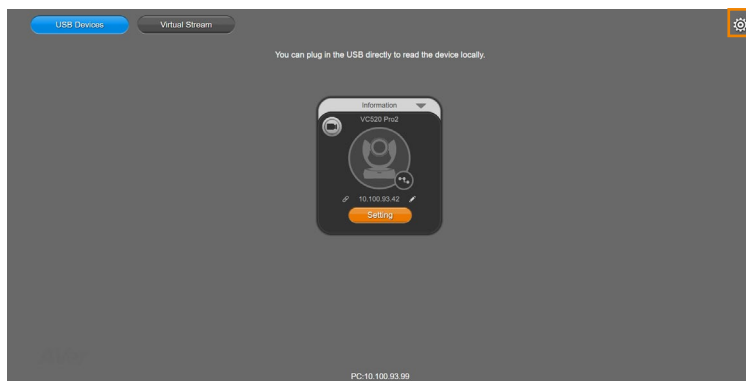

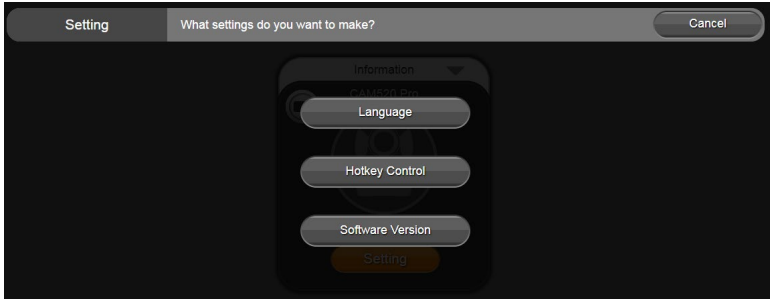

- **Language:** Select desired language and click the check icon to confirm the selection.

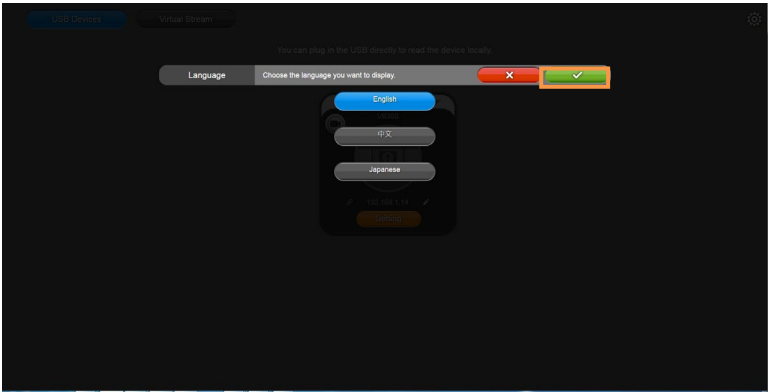

- **Hotkey Control:** User can control the camera by using keyboard. This is a general list for all Aver USB Cameras. Backlight control equals to WDR function in VC520 Pro2.

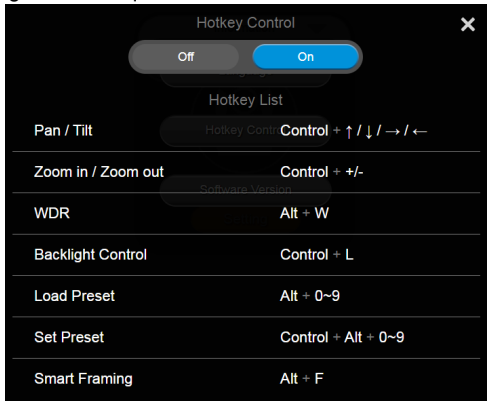

- **Software Version:** Get current PTZApp 2's version number and do auto update here.

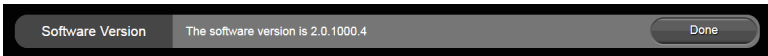



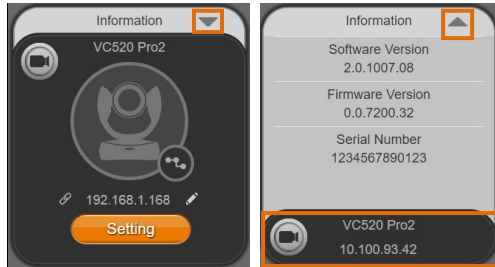

7. **Information:** Click the drop-down triangle icon to review the information of camera. To minimize the information, click the triangle or the bottom area of the information icon.



8. **Camera:** Click the camera icon to view the camera live view. IP address is displayed as well. Click the X icon to close the camera live view. If the live video did not appear, please check the camera and the laptop/PC connection to make sure all are correct and well connected. The resolution of this small live view is 640x480 resolutions.



- **Full Screen:** PTZApp 2 can switch to full screen mode. Click “ ” icon and video screen will switch to full screen mode. In full screen mode, user can use direction panel to control camera direction. Click “ ” icon to go back to normal screen view. The resolution of full screen mode is 1080p.

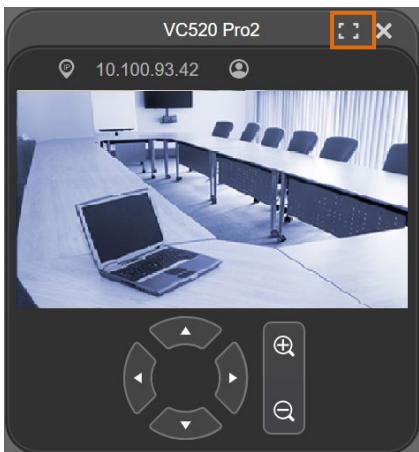

- **People Count and Stream Interval:** Click the  icon to show people count number and stream interval. Click the  or  icon to hide the stream interval.

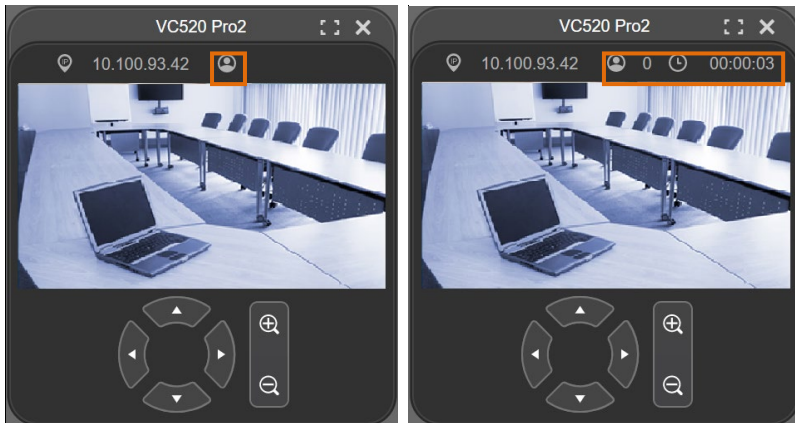

- **Control Panel:** To control the camera direction, zoom in and out, and to enable/disable the “Smart Framing” during your video call.

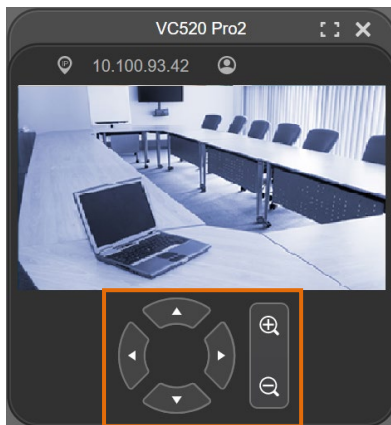

9. **Setting:** Click “**Setting**” button to setup parameters of the camera and speakerphone. Click arrow icon to leave the Setting page.

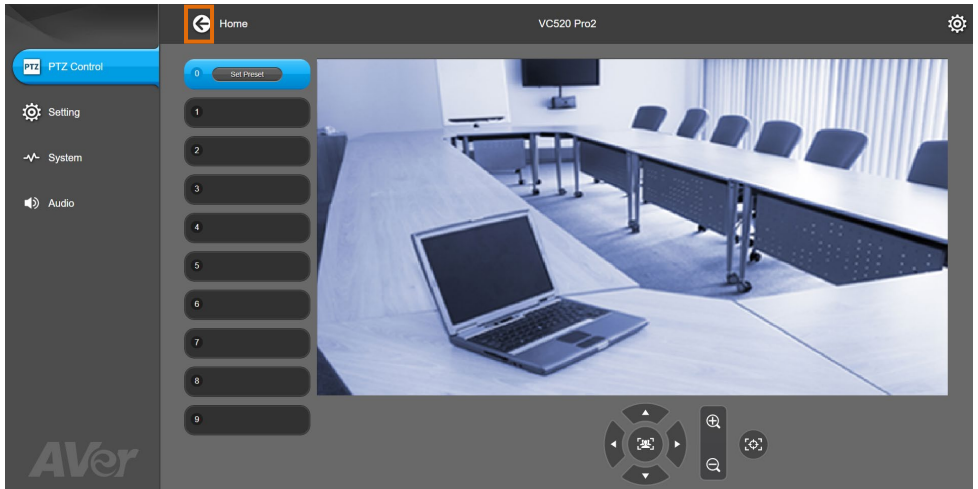
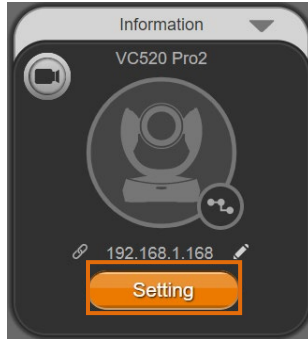

- **PTZ Control:** Use control panel to setup preset positions. Since most of operations are the same as web page, refer to [Setup the Preset](#) section (page 26) for detailed setup.
- **Setting:** To setup parameters of the camera. Since most of operations are the same as web page, refer to [Camera Settings](#) and [Image Settings](#) section (pages 27~41) for detailed setup.
- **System:** To setup system. Since most of operations are the same as web page, refer to [System Settings](#) section (pages 50~59) for detailed setup.
- **Audio:** To setup audio parameters. Since most of operations are the same as web page, refer to [Audio Settings](#) section (pages 60~63) for detailed setup.

The following items are different from web page in System.

- **I/O Port:** Except USB port, user can enable or disable all I/O ports.

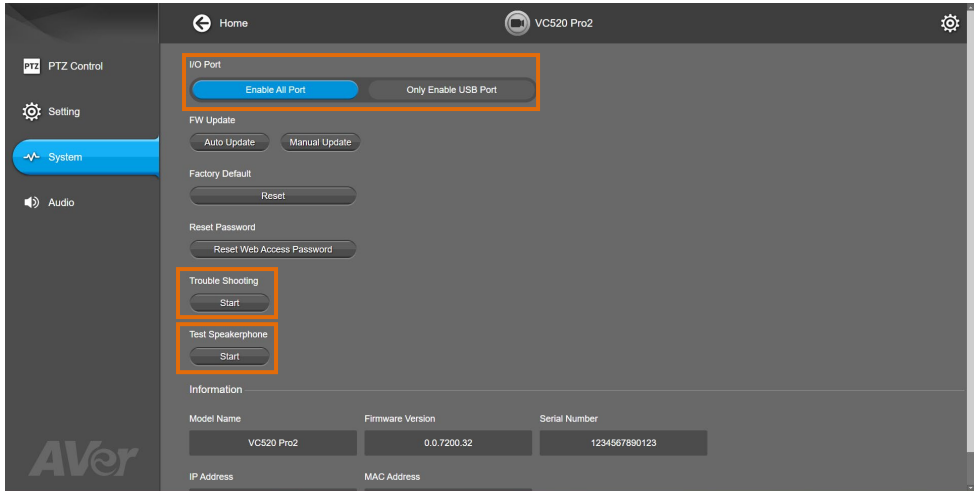

- **Trouble Shooting:** Click **Start** and **Output** to output log to save in local PC.



- **Test Speakerphone:** Click **Start** and **Start** to check the speakerphone status. It will require user to record a short message and play it back to ensure the speakerphone is working.

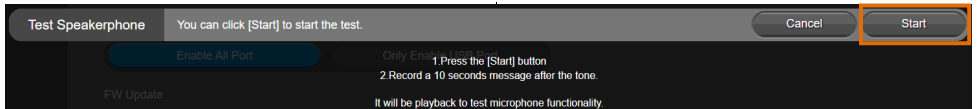

10. Click the icon to display the connected devices to the VC520 Pro2.

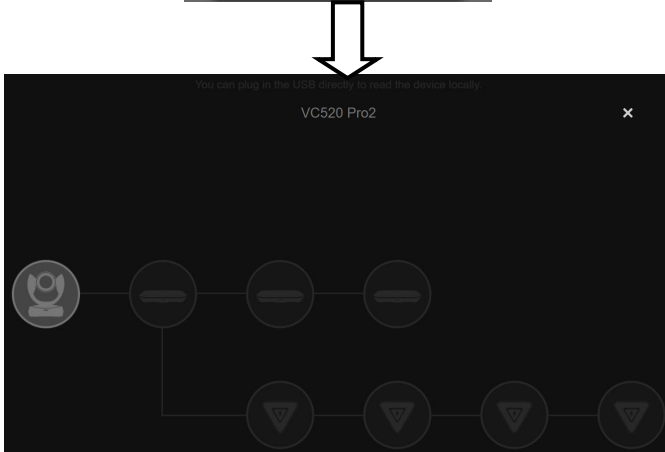

11. **PTZApp 2 Minimize:** Minimize the app to system tray. To quit the application, right-click the icon on the system tray and select **Quit**.

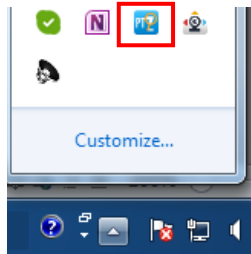

If you can't launch PTZApp 2 right after installation, please also check here and see if it is already minimized. Right-click the icon and choose Restore.

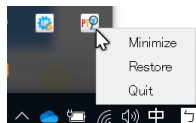

Install EZLive

Please go to <http://www.aver.com/download-center> to download the AVer EZLive software. After downloading, double-click on the file and follow the on-screen instructions to complete the installation.

Use EZLive

During a video call, EZLive can help user to do:

- (1) Camera ePTZ
- (2) Volume control for the speaker connected
- (3) Capture camera's still images
- (4) Record video
- (5) Live stream to Youtube, Livehouse.in, USTREAM...etc.
- (6) Camera Zoom in/out
- (7) Capture PC screen shot
- (8) Record PC screen video
- (9) Set up livestream
- (10) Open file management to retrieve photos and video files
- (11) Livestream setting
- (12) Drawing tool.

