

AI Outdoor Parking Management Pro Bullet Plus Camera



DATASHEET



INTRODUCTION

Milesight AI Outdoor Parking Management Pro Bullet Plus Camera delivers a complete parking management system with three detection modes: **Occupancy Detection** for large-scale space monitoring, **Parking Detection with LPR** for precise space and license plate management, and **Parking Violation Detection** to identify illegal parking. Combined with 24/7 scene adaptability, it provides an all-in-one solution for smarter, more efficient outdoor parking management.

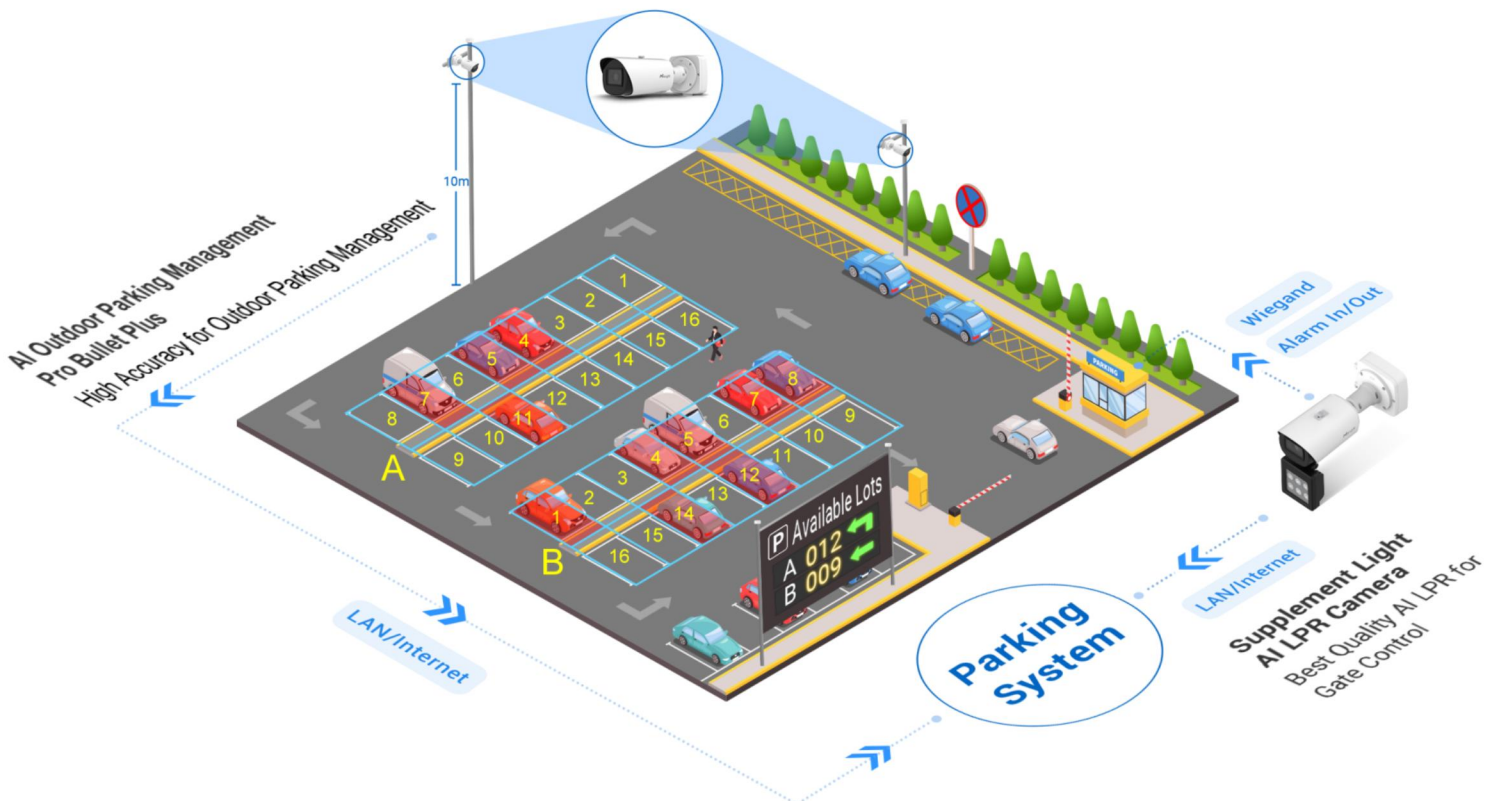

AI Outdoor Parking Management Pro Bullet Plus Camera



KEY FEATURES

Intelligent AI Parking Detection

Occupancy Detection based on AI algorithm can realize simultaneous detection and management of up to 100 parking spaces with up to 98% detection accuracy.

Parking Detection with LPR based on AI LPR algorithm can realize simultaneous detection and management of up to 6 parking spaces with LPR.

Parking Violation Detection can further identify and record illegal parking behavior.

These three parking management modes greatly help guide parking and realize more efficient and intelligent parking management.



Up to 6 Parking Spaces for Parking Detection with LPR



Up to 100 Parking Spaces for Occupancy Detection.



High Accuracy



Parking Violation Management

Excellent Scene Adaptability

With a series of cutting-edge image technologies, AI Outdoor Parking Management has excellent scene adaptability. The wide field of view of the motorized zoom lens allows for a wider monitoring range, while the 4K resolution ensures that the images are sharp enough. In addition, under the 1/1.8" STARVIS starlight sensor and image-based frame accumulation technology, it also ensures the detection of parking lots at night, providing 24/7 surveillance monitoring.

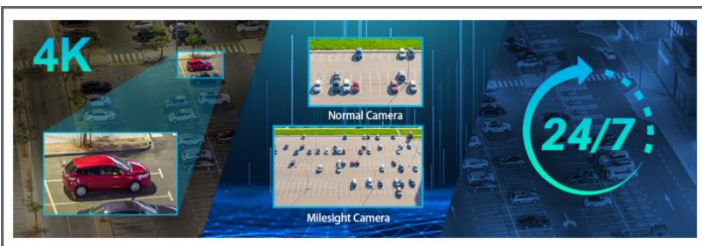

High compatibility

To maximize the usability and compatibility, the AI Outdoor Parking Management Camera supports CGI/APIs, which allows the easy open integration with third-party platforms. The network protocol such as HTTP(s) offers a wide range of options for data processing. The parking information is transmitted to the third-party parking system to help form a complete set of solutions, guide the driver to find the parking space quickly and realize intelligent management.



Unique Structure Design

The unique structure design of the camera enlarges the space and greatly saves efforts for installers, such as the integrated cable management bracket of Pro Bullet Plus Camera. And the IP67-rated weather proofing and IK10-rated vandal proofing allow to protect the camera against adverse impacts to ensure the robust performance.



Flexible Configuration

The configuration of Parking Space Detection is very flexible and convenient. Area Name, Planned Spaces of Area, Distribution and Numbering Scheme of the detection area can be customized, which provides a easy detection area configuration method and conforms to user habits. And the red overlay of the occupied parking space provides a more intuitive interface.

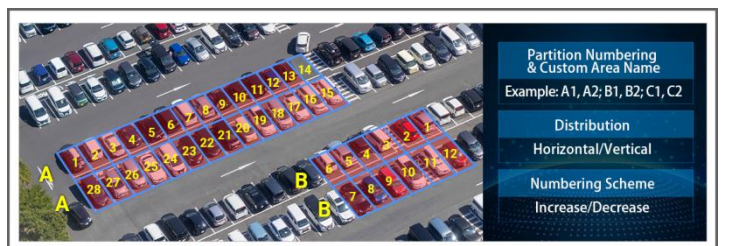

AI Outdoor Parking Management Pro Bullet Plus Camera



	Name	PMC8266-FPE (4K)
Camera	Image Sensor	1/1.8" Progressive Scan CMOS
	Min. Illumination	Color: 0.009Lux@F1.4 B/W: 0Lux with IR on
	WDR	120dB Super WDR
	Shutter Time	1/100000s~1s
	Illumination Distance	Up to 65m
	Day/Night Mode	Day/Night/Auto/Customize/Schedule
	S/N	>55dB
Parking Management	Parking Application Mode	Occupancy Detection/ Parking Detection/ Parking Violation Detection
	Parking Space Detection	Up to 6 Parking Spaces for Parking Detection with LPR; Up to 100 Parking Spaces@10m for Occupancy Detection; Up to 2 Violation Zones for Parking Violation Detection (each zone supports multiple vehicles)
	Detection Accuracy	>98%
	Data Report	Triggered Report: when parking space is occupied or released; Interval Report: regular report of entire parking situation
Lens	Lens	Motorized 3.6~10mm@F1.4
	Field of View	H116°~H48°/D134°~D55°/V65°~V27°
	Mount	Φ14
	Focus Control	Auto/Manual
Video	Max. Image Resolution	3840x2160
	Primary Stream	60Hz: 30fps@(3840x2160, 3072x2048, 2592x1944, 2592x1520, 2048x1536, 1920x1080, 1280x960, 1280x720, 704x576) 50Hz: 25fps@(3840x2160, 3072x2048, 2592x1944, 2592x1520, 2048x1536, 1920x1080, 1280x960, 1280x720, 704x576)
	Secondary Stream	60Hz: 30fps@(704x576, 640x480, 640x360, 352x288, 320x240, 320x192, 320x180) 50Hz: 25fps@(704x576, 640x480, 640x360, 352x288, 320x240, 320x192, 320x180)
	Tertiary Stream	60Hz: 30fps@(1920x1080, 1280x720, 704x576, 640x480, 640x360, 320x240, 320x192, 320x180) 50Hz: 25fps@(1920x1080, 1280x720, 704x576, 640x480, 640x360, 320x240, 320x192, 320x180)
	Video Compression	H.265*/H.265(HEVC)/H.264*/H.264/MJPEG
	Video Bit Rate	16Kbps~16Mbps(CBR/VBR Adjustable)
	Privacy Masking	Up to 28 areas(24 mask areas and 4 mosaic areas)
	ROI	Up to 8 areas
	Image Setting	Brightness/Contrast/Saturation/Sharpness

AI Outdoor Parking Management Pro Bullet Plus Camera



Interface	Ethernet	1*RJ45 10M/100M Ethernet Port
	Audio I/O	1/1
	Alarm I/O	1/1
Network	Network Storage	NAS(Support NFS, SMB/CIFS), ANR
	Protocol	IPv4/IPv6, ARP, TCP, UDP, RTP, RTSP, RTMP, HTTP, HTTPS, DNS, DDNS, DHCP, FTP, NTP, SMTP, SNMP, UPnP, Bonjour, SIP, PPPoE, VLAN, 802.1x, QoS, IGMP, ICMP, SSL
Audio	Audio Compression	G.711/AAC/G.722/G.726
	Audio Sampling Rate	8/16/32/44.1/48KHz
	Audio Bit Rate	16~256kbps
	Two-way Audio	Support
System	Storage	microSD/SDHC/SDXC Card Local Storage, up to 1TB
	Advanced Function	BLC, HLC, 2D DNR, 3D DNR, Defog, AWB, EIS, IP Address Filtering, AGC, Anti-flicker, Corridor Mode, Deblur, Watermark
	SIP/VoIP Support	Yes, Voice & Video-over-IP
	Event Trigger	Motion Detection, Network Disconnection, External Input, Audio Alarm, etc.
	Event Action	FTP Upload, SMTP Upload, SD Card Record, External Output, SIP Phone, HTTP Notification, etc.
	System Compatibility	MQTT, ONVIF Profile G & S & T, API
General	Working Temperature	-40°C~60°C
	Working Humidity	0~95%(Non-condensing)
	Power Supply	PoE (802.3af) / DC 12V±10%
	Power Consumption	Min.: 5.3W (DC 12V), 6.43W(PoE) Max.: 11.37W (DC 12V), 13.7W(PoE)
	Housing	Vandal-proof IK10-rated Metal Housing / Up to IP67-rated for Weather-resistant Performance
	Surge Protection	4KV
	Weight	1630g
	Dimensions	301mmX108mmX126mm
	Warranty	3/5 Years
Certifications	EMC	CE-EMC (EN 55032, EN 55035), FCC (PART 15B)
	Safety	CE-LVD (EN IEC 62368-1)
	Environment	CE-ROHS (Directive (EU) 2015/863 amending 2011/65/EU)



Structure Diagrams

microSD/SDHC/SDXC Card Slot

Reset

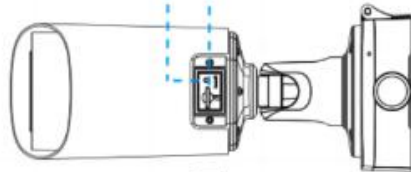

Light Sensor

IR LEDs

Lens

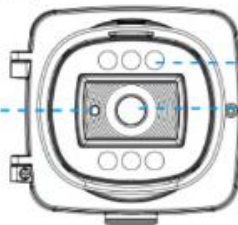

Ethernet Port(PoE)

Alarm /Audio

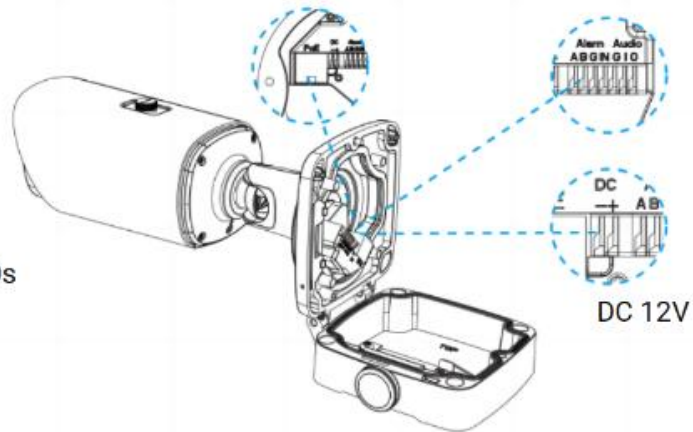

DC 12V

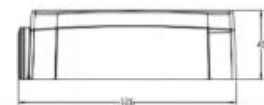
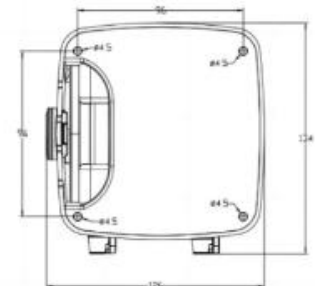
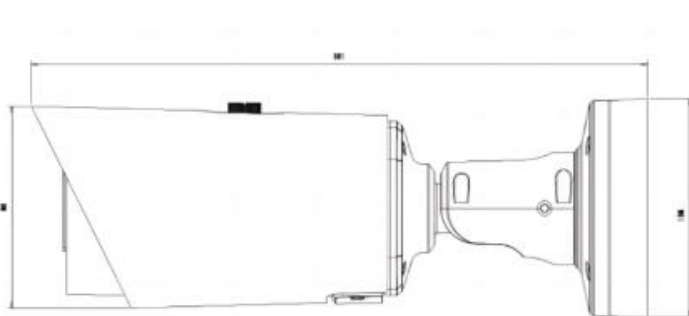

Units: mm

Accessories Support

A62 Junction Box (Default)

Weight: 510g

Dimensions: 134*126*40mm



A02 V2 Pole Mount

Weight: 1kg

Dimensions: 180*136*46mm



A03 External Corner Bracket

Weight: 900g

Dimensions: 170*152.5*76.3mm

