

K . Care, Maintenance, Storage and Transport:



WARNING!

Please follow these instructions to avoid risk of electric shock and/or short circuit.

- The product is self-service, i.e. users do not require assistance to recharge their device.
- Always disconnect the power cord from the main power outlet first.
- Do not clean the product until the unit is powered off and unplugged from the main power outlet. Once unplugged, clean using a dry or slightly damp cloth. Avoid using cleaning products and do not allow liquid to enter the device.
- Do not install in a location where a person could potentially trip on the power cord or the product.
- During care, maintenance, storage and/or transport, avoid places that are wet, humid or have a high temperature.
- Carefully read and abide by the Safety Instructions for care, maintenance, storage and transport.
- We recommend using the original packaging for transportation to protect the product from dust and humidity.

L . Note on Waste Disposal:



In according to the European WEEE directive, electrical and electronic equipment must not be disposed with consumers waste. The consumer is committed by law to deposit electrical and electronic devices to public collecting for free. Particulars are regulated in national right.

The symbol on the product, in the manual or at the packaging alludes to these terms. With this kind of application of used devices you achieve an important share to environmental protection.



ATTENTION!

Please read the user manual completely and carefully. It is part of the product and includes important information for proper installation and use. Keep this guide to have it available, hen there are uncertainties, or the product will be passed on.

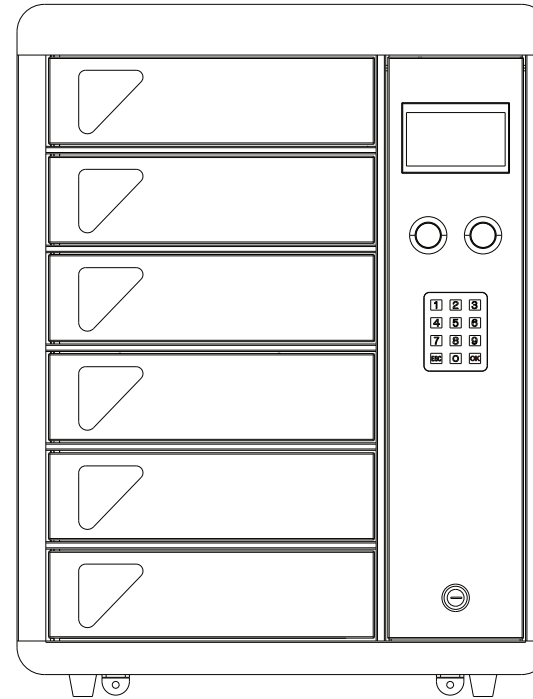

6 Bay Pin Code Charging Locker

Model: PPL6

Contents

A . Descriptions and Functions:	1
B . Intended Use:	1
C . Package Contents:	1
D . Specifications:	2
E . Warranty and Liability:	2
F . Safety Instructions:	2
G . Connect and Operate:	3
H . Replacing Charging Cables:	4
I . Operation:	5
J . Emergency:	6
K . Care, Maintenance, Storage and Transport:	7
L . Note on Waste Disposal:	7

A . Descriptions and Functions:

An innovative cell phone charging locker. Perfect for storing all valuables. It charges 6 devices simultaneously and works with all Apple, Android and other popular devices.

B . Intended Use:



This product is for indoor use only in a dry area. Do not position in any location near water. Positioning this product outside, or inside in a location near water may cause damage or injury to persons or property. Please ensure you carefully read and abide by the 'Safety Instructions'.

C . Package Contents:

- 1pc Charging Locker
- 1pc Power Cord
- 1pc User Manual
- 1pc Key
- 2pcs L-Shaped metal piece
- 4pcs Rubber-Foot
- 1set Expansion Bolt(A)
- 1set Metal Cable Clamp
- 1set Metal Cover

J . Emergency:

1 Administrative Mode

Set up of Admin Password, Press "0" "OK" "0" "OK" "0" "OK" to enter Admin Mode. LCD Displays:

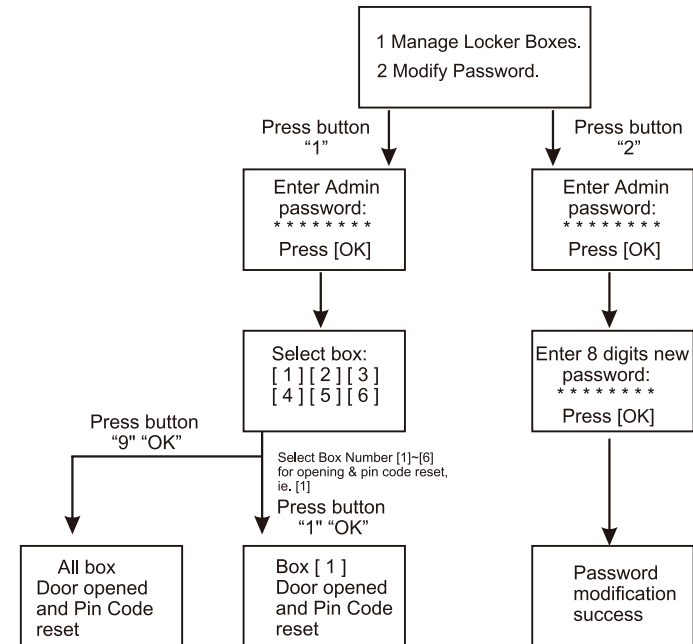

2 Reset Admin Password

Press & hold Reset button for 3 seconds to reset Admin Password to default.(#88888888)

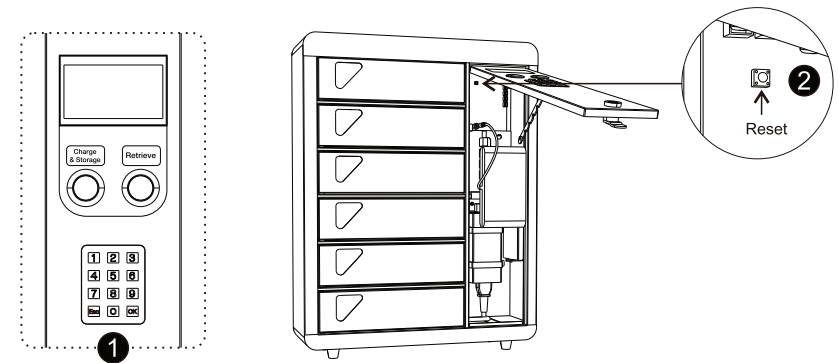

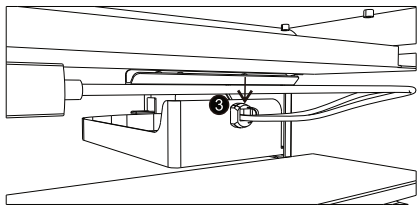

3 Open cable clamp by pushing the side piece toward inside

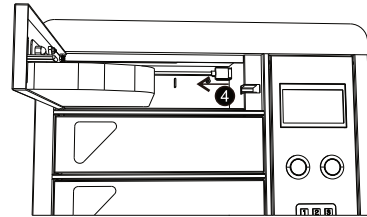

4 Replace cable.

5 Put back all removed parts and screws.

I . Operation:

How to Store or Retrieve

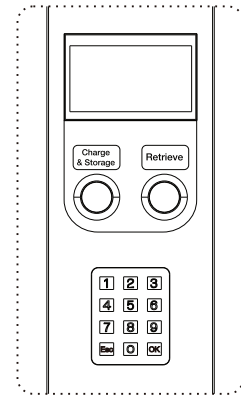
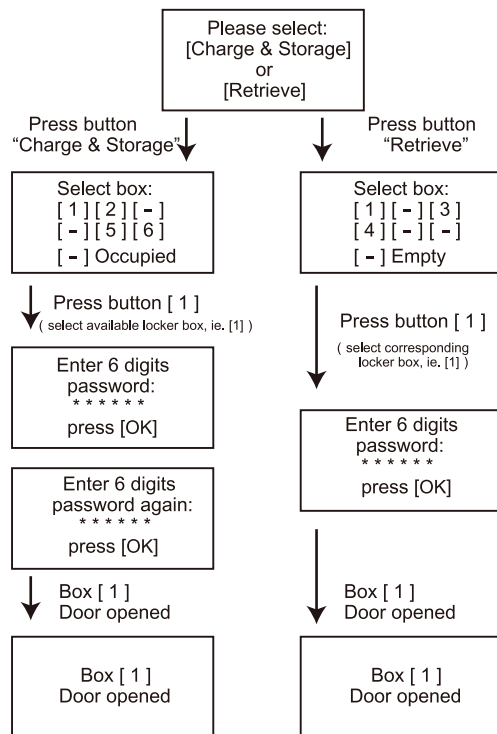

D . Specifications:

Model	PPL6
Input	100-240 Vac 60Hz
Output	Charging Cables 5.0 Vdc 2.1A x 8

E . Warranty and Liability:

- We grants a conditional 1 year warranty for this device and 6 months warranty on any consumable parts such as charging cables and batteries from the date of purchase. An extended warranty may also be purchased.
- The Warranty does not cover accidental damage or vandalism caused to the product.
- If any fault or damage is detected on your device, please contact us for troubleshooting. If the issue cannot be resolved remotely, we may request the product be shipped to the our office, at the customer's expense, to verify the fault or damage, along with a copy of the original purchase invoice.
- We are not liable for damage to persons or property caused by improper installation or operation not described in this guide. Any alteration and/or modification of the product or its accessories immediately voids the warranty.
- Any use other than described in this user manual is not permitted, And causes loss of warranty, loss of guarantee, and non-liability.
- We reserve our right for misprints and changes of the device, packing or user manual.

F . Safety Instructions:



ATTENTION!

We recommend a skilled electrician is used to assemble and disassemble the housing of the product to avoid risk of electric shock or electrical damage to the product.

- This product is not a toy and should not be used by children at any time. It contains small parts which can be swallowed and cause serious injury.
- Ensure the product is assembled and installed in a way that prevents a person tripping over the power cable or the unit falling from its location.
- Please ensure the packing materials are disposed off completely to prevent injury to children (such as box cuts or swallowing insulation materials).
- Do not install in an area with high temperature, high humidity or areas where the charging station may come into contact with water.
- Do not install near air conditioners, or in areas with excessive dust, smoke or vibration.
- Do not modify or alter the product in any way. Any unauthorized modification or alteration will immediately void the Warranty.
- Do not use the product, or any parts, if they are damaged.
- All cables and adaptors should be connected and disconnected slowly and carefully.
- Ensure suitable packaging for transport of the product based on its 'Specifications'.

