

# User Guide

## ZenWiFi ET9

**AXE7800 Tri Band Router**



E23356

First Edition

April 2024

**Copyright © 2024 ASUSTeK Computer Inc. All Rights Reserved.**

No part of this manual, including the products and software described in it, may be reproduced, transmitted, transcribed, stored in a retrieval system, or translated into any language in any form or by any means, except documentation kept by the purchaser for backup purposes, without the express written permission of ASUSTeK Computer Inc. ("ASUS").

Product warranty or service will not be extended if: (1) the product is repaired, modified or altered, unless such repair, modification or alteration is authorized in writing by ASUS; or (2) the serial number of the product is defaced or missing.

ASUS PROVIDES THIS MANUAL "AS IS" WITHOUT WARRANTY OF ANY KIND, EITHER EXPRESS OR IMPLIED, INCLUDING BUT NOT LIMITED TO THE IMPLIED WARRANTIES OR CONDITIONS OF MERCHANTABILITY OR FITNESS FOR A PARTICULAR PURPOSE. IN NO EVENT SHALL ASUS, ITS DIRECTORS, OFFICERS, EMPLOYEES OR AGENTS BE LIABLE FOR ANY INDIRECT, SPECIAL, INCIDENTAL, OR CONSEQUENTIAL DAMAGES (INCLUDING DAMAGES FOR LOSS OF PROFITS, LOSS OF BUSINESS, LOSS OF USE OR DATA, INTERRUPTION OF BUSINESS AND THE LIKE), EVEN IF ASUS HAS BEEN ADVISED OF THE POSSIBILITY OF SUCH DAMAGES ARISING FROM ANY DEFECT OR ERROR IN THIS MANUAL OR PRODUCT.

SPECIFICATIONS AND INFORMATION CONTAINED IN THIS MANUAL ARE FURNISHED FOR INFORMATIONAL USE ONLY, AND ARE SUBJECT TO CHANGE AT ANY TIME WITHOUT NOTICE, AND SHOULD NOT BE CONSTRUED AS A COMMITMENT BY ASUS. ASUS ASSUMES NO RESPONSIBILITY OR LIABILITY FOR ANY ERRORS OR INACCURACIES THAT MAY APPEAR IN THIS MANUAL, INCLUDING THE PRODUCTS AND SOFTWARE DESCRIBED IN IT.

Products and corporate names appearing in this manual may or may not be registered trademarks or copyrights of their respective companies, and are used only for identification or explanation and to the owners' benefit, without intent to infringe.

# Table of contents

<b>1</b>	<b>Getting to know your wireless router</b>	
1.1	Welcome!.....	6
1.2	Package contents .....	6
1.3	Your wireless router .....	7
1.4	Positioning your wireless router .....	8
1.5	Setup Requirements.....	9
<b>2</b>	<b>Getting started</b>	
2.1	Router Setup .....	10
	A.    Wired connection.....	11
	B.    Wireless connection .....	12
2.2	Quick Internet Setup (QIS) with Auto-detection.....	14
2.3	Connecting to your wireless network.....	16
<b>3</b>	<b>Configuring the General and Advanced settings</b>	
3.1	Logging into the Web GUI.....	17
	3.1.1    Setting up the wireless security settings.....	19
	3.1.2    Managing your network clients.....	20
	3.1.3    Monitoring your USB device .....	21
3.2	Adaptive QoS.....	24
	3.2.1    Managing QoS (Quality of Service) Bandwidth.....	24
3.3	Administration.....	27
	3.3.1    Operation Mode .....	27
	3.3.2    System.....	28
	3.3.3    Firmware Upgrade .....	29
	3.3.4    Restore/Save/Upload Setting .....	29
3.4	AiCloud 2.0.....	30
	3.4.1    Cloud Disk.....	31
	3.4.2    Smart Access.....	32
	3.4.3    AiCloud Sync.....	33

## Table of contents

<b>3.5</b>	<b>AiProtection</b> .....	<b>34</b>
3.5.1	Network Protection .....	34
3.5.2	Setting up Parental Controls.....	38
<b>3.6</b>	<b>Firewall</b> .....	<b>41</b>
3.6.1	General.....	41
3.6.2	URL Filter .....	42
3.6.3	Keyword filter .....	43
3.6.4	Network Services Filter .....	44
<b>3.7</b>	<b>Guest Network</b> .....	<b>46</b>
<b>3.8</b>	<b>IPv6</b> .....	<b>48</b>
<b>3.9</b>	<b>LAN</b> .....	<b>49</b>
3.9.1	LAN IP .....	49
3.9.2	DHCP Server.....	50
3.9.3	Route .....	52
3.9.4	IPTV .....	53
<b>3.10</b>	<b>System Log</b> .....	<b>54</b>
<b>3.11</b>	<b>Traffic Analyzer</b> .....	<b>55</b>
<b>3.12</b>	<b>USB Application</b> .....	<b>56</b>
3.12.1	Using AiDisk .....	57
3.12.2	Using Servers Center.....	59
3.12.3	3G/4G .....	64
<b>3.13</b>	<b>WAN</b> .....	<b>66</b>
3.13.1	Internet Connection.....	66
3.13.2	Dual WAN .....	69
3.13.3	Port Trigger.....	70
3.13.4	Virtual Server/Port Forwarding.....	72
3.13.5	DMZ.....	75
3.13.6	DDNS .....	76
3.13.7	NAT Passthrough .....	77

# Table of contents

3.14	Wireless .....	78
3.14.1	General.....	78
3.14.2	WPS .....	81
3.14.3	Bridge .....	83
3.14.4	Wireless MAC Filter .....	85
3.14.5	RADIUS Setting .....	86
3.14.6	Professional .....	87
<b>4</b>	<b>Utilities</b>	
4.1	Device Discovery .....	90
4.2	Firmware Restoration.....	91
4.3	Setting up your printer server .....	93
4.3.1	ASUS EZ Printer Sharing .....	93
4.3.2	Using LPR to Share Printer .....	97
4.4	Download Master .....	102
4.4.1	Configuring Bit Torrent download settings.....	103
4.4.2	NZB settings.....	104
<b>5</b>	<b>Troubleshooting</b>	
5.1	Basic Troubleshooting .....	105
5.2	Frequently Asked Questions (FAQs) .....	108
	<b>Appendices</b>	
	Safety Notices .....	126
	Service and Support.....	128

# 1 Getting to know your wireless router

## 1.1 Welcome!

Thank you for purchasing an ASUS ZenWiFi ET9 Wireless Router! The stylish ZenWiFi ET9 features a 2.4GHz, 5GHz and 6GHz tri bands for an unmatched concurrent wireless HD streaming; SMB server, UPnP AV server, and FTP server for 24/7 file sharing; a capability to handle 300,000 sessions; and the ASUS Green Network Technology, which provides up to 70% power-saving solution.

## 1.2 Package contents

- |   |   |
|---|---|
| <input checked="" type="checkbox"/> ZenWiFi ET9 Wireless Router | <input checked="" type="checkbox"/> Network cable (RJ-45) |
| <input checked="" type="checkbox"/> Power adapter               | <input checked="" type="checkbox"/> Quick Start Guide     |
| <input checked="" type="checkbox"/> Warranty card               |   |

---

### NOTES:

- If any of the items are damaged or missing, contact ASUS for technical inquiries and support. Refer to **Service and Support** at the back of this user manual.
  - Keep the original packaging material in case you would need future warranty services such as repair or replacement.
-

# 1.3 Your wireless router

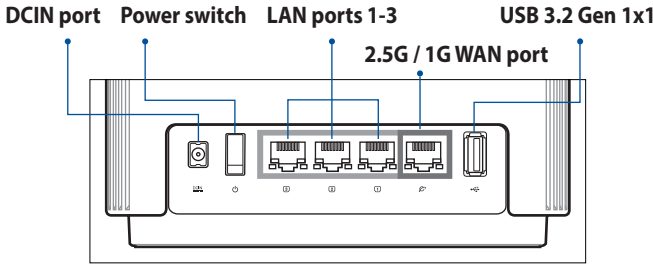

### 2.5G / 1G WAN port

Connect your optical modem to this port with a network cable.

### LAN ports 1-3

Connect your PC to a LAN port with a network cable.

## LED indications during the process of using 160MHz for the backhaul connection

The process starts one minute after the node has connected to the main router with a strong backhaul connection. During this process, the LED indicator of the router keeps static green. The network is currently available for connection, but the performance might be limited.

Step	Router status	Router LED	Time length
1	Checking connection strength	Static green	1 minute
2	Monitoring radar signal	Static green	1 minute (Obey FCC Regulations) 10 minutes (Obey CE Regulations)
3	Using 160MHz for the backhaul connection	Static white	

## Specifications:

<b>DC Power adapter</b>	DC Output: +12V with max 3A current		
<b>Operating Temperature</b>	0~40°C	Storage	0~70°C
<b>Operating Humidity</b>	50~90%	Storage	20~90%

## 1.4 Positioning your wireless router

For optimal wireless transmission between the wireless router and connected wireless devices, ensure that you:

- Place the wireless router in a centralized area for a maximum wireless coverage for the network devices.
- Keep the wireless router away from metal obstructions and away from direct sunlight.
- Keep the wireless router away from 802.11g or 20MHz only Wi-Fi devices, 2.4GHz computer peripherals, Bluetooth devices, cordless phones, transformers, heavy-duty motors, fluorescent lights, microwave ovens, refrigerators, and other industrial equipment to prevent signal interference or loss.
- Always update to the latest firmware. Visit the ASUS website at [\*\*http://www.asus.com\*\*](http://www.asus.com) to get the latest firmware updates.

## 1.5 Setup Requirements

To set up your wireless network, you need a computer that meets the following system requirements:

- Ethernet RJ-45 (LAN) port (10Base-T/100Base-TX/1000BaseTX)
- IEEE 802.11a/b/g/n/ac/ax wireless capability
- An installed TCP/IP service
- Web browser such as Internet Explorer, Firefox, Safari, or Google Chrome

---

### NOTES:

- If your computer does not have built-in wireless capabilities, you may install an IEEE 802.11a/b/g/n/ac/ax WLAN adapter to your computer to connect to the network.
- With its tri band technology, your wireless router supports 2.4GHz, 5GHz and 6GHz wireless signals simultaneously. This allows you to do Internet-related activities such as Internet surfing or reading/writing e-mail messages using the 2.4GHz band while simultaneously streaming high-definition audio/video files such as movies or music using the 5GHz band.
- Some IEEE 802.11n devices that you want to connect to your network may or may not support 5GHz band. Refer to the device's manual for specifications.
- The Ethernet RJ-45 cables that will be used to connect the network devices should not exceed 100 meters.

---

### IMPORTANT!

- Some wireless adapters might have connectivity issues to 802.11ax WiFi APs.
- If you're experiencing such issue, please ensure you update the driver to the latest version. Check your manufacturer's official support site where software drivers, updates, and other related information can be obtained.
  - Realtek: <https://www.realtek.com/en/downloads>
  - Mediatek: <https://www.mediatek.com/products/connectivity-and-networking/broadband-wifi>
  - Intel: <https://downloadcenter.intel.com/>

## 2 Getting started

### 2.1 Router Setup

---

#### **IMPORTANT!**

- Use a wired connection when setting up your wireless router to avoid possible setup problems.
  - Before setting up your ASUS wireless router, do the following:
    - If you are replacing an existing router, disconnect it from your network.
    - Disconnect the cables/wires from your existing modem setup. If your modem has a backup battery, remove it as well.
    - Reboot your cable modem and computer (recommended).
- 



#### **WARNING!**

- The power supply cord(s) must be plugged into socket-outlet(s) that is /are provided with a suitable earth ground. Connect the equipment only to a nearby socket outlet that is easily accessible.
  - If the Adapter is broken, do not try to fix it by yourself. Contact a qualified service technician or your retailer.
  - DO NOT use damaged power cords, accessories, or other peripherals.
  - DO NOT mount this equipment higher than 2 meters.
  - Use this product in environments with ambient temperatures between 0°C (32°F) and 40°C (104°F).
- 

1. Insert your wireless router's AC adapter to the DCIN port.
2. Using the bundled network cable, connect your modem to your wireless router's WAN port.
3. Insert your modem's AC adapter to the DCIN port.

## A. Wired connection

**NOTE:** You can use either a straight-through cable or a crossover cable for wired connection.

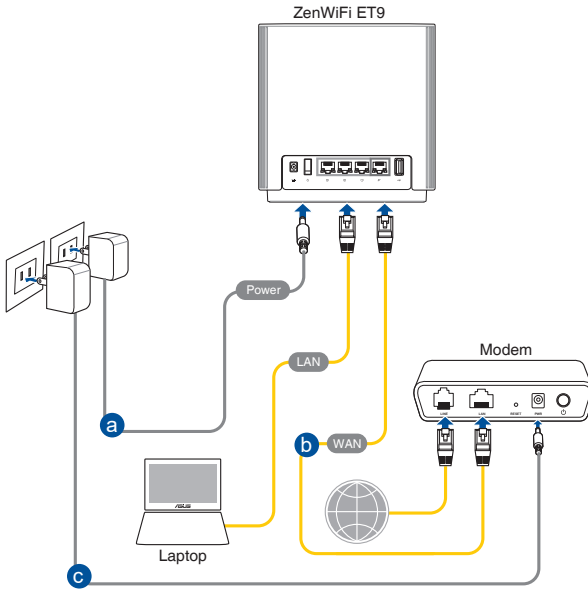

### To set up your wireless router via wired connection:

1. Power on your router and use a network cable to connect your computer to your wireless router's LAN port.
2. The web GUI launches automatically when you open a web browser. If it does not auto-launch, enter <http://www.asusrouter.com>
3. Set up a password for your router to prevent unauthorized access.

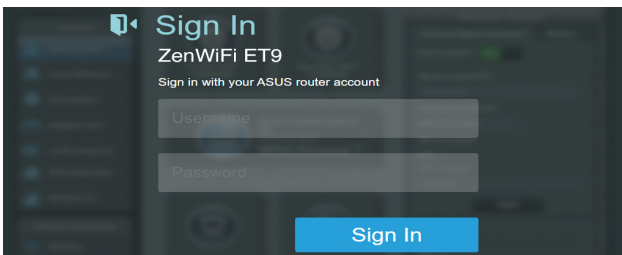

## B. Wireless connection

### To set up your wireless router via wireless connection:

1. Plug your router into a power outlet and power it on.

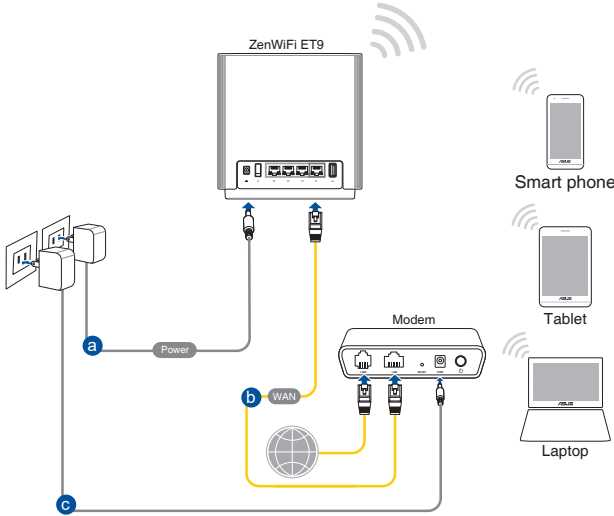

2. Connect to the network name (SSID) shown on the product label on the back side of the router. For better network security, change to a unique SSID and assign a password.

Wi-Fi Name (SSID): ASUS\_XX

\* **XX** refers to the last two digits of 2.4GHz MAC address. You can find it on the label on the back of your router.

3. Once connected, the web GUI launches automatically when you open a web browser. If it does not auto-launch, enter <http://www.asusrouter.com>.
4. Set up a password for your router to prevent unauthorized access.

---

## NOTES:

- For details on connecting to a wireless network, refer to the WLAN adapter's user manual.
  - To set up the security settings for your network, refer to **3.1.1 Setting up the wireless security settings** of this user manual.
- 

**Login Information Setup**

Change the router password to prevent unauthorized access to your ASUS wireless router.

Router Login Name	<input type="text" value="admin"/>
New Password	<input type="password"/>
Retype Password	<input type="password"/> <input type="checkbox"/> Show password

## 2.2 Quick Internet Setup (QIS) with Auto-detection

The Quick Internet Setup (QIS) function guides you in quickly setting up your Internet connection.

---

**NOTE:** When setting the Internet connection for the first time, press the Reset button on your wireless router to reset it to its factory default settings.

---

### To use QIS with auto-detection:

1. Launch a web browser. You will be redirected to the ASUS Setup Wizard (Quick Internet Setup). If not, key in <http://www.asusrouter.com> manually.

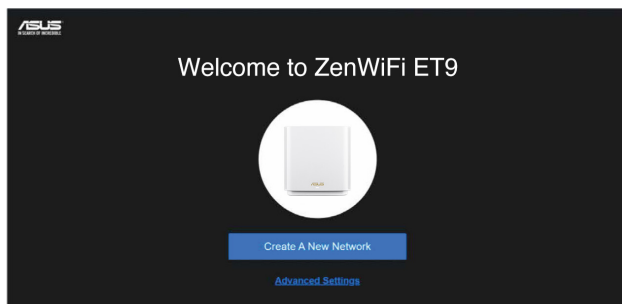

2. The wireless router automatically detects if your ISP connection type is **Dynamic IP, PPPoE, PPTP** and **L2TP**. Key in the necessary information for your ISP connection type.

---

**IMPORTANT!** Obtain the necessary information from your ISP about the Internet connection type.

---

### NOTES:

- The auto-detection of your ISP connection type takes place when you configure the wireless router for the first time or when your wireless router is reset to its default settings.
  - If QIS failed to detect your Internet connection type, click **Manual Setting** and manually configure your connection settings.
-

3. Assign the wireless network name (SSID) and security key for your 2.4GHz, 5GHz and 6GHz wireless connection. Click **Apply** when done.

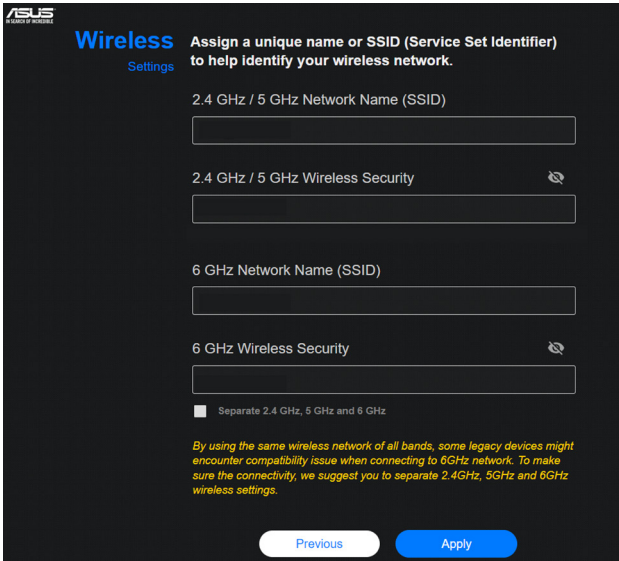

The image shows the 'Wireless Settings' page on an ASUS router. The page title is 'Wireless Settings' with a sub-header 'Assign a unique name or SSID (Service Set Identifier) to help identify your wireless network.' There are four input fields: '2.4 GHz / 5 GHz Network Name (SSID)', '2.4 GHz / 5 GHz Wireless Security', '6 GHz Network Name (SSID)', and '6 GHz Wireless Security'. Below these fields is a checkbox labeled 'Separate 2.4 GHz, 5 GHz and 6 GHz'. A yellow warning message states: 'By using the same wireless network of all bands, some legacy devices might encounter compatibility issue when connecting to 6GHz network. To make sure the connectivity, we suggest you to separate 2.4GHz, 5GHz and 6GHz wireless settings.' At the bottom, there are two buttons: 'Previous' and 'Apply'.

4. On the **Login Information Setup** page, change the router's login password to prevent unauthorized access to your wireless router.

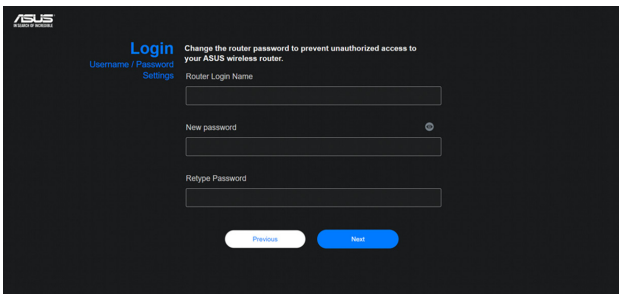



The image shows the 'Login Information Setup' page on an ASUS router. The page title is 'Login Information Setup' with a sub-header 'Change the router password to prevent unauthorized access to your ASUS wireless router.' There are three input fields: 'Router Login Name', 'New password', and 'Retype Password'. At the bottom, there are two buttons: 'Previous' and 'Next'.

**NOTE:** The wireless router's login username and password is different from the 2.4GHz, 5GHz and 6GHz network name (SSID) and security key. The wireless router's login username and password allows you to log into your wireless router's Web GUI to configure your wireless router's settings. The 2.4GHz, 5GHz and 6GHz network name (SSID) and security key allows Wi-Fi devices to log in and connect to your 2.4GHz, 5GHz and 6GHz network.

## 2.3 Connecting to your wireless network

After setting up your wireless router via QIS, you can connect your computer or other smart devices to your wireless network.

### To connect to your network:

1. On your computer, click the network icon  in the notification area to display the available wireless networks.
2. Select the wireless network that you want to connect to, then click **Connect**.
3. You may need to key in the network security key for a secured wireless network, then click **OK**.
4. Wait while your computer establishes connection to the wireless network successfully. The connection status is displayed and the network icon displays the connected  status.

---

### NOTES:

- Refer to the next chapters for more details on configuring your wireless network's settings.
  - Refer to your device's user manual for more details on connecting it to your wireless network.
-

## 3 Configuring the General and Advanced settings

### 3.1 Logging into the Web GUI

Your ASUS Wireless Router comes with an intuitive web graphical user interface (GUI) that allows you to easily configure its various features through a web browser such as Internet Explorer, Firefox, Safari, or Google Chrome.

---

**NOTE:** The features may vary with different firmware versions.

---

#### To log into the web GUI:

1. On your web browser, manually key in the wireless router's default IP address: <http://www.asusrouter.com>.
2. On the login page, key in the user name and password that you have set in **2.2 Quick Internet Setup (QIS) with Auto-detection**.

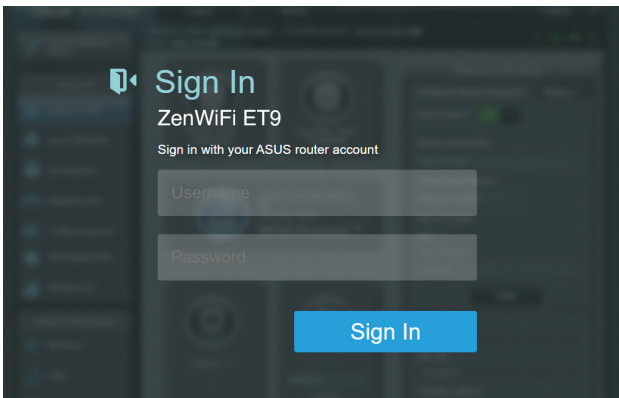

3. You can now use the Web GUI to configure various settings of your ASUS Wireless Router.



\* The image is for reference only.

**NOTE:** If you are logging into the Web GUI for the first time, you will be directed to the Quick Internet Setup (QIS) page automatically.

### 3.1.1 Setting up the wireless security settings

To protect your wireless network from unauthorized access, you need to configure its security settings.

#### To set up the wireless security settings:

1. From the navigation panel, go to **General > Network Map**.
2. On the Network Map screen and under **System Status**, you can configure the wireless security settings such as SSID, security level, and encryption settings.

---

**NOTE:** You can set up different wireless security settings for 2.4GHz, 5GHz and 6GHz bands.

---

#### 2.4GHz/5GHz/6GHz security settings

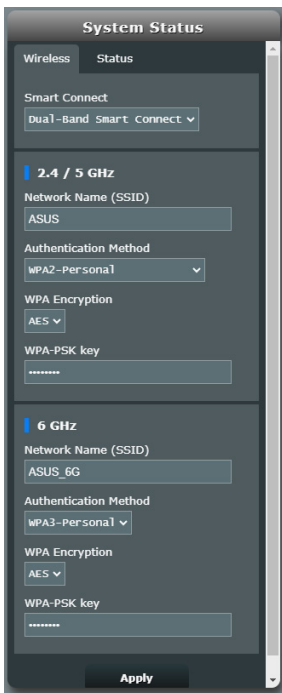

3. On the **Network Name (SSID)** field, key in a unique name for your wireless network.

4. From the **WEP Encryption** dropdown list, select the encryption method for your wireless network.

---

**IMPORTANT!** The IEEE 802.11n/ac/ax standard prohibits using High Throughput with WEP or WPA-TKIP as the unicast cipher. If you use these encryption methods, your data rate will drop to IEEE 802.11g 54Mbps connection.

---

5. Key in your security passkey.
6. Click **Apply** when done.

### 3.1.2 Managing your network clients



#### To manage your network clients:

1. From the navigation panel, go to **General > Network Map**.
2. On the Network Map screen, select the **Client status** icon to display your network client's information.
3. To block a client's access to your network, select the client and click **block**.

### 3.1.3 Monitoring your USB device

The ASUS Wireless Router provides a USB port for connecting a USB device or a USB printer to allow you to share files and printer with clients in your network.



\* The image is for reference only.

**NOTE:** To use this feature, you need to plug a USB storage device, such as a USB hard disk or a USB flash drive, to the USB 3.0 port on the rear panel of your wireless router. Ensure that the USB storage device is formatted and partitioned properly. Refer to the Plug-n-Share Disk Support List at <http://event.asus.com/networks/disksupport>.

---

**IMPORTANT!** You first need to create a share account and its permission /access rights to allow other network clients to access the USB device via an FTP site/third-party FTP client utility, Servers Center, Samba, or AiCloud 2.0. For more details, refer to the section **3.12 USB Application** and **3.4 AiCloud 2.0** in this user manual.

---

### **To monitor your USB device:**

1. From the navigation panel, go to **General > Network Map**.
2. On the Network Map screen, select the **USB Disk Status** icon to display your USB device's information.
3. On the AiDisk Wizard field, click **GO** to set up an FTP server for Internet file sharing.

---

### **NOTES:**

- For more details, refer to the section **3.12.2 Using Servers Center** in this user manual.
  - The wireless router works with most USB HDDs/Flash disks (up to 2TB size) and supports read-write access for FAT16, FAT32, EXT2, EXT3, and NTFS.
-

## Safely removing the USB disk

**IMPORTANT!** Incorrect removal of the USB disk may cause data corruption.

### To safely remove the USB disk:

1. From the navigation panel, go to **General > Network Map**.
2. In the upper right corner, click  > **Eject USB disk**. When the USB disk is ejected successfully, the USB status shows **Unmounted**.



\* The image is for reference only.

## 3.2 Adaptive QoS

### 3.2.1 Managing QoS (Quality of Service) Bandwidth

Quality of Service (QoS) allows you to set the bandwidth priority and manage network traffic.

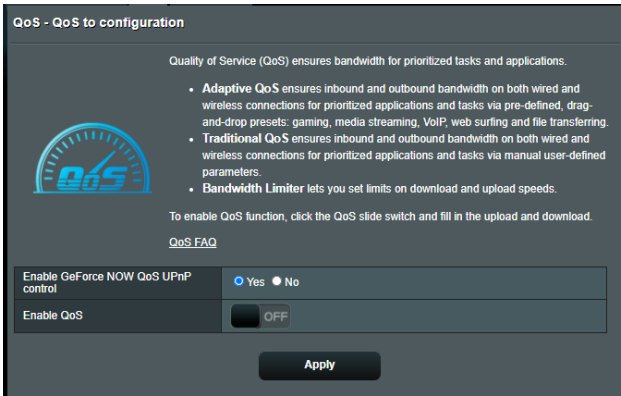

#### To set up bandwidth priority:

1. From the navigation panel, go to **General > Adaptive QoS > QoS**.
2. Click **ON** to enable QoS. Fill in the upload and download bandwidth fields.

---

**NOTE:** Get the bandwidth information from your ISP.

---

3. Click **Apply**.

---

**NOTE:** The User Specify Rule List is for advanced settings. If you want to prioritize specific network applications and network services, select **User-defined QoS rules** or **User-defined Priority** from the drop-down list on the upper-right corner.

---

4. On the **user-defined QoS rules** page, there are four default online service types – web surf, HTTPS and file transfers. Select your preferred service, fill in the **Source IP or MAC, Destination Port, Protocol, Transferred** and **Priority**, then click **Apply**. The information will be configured in the QoS rules screen.

---

**NOTES:**

- To fill in the source IP or MAC, you can:
    - a) Enter a specific IP address, such as "192.168.122.1".
    - b) Enter IP addresses within one subnet or within the same IP pool, such as "192.168.123.\*", or "192.168.\*.\*"
    - c) Enter all IP addresses as "\*.\*.\*.\*" or leave the field blank.
    - d) The format for the MAC address is six groups of two hexadecimal digits, separated by colons (:), in transmission order (e.g. 12:34:56:aa:bc:ef)
  - For source or destination port range, you can either:
    - a) Enter a specific port, such as "95".
    - b) Enter ports within a range, such as "103:315", ">100", or "<65535".
  - The **Transferred** column contains information about the upstream and downstream traffic (outgoing and incoming network traffic) for one section. In this column, you can set the network traffic limit (in KB) for a specific service to generate specific priorities for the service assigned to a specific port. For example, if two network clients, PC 1 and PC 2, are both accessing the Internet (set at port 80), but PC 1 exceeds the network traffic limit due to some downloading tasks, PC 1 will have a lower priority. If you do not want to set the traffic limit, leave it blank.
-

5. On the **User-defined Priority** page, you can prioritize the network applications or devices into five levels from the **user-defined QoS rules'** dropdown list. Based on priority level, you can use the following methods to send data packets:
  - Change the order of upstream network packets that are sent to the Internet.
  - Under **Upload Bandwidth** table, set **Minimum Reserved Bandwidth** and **Maximum Bandwidth Limit** for multiple network applications with different priority levels. The percentages indicate the upload bandwidth rates that are available for specified network applications.

---

**NOTES:**

- Low-priority packets are disregarded to ensure the transmission of high-priority packets.
- Under **Download Bandwidth** table, set **Maximum Bandwidth Limit** for multiple network applications in corresponding order. The higher priority upstream packet will cause the higher priority downstream packet.
- If there are no packets being sent from high-priority applications, the full transmission rate of the Internet connection is available for low-priority packets.

- 
6. Set the highest priority packet. To ensure a smooth online gaming experience, you can set ACK, SYN, and ICMP as the highest priority packet.

---

**NOTE:** Ensure to enable QoS first and set up the upload and download rate limits.

---

## 3.3 Administration

### 3.3.1 Operation Mode

The Operation Mode page allows you to select the appropriate mode for your network.

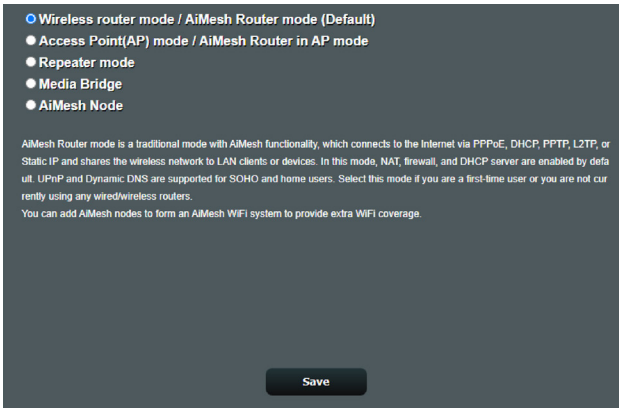

#### To set up the operating mode:

1. From the navigation panel, go to **Advanced Settings > Administration > Operation Mode**.
2. Select any of these operation modes:
  - **Wireless router mode (default):** In wireless router mode, the wireless router connects to the Internet and provides Internet access to available devices on its own local network.
  - **Access Point mode:** In this mode, the router creates a new wireless network on an existing network.
  - **Repeater mode:** This mode turns the router into a wireless repeater to extend the range of your signal.
  - **Media Bridge:** The Media Bridge mode provides the fastest Wi-Fi connection for multiple media devices simultaneously. To set up the Media Bridge mode, you need two ZenWiFi ET9: one configured as the Media station and the other as a router.
  - **AiMesh Node:** You can set ZenWiFi ET9 as an AiMesh node to extend an existing AiMesh routers WiFi coverage.

3. Click **Save**.

---

**NOTE:** The router will reboot when you change the modes.

---

### 3.3.2 System

The **System** page allows you to configure your wireless router settings.

**To set up the System settings:**

1. From the navigation panel, go to **Advanced Settings > Administration > System**.
2. You can configure the following settings:
  - **Change router login password:** You can change the password and login name for the wireless router by entering a new name and password.
  - **WPS button behavior:** The physical WPS button on the wireless router can be used to activate WPS.
  - **Time Zone:** Select the time zone for your network.
  - **NTP Server:** The wireless router can access a NTP (Network time Protocol) server in order to synchronize the time.
  - **Enable Telnet:** Click **Yes** to enable Telnet services on the network. Click **No** to disable Telnet.
  - **Authentication Method:** You can select HTTP, HTTPS, or both protocols to secure router access.
  - **Enable Web Access from WAN:** Select **Yes** to allow devices outside the network to access the wireless router GUI settings. Select **No** to prevent access.
  - **Only allow specific IP:** Click **Yes** if you want to specify the IP addresses of devices that are allowed access to the wireless router GUI settings from WAN.
3. Click **Apply**.

### 3.3.3 Firmware Upgrade

---

**NOTE:** Download the latest firmware from the ASUS website at <http://www.asus.com>.

---

#### To upgrade the firmware:

1. From the navigation panel, go to **Advanced Settings > Administration > Firmware Upgrade**.
2. In the **Firmware Version** field, click **Check** to locate the downloaded file.
3. Click **Upload**.

---

#### NOTES:

- When the upgrade process is complete, wait for some time for the system to reboot.
  - If the upgrade process fails, the wireless router automatically enters rescue mode and the power LED indicator on the front panel starts flashing slowly. To recover or restore the system, refer to section **4.2 Firmware Restoration**.
- 

### 3.3.4 Restore/Save/Upload Setting

#### To restore/save/upload wireless router settings:

1. From the navigation panel, go to **Advanced Settings > Administration > Restore/Save/Upload Setting**.
2. Select the tasks that you want to do:
  - To restore to the default factory settings, click **Restore**, and click **OK** in the confirmation message.
  - To save the current system settings, click **Save setting**, navigate to the folder where you intend to save the file and click **Save**.
  - To restore from a saved system settings file, click **Upload** to locate your file, then click **Open**.

---

**IMPORTANT!** If issues occur, upload the latest firmware version and configure new settings. Do not restore the router to its default settings.

---

## 3.4 AiCloud 2.0

AiCloud 2.0 is a cloud service application that allows you to save, sync, share, and access your files.

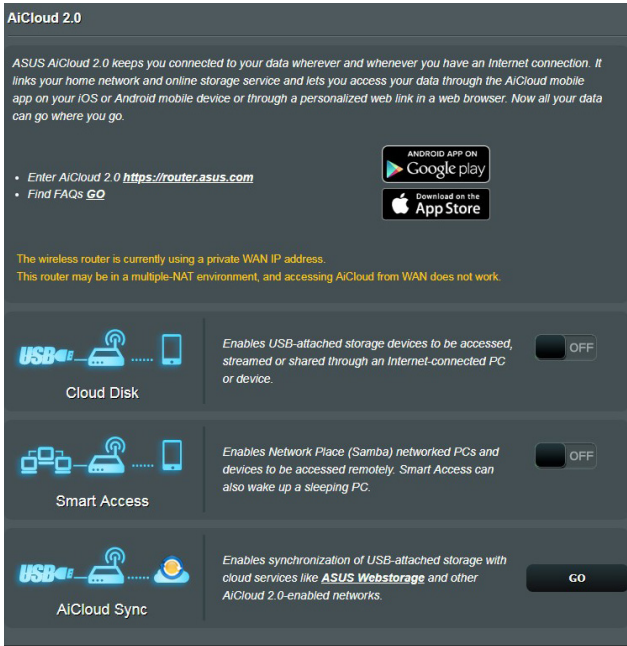

### To use AiCloud 2.0:

1. From Google Play Store or Apple Store, download and install the ASUS AiCloud 2.0 app to your smart device.
2. Connect your smart device to your network. Follow the instructions to complete the AiCloud 2.0 setup process.

### 3.4.1 Cloud Disk

#### To create a cloud disk:

1. Insert a USB storage device into the wireless router.
2. Turn on **Cloud Disk**.

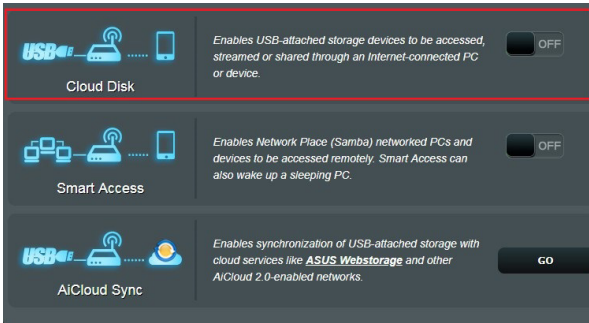

3. Go to <http://www.asusrouter.com> and enter the router login account and password. For better user experience, we recommend that you use **Google Chrome** or **Firefox**.
4. You can now start accessing Cloud Disk files on devices connected to the network.

---

**NOTE:** When accessing the devices that are connected to the network, you need to enter the device's user name and password manually, which will not be saved by AiCloud 2.0 for security reason.

---

### 3.4.2 Smart Access

The Smart Access function allows you to easily access your home network via your router's domain name.

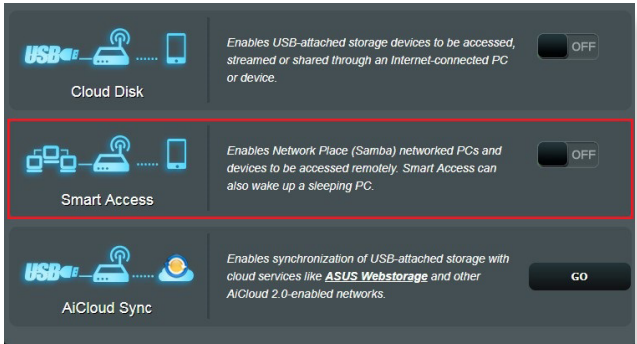

---

#### NOTES:

- You can create a domain name for your router with ASUS DDNS. For more details, refer to section **3.13.6 DDNS**.
  - By default, AiCloud 2.0 provides a secure HTTPS connection. Key in **[https://\[yourASUSDDNSname\].asuscomm.com](https://[yourASUSDDNSname].asuscomm.com)** for a very secure Cloud Disk and Smart Access usage.
-

### 3.4.3 AiCloud Sync

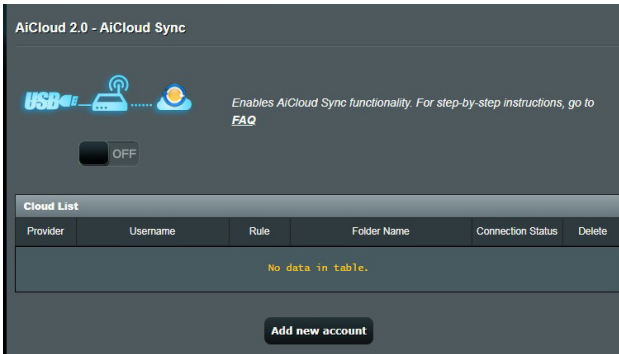

#### To use AiCloud Sync:

1. Launch AiCloud 2.0, click **AiCloud Sync**.
2. Select **ON** to enable AiCloud Sync.
3. Click **Add new account**.
4. Enter your ASUS WebStorage account password and select the directory that you want to sync with WebStorage.
5. Click **Apply**.

## 3.5 AiProtection

AiProtection provides real-time monitoring that detects malware, spyware, and unwanted access. It also filters unwanted websites and apps and allows you to schedule a time that a connected device is able to access the Internet.

### 3.5.1 Network Protection

Network Protection prevents network exploits and secures your network from unwanted access.

**AiProtection**

Network Protection with Trend Micro protects against network exploits to secure your network from unwanted access.

[AiProtection FAQ](#)

Enabled AiProtection  OFF

**1** Router Security Assessment  
Scan your router to find vulnerabilities and offer available options to enhance your devices protection. **Scan** **1** Danger

**2** Malicious Sites Blocking  
Restrict access to known malicious websites to protect your network from malware, phishing, spam, adware, hacking, and ransomware attacks. **ON** **0** Protection

**2** Two-Way IPS  
The Two-Way Intrusion Prevention System protects any device connected to the network from spam or DDoS attacks. It also blocks malicious incoming packets to protect your router from network vulnerability attacks, such as Shellshocked, Heartbleed, Bitcoin mining, and ransomware. Additionally, Two-Way IPS detects suspicious outgoing packets from infected devices and avoids botnet attacks. **ON** **0** Protection

**3** Infected Device Prevention and Blocking  
This feature prevents infected devices from being enslaved by botnets or zombie attacks which might steal your personal information or attack other devices. **ON** **0** Protection

**Alert Preference**

## Configuring Network Protection

### To configure Network Protection:

1. From the navigation panel, go to **General > AiProtection**.
2. From the **AiProtection** main page, click on **Network Protection**.
3. From the **Network Protection** tab, click **Scan**.

When done scanning, the utility displays the results on the **Router Security Assessment** page.

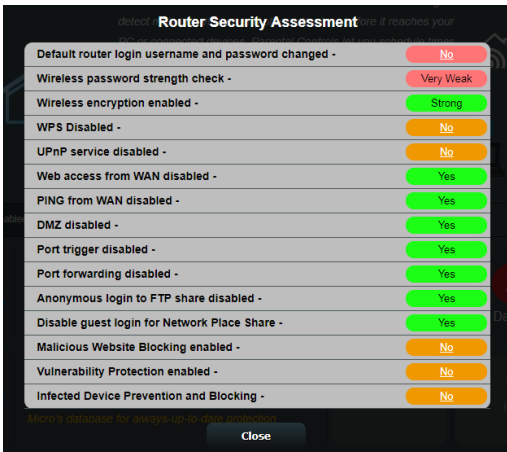

**IMPORTANT!** Items marked as **Yes** on the **Router Security Assessment** page is considered to be at a **safe** status. Items marked as **No**, **Weak**, or **Very Weak** is highly recommended to be configured accordingly.

4. (Optional) From the **Router Security Assessment** page, manually configure the items marked as **No**, **Weak**, or **Very Weak**. To do this:
  - a. Click an item.

**NOTE:** When you click an item, the utility forwards you to the item's setting page.

- b. From the item's security settings page, configure and make the necessary changes and click **Apply** when done.

- c. Go back to the **Router Security Assessment** page and click **Close** to exit the page.
5. To automatically configure the security settings, click **Secure Your Router**.
6. When a message prompt appears, click **OK**.

## Malicious Sites Blocking

This feature restricts access to known malicious websites in the cloud database for an always-up-to-date protection.

---

**NOTE:** This function is automatically enabled if you run the **Router Weakness Scan**.

---

### To enable Malicious Sites Blocking:

1. From the navigation panel, go to **General > AiProtection**.
2. From the **AiProtection** main page, click on **Network Protection**.
3. From the **Malicious Sites Blocking** pane, click **ON**.

## Two-Way IPS

Two-Way IPS (Intrusion Prevention System) protects your router from network attacks by both blocking malicious incoming packets and detecting suspicious outgoing packets.

---

**NOTE:** This function is automatically enabled if you run the **Router Weakness Scan**.

---

### To enable Two-Way IPS:

1. From the navigation panel, go to **General > AiProtection**.
2. From the **AiProtection** main page, click on **Network Protection**.
3. From the **Two-Way IPS** pane, click **ON**.

## Infected Device Prevention and Blocking

This feature prevents infected devices from communicating personal information or infected status to external parties.

---

**NOTE:** This function is automatically enabled if you run the **Router Weakness Scan**.

---

### To enable Infected Device Prevention and Blocking:

1. From the navigation panel, go to **General > AiProtection**.
2. From the **AiProtection** main page, click on **Network Protection**.
3. From the **Infected Device Prevention and Blocking** pane, click **ON**.

### To configure Alert Preference:

1. From the **Infected Device Prevention and Blocking** pane, click **Alert Preference**.
2. Select or key in the e-mail provider, e-mail account, and password then click **Apply**.

## 3.5.2 Setting up Parental Controls

Parental Control allows you to control the Internet access time or set the time limit for a client's network usage.

To go to the Parental Controls main page:

From the navigation panel, go to **General > Parental Controls**.

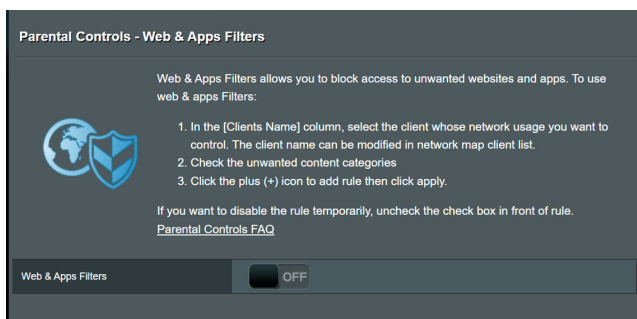

### Web & Apps Filters

Web & Apps Filters is a feature of **Parental Controls** that allows you to block access to unwanted web sites or applications.

#### To configure Web & Apps Filters:

1. From the navigation panel, go to **General > Parental Controls**.
2. From the **Web & Apps Filters** pane, click **ON**.
3. When the End Users License Agreement (EULA) message prompt appears, click **I agree** to continue.
4. From the **Client List** column, select or key in the client's name from the drop down list box.
5. From the **Content Category** column, select the filters from the four main categories: **Adult, Instant Message and Communication, P2P and File Transfer, and Streaming and Entertainment**.

7. Click  to add the client's profile.
8. Click **Apply** to save the settings.

Parental Controls - Web & Apps Filters

Web & Apps Filters allows you to block access to unwanted websites and apps. To use web & apps Filters:

1. In the [Clients Name] column, select the client whose network usage you want to control. The client name can be modified in network map client list.
2. Check the unwanted content categories
3. Click the plus (+) icon to add rule then click apply.

If you want to disable the rule temporarily, uncheck the check box in front of rule.  
[Parental Controls FAQ](#)

Web & Apps Filters  ON

Client List (Max Limit : 64)

<input type="checkbox"/>	Client Name (MAC Address)	Content Category	Add / Delete
<input checked="" type="checkbox"/>	<input type="text" value="192.168.1.100"/>	<ul style="list-style-type: none"><li><input checked="" type="checkbox"/> <b>Adult</b> Block adult/mature content to prevent children from visiting sites that contain material of a sexual, violent, and illegal nature.</li><li><input checked="" type="checkbox"/> <b>Instant Message and Communication</b> Block instant communication software and messaging apps to prevent children from becoming addicted to social networking sites.</li><li><input checked="" type="checkbox"/> <b>P2P and File Transfer</b> By blocking P2P and File Transferring you can make sure your network has a better quality of data transmission.</li><li><input checked="" type="checkbox"/> <b>Streaming and Entertainment</b> By blocking streaming and entertainment services you can limit the time your children spend online.</li></ul>	

No data in table.

**Apply**

## Time Scheduling

Time Scheduling allows you to set the time limit for a client's network usage.

**NOTE:** Ensure that your system time is synchronized with the NTP server.

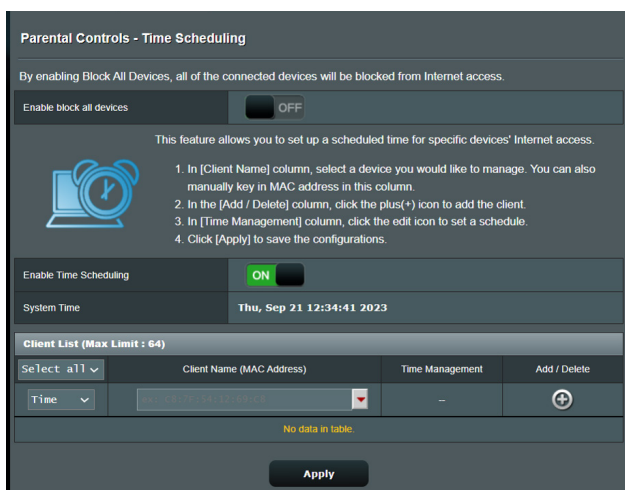

### To configure Time Scheduling:

1. From the navigation panel, go to **General > Parental Controls > Time Scheduling**.
2. From the **Enable Time Scheduling** pane, click **ON**.
3. From the **Clients Name** column, select or key in the client's name from the drop down list box.

**NOTE:** You may also key in the client's MAC address in the **Client MAC Address** column. Ensure that the client name does not contain special characters or spaces as these may cause the router to function abnormally.

4. Click to add the client's profile.
5. Click **Apply** to save the settings.

## 3.6 Firewall

The wireless router can serve as a hardware firewall for your network.

---

**NOTE:** The Firewall feature is enabled by default.

---

### 3.6.1 General

The screenshot shows the 'Firewall' configuration page, specifically the 'General' tab. The page is dark-themed and contains several sections for configuring firewall settings.

**Firewall General**

Enable the firewall to protect your local area network against attacks from hackers. The firewall filters the incoming and outgoing packets based on the filter rules.  
[DoS Protection FAQ](#)

Enable Firewall	<input checked="" type="radio"/> Yes <input type="radio"/> No
Enable DoS protection	<input checked="" type="radio"/> Yes <input type="radio"/> No
Logged packets type	None
Respond ICMP Echo (ping) Request from WAN	<input type="radio"/> Yes <input checked="" type="radio"/> No

**Basic Config**

Enable IPv4 inbound firewall rules	<input type="radio"/> Yes <input checked="" type="radio"/> No
------------------------------------	---

**Inbound Firewall Rules (Max Limit : 128)**

Source IP	Port Range	Protocol	Add / Delete
<input type="text"/>	<input type="text"/>	TCP	<input type="button" value="Add"/>
No data in table.			

**IPv6 Firewall**

All outbound traffic coming from IPv6 hosts on your LAN is allowed, as well as related inbound traffic. Any other inbound traffic must be specifically allowed here.

You can leave the remote IP blank to allow traffic from any remote host. A subnet can also be specified. (2001::1111:2222:3333/64 for example)

**Basic Config**

Enable IPv6 Firewall	<input checked="" type="radio"/> Yes <input type="radio"/> No
Famous Server List	Please select

**Inbound Firewall Rules (Max Limit : 128)**

Service Name	Remote IP/CIDR	Local IP	Port Range	Protocol	Add / Delete
<input type="text"/>	<input type="text"/>	<input type="text"/>	<input type="text"/>	TCP	<input type="button" value="Add"/>
No data in table.					

#### To set up basic Firewall settings:

1. From the navigation panel, go to **Advanced Settings > Firewall > General**.
2. On the **Enable Firewall** field, select **Yes**.

3. On the **Enable DoS** protection, select **Yes** to protect your network from DoS (Denial of Service) attacks though this may affect your router's performance.
4. You can also monitor packets exchanged between the LAN and WAN connection. On the Logged packets type, select **Dropped, Accepted, or Both**.
5. Click **Apply**.

### 3.6.2 URL Filter

You can specify keywords or web addresses to prevent access to specific URLs.

---

**NOTE:** The URL Filter is based on a DNS query. If a network client has already accessed a website such as `http://www.abcxxx.com`, then the website will not be blocked (a DNS cache in the system stores previously visited websites). To resolve this issue, clear the DNS cache before setting up the URL Filter.

---

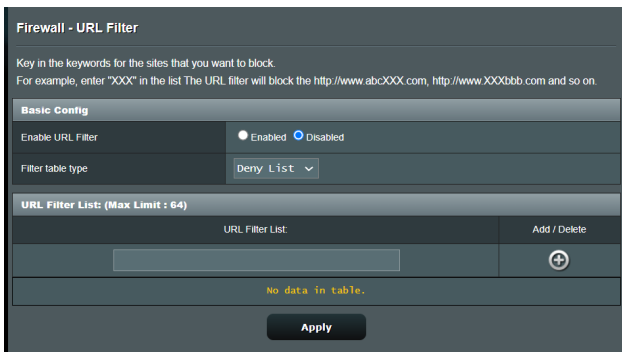

#### To set up a URL filter:

1. From the navigation panel, go to **Advanced Settings > Firewall > URL Filter**.
2. On the Enable URL Filter field, select **Enabled**.
3. Enter a URL and click the  button.
4. Click **Apply**.

### 3.6.3 Keyword filter

Keyword filter blocks access to webpages containing specified keywords.

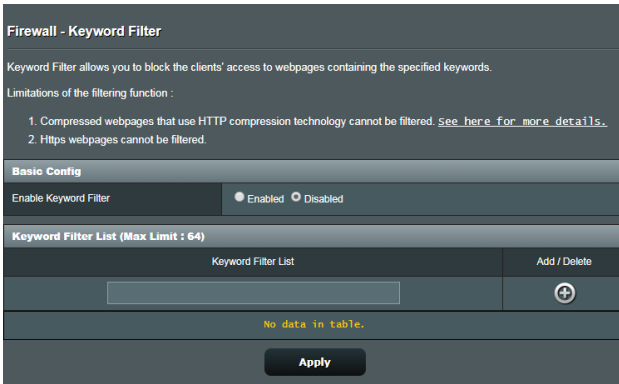

#### To set up a keyword filter:

1. From the navigation panel, go to **Advanced Settings > Firewall > Keyword Filter**.
2. On the Enable Keyword Filter field, select **Enabled**.
3. Enter a word or phrase and click the **Add** button.
4. Click **Apply**.

---

#### NOTES:

- The Keyword Filter is based on a DNS query. If a network client has already accessed a website such as <http://www.abcxx.com>, then the website will not be blocked (a DNS cache in the system stores previously visited websites). To resolve this issue, clear the DNS cache before setting up the Keyword Filter.
  - Web pages compressed using HTTP compression cannot be filtered. HTTPS pages also cannot be blocked using a keyword filter.
-

### 3.6.4 Network Services Filter

The Network Services Filter blocks LAN to WAN packet exchanges and restricts network clients from accessing specific web services such as Telnet or FTP.

**Firewall - Network Services Filter**

The Network Services filter blocks the LAN to WAN packet exchanges and restricts devices from using specific network services. For example, if you do not want the device to use the Internet service, key in 80 in the destination port. The traffic that uses port 80 will be blocked (but https can not be blocked).  
Leave the source IP field blank to apply this rule to all LAN devices.

**Deny List Duration :** During the scheduled duration, clients in the Deny List cannot use the specified network services. After the specified duration, all the clients in LAN can access the specified network services.

**Allow List Duration :** During the scheduled duration, clients in the Allow List can ONLY use the specified network.

**NOTE :** If you set the subnet for the Allow List, IP addresses outside the subnet will not be able to access the Internet or any Internet service.

**Network Services Filter**

Enable Network Services Filter  Yes  No

Filter table type

Well-Known Applications

Date to Enable LAN to WAN Filter  Mon  Tue  Wed  Thu  Fri

Time of Day to Enable LAN to WAN Filter  :  -  :

Date to Enable LAN to WAN Filter  Sat  Sun

Time of Day to Enable LAN to WAN Filter  :  -  :

Filtered ICMP packet types

**Network Services Filter Table (Max Limit : 32)**

Source IP	Port Range	Destination IP	Port Range	Protocol	Add / Delete
<input type="text"/>	<input type="text"/>	<input type="text"/>	<input type="text"/>	TCP	<input type="button" value="+"/>
No data in table.					

### To set up a Network Service filter:

1. From the navigation panel, go to **Advanced Settings > Firewall > Network Service Filter**.
2. On the Enable Network Services Filter field, select **Yes**.
3. Select the Filter table type. **Deny** blocks the specified network services. **Allow** limits access to only the specified network services.
4. Specify the day and time when the filters will be active.
5. To specify a Network Service to filter, enter the Source IP, Destination IP, Port Range, and Protocol. Click the  button.
6. Click **Apply**.

## 3.7 Guest Network

The Guest Network provides temporary visitors with Internet connectivity via access to separate SSIDs or networks without providing access to your private network.

---

**NOTE:** ZenWiFi ET9 supports up to nine SSIDs (three 2.4GHz, three 5GHz and three 6GHz SSIDs).

---

### To create a guest network:

1. From the navigation panel, go to **General > Guest Network**.
2. On the Guest Network screen, select 2.4GHz, 5GHz or 6GHz frequency band for the guest network that you want to create.
3. Click **Enable**.

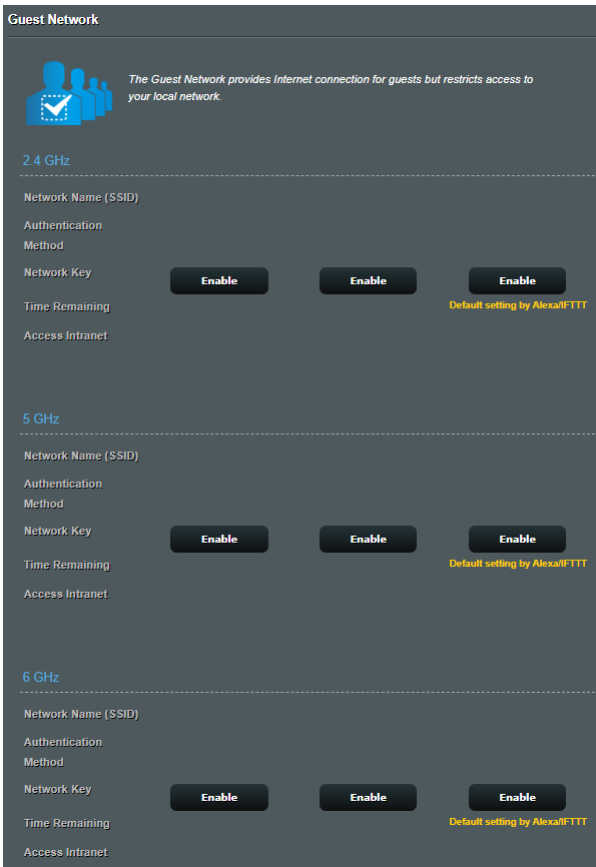

4. To configure additional options, click **Modify**.

The screenshot displays the 'Guest Network' configuration page. At the top, there is a header with a blue icon of people and a checkmark, followed by the text: 'The Guest Network provides Internet connection for guests but restricts access to your local network.' Below this, the interface is divided into three frequency sections: 2.4GHz, 5GHz, and 6GHz. Each section contains a table of configuration options and two 'Enable' buttons. The 2.4GHz section has a 'Remove' button below the table. The 5GHz and 6GHz sections also have 'Remove' buttons below their respective tables. The 'Time Remaining' field in each section is set to 'Unlimited access' and is noted as a 'Default setting by AlexaIFTTT'. The 'Access Intranet' field is set to 'off'.

2.4GHz	
Network Name (SSID)	ASUS_2G_Guest
Authentication Method	Open System
Network Key	None
Time Remaining	Unlimited access
Access Intranet	off

5GHz	
Network Name (SSID)	ASUS_5G_Guest
Authentication Method	Open System
Network Key	None
Time Remaining	Unlimited access
Access Intranet	off

6GHz	
Network Name (SSID)	ASUS_6G_Guest
Authentication Method	Open System
Network Key	None
Time Remaining	Unlimited access
Access Intranet	off

5. Click **Yes** on the **Enable Guest Network** screen.
6. Assign a wireless name for your temporary network on the **Network Name (SSID)** field.
7. Select an **Authentication Method**.
8. Select an **Encryption** method.
9. Specify the **Access time** or choose **Limitless**.
10. Select **Disable** or **Enable** on the **Access Intranet** item.
11. When done, click **Apply**.

## 3.8 IPv6

This wireless router supports IPv6 addressing, a system that supports more IP addresses. This standard is not yet widely available. Contact your ISP if your Internet service supports IPv6.

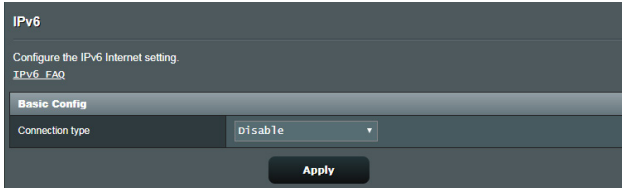

### To set up IPv6:

1. From the navigation panel, go to **Advanced Settings > IPv6**.
2. Select your **Connection type**. The configuration options vary depending on your selected connection type.
3. Enter your IPv6 LAN and DNS settings.
4. Click **Apply**.

---

**NOTE:** Please refer to your ISP regarding specific IPv6 information for your Internet service.

---

## 3.9 LAN

### 3.9.1 LAN IP

The LAN IP screen allows you to modify the LAN IP settings of your wireless router.

---

**NOTE:** Any changes to the LAN IP address will be reflected on your DHCP settings.

---

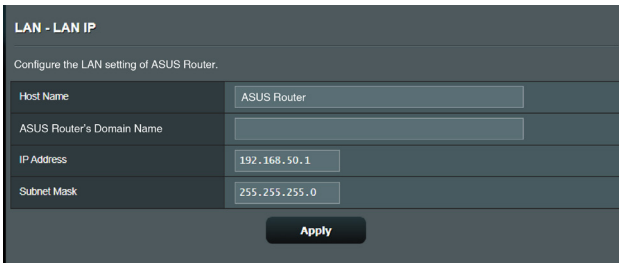

LAN - LAN IP

Configure the LAN setting of ASUS Router.

Host Name	ASUS Router
ASUS Router's Domain Name	
IP Address	192.168.50.1
Subnet Mask	255.255.255.0

Apply

#### To modify the LAN IP settings:

1. From the navigation panel, go to **Advanced Settings > LAN > LAN IP**.
2. Modify the **IP address** and **Subnet Mask**.
3. When done, click **Apply**.

### 3.9.2 DHCP Server

Your wireless router uses DHCP to assign IP addresses automatically on your network. You can specify the IP address range and lease time for the clients on your network.

LAN - DHCP Server

DHCP (Dynamic Host Configuration Protocol) is a protocol for the automatic configuration used on IP networks. The DHCP server can assign each client an IP address and informs the client of the DNS server IP and default gateway IP. ASUS Router supports up to 253 IP addresses for your local network.  
[Manually Assigned IP around the DHCP list FAQ](#)

**Basic Config**

Enable the DHCP Server  Yes  No

ASUS Router's Domain Name

IP Pool Starting Address

IP Pool Ending Address

Lease time

Default Gateway

**DNS and WINS Server Setting**

DNS Server 1

DNS Server 2

Advertise router's IP in addition to user-specified DNS  Yes  No

WINS Server

**Manual Assignment**

Enable Manual Assignment  Yes  No

**Manually Assigned IP around the DHCP list (Max Limit : 64)**

Client Name (MAC Address)	IP Address	DNS Server (Optional)	Host Name (Optional)	Add / Delete
<input type="text" value="192.168.50.254"/>	<input type="text"/>	<input type="text"/>	<input type="text"/>	<input type="button" value="⊕"/>

No data in table.

#### To configure the DHCP server:

1. From the navigation panel, go to **Advanced Settings > LAN > DHCP Server**.
2. In the **Enable the DHCP Server** field, tick **Yes**.
3. In the **Domain Name** text box, enter a domain name for the wireless router.
4. In the **IP Pool Starting Address** field, key in the starting IP address.

5. In the **IP Pool Ending Address** field, key in the ending IP address.
6. In the **Lease Time** field, specify in seconds when an assigned IP address will expire. Once it reaches this time limit, the DHCP server will then assign a new IP address.

---

**NOTES:**

- We recommend that you use an IP address format of 192.168.50.xxx (where xxx can be any number between 2 and 254) when specifying an IP address range.
- An IP Pool Starting Address should not be greater than the IP Pool Ending Address.

- 
7. In the **DNS and WINS Server Settings** section, key in your DNS Server and WINS Server IP address if needed.
  8. Your wireless router can also manually assign IP addresses to devices on the network. On the **Enable Manual Assignment** field, choose **Yes** to assign an IP address to specific MAC addresses on the network. Up to 32 MAC Addresses can be added to the DHCP list for manual assignment.



### 3.9.3 Route

If your network makes use of more than one wireless router, you can configure a routing table to share the same Internet service.

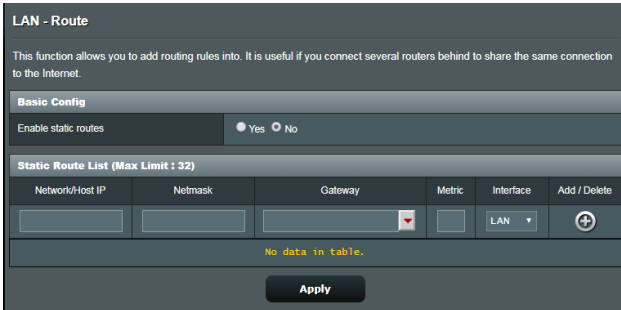
**NOTE:** We recommend that you do not change the default route settings unless you have advanced knowledge of routing tables.



#### To configure the LAN Routing table:

1. From the navigation panel, go to **Advanced Settings > LAN > Route**.
2. On the **Enable static routes** field, choose **Yes**.
3. On the **Static Route List**, enter the network information of other access points or nodes. Click the **Add**  or **Delete**  button to add or remove a device on the list.
4. Click **Apply**.

### 3.9.4 IPTV

The wireless router supports connection to IPTV services through an ISP or a LAN. The IPTV tab provides the configuration settings needed to set up IPTV, VoIP, multicasting, and UDP for your service. Contact your ISP for specific information regarding your service.

**LAN - IPTV**

To watch IPTV, the WAN port must be connected to the Internet. Please go to [WAN - Dual WAN](#) to confirm that WAN port is assigned to primary WAN.

LAN Port	
Select ISP Profile	None ▾
Choose IPTV STB Port	None ▾

Special Applications	
Use DHCP routes	Microsoft ▾
Enable multicast routing (IGMP Proxy)	Disable ▾
UDP Proxy (Udpxy)	0

**Apply**

## 3.10 System Log

System Log contains your recorded network activities.

**NOTE:** System log resets when the router is rebooted or powered off.

### To view your system log:

1. From the navigation panel, go to **Advanced Settings > System Log**.
2. You can view your network activities in any of these tabs:
  - General Log
  - Wireless Log
  - DHCP Leases
  - IPv6
  - Routing Table
  - Port Forwarding
  - Connections

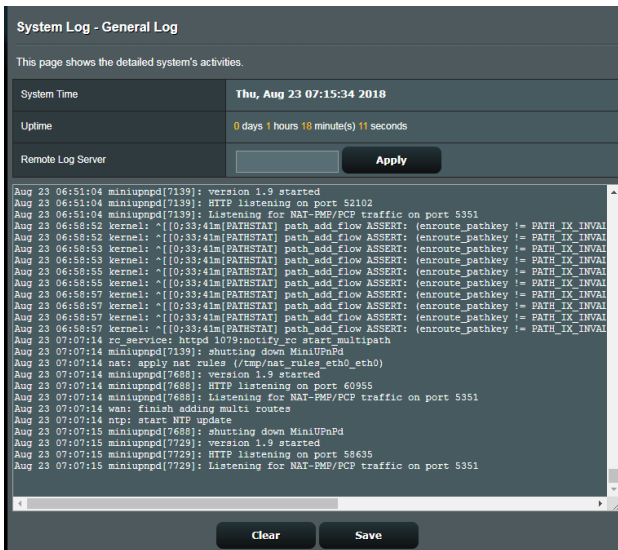

## 3.11 Traffic Analyzer

The traffic monitor feature allows you to access the bandwidth usage and speed of your Internet, wired, or wireless networks. It allows you to monitor network traffic in real-time or on a daily basis. It also offers an option to display the network traffic within the last 24 hours.

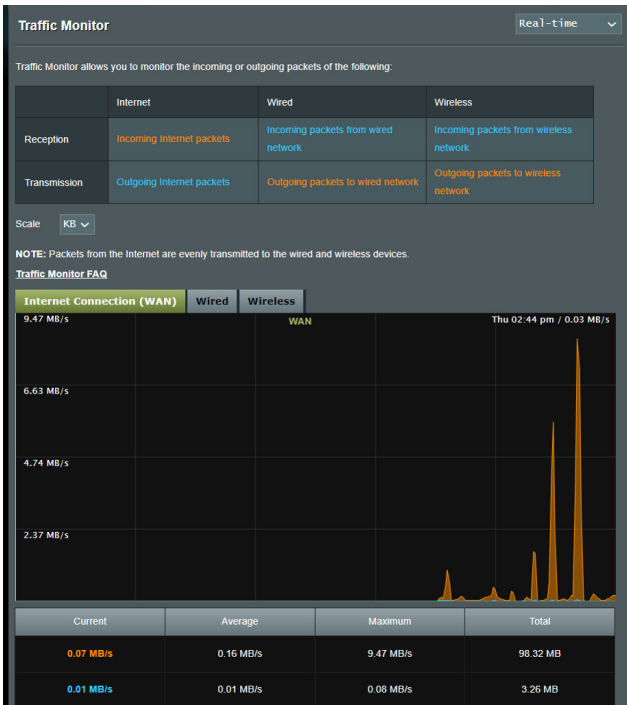

**NOTE:** Packets from the Internet are evenly transmitted to the wired and wireless devices.

## 3.12 USB Application

The USB Applications function provides AiDisk, Servers Center, Network Printer Server and Download Master submenus.

**IMPORTANT!** To use the server functions, you need to insert a USB storage device, such as a USB hard disk or a USB flash drive, in the USB 3.0 port on the rear panel of your wireless router. Ensure that the USB storage device is formatted and partitioned properly. Refer to the ASUS website at <http://event.asus.com/2009/networks/disksupport/> for the file system support table.

**USB Application**

To remove the hard disk from the router, click the USB icon at the upper right corner of your screen.

- AiDisk**  
Share files in the USB disk through the Internet.
- Servers Center**  
Setup the UPnP, iTunes, FTP and Network Place (Samba).
- Network Printer Server**  
The network printer server supports two methods:  
(1) ASUS EZ printer sharing (2) LPR to share printer.
- 3G/4G**  
Switch to USB mode to use a 3G/4G USB wireless dongle or Android phone as a USB modem. Support
- Time Machine**  
Enable Time Machine functionality
- Download Master**  
PC-free download manager
- Install**

### 3.12.1 Using AiDisk

AiDisk allows you to share files stored on a connected USB device through the Internet. AiDisk also assists you with setting up ASUS DDNS and an FTP server.

#### To use AiDisk:

1. From the navigation panel, go to **General > USB application**, then click the **AiDisk** icon.
2. From the Welcome to AiDisk wizard screen, click **Go**.

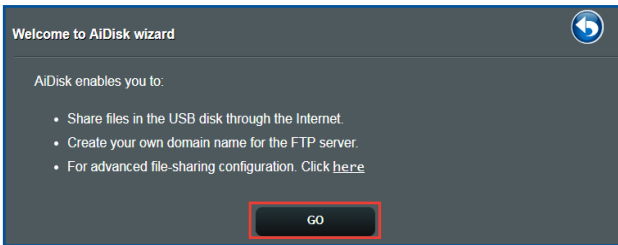

3. Select the access rights that you want to assign to the clients accessing your shared data.

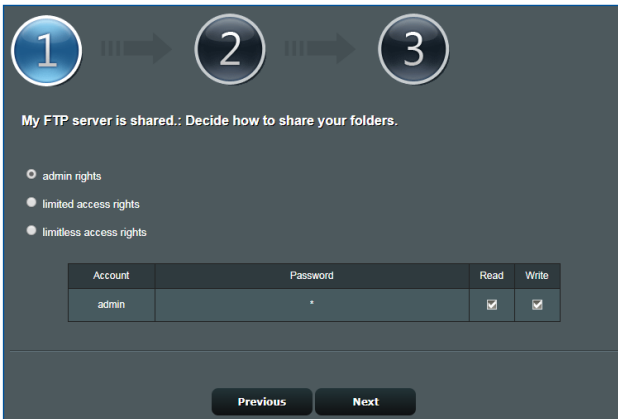

4. Create your domain name via the ASUS DDNS services, read the Terms of Service and then select **I will use the service and accept the Terms of service** and key in your domain name. When done, click **Next**.



You can also select **Skip ASUS DDNS settings** then click **Next** to skip the DDNS setting.

5. Click **Finish** to complete the setting.
6. To access the FTP site that you created, launch a web browser or a third-party FTP client utility and key in the ftp link (**ftp://<domain name>.asuscomm.com**) you have previously created.

### 3.12.2 Using Servers Center

Servers Center allows you to share the media files from the USB disk via a Media Server directory, Samba share service, or FTP share service. You can also configure other settings for the USB disk in the Servers Center.

#### Using Media Server

Your wireless router allows DLNA-supported devices to access multimedia files from the USB disk connected to your wireless router.

---

**NOTE:** Before using the DLNA Media Server function, connect your device to ZenWiFi ET9's network.

---

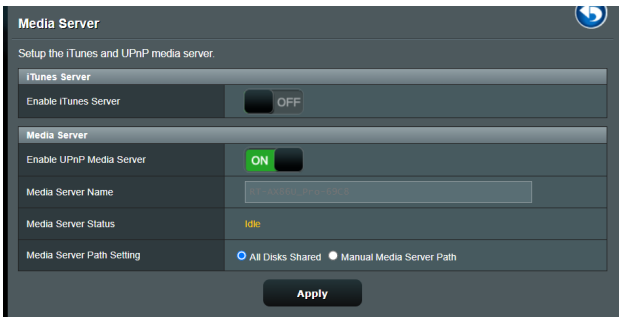

To launch the Media Server setting page, go to **General > USB application > Servers Center > Media Servers**. Refer to the following for the descriptions of the fields:

- **Enable iTunes Server?:** Select ON/OFF to enable/disable the iTunes Server.
- **Enable UPnP Media Server?:** Select ON/OFF to enable/disable the UPnP Media Server.
- **Media Server Status:** Displays the status of the media server.
- **Media Server Path Setting:** Select **All Disks Shared** or **Manual Media Server Path**.

## Using Network Place (Samba) Share service

Network Place (Samba) Share allows you to set up the accounts and permissions for the Samba service.

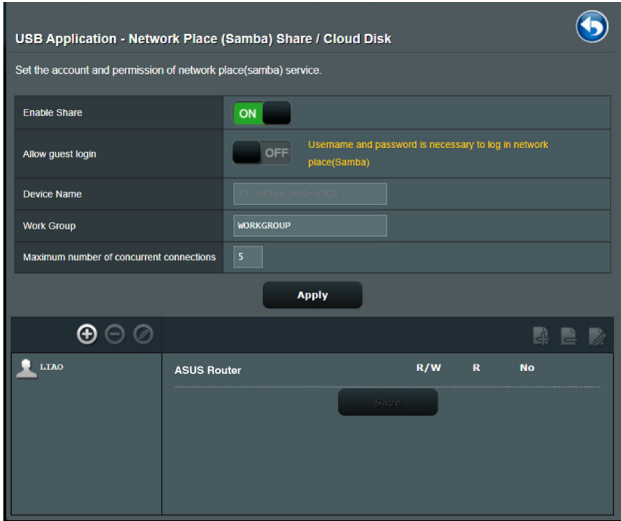

### To use Samba share:

1. From the navigation panel, go to **General > USB application > Servers Center > Network Place (Samba) Share / Cloud Disk**.

---

**NOTE:** Network Place (Samba) Share is enabled by default.

---

2. Follow the steps below to add, delete, or modify an account.

### To create a new account:

- a) Click  to add new account.
- b) In the **Account** and **Password** fields, key in the name and password of your network client. Retype the password to confirm. Click **Add** to add the account to the list.

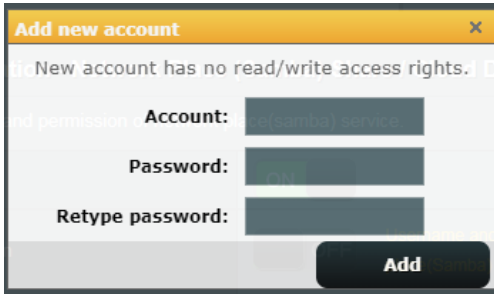

### To delete an existing account:

- a) Select the account that you want to delete.
- b) Click .
- c) When prompted, click **Delete** to confirm the account deletion.

### To add a folder:

- a) Click .
- b) Enter the folder name, and click **Add**. The folder that you created will be added to the folder list.

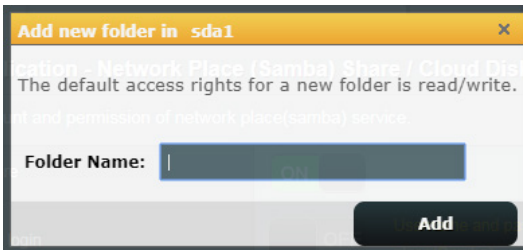

3. From the list of folders, select the type of access permission that you want to assign for specific folders:
  - **R/W**: Select this option to assign read/write access.
  - **R**: Select this option to assign read-only access.
  - **No**: Select this option if you do not want to share a specific file folder.
4. Click **Apply** to apply the changes.

## Using the FTP Share service

FTP share enables an FTP server to share files from USB disk to other devices via your local area network or via the Internet.

---

### IMPORTANT!

- Ensure that you safely remove the USB disk. Incorrect removal of the USB disk may cause data corruption.
  - To safely remove the USB disk, refer to the section **Safely removing the USB disk** under **3.1.3 Monitoring your USB device**.
- 

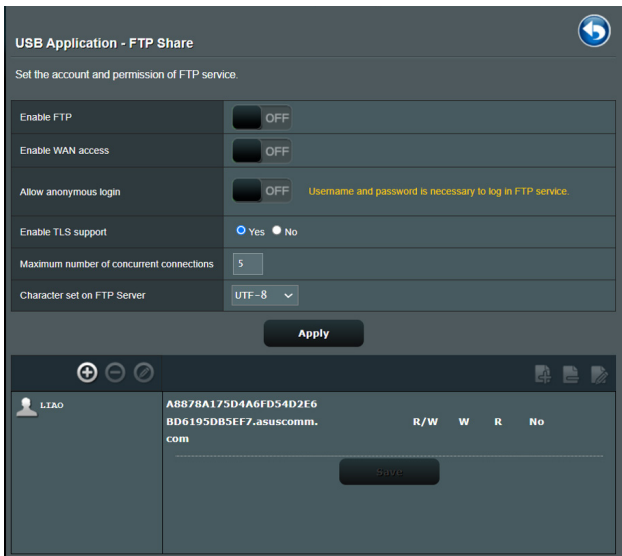

## To use FTP Share service:

---

**NOTE:** Ensure that you have set up your FTP server through AiDisk. For more details, refer to the section **3.12.1 Using AiDisk**.

---

1. From the navigation panel, click **General > USB application > Servers Center > FTP Share**.
2. From the list of folders, select the type of access rights that you want to assign for specific folders:
  - **R/W:** Select to assign read/write access for a specific folder.
  - **W:** Select to assign write only access for a specific folder.
  - **R:** Select to assign read only access for a specific folder.
  - **No:** Select this option if you do not want to share a specific folder.
3. Click **Apply** to confirm the changes.
4. To access the FTP server, key in the ftp link **ftp://<hostname>.asuscomm.com** and your user name and password on a web browser or a third-party FTP utility.

### 3.12.3 3G/4G

3G/4G USB modems can be connected to ZenWiFi ET9 to allow Internet access.

**NOTE:** For a list of verified USB modems, please visit:  
<http://event.asus.com/2009/networks/3gsupport/>.

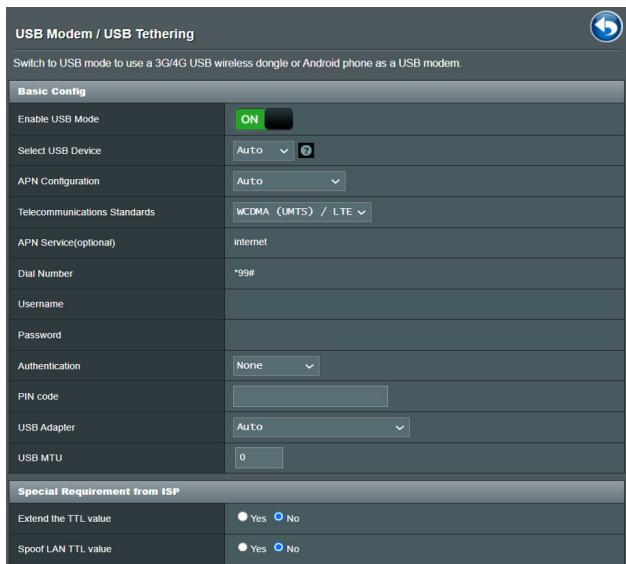

Basic Config	
Enable USB Mode	<input checked="" type="checkbox"/> ON
Select USB Device	Auto
APN Configuration	Auto
Telecommunications Standards	WCDMA (UMTS) / LTE
APN Service(optional)	Internet
Dial Number	*99#
Username	
Password	
Authentication	None
PIN code	
USB Adapter	Auto
USB MTU	0

Special Requirement from ISP	
Extend the TTL value	<input type="radio"/> Yes <input checked="" type="radio"/> No
Spoof LAN TTL value	<input type="radio"/> Yes <input checked="" type="radio"/> No

#### To set up 3G/4G internet access:

1. From the navigation panel, click **General > USB application > 3G/4G**.
2. In the **Enable USB Modem** field, select **Yes**.
3. Set up the following:
  - **Location:** Select your 3G/4G service provider's location from the dropdown list.
  - **ISP:** Select your Internet Service Provider (ISP) from the dropdown list.
  - **APN (Access Point Name) service (optional):** Contact your 3G/4G service provider for detailed information.

- **Dial Number and PIN code:** The 3G/4G provider's access number and PIN code for connection.

---

**NOTE:** PIN code may vary from different providers.

---

- **Username / Password:** The username and password will be provided by the 3G/4G network carrier.
- **USB Adapter:** Choose your USB 3G / 4G adapter from the dropdown list. If you are not sure of your USB adapter's model or the model is not listed in the options, select **Auto**.

4. Click **Apply**.

---

**NOTE:** The router will reboot for the settings to take effect.

---

# 3.13 WAN

## 3.13.1 Internet Connection

The Internet Connection screen allows you to configure the settings of various WAN connection types.

### WAN - Internet Connection

ASUS Router supports several connection types to WAN (wide area network). These types are selected from the dropdown menu beside WAN Connection Type. The setting fields differ depending on the connection type you selected.

Configure the Ethernet WAN settings of ASUS Router.

---

#### Basic Config

WAN Connection Type	Automatic IP
Enable WAN	<input checked="" type="radio"/> Yes <input type="radio"/> No
Enable NAT	<input checked="" type="radio"/> Yes <input type="radio"/> No
Enable UPnP <small>UPnP_FAQ</small>	<input checked="" type="radio"/> Yes <input type="radio"/> No
Enable WAN Aggregation	<input type="radio"/> Yes <input checked="" type="radio"/> No <small>WAN Aggregation combines two network connections to increase your WAN speed up to 2Gbps. Connect your router's WAN port and LAN 4 port to your modem's LAN ports (ensure you use two cables with the same specification). <a href="#">WAN Aggregation FAQ</a></small>

---

#### WAN DNS Setting

DNS Server	Default status: Get the DNS IP from your ISP automatically Assign a DNS service to improve security, block advertisement and gain faster performance. <span>Assign</span>
Forward local domain queries to upstream DNS	<input type="radio"/> Yes <input checked="" type="radio"/> No
Enable DNS Rebind protection	<input type="radio"/> Yes <input checked="" type="radio"/> No
Enable DNSSEC support	<input type="radio"/> Yes <input checked="" type="radio"/> No
Prevent client auto DoH	Auto
DNS Privacy Protocol	None

---

#### DHCP Option

Class Identifier (Option 60)	<input type="text"/>
Client Identifier (Option 61)	<input checked="" type="checkbox"/> IAID/DUID <input type="text"/>
Class Identifier (Option 60)	<input type="text"/>
Client Identifier (Option 61)	<input checked="" type="checkbox"/> IAID/DUID <input type="text"/>

---

#### Account Settings

Authentication	None
PPP Echo Interval	6
PPP Echo Max Failures	10

---

#### Special Requirement from ISP

Host Name	<input type="text"/>
MAC Address	<input type="text"/> <span>MAC Clone</span>
DHCP query frequency	Aggressive Mode
Extend the TTL value	<input type="radio"/> Yes <input checked="" type="radio"/> No
Spoof LAN TTL value	<input type="radio"/> Yes <input checked="" type="radio"/> No

Apply

## To configure the WAN connection settings:

1. From the navigation panel, go to **Advanced Settings > WAN > Internet Connection**.
2. Configure the following settings below. When done, click **Apply**.
  - **WAN Connection Type:** Choose your Internet Service Provider type. The choices are **Automatic IP**, **PPPoE**, **PPTP**, **L2TP** or **fixed IP**. Consult your ISP if the router is unable to obtain a valid IP address or if you are unsure the WAN connection type.
  - **Enable WAN:** Select **Yes** to allow the router Internet access. Select **No** to disable Internet access.
  - **Enable NAT:** NAT (Network Address Translation) is a system where one public IP (WAN IP) is used to provide Internet access to network clients with a private IP address in a LAN. The private IP address of each network client is saved in a NAT table and is used to route incoming data packets.
  - **Enable UPnP:** UPnP (Universal Plug and Play) allows several devices (such as routers, televisions, stereo systems, game consoles, and cellular phone), to be controlled via an IP-based network with or without a central control through a gateway. UPnP connects PCs of all form factors, providing a seamless network for remote configuration and data transfer. Using UPnP, a new network device is discovered automatically. Once connected to the network, devices can be remotely configured to support P2P applications, interactive gaming, video conferencing, and web or proxy servers. Unlike Port forwarding, which involves manually configuring port settings, UPnP automatically configures the router to accept incoming connections and direct requests to a specific PC on the local network.

- **Connect to DNS Server:** Allows this router to get the DNS IP address from the ISP automatically. A DNS is a host on the Internet that translates Internet names to numeric IP addresses.
- **Authentication:** This item may be specified by some ISPs. Check with your ISP and fill them in if required.
- **Host Name:** This field allows you to provide a host name for your router. It is usually a special requirement from your ISP. If your ISP assigned a host name to your computer, enter the host name here.
- **MAC Address:** MAC (Media Access Control) address is a unique identifier for your networking device. Some ISPs monitor the MAC address of networking devices that connect to their service and reject any unrecognized device that attempt to connect. To avoid connection issues due to an unregistered MAC address, you can:
  - Contact your ISP and update the MAC address associated with your ISP service.
  - Clone or change the MAC address of the ASUS wireless router to match the MAC address of the previous networking device recognized by the ISP.

### 3.13.2 Dual WAN

The Dual WAN allows you to select two ISP connections to your router, a primary WAN and a secondary WAN.

#### To configure Dual WAN:

1. From the navigation panel, go to **Advanced Settings > WAN**.
2. Go to **Dual WAN** field, turn **ON**.
3. Choose your **Primary WAN** and **Secondary WAN**. There are WAN, USB, Ethernet LAN and 2.5G WAN for your options.
4. Choose **Fail Over** or **Load Balance**.
5. Click **Apply**.

---

**NOTE:** Detailed explanations are available on the ASUS Support Site FAQ <https://www.asus.com/support/FAQ/1011719>

---

**WAN - Dual WAN**

ASUS Router provides Dual WAN support. Select Failover mode to use a secondary WAN for backup network access. Select Load Balance mode to optimize bandwidth, maximize throughput, minimize response time, and prevent data overload for both WAN connection. [Dual WAN FAQ](#)

To enable WAN Aggregation go to the [WAN-Internet Connection](#) page.

**Basic Config**

Enable Dual WAN	<input checked="" type="checkbox"/> ON
Primary WAN	WAN
Secondary WAN	USB
Dual WAN Mode	Fail Over <input checked="" type="checkbox"/> Allow fallback

**Auto Network Detection**

Detailed explanations are available on the [ASUS Support Site FAQ](#), which may help you use this function effectively.

Detect Interval	Every 5 seconds
Failover Trigger Condition	When the current WAN fails 1.2 continuous times, failover to Secondary WAN
Network Monitoring	<input checked="" type="checkbox"/> DNS Query <input checked="" type="checkbox"/> Ping

### 3.13.3 Port Trigger

Port range triggering opens a predetermined incoming port for a limited period of time whenever a client on the local area network makes an outgoing connection to a specified port. Port triggering is used in the following scenarios:

- More than one local client needs port forwarding for the same application at a different time.
- An application requires specific incoming ports that are different from the outgoing ports.

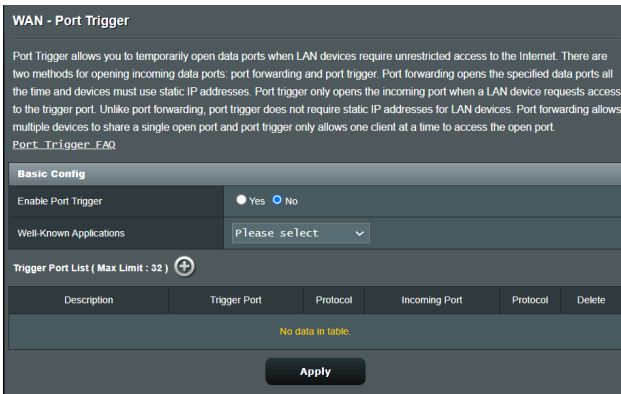

#### To set up Port Trigger:

1. From the navigation panel, go to **Advanced Settings > WAN > Port Trigger**.
2. Configure the following settings below. When done, click **Apply**.
  - **Enable Port Trigger:** Choose **Yes** to enable Port Trigger.
  - **Well-Known Applications:** Select popular games and web services to add to the Port Trigger List.
  - **Description:** Enter a short name or description for the service.

- **Trigger Port:** Specify a trigger port to open the incoming port.
- **Protocol:** Select the protocol, TCP, or UDP.
- **Incoming Port:** Specify an incoming port to receive inbound data from the Internet.
- **Protocol:** Select the protocol, TCP, or UDP.

---

**NOTES:**

- When connecting to an IRC server, a client PC makes an outgoing connection using the trigger port range 66660-7000. The IRC server responds by verifying the username and creating a new connection to the client PC using an incoming port.
  - If Port Trigger is disabled, the router drops the connection because it is unable to determine which PC is requesting for IRC access. When Port Trigger is enabled, the router assigns an incoming port to receive the inbound data. This incoming port closes once a specific time period has elapsed because the router is unsure when the application has been terminated.
  - Port triggering only allows one client in the network to use a particular service and a specific incoming port at the same time.
  - You cannot use the same application to trigger a port in more than one PC at the same time. The router will only forward the port back to the last computer to send the router a request/trigger.
-

### 3.13.4 Virtual Server/Port Forwarding

Port forwarding is a method to direct network traffic from the Internet to a specific port or a specific range of ports to a device or number of devices on your local network. Setting up Port Forwarding on your router allows PCs outside the network to access specific services provided by a PC in your network.

**NOTE:** When port forwarding is enabled, the ASUS router blocks unsolicited inbound traffic from the Internet and only allows replies from outbound requests from the LAN. The network client does not have access to the Internet directly, and vice versa.

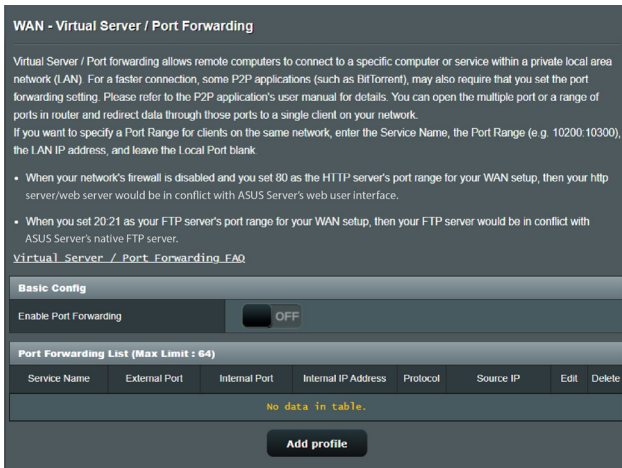

#### To set up Port Forwarding:

1. From the navigation panel, go to **Advanced Settings > WAN > Virtual Server / Port Forwarding**.

2. Configure the following settings below. When done, click **ON**.
- **Enable Port Forwarding:** Turn **ON** to enable Port Forwarding.
  - **Famous Server List:** Determine which type of service you want to access.
  - **Famous Game List:** This item lists ports required for popular online games to work correctly.
  - **FTP Server Port:** Avoid assigning the port range 20:21 for your FTP server as this would conflict with the router's native FTP server assignment.
  - **Service Name:** Enter a service name.
  - **Port Range:** If you want to specify a Port Range for clients on the same network, enter the Service Name, the Port Range (e.g. 10200:10300), the LAN IP address, and leave the Local Port empty. Port range accepts various formats such as Port Range (300:350), individual ports (566,789) or Mix (1015:1024,3021).

---

**NOTES:**

- When your network's firewall is disabled and you set 80 as the HTTP server's port range for your WAN setup, then your http server/web server would be in conflict with the router's web user interface.
  - A network makes use of ports in order to exchange data, with each port assigned a port number and a specific task. For example, port 80 is used for HTTP. A specific port can only be used by one application or service at a time. Hence, two PCs attempting to access data through the same port at the same time would fail. For example, you cannot set up Port Forwarding for port 100 for two PCs at the same time.
-

- **Local IP:** Key in the client's LAN IP address.

---

**NOTE:** Use a static IP address for the local client to make port forwarding work properly. Refer to section **3.9 LAN** for information.

---

- **Local Port:** Enter a specific port to receive forwarded packets. Leave this field blank if you want the incoming packets to be redirected to the specified port range.
- **Protocol:** Select the protocol. If you are unsure, select **BOTH**.

### **To check if Port Forwarding has been configured successfully:**

- Ensure that your server or application is set up and running.
- You will need a client outside your LAN but has Internet access (referred to as "Internet client"). This client should not be connected to the ASUS router.
- On the Internet client, use the router's WAN IP to access the server. If port forwarding has been successful, you should be able to access the files or applications.

### **Differences between port trigger and port forwarding:**

- Port triggering will work even without setting up a specific LAN IP address. Unlike port forwarding, which requires a static LAN IP address, port triggering allows dynamic port forwarding using the router. Predetermined port ranges are configured to accept incoming connections for a limited period of time. Port triggering allows multiple computers to run applications that would normally require manually forwarding the same ports to each PC on the network.
- Port triggering is more secure than port forwarding since the incoming ports are not open all the time. They are opened only when an application is making an outgoing connection through the trigger port.

### 3.13.5 DMZ

Virtual DMZ exposes one client to the Internet, allowing this client to receive all inbound packets directed to your Local Area Network.

Inbound traffic from the Internet is usually discarded and routed to a specific client only if port forwarding or a port trigger has been configured on the network. In a DMZ configuration, one network client receives all inbound packets.

Setting up DMZ on a network is useful when you need incoming ports open or you want to host a domain, web, or e-mail server.

---

**CAUTION:** Opening all the ports on a client to the Internet makes the network vulnerable to outside attacks. Please be aware of the security risks involved in using DMZ.

---

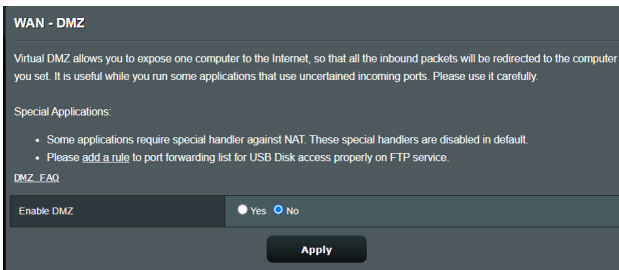

#### To set up DMZ:

1. From the navigation panel, go to **Advanced Settings > WAN > DMZ**.
2. Configure the setting below. When done, click **Apply**.
  - **IP address of Exposed Station:** Key in the client's LAN IP address that will provide the DMZ service and be exposed on the Internet. Ensure that the server client has a static IP address.

## To remove DMZ:

1. Delete the client's LAN IP address from the **IP Address of Exposed Station** text box.
2. When done, click **Apply**.

### 3.13.6 DDNS

Setting up DDNS (Dynamic DNS) allows you to access the router from outside your network through the provided ASUS DDNS Service or another DDNS service.

**WAN - DDNS**

DDNS (Dynamic Domain Name System) is a service that allows network clients to connect to the wireless router, even with a dynamic public IP address, through its registered domain name. The wireless router is embedded with the ASUS DDNS service and other DDNS services.

If you cannot use ASUS DDNS services, please go to <https://iplookup.asus.com/nslookup.php> to reach your internet IP address to use this service.

The wireless router currently uses a private WAN IP address.  
This router may be in the multiple-NAT environment and DDNS service cannot work in this environment.

The host name is successfully registered. You can use "[hostname].asuscomm.com" to access the service in home network from WAN. Use "[hostname].asuscomm.com" to remotely access your network.  
Go to [Advanced Settings > WAN](#) to configure the port forwarding or DMZ settings to allow other WAN clients to remotely access your network.  
If you want to remotely configure the wireless router, go to [here](#).

Enable the DDNS Client	<input checked="" type="radio"/> Yes <input type="radio"/> No
Server	www.asus.com <input type="button" value="Deregister"/>
Host Name	ABB78A17504AGFD5402E6BD6195085EF7.asuscomm.com
DDNS Status	Active
DDNS Registration Result	Registration is successful.
HTTPS/SSL Certificate	<input type="radio"/> Free Certificate from Let's Encrypt <input type="radio"/> Import Your Own Certificate <input checked="" type="radio"/> None

## To set up DDNS:

1. From the navigation panel, go to **Advanced Settings > WAN > DDNS**.
2. Configure the following settings below. When done, click **Apply**.
  - **Enable the DDNS Client:** Enable DDNS to access the ASUS router via the DNS name rather than WAN IP address.
  - **Server and Host Name:** Choose ASUS DDNS or other DDNS. If you want to use ASUS DDNS, fill in the Host Name in the format of xxx.asuscomm.com (xxx is your host name).

- If you want to use a different DDNS service, click FREE TRIAL and register online first. Fill in the User Name or E-mail Address and Password or DDNS Key fields.
- **Enable wildcard:** Enable wildcard if your DDNS service requires one.

---

## NOTES:

DDNS service will not work under these conditions:

- When the wireless router is using a private WAN IP address (192.168.x.x, 10.x.x.x, or 172.16.x.x), as indicated by a yellow text.
  - The router may be on a network that uses multiple NAT tables.
- 

### 3.13.7 NAT Passthrough

NAT Passthrough allows a Virtual Private Network (VPN) connection to pass through the router to the network clients. PPTP Passthrough, L2TP Passthrough, IPsec Passthrough and RTSP Passthrough are enabled by default.

To enable / disable the NAT Passthrough settings, go to the **Advanced Settings > WAN > NAT Passthrough**. When done, click **Apply**.

WAN - NAT Passthrough	
Enable NAT Passthrough to allow a Virtual Private Network (VPN) connection to pass through the router to the network clients.	
PPTP Passthrough	Enable
L2TP Passthrough	Enable
IPsec Passthrough	Enable
RTSP Passthrough	Enable
H.323 Passthrough	Enable
SIP Passthrough	Enable
PPPoE Relay	Disable
FTP ALG port	2021

Apply

# 3.14 Wireless

## 3.14.1 General

The General tab allows you to configure the basic wireless settings.

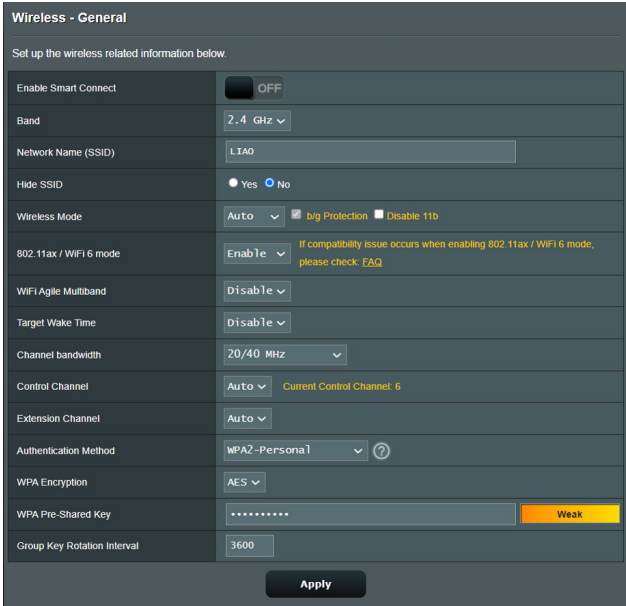

### To configure the basic wireless settings:

1. From the navigation panel, go to **Advanced Settings > Wireless > General**.
2. Select 2.4GHz, 5GHz or 6GHz as the frequency band for your wireless network.
3. Assign a unique name containing up to 32 characters for your SSID (Service Set Identifier) or network name to identify your wireless network. Wi-Fi devices can identify and connect to the wireless network via your assigned SSID. The SSIDs on the information banner are updated once new SSIDs are saved to the settings.

---

**NOTE:** You can assign unique SSIDs for the 2.4 GHz, 5GHz and 6GHz frequency bands.

---

4. In the **Hide SSID** field, select **Yes** to prevent wireless devices from detecting your SSID. When this function is enabled, you would need to enter the SSID manually on the wireless device to access the wireless network.
5. Select any of these wireless mode options to determine the types of wireless devices that can connect to your wireless router:
  - **Auto:** Select **Auto** to allow 802.11AC, 802.11n, 802.11g, and 802.11b devices to connect to the wireless router.
  - **Legacy:** Select **Legacy** to allow 802.11b/g/n devices to connect to the wireless router. Hardware that supports 802.11n natively, however, will only run at a maximum speed of 54Mbps.
  - **N only:** Select **N only** to maximize wireless N performance. This setting prevents 802.11g and 802.11b devices from connecting to the wireless router.
6. Select any of these channel bandwidth to accommodate higher transmission speeds:
  - 40MHz:** Select this bandwidth to maximize the wireless throughput.
  - 20MHz (default):** Select this bandwidth if you encounter some issues with your wireless connection.
7. Select the operating channel for your wireless router. Select **Auto** to allow the wireless router to automatically select the channel that has the least amount of interference.
8. Select any of these authentication methods:
  - **Open System:** This option provides no security.
  - **Shared Key:** You must use WEP encryption and enter at least one shared key.

- **WPA/WPA2 Personal/WPA Auto-Personal:** This option provides strong security. You can use either WPA (with TKIP) or WPA2 (with AES). If you select this option, you must use TKIP + AES encryption and enter the WPA passphrase (network key).
- **WPA/WPA2 Enterprise/WPA Auto-Enterprise:** This option provides very strong security. It is with integrated EAP server or an external RADIUS back-end authentication server.
- **Radius with 802.1x**

---

**NOTE:** Your wireless router supports the maximum transmission rate of 54Mbps when the **Wireless Mode** is set to **Auto** and **encryption method** is **WEP** or **TKIP**.

---

9. Select any of these WEP (Wired Equivalent Privacy) Encryption options for the data transmitted over your wireless network:
  - **Off:** Disables WEP encryption
  - **64-bit:** Enables weak WEP encryption
  - **128-bit:** Enables improved WEP encryption
10. When done, click **Apply**.

## 3.14.2 WPS

WPS (Wi-Fi Protected Setup) is a wireless security standard that allows you to easily connect devices to a wireless network. You can configure the WPS function via the PIN code or WPS button.

**NOTE:** Ensure that the devices support WPS.

**Wireless - WPS**

WPS (WiFi Protected Setup) provides easy and secure establishment of a wireless network. You can configure WPS here via the PIN code or the WPS button.

Enable WPS	<input checked="" type="checkbox"/>
Current Frequency	2.4 GHz
Connection Status	Idle
Configured	Enabled <input type="button" value="Reset"/> Pressing the reset button resets the network name (SSID) and WPA encryption key
AP PIN Code	<input type="text" value="51246044"/>

You can easily connect a WPS client to the network in either of these two ways:

- Method1: Click the WPS button on this interface (or press the physical WPS button on the router), then press the WPS button on the client's WLAN adapter and wait for about three minutes to make the connection.
- Method2: Start the client WPS process and get the client PIN code. Enter the client's PIN code on the Client PIN code field and click Start. Please check the user manual of your wireless client to see if it supports the WPS function. If your wireless client does not support the WPS function, you have to configure the wireless client manually and set the same network Name (SSID), and security settings as this router.

WPS Method:  Push button  Client PIN Code

### To enable WPS on your wireless network:

1. From the navigation panel, go to **Advanced Settings > Wireless > WPS**.
2. In the **Enable WPS** field, move the slider to **ON**.
3. WPS uses 2.4GHz by default. If you want to change the frequency to 5GHz or 6GHz, turn **OFF** the WPS function, click **Switch Frequency** in the **Current Frequency** field, and turn **WPS ON** again.

**NOTE:** WPS supports authentication using Open System, WPA-Personal, and WPA2-Personal. WPS does not support a wireless network that uses a Shared Key, WPA-Enterprise, WPA2-Enterprise, and RADIUS encryption method.

3. In the WPS Method field, select **Push Button** or **Client PIN** code. If you select **Push Button**, go to step 4. If you select **Client PIN** code, go to step 5.
4. To set up WPS using the router's WPS button, follow these steps:
  - a. Click **Start** or press the WPS button found at the rear of the wireless router.
  - b. Press the WPS button on your wireless device. This is normally identified by the WPS logo.

---

**NOTE:** Check your wireless device or its user manual for the location of the WPS button.

---

- c. The wireless router will scan for any available WPS devices. If the wireless router does not find any WPS devices, it will switch to standby mode.
5. To set up WPS using the Client's PIN code, follow these steps:
  - a. Locate the WPS PIN code on your wireless device's user manual or on the device itself.
  - b. Key in the Client PIN code on the text box.
  - c. Click **Start** to put your wireless router into WPS survey mode. The router's LED indicators quickly flash three times until the WPS setup is completed.

### 3.14.3 Bridge

Bridge or WDS (Wireless Distribution System) allows your ASUS wireless router to connect to another wireless access point exclusively, preventing other wireless devices or stations to access your ASUS wireless router. It can also be considered as a wireless repeater where your ASUS wireless router communicates with another access point and other wireless devices.

**Wireless - Bridge**

Bridge (or named WDS - Wireless Distribution System) function allows your ASUS Router to connect to an access point wirelessly. WDS may also be considered a repeater mode.

**Note:**

The function only support [Open System/NONE, Open System/WEP] security authentication method. To set up the corresponding authentication method, please select Legacy as your wireless mode first. [Click Here to modify.](#) Please refer to this [FAQ](#) for more details.

To enable WDS to extend the wireless signal, please follow these steps :

1. Select [WDS Only] or [Hybrid] mode and add MAC address of APs in Remote AP List.
2. Ensure that this wireless router and the AP you want to connect to use the same channel.
3. Key in the remote AP mac in the remote AP list and open the remote AP's WDS management interface, key in the this router's MAC address.
4. To get the best performance, please go to Advanced Settings > Wireless > General and assign the same channel bandwidth, control channel, and extension channel to every router in the network.

You are currently using the Auto channel bandwidth. [Click Here to modify.](#)  
You are currently using the Auto channel. [Click Here to modify.](#)

**Basic Config**

2.4 GHz MAC	<input type="text" value="C8:7F:54:12:69:c8"/>
5 GHz MAC	<input type="text" value="C8:7F:54:12:69:cc"/>
Band	<input type="text" value="2.4 GHz"/>
AP Mode	<input type="text" value="AP Only"/>
Connect to APs in list	<input type="radio"/> Yes <input checked="" type="radio"/> No

**Remote AP List (Max Limit : 4)**

Remote AP List	Add / Delete
<input type="text"/>	<input type="button" value="⊕"/>

No data in table.

To set up the wireless bridge:

1. From the navigation panel, go to **Advanced Settings > Wireless > WDS**.
2. Select the frequency band for the wireless bridge.
3. In the **AP Mode** field, select any of these options:
  - **AP Only**: Disables the Wireless Bridge function.

- **WDS Only:** Enables the Wireless Bridge feature but prevents other wireless devices/stations from connecting to the router.
- **HYBRID:** Enables the Wireless Bridge feature and allows other wireless devices/stations to connect to the router.

---

**NOTE:** In Hybrid mode, wireless devices connected to the ASUS wireless router will only receive half the connection speed of the Access Point.

---

4. In the **Connect to APs in list** field, click **Yes** if you want to connect to an Access Point listed in the Remote AP List.
5. In the **Control Channel** field, select the operating channel for the wireless bridge. Select **Auto** to allow the router to automatically select the channel with the least amount of interference.

---

**NOTE:** Channel availability varies per country or region.

---

6. On the Remote AP List, key in a MAC address and click the **Add** button  to enter the MAC address of other available Access Points.

---

**NOTE:** Any Access Point added to the list should be on the same Control Channel as the ASUS wireless router.

---

7. Click **Apply**.

### 3.14.4 Wireless MAC Filter

Wireless MAC filter provides control over packets transmitted to a specified MAC (Media Access Control) address on your wireless network.

Wireless - Wireless MAC Filter

Wireless MAC filter allows you to control packets from devices with specified MAC address in your Wireless LAN.

**Basic Config**

Band: 2.4GHz

Enable MAC Filter:  Yes  No

MAC Filter Mode: Accept

**MAC filter list (Max Limit : 64)**

Client Name (MAC Address)	Add / Delete

No data in table.

Apply

#### To set up the Wireless MAC filter:

1. From the navigation panel, go to **Advanced Settings > Wireless > Wireless MAC Filter**.
2. Tick **Yes** in the **Enable Mac Filter** field.
3. In the **MAC Filter Mode** dropdown list, select either **Accept** or **Reject**.
  - Select **Accept** to allow devices in the MAC filter list to access to the wireless network.
  - Select **Reject** to prevent devices in the MAC filter list to access to the wireless network.
4. On the MAC filter list, click the **Add**  button and key in the MAC address of the wireless device.
5. Click **Apply**.

### 3.14.5 RADIUS Setting

RADIUS (Remote Authentication Dial In User Service) Setting provides an extra layer of security when you choose WPA-Enterprise, WPA2-Enterprise, or Radius with 802.1x as your Authentication Mode.

Wireless - RADIUS Setting	
This section allows you to set up additional parameters for authorizing wireless clients through RADIUS server. It is required while you select "Authentication Method" in "Wireless - General" as "WPA-Enterprise / WPA2-Enterprise".	
Band	2.4GHz ▼
Server IP Address	<input type="text"/>
Server Port	1812
Connection Secret	<input type="text"/>
<b>Apply</b>	

#### To set up wireless RADIUS settings:

1. Ensure that the wireless router's authentication mode is set to WPA-Enterprise, WPA2-Enterprise, or Radius with 802.1x.

---

**NOTE:** Please refer to section **3.14.1 General** section for configuring your wireless router's Authentication Mode.

---

2. From the navigation panel, go to **Advanced Settings > Wireless > RADIUS Setting**.
3. Select the frequency band.
4. In the **Server IP Address** field, key in your RADIUS server's IP Address.
5. In the **Connection Secret** field, assign the password to access your RADIUS server.
6. Click **Apply**.

### 3.14.6 Professional

The Professional screen provides advanced configuration options.

**NOTE:** We recommend that you use the default values on this page.

Wireless - Professional	
Wireless Professional Setting allows you to set up additional parameters for wireless. But default values are recommended.	
Band	2.4 GHz
Enable Radio	<input checked="" type="radio"/> Yes <input type="radio"/> No
Enable wireless scheduler	<input type="radio"/> Yes <input checked="" type="radio"/> No
Set AP Isolated	<input type="radio"/> Yes <input checked="" type="radio"/> No
Roaming assistant	Enable Disconnect clients with RSSI lower than: -70 dBm
Bluetooth Coexistence	Disable
Enable IGMP Snooping	Enable
Multicast Rate(Mbps)	Auto
Preamble Type	Long
AMPDU RTS	Enable
RTS Threshold	2347
DTIM Interval	1
Beacon Interval	100
Enable TX Bursting	Enable
Enable WMM	Enable
Enable WMM No-Acknowledgement	Disable
Enable WMM APSD	Enable
Optimize AMPDU aggregation	Disable
Modulation Scheme	Up to MCS 11 (NitroQAM/1024-QAM)
Airtime Fairness	Disable
Multi-User MIMO	Enable
OFDMA/802.11ax MU-MIMO	Disable
Explicit Beamforming	Enable
Universal Beamforming	Enable
Tx power adjustment	<input type="range"/> Performance
<b>Apply</b>	

In the **Professional** settings screen, you can configure the following:

- **Band:** Select the frequency band that the professional settings will be applied to.
- **Enable Radio:** Select **Yes** to enable wireless networking. Select **No** to disable wireless networking.

- **Enable wireless scheduler:** You can choose clock format as 24-hour or 12-hour. The color in the table indicates Allow or Deny. Click each frame to change the settings of the hour of the weekdays and click **OK** when done.

Wireless - Professional

\* Reminder: The System time zone is different from your locale setting.

Clock Format: 24-hour ▾ Allow  Deny

Active Schedule

System Time: Thu, Aug 23 06:59:27 2018

Select All	Sun	Mon	Tue	Wed	Thu	Fri	Sat
00 ~ 01							
01 ~ 02							
02 ~ 03							
03 ~ 04							
04 ~ 05							
05 ~ 06							
06 ~ 07							
07 ~ 08							
08 ~ 09							
09 ~ 10							
10 ~ 11							
11 ~ 12							
12 ~ 13							
13 ~ 14							
14 ~ 15							
15 ~ 16							
16 ~ 17							
17 ~ 18							
18 ~ 19							
19 ~ 20							
20 ~ 21							
21 ~ 22							
22 ~ 23							
23 ~ 24							

Cancel OK

- **Set AP isolated:** The Set AP isolated item prevents wireless devices on your network from communicating with each other. This feature is useful if many guests frequently join or leave your network. Select **Yes** to enable this feature or select **No** to disable.
- **Multicast rate (Mbps):** Select the multicast transmission rate or click **Disable** to switch off simultaneous single transmission.
- **Preamble Type:** Preamble Type defines the length of time that the router spent for CRC (Cyclic Redundancy Check). CRC is a method of detecting errors during data transmission. Select **Short** for a busy wireless network with high network traffic. Select **Long** if your wireless network is composed of older or legacy wireless devices.

- **RTS Threshold:** Select a lower value for RTS (Request to Send) Threshold to improve wireless communication in a busy or noisy wireless network with high network traffic and numerous wireless devices.
- **DTIM Interval:** DTIM (Delivery Traffic Indication Message) Interval or Data Beacon Rate is the time interval before a signal is sent to a wireless device in sleep mode indicating that a data packet is awaiting delivery. The default value is three milliseconds.
- **Beacon Interval:** Beacon Interval is the time between one DTIM and the next. The default value is 100 milliseconds. Lower the Beacon Interval value for an unstable wireless connection or for roaming devices.
- **Enable TX Bursting:** Enable TX Bursting improves transmission speed between the wireless router and 802.11g devices.
- **Enable WMM APSD:** Enable WMM APSD (Wi-Fi Multimedia Automatic Power Save Delivery) to improve power management between wireless devices. Select **Disable** to switch off WMM APSD.

# 4 Utilities

---

## NOTES:

- Download and install the wireless router's utilities from the ASUS website:
    - Device Discovery v1.4.8.3 at <https://dlcdnets.asus.com/pub/ASUS/LiveUpdate/Release/Wireless/Discovery.zip>
    - Firmware Restoration v2.1.0.3 at <https://dlcdnets.asus.com/pub/ASUS/LiveUpdate/Release/Wireless/Rescue.zip>
    - Windows Printer Utility v1.0.5.5 at <http://dlcdnets.asus.com/pub/ASUS/LiveUpdate/Release/Wireless/Printer.zip>
  - The utilities are not supported on MAC OS.
- 

## 4.1 Device Discovery

Device Discovery is an ASUS WLAN utility that detects an ASUS wireless router device, and allows you to configure the wireless networking settings.

### To launch the Device Discovery utility:

- From your computer's desktop, click **Start > All Programs > ASUS Utility > Wireless Router > Device Discovery.**

---

**NOTE:** When you set the router to Access Point mode, you need to use Device Discovery to get the router's IP address.

---

## 4.2 Firmware Restoration

Firmware Restoration is used on an ASUS Wireless Router that failed during its firmware upgrading process. It uploads the firmware that you specify. The process takes about three to four minutes.

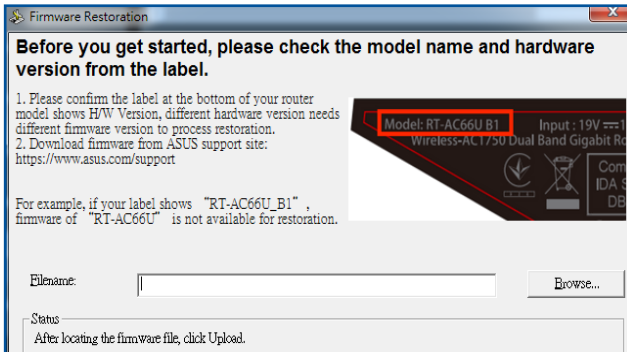

---

**IMPORTANT!** Launch the rescue mode on the router before using the Firmware Restoration utility.

---

**NOTE:** This feature is not supported on MAC OS.

---

### To launch the rescue mode and use the Firmware Restoration utility:

1. Unplug the wireless router from the power source.
2. Hold the Reset button at the rear panel and simultaneously replug the wireless router into the power source. Release the Reset button when the Power LED at the front panel flashes slowly, which indicates that the wireless router is in the rescue mode.

3. Set a static IP on your computer and use the following to set up your TCP/IP settings:

**IP address:** 192.168.1.x

**Subnet mask:** 255.255.255.0

4. From your computer's desktop, click **Start > All Programs > ASUS Utility > Wireless Router > Firmware Restoration.**
5. Specify a firmware file, then click **Upload.**

---

**NOTE:** This is not a firmware upgrade utility and cannot be used on a working ASUS Wireless Router. Normal firmware upgrades must be done through the web interface. Refer to **Chapter 3: Configuring the General and Advanced Settings** for more details.

---

## 4.3 Setting up your printer server

### 4.3.1 ASUS EZ Printer Sharing

ASUS EZ Printing Sharing utility allows you to connect a USB printer to your wireless router's USB port and set up the print server. This allows your network clients to print and scan files wirelessly.

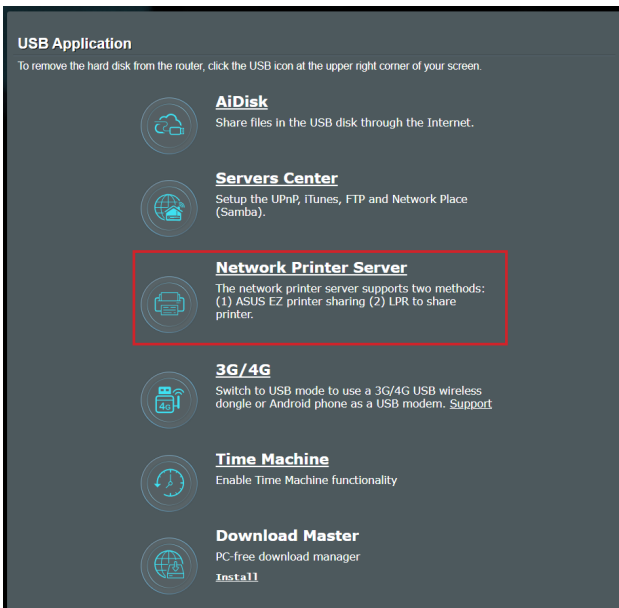

---

**NOTE:** The print server function is supported on Windows® 10 and Windows® 11.

---

**To set up the EZ Printer sharing mode:**

1. From the navigation panel, go to **General > USB Application > Network Printer Server**.
2. Click **Download Now!** to download the network printer utility.

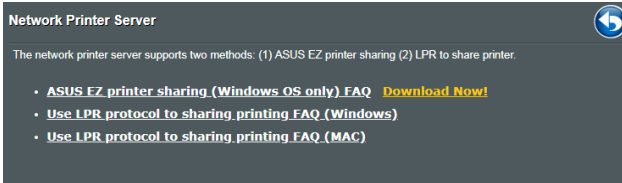

**NOTE:** Network printer utility is supported on Windows® 10 and Windows® 11 only. To install the utility on Mac OS, select **Use LPR protocol for sharing printer**.

3. Unzip the downloaded file and click the Printer icon to run the network printer setup program.

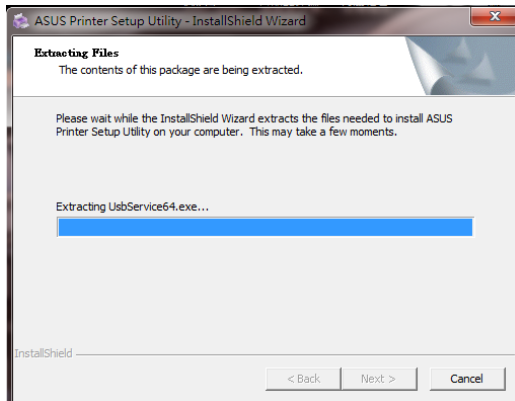
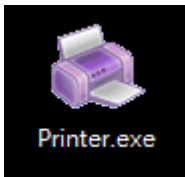

4. Follow the onscreen instructions to set up your hardware, then click **Next**.

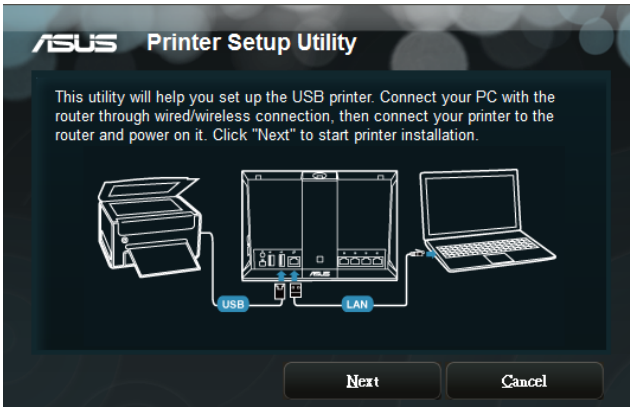

5. Wait a few minutes for the initial setup to finish. Click **Next**.
6. Click **Finish** to complete the installation.
7. Follow the Windows® OS instructions to install the printer driver.



8. After the printer's driver installation is complete, network clients can now use the printer.

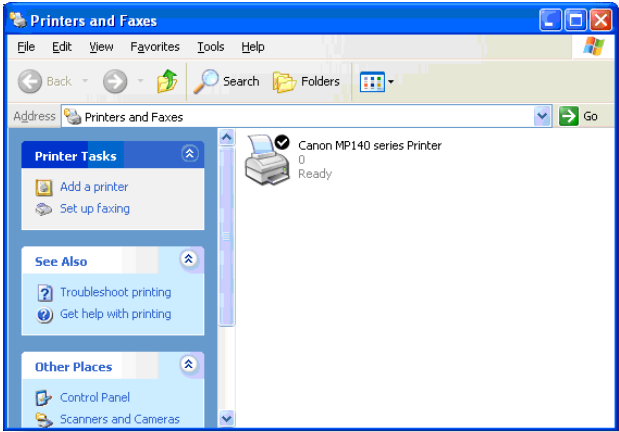

## 4.3.2 Using LPR to Share Printer

You can share your printer with computers running on Windows® and MAC operating system using LPR/LPD (Line Printer Remote/ Line Printer Daemon).

### Sharing your LPR printer

#### To share your LPR printer:

1. From the Windows® desktop, click **Start > Devices and Printers > Add a printer** to run the **Add Printer Wizard**.

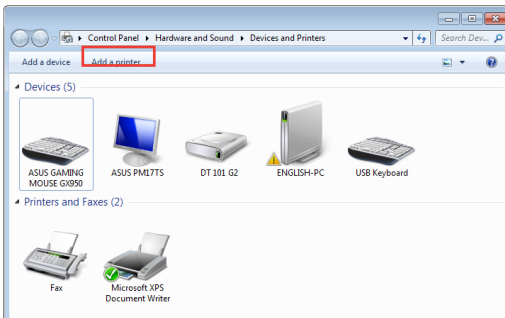

2. Select **Add a local printer** and then click **Next**.

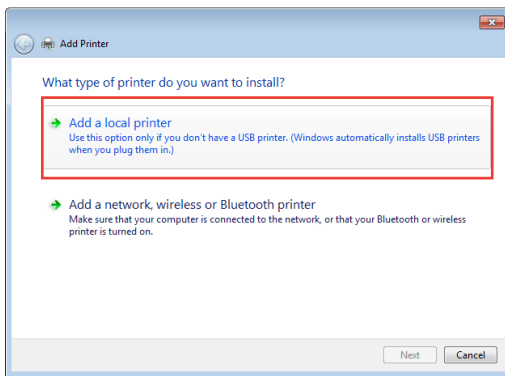

3. Select **Create a new port** then set **Type of Port** to **Standard TCP/IP Port**. Click **New Port**.

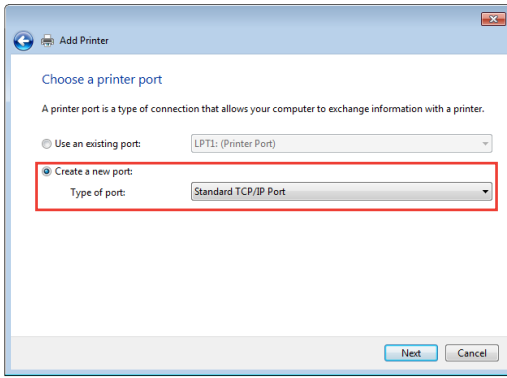

4. In the **Hostname or IP address** field, key in the IP address of the wireless router then click **Next**.

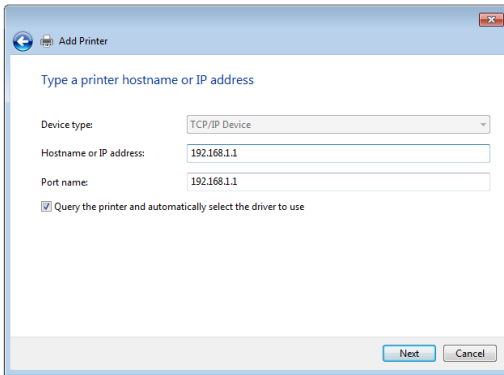

5. Select **Custom** then click **Settings**.

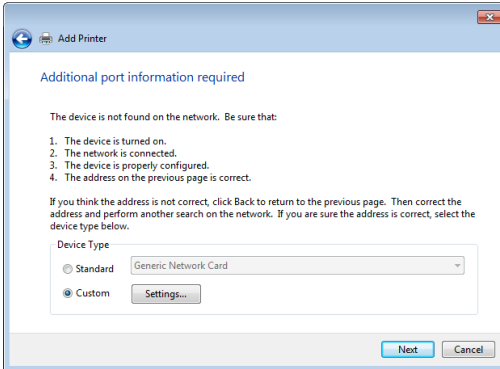

6. Set **Protocol** to **LPR**. In the **Queue Name** field, key in **LPRServer** then click **OK** to continue.

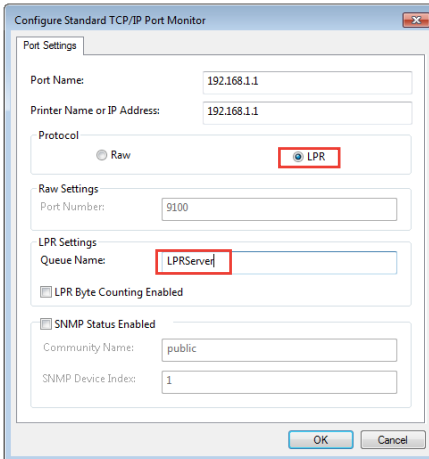

7. Click **Next** to finish setting up the standard TCP/IP port.

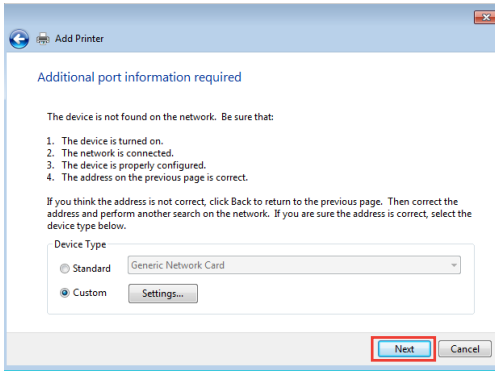

8. Install the printer driver from the vendor-model list. If your printer is not in the list, click **Have Disk** to manually install the printer drivers from a CD-ROM or file.

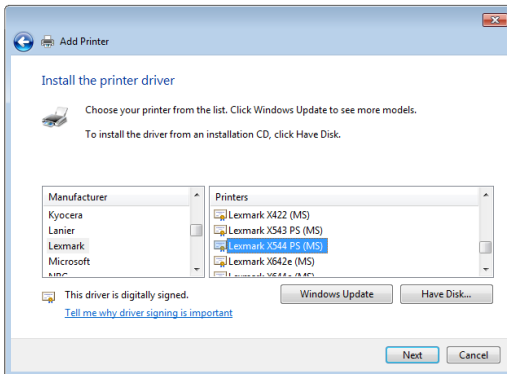

9. Click **Next** to accept the default name for the printer.

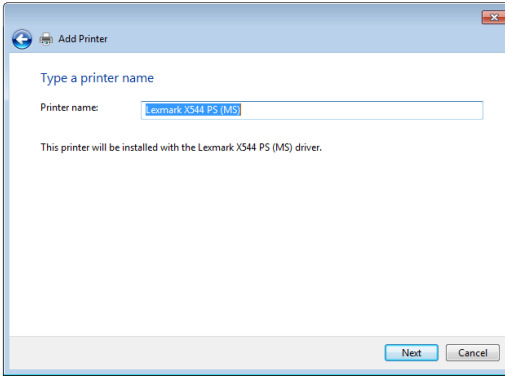

10. Click **Finish** to complete the installation.

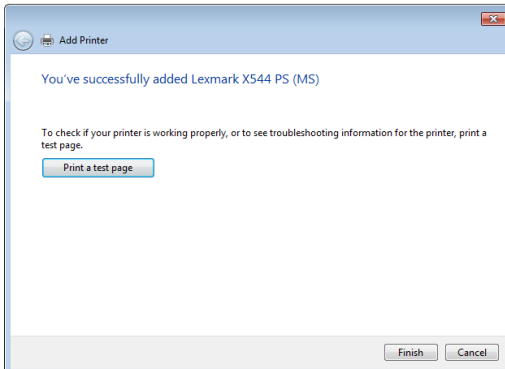

## 4.4 Download Master

Download Master is a utility that helps you download files even while your laptops or other devices are switched off.

---

**NOTE:** You need a USB device connected to the wireless router to use Download Master.

---

### To use Download Master:

1. Click **General > USB application > Download Master** to download and install the utility automatically.

---

**NOTE:** If you have more than one USB drive, select the USB device you want to download the files to.

---

2. After the download process is finished, click the Download Master icon to start using the utility.
3. Click **Add** to add a download task.

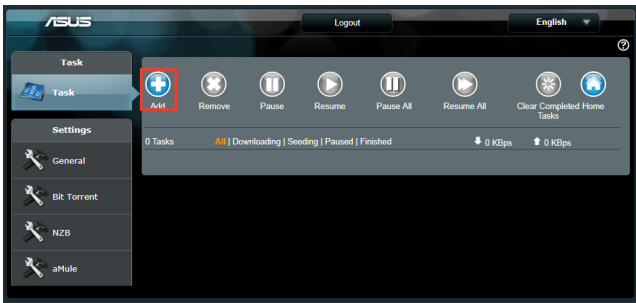

4. Select a download type such as BitTorrent, HTTP, or FTP. Provide a torrent file or a URL to begin downloading.

---

**NOTE:** For details on Bit Torrent, refer to section **4.4.1 Configuring Bit Torrent download settings**.

---

5. Use the navigation panel to configure the advanced settings.

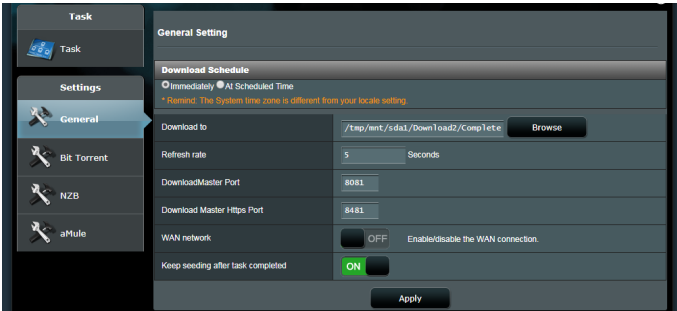

## 4.4.1 Configuring Bit Torrent download settings

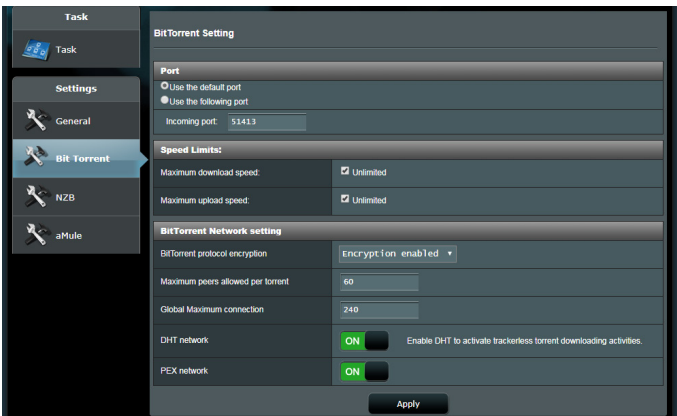

### To configure BitTorrent download settings:

1. From Download Master's navigation panel, click **Bit Torrent** to launch the **Bit Torrent Setting** page.
2. Select a specific port for your download task.
3. To prevent network congestion, you can limit the maximum upload and download speeds under **Speed Limits**.
4. You can limit the maximum number of allowed peers and enable or disable file encryption during downloads.

## 4.4.2 NZB settings

You can set up a USENET server to download NZB files. After entering USENET settings, **Apply**.

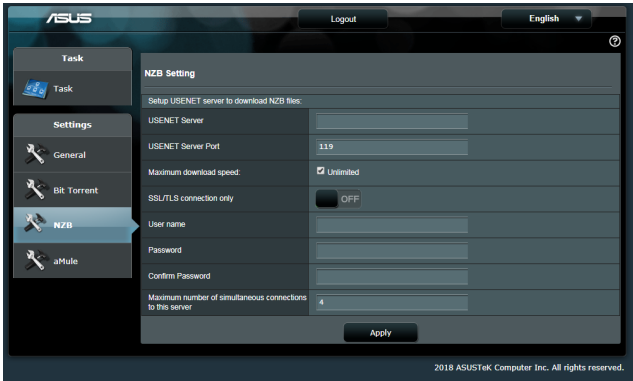

# 5 Troubleshooting

This chapter provides solutions for issues you may encounter with your router. If you encounter problems that are not mentioned in this chapter, visit the ASUS support site at:

<https://www.asus.com/support/> for more product information and contact details of ASUS Technical Support.

## 5.1 Basic Troubleshooting

If you are having problems with your router, try these basic steps in this section before looking for further solutions.

### Upgrade Firmware to the latest version.

1. Launch the Web GUI. Go to **Advanced Settings > Administration > Firmware Upgrade**. Click **Check** to verify if the latest firmware is available.

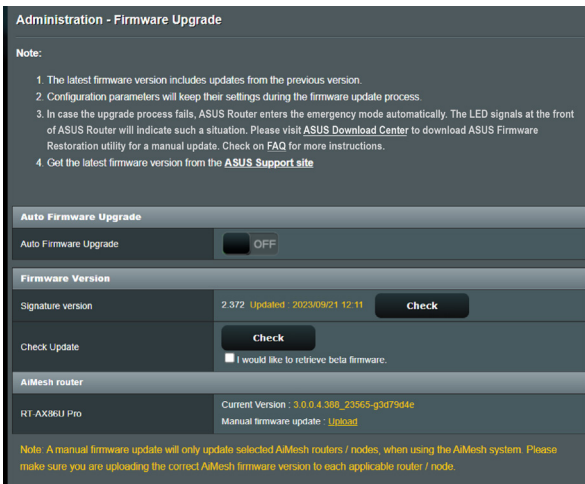

2. If the latest firmware is available, visit the ASUS global website at [https://www.asus.com/networking-iot-servers/whole-home-mesh-wifi-system/zenwifi-wifi-systems/asus-zenwifi-et9/helpdesk\\_bios/?model2Name=ASUS-ZenWiFi-ET9](https://www.asus.com/networking-iot-servers/whole-home-mesh-wifi-system/zenwifi-wifi-systems/asus-zenwifi-et9/helpdesk_bios/?model2Name=ASUS-ZenWiFi-ET9) to download the latest firmware.
3. From the **Firmware Version** page, click **Check** to locate the firmware file.
4. Click **Upload** to upgrade the firmware.

### **Restart your network in the following sequence:**

1. Turn off the modem.
2. Unplug the modem.
3. Turn off the router and computers.
4. Plug in the modem.
5. Turn on the modem and then wait for 2 minutes.
6. Turn on the router and then wait for 2 minutes.
7. Turn on computers.

### **Check if your Ethernet cables are plugged properly.**

- When the Ethernet cable connecting the router with the modem is plugged in properly, the WAN LED will be on.
- When the Ethernet cable connecting your powered-on computer with the router is plugged in properly, the corresponding LAN LED will be on.

### **Check if the wireless setting on your computer matches that of your router.**

- When you connect your computer to the router wirelessly, ensure that the SSID (wireless network name), encryption method, and password are correct.

### **Check if your network settings are correct.**

- Each client on the network should have a valid IP address. ASUS recommends that you use the wireless router's DHCP server to assign IP addresses to computers on your network.

- Some cable modem service providers require you to use the MAC address of the computer initially registered on the account. You can view the MAC address in the web GUI, **Network Map > Clients** page, and hover the mouse pointer over your device in **Client status**.



## 5.2 Frequently Asked Questions (FAQs)

### I cannot access the router GUI using a web browser

- If your computer is wired, check the Ethernet cable connection and LED status as described in the previous section.
- Ensure that you are using the correct login information. Ensure that the Caps Lock key is disabled when you enter the login information.
- Delete the cookies and files in your web browser. For Internet Explorer, follow these steps:

1. Launch Internet Explorer, then click **Tools > Internet Options**.
2. In the **General** tab, under **Browsing history**, click **Delete...**, select **Temporary Internet files and website files** and **Cookies and website data** then click **Delete**.

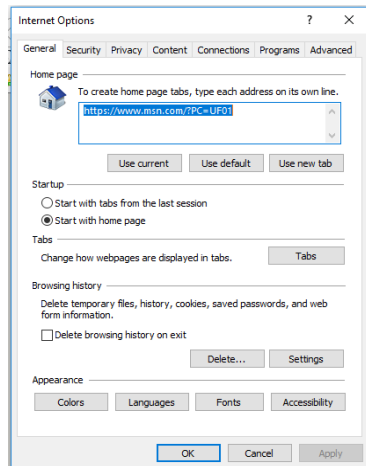

#### NOTES:

- The commands for deleting cookies and files vary with web browsers.
- Disable proxy server settings, cancel the dial-up connection, and set the TCP/IP settings to obtain IP addresses automatically. For more details, refer to Chapter 1 of this user manual.
- Ensure that you use CAT5e or CAT6 ethernet cables.

## The client cannot establish a wireless connection with the router.

**NOTE:** If you are having issues connecting to 5GHz network, make sure that your wireless device supports 5GHz or features dual band capabilities.

- **Out of Range:**
  - Move the router closer to the wireless client.
- **DHCP server has been disabled:**
  1. Launch the web GUI. Go to **General > Network Map > Clients** and search for the device that you want to connect to the router.
  2. If you cannot find the device in the **Network Map**, go to **Advanced Settings > LAN > DHCP Server, Basic Config** list, select **Yes** on the **Enable the DHCP Server**.

### LAN - DHCP Server

DHCP (Dynamic Host Configuration Protocol) is a protocol for the automatic configuration used on IP networks. The DHCP server can assign each client an IP address and informs the client of the DNS server IP and default gateway IP. ASUS Router supports up to 253 IP addresses for your local network.  
[Manually Assigned IP around the DHCP list FAQ](#)

#### Basic Config

Enable the DHCP Server	<input checked="" type="radio"/> Yes <input type="radio"/> No
ASUS Router's Domain Name	<input type="text"/>
IP Pool Starting Address	<input type="text" value="192.168.50.2"/>
IP Pool Ending Address	<input type="text" value="192.168.50.254"/>
Lease time	<input type="text" value="86400"/>
Default Gateway	<input type="text"/>

#### DNS and WINS Server Setting

DNS Server 1	<input type="text"/>
DNS Server 2	<input type="text"/>
Advertise router's IP in addition to user-specified DNS	<input checked="" type="radio"/> Yes <input type="radio"/> No
WINS Server	<input type="text"/>

#### Manual Assignment

Enable Manual Assignment	<input type="radio"/> Yes <input checked="" type="radio"/> No
--------------------------	---

#### Manually Assigned IP around the DHCP list (Max Limit : 64)

Client Name (MAC Address)	IP Address	DNS Server (Optional)	Host Name (Optional)	Add / Delete
<input type="text" value="192.168.1.100"/>	<input type="text"/>	<input type="text"/>	<input type="text"/>	<input type="button" value="⊕"/>

No data in table.

- SSID has been hidden. If your device can find SSIDs from other routers but cannot find your router's SSID, go to **Advanced Settings > Wireless > General**, select **No** on **Hide SSID**, and select **Auto** on **Control Channel**.

Wireless - General

Set up the wireless related information below.

Enable Smart Connect	<input type="checkbox"/> OFF
Band	2.4 GHz
Network Name (SSID)	LIAO
Hide SSID	<input checked="" type="radio"/> Yes <input type="radio"/> No
Wireless Mode	Auto <input checked="" type="checkbox"/> b/g Protection <input type="checkbox"/> Disable 11b
802.11ax / WiFi 6 mode	Enable <small>If compatibility issue occurs when enabling 802.11ax / WiFi 6 mode, please check FAQ</small>
WiFi Agile Multiband	Disable
Target Wake Time	Disable
Channel bandwidth	20/40 Mhz
Control Channel	Auto <small>Current Control Channel: 5</small>
Extension Channel	Auto
Authentication Method	WPA2-Personal
WPA Encryption	AES
WPA Pre-Shared Key	***** <span style="background-color: yellow;">Weak</span>
Group Key Rotation Interval	3600

**Apply**

- If you are using a wireless LAN adapter, check if the wireless channel in use conforms to the channels available in your country/area. If not, adjust the channel, channel bandwidth, and wireless mode.
- If you still cannot connect to the router wirelessly, you can reset your router to factory default settings. In the router GUI, click **Administration > Restore/Save/Upload Setting** and click **Restore**.

Administration - Restore/Save/Upload Setting

This function allows you to save current settings of ASUS Router to a file, or load settings from a file.

Factory default	<b>Restore</b> <input type="checkbox"/> Initialize all the settings, and clear all the data log for AiProtection, Traffic Analyzer, and Web History.
Save setting	<b>Save setting</b> <input type="checkbox"/> Click on this checkbox if you want to share the config file for debugging. Since the original password in the config file will be removed, please do not import the file into your router. <input type="checkbox"/> Transfer ASUS DDNS name
Restore setting	<b>Upload</b>

## Internet is not accessible.

- Check if your router can connect to your ISP's WAN IP address. To do this, launch the web GUI and go to **General > Network Map**, and check the **Internet status**.
- If your router cannot connect to your ISP's WAN IP address, try restarting your network as described in the section **Restart your network in following sequence** under **Basic Troubleshooting**.



- The device has been blocked via the Parental Control function. Go to **General > Parental Controls** and see if the device is in the list. If the device is listed under **Client Name**, remove the device using the **Delete** button or adjust the Time Management Settings.

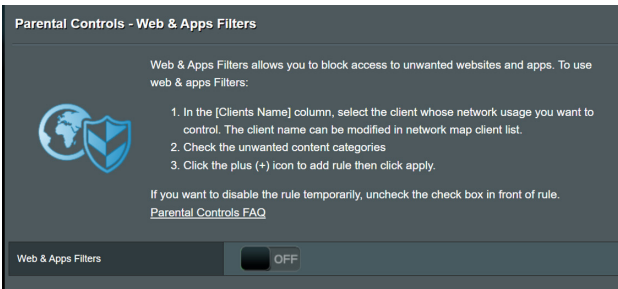

- If there is still no Internet access, try to reboot your computer and verify the network's IP address and gateway address.
- Check the status indicators on the ADSL modem and the wireless router. If the WAN LED on the wireless router is not ON, check if all cables are plugged properly.

### You forgot the SSID (network name) or network password

- Setup a new SSID and encryption key via a wired connection (Ethernet cable). Launch the web GUI, go to **Network Map**, click the router icon, enter a new SSID and encryption key, and then click **Apply**.
- Reset your router to the default settings. Launch the web GUI, go to **Administration > Restore/Save/Upload Setting**, and click **Restore**.

### How to restore the system to its default settings?

- Go to **Administration > Restore/Save/Upload Setting**, and click **Restore**.

### Firmware upgrade failed.

Launch the rescue mode and run the Firmware Restoration utility. Refer to section **4.2 Firmware Restoration** on how to use the Firmware Restoration utility.

## Cannot access Web GUI

Before configuring your wireless router, do the steps described in this section for your host computer and network clients.

### A. Disable the proxy server, if enabled.

#### Windows®

1. Click **Start > Internet Explorer** to launch the browser.
2. Click **Tools > Internet options > Connections > LAN settings.**

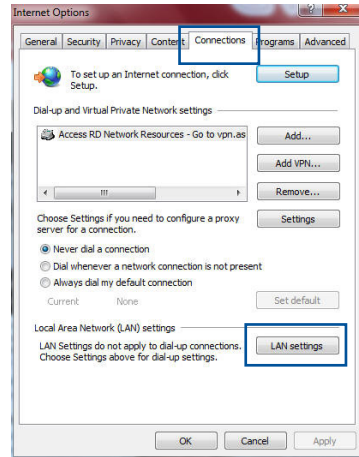

3. From the Local Area Network (LAN) Settings screen, untick **Use a proxy server for your LAN.**
4. Click **OK** when done.

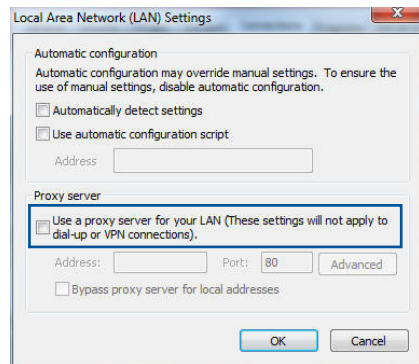

## MAC OS

1. From your Safari browser, click **Safari > Preferences > Advanced > Change Settings...**
2. From the Network screen, deselect **FTP Proxy** and **Web Proxy (HTTP)**.
3. Click **Apply Now** when done.

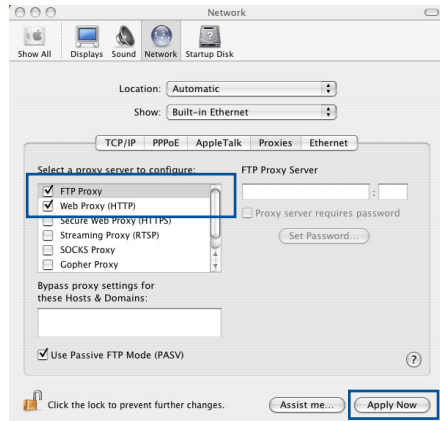

**NOTE:** Refer to your browser's help feature for details on disabling the proxy server.

## B. Set the TCP/IP settings to automatically obtain an IP address.

### Windows®

1. Click **Start > Control Panel > Network and Sharing Center**, then click the network connection to display its status window.

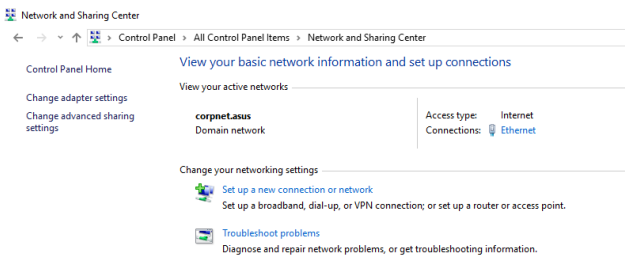

2. Click **Properties** to display the Ethernet Properties window.

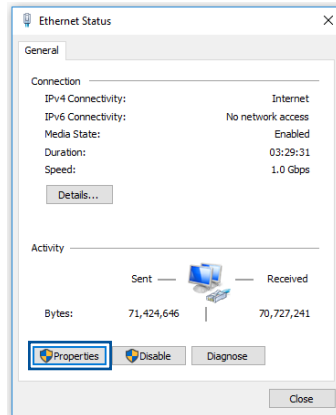

3. Select **Internet Protocol Version 4 (TCP/IPv4)** or **Internet Protocol Version 6 (TCP/IPv6)**, then click **Properties**.

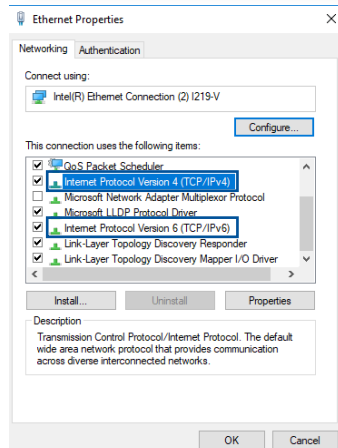

4. To obtain the IPv4 IP settings automatically, tick **Obtain an IP address automatically**.

To obtain the IPv6 IP settings automatically, tick **Obtain an IPv6 address automatically**.

5. Click **OK** when done.

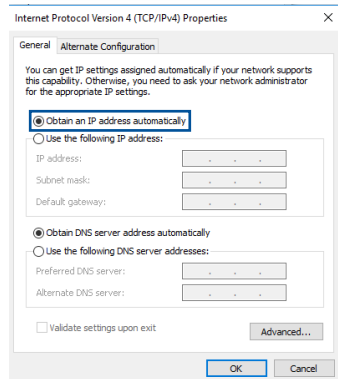

## MAC OS

1. Click the Apple icon  located on the top left of your screen.
2. Click **System Preferences > Network > Configure...**
3. From the **TCP/IP** tab, select **Using DHCP** in the **Configure IPv4** dropdown list.
4. Click **Apply Now** when done.

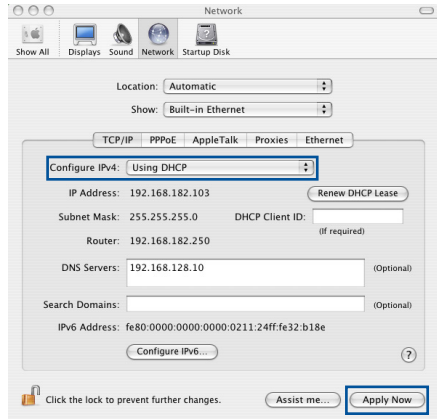

**NOTE:** Refer to your operating system's help and support feature for details on configuring your computer's TCP/IP settings.

## C. Disable the dial-up connection, if enabled.

### Windows®

1. Click **Start > Internet Explorer** to launch the browser.
2. Click **Tools > Internet options > Connections.**
3. Tick **Never dial a connection.**
4. Click **OK** when done.

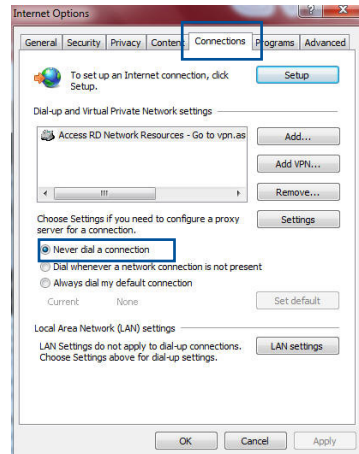

**NOTE:** Refer to your browser's help feature for details on disabling the dial-up connection.

# Appendices

## GNU General Public License

### Licensing information

This product includes copyrighted third-party software licensed under the terms of the GNU General Public License. Please see The GNU General Public License for the exact terms and conditions of this license. All future firmware updates will also be accompanied with their respective source code. Please visit our web site for updated information. Note that we do not offer direct support for the distribution.

### **GNU GENERAL PUBLIC LICENSE**

Version 2, June 1991

Copyright (C) 1989, 1991 Free Software Foundation, Inc.

59 Temple Place, Suite 330, Boston, MA 02111-1307 USA

Everyone is permitted to copy and distribute verbatim copies of this license document, but changing it is not allowed.

### **Preamble**

The licenses for most software are designed to take away your freedom to share and change it. By contrast, the GNU General Public License is intended to guarantee your freedom to share and change free software--to make sure the software is free for all its users. This General Public License applies to most of the Free Software Foundation's software and to any other program whose authors commit to using it. (Some other Free Software Foundation software is covered by the GNU Library General Public License instead.) You can apply it to your programs, too.

When we speak of free software, we are referring to freedom, not price. Our General Public Licenses are designed to make sure that you have the freedom to distribute copies of free software (and charge for this service if you wish), that you receive source code or can get it if you want it, that you can change the software or use pieces of it in new free programs; and that you know you can do these things.

To protect your rights, we need to make restrictions that forbid anyone to deny you these rights or to ask you to surrender the rights. These restrictions translate to certain responsibilities for you if you distribute copies of the software, or if you modify it.

For example, if you distribute copies of such a program, whether gratis or for a fee, you must give the recipients all the rights that you have. You must make sure that they, too, receive or can get the source code. And you must show them these terms so they know their rights.

We protect your rights with two steps: (1) copyright the software, and (2) offer you this license which gives you legal permission to copy, distribute and/or modify the software.

Also, for each author's protection and ours, we want to make certain that everyone understands that there is no warranty for this free software. If the software is modified by someone else and passed on, we want its recipients to know that what they have is not the original, so that any problems introduced by others will not reflect on the original authors' reputations.

Finally, any free program is threatened constantly by software patents. We wish to avoid the danger that redistributors of a free program will individually obtain patent licenses, in effect making the program proprietary. To prevent this, we have made it clear that any patent must be licensed for everyone's free use or not licensed at all.

The precise terms and conditions for copying, distribution and modification follow.

### **Terms & conditions for copying, distribution, & modification**

0. This License applies to any program or other work which contains a notice placed by the copyright holder saying it may be distributed under the terms of this General Public License. The "Program", below, refers to any such program or work, and a "work based on the Program" means either the Program or any derivative work under copyright law: that is to say, a work containing the Program or a portion of it, either verbatim or with modifications and/or translated into another language. (Hereinafter, translation is included without limitation in the term "modification".) Each licensee is addressed as "you".

Activities other than copying, distribution and modification are not covered by this License; they are outside its scope. The act of running the Program is not restricted, and the output from the Program is covered only if its contents constitute a work based on the Program (independent of having been made by running the Program). Whether that is true depends on what the Program does.

1. You may copy and distribute verbatim copies of the Program's source code as you receive it, in any medium, provided that you conspicuously and appropriately publish on each copy an appropriate copyright notice and disclaimer of warranty; keep intact all the notices that refer to this License and to the absence of any warranty; and give any other recipients of the Program a copy of this License along with the Program.

You may charge a fee for the physical act of transferring a copy, and you may at your option offer warranty protection in exchange for a fee.

2. You may modify your copy or copies of the Program or any portion of it, thus forming a work based on the Program, and copy and distribute such modifications or work under the terms of Section 1 above, provided that you also meet all of these conditions:
  - a) You must cause the modified files to carry prominent notices stating that you changed the files and the date of any change.
  - b) You must cause any work that you distribute or publish, that in whole or in part contains or is derived from the Program or any part thereof, to be licensed as a whole at no charge to all third parties under the terms of this License.
  - c) If the modified program normally reads commands interactively when run, you must cause it, when started running for such interactive use in the most ordinary way, to print or display an announcement including an appropriate copyright notice and a notice that there is no warranty (or else, saying that you provide a warranty) and that users may redistribute the program under these conditions, and telling the user how to view a copy of this License. (Exception: if the Program itself is interactive but does not normally print such an announcement, your work based on the Program is not required to print an announcement.)

These requirements apply to the modified work as a whole. If identifiable sections of that work are not derived from the Program, and can be reasonably considered independent and separate works in themselves, then this License, and its terms, do not apply to those sections when you distribute them as separate works. But when you distribute the same sections as part of a whole which is a work based on the Program, the distribution of the whole must be on the terms of this License, whose permissions for other licensees extend to the entire whole, and thus to each and every part regardless of who wrote it.

Thus, it is not the intent of this section to claim rights or contest your rights to work written entirely by you; rather, the intent is to exercise the right to control the distribution of derivative or collective works based on the Program.

In addition, mere aggregation of another work not based on the Program with the Program (or with a work based on the Program) on a volume of a storage or distribution medium does not bring the other work under the scope of this License.

3. You may copy and distribute the Program (or a work based on it, under Section 2) in object code or executable form under the terms of Sections 1 and 2 above provided that you also do one of the following:
  - a) Accompany it with the complete corresponding machine-readable source code, which must be distributed under the terms of Sections 1 and 2 above on a medium customarily used for software interchange; or,
  - b) Accompany it with a written offer, valid for at least three years, to give any third party, for a charge no more than your cost of physically performing source distribution, a complete machine-readable copy of the corresponding source code, to be distributed under the terms of Sections 1 and 2 above on a medium customarily used for software interchange; or,

- c) Accompany it with the information you received as to the offer to distribute corresponding source code. (This alternative is allowed only for noncommercial distribution and only if you received the program in object code or executable form with such an offer, in accord with Subsection b above.)

The source code for a work means the preferred form of the work for making modifications to it. For an executable work, complete source code means all the source code for all modules it contains, plus any associated interface definition files, plus the scripts used to control compilation and installation of the executable. However, as a special exception, the source code distributed need not include anything that is normally distributed (in either source or binary form) with the major components (compiler, kernel, and so on) of the operating system on which the executable runs, unless that component itself accompanies the executable.

If distribution of executable or object code is made by offering access to copy from a designated place, then offering equivalent access to copy the source code from the same place counts as distribution of the source code, even though third parties are not compelled to copy the source along with the object code.

4. You may not copy, modify, sublicense, or distribute the Program except as expressly provided under this License. Any attempt otherwise to copy, modify, sublicense or distribute the Program is void, and will automatically terminate your rights under this License. However, parties who have received copies, or rights, from you under this License will not have their licenses terminated so long as such parties remain in full compliance.
5. You are not required to accept this License, since you have not signed it. However, nothing else grants you permission to modify or distribute the Program or its derivative works. These actions are prohibited by law if you do not accept this License.

Therefore, by modifying or distributing the Program (or any work based on the Program), you indicate your acceptance of this License to do so, and all its terms and conditions for copying, distributing or modifying the Program or works based on it.

6. Each time you redistribute the Program (or any work based on the Program), the recipient automatically receives a license from the original licensor to copy, distribute or modify the Program subject to these terms and conditions. You may not impose any further restrictions on the recipients' exercise of the rights granted herein. You are not responsible for enforcing compliance by third parties to this License.
  
7. If, as a consequence of a court judgment or allegation of patent infringement or for any other reason (not limited to patent issues), conditions are imposed on you (whether by court order, agreement or otherwise) that contradict the conditions of this License, they do not excuse you from the conditions of this License. If you cannot distribute so as to satisfy simultaneously your obligations under this License and any other pertinent obligations, then as a consequence you may not distribute the Program at all. For example, if a patent license would not permit royalty-free redistribution of the Program by all those who receive copies directly or indirectly through you, then the only way you could satisfy both it and this License would be to refrain entirely from distribution of the Program.

If any portion of this section is held invalid or unenforceable under any particular circumstance, the balance of the section is intended to apply and the section as a whole is intended to apply in other circumstances.

It is not the purpose of this section to induce you to infringe any patents or other property right claims or to contest validity of any such claims; this section has the sole purpose of protecting the integrity of the free software distribution system, which is implemented by public license practices. Many people have made generous contributions to the wide range of software distributed through that system in reliance

on consistent application of that system; it is up to the author/donor to decide if he or she is willing to distribute software through any other system and a licensee cannot impose that choice.

This section is intended to make thoroughly clear what is believed to be a consequence of the rest of this License.

8. If the distribution and/or use of the Program is restricted in certain countries either by patents or by copyrighted interfaces, the original copyright holder who places the Program under this License may add an explicit geographical distribution limitation excluding those countries, so that distribution is permitted only in or among countries not thus excluded. In such case, this License incorporates the limitation as if written in the body of this License.

9. The Free Software Foundation may publish revised and/or new versions of the General Public License from time to time. Such new versions will be similar in spirit to the present version, but may differ in detail to address new problems or concerns.

Each version is given a distinguishing version number. If the Program specifies a version number of this License which applies to it and “any later version”, you have the option of following the terms and conditions either of that version or of any later version published by the Free Software Foundation. If the Program does not specify a version number of this License, you may choose any version ever published by the Free Software Foundation.

10. If you wish to incorporate parts of the Program into other free programs whose distribution conditions are different, write to the author to ask for permission.

For software which is copyrighted by the Free Software Foundation, write to the Free Software Foundation; we sometimes make exceptions for this. Our decision will be guided by the two goals of preserving the free status of all derivatives of our free software and of promoting the sharing and reuse of software generally.

## **NO WARRANTY**

11 BECAUSE THE PROGRAM IS LICENSED FREE OF CHARGE, THERE IS NO WARRANTY FOR THE PROGRAM, TO THE EXTENT PERMITTED BY APPLICABLE LAW. EXCEPT WHEN OTHERWISE STATED IN WRITING THE COPYRIGHT HOLDERS AND/OR OTHER PARTIES PROVIDE THE PROGRAM "AS IS" WITHOUT WARRANTY OF ANY KIND, EITHER EXPRESSED OR IMPLIED, INCLUDING, BUT NOT LIMITED TO, THE IMPLIED WARRANTIES OF MERCHANTABILITY AND FITNESS FOR A PARTICULAR PURPOSE. THE ENTIRE RISK AS TO THE QUALITY AND PERFORMANCE OF THE PROGRAM IS WITH YOU. SHOULD THE PROGRAM PROVE DEFECTIVE, YOU ASSUME THE COST OF ALL NECESSARY SERVICING, REPAIR OR CORRECTION.

12 IN NO EVENT UNLESS REQUIRED BY APPLICABLE LAW OR AGREED TO IN WRITING WILL ANY COPYRIGHT HOLDER, OR ANY OTHER PARTY WHO MAY MODIFY AND/OR REDISTRIBUTE THE PROGRAM AS PERMITTED ABOVE, BE LIABLE TO YOU FOR DAMAGES, INCLUDING ANY GENERAL, SPECIAL, INCIDENTAL OR CONSEQUENTIAL DAMAGES ARISING OUT OF THE USE OR INABILITY TO USE THE PROGRAM (INCLUDING BUT NOT LIMITED TO LOSS OF DATA OR DATA BEING RENDERED INACCURATE OR LOSSES SUSTAINED BY YOU OR THIRD PARTIES OR A FAILURE OF THE PROGRAM TO OPERATE WITH ANY OTHER PROGRAMS), EVEN IF SUCH HOLDER OR OTHER PARTY HAS BEEN ADVISED OF THE POSSIBILITY OF SUCH DAMAGES.

END OF TERMS AND CONDITIONS

## Safety Notices

When using this product, always follow the fundamental safety precautions, including, but not limited to the following:

---



### **WARNING!**

- The power supply cord(s) must be plugged into socket-outlet(s) that is /are provided with a suitable earth ground. Connect the equipment only to a nearby socket outlet that is easily accessible.
  - If the Adapter is broken, do not try to fix it by yourself. Contact a qualified service technician or your retailer.
  - DO NOT use damaged power cords, accessories, or other peripherals.
  - DO NOT mount this equipment higher than 2 meters.
  - Use this product in environments with ambient temperatures between 0°C (32°F) and 40°C (104°F).
  - Read the operational guidelines and the temperature range provided before using the product.
  - Pay particular attention to the personal safety when using this device in airports, hospitals, gas stations and professional garages.
  - Medical device interference: Maintain a minimum distance of at least 15 cm (6 inches) between implanted medical devices and ASUS products to reduce the risk of interference.
  - Kindly use ASUS products in good reception conditions to minimize the radiation's level.
  - Keep the device away from pregnant women and the lower abdomen of the teenager.
  - DO NOT use this product if visible defects can be observed or it has been wet or damaged or modified. Seek servicing for assistance.
-

**WARNING!**

- DO NOT place on uneven or unstable work surfaces.
  - DO NOT place or drop objects on the top of the product. Avoid exposing the product to mechanical shock such as crushing, bending, puncturing or shredding.
  - DO NOT disassemble, open, microwave, incinerate, paint, or shove any foreign objects into this product.
  - Refer to the rating label on the bottom of your product and ensure your power adapter complies with this rating.
  - Keep the product away from fire and heat sources.
  - DO NOT expose to or use near liquids, rain, or moisture. DO NOT use the product during electrical storms.
  - Connect the PoE output circuits of this product exclusively to PoE networks, without routing to external facilities.
  - To prevent electrical shock hazard, disconnect the power cable from the electrical outlet before relocating the system.
  - Only use accessories that have been approved by the device manufacturer to work with this model. The use of other types of accessories may invalidate the warranty or violate local regulations and laws, and may pose safety risks. Contact your local retailer for the availability of authorized accessories.
  - Use of this product in a way not recommended in the provided instructions may result in a risk of fire or personal injury.
-

## Service and Support

Visit our multi-language website at <https://www.asus.com/support>.

