

NetShelter™ 9000 Series Rack PDU

Switched

User Guide

990-6302E-001

Release date: 7/2024



Legal Information

The information provided in this document contains general descriptions, technical characteristics and/or recommendations related to products/solutions.

This document is not intended as a substitute for a detailed study or operational and site-specific development or schematic plan. It is not to be used for determining suitability or reliability of the products/solutions for specific user applications. It is the duty of any such user to perform or have any professional expert of its choice (integrator, specifier or the like) perform the appropriate and comprehensive risk analysis, evaluation and testing of the products/solutions with respect to the relevant specific application or use thereof.

The Schneider Electric brand and any trademarks of Schneider Electric SE and its subsidiaries referred to in this document are the property of Schneider Electric SE or its subsidiaries. All other brands may be trademarks of their respective owner.

This document and its content are protected under applicable copyright laws and provided for informative use only. No part of this document may be reproduced or transmitted in any form or by any means (electronic, mechanical, photocopying, recording, or otherwise), for any purpose, without the prior written permission of Schneider Electric.

Schneider Electric does not grant any right or license for commercial use of the document or its content, except for a non-exclusive and personal license to consult it on an "as is" basis.

Schneider Electric reserves the right to make changes or updates with respect to or in the content of this document or the format thereof, at any time without notice.

To the extent permitted by applicable law, no responsibility or liability is assumed by Schneider Electric and its subsidiaries for any errors or omissions in the informational content of this document, as well as any non-intended use or misuse of the content thereof.

Table of Contents

Introduction	10
Product Features	10
About Network Management Cards	11
Types of User Accounts	11
Watchdog Features	11
Overview	11
Network Interface Watchdog Mechanism	12
Resetting the Network Timer	12
Network Port Sharing (NPS)	12
About the Network Port Sharing Feature	12
Display ID	12
Installation Instructions	12
Specific Assignment of Display IDs	13
Firmware Upgrade with NPS	13
Getting Started	13
Establish Network Settings	14
IPv4 Initial Setup	14
IPv6 Initial Setup	14
TCP/IP Configuration Methods	14
.ini file utility	14
DHCP and BOOTP Configuration	15
Network Management with Other Applications	16
Command Line Interface (CLI)	16
Recovering from a Lost Password	16
Front Panel Overview	17
Network Status LED	18
10/100/1000 LED	18
Load Indicator LED	18
Example 1	19
Example 2	20
Example 3	21
Example 4	22
Example 5	23
Example 6	24
Command Line Interface	25
About the Command Line Interface (CLI)	25
Log On to the CLI	25
Local Access to the Command Line Interface	25
Remote Access to the Command Line Interface	25
About the Main Screen	26
Using the CLI	27
Command Syntax	28
Command Response Codes	29
Network Management Card Command Descriptions	30
?	30

about	30
alarmcount	31
boot	31
bye	32
cd	32
clrrst	33
console	33
date	34
delete	35
dir	35
dns	36
eapol	37
email	38
eventlog	40
exit	41
firewall	41
format	42
ftp	42
help	43
lang	43
lastrst	44
ledblink	44
logzip	45
netstat	45
ntp	46
ping	47
portSpeed	47
prompt	48
pwd	48
quit	48
radius	49
reboot	50
resetToDef	50
session	51
smtp	52
snmp	53
snmpv3	54
snmptrap	55
ssh	56
ssl	57
system	59
tcpip	60
tcpip6	61
user	62
userdflt	63
web	64
whoami	65

wifi	65
xferINI	66
xferStatus	66
Device Command Descriptions	66
Network Port Sharing Commands	66
alarmList	67
bkLowLoad	68
bkNearOver	68
bkOverLoad	69
bkPeakCurr	69
bkReading	70
bkRestrictn	70
devLowLoad	71
devNearOver	71
devOverLoad	72
devPeakLoad	72
devReading	73
devStartDly	73
dispID	74
Temperature/Humidity Sensors	74
humAIGen	74
humHyst	75
humLow	75
humMin	76
humReading	76
humStatus	77
lcd	77
lcdBlink	77
logToFlash	78
modbus	79
olAssignUsr	80
olCancelCmd	80
olDlyOff	81
olDlyOn	81
olDlyReboot	82
olGroups	82
olName	83
olOff	84
olOffDelay	84
olOn	85
olOnDelay	85
olRbootTime	86
olStatus	87
olUnasgnUsr	87
phBal	88
phBalAIGen	88
phLowLoad	89

phNearOver	89
phOverLoad	90
phPeakCurr	90
phReading	91
phRestrictn	91
phTophVolts	92
prodInfo	92
sensorName	93
Temperature Sensor Note:	93
tempAlGen	93
tempHigh	94
tempHyst	94
tempMax	95
tempReading	95
tempStatus	95
userAdd	96
userDelete	96
userList	96
userPasswd	98
Web User Interface	99
Supported Web Browsers	99
Log On to the Web User Interface	99
Overview	99
URL Address Formats	100
First Log On	100
Limited Status Access	100
Web User Interface Features	101
Tabs	101
Device Status Icons	101
Quick Links	102
Network Port Sharing (NPS) on the Web UI	102
About Home	103
Status Tab	104
About the Status Tab	104
View the Load Status and Peak Load	104
View the Network Status	104
Current IPv4 Settings	105
Current IPv6 Settings	105
Domain Name System Status	105
Ethernet Port Speed	105
Control	106
Controlling Device Outlets	106
To Control the Outlets on Your Rack PDU	106
Control Actions You Can Select	106
Managing User Sessions	107
Resetting the Network Interface	107
Configuration	108

About the Configuration Tab	108
Configure Load Thresholds	108
To Configure Load Thresholds	108
Configure the Rack PDU Name and Location	108
Set the Coldstart Delay for the Rack PDU	109
Reset Peak Load and kWh	109
Set the Overload Outlet Restrictions	109
Parameters	109
To Set Overload Outlet Restrictions	109
Configure Phase Load Balance	110
Configure and Control Outlet Groups	110
Outlet Group Terminology	110
Purpose and Benefits of Outlet Groups	110
System Requirements for Outlet Groups	111
Rules for Configuring Outlet Groups	111
Enable Outlet Groups	112
Create a Local Outlet Group	112
Create a Global Outlet Group	113
Edit or Delete an Outlet Group	113
Typical Outlet Group Configurations	113
Verify Your Setup and Configuration for Global Outlet Groups	114
Outlet Settings	114
Configure Outlet Settings and the Outlet Name	115
Schedule Outlet Actions	116
Actions You Can Schedule	116
Schedule An Outlet Event	116
Edit, Disable, Enable, or Delete a Scheduled Outlet Event	117
Outlet User Manager	117
Configure an Outlet User	117
Outlet Manager and Network Port Sharing	118
Configure Temperature and Humidity Sensors	118
Security	119
Session Management Screen	119
Ping Response	119
Local Users	119
Remote Users	121
Configure the RADIUS Server	121
Supported RADIUS Servers	122
RADIUS and Network Port Sharing	122
Firewall Menus	123
802.1 X Security Configuration	125
Network Features	126
Protocol Configuration Summary	126
TCP/IP and Communications Settings	126
Port Speed	128
DNS	129
Web	130

Console	131
SNMP	131
SNMPv1	133
SNMPv3	133
Modbus TCP	135
FTP Server	136
Notifications	137
Event Actions	137
Configure Event Actions	137
Email Notification Screens	138
SNMP Trap Receiver Screen	140
SNMP Traps Test Screen	141
General Menu	141
Identification Screen	141
Date/Time Screen	142
Creating and Importing Settings with the Config File	143
Configure Links	143
Logs in the Configuration Menu	143
Identifying Syslog Servers	143
Syslog Settings	144
Syslog Test and Format Example	144
Tests Tab	145
Setting the Network Status LED or Device LCD to Blink	145
Logs Tab	146
Event, Data, and Firewall Logs	146
Event Log	146
Data Log	147
Firewall Logs	149
Use FTP or SCP to Retrieve Log Files	149
About Tab	151
About the Rack PDU	151
Support Screen	151
Device IP Configuration Wizard	152
Capabilities, Requirements, and Installation	152
How to use the Wizard to Configure TCP/IP Settings	152
System Requirements	152
Installation	152
How to Export Configuration Settings	153
Retrieving and Exporting the .ini File	153
Summary of the Procedure	153
Contents of the .ini File	153
.ini and Network Port Sharing	153
Detailed Procedures	154
The Upload Event and Error Messages	155
The Event and Its Error Messages	155
Messages in config.ini	155
Errors Generated by Overridden Values	155

Related Topics	156
Updating Firmware	157
Firmware File Transfer Methods	157
Use the Firmware Update Utility	158
Use FTP or SCP to Update One Rack PDU	159
Use XMODEM To Upgrade One Rack PDU	160
Use a USB Drive To Transfer and Update Files	160
How To Update Multiple Rack PDUs	161
Use the Firmware Upgrade Utility For Multiple Upgrades	161
Upgrade Firmware for Network Port Sharing (NPS) Groups	161
Verifying Upgrades and Updates	162
Verify the Success Or Failure of the Transfer	162
Last Transfer Result Codes	162
Verify the Version Numbers of Installed Firmware	162
Troubleshooting	163
Rack PDU Access Problems	163
SNMP Issues	164
Download Log Files to a USB Flash Drive	164
Source Code Copyright Notice	165

Introduction

Product Features

The APC by Schneider Electric NetShelter APDU9000 Series Switched Rack Power Distribution Unit (PDU) may be used as a stand-alone, network-manageable power distribution device or up to 32 devices can be connected together using one network connection. The Rack PDU provides real-time remote monitoring of connected loads. User-defined alarms warn of potential circuit overloads. The Rack PDU provides full control over outlets through remote commands and user interface settings.

You can manage a NetShelter APDU9000 Series Switched Rack PDU through its Web User Interface (UI), its Command Line Interface (CLI), StruxureWare Data Center Expert, or Simple Network Management Protocol (SNMP). (To use the PowerNet MIB with an SNMP browser, see the PowerNet SNMP Management Information Base (MIB) Reference Guide, available at www.apc.com).

NetShelter APDU9000 Series Switched Rack PDUs have these additional features:

- Device power, peak power, apparent power, power factor and energy monitoring.
- Phase voltage, current, peak current, power, apparent power and power factor monitoring.
- Bank current and peak current (for models that support breaker banks).
- Configurable alarm thresholds that provide network and visual alarms to help avoid overloaded circuits.
- Various levels of access: Super User, Administrator, Device User, Read-Only, Outlet User, and Network-Only User (These are protected by user name and password requirements).
- Multiple user login feature which allows up to four users to be logged in simultaneously.
- Remote individual outlet control.
- Configurable power On or Off delays.
- Event and data logging. The event log is accessible by Telnet, Secure Copy Protocol (SCP), File Transfer Protocol (FTP), Serial connection, or web browser (using HTTPS access with SSL/TLS, or using HTTP access). The data log is accessible by web browser, SCP, or FTP.
- Support for Modbus TCP. You can use this feature to monitor the Rack PDU through a building management system.

The Register Map file can be downloaded from <https://www.apc.com/us/en/download/document/TME45037/>

- Email notifications for Rack PDU Network Management Card (NMC) system events.
- SNMP traps, Syslog messages, and e-mail notifications based on the severity level or category of the Rack PDU and NMC system event.
- Security protocols for authentication and encryption.
- Network Port Sharing (NPS). Up to 32 APDU9000 Series Rack PDUs can be connected using the In and Out ports so that only one network connection is necessary.
- NPS guest firmware auto-update feature allows the NPS host to automatically pass a firmware update to its connected guests.
- Log files can be downloaded by inserting a USB Flash drive into the USB port on the Display Interface of the Rack PDU.

NOTE: The Rack PDU does not provide power surge protection. To ensure that the device is protected from power failure or power surges, connect the Rack PDU to an APC by Schneider Electric Uninterruptible Power Supply (UPS).

About Network Management Cards

The Schneider Electric Network Management Card (NMC) enables essential and secure remote monitoring and management of your Rack PDU.

To ensure your Network Management Card has the latest firmware which is independently certified to the IEC 62443-4-2 standard, your NMC includes a 1- year Secure NMC System (SNS) subscription.

For further information including the latest documentation, please visit www.apc.com/secure-nmc. Select the Software and Firmware tab to download the Secure NMC System update tool for your device. Select the Documents tab to download the Secure NMC System (SNS) Tool User Guide.

NOTE: SNS subscriptions are not currently available in China or Japan.

Types of User Accounts

The Rack PDU has various levels of access (Super User, Administrator, Device User, Read-Only User, Outlet User, and Network-Only User), which are protected by user name and password requirements. Up to four users are allowed to login to the same Rack PDU simultaneously.

- An Administrator or the Super User can use all of the menus in the Web UI and all of the commands in the CLI. Administrator user types can be deleted, but the Super User cannot be deleted. The default user name and password for the Super User are both `apc`. The Super User or Administrator can manage another Administrator's account (enable, disable, change password, etc.)
- A Device User has read and write access to device-related screens. Administrative functions like session management under the Security menu and Firewall under Logs are not available for this user level.
- A Read-Only user has access to the same menus as a Device User but without the capability to change configurations, control devices, delete data, or use file transfer options. Links to configuration options are visible but disabled. The event and data logs display no button to clear the log.
- An Outlet User has access through the Web UI and CLI. The Outlet User has access to the same menus as a Device User but with limited capability to change configurations, control devices, delete data, or use file transfer options. Links to configuration options are visible but are disabled. The Outlet User has access to the Outlet Control menu option that allows the user to control only the outlets assigned by the Administrator. Outlet Users cannot clear the event or data logs. The user name and password are defined by the Administrator during the process of adding a new Outlet User.
- A Network-Only User (remote user) can only log on using the Web UI and CLI (Telnet or SSH). A network-only user has read/write access to the network related menus only.

Watchdog Features

Overview

To detect internal problems and recover from unanticipated inputs, the Rack PDU uses internal, system-wide watchdog mechanisms. When it restarts to recover from an internal problem, a Network Interface Restarted event is recorded in the event log.

Network Interface Watchdog Mechanism

The Rack PDU implements internal watchdog mechanisms to protect itself from becoming inaccessible over the network. For example, if the Rack PDU does not receive any network traffic for 9.5 minutes (either direct traffic, such as SNMP, or broadcast traffic, such as an Address Resolution Protocol [ARP] request), it assumes that there is a problem with its network interface and restarts. The network interface watchdog mechanism is only enabled on a PDU that discovers an active network interface connection at start-up. This allows guest PDUs in a Network Port Sharing chain to function normally without rebooting every 9.5 minutes.

Resetting the Network Timer

To ensure that the Rack PDU does not restart if the network is quiet for 9.5 minutes, the Rack PDU attempts to contact the default gateway every 4.5 minutes. If the gateway is present, it responds to the Rack PDU, and the response restarts the 9.5-minute timer. If your application does not require or have a gateway, specify the IP address of a computer that is running on the network and is on the same subnet. The network traffic of that computer will restart the 9.5-minute time frequently enough to prevent the Rack PDU from restarting.

Network Port Sharing (NPS)

About the Network Port Sharing Feature

You can use the Network Port Sharing feature to view the status of and configure and manage up to 32 Rack PDUs using only one network connection. This is made possible by connecting the Rack PDUs using the A and B ports on the Rack PDU front panel.

NOTE: All Rack PDUs in the group must be from the APDU9000 Series and using the same Rack PDU firmware revision. Data from guest devices will not be presented to the user until the guest PDUs have been updated to match the host PDU's firmware version. The APDU9000 Series Rack PDU NPS host compares its own firmware version with the versions found on each guest. In the event of a version difference, the host copies its firmware to the non-complying guests by means of the NPS chain.

Display ID

The display ID is a number, 1 to 32, used to uniquely identify the Rack PDUs in a group. After two or more Rack PDUs are connected to one another in an NPS group, they can be identified on the various interfaces by the use of this "Display ID". You can view this Display ID in the top left corner of the LCD display. Alternatively, a larger Display ID "shadow" can be enabled on the LCD by selecting the **Display Settings > Display ID > Show** option on the LCD keypad.

Installation Instructions

Connect up to 32 Rack PDUs using the Link A and B ports on the front panel of each unit.

NOTE: To reduce the possibility of communication issues, the maximum total length of cabling (Cat5e+) connecting Rack PDUs in a group should not exceed 10 meters.

Connect the “Network” port of one of the grouped Rack PDUs to a network hub or switch. This unit will be the Host for the Rack PDU group. Guest PDU data can be viewed on the Host PDU. Set up network functionality for this Host Rack PDU as specified in the Establish Network Settings section. The Host PDU will automatically discover any Guest PDUs connected through the A and B ports. The Rack PDU group is now available from the Host PDU’s IP address.

NOTE: Only one Rack PDU in an NPS group is allowed to be the host. If two host units are connected together, one will automatically be chosen to be the single host for the NPS group. You also have the option to select a particular guest to be the host as long as that guest has an active network link.

The host Rack PDU supports many features that are not supported by NPS guests. These include, but are not limited to:

- SNMP rPDU2 Group OIDs
- Initiating AOS/APP firmware updates for guest Rack PDUs
- Time synchronization for guest Rack PDUs
- Data logging for the guest Rack PDUs

Specific Assignment of Display IDs

The Display ID can be configured from the Web User Interface via the “Configuration > RPDU > Device > Display ID” field. The Display ID can also be configured from the CLI interface via the `dispID` command or from SNMP by OID `rPDU2DeviceConfigModule`.

You can assign specific Display IDs by powering up the units manually for the first time in the desired order (1 to 32).

To configure the Display ID order directly from the Rack PDUs, follow the instructions below before powering up any of the Rack PDUs in the group.

1. Before powering up any of the Rack PDUs connected in a group, determine the Display ID order that you would like.
2. First power up the unit that you would like to have Display ID 1.
3. After that unit has initialized and the LCD has started displaying its screens, power on the unit that you would like to have Display ID 2.
4. Continue in the same way for the remaining units, as applicable for your setup.

Firmware Upgrade with NPS

At start-up and routinely during operation, the NPS host compares its own firmware version with the versions found on each guest. In the event of a version difference, the host copies its firmware to the non-complying guests by means of the NPS chain.

NOTE: Automatic firmware upgrade is only available for APDU9000 Series Rack PDUs as this functionality requires resident firmware support in the NPS host and guests. This functionality requires that any replacement Rack PDUs also be APDU9000 Series models to maintain correct operation of the NPS chain.

Getting Started

To start using the Rack PDU:

1. Install the Rack PDU using the Rack Power Distribution Unit Installation Instructions that were shipped with your Rack PDU.

2. Apply power and connect to your network. Follow the directions in the Rack Power Distribution Unit Installation Instructions.
3. Establish network settings.
4. Begin using the Rack PDU by way of one of the following sections found in this manual:
 - Web User Interface
 - Command Line Interface
 - Rack PDU Display Panel

Establish Network Settings

IPv4 Initial Setup

You must define three TCP/IP settings for the Rack PDU before it can operate on the network.

- The IP address of the Rack PDU
- The subnet mask of the Rack PDU
- The IP address of the default gateway (only needed if you are going off segment)

NOTE: If a default gateway is unavailable, use the IP address of a computer that is located on the same subnet as the Rack PDU and is usually running. The Rack PDU used the default gateway to test the network when traffic is very light.

NOTE: Do not use the same loopback address(121.0.0.1) as the default gateway. Doing so disables the card. To enable again, you must log on using a serial connection and reset the TCP/IP settings to their defaults.

For detailed information on how to use a DHCP server to configure the TCP/IP settings at a Rack PDU, see **DHCP Response Options** in this manual.

IPv6 Initial Setup

IPv6 network configuration provides flexibility to accommodate your requirements. IPv6 can be used anywhere an IP address is entered on this interface. You can configure manually, automatically, or using DHCP.

TCP/IP Configuration Methods

Use one of the following methods to define the TCP/IP settings needed by the Rack PDU (found in this manual).

- Device IP Configuration Wizard
- DHCP and BOOTP configuration
- Command Line Interface

.ini file utility

You can use the .ini file export utility to export .ini file settings from configured Rack PDUs to one or more unconfigured Rack PDUs. For more information, see **Creating and Importing Settings with the config File** in this manual.

DHCP and BOOTP Configuration

The default TCP/IP configuration setting, DHCP, assumes that a properly configured DHCP server is available to provide TCP/IP settings to Rack PDU. You can also configure the setting for BOOTP.

A user configuration (INI) file can function as a BOOTP or DHCP boot file. For more information, see “Creating and importing settings with the config file” in this manual.

If neither of these servers is available, see “Device IP Configuration Wizard” in this manual.

BOOTP: For the Rack PDU to use a BOOTP server to configure its TCP/IP settings, it must find a properly configured RFC951–compliant BOOTP server.

In the BOOTPTAB file of the BOOTP server, enter the Rack PDU’s MAC address, IP address, subnet mask, and default gateway, and, optionally, a bootup file name. Look for the MAC address on the bottom of the Rack PDU or on the Quality Assurance slip included in the package.

When the Rack PDU reboots, the BOOTP server provides it with the TCP/IP settings.

- If you specified a bootup file name, the Rack PDU attempts to transfer that file from the BOOTP server using TFTP or FTP. The Rack PDU assumes all settings specified in the bootup file.
- If you did not specify a bootup file name, you can configure the other settings of the Rack PDU remotely through its Web User Interface or Command Line Interface which are discussed in this manual.
- The user name and password are both **apc** by default. To create a bootup file, see your BOOTP server documentation.

DHCP: You can use an RFC2131/RFC2132–compliant DHCP server to configure the TCP/IP settings for the Rack PDU.

This section summarizes the Rack PDU’s communication with a DHCP server. For more detail about how a DHCP server can configure the network settings for a Rack PDU, see “DHCP response options” in this manual.

1. The Rack PDU sends out a DHCP request that uses the following to identify itself:
 - A Vendor Class Identifier (APC by default)
 - A Client Identifier (by default, the MAC address of the Rack PDU)
 - A User Class Identifier (by default, the identification of the application firmware installed on the Rack PDU). This is known as DHCP Option 12.
2. A properly configured DHCP server responds with a DHCP offer that includes all the settings that the Rack PDU needs for network communication. The DHCP offer also includes the Vendor Specific Information option (DHCP option 43). The Rack PDU can be configured to ignore DHCP offers that do not encapsulate the APC cookie in DHCP option 43 using the following hexadecimal format. The Rack PDU does not require this cookie by default.

```
Option 43 = 01 04 31 41 50 43
```

Where:

- The first byte (01) is the code.
- The second byte (04) is the length.
- The remaining bytes (31 41 50 43) are the APC cookie.

See your DHCP server documentation to add code to the Vendor Specific Information option.

NOTE: By selecting the Require vendor specific cookie to accept DHCP Address check box in the Web UI, you can require the DHCP server to provide an APC cookie which supplies information to the Rack PDU.

Network Management with Other Applications

These applications and utilities work with a Rack PDU which is connected to the network.

- PowerNet[®] Management Information Base (MIB) with a standard MIB browser: Perform SNMP SETs and GETs and use SNMP traps.
- StruxureWare Data Center Expert: Provide enterprise-level power management and management of agents, Rack PDUs, and environmental monitors.
- Device IP Configuration Utility: Configure the basic settings of one or more Rack PDU over the network. See “Device IP Configuration Utility” in this manual.
- Security Wizard: Create components needed to help with security for the Rack PDUs when you are using Secure Sockets Layer (SSL) or Transport Layer Security (TLS) and related protocols and encryption routines.

Command Line Interface (CLI)

NOTE: This task is performed when there are no other users logged into any interface of the PDU.

1. Log on to the CLI.
2. Contact your network administrator to obtain the IP address, subnet mask, and default gateway for the Rack PDU.
3. Use the three commands to configure network settings. (Text in *italics* indicates a variable.)

```
tcpip -i yourIPaddress
tcpip -s yoursubnetmask
tcpip -g yourDefaultGateway
```

For each variable, type a numeric value that has the format *xxx . xxx . xxx . xxx*. For example, to set a system IP address of 156.205.14.141, type the following command and press ENTER:

```
tcpip -i 156.205.14.141
```

4. Type `exit`. The Rack PDU restarts to apply the changes.

Recovering from a Lost Password

NOTE: Resetting the Rack PDU will reset the unit to its default configuration. You should export the `.ini` file after configuring your Rack PDU and keep it in a safe place. If you have this file saved, you will be able to retrieve your configuration after a lost password event.

You can use any secure interface to complete the recovery process. This includes the local CLI by serial connection, remote CLI by SSH, or web by HTTPS, all of which are covered in this manual.

1. Hold down the **Reset** button for 20-25 seconds, ensuring the Status LED is pulsing green during this time. When the Status LED changes to orange, release the **Reset** button to allow the Rack PDU to complete its reboot process.
2. Access the device through one of the secure interfaces to set your custom password and configure the device. After resetting the device to defaults, the first log in can be completed with the default user name **apc** and password **apc**.

Front Panel Overview

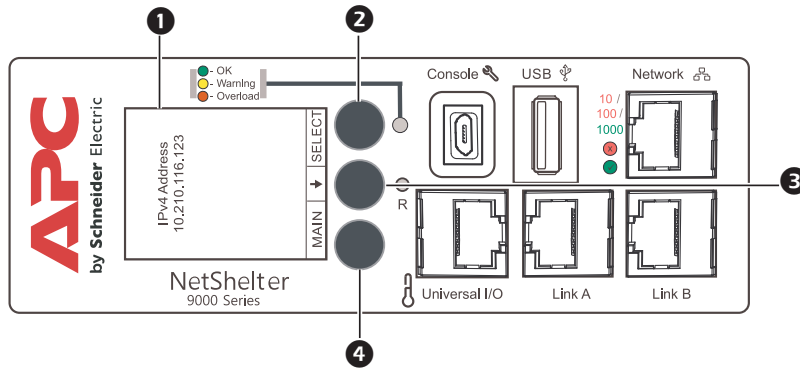

Item	Description	Function
1	Display Panel	Shows information about the Rack PDU. In normal operation input voltage, current, and power refreshes every five seconds. To reverse the text, select Display settings, scroll to LCD Orientation and press Select.
2	Select button	With a menu item highlighted, press the Select button to display Rack PDU information.
3	Scroll button	Press once to display the menu. Press additional times to move the highlight bar down the menu list until you reach the desired item.
4	Main Menu button	Press to view the Rack PDU electrical input.

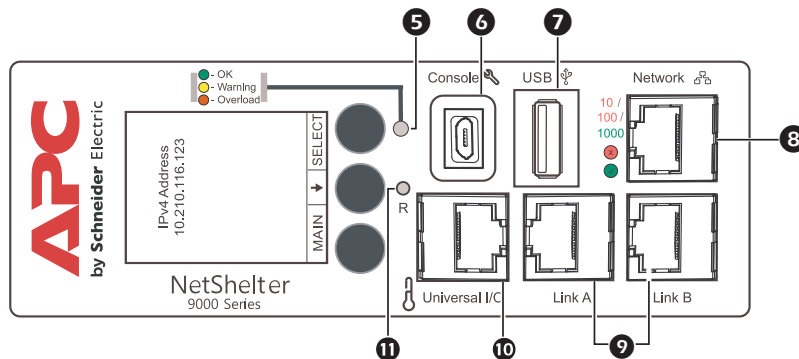

Item	Description	Function
5	Load Indicator LED	Indicates the status of the Rack PDU load and alarm levels.
6	Console port	Connects the Rack PDU to a local computer using a micro-USB cable (APC part number 960-0603), to configure initial network settings or access the command line interface (CLI).
7	USB port	For use with a flash drive for firmware upgrades - 5V @ 100 mA. Can also be used to download log files to a flash drive.
8	10/100/1000 Base-T Connector (Network port)	Connects the Rack PDU to the network using a Cat5e+ network cable.
9	Link A and Link B ports	For use with the Network Port Sharing feature to connect the Rack PDU to the Network or to connect multiple Rack PDUs to one another and to the Network.
10	Universal I/O	Port for connecting an optional APC by Schneider Electric Temperature Sensor (AP9335T) or an optional APC by Schneider Electric Temperature/Humidity Sensor (AP9335TH).
11	Reset button	Resets the network management interface without affecting the outlets of the Rack PDU.

Network Status LED

Condition	Description
Off	One of the following situations exists: <ul style="list-style-type: none"> The Rack PDU is not receiving input power The Rack PDU is not operating properly. It may need to be repaired or replaced. Contact Customer Support.
Solid Green	The Rack PDU has valid TCP/IP settings.
Solid Orange	A hardware issue has been detected in the Rack PDU. Contact Customer Support.
Flashing Green	The Rack PDU does not have valid TCP/IP settings.
Flashing Orange	The Rack PDU is making BOOTP requests.
Alternately flashing Green and Orange	If the LED is flashing slowly, the Rack PDU is making DHCP ² requests ¹ . If the LED is flashing rapidly, the Rack PDU is starting up.
1. If you do not use a BOOTP or DHCP server, see Establish Network Settings in this manual to configure the TCP/IP settings of the Rack PDU. 2. To use a DHCP server, see TCP/IP and Communication Settings in this manual.	

10/100/1000 LED

Condition	Description
Off	One or more of the following situations exists: <ul style="list-style-type: none"> The Rack PDU is not receiving input power. The cable that connects the Rack PDU to the network is disconnected or defective The device that connects the Rack PDU to the network is turned off. The Rack PDU itself is not operating properly. It may need to be repaired or replaced. Contact Customer Support.
Solid Yellow	The Rack PDU is connected to a network operating at 10–100 Megabits per second (Mbps).
Solid Green	The Rack PDU is connected to a network operating at 1000 Mbps.
Flashing Yellow	The Rack PDU is receiving or transmitting data packets at 10–100 Mbps.
Flashing Green	The Rack PDU is receiving or transmitting data packets at 1000 Mbps.

Load Indicator LED

The load indicator LED identifies overload and warning conditions for the Rack PDU.

Condition	Description
Solid Green	OK. No overload (critical) or near overload (warning) alarms are present.
Solid Yellow	Warning. At least one near overload (warning) alarm is present, but no overload (critical) alarms are present.
Flashing Red	Overload. At least one overload (critical) alarm is present.

Example 1

Display Tree — Main Menu

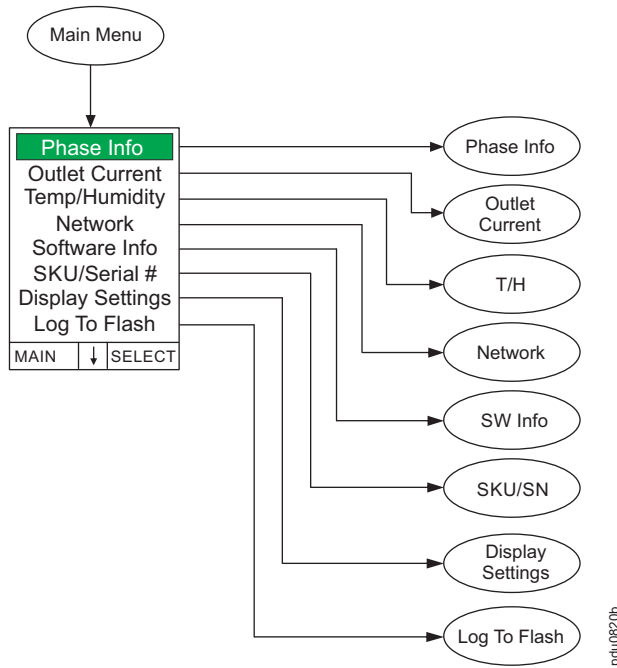

NOTE: MenuHomeScreen is restricted to six lines per menu page. If there are more than six available selections, they will appear on multiple pages. “Outlet Current” only appears on Metered-by-Outlet (MBO) units. “Temp/Humidity” only appears when an AP9335T or AP9335TH sensor is attached.

Example 2

Display Tree — Submenu 1

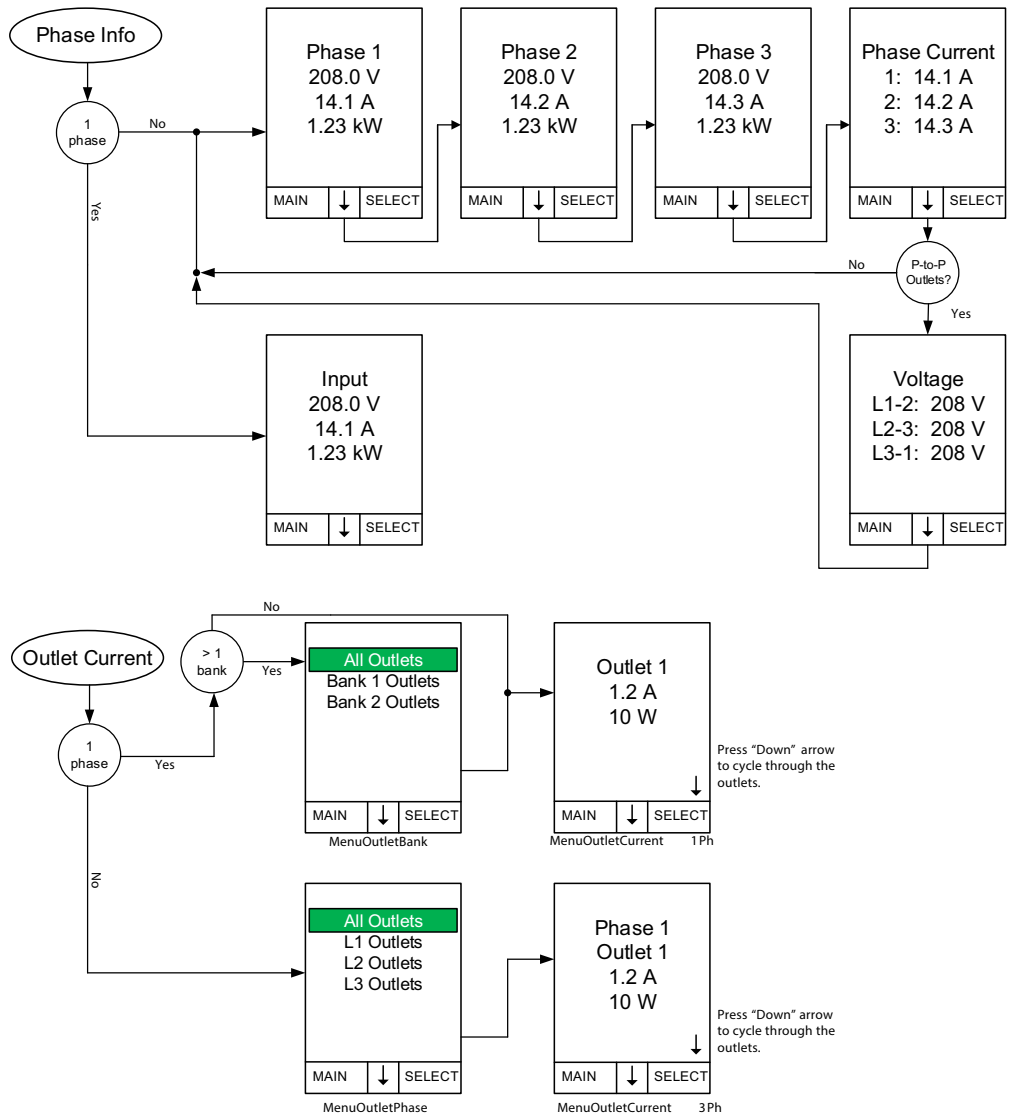

Example 3

Display Tree — Submenu 2

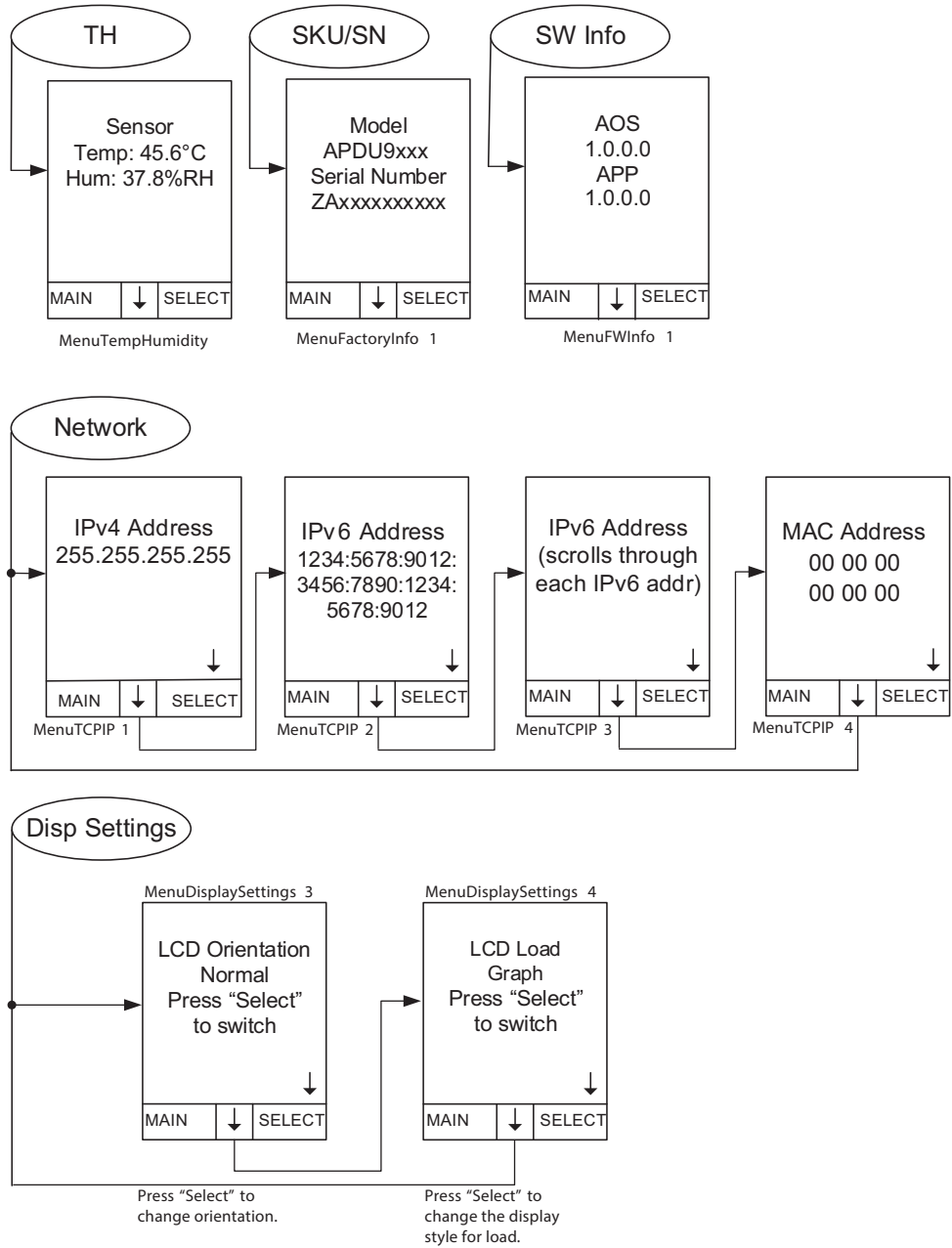

Example 4

Display Tree — Monitor

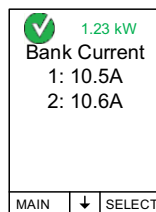
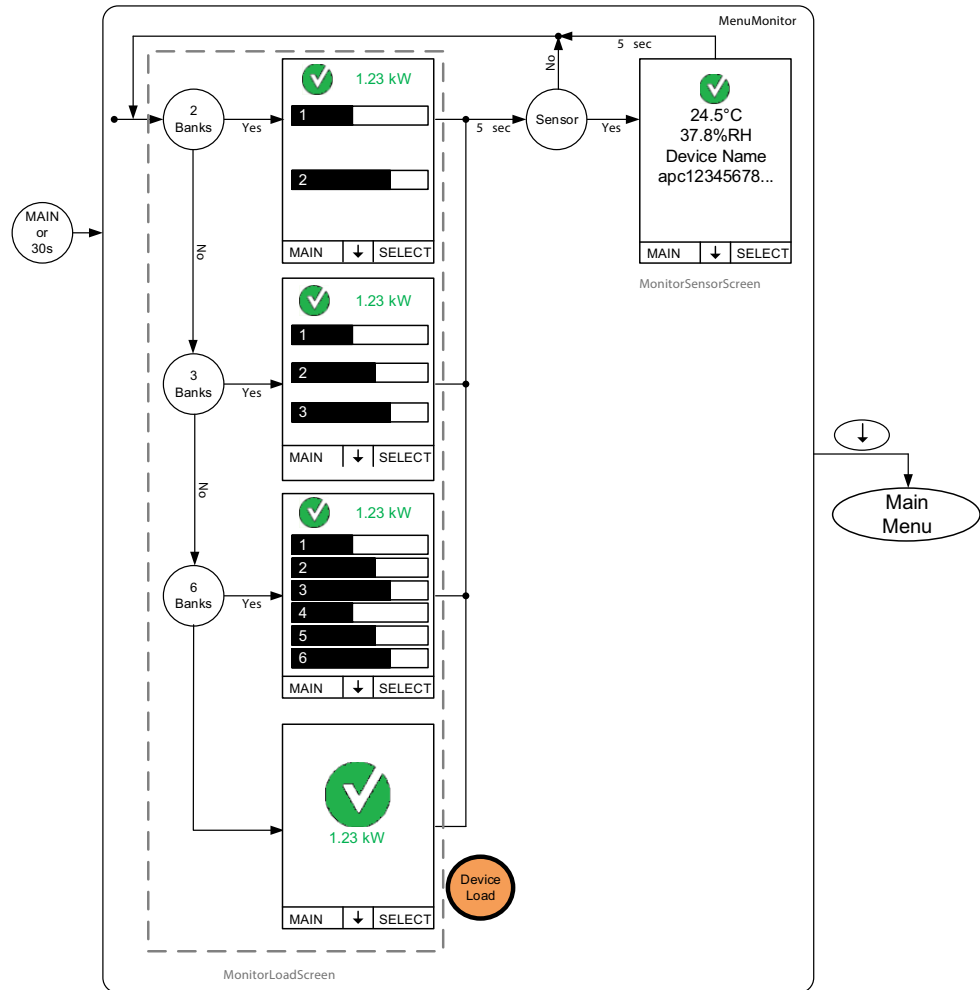

Example of Numeric Load Display

NOTE: Numeric and graph display will have No difference if no bank exists. A total device power screen will be added when using numeric load display if banks exist.

Example 5

Display Tree — Monitor Status Indicator

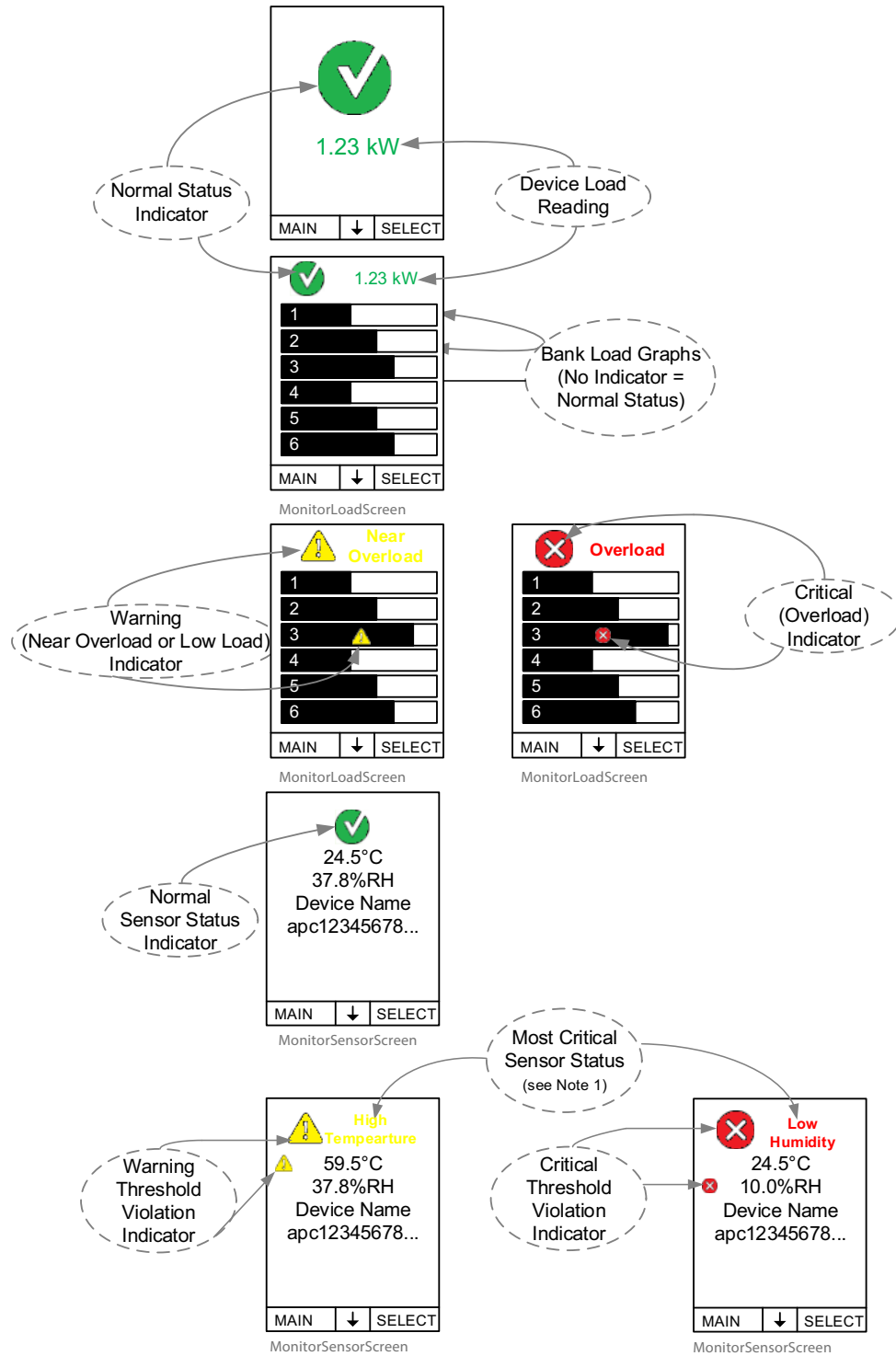

NOTE: 1 — The simplified LCD screens will show device load alarms only when no banks are present **OR** bank load alarms only when banks are present. Phase and outlet alarms and warnings will **NOT** be displayed.

NOTE: 2 — For simplicity, both warning and critical temperature threshold violations will display as High Temp. Similarly, both warning and critical humidity threshold violations will display as Low Humidity.

Example 6

Display Tree — Log to Flash

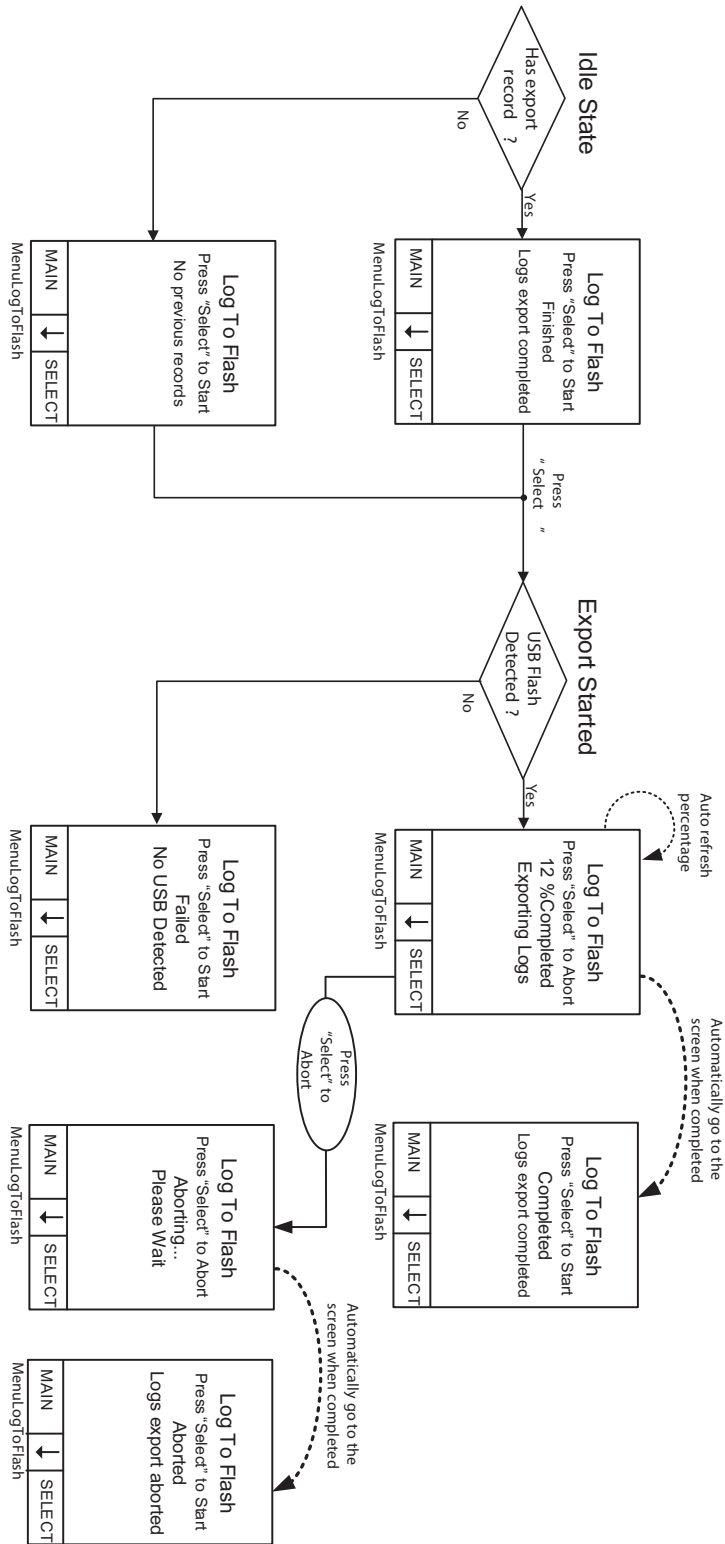

Command Line Interface

About the Command Line Interface (CLI)

You can use the Command Line Interface to view the status of and configure and manage the Rack PDU (and any connected Rack PDUs, if using the Network Port Sharing Feature). In addition, the Command Line Interface enables you to create scripts for automated operation. You can configure all parameters of the Rack PDU (including those for which there are not specific CLI commands) by using the CLI to transfer an INI file to the Rack PDU. The CLI uses XMODEM to perform the transfer, however, you cannot read the current INI file through XMODEM.

Log On to the CLI

To access the Command Line Interface, you can use either a local (serial) connection or a remote (Telnet or SSH) connection with a computer on the same network as the Rack PDU.

Local Access to the Command Line Interface

For local access, use a computer that connects to the Rack PDU through the Console port to access the Command Line Interface:

1. Select a serial port on your computer and disable any service that uses that port.
2. Connect a Micro USB cable from the selected serial port on the computer to the Console port on the Rack PDU.
3. Run a terminal program (e.g., Tera Term or HyperTerminal) and configure the selected port for 9600 bps, 8 data bits, no parity, 1 stop bit, and no flow control.

Remote Access to the Command Line Interface

You can choose to access the Command Line Interface through Telnet and/or SSH. SSH enabled by default. You do not have to enable either.

You can use the `console` command to enable or disable either Telnet or SSH.

If needed, you can also use the Web UI to enable or disable either Telnet or SSH. On the **Configuration** tab, select **Network** from the menu to open the **Console Access** page. Click to check the desired **Enable** box. Click **Apply** to save your changes or **Cancel** to leave the page.

Telnet for basic access: Telnet provides the basic security of authentication by user name and password, but not the high-security benefits of encryption. Telnet is disabled by default.

1. From a computer that has access to the network on which the Rack PDU is installed, at a command prompt, type `telnet` and the IP address for the Rack PDU (for example, `telnet 139.225.6.133`, when the Rack PDU uses the default Telnet port of 23), and press `ENTER`.
If the Rack PDU uses a non-default port number (from 5000 to 32768), you must include a colon or a space, depending on your Telnet client, between the IP address (or DNS name) and the port number. (These are commands for general usage: Some clients do not allow you to specify the port as an argument and some types of Linux might want extra commands).

2. Enter the user name and password (by default, apc and apc for the Super User).

If you cannot remember your user name or password, see *Recovering from a Lost Password* in this manual.

SSH for high-security access: If you use the high security of SSL/TLS for the Web UI, use SSH for access to the Command Line Interface. SSH encrypts user names, passwords, and transmitted data. The interface, user accounts, and user access rights are the same whether you access the Command Line Interface through SSH or Telnet, but to use SSH, you must first configure SSH and have an SSH client program installed on your computer. SSH is enabled by default.

About the Main Screen

The following is an example of the main screen, which is displayed when you log on to the Command Line Interface of a Rack PDU.

```

Schneider Electric                               Network Management Card AOS    v1.3.0.6
(c) Copyright 2019 All Rights Reserved           RPDU 2g APP                      v1.0.0.22
-----
Name       : Test Lab                          Date       : 02/20/2020
Contact    : Don Adams                         Time       : 5:58:30
Location   : Building 3                       User       : Administrator
Up Time    : 0 Days 21 Hours 21 Minutes       Stat       : P+ N4+ N6+ A+
-----
IPv4       : Enabled                           IPv6       : Enabled
Ping response : Enabled
-----
HTTP       : Enabled                           HTTPS      : Enabled
FTP        : Enabled                           Telnet     : Disabled
SSH/SCP    : Enabled                           SNMPv     : Read/Write
SNMPv3     : Enabled
-----
Super User : Enabled                           RADIUS    : Disabled
Administrator : Disabled                       Device User : Disabled
Read-only User : Disabled                       Network-Only User : Disabled

Type ? For command listing
Use tcpip for IP address (-i), subnet (-s), and gateway (-g)

apc>

```

- The firmware name identifies the type of device that connects to the network.
- Three fields identify the system name, contact person, and location of the Rack PDU.
Name : Test Lab
Contact : Don Adams
Location : Building 3
- An **Up Time** field reports how long the Rack PDU Management Interface has been running since it was last turned on or reset.
Date: 02/20/2020
Time: 5:58:30
- Two fields identify when you logged in, by date and time.
Date: 02/20/2020
Time: 5:58:30
- The **User** field identifies whether you logged in through the Super User, Administrator or Device Manager account.
User : Administrator

- A **Stat** field reports the Rack PDU status.

Stat: P+ N4+ N6+ A+

P+	The APC operating system (AOS) is functioning properly
----	--

IPv4 only	IPv6 only	IPv4 and IPv6 *	Description
N+	N+	N4 + N6+	The network is functioning properly
N?	N6?	N4? N6?	A BOOTP request cycle is in progress
N-	N6-	N4 - N6-	The Rack PDU failed to connect to the network
N!	N6!	N4! N6!	Another device is using the Rack PDU IP address
* The N4 and N6 values can be different from one another: you could, for example, have N4-N6+.			

A+	The application is functioning properly
A-	The application has a bad checksum
A?	The application is initializing
A!	The application is not compatible with the AOS

NOTE: If P+ is not displayed, contact the APC by Schneider Electric Customer Care Center.

- The remaining fields show which protocols and user accounts are enabled.

Using the CLI

At the Command Line Interface, you can use commands to configure the Rack PDU. To use a command, type the command and press ENTER. Commands and arguments are valid in lowercase, uppercase, or mixed case. Options are case-sensitive.

While using the Command Line Interface, you can also do the following:

- Type `?` and press ENTER to view a list of available commands, based on your account type.
- To obtain information about the purpose and syntax of a specified command, type the command, a space, and `?` or the word `help`. For example, to view RADIUS configuration options, type:
`radius ?` or `radius help`
- Press the UP arrow key to view the command that was entered most recently in the session. Use the UP and DOWN arrow keys to scroll through a list of up to ten previous commands.
- Type at least one letter of a command and press the TAB key to scroll through a list of valid commands that match the text you typed in the command line.
- Type `exit` or `quit` to close the connection to the Command Line Interface.

Command Syntax

Item	Description
—	Options are preceded by a hyphen
< >	Descriptions of user input arguments are enclosed in angle brackets. For example: <code>-dp <device password></code>
[]	If a command accepts options, the values may be enclosed in brackets.
	A vertical line between items enclosed in brackets or angle brackets indicates that the items are mutually exclusive. You must use one of the items.

Example of a command that supports multiple options:

```
ftp [-p <port number>] [-S <enable | disable>]
```

In this example, the `ftp` command accepts the option `-p`, which defines the port number, and the option `-S`, which enables or disables the FTP feature.

To change the FTP port number to 5010, and enable FTP:

- Type the `ftp` command, the port option, and the argument 5010:

```
ftp -p 5010
```
- After the first command succeeds, type the `ftp` command, the enable/disable option, and the `enable` selection:

```
ftp -S enable
```

Example of a command that accepts mutually exclusive arguments for an option:

```
alarmcount [-p <all | warning | critical | informational>]
```

In this example, the option `-p` accepts only four arguments: `all`, `warning`, or `critical`. For example, to view the number of active critical alarms, type:

```
alarmcount -p critical
```

The command will fail if you type an argument that is not specified.

Command Response Codes

The command response codes enable scripted operations to detect error conditions reliably without having to match error message text:

The CLI reports all command operations with the following format:

E [0-9] [0-9] [0-9] : Error message

Code	Message	Code	Message
E000	Success	E200	Input Error
E001	Successfully Issued	E201	No Response
E002	Reboot required for change to take effect	E202	User Already Exists
E100	Command failed	E203	User Does Not Exist
E101	Command not Found	E204	User Does Not Have Access
E102	Parameter Error	E205	Exceeds Maximum Users
E103	Command Line Error	E206	Invalid value
E104	User Level Denial	E207	Outlet Command Error: Device not initialized
E105	Command Prefill	E208	Outlet Command Error: Previous command is pending
E106	Data Not Available	E209	Outlet Command Error: Database rejected request
E107	Serial Communication with the Rack PDU has been lost.	E210	Outlet Command Error: Outlet restricted
E108	EAPoL disabled due to invalid/encrypted certificate.	E211	Command failed
		E212	Could not allocate memory

Network Management Card Command Descriptions

?

Access: Super User, Administrator, Device User, Read-Only User, Network-Only User

Description: View a list of all the CLI commands available to your account type. To view help text for a specific command, type the command followed by a question mark.

Argument	Description
<command>	View help text for a specific command.

Example: To view a list of options that are accepted by the `alarmcount` command, type

```
apc> alarmcount ?
```

```
Usage: alarmcount -- Display Alarms
```

```
alarmcount [-p <all | warning | critical | informational>]
```

Error Message: E000, E102

about

Access: Super User, Administrator, Device User, Read-Only User, Network-Only User

Description: View hardware and firmware information. This information is useful in troubleshooting and enables you to determine if updated firmware is available at the website.

Parameters: None

Error Message: E000

alarmcount

Access: Super User, Administrator, Device User, Read-Only User, Network-Only User

Description: Displays alarms present in the system.

Parameters:

Option	Argument	Description
-p	all	View the number of active alarms reported by the Rack PDU. Information about the alarms is provided in the Event Log.
	warning	View the number of active warning alarms.
	critical	View the number of active critical alarms.
	informational	View the number of active informational alarms.

Example: To view all active warning alarms, type

```
apc> alarmcount -p warning
E000: Success
WarningAlarmCount: 0
```

Error Message: E000, E102

boot

Access: Super User, Administrator, Network-Only User

Description: Define how the Rack PDU will obtain its network settings, including the IP address, subnet mask, and default gateway. Then configure the BOOTP or DHCP server settings.

Parameters:

Option	Argument	Description
-b <boot mode>	dhcp bootp manual	Define how the TCP/IP settings will be configured when the Rack PDU turns on, resets, or restarts.
-c	[<enable disable> (Require DHCP Cookie)	dhcp and dhcpBootp boot modes only. Enable or disable the requirement that the DHCP server provide the APC cookie.
The default values for these three settings generally do not need to be changed.		
-v	[<vendor class>]	APC.
-i	[<client id>]	The MAC address of the Rack PDU, which uniquely identifies it on the network.
-u	[<user class>]	The name of the application firmware module.

Example: To use a DHCP server to obtain network settings:

1. Type `boot -b dhcp`
2. Enable the requirement that the DHCP server provide the APC cookie:

```
apc> boot -c enable
E000: Success
```

Error Message: E000, E102

bye

Access: Super User, Administrator, Device User , Read-Only User, Network-only User

Description: Exit the CLI session. This works the same as the `exit` or `quit` commands.

Parameters: None.

Example:

```
apc> bye
Connection Closed - Bye
```

Error Message: None.

cd

Access: Super User, Administrator, Device User, Read-Only User

Description: Navigate to a folder in the directory structure of the Rack PDU. The working directory is set back to the root directory '/' when the you log out of the CLI.

Parameters: <directory name>

Example 1: To change to the `ssh` folder and confirm that an SSH security certificate was uploaded to the Rack PDU,

1. Type `cd ssh` and press ENTER.
2. Type `dir` and press ENTER to list the files stored in the SSH folder.

Example 2: To return to the previous directory folder, type `cd ..`

Error Message: E000, E102

clrrst

Access: Super User, Administrator

Description: Clear the network interface reset reason. See `lastrst`, page 44 for more information on the reset reason.

Example: None

Error Message: None

console

Access: Super User, Administrator

Description: Define whether users can access the Command Line Interface using Telnet, which is disabled by default, or Secure SHell (SSH), which is enabled by default and provides protection by transmitting user names, passwords, and data in encrypted form. You can change the Telnet or SSH port setting for additional security. Alternately, disable network access to the Command Line Interface.

Parameters:

Option	Argument	Description
-s	<enable disable>	Enable or Disable SSH access to the device. Enabling SSH enables SCP.
-t	<enable disable>	Enable or Disable Telnet access to the device.
-pt	<telnet port n>	Define the Telnet port used to communicate with the Rack PDU (23 by default).
-ps	<SSH port n>	Define the SSH port used to communicate with the Rack PDU (22 by default).
-b	2400 9600 19200 38400	Configure the speed of the console port connection (9600 bps by default).

Example 1: To enable SSH access to the Command Line Interface, type
`console -s enable`

Example 2: To change the Telnet port to 5000, type
`console -pt 5000`

Error Message: E000, E102

date

Access: Super User, Administrator

Definition: Configure the date and time used by the Rack PDU.

NOTE: To configure an NTP server to define the date and time for the Rack PDU, see `ntp`, page 46.

Parameters:

Option	Argument	Description
-d	<"datestring">	Set the current date. The format must match the current -f setting.
-t	<00:00:00>	Configure the current time, in hours, minutes, and seconds. Use the 24-hour clock format.
-f	mm/dd/yy dd.mm.yyyy mmm-dd-yy dd-mmm-yy yyyy-mm-dd	Select the numerical format in which to display all dates in this user interface. Each letter m (for month), d (for day), and y (for year) represents one digit. Single-digit days and months are displayed with a leading zero.
-z	<time zone offset>	Set the difference with GMT in order to specify your time zone. This enables you to synchronize with other people in different time zones.

Example 1: To display the date using the format yyyy-mm-dd, type

```
date -f yyyy-mm-dd
```

Example 2: To define the date as October 30, 2009, using the format configured in the preceding example, type

```
date -d "2009-10-30"
```

Example 3: To define the time as 5:21:03 p.m., type

```
date -t 17:21:03
```

Error Message: E000, E100, E102

delete

Access: Super User, Administrator

Description: Delete a file in the file system. (To delete the event log, see eventlog, page 40)

Parameters:

Argument	Description
<file name>	Type the name of the file to delete.

Example: To delete a file,

1. Navigate to the folder that contains the file. For example, to navigate to the logs folder, type

```
cd logs
```
2. To view the files in the logs folder, type

```
dir
```
3. To delete a file, type

```
delete <file name>
```

Error Messages: E000, E102

dir

Access: Super User, Administrator, Device User, Read-Only User, Network-Only User

Description: View the files and folders stored on the Rack PDU.

Parameters: None

Example:

```
apc> dir E000: Success
1024 Jan 2 4:34 apc_hw21_aos_2.5.0.8.bin
6249332 Jan 2 4:34 apc_hw21_rpdu2g_1.1.0.15.bin
45000 Sep 30 1996 config.ini

      0   Apr  23  18:53   db/
      0   Apr  23  18:53   ssl/
      0   Apr  23  18:53   ssh/
      0   Apr  23  18:53   logs/
      0   Apr  23  18:53   sec/
      0   Apr  23  18:53   fw/
      0   Apr  23  18:53   email/
      0   Apr  23  18:53   eapol/
      0   Apr  23  18:53   tmp/
      0   Apr  23  18:53   upsfw/
```

Error Messages: E000

dns

Access: Super User, Administrator

Definition: Configure the manual Domain Name System (DNS) settings.

Parameters:

Option	Argument	Description
-OM	enable disable	Override the manual DNS. When this setting is enabled, configuration data from other sources (typically DHCP) takes precedence over the manual configuration set here.
-y	<enable disable>	System-hostname sync
-p	<primary DNS server>	Set the primary DNS server.
-s	<secondary DNS server>	Set the secondary DNS server.
-d	<domain name>	Set the domain name.
-n	<domain name IPv6>	Set the domain name IPv6.
-h	<host name>	Set the host name.

Example:

```
apc > dns -OM
E000: Success
Override Manual DNS Settings: enabled
```

Error Message: E000, E102

eapol

Access: Super User, Administrator

Description: Configure EAPoL (802.1X Security) settings.

Parameters:

Option	Argument	Description
-S	enable disable	Enable or disable EAPoL.
-n	<supplicant name>	Set the supplicant name.
-p	<private key passphrase>	Set the private key passphrase.

Example 1: To display the result of an `eapol` command:

```
apc>eapol
E000: Success

Active EAPoL
Settings
-----
-----

      Status:          enabled
      Supplicant
      Name:            NMC-Supplicant
      Passphrase:      <hidden>
      CA file          Valid Certificate
      Status
      Private Key      Valid Certificate
      Status
      Public Key       Valid Certificate
      Status
```

Example 2: To enable EAPoL:

```
apc>eapol -S enable
E000: Success
Reboot required for change to take effect.
```

email

Access: Super User, Administrator

Description: Configure parameters for email, which the Rack PDU uses to send event notifications.

Parameters:

Option	Argument	Description
-g [n]	<enable disable>	Enables (default) or disables sending email to the recipient.
-t [n]	<To Address>	The user and domain names of the recipient. To use email for paging, use the email address for the recipient's pager gateway account (for example, myacct100@skytel.com). The pager gateway will generate the page.
-o [n]	<long short> (Format)	The long format contains name, location, contact, IP address, serial number of the device, date and time, event code, and event description. The short format provides only the event description.
-l [n]	<Language Code>	The language which the email notification will be sent in. Only English is available at this time.
-r [n]	<Local recipient custom> (Route)	<p>Set the SMTP Server options:</p> <p>Local (recommended): Choose this option if your SMTP server is located on your internal network, or is set up for your e-mail domain. Choose this setting to limit delays and network outages. If you choose this setting, you must also enable forwarding at the SMTP server of the device, and set up a special external e-mail account to receive the forwarded e-mail. NOTE: Check with your SMTP server administrator before making these changes.</p> <p>Recipient: This setting sends email directly to the recipient's SMTP server, which is determined by an MX record lookup of the domain of the To Address. The device tries only once to send the e-mail. A network outage or a busy remote SMTP server can cause a time-out and cause the e-mail to be lost. This setting requires no additional administrative tasks on the SMTP server. NOTE: When using this setting, the "From Address" will match the "To Address", authentication and encryption (TLS) will be disabled, and port 25 will be used.</p> <p>Custom: This setting allows each email recipient to have its own server settings. These settings are independent of the settings given by the <code>smtp</code> command.</p>
Custom Route Option		
-f [n]	<From Address>	<p>The contents of the From field in email messages sent by the Rack PDU in the format <code>user@ [IP_address]</code> if an IP address is specified as Local SMTP Server), or in the format <code>user@domain</code> if DNS is configured and the DNS name is specified as Local SMTP Server in the email messages.</p> <p>The local SMTP server may require that you use a valid user account on the server for this setting. See the server documentation.</p>
-s {n}	<SMTP Server>	The IPv4/ IPv6 address or DNS name of the local SMTP server. This definition is required only when the <code>-r</code> option is set to <code>Local</code> .
-p [n]	<Port>	The SMTP port number, with a default of 25. Common ports are 25 for unencrypted e-mail, and 465 and 587 for SSL/TLS encrypted e-mail. You can change the port setting to any port from 1 to 65535.
-a [n]	<enable disable> (Authentication)	Enable this if the SMTP server requires authentication.
-u [n]	<User Name>	If the SMTP server requires authentication, type the user name and password here. This performs a simple authentication, not SSL/TLS.
-w [n]	<Password>	
-e [n]	<none ifsupported always implicit>	<p>Specify when encryption is used.</p> <p>none: The SMTP server does not require or support encryption.</p> <p>ifsupported: The SMTP server advertises support for STARTTLS but doesn't require the connection to be encrypted. The STARTTLS command is sent after the advertisement is given. This is typically used with port 25.</p> <p>always: The SMTP server requires the STARTTLS command to be sent on connection to the server. This is typically used with port 587.</p> <p>implicit: The SMTP server only accepts connections that begin encrypted. No STARTTLS message is sent to the server. This is typically used with port 465.</p>

Option	Argument	Description
-c[n]	<enable disable >	Require CA Root Certificate: This should be enabled if the security policy of your organization does not allow for implicit trust of SSL/TLS connections. If this is enabled, a valid CA certificate for the SMTP server must be installed to the Rack PDU's certificate store using the certificate loader in order for a TLS connection with the SMTP server to succeed.
-i[n]	<Certificate File Name>	This field is dependent on the root CA certificates installed on the Rack PDU and whether or not a root CA certificate is required.
n = Email Recipient Number (1,2,3 or 4)		

Example: To enable email to be sent to email recipient 1 with email address recipient1@apc.com, using the local SMTP server:

```
apc> email -g1 enable -r1 local -t1 recipient1@apc.com
E000: Success
```

Error Message: E000, E102

eventlog

Access: Super User, Administrator, Device User, Read-Only User

Description: View the date and time you retrieved the Event Log, the status of the Rack PDU, and the status of sensors connected to the Rack PDU. View the most recent device events and the date and time they occurred. Use the following keys to navigate the Event Log:

Parameters:

Key	Description
ESC	Close the Event Log and return to the Command Line Interface.
ENTER	Update the log display. Use this command to view events that were recorded after you last retrieved and displayed the log.
SPACEBAR	View the next page of the Event Log.
B	View the preceding page of the Event Log. This command is not available at the main page of the Event Log.
D	Delete the Event Log. Follow the prompts to confirm or deny the deletion. Deleted events cannot be retrieved.

Example:

```

apc> eventlog
-----Event Log -----
Date: 2/9/2024 Time: 13:22:26
-----
Metered Rack PDU: Communication Established
Date          Time          User          Event
-----
2/9/2024      13:17:22      System        Set Time.
2/9/2024      13:16:57      System        Configuration change. Date
format preference.
2/9/2024      13:16:49      System        Set Date.
2/9/2024      13:16:35      System        Configuration change. Date
format preference.
2/9/2024      13:16:08      System        Set Date.
2/9/2024      13:15:30      System        Set Time.
2/9/2024      13:15:00      System        Set Time.
2/9/2024      13:13:58      System        Set Date.
2/9/2024      13:12:22      System        Set Date.
2/9/2024      13:12:08      System        Set Date.
2/9/2024      13:11:41      System        Set Date.

<ESC>- Exit, <ENTER>- Refresh, <SPACE>- Next, <D>- Delete
    
```

Error Message: E000, E100

exit

Access: Super User, Administrator, Device User, Read-Only User, Network-only User

Description: Exit the CLI session. This works the same as the `bye` or `quit` commands.

Parameters: None.

Example:

```
apc> exit
Bye
```

Error Message: None.

firewall

Access: Super User, Administrator

Description: Enable, disable, or configure the internal Rack PDU firewall feature.

Parameters:

Parameters	Argument	Description
-s	<enable disable>	Enable or disable the firewall.
-f	<file name to activate>	Name of the firewall to activate.
-t	<file name to test> <duration time in minutes>	Name of firewall to test and duration time in minutes.
-fe		Shows active file errors.
-te		Shows test file errors.
-c		Cancel a firewall test.
-r		Shows active firewall rules.
-l		Shows firewall activity log.
-Y		Skip firewall test prompt.

Example: To enable the firewall policy file *example.fwl*, type

```
apc> firewall -f example.fwl
E000: Success
```

Error Message: E000, E102

format

Access: Super User, Administrator

Description: Reformat the file system of the Rack PDU and erase all security certificates, encryption keys, configuration settings, and the event and data logs. Be careful with this command.

NOTE: You must confirm by entering "YES" when prompted.

NOTE: To reset the Rack PDU to its default configuration, use the `resetToDef` command instead.

Parameters:

Option	Definition
-f	This will delete all configuration data, event and data logs, certificates and keys. Network settings will NOT be preserved.
-p	This will delete all configuration data, event and data logs, certificates and keys. Network settings WILL be preserved.

Example:

```
apc> format -p

Format FLASH file system

Warning: This will delete all configuration data,
         event and data logs, certs and keys.

All network configuration settings WILL be preserved.

Enter 'YES' to continue or <ENTER> to cancel: YES
```

Error Message: None

ftp

Access: Super User, Administrator

Description: Enable or disable access to the FTP server. Optionally, change the port setting to the number of any unused port from 5001 to 32768 for added security.

NOTE: The system will reboot if any configuration is changed.

NOTE: FTP is disabled by default, and Secure Copy Protocol (SCP) is automatically enabled when the Super User password is set via SSH.

Parameters:

Option	Argument	Definition
-p	<port number> (valid ranges are: 21 and 5000-32768)	Define the TCP/IP port that the FTP server uses to communicate with the Rack PDU (21 by default). The FTP server uses both the specified port and the port one number lower than the specified port.
-s	<enable disable>	Configure access to the FTP server.

Example: To change the TCP/IP port to 5001, type

```
apc> ftp -p 5001
E000: Success
```

Error Message: E000, E102

help

Access: Super User, Administrator, Device User, Read-Only User, Network-Only User

Description: View a list of all the CLI commands available to your account type. To view help text for a specific command, type the command followed by `help`.

Parameters: [`<command>`]

Example 1: To view a list of commands available to someone logged on as a Device User, log on to the CLI as the Device User, then type `help`

Example 2: To view a list of options that are accepted by the `alarmcount` command, type

```
apc> alarmcount help
Usage: alarmcount -- Display Alarms
       alarmcount [-p <all | warning | critical|
                  informational>]
```

lang

Access: Super User, Administrator, Device User

Description: Displays the language in use.

Parameters: None

Example:

```
apc>lang
E000: Success
```

```
Languages
enUs - English
```

Error Message: None

lastrst

Access: Super User, Administrator

Description: View the last network interface reset reason. Use the output of this command to troubleshoot network interface issues with the guidance of technical support.

Option	Description
02 NMI Reset	The network interface was reset via the Reset button on the Rack PDU front display.
09 Coldstart Reset	The network interface was reset by removing power from the hardware.
12 WDT Reset	The network interface was reset via a firmware command.

Parameters: None

Example:

```
apc> lastrst
09 Coldstart Reset
E000: Success
```

Error Message: E000, E102

ledblink

Access: Super User, Administrator

Description: Sets the status LED to blink for the specified amount of time. Use this command to help visually locate the Rack PDU.

Parameters:

Argument	Definition
<time>	Number of minutes to blink the LED.

Example:

```
apc> ledblink 1
E000: Success
```

Error Message: E000, E102

logzip

Access: Super User, Administrator

Description: Creates a single, compressed archive of the log files available from the NMC and Rack PDU. These files can be used by technical support to troubleshoot issues.

Parameters:

Option	Argument	Definition
-m	<email recipient> (1-4)	The identifying number (1–4) of the email recipient to which the zip file will be sent. Enter the number of one of the four possible email recipients configured.

Example:

```
apc> logzip -m 1
Generating files
/dbg/debug_ZA1023006009.tar
Emailing log files to email recipient - 1
E000: Success
```

Error Message: E000, E102

netstat

Access: Super User, Administrator

Description: View the status of the network and all active IPv4 and IPv6 addresses.

Parameters: None

Example:

```
apc> netstat

Current IP Information:

Family      mHome      Type      IPAddress      Status
IPv6        4          auto      FE80::2C0:B7FF:FE51:F304/64  configured
IPv6        0          manual    ::1/128        configured
IPv4        0          manual    127.0.0.1/32   configured
```

Error Message: E000, E10

ntp

Access: Super User, Administrator

Description: View and configure the Network Time Protocol parameters.

Parameters:

Option	Argument	Definition
-OM	enable disable	Override the manual settings.
-p	<primary NTP server>	Specify the primary server.
-s	<secondary NTP server>	Specify the secondary server.
-e	enable disable	Enable or disable the use of NTP.
-u	<update now>	Immediately update the Rack PDU time from the NTP server.

Example 1: To enable the override of manual setting, type

```
ntp -OM enable
```

Example 2: To specify the primary NTP server, type

```
ntp -p 150.250.6.10
```

Error Message: E000, E102

ping

Access: Super User, Administrator, Device User, Network-Only User

Description: Determine whether the device with the IP address or DNS name you specify is connected to the network. Four inquiries are sent to the address.

Parameters:

Option	Argument	Description
n/a	<IP address or DNS name>	Type an IP address with the format xxx.xxx.xxx.xxx, or the DNS name configured by the DNS server.
-t		Ping until stopped.

Example: To determine whether a device with an IP address of 192.168.1.50 is connected to the network, type

```
apc> ping 192.168.1.50
E000: Success
Reply from 192.168.1.50: time(ms)= <10
Reply from 192.168.1.50: time(ms)= <10
Reply from 192.168.1.50: time(ms)= <10
Reply from 192.168.1.50: time(ms)= <10
```

Error Message: E000, E100, E102

portSpeed

Access: Super User, Administrator, Network-Only User

Description: Define the communication speed of the Ethernet port.

NOTE: The Port Speed setting can be changed to 1000 Mbps. However, this change can only be made via the Web UI.

Parameters:

Option	Arguments	Description
-s	auto 10H 10F 100H 100F	<p>auto enables the Ethernet devices to negotiate to transmit at the highest possible speed.</p> <p>H = Half Duplex (communication in only one direction at a time)</p> <p>F = Full Duplex (communication in both directions simultaneously)</p> <p>10 = 10 Megabits</p> <p>100 = 100 Megabits</p>

Example: To configure the TCP/IP port to communicate using 100 Mbps with half-duplex communication, type

```
apc> portspeed -s 100H
E000: Success
Reboot required for change to take effect.
```

Error Message: E000, E102

prompt

Access: Super User, Administrator, Device User, Network-Only User

Description: Configure the command line interface prompt to include or exclude the account type of the currently logged-in user. Any user can change this setting; all user accounts will be updated to use the new setting.

Parameters:

Option	Argument	Description
-s	long	The prompt includes the account type of the currently logged-in user.
	short	The default setting. The prompt is four characters long: apc>

Example:

```
apc> prompt -s long
E000: Success
```

```
Administrator@apc>prompt -s short
E000: Success
```

Error Message: E000, E102

pwd

Access: Super User, Administrator, Device User, , Read-Only User, Network-Only User

Description: Output the path of the current working directory.

Parameters: None

Example:

```
apc> pwd
/
```

```
apc> cd logs
E000: Success
```

```
apc> pwd
/logs
```

Error Message: E000, E102

quit

Access: Super User, Administrator, Device User, , Read-Only User, Network-only User

Description: Exit the CLI session. This works the same as the `exit` or `bye` commands.

Parameters: None.

Example:

```
apc> quit
Bye
```

Error Message: None.

radius

Access: Super User, Administrator, Network-Only User

Description: View the existing RADIUS settings and configure basic authentication parameters for up to two RADIUS servers. Additional authentication parameters are available in the Web UI.

For detailed information about configuring your RADIUS server, see the [Network Management Card 3 Security Handbook](#).

Parameters:

Option	Argument	Description
-a	<local radiusLocal radius>	Configure RADIUS authentication: local = RADIUS is disabled. Local authentication is enabled. radiusLocal = RADIUS, then Local Authentication. RADIUS and local authentication are enabled. Authentication is requested from the RADIUS server first. If the RADIUS server fails to respond, local authentication is used. radius = RADIUS is enabled. Local authentication is disabled.
-p1 -p2	<server IP>	The server name or IP address of the primary or secondary RADIUS server.
-o1 -o2	<port>	The port number of the primary or secondary RADIUS server. NOTE: RADIUS servers use port 1812 by default to authenticate users. The Rack PDU supports ports 1 to 65535.
-s1 -s2	<server secret>	The shared secret between the primary or secondary RADIUS server and the Rack PDU.
-t1 -t2	<server timeout>	The time in seconds that the Rack PDU waits for a response from the primary or secondary RADIUS server.

Example 1: To view the existing RADIUS settings for the Rack PDU, type `radius` and press ENTER.

Example 2: To configure a 10-second timeout for a secondary RADIUS server, type

```
apc> radius -t2 10
E000: Success
```

Error Message: E000, E102

reboot

Access: Super User, Administrator, Network-Only User

Description: Restart the network management interface of the Rack PDU only. This does not affect the output power of the Rack PDU.

Option	Description
-Y	Skip confirmation prompt (Uppercase Y only)

Example 1:

```
apc> reboot
E000: Success
Reboot Management Interface
Enter 'YES' to continue or <ENTER> to cancel: YES
Rebooting...
```

Example 2:

```
apc> reboot -Y
E000: Success
Reboot Management Interface
Rebooting...
```

Error Message: E000, E100

resetToDef

Access: Super User, Administrator

Description: Reset all configurable parameters to their defaults. Delete all accounts and clear Event and Data Logs.

NOTE: Certain non-configurable parameters are not reset using `resetToDef`, and can only be erased from the Rack PDU by formatting the file system using the `format` command.

Parameters:

Option	Arguments	Description
-p	all keepip	Caution: This resets all configurable parameters to their defaults. all = Reset all configuration changes, including event actions, device settings, and TCP/IP settings. keepip = Reset all configuration changes, <i>except</i> for the TCP/IP settings.

Example: To reset all of the configuration changes *except* the TCP/IP settings, type

```
apc> resettodef -p keepip
Reset to Defaults Except TCP/IP
Enter 'YES' to continue or <ENTER> to cancel: YES
```

Error Message: E000, E100

session

Access: Super User, Administrator

Description: Records who is logged in (user), the interface, the address, time and ID.

Parameters:

Option	Arguments	Description
-d	[-d <session nID>] (Delete)	Delete the session for the current user with the specified session ID.
-m	<enable disable> (MultiUser Enable)	Enable to allow two or more users to log on at the same time. Disable to allow only one user to log in at a time.
-a	<enable disable> (Remote Authentication Override)	The Rack PDU supports RADIUS storage of passwords on a server. Enable Remote Authentication Override to allow a local user to log on using a username and password for the Rack PDU that is stored locally on the Rack PDU.

Example:

```
apc> session
User      Interface  Address          Logged In Time  ID
-----
apc      Telnet     10.169.118.1    00:00:03       19
              -00
```

E000: Success

Error Message: E000, E102

smtp

Access: Super User, Administrator, Network-Only User

Description: Configure the settings for the local e-mail server.

Parameters:

Option	Arguments	Description
-f	<From Address>	The address from which e-mail will be sent by the Rack PDU.
-s	<SMTP Server>	The IPv4/IPv6 address or DNS name of the local SMTP server.
-p	<Port>	The SMTP port number, 25 by default. Common ports are 25 for unencrypted e-mail, and 465 and 587 for SSL/TLS encrypted e-mail. You can change the port setting to any port from 1 to 65535.
-a	<enable disable>	Enable this if your SMTP server requires authentication.
-u	<User Name>	If the SMTP server requires authentication, type the user name and password here.
-w	<Password>	
-e	<none ifavail always implicit>	<p>Encryption options:</p> <p>none: The SMTP server does not require/support encryption.</p> <p>ifavail: The SMTP server advertises support for STARTTLS but does not require the connection to be encrypted. The STARTTLS command is sent after the advertisement is given. This is typically used with port 25.</p> <p>always: The SMTP server requires the STARTTLS command to be sent upon connection to the server. This is typically used with port 587.</p> <p>implicit: The SMTP server only accepts connections that begin encrypted. No STARTTLS message is sent to the server. This is typically used with port 465.</p>
-c	<enable disable>	<p>Require CA Root Certificate.</p> <p>This should be enabled if the security policy of your organization does not allow for implicit trust of SSL/TLS connections. If this is enabled, a valid CA certificate for the SMTP server must be installed to the Rack PDU's certificate store using the certificate loader in order for a TLS connection with the SMTP server to succeed.</p>
-i	<certificate file name>	The file name of the certificate.

Example:

```
apc> smtp
E000: Success
```

```
From: address@example.com
Server: mail.example.com
Port: 25
Auth: disabled
User: User
Password: <not set>
Encryption: none
Req. Cert: disabled
Cert File: <n/a>
```

Error Message: E000, E102

snmp

Access: Super User, Administrator, Network-Only User

Description: Enable or disable and configure SNMPv1.

NOTE: SNMPv1 is disabled by default. The Community Name (-c [n]) must be set before SNMPv1 communications can be established.

Parameters:

Option	Arguments	Description
-S	<enable disable>	Enable or disable SNMPv1
-c [n]	<Community>	Specify a community name or string.
-a [n]	<read write writeplus disable>	Indicate the usage rights.
-n [n]	<IP or Domain Name>	Specify the IPv4/IPv6 address or the domain name of the Network Management Station.
[n] = the access control number: 1,2,3, or 4.		

Example: To enable SNMP version1, type

```
apc> snmp -S enable
```

```
E000: Success
```

```
Reboot required for change to take effect.
```

Error Message: E000, E102

snmpv3

Access: Super User, Administrator

Description: Enable or disable and configure SNMPv3.

NOTE: SNMPv3 is disabled by default. A valid user profile must be enabled with passphrases (-a [n], -c [n]) set before SNMPv3 communications can be established.

Parameters:

Option	Arguments	Description
-s	<enable disable>	Enable or disable SNMPv3
-u [n]	<User Name>	Specify a user name, an authentication phrase and encryption phrase.
-a [n]	<Auth phrase>	
-c [n]	<Crypt phrase>	
-ap [n]	<sha md5 none>	Indicate the type of authentication protocol.
-pp [n]	<aes des none>	Indicate the privacy (encryption) protocol.
-ac [n]	<enable disable>	Enable or disable access.
-au [n]	<User profile name>	Give access to a specified user profile.
-n [n]	<IP or Domain Name>	Specify the IPv4/IPv6 address or the hostname for the Network Management Station.
[n] = Access Control # = 1, 2, 3, through 8		

Example: To give access level 2 to user "JMurphy", type

```
apc> snmpv3 -au2 "JMurphy"
```

```
E000: Success
```

*Reboot required for change to take effect

Error Message: E000, E102

snmptrap

Access: Super User, Administrator, Network-Only User

Description: Enable or disable SNMP trap generation

Parameters:

Option	Arguments	Description
-c [n]	<Community>	Specify a community name or string.
-r [n]	<Receiver NMS IP>	The IPv4/IPv6 address or host name of the trap receiver.
-l [n]	<Language code>	Specify a language. English (enUS) is the only available option at this time.
-t [n]	[snmpV1 snmpV3]	Specify the trap type: SNMPv1 or SNMPv3.
-p [n]	<Port>	Specify the SNMP trap port number for this trap receiver (162 by default). The range is 1 to 65535.
-g [n]	[enable disable]	Enable or disable trap generation for this trap receiver. Enabled by default.
-a [n]	[enable disable]	Enable or disable authentication of traps for this trap receiver, SNMPv1 only.
-u [n]	<profile1 profile2 profile3 profile4>	Select the identifier of the user profile for this trap receiver, SNMPv3 only.
n = Trap receiver # = 1, 2, 3, 4, 5, or 6		

Example: To enable and configure an SNMPv1 trap for Receiver 1, with the Community Name of public, receiver 1 IP address of 10.169.118.100, using the default English language, type

```
apc> snmptrap -c1 public -r1 10.169.118.100 -l1 enUS -t1
snmpV1 -g1 enable
E000: Success
```

Error Message: E000, E102

ssh

Access: Super User, Administrator, Network-Only User

Description: Show, delete, and generate SSH server keys.

NOTE: You must use the `ssh key` command to use the options below.

Parameters:

Option	Argument	Description
-s		Display the current SSH server key in use.
-f		Display the current SSH server key's fingerprint.
-d		Delete the current SSH server key in use.
-i	<filename>.p15	Import the SSH server key from a PKCS #15 file.
-ecdsa	<256> (bit size)	Generate an Elliptic Curve Digital Signature Algorithm (ECDSA) SSH server key with the specified size in bits.
-rsa	<1024 2048 4096> (bit size)	Generate a Rivest–Shamir–Adleman (RSA) SSH server key with the specified size in bits.

Example 1: To delete the SSH server key, type

```
apc> ssh key -d
E000: Success
```

Example 2: To import the SSH server key from a .p15 file generated by the NMC Security Wizard CLI Utility, type

```
apc> ssh key -i nmc.p15
E000: Success
```

Error Messages: E000, E102

ssl

Access: Super User, Administrator, Network-Only User

Description: Configure and manage the Rack PDU's public key and Web UI certificate, and create a Certificate Signing Request (CSR).

NOTE: There are three sets of options for this command, indicated below (`key`, `csr`, and `cert`).

Configure public keys (`key`):

Option	Argument	Description
<code>-s</code>		Display the current public key in use.
<code>-d</code>		Delete the current public key in use.
<code>-i</code>	<filename>.p15	Import the public key from a PKCS #15 file.
<code>-ecdsa</code>	<256 384 521>	Generate an Elliptic Curve Digital Signature Algorithm (ECDSA) public key with the specified size in bits.
<code>-rsa</code>	<1024 2048 4096>	Generate a Rivest–Shamir–Adleman (RSA) public key with the specified size in bits.

*You can generate a PCKS#15 file with the NMC Security Wizard (available on www.apc.com).

Example 1: To generate a new ECDSA-521 public key, type

```
apc> ssl key -ecdsa 521
```

```
E000: Success
```

Example 2: To import the public key from a .p15 file generated by the NMC Security Wizard CLI Utility, type

```
apc> ssl key -i nmc.p15
```

```
E000: Success
```

Configure Certificate Signing Request (`csr`):

Option	Argument	Description
<code>-s</code>	<File Name>	Show the current CSR. If no file path is specified, the command checks the default location: <code>ssl/nmc.csr</code> .
<code>-q</code>	<File Name>	Create a CSR from an active configuration. If no file path is specified, the CSR is stored at the default location: <code>ssl/nmc.csr</code>
<code>-CN</code>	<Common Name>	Create a custom CSR. The Common Name is the fully qualified domain name (FQDN) of the Rack PDU. For example, its IP address or <code>*.nmc.local</code> .
Custom Certificate Signing Request (CSR) options. NOTE: The options below are only available for <code>-CN</code>		
<code>-O</code>	<organization>	The name of your organization.
<code>-OU</code>	<organization unit>	The division of your organization handling the certificate.
<code>-C</code>	<country>	The two-letter country code of where your organization is located.
<code>-san</code>	<Common Name IP Address>	The Common Name or IP address of the Rack PDU.

NOTE: Created Certificate Signing Requests will be stored in the Rack PDU's `ssl` directory. See `dir`, page 35.

Example 3: To create a quick CSR from the current configuration, type

```
apc> ssl csr -q
```

```
E000: Success
```

Example 4: To create a minimal CSR, type

```
apc> ssl csr -CN 192.168.1.100 -C US
```

```
E000: Success
```

Example 5: To create a custom Certificate Signing Request (CSR), type

```
apc> ssl csr -CN apcXXXXXX.nmc.local -C US -san *.nmc.local
```

```
-san 190.0.2.0
```

```
E000: Success
```

Configure the Web UI's certificate (cert):

Option	Argument	Description
-s	<File Name>	Display the specified certificate. NOTE: Executing this option without an argument will display the current certificate in use.
-f	<File Name>	Display the specified certificate's fingerprint. NOTE: Executing this option without an argument will display the current certificate's fingerprint.
-i	<File Name>	Import a certificate.

NOTE: The argument is optional for all three options. If no file path is specified, the command checks the default location: ssl/nmc.crt.

Example 6: To show the active certificate, type

```

apc> ssl cert -s
E000: Success
Certificate

Serial Number: XXXXxXXXXXXXXxXXXXx
Issuer: CN=., C=US
Validity:
  Not Before: Mon Oct 11 16:46:44 2021 UTC
  Not Before: Sat Dec 15 23:59:59 2035 UTC

Subject: CN=., C=US
Subject Public Key Info:

  Public Key Algorithm: ECDSA (256 bit)
  X:
    xx:xx:xx:xx:xx:xx:xx:xx:xx:xx:xx:xx:xx:xx:xx:xx:
    xx:xx:xx:xx:xx:xx:xx:xx:xx:xx:xx:xx:xx:xx:xx:xx:
  Y:
    xx:xx:xx:xx:xx:xx:xx:xx:xx:xx:xx:xx:xx:xx:xx:xx:
    xx:xx:xx:xx:xx:xx:xx:xx:xx:xx:xx:xx:xx:xx:xx:xx:
  Curve: P-256

Thumbprint: xxxxxxxxxxxxxxxxxxxxxxxxxxxxxxxxxxxxxxxxxxxx
Fingerprint:
xxxxxxxxxxxxxxxxxxxxxxxxxxxxxxxxxxxxxxxxxxxxxxxxxxxxxxxx
    
```

Example 7: To display nmc.crt located in the ssl directory, type

```
ssl cert -s ssl/nmc.crt
```

Example 8: To import another certificate (*other.crt*), type

```
apc> ssl cert -i other.crt
```

Error Messages: E000, E102

system

Access: Super User, Administrator

Description: View and set the system name, the contact, the location. Configure system messages, view up time as well as the date and time, the logged-on user, and the high-level system status P, N, A. (See About the Main Screen, page 26 for more information about system status).

Parameters:

Option	Argument	Description
-n	<system name>	Define the device name, the name of the person responsible for the device, and the physical location of the device. NOTE: If you define a value with more than one word, you must enclose the value in quotation marks. These values are also used by StruxureWare Data Center Expert, or EcoStruxure IT Expert and the Rack PDU's SNMP agent.
-c	<system contact>	
-l	<system location>	
-m	<system message>	Show a configurable custom message or banner on the logon page of the Web UI, CLI (Serial, Telnet, SSH), FTP or SCP.
-s	<enable disable>	Allow the host name to be synchronized with the system name so both fields automatically contain the same value. This is the same as using "dns -y". NOTE: When enabling this feature, the system name identifier can no longer contain a space character (since it will be synchronized to the host name field).

Example 1: To set the device location as Test Lab, type

```
apc> system -l "Test Lab"
E000: Success
```

Example 2: To set the system name as Don Adams, type

```
apc> system -n "Don Adams"
E000: Success
```

Error Message: E000, E102

tcpip

Access: Super User, Administrator

Description: View and manually configure IPV4 TCP/IP settings for the Rack PDU.

Parameters:

Option	Argument	Description
-s	enable disable	Enable or disable TCP/IP v4.
-i	<IPv4 address>	Type the IP address of the Rack PDU, using the format xxx.xxx.xxx.xxx
-m	<subnet mask>	Type the subnet mask for the Rack PDU.
-g	<gateway>	Type the IP address of the default gateway. Do not use the loopback address (127.0.0.1) as the default gateway.
-d	<domain name>	Type the DNS name configured by the DNS server.
-h	<host name>	Type the host name that the Rack PDU will use.

Example 1: To view the network settings of the Rack PDU, type

```
apc> tcpip
E000: Success
IP Address:      192.168.1.50
MAC Address:    XX XX XX XX XX XX
Subnet Mask:    255.255.255.0
Gateway:       192.168.1.1
Domain Name:   example.com
Host Name:     HostName
```

Example 2: To manually configure an IP address of 192.168.1.49, type

```
apc> tcpip -i 192.168.1.49
E000: Success
Reboot required for change to take effect
```

Error Message: E000, E102

tcpip6

Access: Super User, Administrator

Description: Enable IPv6. View and manually configure these network settings for the Rack PDU:

Parameters:

Option	Argument	Description
-s	enable disable	Enable or disable IPv6.
-man	enable disable	Enable manual addressing for the IPv6 address of the Rack PDU.
-auto	enable disable	Enable the Rack PDU to automatically configure the IPv6 address
-i	<IPv6 address>	Set the IPv6 address of the Rack PDU
-g	<IPv6 gateway>	Set the IPv6 address of the default gateway
-d6	router stateful stateless never	Set the DHCPv6 mode, with parameters of router controlled. stateful (for address and other information, they maintain their status), stateless (for information other than address, the status is not maintained), or never.

Example 1: To view the network settings of the Rack PDU, type `tcpip6` and press ENTER.

```
apc> tcpip6
E000: Success
IPv6:                               enabled
Manual Settings:                     disabled
IPv6 Address:                         ::/64
MAC Address:                          XX XX XX XX XX XX
Gateway:                              ::
IPv6 Manual Address:                  disabled
IPv6 Autoconfiguration:               enabled
DHCPv6 Mode:                          router controlled
```

Example 2: To manually configure an IPv6 address of 2001:0:0:0:0:FFD3:0:57ab for the, type

```
tcpip -i 2001:0:0:0:0:FFD3:0:57ab
```

Error Message: E000, E102

user

Access: Super User, Administrator

Description: Configure the user name, password, and inactivity timeout for each account type.

NOTE: You can't edit a user name; you must delete it and then create a new user.

NOTE: To change the Super User account settings remotely, you must enter the current password (-cp).

Parameters:

Option	Argument	Description
-n	<user>	Indicate the user.
-cp	<current password>	For a Super User, you must specify the current password. NOTE: The -cp option is only required when changing the Super User's settings remotely.
-pw	<user password>	Specify these options for a user. NOTE: The description must be enclosed in quotation marks.
-pe	<user permission>	
-d	<user description>	
-e	enable disable	Enable or disable access for the particular user account.
-te	enable disable	Enable or disable touch screen access.
-tp	<touch screen access pin>	This option is only available on certain devices.
-tr	enable disable	Enable the touch screen remote authorization override. This option is only available on certain devices. If you enable this override, the Rack PDU will allow a local user to log on using the password for the Rack PDU that is stored locally on the Rack PDU.
-st	<session timeout>	Specify how long a session lasts when the keyboard is idle before the user is automatically logged off.
-sr	enable disable	Bypass RADIUS by using the serial console (CLI) connection, also known as Serial Remote Authentication Override
-el	enable disable	Indicate the Event Log color coding.
-lf	tab csv	Indicate the format for exporting a log file.
-ts	us metric	Indicate the temperature scale, Fahrenheit or Celsius.
-df	<mm/dd/yyyy dd.mm.yyyy mmm-dd-yy dd-mmm-yy yyyy-mm-dd>	Specify a date format.
-lg	<language code (e.g. enUs)>	Specify a user language. English is the only available language at this time.
-del	<user name>	Delete a user.
-l		Display the current user list.

Example 1: To change the log off time to 10 minutes for user "JMurphy", type
`user -n "JMurphy" -st 10`

Example 2: To change the log off time to 10 minutes for the Super User "apc", type
`user -n "apc" -cp <password> -st 10`

Error Message: E000, E102

userdfit

Access: Super User, Administrator

Description: Complimentary function to “user” establishing default user preferences. There are two main features for the default user settings:

Determine the default values to populate in each of the fields when the Super User or Administrator-level account creates a new user. These values can be changed before the settings are applied to the system.

For remote users (user accounts not stored in the system that are remotely authenticated such as RADIUS) these are the values used for those that are not provided by the authenticating server. For example, if a RADIUS server does not provide the user with a temperature preference, the value defined in this section will be used.

Parameters:

Options	Argument	Description
-e	<enable disable>	By default, user will be enabled or disabled upon creation.
-pe	<Administrator Device Read-Only Network-Only>	Specify the user's permission level and account type.
-d	<user description>	Provide a user description. The description must be enclosed in quotation marks.
-st	<session timeout> minute(s)	Provide a default session timeout.
-bl	<bad login attempts>	Number of incorrect login attempts a user has before the system disables their account. Upon reaching this limit, a message is displayed informing the user the account has been locked. The Super User or an Administrator-level account is needed to re-enable the account to allow the user to log back in. NOTE: A Super User account cannot be locked out, but can be manually disabled if necessary.
-el	<enable disable> (Event Log Color Coding)	Enable or disable event log color coding.
-lf	<tab csv> (Export Log Format)	Specify the log export format, tab or CSV.
-ts	<us metrics> (Temperature Scale)	Specify the user's temperature scale. This setting is also used by the system when a user preference is not available (for example, email notifications).
-df	<mm/dd/yyyy dd.mm.yyyy mmm-dd-yy dd- mmm-yy yyyy-mm-dd> (Date Format)	Specify the user's preferred date format.
-lg	<language code (enUs, etc) >	User language. Only enUs is supported at this time.
-sp	<enable disable>	Strong password requirements. When enabled: The password must be 8–64 characters long. The password must contain at least one lowercase letter, one uppercase letter, one number, and one symbol (! " # \$ % & ' () * + , - . / : ; < = > ? @ [\] ^ _ ` { } ~).
-pp	<interval in days>	Required password change interval.

Example: To set the default user's session timeout to 60 minutes, type

```
apc> userdfit -st 60
E000: Success
```

Error Message: E000, E102

web

Access: Super User, Administrator

Description: Enable access to the Web UI using HTTP or HTTPS.

For additional security, you can change the port setting for HTTP and HTTPS to any unused port from 5000 to 32768. Users must then use a colon (:) in the address field of the browser to specify the port number. For example, for a port number of 5000 and an IP address of 152.214.12.114, type: `http://152.214.12.114:5000`

Parameters:

Option	Argument	Definition
-h	enable disable	Enable or disable access to the user interface for HTTP. HTTP is disabled by default.
-s	enable disable	Enable or disable access to the user interface for HTTPS. HTTPS is enabled by default. When HTTPS is enabled, data is encrypted during transmission and authenticated by digital certificate.
-mp	<minimum protocol>	Specify the minimum protocol used by the web interface: SSL v3.0, TLS v1.1, or TLS v1.2.
-ph	<http port #>	Specify the TCP/IP port used by HTTP to communicate with the Rack PDU (80 by default). The other available range is 5000–32768.
-ps	<https port #>	Specify the TCP/IP port used by HTTPS to communicate with the Rack PDU (443 by default). The other available range is 5000–32768.
-lsp	enable disable	Enable or disable access to the Limited Status page in the Web UI.
-lsd	enable disable	Enable or disable the Limited Status page being used as the default page when accessing the device's IP or hostname in a web browser.
-cs	<0 1 2 3 4>	Select the level of security of TLS v1.2 cipher suites between 0 - 4, where 4 is the highest level of security, and 0 is the lowest level of security. The default value is 4. NOTE: The -cs option is only applied when -mp is set to TLS v1.2. When a value between 0 - 4 is entered, the CLI responds with a list of the currently allowed SSL cipher suites.
-hs	enable disable	Enable/ disable the HTTP Strict Transport Security Header (HSTS) response header.

Example 1: To prevent all access to the Web UI, type

```
apc> web -h disable -s disable
```

Example 2: To define the TCP/IP port used by HTTP, type

```
apc> web -ph 80
E000: Success
```

Error Message: E000, E102

whoami

Access: Super User, Administrator, Device User, Read-Only User, Network-Only User

Description: Provides login information on the current user.

Parameters: None

Example:

```
apc> whoami
E000: Success
admin
```

Error Message: E000, E102

wifi

Reserved for future use.

xferINI

Access: Super User, Administrator

Description: Use XMODEM to upload an INI file while you are accessing the Command Line Interface through a serial connection. After the upload completes:

- If there are any system or network changes, the Command Line Interface restarts and you must log on again.
- If you selected a baud rate for the file transfer that is not the same as the default baud rate for the NMC, you must reset the baud rate to the default to reestablish communication with the NMC.

Parameters: None

Example:

```
apc> xferINI
Enter 'YES' or 'Y' to continue or <ENTER> to cancel: <user
enters 'YES' or 'Y'>
---- File Transfer Baud Rate -----
      1- 2400
      2- 9600
      3- 19200
      4- 38400
> <user enters baudrate selection>
Transferring at current baud rate (9600), press <ENTER>...
<user presses <ENTER>>
Start XMODEM-CRC Transfer Now!
CC
<user starts sending INI>
150 bytes have successfully been transmitted.

apc>
```

Error Message: None

xferStatus

Access: Super User, Administrator

Description: View the result of the last file transfer.

Parameters: None

Example:

```
apc> xferStatus
E000: Success

Result of last file transfer: Successful

See Last Transfer Result Codes, page 162 for descriptions of the transfer result
codes.
```

Error Message: E000

Device Command Descriptions

Network Port Sharing Commands

The CLI allows commands to be sent to guest Rack PDUs. The user may specify the Display ID of the Rack PDU to be commanded, followed by a colon, before the first argument (or as the first argument, if the command does not normally have arguments). If a Display ID is optional, omitting it will simply command the local Rack PDU.

For example: <command> [<id#>:]<arg1> <arg2>

This will send <command> <arg1> <arg2> to the Rack PDU with the Display ID specified by [<id#>:]. The Display ID is followed by a colon (:), which is followed by <arg1> with no spaces. Spaces are used to delimit arguments.

alarmList

Access: Super User, Administrator, Device User

Description: Displays alarms present on the device (or another device in the group if NPS is used.) The id# may be from 1 to 32 depending on the group size.

Parameters: None.

Example: To view all active warning alarms, type:

```
apc> alarmList [<id#>:]
```

```
-----Device Alarm Status-----
```

```
      1 Critical Alarm Present.
```

```
-----  
[Critical] rack PDU 1: Internal power supply #2 fault, under  
voltage.
```

```
      <ESC>- Exit, <ENTER>- Refresh
```

Error Message: E102

bkLowLoad

Access: Super User, Administrator, Device User

Description: Set or view the bank low-load threshold current in amps. You can specify all banks, a single bank, a range, or a comma-separated list of single banks and/or ranges. The id# may be from 1 up to 32 depending on the group size.

Parameters: [`<id#>:`] `<all | bank#>` [`<current>`]

`bank#` = A single number or a range of numbers separated with a dash or a comma; separated list of single bank number and/or number ranges. `current` = The new bank threshold (Amps)

Example 1: To set the low-load threshold for all banks to 1A, type:

```
apc> bkLowLoad all 1
E000: Success
```

Example 2: To view the low-load threshold setting for banks 1 through 3, type:

```
apc> bkLowLoad 1-3
E000: Success
1: 1 A
2: 1 A
3: 1 A
```

Error Message: E000, E102

bkNearOver

Access: Super User, Administrator, Device User

Description: Set or view the bank near-overload threshold current in amps. You can specify all banks, a single bank, a range, or a comma-separated list of single banks and/or ranges. The id# may be from 1 up to 32 depending on the group size.

Parameters: [`<id#>:`] `<all | bank#>` [`<current>`]

Example 1: To set the near-overload threshold for all banks to 10A, type:

```
apc> bkNearOver all 10
E000: Success
```

Example 2: To view the near-overload threshold setting for banks 1 through 3, type:

```
apc> bkNearOver 1-3
E000: Success
1: 10 A
2: 10 A
3: 10 A
```

Example 3: To view the near-overload threshold setting for banks 1 and 2 on guest Rack PDU 3, type:

```
apc> bkNearOver 3:1-2
E000: Success
1: 16 A
2: 16 A
```

Error Message: E000, E102

bkOverLoad

Access: Super User, Administrator, Device User

Description: Set or view the bank overload threshold current in amps. You can specify all banks, a single bank, a range, or a comma-separated list of single banks and/or ranges. The id# may be from 1 up to 32 depending on the group size.

Parameters: [`<id#>:`] `<all | bank#>` [`<current>`]

Example 1: To set the bank overload threshold for all banks to 13A, type:

```
apc> bkOverLoad all 13
E000: Success
```

Example 2: To view the bank overload threshold setting for banks 1 through 3, type:

```
apc> bkOverLoad 1-3
E000: Success
1: 13 A
2: 13 A
3: 13 A
```

Error Message: E000, E102

bkPeakCurr

Access: Super User, Administrator, Device User

Description: Display the peak current measurement from a bank(s). The id# may be from 1 to 32 depending on the group size.

Parameters: [`<id#>:`] `<"all" | bank#>`

Example:

```
apc> bkPeakCurr 2
E000: Success
2: 0.0 A
```

```
apc> bkPeakCurr all
E000: Success
1: 0.0 A
2: 0.0 A
```

Error Message: E000, E102

bkReading

Access: Super User, Administrator, Device User, Read Only

Description: View the current reading (measurement) in amps for a bank. You can specify all banks, a single bank, a range, or a comma-separated list of single banks and/or ranges. The id# may be from 1 to 32 depending on the group size.

Parameters: [<id#>:] [<all | bank#>]

Example 1: To view the current reading for bank 3, type:

```
apc> bkReading 3
E000: Success
3: 4.2 A
```

Example 2: To view the current reading for all banks, type:

```
apc> bkReading all
E000: Success
1: 6.3 A
2: 5.1 A
3: 4.2 A
```

Error Message: E000, E102

bkRestrictn

Access: Super User, Administrator, Device User

Description: Set or read the overload restriction feature to prevent users from applying power to outlets when an overload threshold is violated. The id# may be from 1 to 32 depending on the group size.

Parameters: [<id#>:] < all | phase#> [<none | near | over >]

Acceptable arguments are none, near, and over.

To specify phases, choose from the following options.

Type: all, a single phase, a range, or a comma-separated list of phases.
phase# = A single number or a range of numbers separated with a dash or a comma separated list of single phase number and/or number ranges.

Example 1: To set the overload restriction for phase three to none, type:

```
apc> bkRestrictn 3 none
E000: Success
```

Example 2: To view the overload restrictions for all phases, type:

```
apc> bkRestrictn all
E000: Success
1: over
2: near
3: none
```

Example 3: To view the overload restrictions for all phases on guest Rack PDU 2, type:

```
apc> bkRestrictn 2:all
E000: Success
1: None
2: None
```

Error Message: E000, E102

devLowLoad

Access: Super User, Administrator, Device User

Description: Set or view the device low-load warning threshold in kilowatts. The id# may be from 1 to 32 depending on the group size.

Parameters: [`<id#>:`] [`<threshold>`] = New power threshold (Kilowatts).

Example 1: To view the low-load threshold, type:

```
apc> devLowLoad
E000: Success
0.5 kW
```

Example 2: To set the low-load threshold to 1 kW, type:

```
apc> devLowLoad 1.0
E000: Success
```

Error Message: E000, E102

devNearOver

Access: Super User, Administrator, Device User

Description: Set or view the near-overload threshold in kilowatts for the device. The id# may be from 1 to 32 depending on the group size.

Parameters: [`<id#>:`] [`<threshold>`] = New outlet threshold (Kilowatts).

Example 1: To view the near-overload threshold, type:

```
apc> devNearOver
E000: Success
20.5 kW
```

Example 2: To set the near-overload threshold to 21.3 kW, type:

```
apc> devNearOver 21.3
E000: Success
```

Error Message: E000, E102

devOverLoad

Access: Super User, Administrator, Device User

Description: Set or view the overload threshold in kilowatts for the device. The id# may be from 1 to 32 depending on the group size.

Parameters: [`<id#>:`] [`<threshold>`] = New outlet threshold (Kilowatts).

Example 1: To view the overload threshold, type:

```
apc> devOverLoad
E000: Success
25.0 kW
```

Example 2: To set the overload threshold to 25.5 kW, type:

```
apc> devOverLoad 25.5
E000: Success
```

Example 3: To view the overload threshold for guest Rack PDU 3, type:

```
apc> devOverLoad 3:
E000: Success
5.0 kW
```

Error Message: E000, E102

devPeakLoad

Access: Super User, Administrator, Device User

Description: Display the peak power measurement from the device. The id# may be from 1 to 32 depending on the group size.

Parameters: [`<id#>:`]

Example:

```
apc> devPeakLoad
E000: Success
0.0 kW
```

Error Message: E000, E102

devReading

Access: Super User, Administrator, Device User, Read Only

Description: View the total power in kilowatts or total energy in kilowatt-hours for the device.

Parameters: [`<id#>:`] `<power | energy | appower | pf>`

Argument	Definition
<code><power></code>	View the total power in kilowatts
<code><energy></code>	View the total energy in kilowatt-hours
<code><appower></code>	View the total apparent power in kVA
<code><pf></code>	View the power factor

Example 1: To view the total power, type:

```
apc> devReading power
E000: Success
5.2 kW
```

Example 2: To view the total energy, type:

```
apc> devReading energy
E000: Success
200.1 kWh
```

Error Message: E000, E102

devStartDly

Access: Super User, Administrator, Device User

Description: Set or view the amount of time in seconds, which is added to each outlet's Power On Delay before the outlet will turn on after power is applied to the PDU (Cold Start Delay). Allowed values are within the range of 1 to 300 seconds or never (never turn on). The `id#` may be from 1 to 32 depending on the group size.

Parameters: [`<id#>:`] [`<time | never>`]

Argument	Definition
[<code>time "never"</code>]	time = Cold start delay time in whole seconds or "never"; case insensitive

Example 1: To view the cold start delay, type:

```
apc> devStartDly
E000: Success
5 seconds
```

Example 2: To set the cold start delay to six seconds, type:

```
apc> devStartDly 6
E000: Success
```

Example 3: To set the cold start delay to six seconds on guest Rack PDU 2, type:

```
apc> devStartDly 2:6
E000: Success
```

Example 4: To view the cold start delay on guest Rack PDU 2, type:

```
apc> devStartDly 2:
E000: Success
6 sec
```

Error Message: E000, E102

dispID

Access: Super User, Administrator

Description: Sets or reads the device's Display ID. The id# may be from 1 to 32 depending on the group size.

Parameters: [`<id#>:`] [`<new_id#>`] = Set the Display ID.

Example:

```
apc> dispID
E000: Success
RPDU ID: 1*
apc> dispID 2
E000: Success
RPDU ID: 2*
apc> dispID 3: 2
E000: Success
```

Error Message: E000, E102

Temperature/Humidity Sensors

NOTE: You must have installed an optional APC by Schneider Electric Temperature/Humidity Sensor (AP9335TH) to your Rack PDU in order to use the Humidity related commands.

humAlGen

Access: Super User, Administrator, Device User

Description: Sets and reads whether humidity alarms are enabled or disabled. The id# may be from 1 to 32 depending on the group size.

Parameters: [`<id#>:`][`<enable | disable>`]

enable = enable humidity alarms.

disable = disable humidity alarms.

Example:

```
apc> humAlGen enable
E000: Success

apc> humAlGen disable
E000: Success
```

Error Message: E000, E102

humHyst

Access: Super User, Administrator, Device User

Description: Sets and reads the humidity threshold hysteresis value. The id# may be from 1 to 32 depending on the group size.

Parameters: [`<id#>:`] [`<value>`] = new threshold hysteresis value (% RH)

Example:

```
apc> humHyst
E000: Success
6 %RH
```

```
apc> humHyst 5
E000: Success
```

Error Message: E000, E102

humLow

Access: Super User, Administrator, Device User

Description: Set or view the low humidity threshold as a percent of the relative humidity. The id# may be from 1 to 32 depending on the group size.

Parameters: [`<id#>:`] [`<humidity>`] = new low humidity threshold

Example 1: To view the low humidity threshold, type:

```
apc> humLow
E000: Success
10 %RH
```

Example 2: To set the low humidity threshold, type:

```
apc> humLow 12
E000: Success
```

Example 3: To view the low humidity threshold on guest Rack PDU 3, type:

```
apc> humLow 3:
E000: Success
10 %RH
```

Error Message: E000, E102

humMin

Access: Super User, Administrator, Device User

Description: Set or view the minimum humidity threshold as a percent of the relative humidity. The id# may be from 1 to 32 depending on the group size.

Parameters: [<id#>:] [<humidity>] = new minimum humidity threshold

Example 1: To view the minimum humidity threshold, type:

```
apc> humMin
E000: Success
6 %RH
```

Example 2: To set the minimum humidity threshold, type:

```
apc> humMin 8
E000: Success
```

Example 3: To set the minimum humidity threshold on guest Rack PDU 3 to 18% RH, type:

```
apc> humMin 3:18
E000: Success
```

Error Message: E000, E102

humReading

Access: Super User, Administrator, Device User, Outlet User, Read Only

Description: View the humidity value from the sensor. The id# may be from 1 to 32 depending on the group size.

Parameters: [<id#>:]

Example 1: To view the humidity value, type:

```
apc> humReading
E000: Success
25 %RH
```

Example 2: To view the humidity value on guest Rack PDU 2, type:

```
apc> humReading 2:
E000: Success
48 %RH
```

Error Message: E000, E102, E201

humStatus

Access: Super User, Administrator, Device User, Read Only

Description: Displays the status of the sensor. The id# may be from 1 to 32 depending on the group size. Responses: Not Connected, Min Threshold Violation, Low Threshold Violation, Normal.

Parameters: [<id#>:]

Example: To view the status of the humidity sensor, type:

```
apc> humStatus
Not Connected
```

Error Message: None

lcd

Access: Super User, Administrator, Device User

Description: Set or read the LCD (On/Off). The id# may be from 1 to 32 depending on the group size.

Parameters: [<id#>:] [<on|off>]

Example:

```
apc> lcd off
E000: Success
apc> lcd 1: on
E000: Success
```

Error Message: E000, E100, E102

lcdBlink

Access: Super User, Administrator, Device User

Description: Blink the LCD display for the specified time period. The id# may be from 1 to 32 depending on the group size. Valid timeout range is from 1 to 10 minutes.

Parameters: [<id#>:] <timeout> = is the number of minutes to blink the display.

Example:

```
apc> lcdBlink
E000: Success
```

Error Message: E000, E102

logToFlash

Access: Super User, Administrator

Description: Export the log files to the USB flash. The file will be a compressed file. It will contain event.txt, config.ini, debug.txt, data.txt. If an exception occurs, it will also contain dump.txt.

Parameters: [<filename>] = is the appendix to the debug file tar name. If no name is entered, the serial number of the device will be used as the name for the file.

Example 1:

```
apc>logToFlash 01292018
Creating report file: /debug_01292018.tar Press <ESC> to
abort
0% completed...
Exporting logs... please do not remove USB flash
12% completed...Exporting logs... please do not remove USB
flash...
Exporting logs... please do not remove USB
flash 60% completed...
Logs export completed. You may remove USB flash now
```

Example 2:

```
apc>logToFlash
Creating report file:
/debug_ZA1234567890.tar Press <ESC> to abort
0% completed...Exporting logs... please do not remove USB
flash
12% completed...Exporting logs... please do not remove USB
flash...
Exporting logs... please do not remove USB flash
60% completed...Logs export completed. You may remove USB
flash now
```

Error Messages: E000, E102

modbus

Access: Super User, Administrator

Description: View and configure the options for Modbus TCP. Modbus TCP allows a Building Management System (BMS) to monitor the Rack PDU.

Parameters:

Option	Argument	Definition
-te	<enable disable>	Enables or disables Modbus TCP.
-tp	<502 or 5000 to 32768>	Views or sets the Modbus TCP port number. (You can set the Modbus TCP port number in the Web UI.)
-tTo	<minimum protocol>	Specifies the Modbus TCP communication timeout in seconds, where 0 indicates that the connection never times out.
-ka	<enable disable>	Modbus TCP Keep-Alive. <ul style="list-style-type: none"> • If no communication is detected, the Rack PDU sends data packet to the server every 2 hours and 75 seconds. • Prevents communication timeout when the Communication Timeout is set to 7,275 seconds or more.
-rDef		Resets the Modbus configuration to defaults.

Example 1: To view modbus settings, type

```
apc> modbus
E002: Success
TCP Status = DISABLED
TCP Port Number = 502
TCP Communication Timeout = 5 secs
Keep-alive = ENABLED
```

Example 2: To enable Modbus TCP, type

```
apc> modbus -tE enable E002: Success
Reboot required for change to take effect.
```

Error Message: E000, E002, E101, E102

olAssignUsr

Access: Super User, Administrator

Description: Assign control of outlets to an outlet user that exists in the local database. The id# may be from 1 to 32 depending on the group size.

Parameters: [`<id#>:`] `<all | "outlet name" | outlet#>` `<user>`

Argument	Definition
all	All device outlets
<outlet name>	The name configured for a specific outlet. The outlet name must be specified as "outlet name" (in quotes) if the outlet name contains a space.
<outlet#>	A single number or a range of numbers separated with a dash, or a comma-separated list of single outlet numbers and number ranges.
<user>	A user that exists in the local database.

Example 1: To assign a user named Bobby to outlets 3, 5 through 7, and 10, type:

```
apc> olAssignUsr 3,5-7,10 bobby
E000: Success
```

Example 2: To assign a user named Billy to all outlets, type:

```
apc> olAssignUsr all billy
E000: Success
```

Example 3: To assign a user named Billy to all outlets on guest Rack PDU 3, type:

```
apc> olAssignUsr 3:all billy
E000: Success
```

Error Message: E000, E102

olCancelCmd

Access: Super User, Administrator, Device User, and Outlet User, but only for outlets to which the user is assigned.

Description: Cancels all pending commands for an outlet or group of outlets. The id# may be from 1 to 32 depending on the group size.

Parameters: [`<id#>:`] `<all | "outlet name" | outlet#>`

Argument	Definition
all	All device outlets.
<outlet name>	The name configured for a specific outlet.
<outlet#>	A single number or a range of numbers separated with a dash, or a comma-separated list of single outlet numbers and number ranges.

Example 1: To cancel all commands for outlet 3, type:

```
apc> olCancelCmd 3
E000: Success
```

Example 2: To cancel all commands for outlet 3 on guest Rack PDU 3, type:

```
apc> olCancelCmd 3:all
E000: Success
```

Error Message: E000, E102, E104

oDlyOff

Access: Super User, Administrator, Device User, and Outlet User, but only for outlets to which the user is assigned.

Description: Turns off an outlet or group of outlets after the Power Off Delay. The id# may be from 1 to 32 depending on the group size.

Parameters: [`<id#>:`] `<all | "outlet name" | outlet#>`

Argument	Definition
all	All device outlets.
<code><outlet name></code>	The name configured for a specific outlet.
<code><outlet#></code>	A single number or a range of numbers separated with a dash, or a comma-separated list of single outlet numbers and number ranges.

Example 1: To turn off outlets 3, 5 through 7, and 10, type:

```
apc> oDlyOff 3,5-7,10
E000: Success
```

Example 2: To turn off all outlets, type:

```
apc> oDlyOff all
E000: Success
```

Example 3: To turn off all outlets on guest Rack PDU 2, type:

```
apc> oDlyOff 2:all
E000: Success
```

Error Message: E000, E102, E104

oDlyOn

Access: Super User, Administrator, Device User, and Outlet User, but only for outlets to which the user is assigned.

Description: Turns on an outlet or group of outlets after the Power On Delay. The id# may be from, 1 to 32 depending on the group size.

Parameters: [`<id#>:`] `<all | "outlet name" | outlet#>`

Argument	Definition
all	All device outlets.
<code><outlet name></code>	The name configured for a specific outlet.
<code><outlet#></code>	A single number or a range of numbers separated with a dash, or a comma-separated list of single outlet numbers and number ranges.

Example 1: To turn on outlets 3, 5 through 7, and 10, type:

```
apc> oDlyOn 3,5-7,10
E000: Success
```

Example 2: To turn on an outlet with the configured name of Outlet1, type:

```
apc> oDlyOn outlet1
E000: Success
```

Error Message: E000, E102, E104

oIDlyReboot

Access: Super User, Administrator, Device User, and Outlet User, but only for outlets to which the user is assigned.

Description: Delays Cycle power to an outlet or a group of outlets. The specified outlets will be turned off based on the configured Power Off Delay. After the longest Reboot Duration of the selected outlets, the outlets will then begin to turn on based on the configured Power On Delays set for the specified outlets. The id# may be from 1 to 32 depending on the group size.

Parameters: [<id#>:] <all | "outlet name" | outlet#>

Example 1: To cycle power to outlets 3, 5 through 7, and 10, type:

```
apc> oIDlyReboot 3,5-7,10
E000: Success
```

Example 2: To cycle power to an outlet with the configured name of Outlet1, type:

```
apc> oIDlyReboot outlet1
E000: Success
```

Example 3: To cycle power to all outlets on guest Rack PDU 2, type:

```
apc> oIDlyReboot 2:all
E000: Success
```

Error Message: E000, E102, E104

oIGroups

Access: Super User, Administrator, Device User, and Outlet User.

Description: The CLI will not allow outlet synchronization groups to be assigned or managed, except via an INI file put/get. However, outlet group information can be retrieved using this command. Outlet synchronization groups can also be assigned and managed via the Web UI. An Outlet User can perform control commands on all outlets defined in an outlet synchronization group as long as one of the outlets has been assigned to them. Outlet synchronization can occur locally on one Rack PDU or across the network with multiple Rack PDUs depending on configuration. When an outlet is part of a synchronization group it will always be synchronized with the other members of the group. The id# may be from 1 to 32 depending on the group size.

Lists the outlet synchronization groups defined on the Switched Rack PDU. If synchronization of outlets between devices is enabled, information of those devices is also listed.

Parameters: [<id#>:]

Example 1: To list outlet synchronization groups on the Host Rack PDU, type:

```
apc> oIGroups
Outlet Group Method: Enabled via Network
Outlet Group A:
159.215.6.141 Outlets: 2,4-7,9
159.215.6.143 Outlets: 2,7,8
Outlet Group B:
159.215.6.141 Outlets: 1
159.215.6.166 Outlets: 1
E000: Success
```

Example 2: To list outlet synchronization groups on guest Rack PDU 2, type:

```
apc> oIGroups 2:
Outlet Group Method: Local Only
Outlet Grp A:
RPDU Outlets: 3, 10-12, 16
Outlet Grp B:
RPDU Outlets: 13, 14 Outlet Grp C:
RPDU Outlets: 6, 7
```

```
Outlet Grp E:
RPDU Outlets: 23, 24
```

```
E000: Success
```

Example 3: To list outlet synchronization groups on guest Rack PDU 3, type:

```
apc> olGroups 3:
Outlet Group Method: Enabled via In/Out Ports Outlet Grp A:
RPDU1 Outlets: 3,9,24
RPDU2 Outlets: 3,10,11,16
RPDU4 Outlets: 3,8
Outlet Grp B:
RPDU1 Outlets: 5,8,13
RPDU4 Outlets: 5,6
Outlet Grp C:
RPDU1 Outlets: 10,11,19
E000: Success
```

Error Message: E000, E102, E104

olName

Access: Super User, Administrator, Device User, Read Only, and Outlet User, but only for outlets to which the user is assigned.

Description: Set or view the name assigned to an outlet. The id# may be from 1 to 32 depending on the group size.

Parameters: [<id#>:] <all | outlet#> [<newname>]

Argument	Definition
all	All device outlets.
<outlet#>	A single number or a range of numbers separated with a dash, or a comma-separated list of single outlet numbers and number ranges.
<newname>	The name for a specific outlet. Use only letters and numbers.

Example 1: To configure the name for outlet 3 to BobbysServer, type:

```
apc> olName 3 BobbysServer
E000: Success
```

Example 2: To view the names of outlets 3 through 5 on guest Rack PDU 2, type:

```
apc> olName 2:3-5
E000: Success
3: BobbysServer
4: Outlet 4
5: Outlet 5
```

Error Message: E000, E102, E104

o1Off

Access: Super User, Administrator, Device User, and Outlet User, but only for outlets to which the user is assigned.

Description: Turn off an outlet or group of outlets without any delay. The id# may be from 1 to 32 depending on the group size.

Parameters: [`<id#>:`] `<all | "outlet name" | outlet#>`

Example 1: To turn off outlets 3 and 5 through 7, type:

```
apc> o1Off 3,5-7
E000: Success
```

Example 2: To turn off outlets 1 through 3 on guest Rack PDU 2, type:

```
apc> o1Off 2:1-3
E000: Success
```

Error Message: E000, E102, E104

o1OffDelay

Access: Super User, Administrator, Device User, and Outlet User, but only for outlets to which the user is assigned.

Description: Set or view the time delay for the Off Delayed command and for a Reboot Delayed command. The id# may be from 1 to 32 depending on the group size.

Parameters: [`<id#>:`] `<all | "outlet name" | outlet#>` [`<time>`]

Argument	Definition
all	All device outlets.
<outlet name>	The name configured for a specific outlet.
<outlet#>	A single number or a range of numbers separated with a dash, or a comma-separated list of single outlet numbers and number ranges.
<time>	A time for the delay within the range of 1 to 7200 seconds (2 hours).

Example 1: To set a 9 second delay for turning off outlets 3 and 5 through 7, type:

```
apc> o1OffDelay 3,5-7 9
E000: Success
```

Example 2: To view the delay for the Off Delayed command for outlets 3 and 5 through 7, type:

```
apc> o1OffDelay 3,5-7
E000: Success
3: BobbysServer: 9 sec
5: BillysServer: 9 sec
6: JoesServer: 9 sec
7: JacksServer: 9 sec
```

Example 3: To set a 15 second delay for turning off outlets 2-4 on guest Rack PDU 2, type:

```
apc> o1OffDelay 2:2-4 15
E000: Success
```

Error Message: E000, E102, E104

olOn

Access: Super User, Administrator, Device User, and Outlet User, but only for outlets to which the user is assigned.

Description: Turn on an outlet or group of outlets without any delay. The id# may be from 1 to 32 depending on the group size.

Parameters: [`<id#>:`] `<all | "outlet name" | outlet#>`

Argument	Definition
all	All device outlets.
<outlet name>	The name configured for a specific outlet.
<outlet#>	A single number or a range of numbers separated with a dash, or a comma-separated list of single outlet numbers and number ranges.

Example 1: To turn on outlets 3 and 5 through 7, type:

```
apc> olOn 3,5-7
E000: Success
```

Example 2: To turn on outlets 3 and 5 through 7 on guest Rack PDU 3, type:

```
apc> olOn 3:3,5-7
E000: Success
```

Error Message: E000, E102, E104

olOnDelay

Access: Super User, Administrator, Device User, and Outlet User, but only for outlets to which the user is assigned.

Description: Set or view the time delay for the On Delayed command and for a Reboot Delayed command. The id# may be from 1 to 32 depending on the group size.

Parameters: [`<id#>:`] `<all | "outlet name" | outlet#>` [`<time>`]

Argument	Definition
all	All device outlets.
<outlet name>	The name configured for a specific outlet.
<outlet#>	A single number or a range of numbers separated with a dash, or a comma separated list of single outlet numbers and number ranges.
<time>	A time for the delay within the range of 1 to 7200 seconds (2 hours).

Example 1: To set a 6-second delay for turning on outlets 3 and 5 through 7, type:

```
apc> olOnDelay 3,5-7 6
E000: Success
```

Example 2: To view the delay for On Delayed command for outlets 3 and 5 through 7, type:

```
apc> olOnDelay 3,5-7
E000: Success
3: BobbyServer: 6 sec
5: BillyServer: 6 sec
6: JoesServer: 6 sec
7: JacksServer: 6 sec
```

Error Message: E000, E102, E104

olRbootTime

Access: Super User, Administrator, Device User, and Outlet User, but only for outlets to which the user is assigned.

Description: Set or view the amount of time an outlet will remain off for a Reboot Delayed command. The id# may be from 1 to 32 depending on the group size.

Parameters: [`<id#:>`] `<all | "outlet name" | outlet#>` [`<time>`]

Argument	Definition
all	All device outlets
<outlet name>	The name configured for a specific outlet.
<outlet#>	A single number or a range of numbers separated with a dash, or a comma separated list of single outlet numbers and number ranges.
<time>	A time for the delay within the range of 1 to 7200 seconds (2 hours).

Example 1: To view the time set for outlets 3 and 5 through 7, type:

```
apc> olRbootTime 3,5-7
E000: Success
3: BobbysServer: 4 sec
5: BillysServer: 5 sec
6: JoesServer: 7 sec
7: JacksServer: 2 sec
```

Example 2: To set the time for outlets 3 and 5 through 7 to remain off during a reboot, type:

```
apc> olRbootTime 3,5-7 10
E000: Success
3: BobbysServer: 10 sec
5: BillysServer: 10 sec
6: JoesServer: 10 sec
7: JacksServer: 10 sec
```

Error Message: E000, E102, E104

olStatus

Access: Super User, Administrator, Device User, and Read Only. Outlet Users also have access, but only for outlets to which the user is assigned.

Description: View the status of specified outlets. The id# may be from 1 to 32 depending on the size of the group.

Parameters: [`<id#>:`] `<all | "outlet name" | outlet#>`

Argument	Definition
all	All device outlets
<code><outlet name></code>	The name configured for a specific outlet.
<code><outlet#></code>	A single number or a range of numbers separated with a dash, or a comma-separated list of single outlet numbers and number ranges.

Example 1: To view the status for outlets 3 and 5 through 7, type:

```
apc> olStatus 3,5-7
E000: Success

3: BobbysServer:    On
5: BillysServer:   Off
6: JoesServer:     Off
7: JacksServer:    On
```

Example 2: To view the status for outlets 5 through 7 on guest Rack PDU 2, type:

```
apc> olStatus 2:5-7
E000: Success
5: Outlet 5: On
6: Outlet 6: On*
7: Outlet 7: On*
```

NOTE: A trailing * means that a control action is pending.

Error Message: E000, E102, E104

olUnasgnUsr

Access: Super User, Administrator

Description: Unassign outlets to a user that exists in the local database. Outlet permissions for RADIUS defined users can only be set at the RADIUS server. This command is only available to the administrator. If an outlet is specified that is not assigned to a user, no error is generated. The id# may be from 1 to 32 depending on the group size.

Parameters: [`<id#>:`] `<all | "outlet name" | outlet#>` `<user>`

Argument	Definition
all	All device outlets.
<code><outlet name></code>	The name configured for a specific outlet.
<code><outlet#></code>	A single number or a range of numbers separated with a dash, or a comma-separated list of single outlet numbers and number ranges.
<code><user></code>	A user that exists in the local database.

Example 1: To remove a user named Bobby from control of outlets 3, 5 through 7, and 10, type:

```
apc> olUnasgnUsr 3,5-7,10 Bobby
E000: Success
```

Example 2: To remove a user named Billy from control of all outlets, type:

```
apc> olUnasgnUsr all Billy
E000: Success
```

Error Message: E000, E102

phBal

Access: Super User, Administrator, Device User, Outlet User, Read Only

Description: Sets or reads the phase load balance threshold. Only applies to models with two or more metered phases. The id# may be from 1 to 32 depending on the group size.

Parameters: [`<id#>:`] [`<current>`] = The new phase threshold (Amps).

Example:

```
apc> phBal 13
E000: Success
```

```
apc> phBal
E000: Success
13A
```

Error Message: E000, E102

phBalAlGen

Access: Super User, Administrator, Device User, Outlet User, Read Only

Description: Sets or reads whether phase load balance alarms are enabled or disabled. Only applies to models with two or more metered phases. The id# may be from 1 to 32 depending on the group size.

Parameters: [`<id#>:`] [`<enable | disable>`]

enable = enable phase load balance alarms

disable = disable phase load balance alarms

Example:

```
apc> phBalAlGen enable E000: Success
apc> phBalAlGen disable E000: Success
```

Error Message: E000, E102

phLowLoad

Access: Super User, Administrator, Device User

Description: Set or view the phase low-load threshold in Amps. To specify phases, choose from the following options. Type: `all`, a single phase, a range, or a comma-separated list of phases. The `id#` may be from 1 to 32 depending on the group size.

Parameters: [`<id#>:`] `<all | phase#>` [`<current>`]

`phase#` = A single number or a range of numbers separated with a dash or a comma-separated list of single bank number and/or number ranges.

`current` = The new phase threshold (Amps).

Example 1: To set the low-load threshold for all phases to 1 A, type:

```
apc> phLowLoad all 1
```

```
E000: Success
```

Example 2: To view the low-load threshold for phases 1 through 3, type:

```
apc> phLowLoad 1-3
```

```
E000: Success
```

```
1: 1 A
```

```
2: 1 A
```

```
3: 1 A
```

Error Message: E000, E102

phNearOver

Access: Super User, Administrator, Device User

Description: Set or view the phase near-overload threshold in Amps. The `id#` may be from 1 to 32 depending on the group size.

Parameters: [`<id#>:`] `<all | phase#>` [`<current>`]

`phase#` = A single number or a range of numbers separated with a dash or a comma-separated list of single bank number and/or number ranges.

`current` = The new phase threshold (Amps).

Example 1: To set the near-overload threshold for all phases to 10 A, type:

```
apc> phNearOver all 10
```

```
E000: Success
```

Example 2: To view the near-overload threshold for phases 1 through 3, type:

```
apc> phNearOver 1-3
```

```
E000: Success
```

```
1: 10 A
```

```
2: 10 A
```

```
3: 10 A
```

Error Message: E000, E102

phOverLoad

Access: Super User, Administrator, Device User

Description: Set or view the phase overload threshold. The id# may be from 1 to 32 depending on the group size.

Parameters: [`<id#>:`] `<all | phase#>` [`<current>`]

`phase#` = A single number or a range of numbers separated with a dash or a comma-separated list of single bank number and/or number ranges.

`current` = The new phase threshold (Amps).

Example 1: To set the overload threshold for all phases to 13 A, type:

```
apc> phOverLoad all 13
```

```
E000: Success
```

Example 2: To view the overload threshold for phases 1 through 3, type:

```
apc> phOverLoad 1-3
```

```
E000: Success
```

```
1: 13 A
```

```
2: 13 A
```

```
3: 13 A
```

Error Message: E000, E102

phPeakCurr

Access: Super User, Administrator, Device User

Description: Display the peak current measurement from a phase(s). The id# may be from 1 to 32 depending on the group size.

Parameters: [`<id#>:`] `<all | phase#>`

`phase#` = A single number or a range of numbers separated with a dash or a comma-separated list of single bank number and/or number ranges.

Example:

```
apc> phPeakCurr 2
```

```
E000: Success
```

```
2: 0.0 A
```

```
apc> phPeakCurr all
```

```
E000: Success
```

```
1: 0.0 A
```

```
2: 0.0 A
```

```
3: 0.0 A
```

Error Message: E000, E102

phReading

Access: Super User, Administrator, Device User, Read Only

Description: View the current, voltage, or power for a phase. Set or view the phase near-overload threshold in kilowatts. You can specify all phases, a single phase, a range, or a comma-separated list of phases. The id# may be from 1 to 32 depending on the group size.

Parameters: [`<id#>:`] `< all | phase# >` `< current | voltage | power | appower | pf >`

Example 1: To view the measurement for current for phase 3, type:

```
apc> phReading 3 current
E000: Success
3: 4A
```

Example 2: To view the voltage for each phase, type:

```
apc> phReading all voltage
E000: Success
1: 120 V
2: 120 V
3: 120 V
```

Example 3: To view the power for phase 2 on guest Rack PDU 3, type:

```
apc> phReading 3:2 power
E000: Success
2: 40 W
```

Error Message: E000, E102

phRestrictn

Access: Super User, Administrator

Description: Set or view the overload restriction feature to prevent outlets from turning on when the overload alarm threshold is violated. Acceptable arguments are none, near, and over. To specify phases, choose from the following options. Type: all, a single phase, a range, or a comma-separated list of phases. The id# may be from 1 to 32 depending on the group size.

Parameters: [`<id#>:`] `< all | phase# >` [`<none | near | over>`]
 phase# = A single number or a range of numbers separated with a dash or a comma-separated list of single bank number and/or number ranges.

Example 1: To set the overload restriction for phase three to none, type:

```
apc> phRestrictn 3 none
E000: Success
```

Example 2: To view the overload restrictions for all phases, type:

```
apc> phRestrictn all
E000: Success
1: over
2: near
3: none
```

Error Message: E000, E102

phTophVolts

Access: Super User, Administrator, Device User, Outlet User, Read Only

Description: Read the phase-to-phase voltage on multi-phase devices. The id# may be from 1 to 32 depending on the group size.

Parameters: [`<id#>`:]

id# = The display identifier of the Rack Power Distribution Unit (RPDU) – normally 1.

However, in an NPS environment, the value will be 1 through number of NPS remotes.

Example:

```
apc> phTophVolts 1
E000: Success
1: L1-2 208 V
2: L2-3 208 V
3: L3-1 208 V
```

Error Message: E000, E102

prodInfo

Access: Super User, Administrator, Device User, Outlet User, Read Only

Description: View information about the Rack PDU. The id# may be from 1 to 32 depending on the group size.

Parameters: [`<id#>`: | all]

Example: To view the product information for this Rack PDU, type:

```
apc> prodInfo
E000: Success

RPDU ID:          1
AOS X.X.X
Switched Rack PDU XXXXXX
Model:           XXXXXX
Name:            room555Main
Location:        Room 555
Contact:         (xxx) 555-1234
Present Outlets: XX
Switched Outlets: XX
Metered Outlets: XX
Max Current:     XX
Phases:          XX
Banks:           X
Uptime:          0 Days 0 Hours 0 Minutes
NPS Type:        Host
NPS Status:      Active
Network Link:    Link Active
```

Error Message: E000

sensorName

Access: Super User, Administrator, Device User

Description: Set or view the name assigned to the Rack PDU Temp/Humidity port.

Parameters: [`<id#>:`] [`<newname>`]

Example 1: To set the name for the port to "Sensor1," type:

```
apc> sensorName Sensor1
```

```
E000: Success
```

Example 2: To then view the name for the sensor port, type:

```
apc> sensorName
```

```
E000: Success
```

```
Sensor1
```

Example 3: To set the name for the sensor port on guest Rack PDU 2 to "Sensor1," type:

```
apc> sensorName 2:Sensor1
```

```
E000: Success
```

Error Message: E000, E102

Temperature Sensor Note:

You must have installed an optional APC by Schneider Temperature Sensor (AP9335T) to your Rack PDU in order to use the Temperature related commands.

tempAlGen

Access: Super User, Administrator, Device User

Description: Sets or reads whether temperature alarms are enabled or disabled. The id# may be from 1 to 32 depending on the group size.

Parameters: [`<id#>:`] [`<enable | disable>`]

enable = enable temperature alarms.

disable = disable temperature alarms.

Example:

```
apc> tempAlGen enable
```

```
E000: Success
```

```
apc> tempAlGen disable
```

```
E000: Success
```

Error Message: E000, E102

tempHigh

Access: Super User, Administrator, Device User

Description: Set or view the high-temperature threshold in either Fahrenheit or Celsius. The id# may be from 1 to 32 depending on the group size.

Parameters: [`<id#>:`] `< F | C >` [`<temperature>`] = New high temperature threshold

Example 1: To set the high-temperature threshold to 70 ° Fahrenheit, type:

```
apc> tempHigh F 70
E000: Success
```

Example 2: To view the high-temperature threshold in Celsius, type:

```
apc> tempHigh C
E000: Success
21 C
```

Example 3: To view the high-temperature threshold of guest Rack PDU 2 in Fahrenheit, type:

```
apc> tempHigh 2:F
E000: Success
70 F
```

Error Message: E000, E102

tempHyst

Access: Super User, Administrator, Device User

Description: Set and displays the temperature threshold hysteresis. The id# may be from 1 to 32 depending on the group size.

Parameters: [`<id#>:`] `< F | C >` [`<temperature>`] = new temperature hysteresis value.

Example:

```
apc> tempHyst F 6
E000: Success
```

```
apc> tempHyst C
E000: Success
3 C
```

Error Message: E000, E102

tempMax

Access: Super User, Administrator, Device User

Description: Set or view the max-temperature threshold in either Fahrenheit or Celsius. The id# may be from 1 to 32 depending on the group size.

Parameters: [<id#>:] < F | C > [<temperature>] = new max temperature threshold.

Example 1: To set the max-temperature threshold to 80° Fahrenheit, type:

```
apc> tempMax F 80
E000: Success
```

Example 2: To view the max-temperature threshold in Celsius, type:

```
apc> tempMax C
E000: Success
27 C
```

Example 3: To view the max-temperature threshold of guest Rack PDU 3 in Fahrenheit, type:

```
apc> tempMax 3:F
E000: Success
95 F
```

Error Message: E000, E102

tempReading

Access: Super User, Administrator, Device User, Outlet User, Read Only

Description: View the temperature value in either Fahrenheit or Celsius from the sensor. The id# may be from 1 to 32 depending on the group size.

Parameters: [<id#>:] < F | C > = temperature

Example 1: To view the temperature value in Fahrenheit, type:

```
apc> tempReading F
E000: Success
51.1 F
```

Example 2: To view the temperature value of guest Rack PDU 3 in Celsius, type:

```
apc> tempReading 3:C
E000: Success
23.5 C
```

Error Message: E000, E102, E201

tempStatus

Access: Super User, Administrator, Device User, Read Only

Description: Displays the status of the sensor. The id# may be from 1 to 32 depending on the group size.

Parameters: [<id#>:]

Example: To view the status of the temperature sensor, type:

```
apc> tempStatus
Normal
```

Error Message: None

userAdd

Access: Super User, Administrator

Description: Add an outlet user to the local user database.

The password for the new user will be the same as the user name. To change the password of the user, use the `userPasswd` command.

Parameters: <user>

`user` = A user that does NOT exist in the local database.

Example: To add a user named Bobby, type:

```
apc> userAdd Bobby
```

```
E000: Success
```

Error Message: E000, E102, E202

userDelete

Access: Super User, Administrator

Description: Remove an outlet user from the local user database.

Parameters: <user>

`user` = A user that exists in the local database.

Example: To remove a user named Bobby, type:

```
apc> userDelete Bobby
```

```
E000: Success
```

Error Message: E000, E102, E202

userList

Access: Super User, Administrator, Device User, Read Only, and Outlet User, but only for outlets to which the user is assigned.

Description: List the users and the outlets assigned to them.

When used by the administrator, it lists the users in the local database and the outlet numbers assigned to them. When used by an outlet user, it lists only that user and their outlets. If the active user was authenticated via RADIUS, then the user and the outlet permissions are displayed based on logged user type.

When multiple Rack PDUs are connected via the In/Out ports, the outlets will be listed as:

```
<id> [<outlet list>];<id> [<outlet list>];<id> [<outlet list>];  
<id> [<outlet list>]
```

<id> is the display ID of the Rack PDU, and the list of owned outlets is contained within square brackets that follow. A semi-colon is used to delimit one Rack PDU device from the next.

Parameters: None

Example 1: When logged in as the Administrator, type:

```
apc> userList
```

```
E000: Success
```

Name	User Type	Status	Outlets
----	-----	-----	-----
apc	Super	*****	1-24
device	Device	Enabled	1-24
network	NetworkOnly	Enabled	1-24
dobby	Outlet	Enabled	1-24

Example 2: If outlet user 'dobby' is logged in:

```
apc> userList
```

E000: Success

Name	User Type	Status	Outlets
----	-----	-----	-----
dobby	Outlet	Enabled	1-12

Example 3: If a radius outlet user 'RadOutlet' is logged in:

apc> userList

E000: Success

Name	User Type	Status	Outlets
----	-----	-----	-----
RadOutlet	Outlet (Radius)	*****	1 [1, 3, 5]

Example 4: If a radius device user 'RadDevice' is logged in:

apc> userList

E000: Success

Name	User Type	Status	Outlets
----	-----	-----	-----
raddev	Device (Radius)	*****	1-24
readonly	ReadOnly	Enabled	1-24
network	NetworkOnly	Enabled	1-24
dobby	Outlet	Enabled	1-12

Example 5: If an Admin user is logged in, and multiple Rack PDUs are present on the In/Out ports:

apc> userList

E000: Success

Name	User Type	Status	Outlets
----	-----	-----	-----
apc	Super	*****	1 [1-24]; 2 [1-24]; 3 [1-24]; 4 [1-24]
administrator	Admin	Enabled	1 [1-24]; 2 [1-24]; 3 [1-24]; 4 [1-24]
device	Device	Enabled	1 [1-24]; 2 [1-24]; 3 [1-24]; 4 [1-24]
readonly	ReadOnly	Enabled	1 [1-24]; 2 [1-24]; 3 [1-24]; 4 [1-24]
network	NetworkOnly	Enabled	1 [1-24]; 2 [1-24]; 3 [1-24]; 4 [1-24]
dobby	Outlet	Enabled	1 [1]; 3 [3]; 4 [4]

Error Message: E000

userPasswd

Access: Super User, Administrator.

Description: Set an Outlet User Password. The administrator user can change passwords for all users.

Parameters: <user> <password1> <password2> = User name that will have its password changed. Password 2 is a confirmation and must be identical to password 1.

Example: To set doobby's password to "riddle" type:

```
apc> userPasswd doobby riddle riddle
```

```
E000: Success
```

Error Messages: E000, E102, E104

Web User Interface

Supported Web Browsers

You can use the latest version of Microsoft Edge®, Google Chrome®, Apple Safari®, or Mozilla Firefox® to access the Rack PDU through its Web UI. Other commonly available browsers and versions may work but have not been fully tested.

The Rack PDU cannot work with a proxy server. Before you can use a Web browser to access the Web UI of the Rack PDU, you must do one of the following:

- Configure the Web browser to disable the use of a proxy server for the Rack PDU.
- Configure the proxy server so that it does not proxy the specific IP address of the Rack PDU.

Log On to the Web User Interface

Overview

You can use the DNS name or System IP address of the Rack PDU for the URL address of the Web UI. Use your case-sensitive user name and password to log on.

The default user name and password for the **Super User** are both **apc**. For all other user types, there is no default user name or password. The **Super User** or an **Administrator** created by the **Super User**, must define the user name and password and other account characteristics for these users.

NOTE: If you are using HTTPS (SSL/TLS) as your access protocol, your login credentials are compared with information in a server certificate. If the certificate was created with the Security Wizard, and an IP address was specified as the common name in the certificate, you must use an IP address to log on to the Rack PDU. If a DNS name was specified as the common name on the certificate, you must use a DNS name to log on.

You may receive a message that the Web page is not secure. This is normal, and you can continue to the Web UI. The warning is generated because your Web browser does not recognize the default certificate used for encryption over HTTPS. However, information transmitted over HTTPS is still encrypted. See the *Security Handbook* on www.apc.com for more details on HTTPS and instructions to resolve the warning.

URL Address Formats

Type the DNS name or IP address of the Rack PDU in the Web browser's URL address field and press ENTER. Until HTTP is enabled, you must include https:// in the URL. When you specify a non-default Web server port in Internet Explorer, you must include http:// or https:// in the URL.

Common browser error messages at log-on:

Error Message	Browser	Cause of Error
"This page cannot be displayed."	Internet Explorer	Web access is disabled, or the URL was not correct.
"Unable to connect."	Firefox	

URL format examples:

NOTE: HTTP is disabled by default, and HTTPS is enabled by default.

- For a DNS name of Web1:
 http://Web1 if HTTP is your access mode
 https://Web1 if HTTPS (HTTP with SSL/TLS) is your access mode
- For a System IP address of 139.225.6.133 and the default Web server port (80):
 http://139.225.6.133 if HTTP is your access mode
 https://139.225.6.133:5000 if HTTPS (HTTP with SSL/TLS) is your access mode
- For a System IPv6 address of 2001:db8:1::2c0:b7ff:fe00:1100 and a non-default Web server port
 http://[2001:db8:1::2c0:b7ff:fe00:1100]:5000 if HTTP is your access mode

First Log On

When you log on to the NMC for the first time, you will be prompted to change the default Super User account password (**apc**). After you log in, you will be directed to the **Configuration Summary** screen. This screen is an overview of all system protocols, and their current values (e.g. enabled/disabled). You can access this screen at any time afterwards by following the path: **Configuration > Network > Summary**.

Limited Status Access

The RPDU Limited Status (**Configuration > Network > Web > Access**) page provides limited information, without requiring you to log on. Using a Web browser, access the RPDU's IP address to view the log on page. When enabled, there is a "Limited Status" hyperlink toward the lower right corner of the frame. Clicking on "Limited Status," instead of the regular user name / password fields, a limited summary of Device and System Information is made available to viewing. A "Log On" hyper link, as seen immediately above, allows for easy access to the standard Log In page.

Web User Interface Features

Read the following to familiarize yourself with basic Web UI features for your Rack PDU.



Tabs

The following tabs are available:

- **Home:** Appears when you log on. (This is the default tab when you log on. To change the login page to a different page, click on the green pushpin  at the top right side of the browser window while on the desired page.)
- **Status:** Gives the user the status of the Rack PDU and **Network**. The **RPDU** tab covers the status of alarms, groups, device, phase, bank, and environment. **Network** tab covers just the network.
- **Control:** The **Control** tab covers three topics: **RPDU**, **Security** and **Network**. Much more information is covered under each of these tabs and will be described in the **Control** tab section.
- **Configuration:** The **Configuration** tab covers **RPDU**, **Security**, **Network**, **Notification**, **General Configuration:** The **Configuration** tab covers **RPDU**, **Security**, **Network**, **Notification**, **General** the **Configuration** tab section.
- **Tests:** The **Tests** tab covers **RPDU** and **Network**. The **RPDU** tab covers LCD Blink and the **Network** tab covers LED Blink. Both will be further described later in the **Tests** section of the document.
- **Logs:** The **Logs** section covers: **Event**, **Data** and **Firewall**. The **Event** and **Data** tabs cover more information which will be further discussed later in the **Logs** section of the document.
- **About:** The **About** section covers **RPDU**, **Network**, and **Support** which will be further discussed later in the **About** section of the document.

Device Status Icons

One or more icons and accompanying text indicate the current operating status of the Rack PDU:

Symbol	Description
	Critical: A critical alarm exists, which requires immediate action.
	Warning: An alarm condition requires attention and could jeopardize your data or equipment if its cause is not addressed.
	No Alarms: No alarms are present, and the Rack PDU and NMC are operating normally.

At the upper right corner of every page, the Web UI displays the same icons currently displayed on the **Home** page to report Rack PDU status:

- The **No Alarms** icon if no alarms exist.
- One or both of the other icons (**Critical** and **Warning**) if any alarms exist, and after each icon, the number of active alarms of that severity.

Quick Links

At the lower left on each page of the interface, there are three configurable links. By default, the links access the URLs for these Web pages:

- **Link 1:** The home page of the APC by Schneider Electric website
- **Link 2:** Demonstrations of APC by Schneider Electric web-enabled products
- **Link 3:** Information on EcoStruxure IT

Located in the upper right hand corner of each page:

- User name (click to change user preferences)
- Language (if available, click to change language preference)
- Log Off (click to log the current user off of the Web UI)
- Help (click to view help contents)
- Click on the pushpin icon to set the current web page to be the log in home page. 

Example:

Log In Home: To make any screen the “home” screen (that is, the screen that displays first when you log on), go to that screen, and click the pushpin icon in the top right corner. 

Click this icon to revert to displaying the Home screen when you log on. 

Network Port Sharing (NPS) on the Web UI

The Web UI of the Rack ATS will have additional capabilities if the Rack ATS is part of an NPS group. This includes an NPS Group Status page (**Status > ATS > Group Status**) and an NPS Group Configuration page **Configuration > ATS > Group**. Additionally, for Web pages that support NPS features, you can view a different Rack ATS in the group by selecting the Display ID of that unit.

Each Rack ATS in the NPS group is denoted with a Rack ATS icon  followed by its Display ID (1 to 32). The Rack ATS that you are logged into is displayed with an additional asterisk (*) following the Display ID.

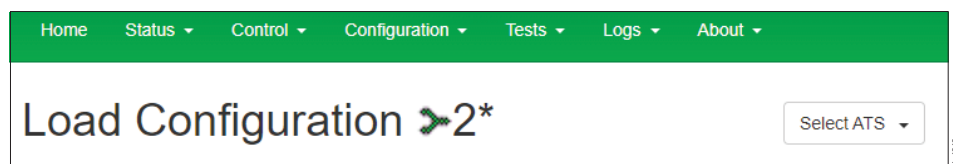

Group Control Using Network Port Sharing

The Web UI of the Rack PDU will have additional capabilities if the Rack PDU is part of an NPS group. This includes an NPS Group Status web page and an NPS Group Configuration page. In addition, for web pages that support NPS Rack PDUs, the user can select a different Rack PDU in the group to view by selecting the Rack PDU Display ID of the unit he or she would like to view.

Each Rack PDU in the NPS group is denoted with a Rack PDU icon followed by its Display ID (1 to 32). The Rack PDU that the user is logged into is displayed with an additional asterisk (*) following the Display ID. 

NOTE: The **Reset/Reboot** web page has many additional reset/reboot options for Rack PDU groups. These include individual Rack PDU reset to defaults, individual Rack PDU rebooting, and clearing of guest PDU lost communication alarms by removing the guests from the group.

About Home

The **Home** page contains the following information: Active Alarms, Load Status and Recent Device Events. Active Alarms will show if any alarms exist. If no alarms exist, a green check mark with the words **No Alarms Present** will show. The Load Status shows a colored bar demonstrating the level of the Bank, Phase and Device loads. To see the Device Status select the **More** link at the bottom of the list. The Recent Device Events box will list the five most recent device Events by the device by Date, Time and Event.

Overview

In the **Load Status** area, view the load for the device in kW and for the phases and banks in amps, as applicable. The green, yellow, and red meter shows the current load status: normal, near overload, or overload.

NOTE: If a low load threshold was configured the meter will also include a blue segment to the left of the green.

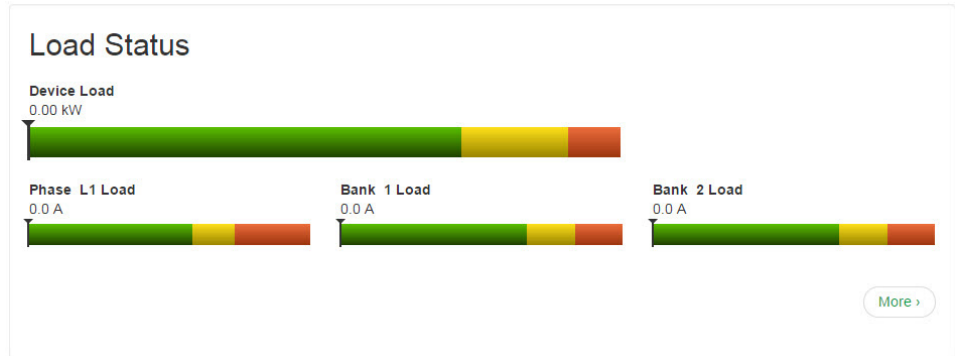

In the **Rack PDU Parameters** box the reader will find the Name, Location, Contact, Model Number, Rating, User (type of user account accessing the Rack PDU) and Uptime (the amount of time the Rack PDU has been operating since the last reboot from either a power cycle or a reboot of the Management Interface).

In the **Recent Device Events** box are the Events which have occurred most recently and the dates and times they occurred. A maximum of five Events are shown at one time. Click **More Events** to go to the **Logs** tab to view the entire event log.

Status Tab

About the Status Tab

Use the **Status** tab to:

- View the status for the Rack PDU device or the network
- Under the RPDU tab, users can access: Alarms, Device, Phase, Bank, Outlets and Environment
- Manage outlets
- Select Network to view the current IPv4 and IPv6 settings

View the Load Status and Peak Load

Path: Status > RPDU

Alarms: Lists Device Alarm Status.

Group: Network Port Sharing Group Status. List the Properties, Metering and firmware version information. **Change Host RPDU** can be accessed from its link at the bottom of the page.

Device: Shows status of device. Lists Status, Properties and Configuration information.

Phase: Shows Phase Status. Delta values for Phase Load Balance are displayed for models with two or more metered phases. The phase settings can also be configured via a **Configure Phase Settings** link at the bottom of the page. Configuration can be changed as well.

Bank: Shows bank status (only on units with this feature). List current size and demonstrates range on a colored red, green and yellow sliding bar. The bank settings can be changed via a **Configure Bank Status** link at the bottom of the page.

Outlet: Shows: Outlet Name, Phase, State and Outlet Load.

Switched Outlet: Choose from the following options:

- **Scheduling:** Shows scheduled outlet actions. You can also schedule outlet actions from this page.
- **Outlet Alarm Actions:** Shows outlet alarm actions. You can also configure alarm actions from this page.
- **Outlet Groups:** Shows outlet groups as either enabled or disabled. You can also configure groups from this page.

Environment: Shows Alarm Status, Temperature, Humidity and can configure Temperature and Humidity Configuration after pressing the Configure link.

View the Network Status

Path: Status > Network

The **Network** screen displays information about your network.

Current IPv4 Settings

System IP: The IP address of the unit.

Subnet Mask: The IP address of the sub-network.

Default Gateway: The IP address of the router used to connect to the network.

MAC Address: The MAC address of the unit.

Mode: How the IPv4 settings are assigned: **Manual**, **DHCP**, or **BOOTP**.

DHCP Server: The IP address of the DHCP server. This is only displayed if **Mode** is **DHCP**.

Lease Acquired: The date/time that the IP address was accepted from the DHCP server.

Lease Expires: The date/time that the IP address accepted from the DHCP server expires and will need to be renewed.

Current IPv6 Settings

Type: How the IPv6 settings are assigned.

IP Address: The IP address of the unit.

Prefix Length: The range of addresses for the sub-network.

Domain Name System Status

Active Primary DNS Server: The IP address of the primary DNS server.

Active Secondary DNS Server: The IP address of the secondary DNS server.

Active Host Name: The host name of the active DNS server.

Active Domain Name (IPv4/IPv6): The IPv4/IPv6 domain name that is currently in use.

Active Domain Name (IPv6): The IPv6 domain name that is currently in use.

Ethernet Port Speed

Current Speed: The current speed assigned to the Ethernet port.

Control

The **Control** menu options enable you to take immediate actions affecting active user management and the security of your network.

Controlling Device Outlets

Path: Control > RPDU > Outlet

Shows Outlet Control, Control Action, and Selected Outlets. Inside the Select Outlet box the screen will show the Outlet's Name, its State and its Phase.

NOTE: If you apply an outlet control action to outlets or outlet groups, the following delays are used for the action:

- For an individual outlet (not in an outlet group), the action uses the delay periods and reboot duration configured for that outlet.
- For a global outlet group, the action uses the delay periods and reboot duration configured for the global outlet.
- For a local outlet group, the action uses the delay periods configured for the lowest-numbered outlet in the group.

To Control the Outlets on Your Rack PDU

Mark the checkboxes for each individual outlet or outlet group to control, or select the **All Outlets** checkbox.

Select a **Control Action** from the list, and click **Next >>**. On the confirmation page that explains the action, choose to apply or cancel it.

Control Actions You Can Select

Option	Header
No Action	Do nothing
On Immediate	Apply power to the selected outlets
On Delayed	Apply power to each selected outlet according to its value for Power On Delay †
Off Immediate	Remove power from the selected outlets
Off Delayed	Remove power from each selected outlet according to its value for Power Off Delay †
Reboot Immediate	Remove power from each selected outlet. Then apply power to each of these outlets according to its value for Reboot Duration †
Reboot Delayed	Remove power from each selected outlet according to its value for Power Off Delay . Wait until all outlets are off (the highest value for Reboot Duration), and then apply power to each outlet according to its value for Power On Delay . †
Cancel Pending Commands	Cancel all commands pending for the selected outlets and keep them in the present state. NOTE: For global outlet groups, you can cancel a command only from the interface of the initiator outlet group. The action will cancel the command for the initiator outlet group and all follower outlet groups.
† If a local outlet group is selected, only the configured delays and reboot duration of the lowest-numbered outlet of the group are used. If a global outlet group is selected, only the configured delays and reboot duration of the global outlet are used.	

Managing User Sessions

Path: Control > Security > Session Management

The **Session Management** menu displays all active users currently connected to the RPDU. To view Information about a given user, click their user name. The **Session Details** screen displays basic information about the user including what interface they are logged-in to, their IP address, and user authentication. There is also an option to **Terminate Session** for the user.

Resetting the Network Interface

Path: Control > Network > Reset/Reboot

This menu gives you the option to reset and reboot various components of the network interface.

Users have the option to:

- **Reboot Management Interface** — restarts the Rack PDU's Network Management Interface. It does not affect the outlet ON/OFF status.
- **Reset all** — Clear the **Exclude TCP/IP** checkbox to reset all configuration values; mark the **Exclude TCP/IP** checkbox to reset all values except TCP/IP and EAPoL.

NOTE: Selecting **Reset all** will return all Network interfaces to their default settings. After logging in with the default login and password, (**apc**) you will be required to change your login and password.

- **Reset Only** — (Resetting may take up to a minute) Options include:
TCP/IP settings: Set the TCP/IP Configuration to **DHCP & BOOTP**, its default setting. This request requires that the Rack PDU receive its TCP/IP settings from a DHCP or BOOTP server. See "View the result of the test DNS in the Last Query Response field" on the web page. EAPoL is reset to disabled.

Event configuration: Reset all changes to event configuration, by event and by group, to their default settings.

Guest PDU: lost communication alarms by removing corresponding Guest PDUs.

Host Display ID: and Remove all Guest PDUs.

RPDU: to Defaults.

For NPS groups:

Guest PDU lost Communication alarms by removing corresponding Guest PDUs.

Host Display ID and remove all Guest PDUs Host to Defaults

Guest to Defaults

Guest Management Interface (Reboot)

Configuration

About the Configuration Tab

Under the Configuration tab, several menu options are available to make changes to the Rack PDUs:

- View the load status for the Rack PDU
- Manage and control outlets
- Configure a name and location for the Rack PDU
- View and manage the peak load measurement
- Click user-configurable links to open web pages for specific devices connected to the Rack PDU

Configure Load Thresholds

Path: Configuration > RPDU

View the load for the device, phases, banks, and outlets. The indicator in the green, yellow, and red meter shows the current load status: normal, near overload, or overload. If a low load threshold was configured, the meter will include a blue segment to the left of the green. When viewing the **Device Load**, the triangle above the meter indicates peak load.

NOTE: The Rack PDU generates an alarm when any bank exceeds its rated value. However, if a circuit breaker trips, there is no definitive indication that the circuit breaker is open, other than that the current for that bank will drop.

Set the Low Load Warning to 1 amp for these reasons:

- The default setting for the Low Load Warning is 0 amps. This effectively disables the warning. With a setting of 0 amps for the Low Load Warning, the Web UI will not indicate that a circuit breaker may have tripped.
- A 1 amp detection threshold for the Low Load Warning for Bank Load Management will help to indicate that a circuit breaker may have tripped.

To Configure Load Thresholds

1. To configure load thresholds for the device, phases, or banks, make a selection from the **Configuration > RPDU > Device** and **Phase** and **Bank** drop-down menu. To configure load thresholds for outlets, click **Configuration** and then click an outlet.
2. Set Overload Alarm, Near Overload Warning, and Low Load Warning thresholds.
3. Click **Apply** to save your settings.

Configure the Rack PDU Name and Location

Path: Configuration > RPDU > Device

The name and location you enter will appear on the **Home** tab.

1. Enter a name and location and contact.
2. Click **Apply** to save.

Set the Coldstart Delay for the Rack PDU

Path: Configuration > RPDU > Device

The Coldstart Delay is the number of seconds added to each outlet's Power On Delay before an outlet will turn on after power is applied to the Rack PDU. Allowed values are from 1 to 300 seconds, **Immediate**, or **Never** (never turn on).

1. Make a selection for **Coldstart Delay**.
2. Click **Apply**.

Reset Peak Load and kWh

Path: Configuration > RPDU > Device

1. Click the **Configuration** tab, then **RPDU**, then **Device**.
2. Click the **Peak Load** and **Kilowatt-Hours** checkboxes as desired.
3. Click **Apply**.

Set the Overload Outlet Restrictions

Parameters

Path: Configuration > RPDU > Phase and Bank

Prevent users from applying power to outlets during an overload condition. You can set the following restrictions for each phase and bank:

- **None:** Users can apply power to outlets regardless of an Overload Alarm or Near Overload Warning.
- **On Warning:** Users cannot apply power to an outlet on the selected phase or bank if the current for that phase or bank has exceeded the Near Overload Warning threshold.
- **On Overload:** Users cannot apply power to an outlet on the selected phase or bank if the current for that phase or bank has exceeded the Overload Alarm threshold.

To Set Overload Outlet Restrictions

1. Click the **Configuration** tab, then **RPDU**, then **Phase** or **Bank** from the menu.
2. Make selections for **Overload Outlet Restriction**.
3. Click **Apply**.

Configure Phase Load Balance

Path: Configuration > RPDU > Phase

The Phase Load Balance alarm is only available for units with two or more metered phases.

Specify a warning threshold (in Amps) between 0 and the maximum phase current rating, then select **Enable** under **Alarm Generation**. Once this feature is enabled, the RPDU will generate a Warning alarm if the phases are out of balance by more than the specified number of Amps.

Configure and Control Outlet Groups

Outlet Group Terminology

An *outlet group* consists of outlets that are logically linked together on the same Rack PDU. Outlets that are in an outlet group turn on, turn off, and reboot in a synchronized manner:

- A *local outlet group* consists of two or more outlets on a Rack PDU. Only the outlets in that group are synchronized.
- A *global outlet group* consists of one or more outlets on a Rack PDU. One outlet is configured as a *global outlet*, which logically links the outlet group to outlet groups on up to three other Rack PDUs. All outlets in the linked global outlet groups are synchronized.
 - For global outlet groups, the *initiator outlet group* is the group that issued the action.
 - For global outlet groups, a *follower outlet group* is any other outlet group that is synchronized with the initiator outlet group.

When you apply an outlet control action to outlets that are members of an outlet group, the outlets are synchronized as follows:

- For a global outlet group, use the delay periods and reboot duration configured for the global outlet of the initiator outlet group.
- For a local outlet group, the outlets use the delay periods and reboot duration of the lowest numbered outlet in the group.

Purpose and Benefits of Outlet Groups

By using groups of synchronized outlets on Rack PDUs, you can ensure that outlets turn on, turn off, and reboot in a synchronized manner. Synchronizing control group actions through outlet groups provides the following benefits:

- Synchronized shutdown and startup of the power supplies of dual-corded servers prevents erroneous reporting of power supply failures during a planned system shutdown or reboot.
- Synchronizing outlets by using outlet groups provides more precise shutdown and restart timing than relying on the delay periods of individual outlets.
- A global outlet is visible to the user interface of any Rack PDU to which it is linked.

System Requirements for Outlet Groups

To set up and use synchronized outlet control groups:

- You need a computer that can initiate synchronized control operations through the Web UI or CLI of the Rack PDUs or through SNMP.
- All of the Rack PDUs must use firmware that has the same version number for both APC by Schneider Electric's APC Operating System (AOS) module and the application module.
- All of the Rack PDUs must be configured with the same "Member Name".
- If you are using Network mode, you will also need the following items. These are not necessary if you are using Network Port Sharing mode over the In/Out ports.
 - You need a 10/100/1000 Base-T TCP/IP network, with an Ethernet hub or switch that has a power source not shared by the computers or other devices being synchronized.
 - All of the Rack PDUs must be on the same subnet.
 - Outlet groups you synchronize must have the same Multicast IP address, outlet group port, authentication phrase, and encryption phrase. Make sure each Ethernet switch that connects Rack PDUs allows Multicast network traffic for that Multicast IP address.

Rules for Configuring Outlet Groups

For a system that uses outlet groups, the following rules apply:

- A Rack PDU can have more than one outlet group, but an outlet can belong to only one outlet group.
- A local outlet group, which has no global outlet, must consist of two or more outlets.
- You can synchronize a global outlet group on one Rack PDU with a global outlet group on each of three other Rack PDUs.
 - In a global outlet group, you can designate only one outlet to be a global outlet, linking to outlet groups on other Rack PDUs for the purpose of synchronization. That global outlet can be the only outlet in its group, or the group can consist of multiple outlets.
 - A global outlet of one outlet group must have the same physical outlet number as the global outlet of any other outlet group to which it links.
- To create and configure outlet groups, you must use the Web UI or export configuration file (.ini file) settings from a configured Rack PDU. The Command Line Interface lets you display whether an outlet is a member of an outlet group and lets you apply control actions to an outlet group, but the Command Line Interface does not let you set up or configure an outlet group.

Enable Outlet Groups

Path: Configuration > RPDU > Switched Outlet > Outlet Groups

Configure the following parameters, and click **Apply**.

Enable creation of outlet groups:

Parameters	Description
Device Level Outlet Group	To create an outlet group, you must enable the desired group method. Choices are: Disabled, Local Only, Enabled via Network, and Enabled via In/Out Ports (Network Port Sharing).

Enable support for global outlet groups (linked groups):

Parameters	Description
Member Name	To link outlet groups on multiple Switched Rack PDUs, you must define the same Member name on each of the Rack PDUs. NOTE: A maximum of four devices can be configured with the same Member name.

Setting parameters for outlet groups using Network mode:

Parameters	Description
Multicast IP	To link outlet groups on multiple Switched Rack PDUs, you must define the same Multicast IP address on each of the Rack PDUs.
Authentication Phrase	A phrase of 15 to 32 ASCII characters that verifies that the device is communicating with other devices, that the message has not been changed during transmission, and that the message was communicated in a timely manner. The authentication phrase indicates that it was not delayed and that it was not copied and sent again later at an inappropriate time.
Encryption Phrase	A phrase of 15 to 32 ASCII characters that ensures the privacy of the data (by means of encryption).
Outlet Group Port	The port number on which the device will communicate with other devices. This must be the same on all Rack PDUs in a group.

NOTE: Devices attempting to synchronize with Outlet Groups on other devices using network mode must all have the same Authentication Phrase and Encryption Phrase. The values are hidden to the user.

Create a Local Outlet Group

Path: Configuration > RPDU > Switched Outlet > Outlet Groups

1. Make sure outlet groups are enabled.
2. Click **Create Local Outlet Group**.
3. Select the checkboxes of the outlets that will be in the group and assign the group a name in the **Outlet Group Name** field. You must select at least two outlets.

Create a Global Outlet Group

Path: Configuration > RPDU > Switched Outlet > Outlet Groups

To set up multiple global outlet groups that link to outlet groups on other Network Management Cards:

1. Make sure outlet groups are enabled.
2. Click on **Create Global Outlet Groups**.
3. Select the checkboxes of the outlets that will be in the group and then click **“Apply and Select Global Outlets”** to select the global outlet for the group. If there is only one outlet in the group, it will automatically be assigned as the global outlet.
4. To add outlets to any of the global outlet groups you created, see “Edit or delete an outlet group”.

Edit or Delete an Outlet Group

Path: Configuration > RPDU > Switched Outlet > Outlet Groups

1. In the **Configure Group** table, click on the number or name of the outlet group to edit or delete.
2. When editing an outlet group you can do any of the following:
 - Rename the outlet group.
 - Add or remove outlets by clicking the checkboxes to mark or unmark them.

NOTE: You cannot remove an outlet from an outlet group that contains only two outlets unless the remaining outlet is a global outlet.

3. To delete the outlet group, click **Delete Outlet Group**.

Typical Outlet Group Configurations

The following configuration shows two Rack PDUs, each with eight outlet groups. Each outlet group consists of a single global outlet. Each outlet group 1 on the first Rack PDU is linked to the outlet group 2 in the same location on the second Rack PDU. One power cord of a dual-corded server 3 is connected to each outlet on the first Rack PDU, and its other cord is connected to the corresponding outlet on the second Rack PDU, ensuring that output power from both power sources to the server will turn On or Off in a synchronized manner in response to an outlet control action.

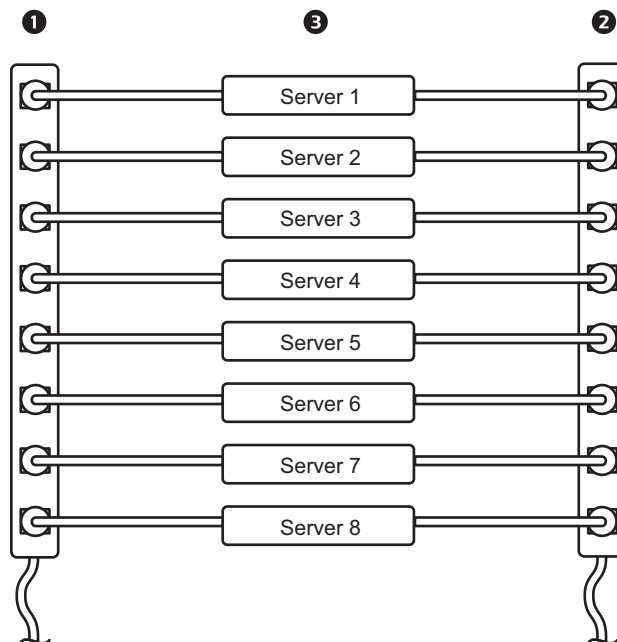

The following configuration shows three sets of synchronized outlets. Global outlets are shown in black. Outlet groups are enclosed in red rectangles.

1	These four global outlet groups synchronize a total of 19 outlets.
2	These two global outlet groups synchronize 6 outlets, 2 in one group and 4 in the other.
3	This local outlet group synchronizes 3 outlets on the same Rack PDU.

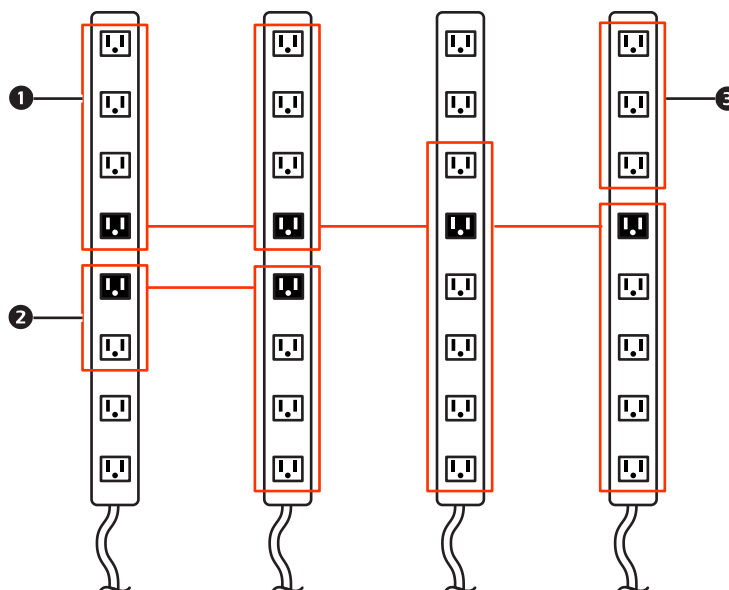

Verify Your Setup and Configuration for Global Outlet Groups

Path: Configuration > RPDU > Switched Outlet > Outlet Groups

To ensure that your setup meets all system requirements for outlet groups and that you have configured the outlet groups correctly, view the groups and their connections:

- The **Configure Group** table displays the following:
 - All configured outlet groups on the current Rack PDU.
 - The outlets in each group by outlet number.
 - Any outlet groups on other Rack PDUs with which a global outlet group is synchronized. Each Rack PDU is identified by its IP address if using network mode, or Display ID if using Network Port Sharing over In/Out ports. Each global outlet is displayed in bold text.
- The **Global Outlet Overview** section displays the following:
 - The IP address or Display ID of the current Rack PDU.
 - The IP address or Display ID of any Rack PDUs that contain global outlets that are available to be synchronized with outlet groups on other Rack PDUs.
 - All global outlets configured on the Rack PDUs, regardless of whether they are synchronized with outlet groups on the current Rack PDU.

Outlet Settings

Select from the options to control the outlets on your Rack PDU.

Path: Configuration > RPDU > Switched Outlet (or Outlet Groups)

Configure Outlet Settings and the Outlet Name

The following settings are available:

Setting	Description
Name	Set the name for one or more outlets. The name is displayed next to the outlet number on status screens.
External Link	Define an HTTP or HTTPS link to a web site or IP address. The external device web link can be set to the IP address of the external device plugged into the outlet (if applicable). Alternatively, it can be set to the device's manufacturer web page in order to more easily view user manuals, etc. Clicking the link on the Outlet Links page will open a new browser window to the link.
Power On Delay	Set the number of seconds that the Rack PDU waits after a command is issued before applying power to an outlet. NOTE: To configure an outlet to remain off at all times, select the Never radio button next to Power On Delay.
Power Off Delay	Set the number of seconds that the Rack PDU waits after a command is issued before removing power to an outlet. NOTE: To configure an outlet to remain on at all times, select the Never radio button next to Power Off Delay.
Reboot Duration	Set the number of seconds an outlet remains Off before restarting.

Path: Configuration > RPDU > Switched Outlet > Configuration

Click the **Configure Multiple Outlets** button in the **Outlet Configuration** section or click the outlet name.

- Configure outlet settings for multiple outlets:
 - Select the checkboxes next to the numbers of the outlets you want to modify, or select the **All Outlets** checkbox.
 - Enter values for **Name** and **Link**, and click the **Apply** button immediately below the list.
 - Enter values for **Power On Delay**, **Power Off Delay**, or **Reboot Duration**, and click the **Apply** button immediately below the list.
- Configure outlet settings for a single outlet:
 - Enter values for **Name** and **Link**, and click the **Apply** button immediately below the list.
 - Enter values for **Power On Delay**, **Power Off Delay**, or **Reboot Duration**, and click the **Apply** button immediately below the list.

Schedule Outlet Actions

Actions You Can Schedule

To configure values for **Power On Delay**, **Power Off Delay**, and **Reboot Duration** for each outlet. Although you must use the Web UI to schedule outlet actions, you can set these values in either the Web or Command Line Interfaces. For any outlets you select, you can schedule any of the actions listed in the following table to occur daily; at intervals of one, two, four, or eight weeks; or only once.

Option	Description
No Action	Do nothing
On Immediate	Apply power to the selected outlets
On Delayed	Apply power to each selected outlet according to its value for Power On Delay †
Off Immediate	Remove power from the selected outlets.
Off Delayed	Remove power from each selected outlet according to its value for Power Off Delay†
Reboot Immediate	Remove power from each selected outlet. Then apply power to each of these outlets according to its value for Reboot Duration . †
Reboot Delayed	Remove power from each selected outlet according to its value for Power Off Delay . Wait until all outlets are off (the highest value for Reboot Duration), and then apply power to each outlet according to its value for Power On Delay .†
† If a local outlet group is selected, only the configured delays and reboot duration of the lowest-numbered outlet of the group are used. If a global outlet group is selected, only the configured delays and reboot duration of the global outlet are used.	

Schedule An Outlet Event

Path: Configuration > RPDU > Switched Outlet > Scheduling

1. On the **Outlet Scheduling** page, select how often the event will occur (**One-Time**, **Daily**, or **Weekly**), and click the **Next** button.

NOTE: If you select **Weekly**, you can choose to have the event occur once every week or once every two, four, or eight weeks.

2. On the **Schedule a Daily Action** page, in the **Name of event** text box, replace the default name, `Outlet Event`, with a name that will identify your new event.
3. Use the drop-down lists to select the type of event and when it will occur. The date format for one-time events is *mm/dd*, and the time format for all events is *hh/mm*, with the two-digit hour specified in 24-hour time.
 - An event that is scheduled daily or at one of the intervals available in the **Weekly** selection continues to occur at the scheduled interval until the event is deleted or disabled.
 - You can schedule a one-time event to occur only on a date within 12 months of the date on which you perform the scheduling. For example, on March 26, 2020, you could schedule a one-time event on any date from the current date until March 26, 2021.
4. Use the checkboxes to select which outlets will be affected by the action. You can select one or more individual outlets or **All Outlets**.
5. Click **Apply** to confirm the scheduling of the event, or **Cancel** to clear it.

When you confirm the event, the summary page is re-displayed, with the new event displayed in the list of scheduled events.

Edit, Disable, Enable, or Delete a Scheduled Outlet Event

Path: Configuration > RPDU > Switched Outlet > Scheduling

1. In the event list in the **Scheduled Outlet Action** section of the **Scheduling** page, click on the name of the event.
2. On the **Daily/Weekly scheduled action detail** page, you can do any of the following:
 - Change details of the event, such as the name of the event, when it is scheduled to occur, and which outlets are affected.
 - Under **Status of event** at the top of the page you can perform the following tasks:
 - * Disable the event, leaving all its details configured so that it can be re-enabled later. A disabled event will not occur. An event is enabled by default when you create it.
 - * Enable the event, if it was previously set to **Disable**.
 - * Delete the event, removing the event completely from the system. A deleted event cannot be retrieved.

When you finish making changes on this page, click **Apply** to confirm the changes or **Cancel**.

Outlet User Manager

The Outlet User Management web page allows a user with administrative rights to view existing outlet user information and to add new users. Individual outlets can be assigned to each outlet user. When an outlet user logs into the Rack PDU, he or she will only be able to view or control outlets that have been assigned to the outlet user.

To modify an existing outlet user's assigned outlets, click on the outlet listing under the desired RPDU icon. To modify an existing outlet user's properties, click on the desired user name.

To create a new outlet user account, click the **Add User** button on the web page. This will take you to the new user configuration web page. Be sure to select **Outlet** in the **User Type** field. After filling out all of the fields, click **Next >>** to continue to the next page which allows you to select the desired outlets for the outlet user.

Configure an Outlet User

Path: Configuration > RPDU > Outlet User

1. Click the **Add New User** button.
2. Type in the information for the following options and click **Apply** to confirm the changes.

Option	Description
User Name	Set the outlet user name. "New User" is reserved and is not allowed. NOTE: A user name in orange indicates the user account has been disabled.
Password	Set the outlet user password.
User Description	Set identification/description of outlet user.
Account Status	Enable, disable, or delete outlet user's account.
Device outlet access	Select the outlets the user can access.

Outlet Manager and Network Port Sharing

Outlet users can be assigned outlets on any Rack PDU in a group with switched outlets. The outlet users will be stored on the Host PDU. In the Web UI, you can view outlets assigned to a particular PDU by clicking on its Display ID in the window.

Configure Temperature and Humidity Sensors

Path: Configuration > RPDU > Environment

NOTE: To use this feature, you must have installed an optional APC by Schneider Electric Temperature Sensor (AP9335T) or APC by Schneider Electric Temperature/Humidity Sensor (AP9335TH) to your Rack PDU.

For temperature:

- If the high temperature threshold is reached, the system generates a Warning alarm.
- If the maximum temperature threshold is reached, the system generates a Critical alarm.

Similarly, for humidity:

- If the low humidity threshold is reached, the system generates a Warning alarm.
- If the minimum humidity threshold is reached, the system generates a Critical alarm.

NOTE: Click the thermometer symbol in the upper right corner to toggle between Fahrenheit and Celsius.

To configure temperature and humidity sensors:

1. Enter values for minimum, maximum, high, and low thresholds.
2. Enter **Hysteresis** values.
3. Enable alarm generation as desired.
4. Click **Apply**.

Hysteresis: This value specifies how far past a threshold the temperature or humidity must return to clear a threshold violation.

- For Maximum and High temperature threshold violations, the clearing point is the threshold minus the hysteresis.
- For Minimum and Low humidity threshold violations, the clearing point is the threshold plus the hysteresis.

Increase the value for Temperature Hysteresis or Humidity Hysteresis to avoid multiple alarms if temperature or humidity that has caused a violation then wavers slightly up and down. If the hysteresis value is too low, such wavering can cause and clear a threshold violation repeatedly.

Example of rising but wavering temperature: The maximum temperature threshold is 85 °F, and the temperature hysteresis is 3 °F. The temperature rises above 85 °F, violating the threshold. It then wavers down to 84 °F and then up to 86 °F repeatedly, but no clearing event and no new violation occur. For the existing violation to clear, the temperature would have to drop to 82 °F (3 °F below the threshold).

Example of falling but wavering humidity: The minimum humidity threshold is 18%, and the humidity hysteresis is 8%. The humidity falls below 18%, violating the threshold. It then wavers up to 24% and down to 13% repeatedly, but no clearing event and no new violation occur. For the existing violation to clear, the humidity would have to rise to above 26% (8% past the threshold).

Security

Session Management Screen

Path: Configuration > Security > Session Management

Enabling **Allow Concurrent Logins** means that two or more users can log on at the same time. Each user has equal access and each interface (HTTP, FTP, telnet console, serial console (CLI), etc.) counts as a logged-in user.

Remote Authentication Override: The Rack PDU supports Radius storage of passwords on a server. However, if you enable this override, the Rack PDU will allow a local user to log on using the password for the Rack PDU that is stored locally on the Rack PDU. See also “Local Users” and “Remote Users authentication”.

Ping Response

Path: Configuration > Security > Ping Response

Select the Enable check box for **IPv4 Ping Response** to allow the Rack PDU to respond to network pings. Clear the check box to disable a Rack PDU response. This does not apply to IPv6.

Local Users

Use these menu options to view, and to set up access and individual preferences (like displayed date format), to the Rack PDU user interfaces. This applies to users as defined by their logon name.

Path: Configuration > Security > Local Users > Management

Setting user access: With this option an Administrator or Super User can list and configure the users allowed access to the Web UI. The Super User user account always has access to the Rack PDU.

Click on **Add User** to add a user. On the resulting **User Configuration** screen, you can add a user and withhold access by clearing the **Access** checkbox. User names and passwords are case-sensitive. The maximum length for both the name and password is 64 bytes, with less for multi-byte characters. You have to enter a password. Blank passwords (passwords with no characters) are not allowed.

NOTE: Values greater than 64 bytes in Name and Password might get truncated. To change an Administrator/Super User setting, you must enter all three password fields.

Use **Session Timeout** to configure the time (3 minutes by default) that the Web UI waits before logging off an inactive user. If you change this value, you must log off for the change to take effect.

NOTE: This timer continues to run if a user closes the browser window without first logging Off by clicking **Log Off** at the upper right. Because that user is still considered to be logged on, no user can log on until the time specified as **Minutes of Inactivity** expires. For example, with the default value for **Minutes of Inactivity**, if a user closes the browser window without logging off, no user can log on for 3 minutes.

Serial Remote Authentication Override: By selecting this option, you can bypass RADIUS by using the serial console (CLI) connection. This screen enables it for the selected user, but it must also be enabled globally to work, (through the “Session Management” screen).

Default settings: Determine the default values to populate in each of the fields when the Super User or Administrator-level account creates a new user. These values can be changed before the settings are applied to the system.

- Access: Put a check in the **Enable** box to allow access.
- User Type: Select the user type from the dropdown menu.
- User Description: Type the user Description in the box.
- Session Timeout: Select from 1 to 60 minutes.
- Bad Login Attempts: Set the number of failed login attempts the user can have. Select from 0 to 99 attempts. 0= unlimited.

User Preferences: This option is enabled by default.

- **Event Log Color Coding:** Mark the checkbox to enable color-coding of alarm text recorded in the event log. System event entries and configuration change entries do not change color.

Text Color	Alarm Severity
Red	Critical: A critical alarm exists, which requires immediate action.
Orange	Warning: An alarm condition requires attention and could jeopardize your data or equipment if its cause is not addressed.
Green	Alarm Cleared: The conditions that caused the alarm have improved.
Black	Normal: No alarms are present. The Rack PDU and all connected devices are operating normally.

- **Change the default temperature scale:** Select the temperature scale, **US Customary** (Fahrenheit) or **Metric** (Celsius), in which to display all temperature measurements in this user interface.
- **Export Log Format:** Configure which format the event log should be displayed in when exported (downloaded). Tab (default) allows fields to be tab-delimited whereas CSV is comma-separated.
- **Date Format:** Select the numerical format in which to display all dates in this user interface. In the selections, each letter m (for month), d (for day), and y (for year) represents one digit. Single-digit days and months are displayed with a leading zero.
- **Language:** Select the user interface display languages from the drop-down box.

Password Requirements:

- **Strong Passwords:** Configure whether new passwords created for user accounts will require additional rules such as at least one lowercase character, one uppercase character, one number, and one symbol.
- **Password Policy:** Select the duration (in days) to which the user will be required to change their password. A value of 0 days disables this feature (by default).

Remote Users

Authentication: Specify how you want users to be authenticated at logon.

Path: Configuration > Security > Remote Users > Authentication

For information about local authentication (not using the centralized authentication of a RADIUS server), see the *Security Handbook*, available at www.apc.com.

The authentication and authorization functions of RADIUS (Remote Authentication Dial-In User Service) is supported.

- When a user accesses the Network Management Card or other network-enabled device that has RADIUS enabled, an authentication request is sent to the RADIUS server to determine the User permission level.
- RADIUS user names used with the Rack PDU are limited to 32 characters.

Select one of the following:

- **Local Authentication Only:** RADIUS is disabled. Local authentication is enabled.
- **RADIUS, then Local Authentication:** RADIUS and local authentication are enabled. Authentication is requested from the RADIUS server first. If the RADIUS server fails to respond, local authentication is used.
- **RADIUS Only:** RADIUS is enabled. Local authentication is disabled.

NOTE: If **RADIUS Only** is selected, and the RADIUS server is unavailable, or improperly configured, remote access is unavailable to all users. You must use a serial connection to the Command Line Interface and change the **access** setting to **local** or **radiusLocal** to regain access.

For example, the command to change the access setting to **local** would be:
radius -a local

RADIUS:

Path: Configuration > Security > Remote Users > RADIUS

Use this option to do the following:

- List the RADIUS servers (a maximum of two) available to the Rack PDU and the time-out period for each.
- Click on a link, and configure the parameters for authentication by a new RADIUS server.
- Click a listed RADIUS server to display and modify its parameters.

RADIUS Setting	Definition
RADIUS Server	The server name or IP address (IPv4 or IPv6) of the RADIUS server. Click on a link to configure the server. NOTE: RADIUS servers use port 1812 by default to authenticate users. The Rack PDU supports ports 1812, 5000 to 32768.
Secret	The shared secret between the RADIUS server and the Network Management Card of the Rack PDU.
Reply Timeout	The time in seconds that the Rack PDU waits for a response from the RADIUS server.
Test Settings	Enter the Administrator user name and password to test the RADIUS server path that you have configured.
Skip Test and Apply	Do not test the RADIUS server path. (Not recommended)

Configure the RADIUS Server

Summary of the configuration procedure:

You must configure your RADIUS server to work with the Rack PDU.

For examples of the RADIUS users file with Vendor Specific Attributes (VSAs) and an example of an entry in the dictionary file on the RADIUS server, see the *Security Handbook*.

1. Add the IP address of the Rack PDU to the RADIUS server client list (file).
2. Users must be configured with Service-Type attributes unless Vendor Specific Attributes (VSAs) are defined. If no Service-Type attributes are configured, users will have read-only access (on the Web UI only).
See your RADIUS server documentation for information about the RADIUS users file, and see the *Security Handbook* for an example.
3. VSAs can be used instead of the Service-Type attributes provided by the RADIUS server. VSAs require a dictionary entry and a RADIUS users file. In the dictionary file, define the names for the ATTRIBUTE and VALUE keywords, but not for the numeric values. If you change numeric values, RADIUS authentication and authorization will fail. VSAs take precedence over standard RADIUS attributes.

Configuring a RADIUS server on UNIX® with shadow passwords:

If UNIX shadow password files are used (/etc/passwd) with the RADIUS dictionary files, the following two methods can be used to authenticate users:

- If all UNIX users have administrative privileges, add the following to the RADIUS “user” file. To allow only Device Users, change the APC-Service-Type to Device.

```
DEFAULT          Auth-Type = System
                  APC-Service-Type = Admin
```

- Add user names and attributes to the RADIUS “user” file, and verify the password against /etc/passwd. The following example is for users bconners and thawk:.

```
bconners         Auth-Type = System
                  APC-Service-Type = Admin

thawk            Auth-Type = System
                  APC-Service-Type = Device
```

Supported RADIUS Servers

FreeRADIUS v 1.x and v 2.x, Microsoft Server 2008 and 2012 Network Policy Server (NPS) are supported. Other commonly available RADIUS applications may work but have not been fully tested.

RADIUS and Network Port Sharing

NOTE: See the Security Handbook for more information on using RADIUS.

For RADIUS users file with VSAs, outlets on guest Rack PDUs can be associated to RADIUS users by using the method in the following example:

```
# give user access to outlets 1, 2, and 3 on unit 1,
# outlet 7 on 2, outlets 1 through 6
# on unit 3, and outlets 1,2,4 through 6,7 through 10,
# and 20 on unit 4
newOutletUser Auth-Type = Local, User-Password =
"newoutlets"
    APC-Service-Type = Outlet,
    APC-Outlets = "1[1,2,3];2[7];3[1-6];4[1,2,4-6,7-
10,20];"
```

Firewall Menus

Path: Configuration > Security > Firewall

Configuration: Enable or disable the firewall functionality. The configured policy is listed by default. Select the **Enable** checkbox to enable the firewall. The check box is un-checked by default.

- Click **Apply** to confirm a firewall policy you have selected to enable. The **Firewall Confirmation** page will open.
 - The Confirmation page contains a recommendation to test the firewall before enabling. It is not mandatory.
 - The first hyperlink goes to the Firewall Policy page.
 - The second hyperlink goes to the Firewall Test page.
 - Click **Apply** to enable the firewall and return to the Configuration page.
 - Click **Cancel** to return to the Configuration page without enabling the Firewall.
- Click **Cancel**: No new selection will be enabled. You stay on the Configuration page.

Active Policy: Select an active policy from the Available Policies drop-down list, and view the validity of that policy. The current active policy is displayed by default; you can select another from the list.

- Click **Apply** to enable your changes. If a different firewall was selected and enabled, the change is effective immediately. If a newly configured firewall policy has been selected, it is recommended that you test the new firewall before enabling it.

Click **Cancel** to restore the original active policy and stay on the Active Policy page.

Active Rules: When a firewall is enabled, this read-only page lists the individual rules that are being enforced by a current active policy. See the **Create/Edit Policy** section for descriptions of the fields (Priority, Destination, Source, Protocol, Action, and Log).

Create/Edit Policy: Create a new policy; delete or edit an existing policy:

NOTE: While deleting an active enabled firewall policy cannot be done, editing a running policy can be done but is not recommended as changes are applied immediately. Instead, disable the firewall, edit the policy, test it, and then re-enable the policy.

Create a new policy: Click **Add Policy**, and type in the file name for the new firewall file. The filename should have a .fwl file extension. If left without a file extension, .fwl will be appended to the name automatically.

- Click **Apply**: If the filename is legal, the empty file firewall policy file will be created. It will be located in the /fwl folder with the other policies on the system.
- Click **Cancel** to return to the previous page without creating a new firewall file.

Edit an existing policy: Select **Edit Policy** to go to the edit page. You can edit an firewall policy which is not active.

Warning page: If you attempt to edit the active enabled policy, a warning page will open:

“Editing the active firewall policy will cause all changes made to be applied immediately. It is recommended to disable the firewall and test the policy before enabling it.”

- Click **Apply** to leave the Warning page and return to the Edit Policy page
- Click **Cancel** to leave the Warning page and return to the Create/Edit Policy page

To edit an existing policy:

1. Select the policy you want to edit from the **Policy Name** drop-down list and click **Edit Policy**.
2. Click **Add Rule** or select the **Priority** of an existing rule to go to the **Edit Rule** page. From this page, you can change the rule settings or delete the selected rule.

Setting	Description
Priority	If 2 rules conflict, the rule with the higher priority will determine what happens. The highest priority is 1; the lowest is 250.
Type	host: In the IP/any field, you will enter a single IP address subnet: In the IP/any field, you will enter a subnet address range: In the IP/any field, you will enter a range of IP addresses
IP/any	Specify the IP address or range of addresses this rule applies to, or select one of the following: <ul style="list-style-type: none"> • any: The rule applies regardless of the IP address • anyip4: The rule applies for any IPv4 address. • anyip6: The rule applies for any IPv6 address.
Port	Specify a port the rule will apply to. <ul style="list-style-type: none"> • None: The rule will apply to any port • Common Configured ports: Select a standard port • Other: Specify a non-standard port number
Protocol	Specify the protocol to which the rule applies <ul style="list-style-type: none"> • any: any protocol • tcp: used for reliable information transfer between applications • udp: alternative to TCP using for faster, lower bandwidth information transfer. Though it has fewer delays, UDP is less reliable than TCP. • icmp: used to report errors for troubleshooting • icmpv6: used to report errors for troubleshooting on applications using IPv6
Action	allow: Allow the packet that matches this rule discard: Discard the packet that matches this rule
Log	If this rule is applied to a packet, regardless of whether the packet is blocked or allowed, this will add an entry to the Firewall Log.

It is recommended that you add one of the following as the lowest priority rule in your firewall policy:

- To use the firewall as a white list, add
250 Dest any / Source any / protocol any / discard
- To use the firewall as a black list, add
250 Dest any / Source any / protocol any / allow

Delete a policy: Select **Delete Policy** to open the Confirm Deletion page. Click **Apply** to confirm and the selected firewall file is removed from the file system.

Load Policy: Upload a policy (with the .fwl suffix) from a source external to this device.

Test: Temporarily enforce the rules of a chosen policy for a time that you specify.

802.1X Security Configuration

Path: Configuration > Security > 802.1X Security

The NMC takes the role of a supplicant in an EAPoL (Extensible Authentication Protocol over LAN) architecture used in IEEE 802.1X port-based network access control. The NMC supports EAP-TLS as an authentication method which requires the user to upload 3 client-side certificates. The private key is stored in an encrypted format. The user needs to provide a valid passphrase to be able to enable 802.1X security access.

NOTE: The NMC supports only EAP-TLS authentication method.

The Web UI offers the following options for EAPoL configuration:

Setting	Description
EAPoL Access	Used to enable or disable 802.1X Security Access. NOTE: The 802.1X security access is disabled by default. The user can enable only when valid certificates and a valid passphrase for the private key are provided by the user.
Supplicant Identifier	Allows the users to set their own supplicant identifier (up to 32 characters including whitespace). NOTE: By default, the supplicant identifier is set to "NMC-Supplicant-xx:xx:xx:xx:xx:xx" where six octets of 'xx' are the MAC ID of the NMC.
CA Certificate	Upload/replace or remove a CA root certificate. The supported file formats are PEM (Privacy Enhanced Mail) or the DER (Distinguished Encoding Rules) format with permitted file extensions .pem, .PEM, .der, or .DER.
Private Key Certificate	Upload/replace or remove an encrypted private key. The supported file formats are PEM (Privacy Enhanced Mail) or the DER (Distinguished Encoding Rules) format with permitted file extensions .key or .KEY. NOTE: Unencrypted private key is not accepted.
Private Key Passphrase	Provide the passphrase to decrypt the encrypted private key. Allows up to 64 characters including whitespace.
User/Public Certificate	Upload/replace or remove a user/public certificate. The supported file formats are PEM (Privacy Enhanced Mail) or the DER (Distinguished Encoding Rules) format with permitted file extensions .pem, .PEM, .der, or .DER.

Network Features

Protocol Configuration Summary

Path: Configuration > Network > Summary

You can use this page to view all protocols enabled or disabled on your Rack PDU. Select a link for any protocol to go to the appropriate configuration page.

TCP/IP and Communications Settings

TCP/IP:

Path: Configuration > Network > TCP/IP

The TCP/IP option on the left navigation menu, selected by default when you choose Network on the top menu bar, displays the current IPv4 address, subnet mask, default gateway, MAC address, and boot mode of the Rack PDU. For information on DHCP options, see **RFC2131** and **RFC2132** online.

Setting	Description
Enable	Enable or disable IPv4 with this check box.
Manual	Configure IPv4 manually by entering the IP address, subnet mask, and default gateway.
BOOTP	<p>A BOOTP server provides the TCP/IP settings. At 32-second intervals, the Rack PDU requests network assignment from any BOOTP server:</p> <ul style="list-style-type: none"> If the Rack PDU receives a valid response, it starts the network services. If the Rack PDU finds a BOOTP server, but a request to that server fails or times out, the Rack PDU stops requesting network settings until it is restarted. By default, if previously configured network settings exist, and the Rack PDU receives no valid response to five requests (the original and four retries), it uses the previously configured settings so that it remains accessible. <p>Click Next>> to access the BOOTP Configuration page to change the number of retries or the action to take if all retries fail:¹</p> <ul style="list-style-type: none"> Maximum retries: Enter the number of retries that will occur when no valid response is received, or zero (0) for an unlimited number of retries. If retries fail: Select Use prior settings (the default) or Stop BOOTP request.
DHCP	<p>The default setting. At 32-second intervals, the Rack PDU requests network assignment from any DHCP server.</p> <ul style="list-style-type: none"> If the Rack PDU receives a valid response, it does not (as previously) require the APC cookie from the DHCP server in order to accept the lease and start the network services. If the Rack PDU finds a DHCP server, but the request to that server fails or times out, it stops requesting network settings until it is restarted.¹ Require vendor specific cookie to accept DHCP Address: By selecting this check box, you can require the DHCP server to provide a cookie which supplies information to the Rack PDU.
<p>¹ The default values for these three settings on the configuration pages generally do not need to be changed:</p> <ul style="list-style-type: none"> Vendor Class: APC Client ID: The MAC address of the NMC of the Rack PDU, which uniquely identifies it on the local area network (LAN) User Class: The name of the application firmware module 	

DHCP response options:

Each valid DHCP response contains options that provide the TCP/IP settings that the Rack PDU needs to operate on a network, and other information that affects the operation of the Rack PDU.

Vendor Specific Information (option 43): The Rack PDU uses this option in a DHCP response to determine whether the DHCP response is valid. This option contains an APC-specific option in a TAG/LEN/ DATA format, called the APC Cookie. This is disabled by default.

- **APC Cookie. Tag 1, Len 4, Data “1APC”**

Option 43 communicates to the Rack PDU that a DHCP server is configured to service devices.

Following, in hexadecimal format, is an example of a Vendor Specific Information option that contains the APC cookie:

```
Option 43 = 0x01 0x04 0x31 0x41 0x50 0x43
```

TCP/IP options:

The Rack PDU uses the following options within a valid DHCP response to define its TCP/IP settings. All of these options except the first are described in RFC2132.

- **IP Address** (from the **yiaddr** field of the DHCP response, described in RFC2131): The IP address that the DHCP server is leasing to the Rack PDU.
- **Subnet Mask (option 1):**The Subnet Mask value that the Rack PDU needs to operate on the network.
- **Router, i.e., Default Gateway (option 3):** The default gateway address that the Rack PDU needs to operate the network.
- **IP Address Lease Time (option 51):** The time duration for the lease of the IP Address to the Rack PDU.
- **Renewal Time, T1 (option 58):** The time that the Rack PDU must wait after an IP address lease is assigned before it can request a renewal of that lease.
- **Rebinding Time, T2 (option 59):** The time that the Rack PDU must wait after an IP address lease is assigned before it can seek to rebind that lease.

Other options:

The Rack PDU also uses these options within a valid DHCP response. All of these options except the last are described in **RFC2132**.

- **Network Time Protocol Servers (option 42):** Up to two NTP servers (primary and secondary) that the Rack PDU can use.
- **Time Offset (option 2):** The offset of the Rack PDU's subnet, in seconds, from Coordinated Universal Time (UTC).
- **Domain Name Server (option 6):** Up to two Domain Name System (DNS) servers (primary and secondary) that the Rack PDU can use.
- **Host Name (option 12):** The host name that the Rack PDU will use (32-character maximum length).
- **Domain Name (option 15):** The domain name that the Rack PDU will use (64-character maximum length).
- **Boot File Name** (from the **file** field of the DHCP response, described in **RFC2131**): The fully qualified directory-path to a user configuration file (.ini file) to download. The **siaddr** field of the DHCP response specifies the IP address of the server from which the device will download the .ini file. After the download, the .ini file is used as a boot file to reconfigure the settings.

Path: Configuration > Network > TCP/IP > IPv6 settings

Setting	Description
Enable	Enable or disable IPv6 with this check box.
Manual	Configure IPv6 manually by entering the IP address and the default gateway.

Auto Configuration	When the Auto Configuration check box is selected, the system obtains addressing prefixes from the router (if available). It uses those prefixes to automatically configure IPv6 addresses.
DHCPv6 Mode	<p>Router Controlled: Selecting this option means that DHCPv6 is controlled by the Managed(M) and Other(O) flags received in IPv6 router advertisements. When a router advertisement is received, the Rack PDU checks whether the M or the O flag is set. The Rack PDU interprets the state of the M (Managed Address Configuration Flag) and O (Other Stateful Configuration Flag) “bits” for the following cases:</p> <ul style="list-style-type: none"> • <i>Neither is set:</i> Indicates the local network has no DHCPv6 infrastructure. The Rack PDU uses router advertisements and manual configuration to get addresses that are not link-local and other settings. • <i>M, or M and O are set:</i> In this situation, full DHCPv6 address configuration occurs. DHCPv6 is used to obtain addresses AND other configuration settings. This is known as <code>DHCPv6 stateful</code>. Once the M flag has been received, the DHCPv6 address configuration stays in effect until the interface in question has been closed. This is true even if subsequent router advertisement packets are received in which the M flag is not set. If an O flag is received first, then an M flag is received subsequently, the Rack PDU performs full address configuration upon receipt of the M flag. • <i>Only O is set:</i> In this situation, the Rack PDU sends a DHCPv6 Info-Request packet. DHCPv6 will be used to configure “other” settings (such as location of DNS servers), but NOT to provide addresses. This is known as <code>DHCPv6 stateless</code>. <p>Address and Other Information: With this radio box selected, DHCPv6 is used to obtain addresses AND other configuration settings. This is known as <code>DHCPv6 stateful</code>.</p> <p>Non-Address Information Only: With this radio box selected, DHCPv6 will be used to configure “other” settings (such as location of DNS servers), but NOT to provide addresses. This is known as <code>DHCPv6 stateless</code>.</p> <p>Never: Select this to disable DHCPv6.</p>

Port Speed

Path: Configuration > Network > Port Speed

The **Port Speed** setting defines the communication speed of the TCP/IP port.

- For **Auto-negotiation** (the default), Ethernet devices negotiate to transmit at the highest possible speed, but if the supported speeds of two devices are unmatched, the slower speed is used.
- Alternatively, you can choose 10 Mbps or 100 Mbps, each with the option of half-duplex (communication in only one direction at a time) or full-duplex (communication in both directions on the same channel simultaneously).

DNS

Configuration:

Path: Configuration > Network > DNS > Configuration

Use the options under **Configuration** to configure and test the Domain Name System (DNS):

- **Override Manual DNS Settings:** Selection of Override Manual DNS Settings will result in configuration data from other sources (typically DHCP) taking precedence over the manual configurations set here.
- Select **Primary DNS Server** or **Secondary DNS Server** to specify the IPv4 or IPv6 addresses of the primary and optional secondary DNS server. For the Rack PDU to send email, you must at least define the IP address of the primary DNS server.
 - The Rack PDU waits up to 15 seconds for a response from the primary DNS server or secondary DNS server (if specified). If the Rack PDU does not receive a response within that time, email cannot be sent. Use DNS servers on the same segment as the Rack PDU or on a nearby segment (but not across a wide-area network [WAN]).
 - Define the IP addresses of the DNS servers then enter the DNS name of a computer on your network to look up the IP address for that computer to verify correct operation.
- **System Name Synchronization:** Allow the system name to be synchronized with the host name so both fields automatically contain the same value.
 - NOTE:** When enabling this feature, the system name identifier can no longer contain a space character (since it will be synchronized to the host name field).
- **Host Name:** Configure a host name here and a domain name in the **Domain Name** field then users can enter a host name in any field in the Rack PDU interface (except email addresses) that accepts a domain name.
- **Domain Name (IPv4/IPv6):** Configure the domain name here only. In all other fields in the Rack PDU interface (except email addresses) that accept domain names, the Rack PDU adds this domain name when only a host name is entered.
 - To override all instances of the expansion of a specified host name by the addition of the domain name, set the domain name field to its default, `somedomain.com`, or to `0.0.0.0`.
 - To override the expansion of a specific host name entry, include a trailing period. The Rack PDU recognizes a host name with a trailing period (such as `mySnmpServer.`) as if it were a fully-qualified domain name and does not append the domain name.
- **Domain Name (IPv6):** Specify the IPv6 domain name here.

Test:

Path: Configuration > Network > DNS > Test

Use this option to send a DNS query that tests the setup of your DNS servers by looking up the IP address. View the result of a test in the **Last Query Response** field.

- Select **test** to send a DNS query that tests the setup of your DNS servers:
 - As **Query Question**, identify the value to be used for the selected query type:

Query Type Selected	Query Question to Use
by Host	The URL
by FQDN	The fully qualified domain name, <code>my_server.my_domain</code>
by IP	The IP address
by MX	The Mail Exchange address

Web

Path: Configuration > Network > Web

Option	Description
access	<p>To activate changes to any of these selections, log off from the Rack PDU:</p> <ul style="list-style-type: none"> • Disable: Disables access to the Web UI. (To re-enable access, log in to the Command Line Interface, then type the command <code>http -S enable</code>. For HTTPS access, type <code>https -S enable</code>.) • Enable HTTP: Enables Hypertext Transfer Protocol (HTTP), which provides Web access by user name and password, but does not encrypt user names, passwords, and data during transmission. HTTP is disabled by default. • Enable HTTPS: Enables Hypertext Transfer Protocol (HTTPS) over Secure Sockets Layer/Transport Layer Security (SSL/TLS). SSL/TLS encrypts user names, passwords, and data during transmission, and authenticates the Rack PDU by digital certificate. When HTTPS is enabled, your browser displays a small lock icon. HTTPS is enabled by default. <p>See "Creating and Installing Digital Certificates" in the <i>Security Handbook</i>, available at www.apc.com.</p> <p>HTTP Port: The TCP/IP port (80 by default) used to communicate by HTTP with the Rack PDU.</p> <p>HTTPS Port: The TCP/IP port (443 by default) used to communicate by HTTPS with the Rack PDU.</p> <p>For either of these ports, you can change the port setting to any unused port from 5000 to 32768 for additional security. Users must then use a colon (:) in the address field of the browser to specify the port number. For example, for a port number of 5000 and an IP address of 152.214.12.114:</p> <pre>http://152.214.12.114:5000 https://152.214.12.114:5000</pre> <p>Minimum Protocol: Choose from the drop down menu - SSL 3.0, TLS 1.0, TLS 1.1, or TLS 1.2</p> <p>Require Authentication Cookie: Click to put a check the Enable box.</p> <p>Limited Status Access: Click to put a check in the box before Enable or Use as a default page.</p>
ssl certificate	<p>Add, replace, or remove a security certificate.</p> <p>Status:</p> <ul style="list-style-type: none"> • Not installed: A certificate is not installed, or was installed by FTP or SCP to an incorrect location. Using Add or Replace Certificate File installs the certificate to the correct location, <code>/ssl</code> on the Rack PDU. • Generating: The Rack PDU is generating a certificate because no valid certificate was found. • Loading: A certificate is being activated on the Rack PDU. • Valid certificate: A valid certificate was installed or was generated by the Rack PDU. Click on this link to view the contents of the certificate. <p>If you install an invalid certificate, or if no certificate is loaded when you enable SSL/TLS, the Rack PDU generates a default certificate, a process which delays access to the interface for up to one minute. You can use the default certificate for basic encryption-based security, but a security alert message displays whenever you log on.</p> <p>Add or Replace Certificate File: Enter or browse to the certificate file created with the Security Wizard.</p> <p>See "Creating and Installing Digital Certificates" in the <i>Security Handbook</i>, available at www.apc.com, to choose a method for using digital certificates created by the Security Wizard or generated by the Rack PDU.</p> <p>Remove: Delete the current certificate.</p>

Console

Path: Configuration > Network > Console > *options*

Option	Description
access	<ul style="list-style-type: none"> • Disable: Disables all access to the Command Line Interface. • Disable: Disables all access to the Command Line Interface. Telnet is disabled by default. • Enable SSH: SSH transmits user names, passwords, and data in encrypted form, providing protection from attempts to intercept, forge, or alter data during transmission. SSH is enabled by default. <p>Configure the ports to be used by these protocols:</p> <ul style="list-style-type: none"> • Telnet Port: The Telnet port used to communicate with the Rack PDU (23 by default). You can change the port setting to any unused port from 5000 to 32768 for additional security. Users must then use a colon (:) or a space, as required by your Telnet client program, to specify the non-default port. For example, for port 5000 and an IP address of 152.214.12.114, your Telnet client requires one of these commands: <pre>telnet 152.214.12.114:5000 telnet 152.214.12.114 5000</pre> • SSH Port: The SSH port used to communicate with the Rack PDU (22 by default). You can change the port setting to any unused port from 5000 to 32768 for additional security. See the documentation for your SSH client for the command line format required to specify a non-default port.
ssh host key	<p>Status indicates the status of the host key (private key):</p> <ul style="list-style-type: none"> • SSH Disabled, No host key in use: When disabled, SSH cannot use a host key. • Generating: The Rack PDU is creating a host key because no valid host key was found. • Loading: A host key is being activated on the Rack PDU. • Valid: One of the following valid host keys is in the <code>/ssh</code> directory (the required location on the Rack PDU): <ul style="list-style-type: none"> — A 1024-bit or 2048-bit host key created by the Security Wizard — A 2048-bit RSA host key generated by the Rack PDU <p>Add or Replace: Browse to and upload a host key file created by the Security Wizard. To use the Security Wizard, see the <i>Security Handbook</i>, available at www.apc.com</p> <p>NOTE: To reduce the time required to enable SSH, create and upload a host key in advance. If you enable SSH with no host key loaded, the Rack PDU takes up to one minute to create a host key, and the SSH server is not accessible during that time.</p> <p>Remove: Remove the current host key.</p>

NOTE: To use SSH, you must have an SSH client installed. Most Linux and other UNIX platforms include an SSH client, but Microsoft Windows operating systems do not. Clients are available from various vendors.

SNMP

All user names, passwords, and community names for SNMP are transferred over the network as plain text. If your network requires the high security of encryption, disable SNMP access or set the access for each community to Read. (A community with Read access can receive status information and use SNMP traps.)

When using StruxureWare Data Center Expert to manage a Rack PDU on the public network, you must have SNMP enabled in the Rack PDU interface. Read access will allow the StruxureWare Data Center Expert to receive traps from the Rack PDU, but Write access is required while you use the interface of the Rack PDU to set the StruxureWare Data Center Expert as a trap receiver.

For detailed information on enhancing and managing the security of your system, see the *Security Handbook*, available at www.apc.com.

Network Port Sharing

All Rack PDUs in a group can be accessed through the Host Rack PDU via SNMP “rPDU2” OIDs available in our PowerNet-MIB.

The full path to these OIDs is:

```
iso(1).org(3).dod(6).internet(1).private(4).enterprises(1).apc(318).products(1).  
hardware(1).rPDU2(26)
```

Individual Rack PDUs can be identified in the SNMP MIB tables by viewing the corresponding “Module” OIDs in each table. These Module OIDs will return the Display ID of the Rack PDU.

Example Module OIDs: rPDU2IdentModule, rPDU2DeviceConfigModule, rPDU2SensorTempHumidityConfigModule

In order to be backwards compatible with previous versions, the Host Rack PDU will always be the first index in any table that supports multiple Rack PDUs. In addition, after the Rack PDU group is set up, the index order of guest Rack PDUs should not change even if the Display ID is changed or a PDU temporarily loses communication. The index order should only change if you manually remove a Rack PDU from the group.

A MIB table walk should skip the indexes associated with a Rack PDU that has temporarily lost communication.

SNMPv1

Path: Configuration > Network > SNMPv1 > options

NOTE: SNMPv1 is disabled by default. SNMPv2c is supported under SNMPv1 in this configuration.

Option	Description
access	<p>Enable SNMPv1 Access: Enables SNMP version 1 as a method of communication with this device.</p> <p>NOTE: This configuration also supports SNMPv2c.</p>
access control	<p>You can configure up to four access control entries to specify which Network Management Systems (NMSs) have access to this device. The opening page for access control, by default, assigns one entry to each of the four available SNMPv1 communities, but you can edit these settings to apply more than one entry to any community to grant access by several specific IPv4 and IPv6 addresses, host names, or IP address masks. To edit the access control settings for a community, click its community name.</p> <ul style="list-style-type: none"> If you leave the default access control entry unchanged for a community, that community has access to this device from any location on the network. If you configure multiple access control entries for one community name, the limit of four entries requires that one or more of the other communities must have no access control entry. If no access control entry is listed for a community, that community has no access to this device. <p>Community Name: The name that an NMS must use to access the community. The maximum length is 15 ASCII characters.</p> <p>NMS IP/Host Name: The IPv4 or IPv6 address, IP address mask, or host name that controls access by NMSs. A host name or a specific IP address (such as 149.225.12.1) allows access only by the NMS at that location. IP addresses that contain 255 restrict access as follows:</p> <ul style="list-style-type: none"> 149.225.12.255: Access only by an NMS on the 149.225.12 segment. 149.225.255.255: Access only by an NMS on the 149.225 segment. 149.255.255.255: Access only by an NMS on the 149 segment. 0.0.0.0 (the default setting) which can also be expressed as 255.255.255.255: Access by any NMS on any segment. <p>Access Type: The actions an NMS can perform through the community.</p> <ul style="list-style-type: none"> Read: GETS only, at any time Write: GETS at any time, and SETS when no user is logged onto the Web UI or CLI. Write+: GETS and SETS at any time. Disable: No GETS or SETS at any time.

SNMPv3

Path: Configuration > Network > SNMPv3 > options

For SNMP GETs, SETs, and trap receivers, SNMPv3 uses a system of user profiles to identify users. An SNMPv3 user must have a user profile assigned in the MIB software program to perform GETs and SETs, browse the MIB, and receive traps.

NOTE: SNMPv3 is disabled by default. To use SNMPv3, you must have a MIB program that supports SNMPv3. The Rack PDU supports SHA or MD5 authentication and AES or DES encryption.

Option	Description
access	SNMPv3 Access: Enables SNMPv3 as a method of communication with this device.

<p>user profiles</p>	<p>By default, lists the settings of four user profiles, configured with the user names apc snmp profile1 through apc snmp profile4, and no authentication and no privacy (no encryption). To edit the following settings for a user profile, click a user name in the list.</p> <p>User Name: The identifier of the user profile. SNMP version 3 maps GETs, SETs, and traps to a user profile by matching the user name of the profile to the user name in the data packet being transmitted. A user name can have up to 32 ASCII characters.</p> <p>Authentication Passphrase: A phrase of 15 to 32 ASCII characters that verifies that the NMS communicating with this device through SNMPv3 is the NMS it claims to be, that the message has not been changed during transmission, and that the message was communicated in a timely manner, indicating that it was not delayed and that it was not copied and sent again later at an inappropriate time.</p> <p>Privacy Passphrase: A phrase of 15 to 32 ASCII characters (<code>apc crypt passphrase</code>, by default) that ensures the privacy of the data (by means of encryption) that an NMS is sending to this device or receiving from this device through SNMPv3.</p> <p>Authentication Protocol: The APC by Schneider Electric implementation of SNMPv3 supports SHA and MD5 authentication. Authentication will not occur unless an authentication protocol is selected.</p> <p>Privacy Protocol: The implementation of SNMPv3 supports AES and DES as the protocols for encrypting and decrypting data. Privacy of transmitted data requires that a privacy protocol is selected and that a privacy passphrase is provided in the request from the NMS. When a privacy protocol is enabled but the NMS does not provide a privacy passphrase, the SNMP request is not encrypted.</p> <p>NOTE: You cannot select the privacy protocol if no authentication protocol is selected.</p>
<p>access control</p>	<p>You can configure up to four access control entries to specify which NMSs have access to this device. The opening page for access control, by default, assigns one entry to each of the four user profiles, but you can edit these settings to apply more than one entry to any user profile to grant access by several specific IP addresses, host names, or IP address masks.</p> <ul style="list-style-type: none"> • If you leave the default access control entry unchanged for a user profile, all NMSs that use that profile have access to this device. • If you configure multiple access entries for one user profile, the limit of four entries requires that one or more of the other user profiles must have no access control entry. If no access control entry is listed for a user profile, no NMS that uses that profile has any access to this device. <p>To edit the access control settings for a user profile, click its user name.</p> <p>Access: Mark the Enable checkbox to activate the access control specified by the parameters in this access control entry.</p> <p>User Name: From the drop-down list, select the user profile to which this access control entry will apply. The choices available are the four user names that you configure through the user profiles option on the left navigation menu.</p> <p>NMS IP/Host Name: The IP address, IP address mask, or host name that controls access by the NMS. A host name or a specific IP address (such as 149.225.12.1) allows access only by the NMS at that location. An IP address mask that contains 255 restricts access as follows:</p> <ul style="list-style-type: none"> • 149.225.12.255: Access only by an NMS on the 149.225.12 segment. • 149.225.255.255: Access only by an NMS on the 149.225 segment. • 149.255.255.255: Access only by an NMS on the 149 segment. • 0.0.0.0 (the default setting) which can also be expressed as 255.255.255.255: Access by any NMS on any segment.

Modbus TCP

You must enable Modbus to allow the Building Management System to monitor the Rack PDU through Modbus TCP.

Path: Configuration > Network > Modbus > TCP

Configuration

Modbus TCP

Access
 Enable

Port [502, 5000 to 32768]

Communication Timeout
 Never
 Time
(secs) [0 to 64800, 0 - never]

Keep-Alive
 Enable

[APC's Web Site](#) | [Software & Firmware Downloads](#) | [EcoStruxure™ IT](#)

© 2024, Schneider Electric. All rights reserved.
[Site Map](#) | Updated: 07/11/2024 at 16:08 (10.177.58.201)

Access: Select **Enable** to enable Modbus TCP.

Port: Specify the port for the TCP connection (502 by default, or 5000 to 32768).

Communication Timeout: Enter the number of seconds the Rack PDU waits before disconnecting from the Modbus Poll software.

Keep-Alive: When you select **Enable**, the Rack PDU sends a packet to the server every 2 hours and 75 seconds if any other communication is not detected. This helps prevent a communication timeout when **Communication Timeout** is set to 7,275 seconds or more.

You must log off for the changes to take effect.

FTP Server

Path: Configuration > Network > FTP Server

The **FTP Server** settings enable or disable access to the FTP server. FTP is disabled by default.

By default, the FTP server communicates with the Rack PDU through TCP/IP port 21. The FTP server uses both the specified port and the port one number lower than the specified port.

You can change the **Port** setting to the number of any unused port from 5001 to 32768 for added security. Users must then use a colon (:) to specify the non-default port number. For example, for port 5001 and IP address 152.214.12.114, the command would be `ftp 152.214.12.114:5001`.

NOTE: FTP transfers files without encryption. For higher security, transfer files with Secure Copy Protocol (SCP). Secure SHell (*SSH*) is enabled by default and enables SCP automatically. However, SCP will not allow a file transfer until the Super User default password (**apc**) is changed. At any time that you want a Rack PDU to be accessible for management by StruxureWare Data Center Expert, FTP server access must be enabled in the Rack PDU interface.

For detailed information on enhancing and managing the security of your system, see the *Security Handbook*, available at www.apc.com.

Notifications

Event Actions

Path: Configuration > Notification

Types of notification:

You can configure event actions to occur in response to an event or group of events. These actions notify users of the event in any of several ways:

- Active, automatic notification. The specified users or monitoring devices are contacted directly.
 - email notification
 - SNMP traps
 - Syslog notification
- Indirect notification
 - Event log. If no direct notification is configured, users must check the log to determine which events have occurred.

You can also log system performance data to use for device monitoring. See “Logs in the Configuration Menu” in this manual for information on how to configure and use this data logging option.

— Queries (SNMP GETs)

SNMP enables an NMS to perform informational queries. For SNMPv1, which does not encrypt data before transmission, configuring the most restrictive SNMP access type (READ) enables informational queries without the risk of allowing remote configuration changes.

Configure Event Actions

Path: Configuration > Notification > Event Actions > By Event

By default, logging an event is selected for all events. To define event actions for an individual event:

1. To find an event, click on a column heading to see the lists under the **Device Events** or **System Events** categories.
Or you can click on a sub-category under these headings, like **Security** or **Temperature**.
2. Click on the event name to view or change the current configuration, such as recipients to be notified by email, or Network Management Systems (NMSs) to be notified by SNMP traps. If no Syslog server is configured, items related to Syslog configuration are not displayed.

NOTE: When viewing details of an event configuration, you can enable or disable event logging or Syslog, or disable notification for specific email recipients or trap receivers, but you cannot add or remove recipients or receivers. To add or remove recipients or receivers, see the following topics in this manual:

- Identifying Syslog servers
- Configuration > Notification > email > Recipients
- SNMP trap receiver screen

Path: Configuration > Notification > Event Actions > By Group

To configure a group of events simultaneously:

1. Select how to group events for configuration:
 - Select **Events by Severity**, and then select one or more severity levels. You cannot change the severity of an event.

2. Click **Next** to move to the next screen and do the following:
 - Select event actions for the group of events.
 - a. To select any action except **Logging** (the default), you must first have at least one relevant recipient or receiver configured.
 - b. If you selected **Logging** and have configured a Syslog server, select **Event Log** or **Syslog** on the next screen.
3. Click **Next** to move to the next screen to do the following:
 - If you selected **Logging** on the previous screen, select **Enable Notifications** or **Disable Notification**.
 - If you selected **Email Recipients** on the previous screen, select the email recipients to configure.
 - If you selected **Trap Receivers** on the previous screen, select the trap receiver to configure.
4. Click **Next** to move to the next screen to do the following:
 - If you are configuring **Logging** settings, view the pending actions and click **Apply** to accept the changes or click **Cancel** to revert to the previous settings.
 - If you are configuring **Email Recipients** or **Trap Receivers**, select **Enable Notifications** or **Disable Notification** and set the notification timing settings.
5. Click **Next** to move to the next screen to do the following:
 - View the pending actions and click **Apply** to accept the changes or click **Cancel** to revert to the previous settings.

Notification parameters: These configuration fields define email parameters for sending notifications of events.

They are usually accessed by clicking the receiver or recipient name.

Field	Description
Delay <i>n</i> time before sending	If the event persists for the specified time, the notification is sent. If the condition clears before the time expires, no notification is sent.
Repeat at an interval of <i>n</i>	The notification is sent repeatedly at the specified interval (the default is every 2 minutes until the condition clears).
Up to <i>n</i> times	During an active event, the notification repeats for this number of times.
or	
Until condition clears	The notification is sent repeatedly until the condition clears or is resolved.

NOTE: For events that have an associated clearing event, you can also set these parameters.

Email Notification Screens

Use Simple Mail Transfer Protocol (SMTP) to send email to up to four recipients when an event occurs. To use the email feature, you must define the following settings:

- The IP addresses of the primary and, optionally, the secondary Domain Name System (DNS) servers.
- The IP address or DNS name for the SMTP Server and From Address.
- The email addresses for a maximum of four recipients.
- You can use the **To Address** setting of the recipient’s option to send email to a text-based screen.

Path: Configuration > Notification > email > Server

This screen lists your primary and secondary DNS servers and displays the following fields:

From Address: The contents of the **From** field in email messages sent by the Rack PDU:

- In the format **user@[IP_address]** (if an IP address is specified as Local SMTP Server)
- In the format **user@domain** (if DNS is configured and the DNS name is specified as Local SMTP Server) in the email messages.

NOTE: The local SMTP server may require that you use a valid user account on the server for this setting. See the server documentation.

SMTP Server: The IPv4/ IPv6 address or DNS name of the local SMTP server.

NOTE: This definition is required only when the SMTP server is set to **Local**.

Authentication: Enable this if the SMTP server requires authentication.

Port: The SMTP port number, with a default of 25. The range is 25, 465, 587, 2525, 5000 to 32768.

User Name, Password, and Confirm Password: If your mail server requires authentication, enter your user name and password here. This performs a simple authentication, not SSL/TLS.

Use SSL/TLS: Select when encryption is used.

- **Never:** The SMTP server does not require nor support encryption.
- **If Supported:** The SMTP server advertises support for STARTTLS but doesn't require the connection to be encrypted. The STARTTLS command is sent after the advertisement is given.
- **Always:** The SMTP server requires the STARTTLS command to be sent on connection to it.
- **Implicitly:** The SMTP server only accepts connections that begin encrypted. No STARTTLS message is sent to the server.

Require CA Root Certificate: This should only be enabled if the security policy of your organization does not allow for implicit trust of SSL/TLS connections. If this is enabled, a valid root CA certificate must be loaded onto the RPDU for encrypted emails to be sent.

File Name: This field is dependent on the root CA certificates installed on the Rack PDU and whether or not a root CA certificate is required.

Path: **Configuration > Notification > email > Recipients**

Specify up to four email recipients. Click on a name to configure the settings.

Generation: Enables (default) or disables sending email to the recipient.

To Address: The user and domain names of the recipient. To use email for paging, use the email address for the recipient's pager gateway account (for example, myacct100@skytel.com). The pager gateway will generate the page. To bypass the DNS lookup of the IP address of the mail server, use the IP address in brackets instead of the email domain name, e.g., use jsmith@[xxx.xxx.x.xxx] instead of jsmith@company.com. This is useful when DNS lookups are not working correctly.

Language: The language which the email notification will be sent in. This is dependent on the installed language pack (if applicable).

Port: The SMTP port number, with a default of 25. The range is 25, 465, 587, 2525, 5000 to 32768.

Format: The long format contains name, location, contact, IP address, serial number of the device, date and time, event code, and event description. The short format provides only the event description.

Server: Select one of the following methods for routing email:

- **Local:** This is through the site-local SMTP server. This recommended setting ensures that the email is sent using the site-local SMTP server. Choosing this setting limits delays and network outages and retries sending email for many hours. When choosing the Local setting you must also enable forwarding at the SMTP server of your device and set up a special external email account to receive the forwarded email. Check with your SMTP server administrator before making these changes.

- **Recipient:** This is the SMTP server of the recipient. The Rack PDU performs an MX record look-up on the recipient's email address and uses that as its SMTP server. The email is only sent once so it could easily be lost.
- **Custom:** This setting enables each email recipient to have its own server settings. These settings are independent of the settings given under "SMTP Server" above.

Path: Configuration > Notification > email > SSL Certificates

Load a mail SSL/TLS certificate on the Rack PDU for greater security. The file must have an extension of `.crt` or `.cer`. Up to five files can be loaded at any given time.

When installed, the certificate details also display here. An invalid certificate will display "n/a" for all fields except **File Name**.

Certificates can be deleted using this screen. Any email recipients using the certificate should be manually modified to remove reference to this certificate.

Path: Configuration > Notification > email > Test

Send a test message to a configured recipient.

SNMP Trap Receiver Screen

Path: Configuration > Notification > SNMP Traps > Trap Receivers

With Simple Network Management Protocol (SNMP) traps, you can automatically get notifications for significant device events. They are a useful tool for monitoring devices on your network.

The trap receivers are displayed by **NMS IP/Host Name**, where NMS stands for Network Management System. You can configure up to six trap receivers.

To configure a new trap receiver, click **Add Trap Receiver**. To edit (or delete) one, click its IP address/host name.

Trap Generation: Enable (the default) or disable trap generation for this trap receiver.

NMS IP/Host Name: The IPv4/ IPv6 address or host name of this trap receiver. The default, 0.0.0.0, leaves the trap receiver undefined.

Language: Select a language from the drop-down list. This can differ from the Web UI and from other trap receivers.

Select either the **SNMPv1** or **SNMPv3** radio button to specify the trap type. For an NMS to receive both types of traps, you must separately configure two trap receivers for that NMS, one for each trap type.

SNMPv1: Settings for SNMPv1

- **Community Name:** The name used as an identifier when SNMPv1 traps are sent to this trap receiver.
- **Authenticate Traps:** When this option is enabled (the default), the NMS identified by the NMS IP/Host Name setting will receive authentication traps (traps generated by invalid attempts to log on to this device).

SNMPv3: Settings for SNMPv3

- **User Name:** Select the identifier of the user profile for this trap receiver.

If you delete a trap receiver, all notification settings configured under "Configuring event actions" for the deleted trap receiver are set to their default values.

SNMP Traps Test Screen

Path: Configuration > Notification > SNMP Traps > Test

Last Test Result: The result of the most recent SNMP trap test. A successful SNMP trap test verifies only that a trap was sent; it does not verify that the trap was received by the selected trap receiver. A trap test succeeds if all of the following are true:

- The SNMP version (SNMPv1 or SNMPv3) configured for the selected trap receiver is enabled on this device.
- The trap receiver itself is enabled.
- If a host name is selected for the **To** address, that host name can be mapped to a valid IP address.

To: Select the IP address or host name to which a test SNMP trap will be sent. If no trap receiver is configured, a link to the **Trap Receiver** configuration screen is displayed.

General Menu

This menu contains miscellaneous configuration items including device identification, date and time, exporting and importing your RPDU configuration options, the three links at the bottom left of the screen, and consolidating data for troubleshooting purposes.

Identification Screen

Path: Configuration > General > Identification

Define the **Name**, the **Location** (the physical location), and the **Contact** (the person responsible for the device) used by:

- the SNMP agent of the Rack PDU and
- StruxureWare Data Center Expert

Specifically, the name field is used by the **sysName**, **sysContact**, and **sysLocation** object identifiers (OIDs) in the SNMP agent of the Rack PDU. For more information about MIB-II OIDs, see the PowerNet® *SNMP Management Information Base (MIB) Reference Guide*, available at www.apc.com.

Host Name Synchronization allows the host name to be synchronized with the system name so both fields automatically contain the same value.

NOTE: When enabling this feature, the system name identifier can no longer contain a space character (since it will be synchronized to the host name field).

System Message: When defined, a custom message will appear on the log on screen for all users.

Date/Time Screen

Path: Configuration > General > Date/Time > Mode

Set the time and date used by the device. (Note that the time format used is 24 hour only.) You can change the current settings manually or through a Network Time Protocol (NTP) Server.

With both, you select the **Time Zone**. This is your local time difference with Coordinated Universal Time (UTC), also known as Greenwich Mean Time (GMT).

Manual Mode

Do one of the following:

- Enter the date and time for the device
- Select the check box **Apply Local Computer Time** to apply the date and time settings of the computer you are using

Synchronize with NTP Server

Have an NTP (Network Time Protocol) Server define the date and time for the Rack PDU. By default, any Rack PDU on the private side of a StruxureWare Data Center Expert obtains its time settings by using StruxureWare Data Center Expert as an NTP server.

- **Override Manual NTP Settings:** If you select this, data from other sources (typically DHCP) take precedence over the NTP configurations you set here.
- **Primary NTP Server:** Enter the IP address or domain name of the primary NTP server.
- **Secondary NTP Server:** Enter the IP address or domain name of the secondary NTP server, when a secondary server is available.
- **Update Interval:** Define, in hours, how often the Rack PDU accesses the NTP Server for an update. Minimum: 1; Maximum: 8760 (1 year).
- **Update Using NTP Now:** Initiate an immediate update of the date and time by the NTP Server.

Daylight Saving

Path: Configuration > General > Date /Time > Daylight Saving

Daylight Saving Time (DST) is disabled by default. You can enable traditional United States DST or enable and configure a customized daylight saving time to match how Daylight Saving Time is implemented in your local area.

When customizing DST, the system puts the clock forward by an hour when the time and date you specify under **Start** is reached and puts the clock back an hour when the time and date you specify under **End** is reached.

- If your local DST always starts or ends on the fourth occurrence of a specific weekday of a month (e.g., the fourth Sunday), choose Fourth/Last. If a fifth Sunday occurs in that month, you should still choose Fourth/Last.
- If your local DST always starts or ends on the last occurrence of a specific weekday of a month, whether it is the fourth or the fifth occurrence, choose Fifth/Last.

Creating and Importing Settings with the Config File

Path: Configuration > General > User Config File

Use the settings from one Rack PDU to configure another. Retrieve the config.ini file from the configured Rack PDU, customize that file (e.g., change the IP address), and upload the customized file to the new Rack PDU.

The file name can be up to 64 characters and must have the .ini suffix.

Status	Reports the progress of the upload. The upload succeeds even if the file contains errors, but a system event reports the errors in the event log.
Upload	Browse to the customized file and upload it so that the current Rack PDU can use it to set its own configuration.
Download	Allows the download of the Configuration File (config.ini) file directly through the web browser to the user's computer.

To retrieve and customize the file of a configured Rack PDU, see [How to Export Configuration Settings](#) in this manual.

Instead of uploading the file to one Rack PDU, you can export the file to multiple Rack PDUs by using an FTP or SCP script.

Configure Links

Path: Configuration > General > Quick Links

Select **Configuration > General > Quick Links** to view and change the URL links displayed at the bottom left of each page of the interface.

By default, these links access the following Web pages:

- **Link 1:** The home page of the APC by Schneider Electric website
- **Link 2:** Demonstrations of APC by Schneider Electric web-enabled products
- **Link 3:** Information on EcoStruxure IT

Logs in the Configuration Menu

Identifying Syslog Servers

Path: Configuration > Logs > Syslog > Servers

Click **Add Server** to configure a new Syslog server.

Syslog Server: Uses IPv4/ IPv6 addresses or host names to identify from one to four servers to receive Syslog messages sent by the Rack PDU.

Port: The port that the Rack PDU will use to send Syslog messages. The default UDP port assigned to Syslog is 514.

Language: Select the language for any Syslog messages.

Protocol: Select either UDP or TCP.

Syslog Settings

Path: Configuration > Logs > Syslog > Settings

Message Generation: Enable the generation and the logging of Syslog messages for events that have Syslog configured as a notification method.

Facility Code: Selects the facility code assigned to the Syslog messages of the Rack PDU (User, by default).

NOTE: User best defines the Syslog messages sent by the Rack PDU. Do not change this selection unless advised to do so by the Syslog network or system administrator.

Severity Mapping: This section maps each severity level of the Rack PDU or environment events to available Syslog priorities. The local options are **Critical**, **Warning**, and **Informational**. You should not need to change the mappings.

- **Emergency:** The system is unusable
- **Alert:** Action must be taken immediately
- **Critical:** Critical conditions
- **Error:** Error conditions
- **Warning:** Warning conditions
- **Notice:** Normal but significant conditions
- **Informational:** Informational messages
- **Debug:** Debug-level messages

The following are the default settings for the **Local Priority** settings:

- **Critical** is mapped to **Critical**
- **Warning** is mapped to **Warning**
- **Informational** is mapped to **Info**

Syslog Test and Format Example

Path: Configuration > Logs > Syslog > Test

Send a test message to the Syslog servers (configured through the “Identifying Syslog servers” option above). The result will be sent to all configured Syslog servers.

Select a severity to assign to the test message and then define the test message. Format the message to consist of the event type (for example, APC, System, or Device) followed by a colon, a space, and the event text. The message can have a maximum of 50 characters.

- The priority (PRI): the Syslog priority assigned to the message event, and the facility code of messages sent by the Rack PDU.
- The Header: a time stamp and the IP address of the Rack PDU.
- The Message (MSG) part:
 - The **TAG** field, followed by a colon and space, identifies the event type.
 - The **CONTENT** field is the event text, followed (optionally) by a space and the event code.

Example:

```
APC: Test Syslog is valid.
```

Tests Tab

Setting the Network Status LED or Device LCD to Blink

Path: Tests > Network > LED Blink

If you are having trouble finding your device, enter a number of minutes in the **LED Blink Duration** field, click **Apply**, and the Status LED on the display will blink.

Path: Tests > RPDU > LCD Blink

Under this menu, you can enter a number of minutes in the **LCD Blink Duration** field, click **Apply** and the LCD backlight will begin blinking.

Logs Tab

Event, Data, and Firewall Logs

Event Log

Path: Logs > Events

By default, the log displays all events recorded during the last two days, starting with the latest events.

Additionally, the log records any event that sends an SNMP trap, except SNMP authentication failures, and abnormal internal system events.

You can enable color coding for events on the **Configuration > Security > Local Users Management** screen.

Path: Logs > Events > Log

By default, the event log displays the most recent events first. To see the events listed together on a Web page, click Launch Log in New Window.

To open the log in a text file or to save the log to disk, click on the floppy disk icon



on the same line as the **Event Log** heading.

You can also use FTP or Secure Copy Protocol (SCP) to view the event log. See **FTP or SCP to retrieve Log Files** in this manual.

Filtering Event Logs

Use filtering to omit information you don't want to display.

- Filtering the log by date or time: Use the **Last** or **From** radio buttons. (The filter configuration is saved until the Rack PDU restarts.)
- Filtering the log by event severity or category:
 - Click **Filter Log**.
 - Clear a check box to remove it from view.
 - After you click **Apply**, text at the upper right corner of the **Event Log** page indicates that a filter is active. The filter is active until you clear it or until the Rack PDU restarts.
- Removing an active filter:
 - Click **Filter Log**.
 - Click **Clear Filter (Show All)**.
 - As Administrator, click **Save As Default** to save this filter as the new default log view for all users.

Important points on filtering:

- Events are processed through the filter using OR logic. If you apply a filter, it works regardless of the other filters.
- Events that you cleared in the **Filter By Severity** list never display in the filtered **Event Log**, even if selected in the **Filter by Category** list.
- Similarly, events that you clear in the Filter by Category list never display in the filtered **Event Log**.

Deleting event logs

To delete all events, click **Clear Log**. Deleted events cannot be retrieved.

To disable the logging of events based on their assigned severity level or their event category, see **Configure Event Actions** in this manual.

Path: Logs > Events > Reverse Lookup

With reverse lookup enabled, when a network-related event occurs, both the IP address and the domain name for the networked device with the event are logged in the event log. If no domain name entry exists for the device, only its IP address is logged with the event.

Since domain names generally change less frequently than IP addresses, enabling reverse lookup can improve the ability to identify addresses of networked devices that are causing events.

Reverse lookup is disabled by default. You should not need to enable it if you have no DNS server configured or have poor network performance because of heavy network traffic.

Path: Logs > Events > Size

Use **Event Log Size** to specify the maximum number of log entries.

NOTE: When you resize the event log in order to specify a maximum size, all existing log entries are deleted. When the log subsequently reaches the maximum size, the older entries are deleted.

Network Port Sharing Event Logs and Traps

Rack PDU events from guest Rack PDUs are sent to the host Rack PDU for inclusion into its log. The log entry will include the Display ID of the unit that the event occurred on. These events are then handled the same as local events from the host PDU. Therefore alarms, SNMP traps, emails, Syslog, etc., will support Rack PDU events and alarms from all Rack PDUs in a group.

Example event log: `Rack PDU 4: Device low load.`

NOTE: System events will only be logged for the host Rack PDU. System events from guest Rack PDUs will not be logged on the host PDU.

Data Log

Use the data log to display measurements about the Rack PDU, the power input to the Rack PDU, and the ambient temperature of the Rack PDU.

The steps to display and resize the data log are the same as for the event log, except that you use menu options under **Data** instead of **Events**.

Path: Logs > Data > Log

Filtering Data Logs

Use filtering to omit information you don't want to display. Using the **Network Port Sharing Data Log**, the host Rack PDU will poll data from guest Rack PDUs so that data from all Rack PDUs in a group are available. To view data from a different Rack PDU in a group, select the desired Rack PDU from the "Filter Log" pull-down list.

Similarly for data log graphing, you can select a different Rack PDU by clicking on the **Change Data Filter** button.

- Filtering the log by date or time: Use the **Last** or **From** radio buttons. (The filter configuration is saved until the Rack PDU restarts.)
- Filtering the log by event severity or category:
 - Click **Filter Log**.
 - Clear a check box to remove it from view.
 - After you click **Apply**, text at the upper right corner of the **Data Log** page indicates that a filter is active. The filter is active until you clear it or until the Rack PDU restarts.

- Removing an active filter:
 - Click **Filter Log**.
 - Click **Clear Filter (Show All)**.
 - As Administrator, click **Save As Default** to save this filter as the new default log view for all users.

Deleting data logs

To delete all data log records, click **Clear Data Log**. Deleted data log records cannot be retrieved.

Path: Logs > Data > Interval

Define, in the **Log Interval** setting, how frequently data is searched for and stored in the data log. When you click **Apply**, the number of possible storage days is recalculated and display at the top of the screen. When the log is full, the oldest entries are deleted.

NOTE: Because the interval specifies how often the data is recorded, the smaller the interval, the more times the data is recorded and the larger the log file.

Data Log Graphing

Path: Logs > Data > Graphing

Data log graphing provides a graphical display of logged data and is an enhancement of the existing data log feature. How the graphing enhancement displays data and how efficiently it performs will vary depending on your computer hardware, computer operating system, and the Web browser you use to access the interface of the unit.

NOTE: JavaScript® must be enabled in your browser to use the graphing feature. Alternatively, you can use FTP or SCP to import the data log into a spreadsheet application, and graph data in the spreadsheet.

Graph Data: Select the data items that correspond to the abbreviated column headings in the data log to graph multiple data items. Hold down the CTRL key to select multiple items.

Graph Time: Select **Last** to graph all records or to change the number of hours, days, or weeks for which data log information is graphed. Select a time option from the drop-down menu. Select **From** to graph data logged during a specific time period.

NOTE: Enter time using the 24-hour clock format.

Apply: Click **Apply** to graph the data.

Launch Graph in New Window: Click **Launch Graph in New Window** to launch the data log graph in a new browser window that provides a larger view of the graph.

Data Log Rotation

Path: Logs > Data > Rotation

Rotation causes the contents of the data log to be appended to the file you specify by name and location. Use this option to set up password-protection and other parameters.

- **FTP Server:** The IP address or host name of the server where the file will reside.
- **User Name/Password:** The user name with password required to send data to the repository file. This user must also be configured to have read and write access to the data repository file and the directory (folder) in which it is stored.
- **File Path:** The path to the repository file.

- **Filename:** The name of the repository file (an ASCII text file), e.g. `datalog.txt`. Any new data is appended to this file: it does not overwrite it.
- **Unique Filename:** Select this check box to save the log as `mmdyyy_<filename>.txt`, where filename is what you specified in the **Filename** field above. Any new data is appended to the file but each day has its own file.
- **Delay n hours between uploads:** The number of hours between uploads of data to the file (max. 24 hours).
- **Upon failure, try uploading every n minutes:** The number of minutes between attempts to upload data to the file after a failed upload.
 - **Up to n times:** The maximum number of times the upload will be attempted after it fails initially.
 - **Until upload succeeds:** Attempt to upload the file until the transfer is completed.

Data Log Size

Path: Logs > Data > Size

Use **Data Log Size** to specify the maximum number of log entries.

NOTE: When you resize the data log in order to specify a maximum size, all existing log entries are deleted. When the log subsequently reaches the maximum size, the older entries are deleted.

Firewall Logs

Path: Logs > Firewall

If you create a firewall policy, firewall events will be logged here.

The information in the log can be useful to help the technical support team solve problems. Log entries contain information about the traffic and the rules action (allowed, discarded). When logged here, these events are not logged in the main Event Log.

A firewall log contains up to 50 of the most recent events. The firewall log is cleared when the management interface reboots.

Use FTP or SCP to Retrieve Log Files

An Administrator or Device User can use FTP or SCP to retrieve a tab-delimited event log file (`event.txt`) or data log file (`data.txt`) and import it into a spreadsheet.

- The file reports all events or data recorded since the log was last deleted or (for the data log) truncated because it reached maximum size.
- The file includes information that the event log or data log does not display.
 - The version of the file format (first field)
 - The date and time the file was retrieved
 - The **Name**, **Contact**, and **Location** values and IP address of the Rack PDU
 - The unique **Event Code** for each recorded event (`event.txt` file only)

NOTE: The Rack PDU uses a four-digit year for log entries. You may need to select a four-digit date format in your spreadsheet application to display all four digits.

If you are using the encryption-based security protocols for your system, use SCP to retrieve the log file. If you are using unencrypted authentication methods for the security of your system, use FTP to retrieve the log file.

NOTE: By default, FTP is disabled and SCP (via SSH) is enabled.

See the *Security Handbook*, available at www.apc.com, for information on available protocols and methods for setting up the type of security you need.

To use SCP to Retrieve the Files

To retrieve the `event.txt` file, use the following command:

```
scp -c <cipher> username@hostname_or_ip_address:event.txt ./event.txt
```

To retrieve the `data.txt` file, use the following command:

```
scp -c <cipher> username@hostname_or_ip_address:data.txt ./data.txt
```

NOTE:

- This SCP command is for OpenSSH. The command may differ depending on the SSH tool used.
- When using OpenSSH, `<cipher>` can be either `aes256-cbc` or `3des-cbc`.

To Use FTP to Retrieve the `event.txt` or `data.txt` Files

1. At a command prompt, type `ftp` and the IP address of the Rack PDU, and press ENTER.

If the **Port** setting for the **FTP Server** option (set through the **Network** menu of the **Administration** tab) has been changed from its default (**21**), you must use the non-default value in the FTP command. For Windows FTP clients, use the following command, including spaces. (For some FTP clients, you must use a colon instead of a space between the IP address and the port number.)

```
ftp>open ip_address port_number
```

To set a non-default port value to enhance security for the FTP Server. You can specify any port from 5001 to 32768.

2. Use the case-sensitive **User Name** and **Password** for Administrator or Device User to log on. For Administrator, **apc** is the default for **User Name** and **Password**. For the Device User, the defaults are **device** for **User Name** and **apc** for **Password**.
3. Use the **get** command to transmit the text of a log to your local drive.

```
ftp>get event.txt
```

or

```
ftp>get data.txt
```

4. Type `quit` at the `ftp>` prompt to exit from FTP.

About Tab

About the Rack PDU

Path: About > RPDU/Network

The hardware information is useful to APC by Schneider Electric Customer Support for troubleshooting problems with the Rack PDU. The serial number and MAC address are also available on the Rack PDU itself.

Firmware information for the Application Module, APC OS (AOS), and APC Boot Monitor indicates the name, the firmware version, and the date and time each firmware module was created. This information is also useful in troubleshooting and enables you to determine if updated firmware is available at the website, www.apc.com.

Management Uptime is the length of time the network management interface has been running continuously.

Support Screen

Path: About > Support

With this option, you can consolidate various data in this interface into a single zipped file for troubleshooting purposes and customer support. The data includes the event and data logs, the configuration file and complex debugging information.

Click **Generate Logs** to create the file and then **Download**. You will be asked whether you want to view or save the zipped file.

Device IP Configuration Wizard

Capabilities, Requirements, and Installation

How to use the Wizard to Configure TCP/IP Settings

The Device IP Configuration Wizard can discover Rack PDUs that do not have an IP address assigned. Once discovered, you can configure the IP address settings for the cards.

You can also search for devices already on the network by entering an IP range to define the search. The Utility scans the IP addresses in the defined range and discovers Rack PDUs that already have a DHCP-assigned IP address.

NOTE: See detailed information on the Utility in the Frequently Asked Questions (FAQs) section of the APC by Schneider Electric website. Go to www.apc.com, select your country from the drop-down list, select Support > Resources and Tools > FAQs and search for FA156064 (the ID of the relevant article).

NOTE: To use the DHCP Option 12, see FAQ FA156110.

System Requirements

The Device IP Configuration Wizard is a Windows application designed specifically to remotely configure the basic TCP/IP settings of Network Management Cards. The Wizard runs on Microsoft® Windows® 2000, Windows Server 2003, Windows Vista, Windows XP, Windows 7, Windows Server® 2008, Windows 8, and Windows 10, and Windows 2012. This utility supports cards that have firmware version 3.x.x or higher and is for IPv4 only.

Installation

To install the Device IP Configuration Wizard from a downloaded executable file:

1. Go to www.apc.com
2. Download the Device IP Configuration Wizard.
3. Run the downloaded executable file.

When installed, the Device IP Configuration Wizard is available through the Windows Start menu options.

How to Export Configuration Settings

Retrieving and Exporting the .ini File

Summary of the Procedure

A Super User/Administrator can retrieve the .ini file of a device and export it to another device or to multiple devices. The steps are below; see details in the sections following.

1. Configure a device with the desired settings and export them.
2. Retrieve the .ini file from that device.
3. Customize the file to change the TCP/IP settings at least.
4. Use a file transfer protocol supported by the device to transfer a copy to one or more other devices. For a transfer to multiple devices, use and FTP or SCP script or the .ini file utility.

NOTE: FTP is disabled by default.

Each receiving device uses the file to reconfigure its own settings and then deletes it.

NOTE: Managing Users via the config.ini - Users are no longer managed via the config.ini in any form. Users are now managed via a separate file with the .csf extension. www.apc.com.

Contents of the .ini File

The config.ini file you retrieve from a device contains the following:

- Section headings and keywords (only those supported for the particular device from which you retrieve the file): **Section headings** are category names enclosed in brackets ([]). **Keywords**, under each section heading, are labels describing specific device settings. Each keyword is followed by an equal sign and a value (either the default or a configured value).
- The `Override` keyword: With its default value, this keyword prevents the exporting of one or more keywords and their device-specific values. For example, in the `[NetworkTCP/IP]` section, the default value for `Override` (the MAC address of the device) blocks the exporting of values for the `SystemIP`, `SubnetMask`, `DefaultGateway`, and `BootMode`.

.ini and Network Port Sharing

The .ini configuration utility is able to get and set values for all devices in a group. In order to be backwards compatible, the host Rack PDU will always be designated as first, "PDU_A". Any guest Rack PDUs are then designated "PDU_B", "PDU_C", and "PDU_D" based on their Display ID in ascending order up to PDU_Z. After that, further PDUs are designated PDU_AA, up to PDU_FF. Therefore, "PDU_A" will not necessarily correlate to Display ID 1, and so on.

NOTE: Because of the large number of configuration values possible in a Rack PDU group, it may take a very long time to process an INI file set. For example, a Rack PDU group of 4 units with all values changing may take 30 minutes to complete processing.

Detailed Procedures

Retrieving: To set up and retrieve an .ini file to export:

1. If possible, use the interface of a Rack PDU to configure it with the settings to export. (Directly editing the .ini file risks introducing errors).
2. Use FTP or SCP to retrieve the *config.ini* from the configured Rack PDU:
 - To use FTP:
 - a. Open a connection to the Rack PDU using its IP address:
`ftp> open ip_address`
 - b. Log on using the Super User/Administrator user name and password.
 - c. Retrieve the *config.ini* file containing the settings of the Rack PDU:
`ftp > get config.ini`
 The file is written to the folder from which you launched the FTP.
 To retrieve configuration settings from multiple Rack PDUs and export them to the other Rack PDUs, see *Release Notes: ini File Utility, version 2.0*, available at www.apc.com.

— To use SCP, use the following command:

```
scp -c <cipher> username@hostname_or_ip_address:config.ini
./config.ini
```

Then enter the correct password.

NOTE: This SCP command is for OpenSSH. The command may differ depending on the SSH tool used.

NOTE: When using OpenSSH, <cipher> can be either aes256-cbc or 3des- cbc

Customizing: You must customize the file before you export it.

1. Use a text editor to customize the file.
 - Section headings, keywords, and pre-defined values are not case-sensitive, but string values that you define are case-sensitive.
 - Use adjacent quotation marks to indicate no value. For example, `LinkURL1=""` indicates that the URL is intentionally undefined.
 - To export scheduled events, configure the values directly in the .ini file.
 - To export a system time with the greatest accuracy, if the receiving NMC 2s can access a Network Time Protocol server, configure `enabled` for `NTPEnable:`
`NTPEnable=enabled`
 - Alternatively, reduce transmission time by exporting the [SystemDate/Time] section as a separate .ini file.
 - To add comments, start each comment line with a semicolon (;).
2. Copy the customized file to another file name in the same folder:
 - The file name can have up to 64 characters and must have the .ini suffix.
 - Retain the original customized file for future use. **The file that you retain is the only record of your comments.**

Transferring the file to a single Rack PDU: To transfer the .ini file to another Rack PDU, do either of the following:

- From the Web UI of the receiving Rack PDU, select **Configuration > General> User Config File**. Enter the full path of the file or use Browse on your local PC.
- Use any file transfer protocol supported by Rack PDUs, i.e., FTP, FTP Client, SCP, or TFTP. The following example uses FTP:
 - From the folder containing the copy of the customized .ini file, use FTP to log in to the Rack PDU to which you are exporting the .ini file:
`ftp> open ip_address`
 - Export the copy of the customized .ini file to the root directory of the receiving Rack PDU:
`ftp> put filename.ini`

Exporting the file to multiple Rack PDUs: To export the .ini file to multiple Rack PDUs:

- Use FTP or SCP but write a script that incorporates and repeats the steps used for exporting the file to a single Rack PDU.
- Use a batch processing file and the .ini file utility.
- To create the batch file and use the utility, see *Release Notes: ini File Utility, version 2.0*, available at www.apc.com.

The Upload Event and Error Messages

The Event and Its Error Messages

The following event occurs when the receiving Rack PDU completes using the .ini file to update its settings.

Configuration file upload complete, with number valid values
If a keyword, section name, or value is invalid, the upload by the receiving Rack PDU succeeds, and additional event text states the error.

Event text	Description
Configuration file warning: Invalid keyword on line <i>number</i> . Configuration file warning: Invalid value on line <i>number</i> .	A line with an invalid keyword or value is ignored.
Configuration file warning: Invalid section on line <i>number</i> .	If a section name is invalid, all keyword/value pairs in that section are ignored.
Configuration file warning: Keyword found outside of a section on line <i>number</i> .	A keyword entered at the beginning of the file (i. e., before any section headings) is ignored.
Configuration file warning: Configuration file exceeds maximum size.	If the file is too large, an incomplete upload occurs. Reduce the size of the file, or divide it into two files, and try uploading again.

Messages in config.ini

A Rack PDU from which you download the config.ini file must be discovered successfully in order for its configuration to be included. If the Rack PDU is not present or is not discovered, the config.ini file contains a message under the appropriate section name, instead of keywords and values.

For example: Rack PDU not discovered

If you did not intend to export the Rack PDU configuration as part of the .ini file import, ignore these messages.

Errors Generated by Overridden Values

The `Override` keyword and its value will generate error messages in the event log when it blocks the exporting of values. See “Contents of the .ini file” in this manual for information about which values are overridden.

Because the overridden values are device-specific and not appropriate to export to the other Rack PDUs, ignore these error messages. To prevent these error messages, delete the lines that contain the `Override` and the lines that contain the values that they override. Do not delete or change the line containing the section heading.

Related Topics

On Windows operating systems, instead of transferring .ini files, you can use the Device IP Configuration Wizard to update the basic TCP/IP settings of the Rack PDU and configure other settings through its user interface.

Updating Firmware

When you update the firmware on the Rack PDU:

- You obtain the latest bug fixes and performance improvements.
- New features become available for immediate use.

Keeping the firmware versions consistent across your network helps ensure that all Rack PDUs support the same features in the same manner. Here, upgrading simply means placing the firmware file on the Rack PDU; there is no installation required. Check regularly on www.se.com for any new updates.

Firmware File Transfer Methods

To upgrade the firmware of one or more NMCs **to firmware version 3.x or later**, download the Secure NMC System Tool for your application (SU or SUCAN) from the APC website. For more information on how to use the Secure NMC System Tool, please consult the *Secure NMC System (SNS) Tool User Guide*.

NOTE: A valid Secure NMC System subscription is required to upgrade to firmware version 3.x using the Secure NMC System Tool.

NOTE: Firmware versions 3.x or later are not currently available in China or Japan. The latest firmware version available is version 2.5.0.6.

To update the firmware of one or more NMCs **to firmware version 2.5.x or earlier**, use one of these five methods:

- On a Windows operating system, use the **Firmware Update Utility** downloaded from . See *Use the Firmware Update Utility*, page 158.
- On any supported operating system, use **FTP** or **SCP** to transfer the .nmc3 file. See *Use FTP or SCP to Update One Rack PDU*, page 159.
- For a Network Management Card that is **NOT** on your network, use **XMODEM** through a USB virtual communication port via the boot loader to transfer the .nmc3 file from your computer to the NMC. See *Use XMODEM To Upgrade One Rack PDU*, page 160.
- Use a **USB drive** to transfer the .nmc3 file from your computer to the NMC. See *Use a USB Drive To Transfer and Update Files*, page 160.
- For updates to **multiple NMCs**, see *Use the Firmware Upgrade Utility For Multiple Upgrades*, page 161.

Use the Firmware Update Utility

This Firmware Update Utility is part of the firmware update package available on www.apc.com. *(Never use an Update Utility designated for one product to update the firmware of another product).*

Use the Utility for updates on Windows-based systems. On any supported Windows operating system, the Firmware Update Utility automates the firmware transfer.

Unzip the downloaded firmware update file and double-click the .exe file. Then enter the IP address, the user name, and the password in the dialog fields and click **Start Update Now**. You can use the **Ping** button to test your entered details.

Use the Utility for manual updates, primarily on Linux. On non-Windows operating systems, the Firmware Update Utility extracts the firmware file, but does not upgrade the Rack PDU.

To extract the firmware files:

1. After extracting files from the downloaded firmware upgrade file, run the **Firmware Update Utility** (the .exe file).
2. At the prompts, click **Next>**, then specify the directory location to which the files will be extracted.
3. When the **Extraction Complete** message displays, close the dialog box.

See *Firmware File Transfer Methods*, page 157 for the different upgrade methods after extraction.

Use FTP or SCP to Update One Rack PDU

FTP

To use FTP to update a Rack PDU over the network:

- The Rack PDU must be on the network with its system IP, subnet mask, and default gateway configured.
- The FTP server must be enabled at the Rack PDU. You can enable the FTP server under **Configuration > Network > FTP Server**.

To transfer the files:

1. Extract the firmware file.

2. At a computer on the network, open a command prompt window. Go to the directory that contains the firmware files, and list the files:

```
C:\>cd apc
```

```
C:\apc>dir
```

3. Open an FTP client session: `C:\apc>ftp`

4. Type `open` with the IP address of the Rack PDU, and press ENTER. If the **port** setting for the FTP Server has changed from its default of **21**, you must use the non-default value in the FTP command.

- For Windows FTP clients, separate a non-default port number from the IP address by a space. For example (showing a space before 21000):

```
ftp> open 150.250.6.10 21000
```

- Some FTP clients require a colon instead before the port number.

5. Log on as the Super User (**apc** is the default user name and password) or Administrator.

6. Send the .nmc3 file:

```
put apc_hw21_rpdu2g_0-0-0.nmc3
```

(where 0-0-0 is the firmware version number).

7. When FTP confirms the transfer, type `quit` to close the session.

SCP

To use Secure Copy Protocol (SCP) to update firmware for the Rack PDU, follow these steps:

NOTE: As SCP is part of SSH, enabling SSH also enables SCP. SSH is enabled by default.

1. Locate the firmware file.

2. Use an SCP command line to transfer the firmware to the Rack PDU. The following example uses 0-0-0 to represent the version number of the firmware:

```
scp -c <cipher> apc_hw21_rpdu2g_0-0-0.nmc3
```

```
apc@158.205.6.185:apc_hw21_rpdu2g_0-0-0.nmc3
```

NOTE: This SCP command is for OpenSSH. The command may differ depending on the SSH tool used. `<cipher>` can be either `aes256-cbc` or `3des-cbc`.

Use XMODEM To Upgrade One Rack PDU

To use XMODEM to upgrade one Rack PDU that is not on the network, you must extract the firmware files from the Firmware Upgrade Utility.

To transfer the files:

1. Select a serial port at the local computer and disable any service that uses the port.
2. Connect a Micro USB cable to the selected port and to the Console port at the Rack PDU.
3. Run a terminal program such as TeraTerm or HyperTerminal, and configure the selected port for 115200 bps, 8 data bits, no parity, 1 stop bit, and no flow control.
4. Press the **Reset** button on the Rack PDU, then immediately press ENTER twice, or until the Boot Monitor prompt displays: `BM>`
5. Type `XMODEM()`, then press ENTER.
6. From the terminal program's menu, select **XMODEM**, then select the `.nmc3` firmware file to transfer using XMODEM. After the XMODEM transfer is complete, the Boot Monitor prompt returns.
7. Type `reset()` or press the **Reset** button to restart the network management interface.

Use a USB Drive To Transfer and Update Files

Before starting the transfer, make sure the USB drive is formatted in FAT32.

1. Create a folder named **apcfirm** on the USB flash drive.
2. Download the firmware update files and unzip them if needed. Copy the **app.nmc3** firmware file into the **apcfirm** folder.

NOTE: Only use firmware applications intended for your device type and NMC.

3. Use a text editor to create a file named **nmc3.rcf** and save it to the **apcfirm** folder. (The file extension must be `.rcf`, not `.txt` for example.)

Add only the following text to the file: `NMC3=application_name.nmc3`, where `application_name` is filename of the firmware update file.

For example: If the update firmware file is `apc_hw21_rpdu2g_0-0-0-xx.nmc3`, the text file should say `NMC3=apc_hw21_rpdu2g_0-0-0-xx.nmc3`

Save the changes to the `nmc3.rcf` file.

4. Insert the flash drive into a USB port on your Rack PDU.
5. Use the Web UI, the CLI, or the **Reset** button on the front of the Rack PDU to reboot the management interface. Wait for the reboot to finish.
6. Check that the update was completed successfully using the procedures in *Verifying Upgrades and Updates*, page 162.

How To Update Multiple Rack PDUs

Use one of these methods:

- **Firmware Update Utility:** Use this for multiple firmware updates in IPv4 if you have Windows. The Utility records all update steps in a log as a good reference to validate the update. The Utility is included with your firmware download. For more information, see the following:
 - Use the Firmware Update Utility, page 158, or
 - FAQ article FA156099: *How do I perform a mass firmware upgrade on APC network enabled products?* on www.se.com. To find an FAQ article on www.se.com, enter the title or number of the article in the search bar. On the resulting page, select **Faq** to narrow your search results to only FAQ articles.
- **Export configuration settings:** You can create batch files and use the .ini file utility to retrieve configuration settings from multiple Rack PDU and export them to other Rack PDUs. For more information on how to download the .ini file utility,
 - See FAQ article FA156117: *How can I mass configure a Network Management Card (NMC) or NMC embedded product?* on www.se.com. To find an FAQ article on www.se.com, enter the title or number of the article in the search bar. On the resulting page, select **Faq** to narrow your search results to only FAQ articles.
 - Read the release notes (release notes are included with the utility file).
- **Use FTP or SCP to update multiple Rack PDUs:** To update multiple Rack PDUs using an FTP client or using SCP, write a script which automatically performs the procedure.

NOTE: To find an FAQ article, go to www.apc.com/support, select **FAQS** under Resources and Tools, then enter the article number or title in the Search bar.

Use the Firmware Upgrade Utility For Multiple Upgrades

After downloading the Upgrade Utility, double click on the .exe file to run the utility (which ONLY works with IPv4) and follow these steps to upgrade your Rack PDU firmware:

1. Type in an IP address, a user name, and a password.
2. Open the devices.txtfile. This should list any device IP, user name, and password.
3. Select the **Upgrade From Device List** check box to use the *iplist.txt* file.
4. Choose the **Upgrade Now** button to start the firmware version update(s).
5. Choose **View Log** to verify any upgrade.

Upgrade Firmware for Network Port Sharing (NPS) Groups

For an NPS Group, all Rack PDUs in the group must have the same firmware version. Upgrade the host Rack PDU and it will upgrade all guest Rack PDUs automatically. This may take up to 10 minutes.

Verifying Upgrades and Updates

Verify the Success Or Failure of the Transfer

To verify whether a firmware update succeeded, use the `xferStatus` command in the CLI to view the last transfer result, or use an SNMP GET to the `mfiletransferStatusLastTransferResult` OID.

Last Transfer Result Codes

Possible transfer errors include the TFTP or FTP server not being found, or the server refusing access, the server not finding or not recognizing the transfer file, or a corrupt transfer file.

SNMP Return Value	Code	Description
1	Successful	The file transfer was successful.
2	Result not available	There are no recorded file transfers.
3	Failure unknown	The last file transfer failed for an unknown reason.
4	Server inaccessible	The TFTP or FTP server could not be found on the network.
5	Server access denied	The TFTP or FTP server denied access.
6	File not found	The TFTP or FTP server could not locate the requested file.
7	File type unknown	The file was downloaded but the contents were not recognized.
8	File corrupt	The file was downloaded but at least one Cyclical Redundancy Check (CRC) failed.

Verify the Version Numbers of Installed Firmware

Path: About > Network

Use the Web UI to verify the versions of the upgraded firmware modules. You could also use an SNMP GET to the MIB II `sysDescr` OID. In the Command Line Interface, use the **about** command.

Troubleshooting

Rack PDU Access Problems

For problems that persist or are not described here, contact APC by Schneider Electric Customer Care at www.apc.com.

Problem	Solution
After a Network Port Sharing host is updated to new firmware, the guest Rack PDUs show a "firmware version does not match" alarm.	This will be automatically resolved by the host PDU, given time. Events are logged in this order : "Remote RPDU 2 (SN: xxxxxxxxxxxx) firmware version does not match." > "Guest RPDU firmware download started." > "Guest RPDU firmware download completed." > "Remote RPDU 2 (SN: xxxxxxxxxxxx) firmware version alarm has been cleared." > "Remote RPDU 2 (SN: xxxxxxxxxxxx) communication established."
Unable to ping the Rack PDU	If the Rack PDU's Status LED is green, try to ping another node on the same network segment as the Rack PDU. If that fails, it is not a problem with the Rack PDU. If the Status LED is not green, or if the ping test succeeds, perform the following checks: <ul style="list-style-type: none"> • Verify all network connections. • Verify the IP addresses of the Rack PDU and the NMS. • If the NMS is on a different physical network (or subnetwork) from the Rack PDU, verify the IP address of the default gateway (or router). • Verify the number of subnet bits for the Rack PDU's subnet mask.
Cannot allocate the communications port through a terminal program	Before you can use a terminal program to configure the Rack PDU, you must shut down any application, service, or program using the communications port.
Cannot access the Command Line Interface through a serial connection.	Make sure that you did not change the baud rate. Try 2400, 9600, 19200, or 38400. The baud rate can be configured from the NMC with the CLI command: <pre>console -b <baud rate></pre> The default baud rate is 9600.
Cannot access the Command Line Interface remotely	Make sure you are using the correct access method, Telnet or Secure SHell (SSH). The Super User or an Administrator can enable these access methods. By default, Telnet is disabled, and SSH is enabled. SSH and Telnet can be enabled/disabled independently. <ul style="list-style-type: none"> • For SSH, the Rack PDU may be creating a host key. The Rack PDU can take up to one minute to create the host key, and SSH is inaccessible for that time.
Cannot access the Web UI	<ul style="list-style-type: none"> • Verify that HTTP or HTTPS access is enabled. • Make sure you are specifying the correct URL — one that is consistent with the security system used by the Rack PDU. SSL/TLS requires https, not http, at the beginning of the URL. • Verify that you can ping the Rack PDU. • Verify that you are using a Web browser supported for the Rack PDU. • If the Rack PDU has just restarted and SSL/TLS security is being set up, the Rack PDU may be generating a server certificate. The Rack PDU can take up to one minute to create this certificate, and the SSL/TLS server is not available during that time. • Check that the Minimum Protocol setting configured on the Rack PDU for SSL/TLS matches what is enabled or configured in your web browser. <p>NOTE: Check the specific error message reported by the browser. It may indicate the specific problem.</p>
Cannot communicate using Network Port Sharing (NPS)	<ul style="list-style-type: none"> • If you are having communications problems with Network Port Sharing, check that the total length of network cable between up to 32 units is not more than 10 meters.

	<ul style="list-style-type: none"> If you are using Network Port Sharing and do not see one or more of the units in the group, check that all units in the group are using the same firmware revision. Guest PDUs should receive firmware updates from their hosts, but manually updating units that seem to be completely unresponsive to the host's firmware revision may resolve the issue. You can download appropriate firmware revisions from the APC by Schneider Electric website, www.apc.com.
The Rack PDU reports "Component communications lost with Phase Meter" and/or "Communication lost" alarms	Refer to FAQ FA168022 at www.apc.com .
The Rack PDU reports "CAN bus off" alarm	Refer to FAQ FA173637 at www.apc.com .

SNMP Issues

Problem	Solution
Unable to perform a GET	<ul style="list-style-type: none"> Verify the read (GET) community name (SNMPv1) or the user profile configuration (SNMPv3). Use the CLI or Web UI to ensure that the NMS has access.
Unable to perform a SET	<ul style="list-style-type: none"> Verify that SNMP is enabled. SNMPv1 and SNMPv3 are disabled by default. Verify the read/write (SET) community name (SNMPv1) or the user profile configuration (SNMPv3). Use the CLI or Web UI to ensure that the NMS has write (SET) access (SNMPv1) or is granted access to the target IP address through the access control list (SNMPv3).
Unable to receive traps at the NMS	<ul style="list-style-type: none"> Make sure the trap type (SNMPv1 or SNMPv3) is correctly configured for the NMS as a trap receiver. For SNMPv1, query the <code>mconfigTrapReceiverTable</code> MIB OID to verify that the NMS IP address is listed correctly and that the community name defined for the NMS matches the community name in the table. If either is not correct, use SETs to the <code>mconfigTrapReceiverTable</code> OIDS, or use the CLI or Web UI to correct the trap receiver definition. For SNMPv3, check the user profile configuration for the NMS, and run a trap test.
Traps received at an NMS are not identified	See your NMS documentation to verify that the traps are properly integrated in the alarm/trap database.

Download Log Files to a USB Flash Drive

1. Insert a USB Flash drive to the USB port on the Display Interface of the Rack PDU. Before starting the transfer, make sure the USB drive is formatted in FAT32.
2. Scroll to **Log to Flash** on the Display Screen and press the **Select** button.
3. Press the **Select** button again to export the Log files to your Flash drive.
4. You may abort the download by pressing the **Select** button at any time during the download process.

NOTE: If a debug.txt file or a dump.txt file does not exist on the Rack PDU, it cannot be downloaded to the USB Flash drive. These files are only created following an unexpected system crash or a Network Management Card (NMC) reset. The debug.txt and dump.txt files are used for technical support only.

Source Code Copyright Notice

cryptlib copyright Digital Data Security New Zealand Ltd 1998.

Copyright © 1990, 1993, 1994 The Regents of the University of California. All rights reserved.

This code is derived from software contributed to Berkeley by Mike Olson.

Redistribution and use in source and binary forms, with or without modification, are permitted provided the following conditions are met:

1. Redistributions of source code must retain the above copyright notice, this list of conditions and the following disclaimer.
2. Redistributions in binary form must reproduce the above copyright notice, this list of conditions and the following disclaimer in the documentation and/or other materials provided with the distribution.
3. All advertising materials mentioning features or use of this software must display the following acknowledgment: This product includes software developed by the University of California, Berkeley and its contributors.
4. Neither the name of the University nor the names of its contributors may be used to endorse or promote products derived from this software without specific prior written permission.

THIS SOFTWARE IS PROVIDED BY THE REGENTS AND CONTRIBUTORS "AS IS" AND ANY EXPRESS OR IMPLIED WARRANTIES, INCLUDING, BUT NOT LIMITED TO, THE IMPLIED WARRANTIES OF MERCHANTABILITY AND FITNESS FOR A PARTICULAR PURPOSE ARE DISCLAIMED. IN NO EVENT SHALL THE REGENTS OR CONTRIBUTORS BE LIABLE FOR ANY DIRECT, INDIRECT, INCIDENTAL, SPECIAL, EXEMPLARY, OR CONSEQUENTIAL DAMAGES (INCLUDING, BUT NOT LIMITED TO, PROCUREMENT OF SUBSTITUTE GOODS OR SERVICES; LOSS OF USE, DATA, OR PROFITS; OR BUSINESS INTERRUPTION) HOWEVER CAUSED AND ON ANY THEORY OF LIABILITY, WHETHER IN CONTRACT, STRICT LIABILITY, OR TORT (INCLUDING NEGLIGENCE OR OTHERWISE) ARISING IN ANY WAY OUT OF THE USE OF THIS SOFTWARE, EVEN IF ADVISED OF THE POSSIBILITY OF SUCH DAMAGE.

Radio Frequency Interference

USA—FCC

This equipment has been tested and found to comply with the limits for a Class A digital device, pursuant to part 15 of the FCC Rules. these limits are designed to provide reasonable protection against harmful interference when the equipment is operated in a commercial environment. This equipment generates, uses, and can radiate radio frequency energy and, if not installed and used in accordance with this user manual, may cause harmful interference to radio communications. Operation of this equipment in a residential area is likely to cause harmful interference. The user will bear sole responsibility for correcting such interference.

Canada—ICES

This Class A digital apparatus complies with Canadian ICES-003.

Cet appareil numérique de la classe A est conforme à la norme NMB-003 du Canada

APC
70 Mechanic Street
02035 Foxboro, MA
USA

www.se.com

As standards, specifications, and designs change from time to time, please ask for confirmation of the information given in this publication.

© 2021 - 2024 **Schneider Electric**. All Rights Reserved.

990-6302E-001