

User guide

EM32DX / EM32DX-A / EM13DX

The colour and the appearance may differ depending on the product, and the content in the manual is subject to change without prior notice to improve the performance.

An administration fee may be charged in the following situations:

- (a) An engineer is called out at your request, but it is found that the product has no defect (i.e., where the user manual has not been read).
- (b) You bring the unit to a repair centre, but it is found that the product has no defect (i.e., where the user manual has not been read).

You will be informed of the administration fee amount before a technician visits.

Table of contents

Before Using the Product

| | |
|-------------------------------------|---|
| Safety Precautions | 3 |
| Safety symbols | 3 |
| Electricity and Safety | 4 |
| Installation | 5 |
| Operation | 6 |
| Precautions when handling the panel | 8 |
| Cleaning | 8 |

| | |
|-------------------------|---|
| Storage and Maintenance | 9 |
|-------------------------|---|

Preparations

| | |
|-------------------------|----|
| Checking the Components | 10 |
|-------------------------|----|

| | |
|------------------------------|----|
| Parts | 11 |
| Status indicator description | 16 |
| Anti-theft Lock | 19 |

| | |
|--|----|
| Before Installing the Product (Installation Guide) | 20 |
| Using the packaging materials to create a temporary stand (EM32DX, EM32DX-A models only) | 20 |
| Tilting Angle and Rotation (EM32DX, EM32DX-A models) | 20 |
| Tilting Angle and Rotation (EM13DX models) | 21 |

| | |
|---|----|
| Installing the Wall Mount | 22 |
| Preparing before installing Wall-Mount | 22 |
| Installing the Wall Mount | 22 |
| Wall Mount Kit Specifications (VESA) | 23 |
| Mounting the product using a wire (EM32DX, EM32DX-A models) | 24 |
| Mounting the product using a wire (EM13DX models) | 26 |

Network

| | |
|-------------------------|----|
| Network Setting (Wired) | 28 |
|-------------------------|----|

| | |
|----------------------------------|----|
| Network Settings (Wireless) | 28 |
| Connecting to a Wireless Network | 28 |

Troubleshooting Guide

| | |
|--|----|
| Requirements Before Contacting Samsung Customer Service Centre | 29 |
| Check the followings. | 29 |

Specifications

| | |
|---------|----|
| General | 32 |
|---------|----|

Appendix

| | |
|--|----|
| Responsibility for the Pay Service (Cost to Customers) | 34 |
| Not a product defect | 34 |
| A Product damage caused by customer's fault | 34 |
| Others | 34 |

| | |
|------------------------|----|
| Connecting the battery | 35 |
|------------------------|----|

| | |
|------|----|
| OOBE | 35 |
|------|----|

| | |
|---------------------------|----|
| Installing the mobile app | 35 |
|---------------------------|----|

| | |
|---|----|
| Playing picture files by connecting a USB | 36 |
|---|----|

| | |
|----------------------------|----|
| E-Paper product guidelines | 37 |
|----------------------------|----|

| | |
|----------------------------|----|
| Open Source License Notice | 37 |
|----------------------------|----|





Chapter 01







Before Using the Product

Safety Precautions

The following safety instructions are to ensure your personal safety and prevent property damage. Please read the following to ensure the proper use of the product.

Safety symbols







| Symbol | Name | Meaning |
|---|-------------|--|
|  | Warning | A serious or fatal injury may result if instructions are not followed. |
|  | Caution | Personal injury or damage to properties may result if instructions are not followed. |
|  | Prohibition | Do NOT attempt. |
|  | Instruction | Follow directions. |

| CAUTION | | | |
|---|--|---|--|
| RISK OF ELECTRIC SHOCK. DO NOT OPEN. | | | |
| CAUTION: TO REDUCE THE RISK OF ELECTRIC SHOCK, DO NOT REMOVE COVER (OR BACK). THERE ARE NO USER SERVICEABLE PARTS INSIDE. REFER ALL SERVICING TO QUALIFIED PERSONNEL. | | | |
|  | This symbol indicates that high voltage is present inside. It is dangerous to make any kind of contact with any internal part of this product. |  | AC voltage: Rated voltage marked with this symbol is AC voltage. |
|  | This symbol indicates that this product has included important literature concerning operation and maintenance. |  | DC voltage: Rated voltage marked with this symbol is DC voltage. |
|  | Class II product: This symbol indicates that a safety connection to electrical earth (ground) is not required. If this symbol is not present on a product with a mains lead, the product MUST have a reliable connection to protective earth (ground). |  | Caution. Consult instructions for use: This symbol instructs the user to consult the user manual for further safety related information. |





Electricity and Safety

 The following images are for reference only. Real-life situations may differ from what is shown in the images.

Warning









-  **Do not touch the power plug with wet hands.**
Otherwise, an electric shock may result.
-  **Do not bend or pull the power cord with force. Be careful not to leave the power cord under a heavy object.**
Product failure, an electric shock or fire may result from a damaged cable.
-  **Do not connect multiple products to a single power socket.**
Overheated power sockets may cause a fire.
-  **Insert the power plug all the way in so it is not loose.**
An unsecure connection may cause a fire.
-  **Clean any dust around the pins of the power plug or the power socket with a dry cloth.**
A fire may result.
-  **Connect the power plug to a grounded power socket. (Except for devices that do not provide grounding)**
An electric shock or injury may result.
-  **Do not use a damaged power plug or a loose power socket.**
An electric shock or fire may result.

Caution

-  **Hold the plug when disconnecting the power cord from the power socket.**
An electric shock or fire may result.
-  **When connecting the power plug to the port, be sure to connect it completely.**
If the power plug is not completely connected to the port, the plug may be unexpectedly disconnected, or there is a risk of overheating due to overcurrent, leading to safety accidents.
-  **Only use the power cord provided with your product by Samsung. Do not use the power cord with other products.**
An electric shock or fire may result.
-  **Keep the power socket where the power cord is connected unobstructed.**
When a problem occurs with the product, the power cord must be unplugged to completely cut off power to the product. Note that the product is not completely powered down by using only the power button on the remote.
-  **Do not disconnect the power cord while the product is being used.**
The product may become damaged by an electric shock.

Installation



Warning

-  Always use both hands to handle the product to avoid the risk of dropping or applying excessive pressure, which may cause damage.
-  Before moving the product, turn off the power switch and disconnect the power cord and all other connected cables.
Damage to the cable may cause a fire or electric shock.
-  When installing the product, keep it at a distance from the wall so that it is well ventilated.
An increased internal temperature may cause a fire.
-  Do not install the product in a poorly ventilated space such as bookcase or closet.
An increased internal temperature may cause a fire.
-  Keep the plastic packaging out of the reach of children.
Children's misuse of the plastic packaging may cause suffocation.
-  Do not install the power cord (DC power supply) and the product near heat sources.
(Candles, mosquito repellents, cigarettes, sprays, heating devices, places exposed to direct sunlight, and more)
-  When installing the product, fix it firmly so that it does not fall.
If the product is not fixed firmly and a child touches the product while playing, the product may fall, causing damage to the product or injury to the child.
-  Do not install the product in a kitchen or near a kitchen counter.
Edible oil or oil vapor can damage or deform the product.
-  Have a technician install the wall-mount hanger.
Installation by an unqualified person can result in an injury. Only use approved cabinets.

-  If the product is installed in an unusual location, the surrounding environment may cause a serious quality problem. Therefore, be sure to contact Samsung Customer Service Centre before installation.















(Places where many fine dusts are generated, places where chemicals are used, places with too high or low temperatures, places with a lot of moisture or water, transportation equipment such as vehicles, airports and stations used continuously for a long time, and more)

Caution











-  Do not drop the product while moving.
The product may fall, causing personal injury or product damage.
-  Do not lay down the product on its front.
The screen may become damaged.
-  Prolonged exposure to direct sunlight may discolour the surface of the screen display.



Operation

Warning

-  If the product generates a strange noise, a burning smell, or smoke, unplug the power plug immediately and contact your Samsung Customer Service Centre.
An electric shock or fire may result.
-  Keep the remote control batteries and the small accessories out of the reach of children. Ensure children do not swallow any of them.
If children have had the battery in their mouths, consult your doctor immediately.
-  If the product is dropped or its appearance is damaged, turn off the power switch and disconnect the power cord. Then contact Samsung Customer Service Centre.
Continued use can result in an electric shock or a fire.
-  Do not move the product by pulling the power cord or any cable.
Product failure, an electric shock or fire may result from a damaged cable.
-  Ensure the vents are not blocked by tablecloths or curtains.
An increased internal temperature may cause a fire.
-  Do not apply an impact to the product.
 - The screen display may be damaged.
 - An electric shock or fire may result.
-  Do not insert metallic objects (chopsticks, coins, hairpins, etc) or objects that burn easily (paper, matches, etc) into the product (through the vent or input/output ports, etc).
 - If foreign substances enter the product, be sure to power off the product and disconnect the power cord. Then contact Samsung Customer Service Centre.
 - Product failure, an electric shock or fire may result.
-  Do not place objects containing liquid (vases, pots, bottles, etc) or metallic objects on top of the product.
 - If foreign substances such as water enter the product, be sure to disconnect the power cord. Then contact Samsung Customer Service Centre.
 - Product failure, an electric shock or fire may result.
-  During a lightning or thunderstorm, power off the product and disconnect the power cord.
An electric shock or fire may result.
-  Do not leave heavy objects or items that children like (toys, sweets, etc.) on top of the product.
The product or heavy objects may fall as children try to reach for the toys or sweets resulting in a serious injury.
-  Do not hang on or climb on the product.
 - The product may fall, causing personal injury or even death.
 - Be especially careful that children do not hang on or climb on the product.
-  While the power plug is plugged into a power socket, do not insert a chopstick or other conductor into a remaining power socket. Also, after disconnecting the power plug from the power socket, do not touch the pins of the plug immediately.
Otherwise, an electric shock may result.
-  There is a high voltage inside the product. Never disassemble, repair or modify the product yourself.
 - Contact Samsung Customer Service Centre for repairs.
 - An electric shock or fire may result.
-  If a gas leakage is found, do not touch the product or the power plug, and ventilate the room immediately.
Sparks can cause an explosion or fire.
-  Do not use humidifiers or stoves around the product.
An electric shock or fire may result.

Caution

-  **Insert each battery so that its polarity (+, -) is correct.**
If the polarity is not correct, the battery may rupture or the internal fluid may leak, causing contamination and damage to the surroundings, fire, or personal injury.
-  **Do not place heavy objects on the product.**
Product failure or personal injury may result.
-  **When you do not use the product for a long time due to vacation or other reason, disconnect the power cord from the power socket.**
Dust accumulation combined with heat can cause a fire, electric shock or electric leakage.
-  **Use the product at the recommended resolution and frequency.**
Your eyesight may deteriorate.
-  **The batteries (and rechargeable batteries) are not ordinary refuse and must be returned for recycling purposes. The customer is responsible for returning the used or rechargeable batteries for recycling.**
The customer can return used or rechargeable batteries to a nearby public recycling centre or to a store selling the same type of the battery or rechargeable battery.
-  **Rest your eyes for more than 5 minutes for every 1 hour of product use.**
Eye fatigue will be relieved.
-  **Leaving the screen fixed on a stationary image for an extended period of time may cause afterimage burn-in or defective pixels.**
When you do not use the product for a long time, activate power-saving mode or set the screen saver to moving-picture mode.
-  **Do not use or keep combustible spray or an inflammable substance near the product.**
An explosion or fire may result.
-  **Use only the specified standardised batteries, and do not use a new battery and a used battery at the same time.**
Otherwise, the batteries may be damaged or cause fire, personal injury or damage due to a leakage of the internal liquid.
-  **Do not watch the product screen too closely and continuously for a long time.**
Your eyesight may deteriorate.

-  **Do not lift or move the product when it is in operation.**
-  **Do not touch the screen when the product has been turned on for an extended period of time as it will become hot.**
-  **When using headphones or earphones, do not turn the volume too high or use them for a long time.**
Damage to your hearing may result.

Precautions when handling the panel

 The colour and the appearance may differ depending on the model.

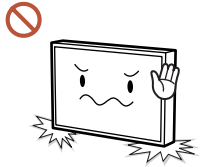

Do not stand the product as shown in the image. The panel is fragile and can get damaged.

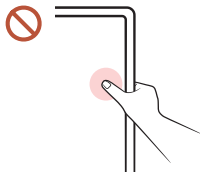

Do not hold the product by the display screen.

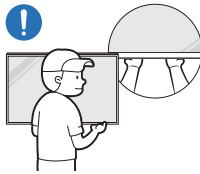

Always use both hands to handle the product.

Cleaning

Warning



Do not spray water or cleaner directly on the product.

- The product's surface may be damaged, or the markings may be erased.
- An electric shock or fire may result.

Caution



When cleaning, be sure to disconnect the power plug and wipe gently with a soft and dry cloth such as superfine fibers or cotton flannels to prevent scratches.

The product's surface may be damaged, or the markings may be erased.



Be sure to use a soft and dry cloth such as superfine fibers or cotton flannels because the surface of the product and the screen display are vulnerable to scratches.

The product's surface or the screen display can be easily scratched with foreign substances.



Do not apply chemicals containing alcohol, solvent, or surfactant such as wax, benzene, thinner, pesticide, air freshener, lubricant, or cleaner to the product.

The product's exterior may be discoloured or cracked, the surface of the panel may be peeled off, or the markings may be erased.

Storage and Maintenance

Cleaning the exterior and display

Wipe the surface with a slightly wet, soft cloth, and then wipe with a dry cloth.

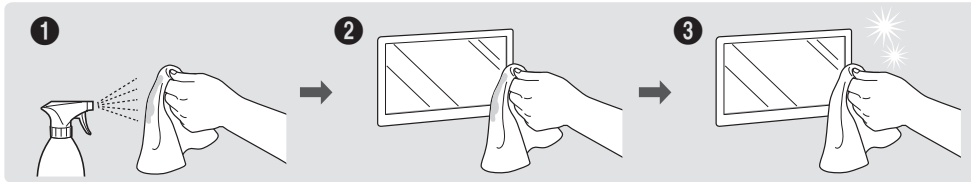

Precautions

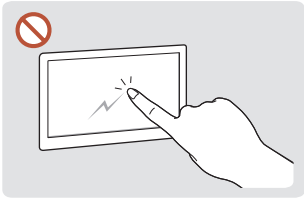

Do not scratch the screen with nails or sharp objects. Scratches may leave marks or damage the product.

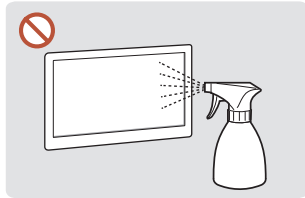

Do not spray water directly on any part of the product. Product failure, an electric shock or fire may result from water that enters the product.

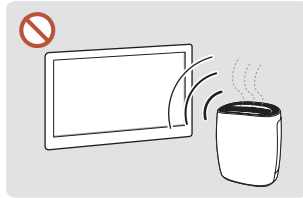

Due to the characteristics of high-glossy products, using a UV humidifier nearby may create white-coloured stains on the product.

- Removing a sticker attached on the screen may leave residues. Clean the residues before watching the screen.
- Do not strongly press and rub the product. Damage to the product may result.
- Do not wipe the screen with chemicals. Product failure may result.
- Contact Samsung Customer Service Centre if the inside of the product needs cleaning (service fee will be charged).
- We recommend wearing clean gloves when touching the front panel instead of bare hands.

Chapter 02

Preparations

Checking the Components

 Contact the vendor where you purchased the product if any components are missing.

 The appearance of the components may differ from the images shown.

 A stand is not provided with the product. To install a stand, you can purchase one separately. (EM32DX, EM32DX-A models only)



Simple User Guide



Warranty card
(Not available in some locations)



Regulatory guide



Battery (EM32DX models only)



USB Charger



USB-C cable

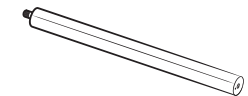

Stand (2)
(EM13DX)

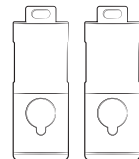

Wire bracket (2)
(EM32DX, EM32DX-A)



Wire holder (2)
(EM32DX, EM32DX-A)

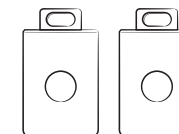

Wire bracket (2)
(EM13DX)



Wire holder (2)
(EM13DX)

Parts

EM32DX

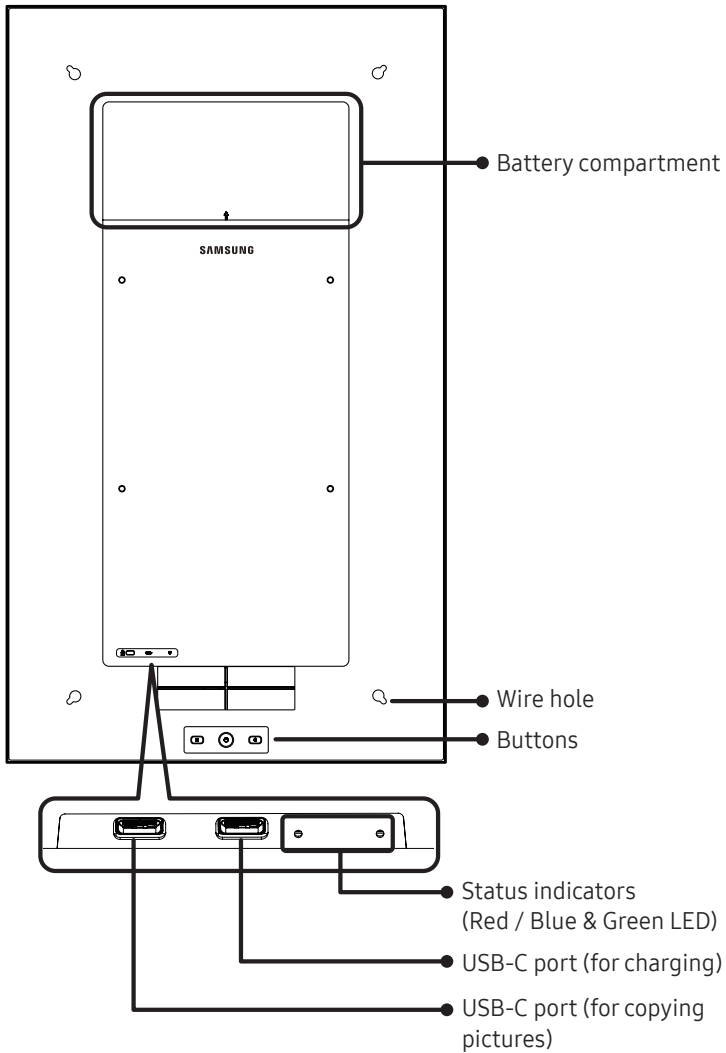

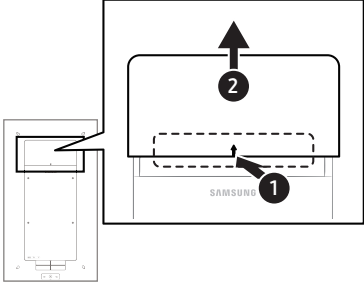

The colour and shape of parts may differ from what is shown. Specifications are subject to change without notice to improve quality.

| Parts | Description |
|---------------------|---|
| Battery compartment | <p>You can install the provided battery to use the product cordlessly.</p> <ul style="list-style-type: none"> Once you install the battery for the first time, you must connect the charger to activate and use it to power the product. Connect the charger to the product if you are going to use a mobile app or VXT. <p>Installing the battery</p>  <ul style="list-style-type: none"> Press and slide the battery cover to open. Then, install the battery. <ul style="list-style-type: none"> Press the area approximately 5 cm to the left and right of the arrow mark in the center of the battery cover. When removing the battery cover, lay the set face down on a flat surface. When you install the battery for the first time, you must connect the charger to activate it. The battery is shipped with approximately 30% charge. To use the product without the charger, fully charge the battery first. |
| Wire hole | <p>You can attach the provided wire holder and wire bracket and mount the product with a wire.</p> |

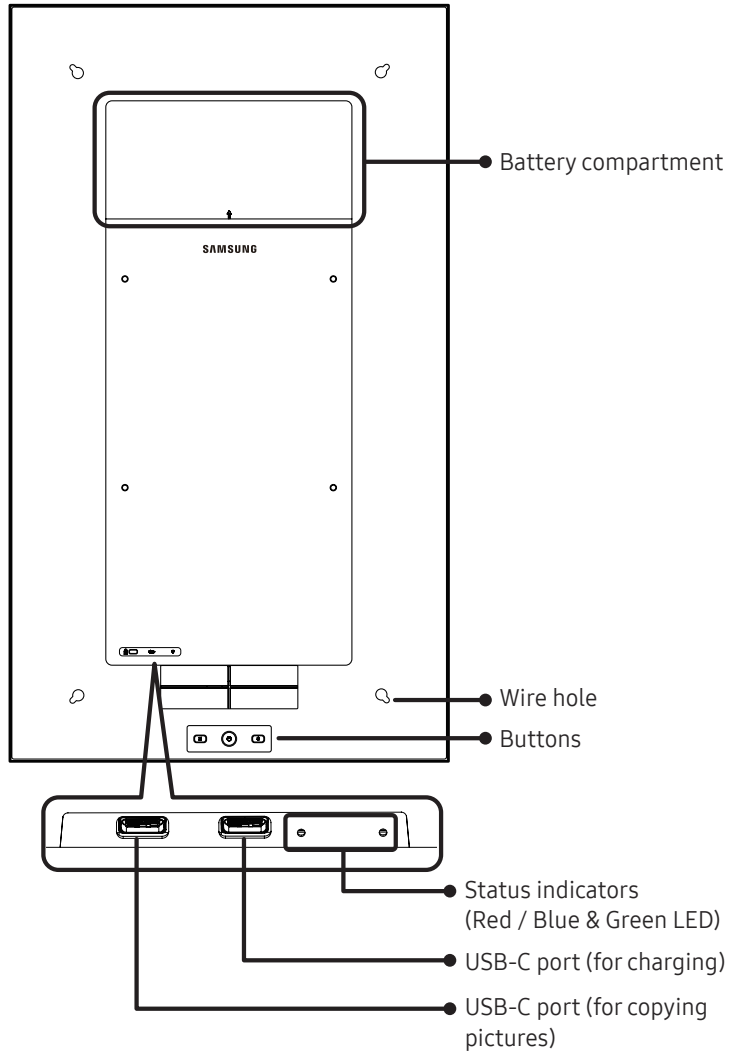
EM32DX-A





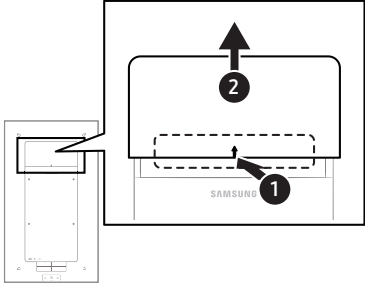

 The colour and shape of parts may differ from what is shown. Specifications are subject to change without notice to improve quality.

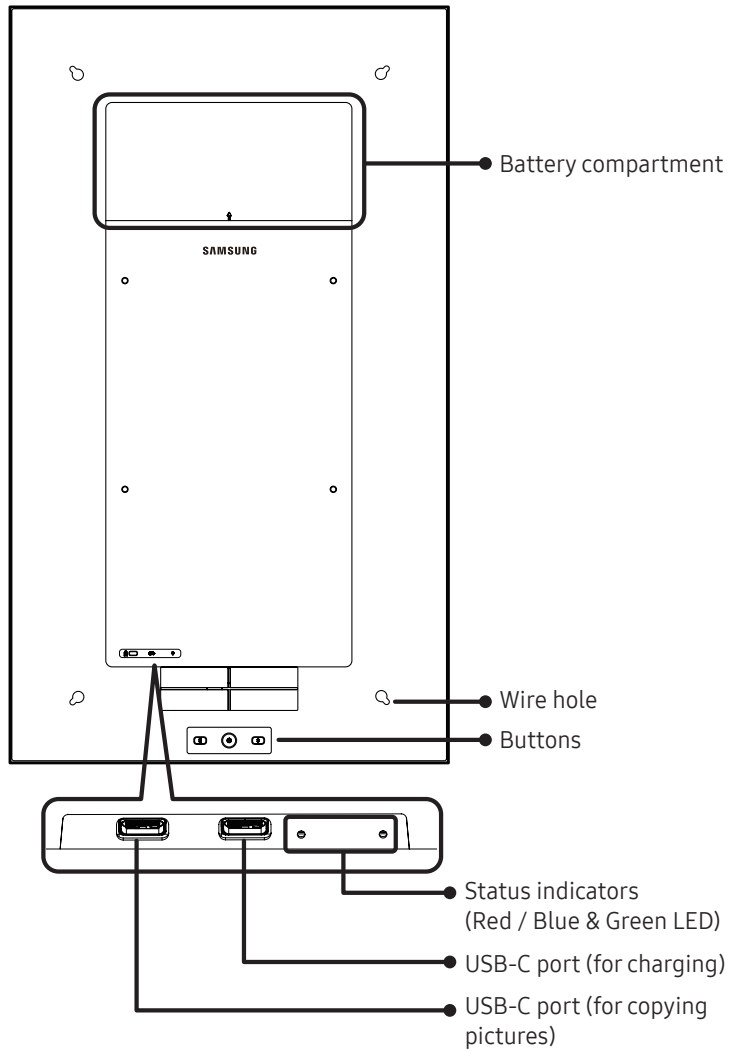
| Parts | Description |
|---------------------|--|
| Battery compartment | <p> Connect the charger to the product if you are going to use a mobile app or VXT.</p> <p>Remove or replace the installed battery</p> <p>You can remove or replace the installed battery by following the steps below.</p>  <ul style="list-style-type: none"> Press and slide the battery cover to open. Then, remove or replace the installed the battery. <ul style="list-style-type: none"> Press the area approximately 5 cm to the left and right of the arrow mark in the center of the battery cover. When removing the battery cover, lay the set face down on a flat surface. The battery is shipped with approximately 30% charge. To use the product without the charger, fully charge the battery first. |
| Wire hole | <p>You can attach the provided wire holder and wire bracket and mount the product with a wire.</p> |

EM32DX / EM32DX-A



| Parts | Description | |
|-----------------------------------|---|--|
| Buttons |  | Press the button to turn on the product, or wake up the product in the sleep mode. |
| | Power | Press and hold the button for 2 seconds to turn off the product. <ul style="list-style-type: none"> When the product is off, the screen becomes white. |
| |  | Press the button to move to the next picture. |
| | Mode | Press and hold the button to switch between the Auto and Manual mode. <ul style="list-style-type: none"> The Manual mode is the default setting. In the Auto mode, the default content change interval is 4 hours. |
| Buttons |  | Press and hold the button to enter the Bluetooth pairing mode. |
| | Press and hold the  and  buttons for 5 seconds to reset the product. | |
| USB-C port (for copying pictures) | <p>You can connect a USB memory device to copy pictures to the product's internal storage.</p> <ul style="list-style-type: none"> Create a 'SAMSUNG_E-Paper' folder in your USB and save picture files in the folder. Then, connect the USB to this port to copy the files into the product's internal storage. The optimized resolution for the picture files is 1440 x 2560. Compatible image file format: BMP, JPG, JPEG, PNG The thickness of the USB memory device must be below 7 mm. | |
| USB-C port (for charging) | You can connect a USB-C charger to supply power. | |
| Status indicators | <p>Two LED indicators display operation status. (Red / Blue & Green LED)</p> <ul style="list-style-type: none"> Refer to the "Status indicator description" section for details. | |



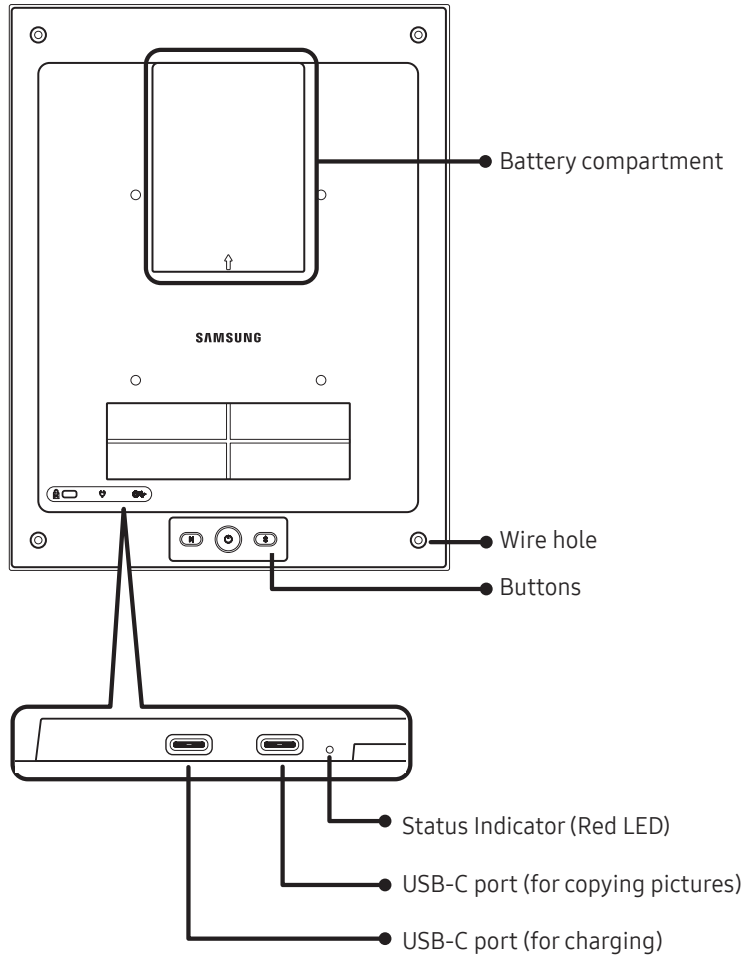

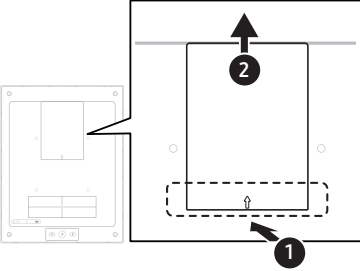

EM13DX

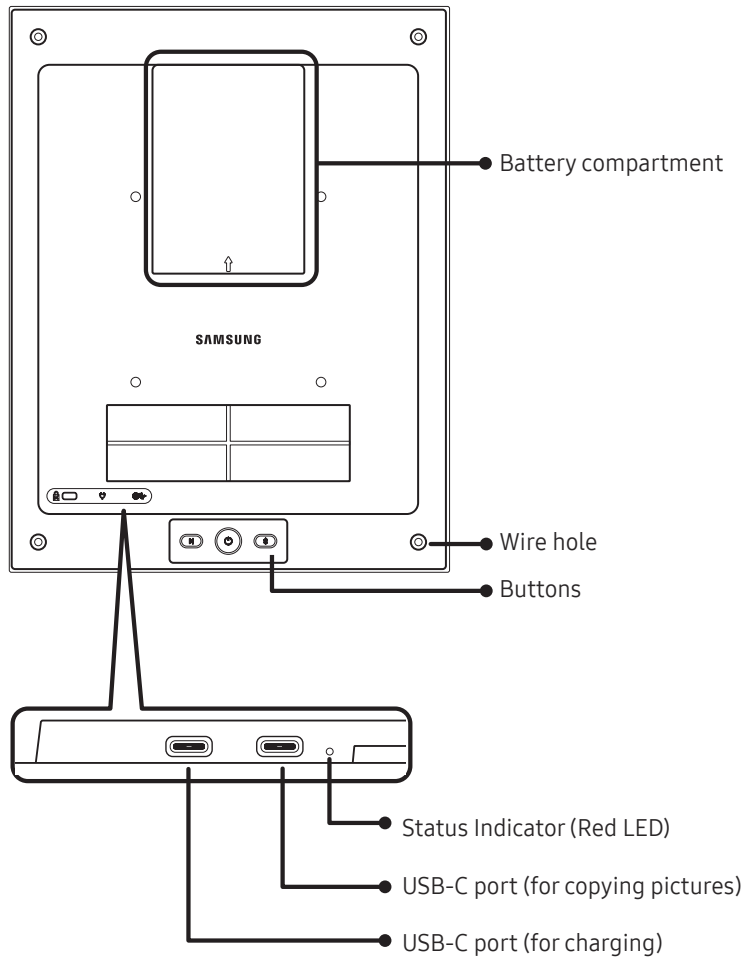

The colour and shape of parts may differ from what is shown. Specifications are subject to change without notice to improve quality.

| Parts | Description |
|----------------------------|---|
| <p>Battery compartment</p> | <p> Connect the charger to the product if you are going to use a mobile app or VXT.</p> <p>Remove or replace the installed battery</p> <p>You can remove or replace the installed battery by following the steps below.</p>  <ul style="list-style-type: none"> • Press and slide the battery cover to open. Then, remove or replace the installed the battery. <ul style="list-style-type: none"> – Press the area approximately 5 cm to the left and right of the arrow mark in the center of the battery cover. – When removing the battery cover, lay the set face down on a flat surface. • The battery is shipped with approximately 30% charge. To use the product without the charger, fully charge the battery first. |
| <p>Wire hole</p> | <p>You can attach the provided wire holder and wire bracket and mount the product with a wire.</p> |



| Parts | Description | |
|-----------------------------------|---|---|
| Buttons |  Power | Press the button to turn on the product, or wake up the product in the sleep mode. Press and hold the button for 2 seconds to turn off the product. <ul style="list-style-type: none"> When the product is off, the screen becomes white. |
| |  Mode | Press the button to move to the next picture. Press and hold the button to switch between the Auto and Manual mode. <ul style="list-style-type: none"> The Manual mode is the default setting. In the Auto mode, the default content change interval is 4 hours. |
| |  Bluetooth | Press and hold the button to enter the Bluetooth pairing mode. |
| |  Press and hold the  and  buttons for 5 seconds to reset the product. | |
| USB-C port (for charging) | You can connect a USB-C charger to supply power. | |
| USB-C port (for copying pictures) | You can connect a USB memory device to copy pictures to the product's internal storage. <ul style="list-style-type: none"> Create a 'SAMSUNG_E-Paper' folder in your USB and save picture files in the folder. Then, connect the USB to this port to copy the files into the product's internal storage. The optimized resolution for the picture files is 1200 x 1600. Compatible image file format: BMP, JPG, JPEG, PNG  The thickness of the USB memory device must be below 7 mm. | |
| Status indicators | LED indicators displays operation status. <ul style="list-style-type: none"> Refer to the "Status indicator description" section for details. | |

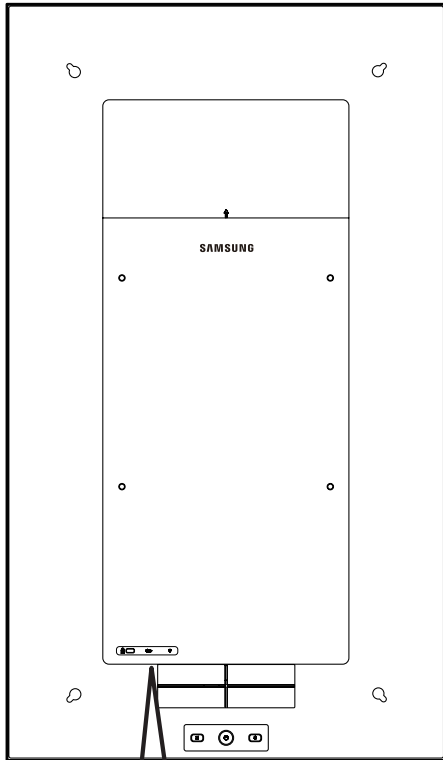

Blue and Green LED

Red LED

Status indicator description

| Parts | LED Status | Description |
|-------|--|---|
| Red | On | Charging in progress. |
| | Off | Charging complete. |
| | Blinks | The charger is connected without the battery installed. |
| Blue | On (3 seconds) | Bluetooth pairing has been completed. |
| | Blinks (0.25-second interval) | The product is waiting for the Bluetooth pairing. |
| Green | On | Copying pictures from the USB memory device. |
| | Blinks (0.5-second interval) | The product is turning on. |
| | Blinks (0.25-second interval for 2 seconds) | Switching between Auto to Manual mode. |
| | Blinks (0.25 second, 0.75 second) | Software update in progress. |

EM13DX

Front

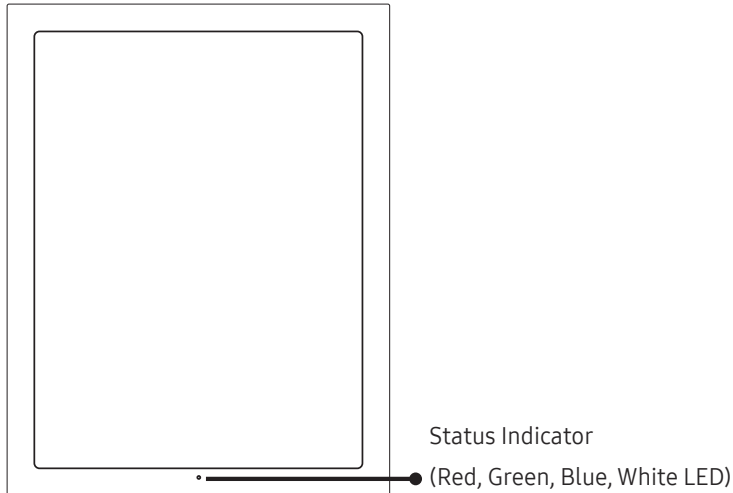

Status indicator description

| Color | LED Status | Description |
|-------|---|---|
| Blue | Blinking (at 0.5-second intervals, until Bluetooth standby mode turns off) | Bluetooth standby mode. |
| | On (for 2 seconds) | Bluetooth pairing is complete. |
| Green | Blinking (at 0.5-second intervals, until the operation is complete) | Executing commands. (Other than button input) <ul style="list-style-type: none">Indicates the product is executing commands such as setting change, content download (including USB), custom app download, and switching screens. |
| | On (until the update is complete) | Firmware update in progress. |
| Red | Blinking (at 0.5-second intervals, until the booting is complete) | Switching to Normal mode (= booting) <ul style="list-style-type: none">Also applies when switching from Sleep to Normal mode. |
| | Blinking (at 0.25-second intervals, until the screen completes switching to white) | Powering off by pressing and holding the Power button |
| | On (until the reset is complete) | Factory reset in progress. |
| White | Blinking (at 0.5-second interval for 2 seconds) | Switching from Auto Play to Manual Play. |
| | Blinking (at 0.25-second interval for 2 seconds) | Switching from Manual Play to Auto Play. |
| | On (for 2 seconds) | Skipping to the next content. |

 Multiple LEDs may turn on at the same time to indicate two or more statuses, causing the light to appear as a mixed color.

EM13DX

Rear

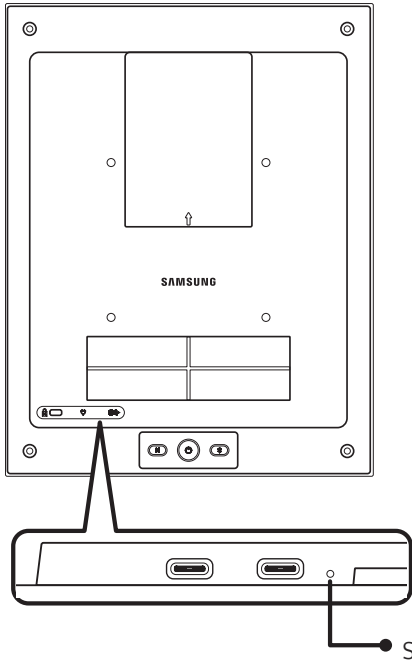

Status Indicator (Red LED)

Status indicator description

| Color | LED Status | Description |
|-------|------------|--|
| Red | Blinking | The charger is connected but no battery is inserted. |
| | On | The battery is charging. |
| | Off | Charging is complete. |

Anti-theft Lock

- ✎ An anti-theft lock allows you to use the product securely even in public places.
- ✎ The locking device shape and locking method depend on the manufacturer. Refer to the user guide provided with your anti-theft locking device for details.
- ✎ The following images are for reference only. Real-life situations may differ from what is shown in the images.
- ✎ When using an anti-theft lock, ensure the product is positioned with enough clearance from the wall to accommodate the lock's thickness.

To lock an anti-theft locking device:

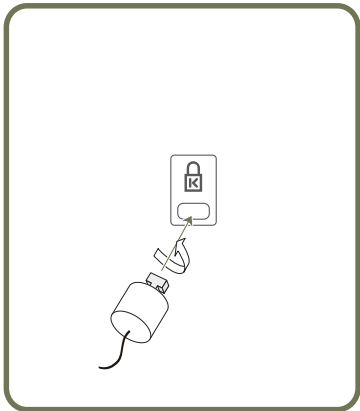

- 1 Fix the cable of your anti-theft locking device to a heavy object such as a desk.
- 2 Put one end of the cable through the loop on the other end.
- 3 Insert the locking device into the anti-theft lock slot at the back of the product.
- 4 Lock the locking device.
 - An anti-theft locking device can be purchased separately.
 - Refer to the user guide provided with your anti-theft locking device for details.
 - Anti-theft locking devices can be purchased at electronics retailers or online.

Before Installing the Product (Installation Guide)

To prevent injury, this apparatus must be securely attached to the floor/wall in accordance with the installation instructions.

- Ensure that an authorised installation company installs the wall mount.
- Otherwise, it may fall and cause personal injury.
- Make sure to install the specified wall mount.

Using the packaging materials to create a temporary stand (EM32DX, EM32DX-A models only)

You can transform the packaging materials to use them as a temporary stand for the product.

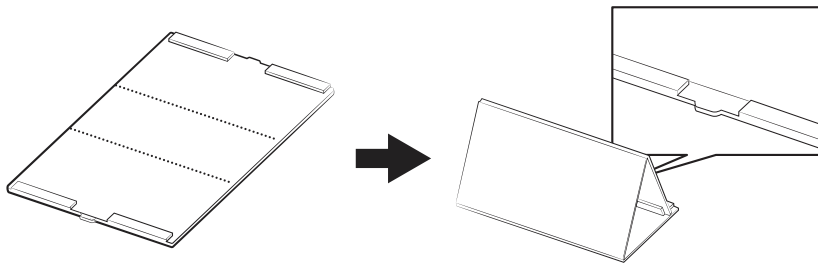

- 1 Fold the packing pad as shown in the figure.

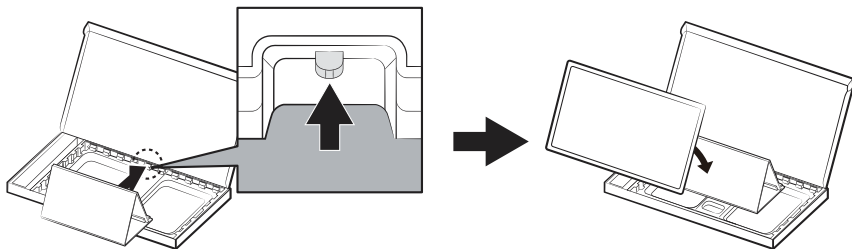

- 2 Insert the tab at the back of the folded packing pad into the slot at the packaging material to secure it.

- 3 Put the product on the stand.

 You must place the product in landscape orientation. If you put the product in portrait orientation may cause damage to the product.

Tilting Angle and Rotation (EM32DX, EM32DX-A models)

 Contact Samsung Customer Service Centre for further details.

- The product can be tilted at a maximum angle of 20° from a perpendicular wall surface.
- To use the product in Portrait mode, ensure the battery cover (A) is positioned at the top, as shown in the images below.

EM32DX / EM32DX-A

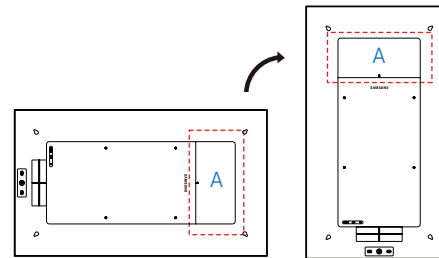

 Do not use this model installed on a ceiling, floor, or table.

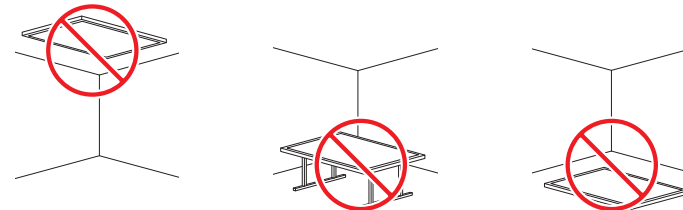

Tilting Angle and Rotation (EM13DX models)

 Contact Samsung Customer Service Centre for further details.

- The product can be tilted from the vertical surface to the angle using the stand.
- To use the product in Portrait mode, ensure the battery cover (A) is positioned at the top, as shown in the images below.

EM13DX

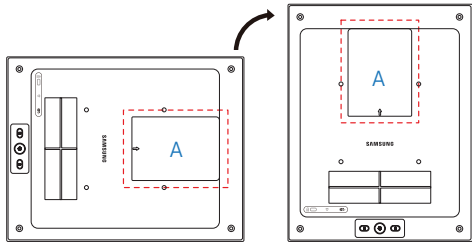

 Do not use this model installed on a ceiling, floor, or table.

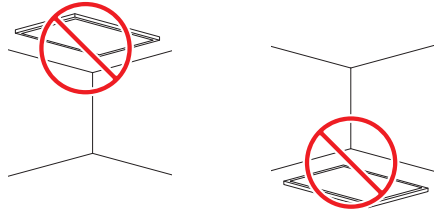

Landscape installation

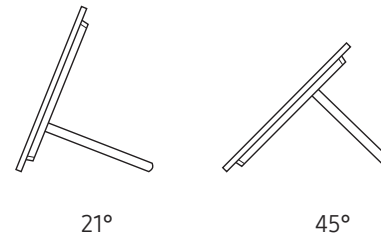

Portrait installation

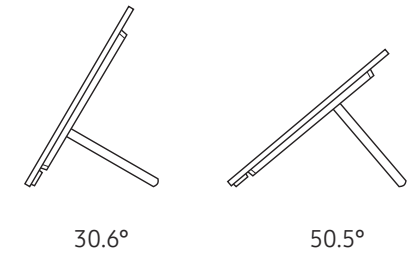

Horizontal installation

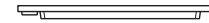

 The rear side of the product must be installed with sufficient clearance from the floor to prevent contact.

Installing the Wall Mount

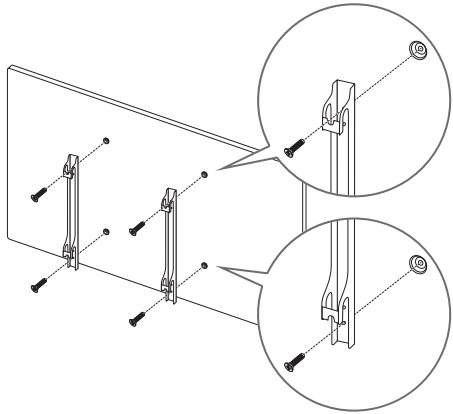

Preparing before installing Wall-Mount

To install a wall mount not made by Samsung, refer to the installation manual provided by the wall mount manufacturer.

Installing the Wall Mount

- The wall mount kit (sold separately) allows you to mount the product on the wall.
- The provided image is only for reference. For detailed information on installing the wall mount, see instructions provided with the wall mount.
- We recommend you contact a technician for assistance when installing the wall mount bracket.
- Samsung is not responsible for any damage to the product or injury to yourself or others if you select to install the wall mount on your own.

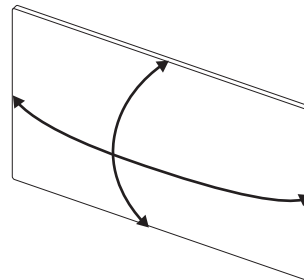

After wall-mount installation, be careful when holding its edges to tilt or swivel it. The product may get damaged if you tilt or swivel it excessively.

Wall Mount Kit Specifications (VESA)

✎ Install your wall mount on a solid wall perpendicular to the floor. To install the product on the other wall area, contact the nearest agency. If you install the product on a slanted wall, it may fall and result in severe personal injury.

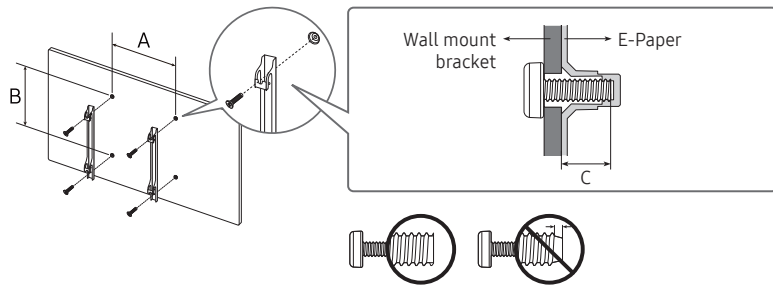

- Do not use screws that are longer than the standard length or do not comply with the VESA standard screw specifications. Screws that are too long may cause damage to the inside of the product.
- For wall mounts that do not comply with the VESA standard screw specifications, the length of the screws may differ depending on the wall mount specifications.
- Do not fasten the screws too firmly. This may damage the product or cause the product to fall, leading to personal injury. Samsung is not liable for these kinds of accidents.
- Samsung is not liable for product damage or personal injury when a non-VESA or non-specified wall mount is used or the consumer fails to follow the product installation instructions.
- Do not mount the product at more than a 20 degree tilt.
- Always have at least two people mount the product on a wall. (Four or more people for the 82-inch size and larger models.)
- Standard dimensions for wall mount kits are shown in the table below.

| Model Name | VESA screw hole specs (A * B) in millimetres | C (mm) | Standard Screw | Quantity |
|------------------|--|--------|----------------|----------|
| EM32DX, EM32DX-A | 200 x 200 | 8 - 10 | M4 | 4 |
| EM13DX | 100 x 100 | 8 - 10 | M4 | 4 |

✎ Do not install your Wall Mount Kit while your product is turned on. It may result in personal injury due to electric shock.

Mounting the product using a wire (EM32DX, EM32DX-A models)

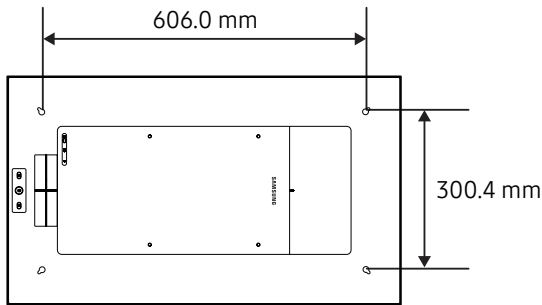

- ⚠ Select a wire that can support four times the weight of the set (10 kg).
- The manufacturer does not guarantee issues caused by customer-installed wires.
- The manufacturer is not responsible for any accidents or injuries resulting from improper mounting or mishandling.

Inserting the wire holder

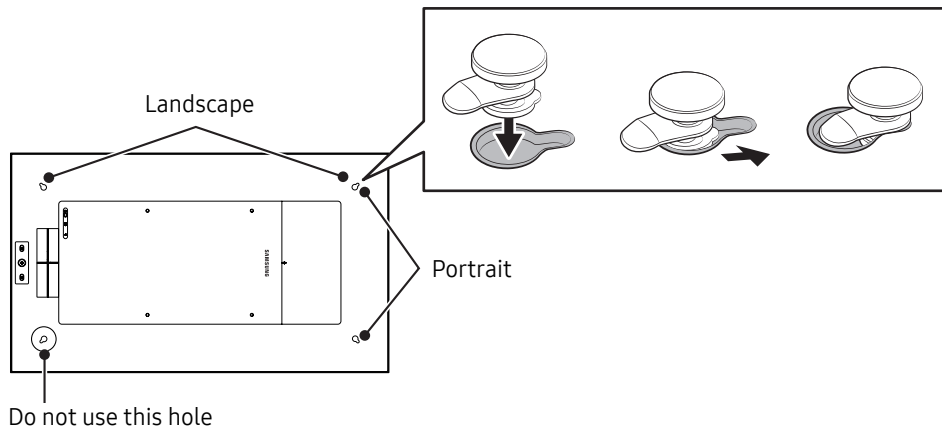

- Attach the two wire holders into the wire holes.
 - Select the appropriate wire holes based on the desired orientation (landscape or portrait).

- After inserting the wire holder into the hole, push it until you hear a clicking sound.
- Ensure the wire holders are firmly attached.

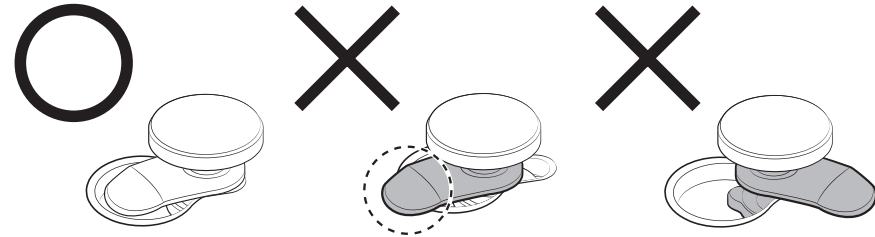

- ⚠ Insert the wire holder correctly as shown in the figure.
 - You must insert the bottom part of the wire holder into the hole.
 - The wire holder's tab must not protrude out of the hole area.

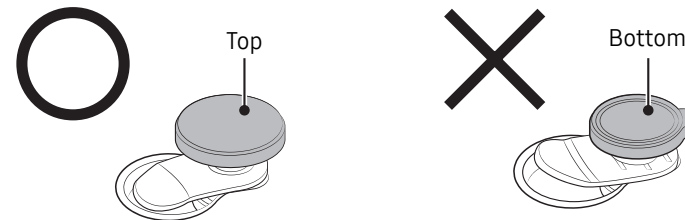

- ⚠ Insert the wire holder correctly as shown in the figure. You must insert the bottom part of the wire holder into the hole.

Removing the wire holder

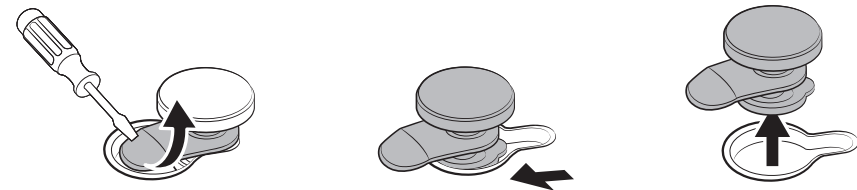

Use a tool to pry the tab out of the hole area. Then, remove the wire holder in the reverse order of insertion.

Hanging the product on the wall

Using a wire and a nail, you can hang the product on the wall.

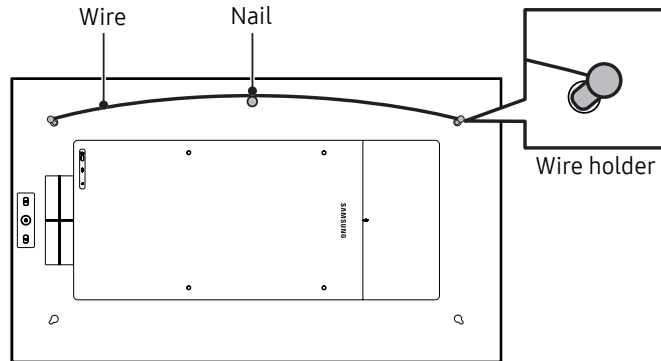

Attach a wire to the wire holders. Then, hang the wire on the nail securely fastened to the wall. Ensure the wire is securely fixed to the holder to prevent it from slipping.

Hanging the product from the ceiling

Using a wire with a hook, you can hang the product from the ceiling.

- ⚠ Hanging the product with a wire bracket directly to screws or nails may cause damage to the product.
- Select a wire that can support four times the weight of the set (10 kg).
- The manufacturer does not guarantee issues caused by customer-installed wires.

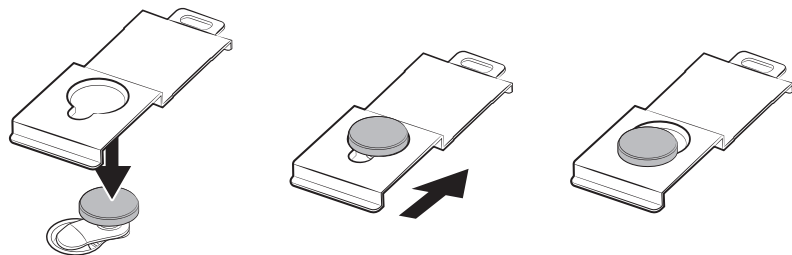

- 1 Attach each wire bracket to the wire holder until it locks securely.
 - Ensure each wire bracket is firmly attached to the wire holder.

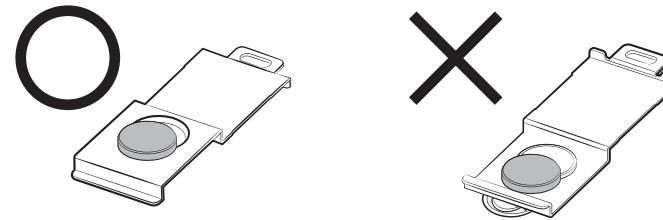

⚠ Make sure to attach the wire bracket in the correct direction.

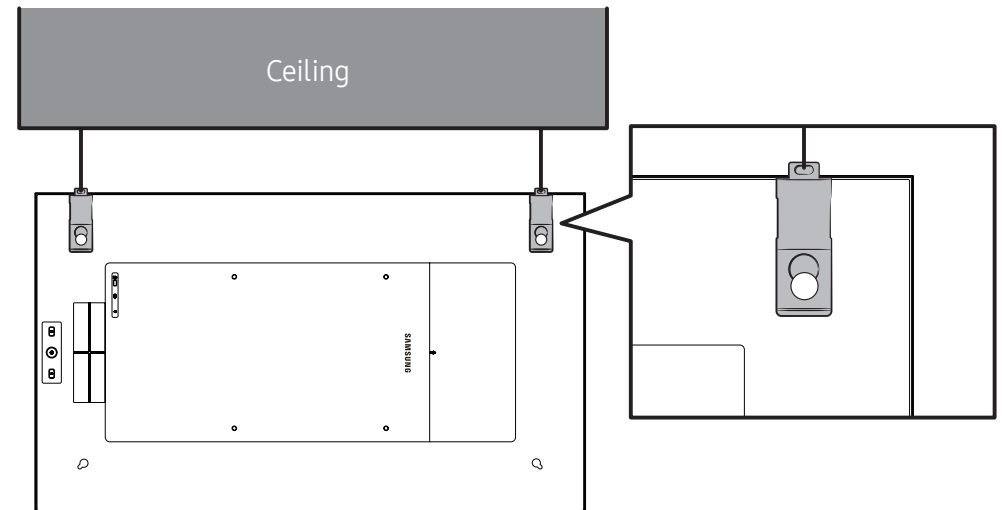

- 2 Hook the wire onto the bracket to secure the product.

Mounting the product using a wire (EM13DX models)

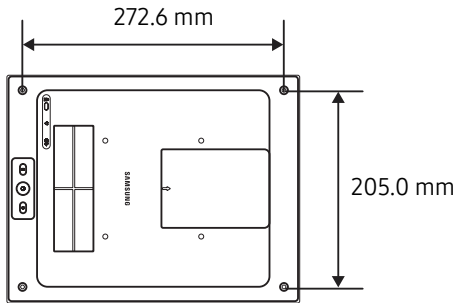

- Select a wire that can support four times the weight of the set (10 kg).
- The manufacturer does not guarantee issues caused by customer-installed wires.
- The manufacturer is not responsible for any accidents or injuries resulting from improper mounting or mishandling.

Inserting the wire holder

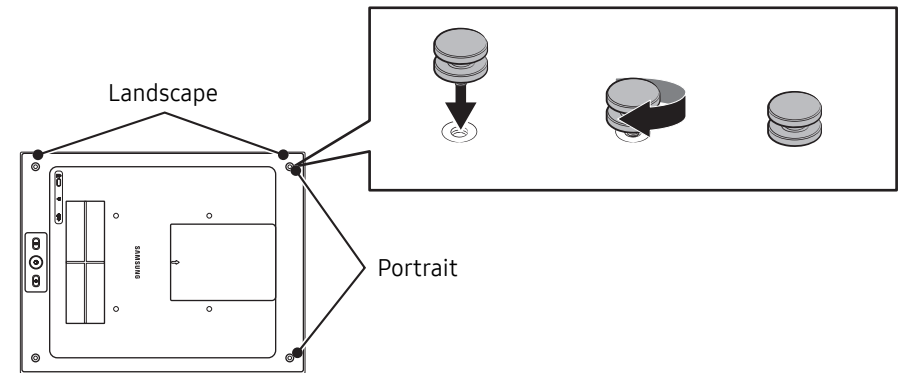

- Attach the two wire holders into the wire holes.
 - Select the appropriate wire holes based on the desired orientation (landscape or portrait).
 - Insert the wire holders into the wire holes. Rotate each wire holder clockwise until securely fastened.
 - Ensure the wire holders are firmly attached.

Hanging the product on the wall

Using a wire and a nail, you can hang the product on the wall.

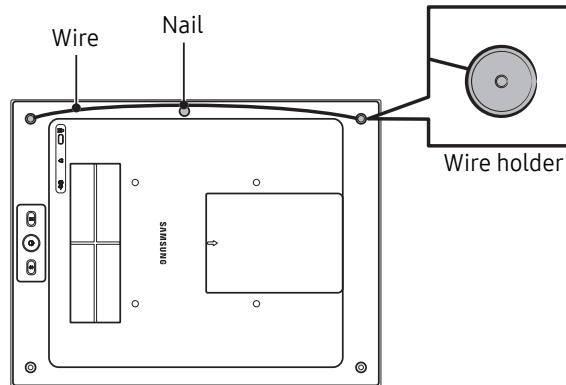

Attach a wire to the wire holders. Then, hang the wire on the nail securely fastened to the wall. Ensure the wire is securely fixed to the holder to prevent it from slipping.

Hanging the product from the ceiling

Using a wire with a hook, you can hang the product from the ceiling.

- ⚠ Hanging the product with a wire bracket directly to screws or nails may cause damage to the product.
- Select a wire that can support four times the weight of the set (10 kg).
- The manufacturer does not guarantee issues caused by customer-installed wires.

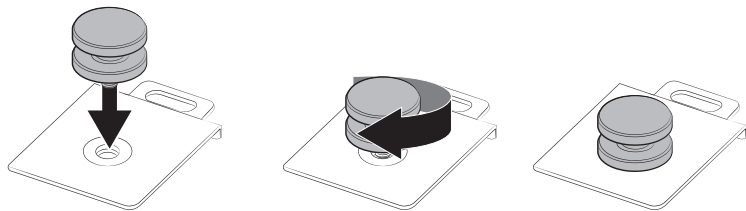

- 1 Attach each wire bracket to the wire holder until it locks securely.
 - Ensure each wire bracket is firmly attached to the wire holder.

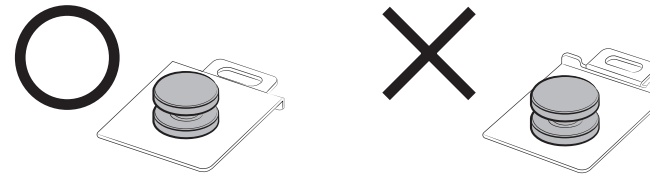

- ⚠ Make sure to attach the wire bracket in the correct direction.

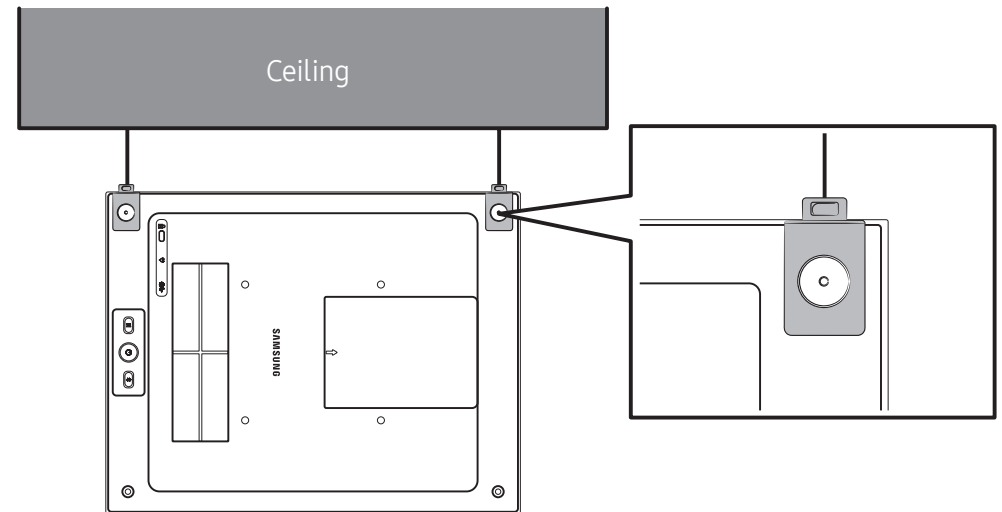

- 2 Hook the wire onto the bracket to secure the product.

Chapter 03

Network

Network Setting (Wired)

- ✎ The E-Paper device can be powered and connected to the network using a PoE (Power over Ethernet) adapter via a wired LAN cable. When using a PoE adapter, connect it to the USB charging port.

Network Settings (Wireless)

- ✎ Connect the mobile phone with the mobile app to Wi-Fi.
- ✎ If you connect the product and the mobile phone using Bluetooth, you can connect the Wi-Fi of the product in the mobile app. Select the same ones as Wi-Fi with your phone connected.
- ✎ EM32DX-A models only: To enable remote wake-up via the mobile app, VXT, or a custom app, a 2.4GHz Wi-Fi network connection is required.

Connecting to a Wireless Network

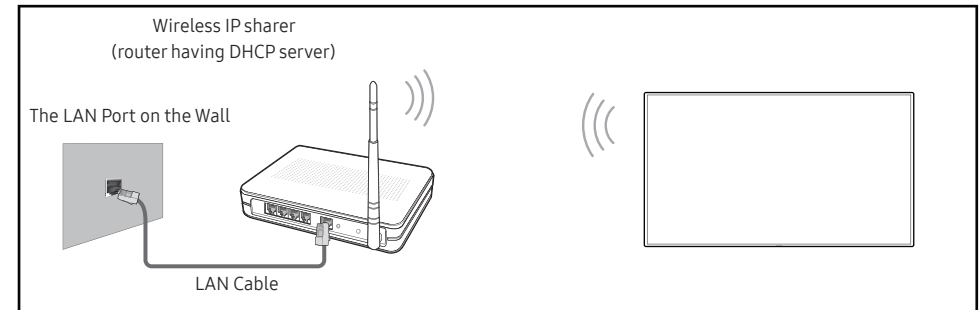

Samsung recommends using IEEE 802.11n.

- ✎ Select a channel for the wireless IP sharer that is not currently being used. If the channel set for the wireless IP sharer is currently being used by another device nearby, this will result in interference and communication failure.
- ✎ Your product supports only the following wireless network security protocols.
 - Authentication Modes: WEP, WPAPSK, WPA2PSK
 - Encryption Types: WEP, TKIP, AESIn compliance with the Wi-Fi certification specifications, Samsung products do not support WEP or TKIP security encryption in networks running in the High-throughput(Greenfield) 802.11n mode.

Chapter 04

Troubleshooting Guide

Requirements Before Contacting Samsung Customer Service Centre

When requesting service, the customer must provide the PIN code in advance to allow the service engineer to access the EMDX (E-Paper) App and check the product information.

Check the followings.

| Screen issue | |
|--|--|
| The picture on the screen looks abnormal. | If the power is cut off while changing the picture file, E-Paper will continue to display the screen shown at the moment of the power cut until the power is restored. Connect the charger and try changing the picture file again. |
| | As a characteristic of E-Paper, burn-in may occur. This is not covered under warranty. Repeatedly displaying the same image (such as fixed text, patterns, or logos) may accelerate burn-in. Allow about 5 minutes for the screen to stabilize after changing the image. |
| | Changing the display picture will take some time. Screen flickering during changing the picture is a characteristic of E-Paper which is normal. |
| The screen flickers. | The E-paper automatically refreshes the screen to optimize the screen. |
| The color of the screen appears different from before. | As the screen refreshes repeatedly over time, its color may gradually change compared to its initial state. Such discoloration is a characteristic of E-Paper display technology. Please note that discoloration is not covered under warranty. |

Mobile connection issue

Unable to connect the product to a mobile phone with the mobile app installed.

Ensure that the mobile phone's Bluetooth is turned on.

Press the  button on the back of the product.

- While in pairing mode, the blue LED on the back of the product will blink.
- Once the connection is complete, the blue LED will remain solid.

Battery issue

The battery icon on the top-right corner of the screen does not disappear.

The low battery icon appears when the battery level is below 10%. It will disappear once the charger is connected.

- It is recommended to disconnect the charger after the battery is fully charged.
- The red LED turns on while the battery is charging and turns off when the battery is fully charged.
- The low battery icon appears when the product wakes up from the Sleep mode. If the Network Standby function is enabled in the Sleep mode, increased battery consumption may cause the product to power off without showing the low battery icon.

The battery icon on the top-right corner of the screen appears too often.

As batteries are consumable items, their usage time gradually decreases compared to when first purchased.

- When a replacement is needed, the low battery notification may appear more frequently.

I want to check the battery level.

You can check the battery level in the mobile app.

The battery is not charging properly.

Check the connection of the charger.



The battery life has become shorter compared to when it was first purchased.

If the charged battery has been exposed to extreme temperatures (low or high), its usage time may decrease. The optimal operating temperature is 10 to 35 °C.

Batteries are consumable items, so their usage time gradually decreases over time.

Connecting to a mobile device or using VXT increases battery consumption. In such cases, use the product with the charger connected.

Other issue

| | |
|--|--|
| Buttons do not work when they are pressed. | Check if the battery is discharged. Check the charger and battery. Disconnect the charger and remove the battery, then reconnect the charger and reinsert the battery. Try operating the buttons again. |
| Product reset | Press and hold the  and  buttons for 5 seconds to reset the product. <ul style="list-style-type: none">• The product will reset and turn off, while the screen retains the current picture.• Press the  button to turn the product back on. The initial setup screen with QR codes will appear on the display. |

Chapter 05

Specifications

General

| Model Name | | EM32DX / EM32DX-A | EM13DX |
|-------------------------|--------------|----------------------------------|----------------------------------|
| Panel | Size | 32 CLASS (31.5 inches / 79.9 cm) | 13 CLASS (13.3 inches / 33.8 cm) |
| | Display area | 696.32 mm (H) x 391.68 mm (V) | 202.8 mm (H) x 270.4 mm (V) |
| Resolution (Panel Spec) | | 2560 x 1440 | 1600 x 1200 |

| | | |
|-------------------------------------|------------------|--|
| Power Supply | | AC100-240V~ 50/60Hz * Refer to the label at the back of the product as the standard voltage can vary in different countries. |
| Environmental considerations | Operating | Temperature: 32 °F to 104 °F (0 °C to 40 °C) * For installing the enclosure, keep the internal temperature at 104 °F (40 °C) or below. Humidity: 30% to 70%, non-condensing |
| | Storage | Temperature -13 °F to 32°F (-25 °C to 0°C), -y Temperature 32°F to 104 °F (0°C to 40 °C), Humidity 30% to 70%, non-condensing Temperature 104°F to 140 °F (40°C to 60 °C), Humidity 30% to 50%, non-condensing * Applicable before the product package is unpacked. |

- Disposal of a BATTERY into fire or a hot oven, or mechanically crushing or cutting of a BATTERY, that can result in an EXPLOSION.
- CAUTION
Risk of fire or explosion if the battery is replaced by an incorrect type.
- EM32DX: The battery warranty period is 1 year and may differ from the product warranty period.
- EM32DX-A / EM13DX: The battery warranty period is 2 years and may differ from the product warranty period. The battery is out of warranty if it is charged and used for more than 400 cycles within 2 years (battery warranty period).
- The battery is shipped with approximately 30% charge. To use the product without the charger, fully charge the battery first.
- For detailed device specifications, visit the Samsung website.
- (USA only)
Dispose unwanted electronics through an approved recycler.
To find the nearest recycling location, go to our website:
www.samsung.com/recycling or call, 1-800-SAMSUNG
For battery recycling go to call2recycle.org or call 1-800-822-8837



Chapter 06

Appendix

Responsibility for the Pay Service (Cost to Customers)

 When the service is requested, in spite of in warranty, we may charge you for a visit from a service technician in the following cases.

Not a product defect

Cleaning of the product, Adjustment, Explanation, Re-installation and etc.

- If a service technician is requested to give instructions on how to use product or simply adjusts options without disassembling product.
- If a defect is caused by external environmental factors (Internet, Antenna, Wired Signal, etc.)
- If a product is reinstalled or devices are connected additionally after installing the purchased product for the first time.
- If a product is reinstalled to move to a different spot or to move to a different house.
- If the customer requests instructions on how to use another company's product.
- If customer requests instructions on how to use the network or another company's programme.
- If customer requests software installation and setup for the product.
- If a service technician removes/cleans dusts or foreign materials inside of the product.
- If customer requests an installation additionally after purchasing a product through home-shopping or online.

A Product damage caused by customer's fault

Product damage caused by customer's mishandling or wrong repair

If a product damage is caused by;

- External impact or drop.
- Use of supplies or separately sold product unspecified by Samsung.
- Repair from a person besides an engineer of outsourcing service company or partner of Samsung Electronics Co., Ltd.
- Remodeling or repairing the product by customer.
- Using it with incorrect voltage or non-authorized electrical connections.
- Not following the "cautions" in User Manual.

Others

- If product fails by natural disaster. (lightning, fire, earthquake, flood damage, etc)
 - If consumable components are all used up. (Battery, Toner, Fluorescent lights, Head, Vibrator, Lamp, Filter, Ribbon, etc.)
-  If customer requests a service in case the product has no defect, service fee may be charged. So please read User Manual first.

Connecting the battery

- Batteries are consumables and usage time gradually decreases over time. If you need to replace the battery purchase a new battery.
- The battery works best between 10 to 35 °C.
 - Operating outside of this range may cause damage to the battery or shorten its lifespan.
- Using the charger is recommended if using the mobile app or VXT Player App.

Oobe

- You must use the "Samsung E-Paper" mobile app.
- For the product's network settings, your mobile device should have the Bluetooth function turned on and connected to a wireless AP.
- You must remember the 6-digit PIN code you set during the initial settings for future use. (You need to enter the PIN code when you reconnect.)
- If you skip the initial settings, only the content playback function via USB connection will be available.
- If the initial settings are not completed within 2 hours from the initial booting screen, the product will enter the Sleep mode.

Installing the mobile app

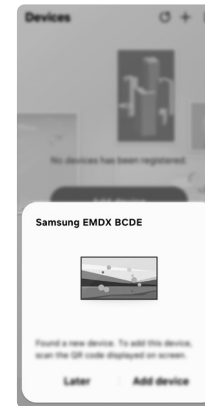

- 1 Installing the mobile app
 - Search for the 'Samsung E-Paper' app from the Google Play Store or Apple App Store and install it on your mobile.
 - When the product is powered on, the screen displays three QR codes: one for Android app installation, one for iOS app installation, and one for adding the device to the app.

The app can be installed on mobile phones running Android 10 or later and iOS 15 or later. 2 GB of storage space is required.
- 2 Registering the product on the mobile app through Bluetooth
 - When you open the mobile app, a nearby device appears. Tap **Add device** to register the product on the mobile app. Alternatively, you can tap the + button. Then scan the QR code that appears on the product when you turn on the product.
 - Verify and enter the device name (EMDX + 4-digit number) and pairing code (6-digit number) displayed on the product screen to complete the connection.
- 3 Setting Up Wi-Fi
 - Select the same Wi-Fi network that your mobile phone is connected to.
 - You can also use your mobile phone's **Mobile Hotspot** for the connection.

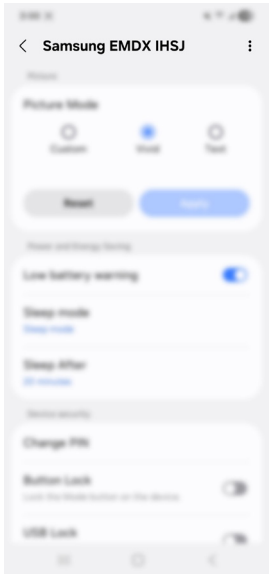



- 4 You can enable or disable the Network standby function in the Power and Energy Saving menu of mobile app.
- Sleep mode: Sleep mode / Deep sleep mode / Sleep mode off
 - ☞ Changing this setting may increase power consumption.
 - Sleep After
 - ☞ Changing this setting may increase power consumption.

Playing picture files by connecting a USB

- If you save picture files in the SAMSUNG_E-Paper folder on the USB and connect it to the product, the picture files will be copied to the internal memory.
 - The playback order follows the ascending order of file names.
 - Each time you connect a USB, the files stored in the internal memory will be deleted, and the picture files from the newly connected USB will be copied.
- The optimized resolution for the picture files : 1440 x 2560 (EM32DX / EM32DX-A), 1200 x 1600 (EM13DX).
 - If the picture size is not 1440 x 2560 (EM32DX / EM32DX-A) or 1200 x 1600 (EM13DX) , it will be scaled up or down to fit the screen size, while maintaining the aspect ratio.
- Compatible image file formats: BMP, JPG, JPEG, PNG

| File Format | Max. resolution |
|-------------|-----------------|
| BMP | 7680 x 4320 |
| JPG | |
| JPEG | |
| PNG | |

E-Paper product guidelines

- To add your product to the "Samsung E-Paper" app, press and hold the  button on the product to pair it with the mobile app.
- Screen flickering during refreshing or changing pictures is a characteristic of E-Paper display which is normal.
- Changing the display picture will take some time.
- The E-paper automatically refreshes the screen to optimize the screen.
- If the product will not be used for a long time, switching the screen to white is recommended. To switch the screen to white, press and hold the  for 2 seconds.

Open Source License Notice

Open Source used in this product can be found on the following webpage.
(<https://opensource.samsung.com>)