

# Alienware m16 R1 Service Manual

## Notes, cautions, and warnings

 **NOTE:** A NOTE indicates important information that helps you make better use of your product.

 **CAUTION:** A CAUTION indicates either potential damage to hardware or loss of data and tells you how to avoid the problem.

 **WARNING:** A WARNING indicates a potential for property damage, personal injury, or death.

# Contents

<b>Chapter 1: Working inside your computer</b> .....	<b>6</b>
Before working inside your computer.....	6
Safety instructions.....	6
Electrostatic discharge—ESD protection.....	7
ESD field service kit .....	7
Transporting sensitive components.....	8
After working inside your computer.....	8
<b>Chapter 2: Removing and installing components</b> .....	<b>9</b>
Recommended tools.....	9
Screw list.....	9
Major components of Alienware m16 R1.....	10
Base cover.....	12
Removing the base cover.....	12
Installing the base cover.....	14
Battery.....	16
Lithium-ion battery precautions.....	16
Removing the battery.....	17
Installing the battery.....	18
Battery cable.....	19
Removing the battery cable.....	19
Installing the battery cable.....	19
Solid-state drive.....	20
Removing the 2230 solid-state drive in slot three and four.....	20
Installing the 2230 solid-state drive in slot three and four.....	21
Removing the 2280 solid-state drive in slot one and two.....	22
Installing the 2280 solid-state drive in slot one and two.....	23
Procedure to move the screw mount in SSD slot one and two.....	24
Memory.....	25
Removing the memory.....	25
Installing the memory.....	26
Wireless card.....	27
Removing the wireless card.....	27
Installing the wireless card.....	28
Fan.....	29
Removing the small fan.....	29
Installing the small fan.....	30
Rear-I/O cover.....	31
Removing the rear-I/O cover.....	31
Installing the rear-I/O cover.....	32
I/O board.....	33
Removing the I/O board.....	33
Installing the I/O board.....	34
Speakers.....	35
Removing the speakers.....	35

Installing the speakers.....	36
Power-adapter port.....	37
Removing the power-adapter port.....	37
Installing the power-adapter port.....	38
Touchpad.....	39
Removing the touchpad.....	39
Installing the touchpad.....	40
Antennas.....	42
Display assembly.....	45
Top heat-sink.....	49
Removing the top heat-sink.....	49
Installing the top heat-sink.....	49
Keyboard-controller board.....	50
Removing the keyboard-controller board.....	50
Installing the keyboard-controller board.....	51
System board.....	52
Removing the system board .....	52
Installing the system board .....	55
Fan and heat-sink assembly.....	58
Removing the fan and heat-sink assembly.....	58
Installing the fan and heat-sink assembly.....	60
Audio board.....	62
Removing the audio board.....	62
Installing the audio board.....	63
Power button.....	64
Removing the power button.....	64
Installing the power button.....	65
Palm-rest and keyboard assembly.....	66
Removing the palm-rest and keyboard assembly.....	66
Installing the palm-rest and keyboard assembly.....	67

### **Chapter 3: Drivers and downloads..... 69**

### **Chapter 4: System setup..... 70**

Entering BIOS setup program.....	70
Navigation keys.....	70
Boot Sequence.....	70
One time boot menu.....	71
BIOS overview.....	71
System setup options.....	71
System and setup password.....	81
Assigning a system setup password.....	81
Deleting or changing an existing system setup password.....	82
Clearing CMOS settings.....	82
Clearing BIOS (System Setup) and System passwords.....	83
Updating the BIOS.....	83
Updating the BIOS in Windows.....	83
Updating the BIOS using the USB drive in Windows.....	83
Updating the BIOS from the F12 One-Time boot menu.....	83

<b>Chapter 5: Troubleshooting.....</b>	<b>85</b>
Handling swollen Lithium-ion batteries.....	85
<b>Locate the Service Tag or Express Service Code of your Dell computer .....</b>	<b>85</b>
System-diagnostic lights.....	85
SupportAssist diagnostics.....	86
Recovering the operating system.....	87
Backup media and recovery options.....	87
WiFi power cycle.....	87
Drain residual flea power (perform hard reset).....	87
 <b>Chapter 6: Getting help and contacting Alienware.....</b>	 <b>89</b>

# Working inside your computer

## Before working inside your computer

### About this task

 **NOTE:** The images in this document may differ from your computer depending on the configuration you ordered.

### Steps

1. Save and close all open files and exit all open applications.

2. Shut down your computer. Click **Start** >  **Power** > **Shut down**.

 **NOTE:** If you are using a different operating system, see the documentation of your operating system for shut-down instructions.

3. Disconnect your computer and all attached devices from their electrical outlets.

4. Disconnect all attached network devices and peripherals, such as keyboard, mouse, and monitor from your computer.

 **CAUTION:** To disconnect a network cable, first unplug the cable from your computer and then unplug the cable from the network device.

5. Remove any media card and optical disc from your computer, if applicable.

## Safety instructions

Use the following safety guidelines to protect your computer from potential damage and to ensure your personal safety. Unless otherwise noted, each procedure included in this document assumes that you have read the safety information that shipped with your computer.

 **WARNING:** Before working inside your computer, read the safety information that is shipped with your computer. For more safety best practices, see the Regulatory Compliance home page at [www.dell.com/regulatory\\_compliance](http://www.dell.com/regulatory_compliance).

 **WARNING:** Disconnect your computer from all power sources before opening the computer cover or panels. After you finish working inside the computer, replace all covers, panels, and screws before connecting your computer to an electrical outlet.

 **CAUTION:** To avoid damaging the computer, ensure that the work surface is flat, dry, and clean.

 **CAUTION:** To avoid damaging the components and cards, handle them by their edges, and avoid touching the pins and the contacts.

 **CAUTION:** You should only perform troubleshooting and repairs as authorized or directed by the Dell technical assistance team. Damage due to servicing that is not authorized by Dell is not covered by your warranty. See the safety instructions that is shipped with the product or at [www.dell.com/regulatory\\_compliance](http://www.dell.com/regulatory_compliance).

 **CAUTION:** Before touching anything inside your computer, ground yourself by touching an unpainted metal surface, such as the metal at the back of the computer. While you work, periodically touch an unpainted metal surface to dissipate static electricity which could harm internal components.

 **CAUTION:** When you disconnect a cable, pull it by its connector or its pull tab, not the cable itself. Some cables have connectors with locking tabs or thumbscrews that you must disengage before disconnecting the cable. When disconnecting cables, keep them evenly aligned to avoid bending the connector pins. When connecting cables, ensure that the ports and the connectors are correctly oriented and aligned.

 **CAUTION:** Press and eject any installed card from the media-card reader.

**⚠ CAUTION: Exercise caution when handling Lithium-ion batteries in laptops. Swollen batteries should not be used and should be replaced and disposed properly.**

**ℹ NOTE:** The color of your computer and certain components may appear differently than shown in this document.

## Electrostatic discharge—ESD protection

ESD is a major concern when you handle electronic components, especially sensitive components such as expansion cards, processors, memory DIMMs, and system boards. Very slight charges can damage circuits in ways that may not be obvious, such as intermittent problems or a shortened product life span. As the industry pushes for lower power requirements and increased density, ESD protection is an increasing concern.

Due to the increased density of semiconductors used in recent Dell products, the sensitivity to static damage is now higher than in previous Dell products. For this reason, some previously approved methods of handling parts are no longer applicable.

Two recognized types of ESD damage are catastrophic and intermittent failures.

- **Catastrophic** – Catastrophic failures represent approximately 20 percent of ESD-related failures. The damage causes an immediate and complete loss of device functionality. An example of catastrophic failure is a memory DIMM that has received a static shock and immediately generates a "No POST/No Video" symptom with a beep code emitted for missing or nonfunctional memory.
- **Intermittent** – Intermittent failures represent approximately 80 percent of ESD-related failures. The high rate of intermittent failures means that most of the time when damage occurs, it is not immediately recognizable. The DIMM receives a static shock, but the tracing is merely weakened and does not immediately produce outward symptoms related to the damage. The weakened trace may take weeks or months to melt, and in the meantime may cause degradation of memory integrity, intermittent memory errors, etc.

The more difficult type of damage to recognize and troubleshoot is the intermittent (also called latent or "walking wounded") failure.

Perform the following steps to prevent ESD damage:

- Use a wired ESD wrist strap that is properly grounded. The use of wireless anti-static straps is no longer allowed; they do not provide adequate protection. Touching the chassis before handling parts does not ensure adequate ESD protection on parts with increased sensitivity to ESD damage.
- Handle all static-sensitive components in a static-safe area. If possible, use anti-static floor pads and workbench pads.
- When unpacking a static-sensitive component from its shipping carton, do not remove the component from the anti-static packing material until you are ready to install the component. Before unwrapping the anti-static packaging, ensure that you discharge static electricity from your body.
- Before transporting a static-sensitive component, place it in an anti-static container or packaging.

## ESD field service kit

The unmonitored Field Service kit is the most commonly used service kit. Each Field Service kit includes three main components: anti-static mat, wrist strap, and bonding wire.

### Components of an ESD field service kit

The components of an ESD field service kit are:

- **Anti-Static Mat** – The anti-static mat is dissipative and parts can be placed on it during service procedures. When using an anti-static mat, your wrist strap should be snug and the bonding wire should be connected to the mat and to any bare metal on the system being worked on. Once deployed properly, service parts can be removed from the ESD bag and placed directly on the mat. ESD-sensitive items are safe in your hand, on the ESD mat, in the system, or inside a bag.
- **Wrist Strap and Bonding Wire** – The wrist strap and bonding wire can be either directly connected between your wrist and bare metal on the hardware if the ESD mat is not required, or connected to the anti-static mat to protect hardware that is temporarily placed on the mat. The physical connection of the wrist strap and bonding wire between your skin, the ESD mat, and the hardware is known as bonding. Use only Field Service kits with a wrist strap, mat, and bonding wire. Never use wireless wrist straps. Always be aware that the internal wires of a wrist strap are prone to damage from normal wear and tear, and must be checked regularly with a wrist strap tester in order to avoid accidental ESD hardware damage. It is recommended to test the wrist strap and bonding wire at least once per week.
- **ESD Wrist Strap Tester** – The wires inside of an ESD strap are prone to damage over time. When using an unmonitored kit, it is a best practice to regularly test the strap prior to each service call, and at a minimum, test once per week. A wrist strap tester is the

best method for doing this test. If you do not have your own wrist strap tester, check with your regional office to find out if they have one. To perform the test, plug the wrist-strap's bonding-wire into the tester while it is strapped to your wrist and push the button to test. A green LED is lit if the test is successful; a red LED is lit and an alarm sounds if the test fails.

- **Insulator Elements** – It is critical to keep ESD sensitive devices, such as plastic heat sink casings, away from internal parts that are insulators and often highly charged.
- **Working Environment** – Before deploying the ESD Field Service kit, assess the situation at the customer location. For example, deploying the kit for a server environment is different than for a desktop or portable environment. Servers are typically installed in a rack within a data center; desktops or portables are typically placed on office desks or cubicles. Always look for a large open flat work area that is free of clutter and large enough to deploy the ESD kit with additional space to accommodate the type of system that is being repaired. The workspace should also be free of insulators that can cause an ESD event. On the work area, insulators such as Styrofoam and other plastics should always be moved at least 12 inches or 30 centimeters away from sensitive parts before physically handling any hardware components
- **ESD Packaging** – All ESD-sensitive devices must be shipped and received in static-safe packaging. Metal, static-shielded bags are preferred. However, you should always return the damaged part using the same ESD bag and packaging that the new part arrived in. The ESD bag should be folded over and taped shut and all the same foam packing material should be used in the original box that the new part arrived in. ESD-sensitive devices should be removed from packaging only at an ESD-protected work surface, and parts should never be placed on top of the ESD bag because only the inside of the bag is shielded. Always place parts in your hand, on the ESD mat, in the system, or inside an anti-static bag.
- **Transporting Sensitive Components** – When transporting ESD sensitive components such as replacement parts or parts to be returned to Dell, it is critical to place these parts in anti-static bags for safe transport.

## ESD protection summary

It is recommended to use the traditional wired ESD grounding wrist strap and protective anti-static mat at all times when servicing Dell products. In addition, it is critical to keep sensitive parts separate from all insulator parts while performing service and that they use anti-static bags for transporting sensitive components.

## Transporting sensitive components

When transporting ESD sensitive components such as replacement parts or parts to be returned to Dell, it is critical to place these parts in anti-static bags for safe transport.

## After working inside your computer

### About this task

 **CAUTION: Leaving stray or loose screws inside your computer may severely damage your computer.**

### Steps

1. Replace all screws and ensure that no stray screws remain inside your computer.
2. Connect any external devices, peripherals, or cables you removed before working on your computer.
3. Replace any media cards, discs, or any other parts that you removed before working on your computer.
4. Connect your computer and all attached devices to their electrical outlets.
5. Turn on your computer.



# Removing and installing components

**NOTE:** The images in this document may differ from your computer depending on the configuration you ordered.

## Recommended tools

The procedures in this document may require the following tools:

- Phillips screwdriver #0
- Plastic scribe











## Screw list

**NOTE:** When removing screws from a component, it is recommended to note the screw type, the quantity of screws, and then place them in a screw storage box. This is to ensure that the correct number of screws and correct screw type is restored when the component is replaced.















**NOTE:** Some computers have magnetic surfaces. Ensure that the screws are not left attached to such surfaces when replacing a component.

**NOTE:** Screw color may vary with the configuration ordered.

**Table 1. Screw list**

Component	Screw type	Quantity	Screw image
Base cover	M2.5x8 (captive screw)	2	
Base cover	M2.5x5	6	
2280 or 2230 solid-state drive in SSD Slot one and two	M2x3.5	2	
2230 solid-state drive in SSD Slot three and four	M2x3.5	2	
Wireless-card bracket	M2x2.5	2	
Small fan	M2x4	3	
Rear I/O cover	M2x4	5	
Rear I/O cover	M2.5x5	2	
I/O board	M2x2.5	4	
Battery	M2x3.5	4	

**Table 1. Screw list (continued)**

Component	Screw type	Quantity	Screw image
Battery	M2x4	4	
Power-adapter port-bracket	M2x4	2	
Display-assembly hinges	M2.5x5	10	
Touchpad bracket	M2x2.5	6	
Touchpad	M2x2	2	
Antenna	M2.5x5	4	
Keyboard-controller board	M2x2	2	
Type-C bracket	M2x2.5	2	
System board	M2x4	18	
System board	M2x2.5	2	
Top heat-sink	M2x2.5	4	
Fan and heat-sink assembly	M2x8.05 (captive)	4	
Fan and heat-sink assembly	M2x7.1 (captive)	4	
Audio board	M2x4	2	
Power button bracket	M2x2.5	3	

## Major components of Alienware m16 R1

The following image shows the major components of Alienware m16 R1.

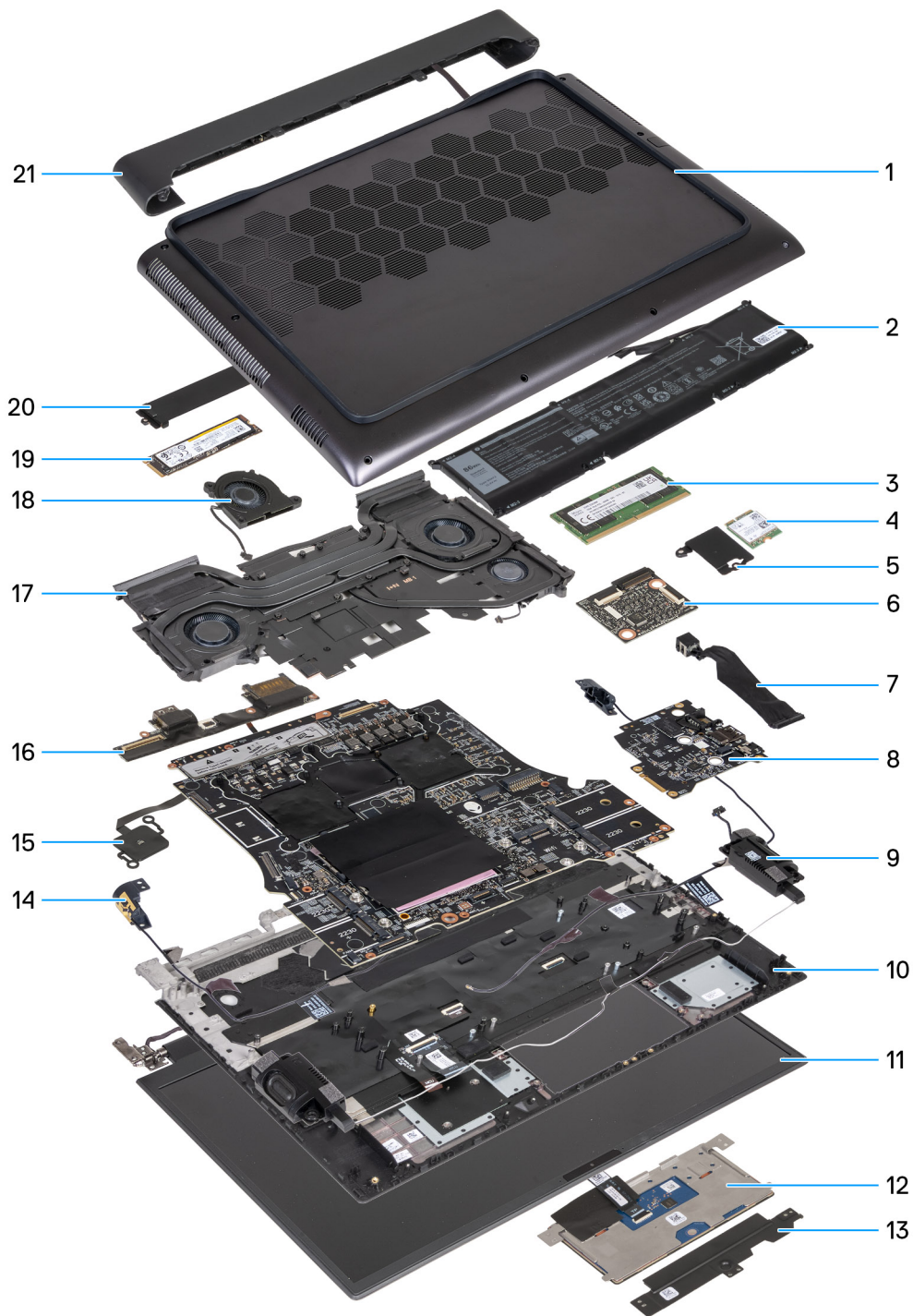

- 1. Base cover
- 2. Battery
- 3. Memory modules
- 4. Wireless card
- 5. Wireless-card bracket
- 6. Keyboard-controller board
- 7. Power-adaptor cable
- 8. Audio board
- 9. Left speaker
- 10. Palm-rest and keyboard assembly
- 11. Display assembly
- 12. Touchpad
- 13. Touchpad bracket

- 14. Antenna holder
- 15. Power-button bracket
- 16. I/O board
- 17. Heat sink
- 18. Small fan
- 19. 2280 solid-state drive
- 20. 2280 solid-state drive thermal shield
- 21. Rear-I/O cover

**NOTE:** Computers shipped with NVIDIA GeForce RTX 4080/4090 graphics card have two M.2 2230 and two M.2 2280 solid-state drive slots, whereas computers shipped with NVIDIA GeForce RTX 4050/4060/4070 graphics card have only two M.2 2280 solid-state drive slots.

**NOTE:** Dell provides a list of components and their part numbers for the original system configuration purchased. These parts are available according to warranty coverages purchased by the customer. Contact your Dell sales representative for purchase options.

## Base cover

### Removing the base cover

#### Prerequisites

1. Follow the procedure in [Before working inside your computer](#).

#### About this task

The following image(s) indicate the location of the base cover and provides a visual representation of the removal procedure.



**6x**  
M2.5x5



**2x**  
M2.5x8

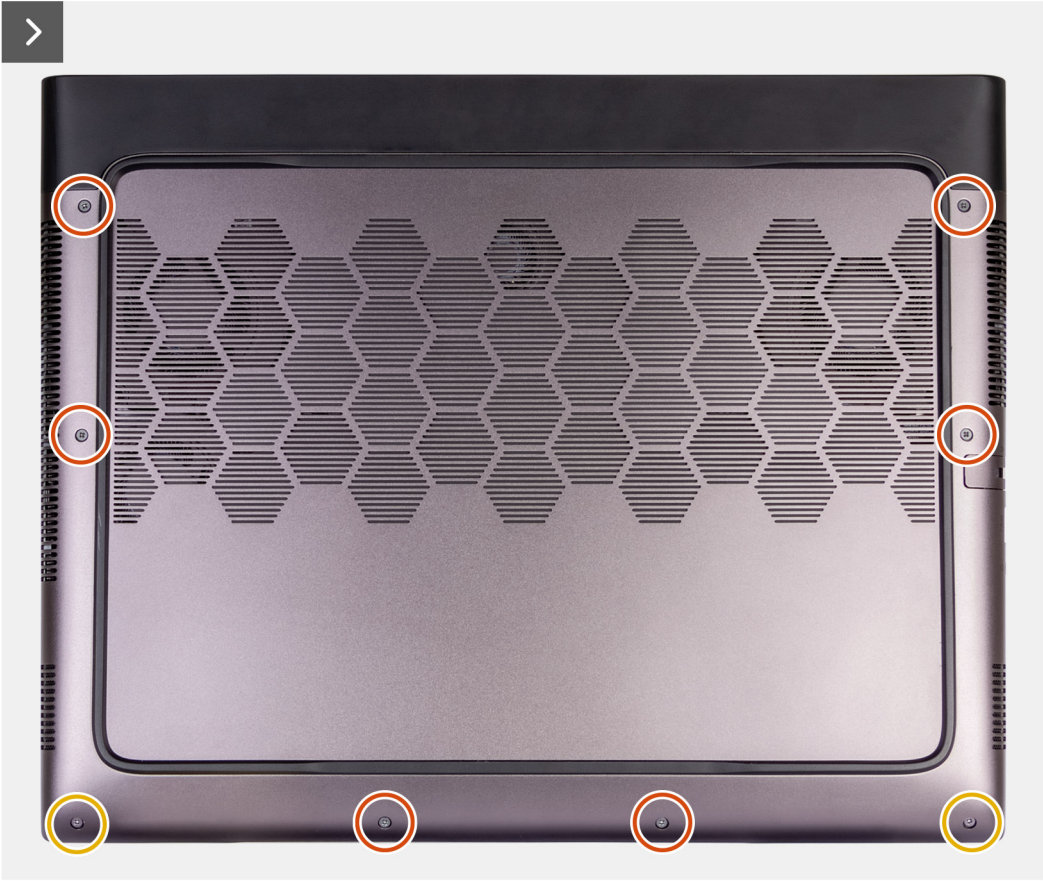

## Steps

1. Remove the six screws (M2.5x5) that secure the base cover to the palm-rest and keyboard assembly.
2. Loosen the two captive screws (M2.5x8) that secure the base cover to the palm-rest and keyboard assembly.
3. Using a plastic scribe, pry the base cover from the bottom left and continue to work on the sides to open the base cover.

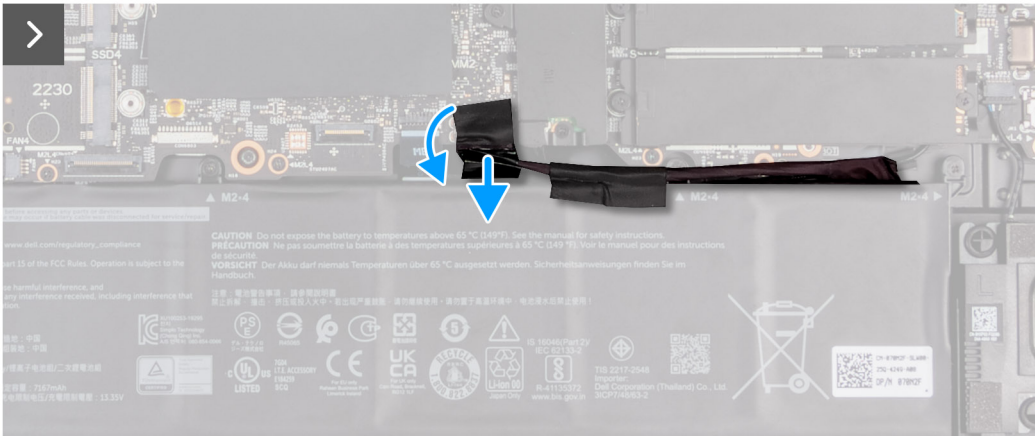
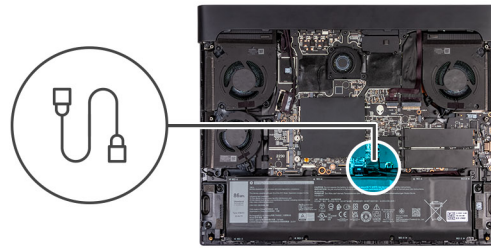

4. Slide and lift the base cover off the palm-rest and keyboard assembly.
5. Peel the tape that secures the battery cable to the battery.
6. Disconnect the battery cable from the system board.

## Installing the base cover

### Prerequisites

If you are replacing a component, remove the existing component before performing the installation process.

### About this task

The following image(s) indicate the location of the base cover and provides a visual representation of the installation procedure.

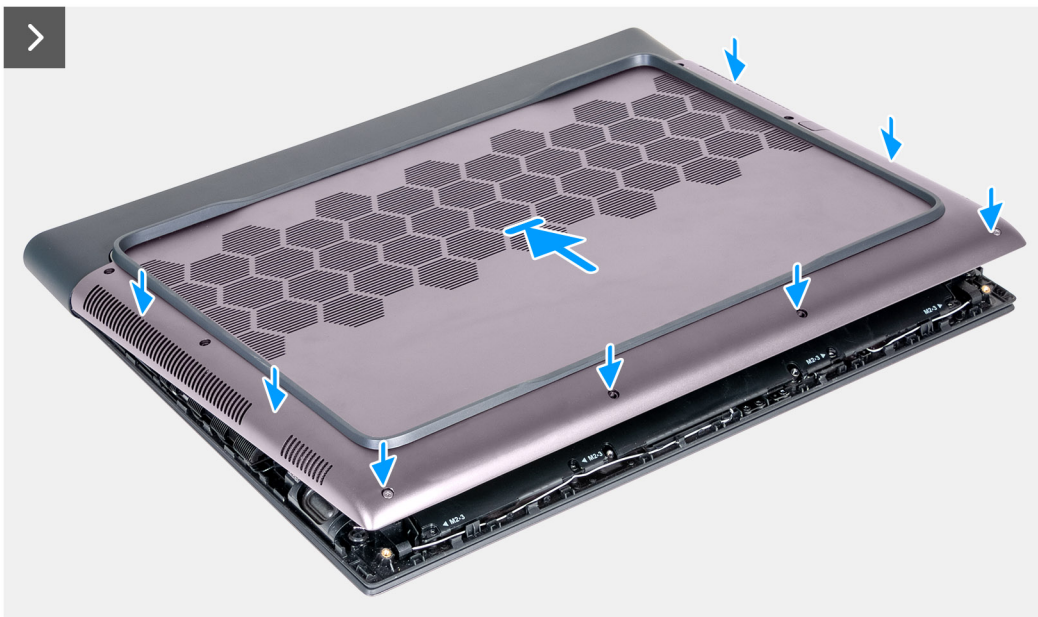
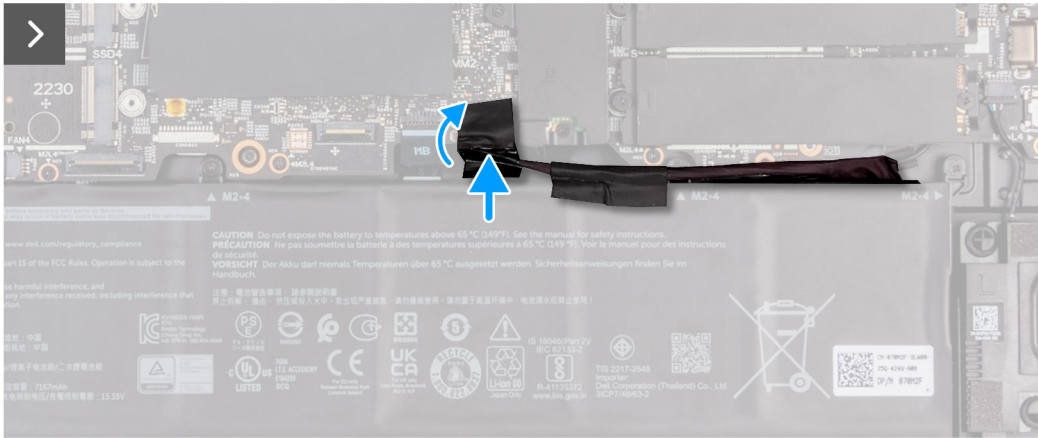
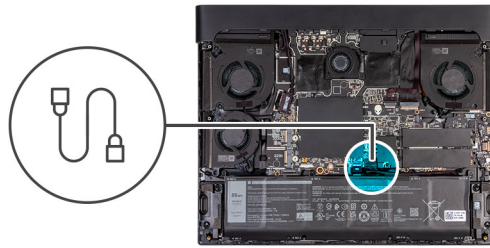

**Steps**

1. Connect the battery cable to the system board.
2. Adhere the tape that secures the battery cable to the battery.
3. Slide the tabs on the top of the base cover under the I/O-cover and snap the base cover to the palm-rest and keyboard assembly.



6x  
M2.5x5



2x  
M2.5x8

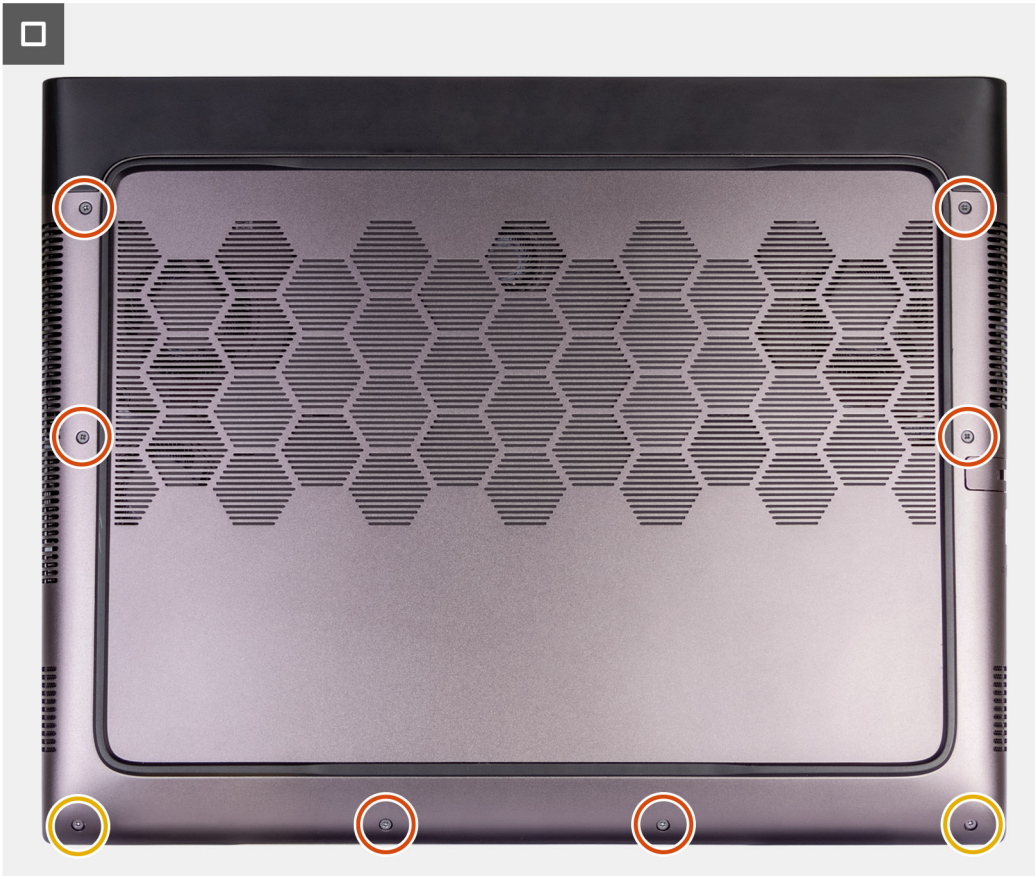

4. Tighten the two captive screws (M2.5x8) on the base cover that secure the base cover to the palm-rest and keyboard assembly.
5. Replace the six screws (M2.5x5) that secure the base cover to the palm-rest and keyboard assembly.

#### Next steps

1. Follow the procedure in [After working inside your computer.](#)

## Battery

### Lithium-ion battery precautions

#### ⚠ CAUTION:

- Exercise caution when handling Lithium-ion batteries.
- Discharge the battery completely before removing it. Disconnect the AC power adapter from the system and operate the computer solely on battery power—the battery is fully discharged when the computer no longer turns on when the power button is pressed.
- Do not crush, drop, mutilate, or penetrate the battery with foreign objects.
- Do not expose the battery to high temperatures, or disassemble battery packs and cells.



- Do not apply pressure to the surface of the battery.
- Do not bend the battery.
- Do not use tools of any kind to pry on or against the battery.
- Ensure any screws during the servicing of this product are not lost or misplaced, to prevent accidental puncture or damage to the battery and other system components.
- If the battery gets stuck inside your computer as a result of swelling, do not try to release it as puncturing, bending, or crushing a lithium-ion battery can be dangerous. In such an instance, contact Dell technical support for assistance. See [www.dell.com/contactdell](http://www.dell.com/contactdell).
- Always purchase genuine batteries from [www.dell.com](http://www.dell.com) or authorized Dell partners and resellers.
- Swollen batteries should not be used and should be replaced and disposed properly. For guidelines on how to handle and replace swollen Lithium-ion batteries, see [Handling swollen Lithium-ion batteries](#).

## Removing the battery

### Prerequisites

1. Follow the procedure in [Before working inside your computer](#).
2. Remove the [base cover](#).

### About this task

- NOTE:** This computer is designed without an RTC coin cell-battery. After a service incident where the computer battery is disconnected, when the battery is fully discharged, or when the computer is reassembled and turned on, an RTC reset cycle will occur. When an RTC Reset cycle occurs, the computer turns on and off three times. An "Invalid Configuration" error message is displayed prompting you to enter the BIOS and configure the date and time. The computer starts functioning normally after setting the date and time.
- NOTE:** Removing the battery resets the BIOS setup program's settings to default. It is recommended that you note the BIOS setup program's settings before removing the battery.

The following image(s) indicate the location of the battery and provides a visual representation of the removal procedure.

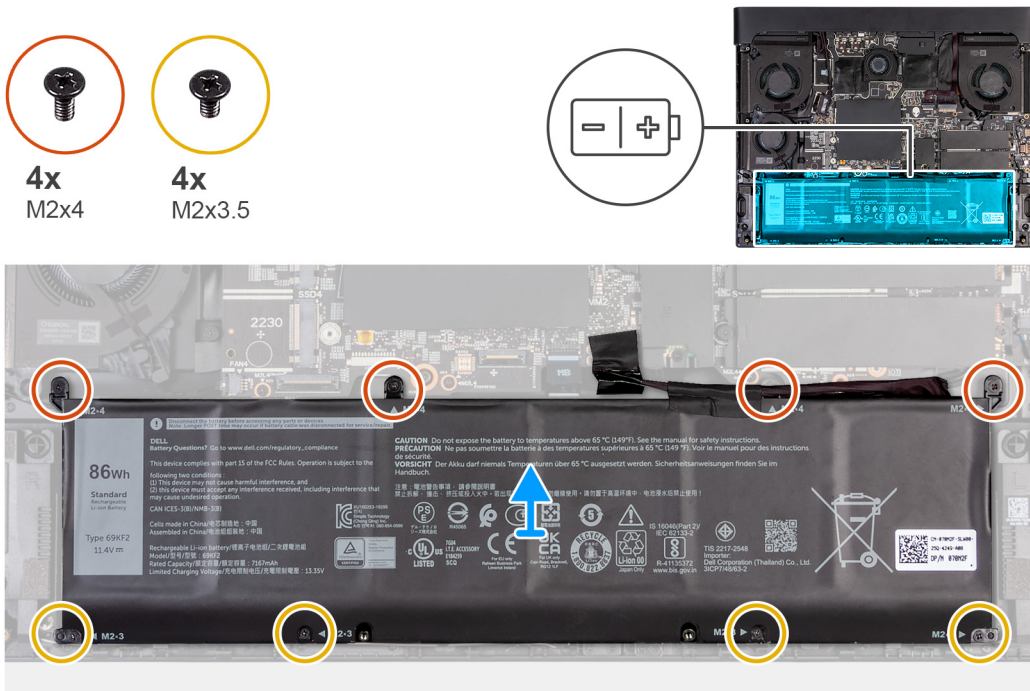

## Steps

1. Peel the tape that secures the battery cable to the battery.
2. Disconnect the battery cable from the system board.
  - ① **NOTE:** This step is applicable only if the battery cable has not been disconnected.
3. Remove the four screws (M2x4) that secure the battery to the palm-rest and keyboard assembly.
4. Remove the four screws (M2x3.5) that secures the battery to the palm-rest and keyboard assembly.
5. Lift the battery off the palm-rest and keyboard assembly.

## Installing the battery

### Prerequisites

If you are replacing a component, remove the existing component before performing the installation process.

### About this task

The following image(s) indicate the location of the battery and provides a visual representation of the installation procedure.

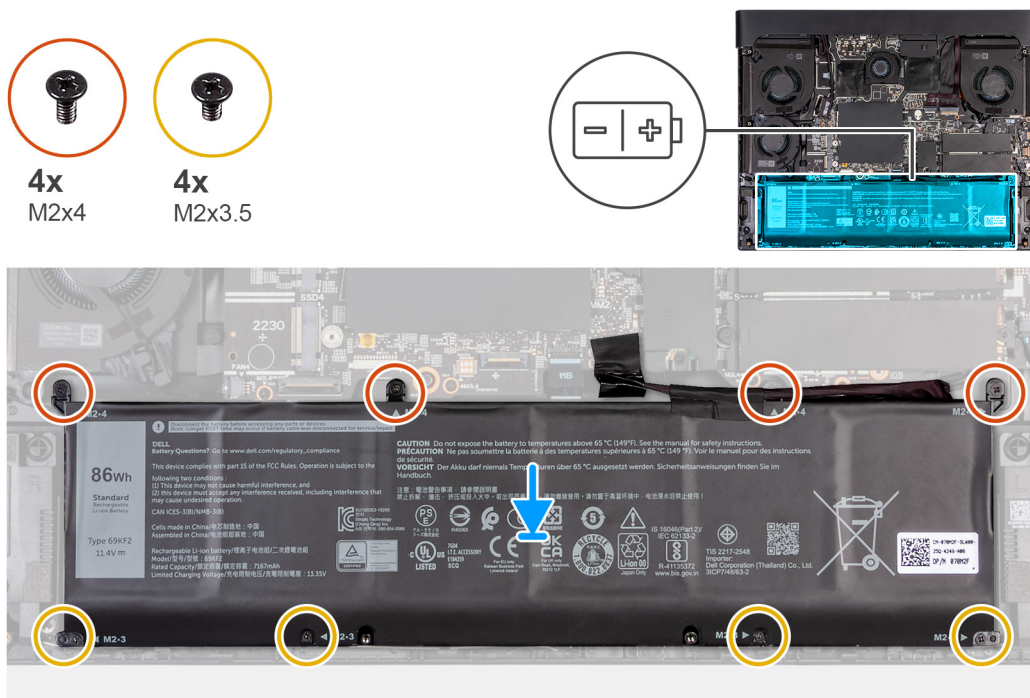

## Steps

1. Using the alignment posts, place the battery on the palm-rest and keyboard assembly.
2. Align the screw holes on the battery with the screw holes on the palm-rest and keyboard assembly.
3. Replace the four screws (M2x3.5) that secure the battery to the palm-rest and keyboard assembly.
4. Replace the four screws (M2x4) that secure the battery to the palm-rest and keyboard assembly.
5. Connect the battery cable to the system board.
6. Adhere the tape that secures the battery cable to the battery.

### Next steps

1. Install the [base cover](#).
2. Follow the procedure in [After working inside your computer](#).

# Battery cable

## Removing the battery cable

### Prerequisites

1. Follow the procedure in [Before working inside your computer.](#)
2. Remove the [base cover.](#)
3. Remove the [battery.](#)

### About this task

**NOTE:** If the battery is disconnected from system board for service, then there is a delay during boot as the computer undergoes RTC battery reset.

The following image(s) indicate the location of the battery cable and provides a visual representation of the removal procedure.

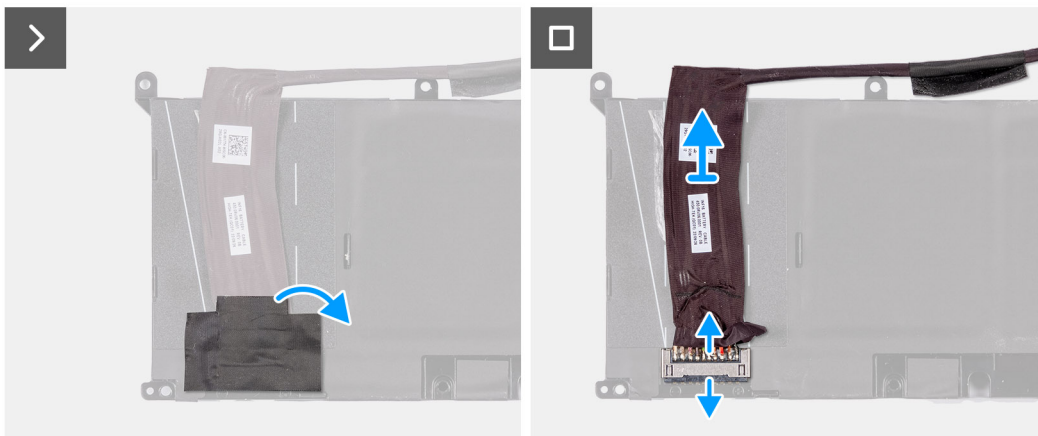
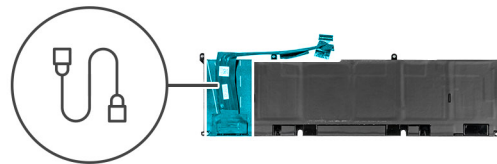

### Steps

1. Turn the battery over.
2. Peel the tape securing the battery cable.
3. Open the latch to disconnect the battery cable from the battery.
4. Peel the battery cable off the battery.
5. Lift the battery cable off the battery.

## Installing the battery cable

### Prerequisites

If you are replacing a component, remove the existing component before performing the installation process.

### About this task

The following image(s) indicate the location of the battery cable and provides a visual representation of the installation procedure.

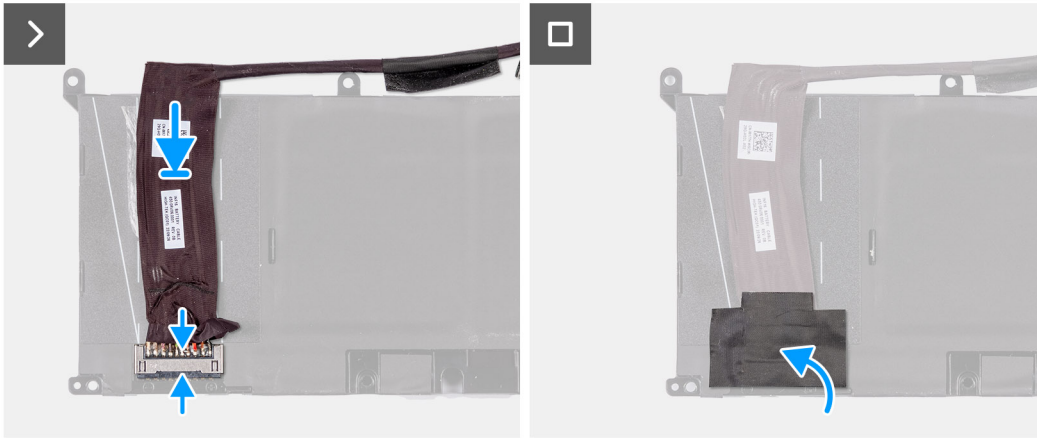
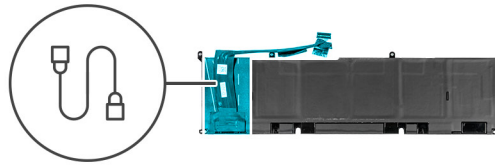

### Steps

1. Adhere the battery cable to the battery.
2. Connect the battery cable to the latch on the battery.
3. Adhere the tape back on the battery.
4. Turn the battery over.

### Next steps

1. Install the [battery](#).
2. Install the [base cover](#).
3. Follow the procedure in [After working inside your computer](#).

## Solid-state drive

### Removing the 2230 solid-state drive in slot three and four

#### Prerequisites

1. Follow the procedure in [Before working inside your computer](#).
2. Remove the [base cover](#).

#### About this task

The following image(s) indicate the location of the 2230 solid-state drive in slot three and four and provides a visual representation of the removal procedure.

**i** **NOTE:** Computers shipped with NVIDIA GeForce RTX 4080/4090 graphics card have two M.2 2230 and two M.2 2280 solid-state drive slots, whereas computers shipped with NVIDIA GeForce RTX 4050/4060/4070 graphics card have only two M.2 2280 solid-state drive slots.



2x  
M2x3.5

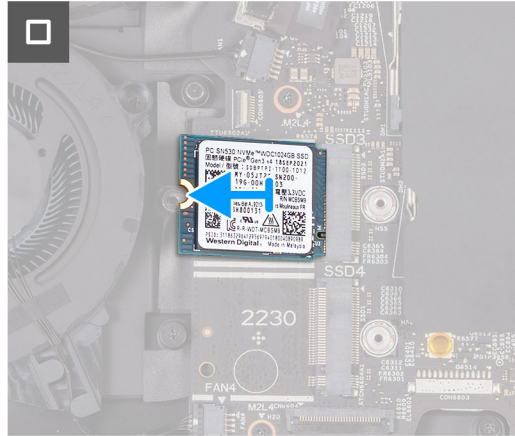
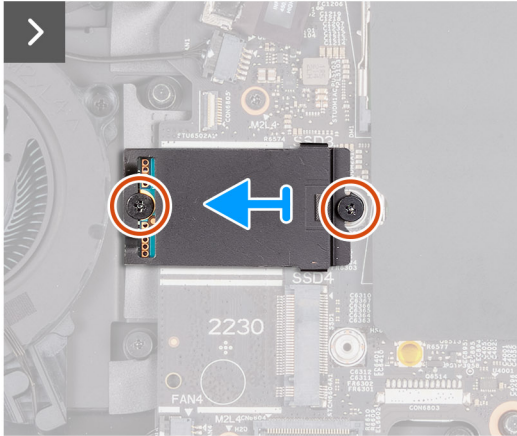
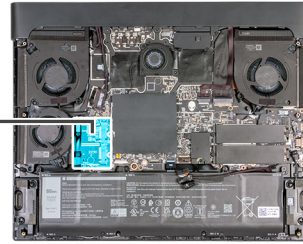

### Steps

1. Remove the two screws (M2x3.5) that secure the 2230 thermal shield to the palm-rest and keyboard assembly.
2. Slide and remove the 2230 thermal shield off the solid-state drive.
3. Slide and lift the 2230 solid-state drive from the solid-state drive slot.

## Installing the 2230 solid-state drive in slot three and four

### Prerequisites

If you are replacing a component, remove the existing component before performing the installation process.

### About this task

The following image(s) indicate the location of the 2230 solid-state drive in slot three and four and provides a visual representation of the installation procedure.



2x  
M2x3.5

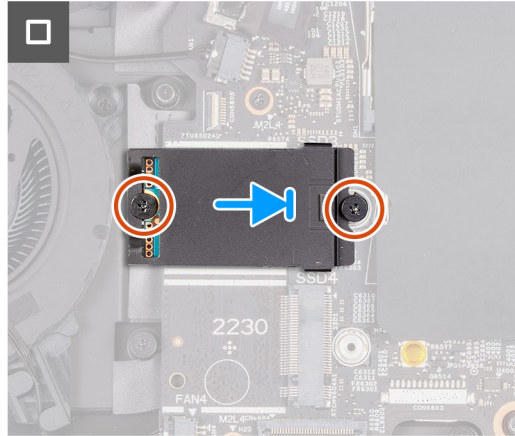
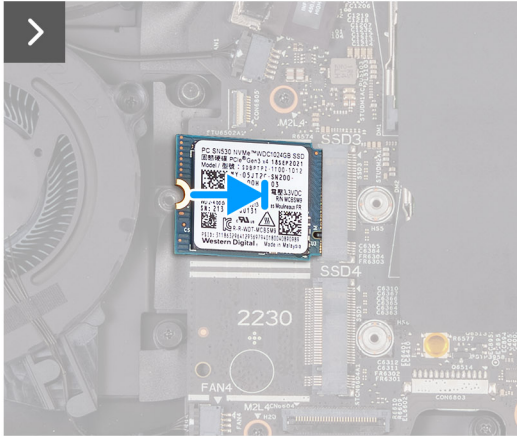
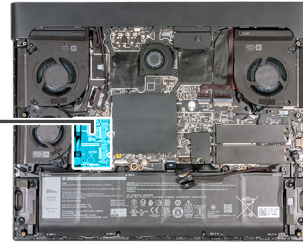

### Steps

1. Align the notch on the 2230 solid-state drive with the tab on the M.2 card slot on the system board.
2. Slide the 2230 solid-state drive into the M.2 card slot on the system board.
3. Align and place the solid-state drive thermal shield on the solid-state drive.
4. Align the screw hole on the solid-state drive thermal shield with the screw hole on the solid-state drive and palm-rest and keyboard assembly.
5. Replace the two screws (M2x3.5) that secure the 2230 thermal shield to the palm-rest and keyboard assembly.

### Next steps

1. Install the [base cover](#).
2. Follow the procedure in [After working inside your computer](#).

## Removing the 2280 solid-state drive in slot one and two

### Prerequisites

1. Follow the procedure in [Before working inside your computer](#).
2. Remove the [base cover](#).

### About this task

- NOTE:** This procedure applies only to computers shipped with an 2280 solid-state drive installed in M.2 slot one and two.
- NOTE:** The M.2 card installed on M.2 slot one and two will depend on the configuration ordered. Supported card configurations:
- 2230 solid-state drive
  - 2280 solid-state drive

The following image(s) indicate the location of the 2280 solid-state drive in slot one and two and provides a visual representation of the removal procedure.



2x  
M2x3.5

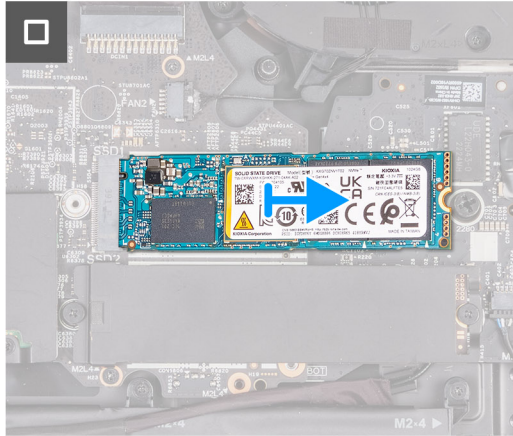
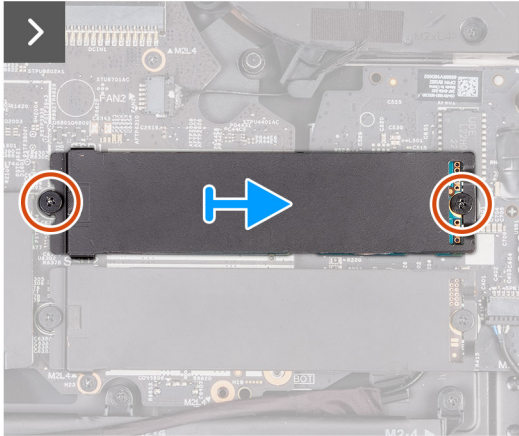
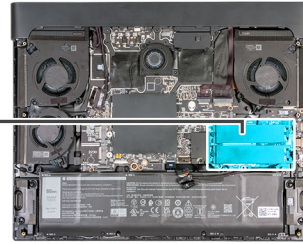

### Steps

1. Remove the two screws (M2x3.5) that secure the 2280 thermal shield to the palm-rest and keyboard assembly.
2. Lift the 2280 thermal shield off the solid-state drive.
3. Slide and lift the 2280 solid-state drive from the solid-state drive slot.

## Installing the 2280 solid-state drive in slot one and two

### Prerequisites

If you are replacing a component, remove the existing component before performing the installation process.

### About this task

**NOTE:** This procedure applies if you are installing a 2280 solid-state drive into M.2 slot one and two.

**NOTE:** Supported card configurations on M.2 slot one and two:

- 2230 solid-state drive
- 2280 solid-state drive

The following image(s) indicate the location of the 2280 solid-state drive in slot one and two and provides a visual representation of the installation procedure.



2x  
M2x3.5

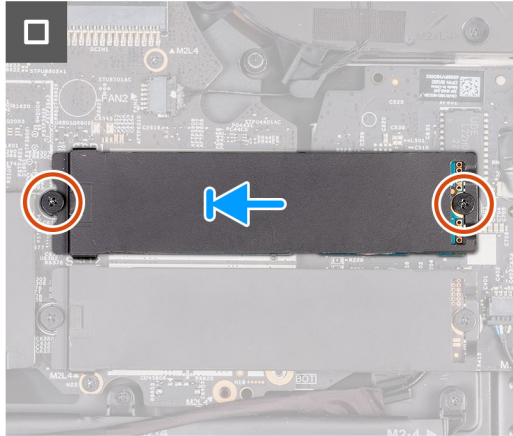
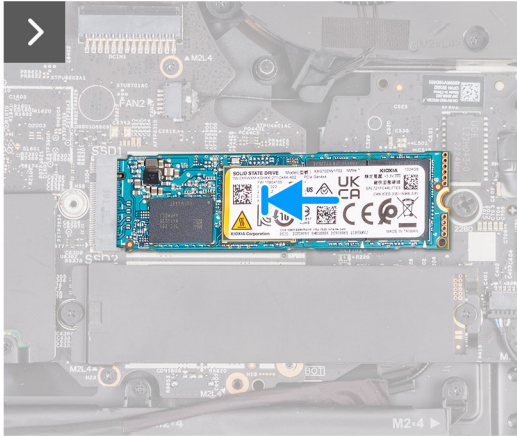
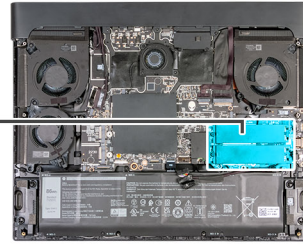
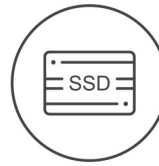

### Steps

1. Align the notch on the 2280 solid-state drive with the tab on the M.2 card slot on the system board.
2. Slide the 2280 solid-state drive into the M.2 card slot on the system board.
3. Slide the tab on the 2280 thermal shield into the M.2 card slot and align the screw holes on the thermal shield to the screw holes on the palm-rest and keyboard assembly.
4. Replace the two screws (M2x3.5) that secure the 2280 thermal shield to the palm-rest and keyboard assembly.

### Next steps

1. Install the [base cover](#).
2. Follow the procedure in [After working inside your computer](#).

## Procedure to move the screw mount in SSD slot one and two

### About this task

This computer supports two solid-state drive form factors in SSD slot one and two:

- M.2 2230
- M.2 2280

If you are replacing the current solid-state drive in SSD slot one and two, with another solid-state drive that is of a different form factor, see the following procedure to move the location of the screw mount in SSD slot one and two.

### Steps

1. Unscrew the screw mount from the palm-rest and keyboard assembly.
2. Slide the screw mount into the other screw mount slot on the palm-rest and keyboard assembly.



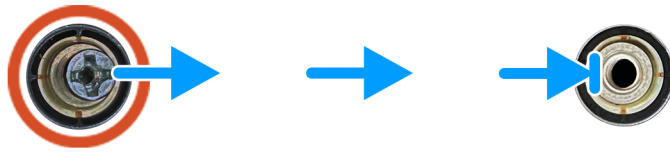

3. To install a 2230 solid-state drive in SSD slot three and four, see [installing the 2230 solid-state drive in SSD slot three and four](#).
4. To install a 2280 solid-state drive in SSD slot one and two, see [installing the 2280 solid-state drive in SSD slot one and two](#).

## Memory

### Removing the memory

#### Prerequisites

1. Follow the procedure in [Before working inside your computer](#).
2. Remove the [base cover](#).

#### About this task

**NOTE:** This computer may have up to two memory modules installed.

The following image(s) indicate the location of the memory and provides a visual representation of the removal procedure.

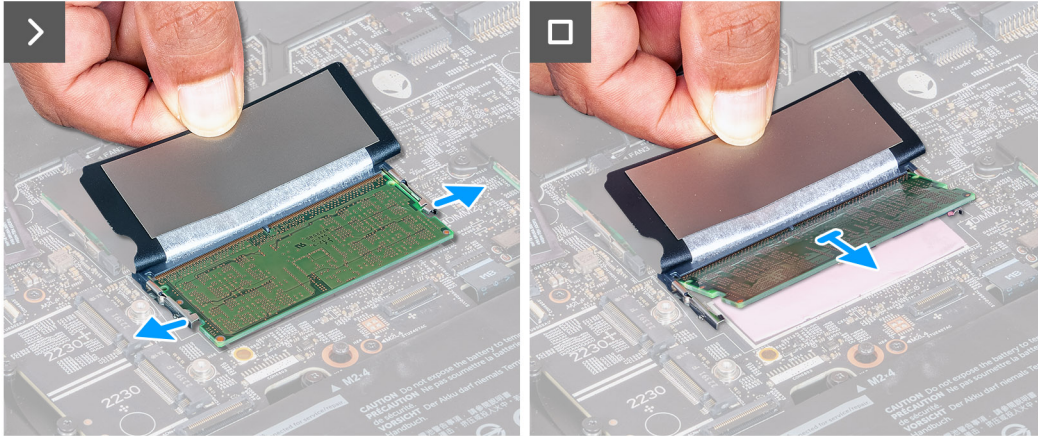
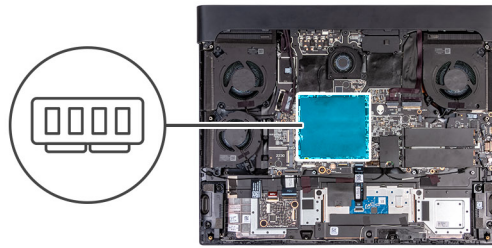

## Steps

1. Lift the Mylar to access the memory.
2. Use your fingertips to carefully spread apart the securing-clips on each end of the memory-module slot until the memory module pops up.
3. Slide and remove the memory module from the memory-module slot.

**⚠ CAUTION:** To prevent damage to the memory module, hold the memory module by the edges. Do not touch the components on the memory module.

**ⓘ NOTE:** Repeat the steps to remove any other memory module installed in your computer.

**ⓘ NOTE:** Note the slot and the orientation of the memory module in order to replace it in the correct slot.

**ⓘ NOTE:** If the memory module is difficult to remove, gently ease the memory module back and forth to remove it from the slot.

## Installing the memory

### Prerequisites

If you are replacing a component, remove the existing component before performing the installation process.

### About this task

**ⓘ NOTE:** Up to two memory modules may be installed into this computer.

The following image(s) indicate the location of the memory and provides a visual representation of the installation procedure.

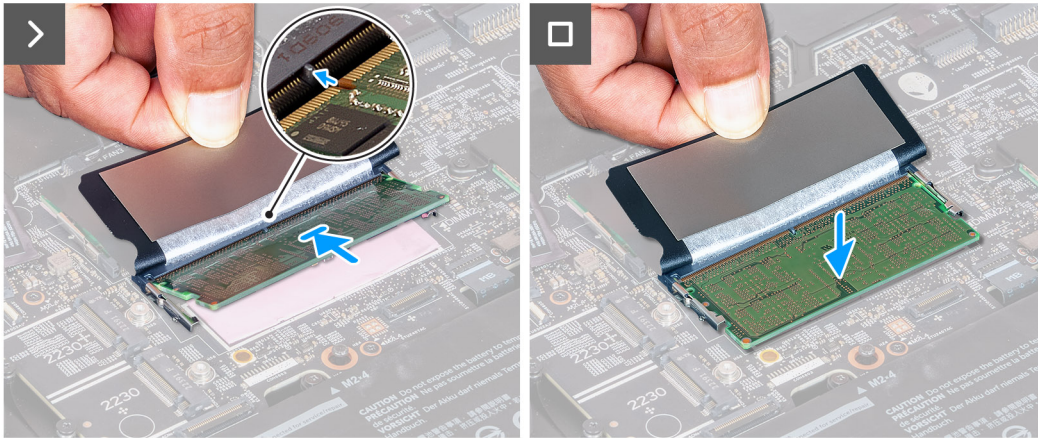
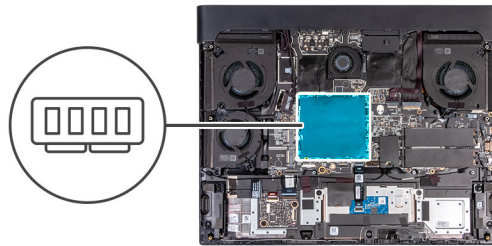

### Steps

1. Lift the Mylar to access the memory module.
2. Align the notch on the memory module with the tab on the memory-module slot.
3. Slide the memory module firmly at an angle, into the memory-module slot.
4. Press the memory module down until it clicks into place.

 **CAUTION:** To prevent damage to the memory module, hold the memory module by the edges. Do not touch the components on the memory module.

 **NOTE:** Repeat the steps to install a second memory into your computer.

 **NOTE:** The securing clips return to a locked position. If you do not hear the click, remove the memory module and reinstall it.

### Next steps

1. Install the [base cover](#).
2. Follow the procedure in [After working inside your computer](#).

## Wireless card

### Removing the wireless card

#### Prerequisites

1. Follow the procedure in [Before working inside your computer](#).
2. Remove the [base cover](#).

#### About this task

The following image(s) indicate the location of the wireless card and provides a visual representation of the removal procedure.



2x  
M2x2.5

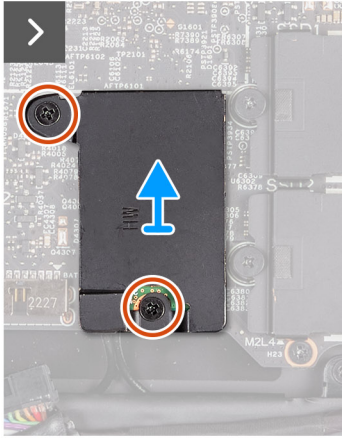
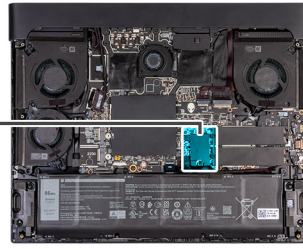

### Steps

1. Remove the two screws (M2x2.5) that secures the wireless-card thermal shield to the wireless card and palm-rest and keyboard assembly.
2. Slide and lift the wireless-card thermal shield off the wireless card.
3. Disconnect the antenna cables from the wireless card.
4. Slide and remove the wireless card at an angle from the wireless-card slot.

## Installing the wireless card

### Prerequisites

If you are replacing a component, remove the existing component before performing the installation process.

### About this task

The following image(s) indicate the location of the wireless card and provides a visual representation of the installation procedure.



2x  
M2x2.5

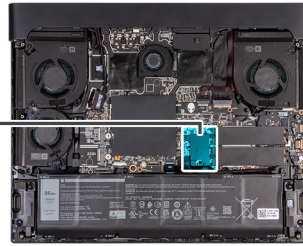

### Steps

1. Connect the antenna cables to the wireless card.

**NOTE:** The following table provides the antenna-cable color scheme for the wireless card that is supported by your computer.

**Table 2. Antenna-cable color scheme**

Connectors on the wireless card	Antenna-cable color	Silkscreen marking	
Main	White	MAIN	△ (white triangle)
Auxiliary	Black	AUX	▲ (black triangle)

2. Align the notch on the wireless card with the tab on the wireless-card slot and insert the wireless card at an angle into the wireless-card slot.
3. Align the screw hole on the wireless-card thermal shield with the screw hole on the wireless card and palm-rest and keyboard assembly.
4. Replace the screw (M2x2.5) that secures the wireless-card bracket to the wireless card and the palm-rest and keyboard assembly.

### Next steps

1. Install the [base cover](#).
2. Follow the procedure in [After working inside your computer](#).

## Fan

### Removing the small fan

#### Prerequisites

1. Follow the procedure in [Before working inside your computer](#).
2. Remove the [base cover](#).

### About this task

The following image(s) indicate the location of the small fan and provides a visual representation of the removal procedure.



3x  
M2x4

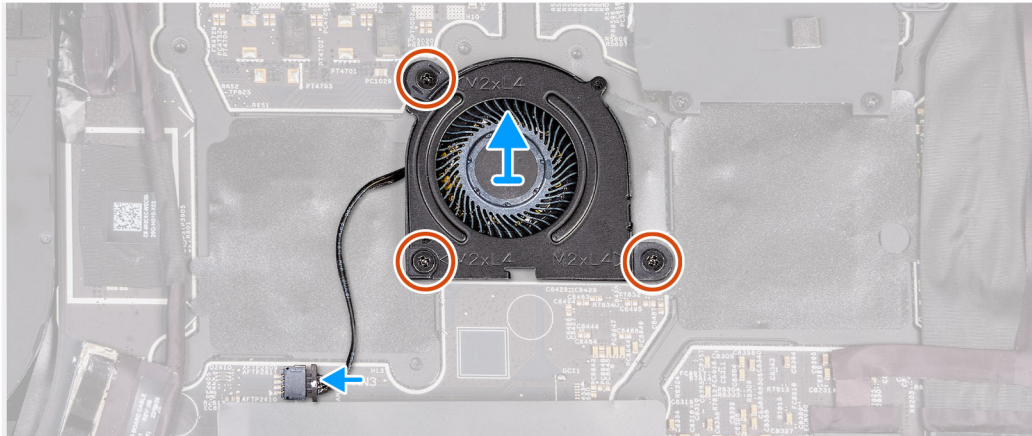
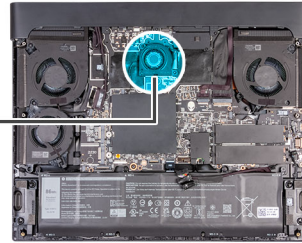
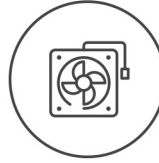

### Steps

1. Disconnect the fan cable from the system board.
2. Remove the three screws (M2x4) that secure the fan to the palm-rest and keyboard assembly.
3. Lift the fan from the system board.

## Installing the small fan

### Prerequisites

If you are replacing a component, remove the existing component before performing the installation process.

### About this task

The following image(s) indicate the location of the rear-I/O cover and provides a visual representation of the installation procedure.



**3x**  
M2x4

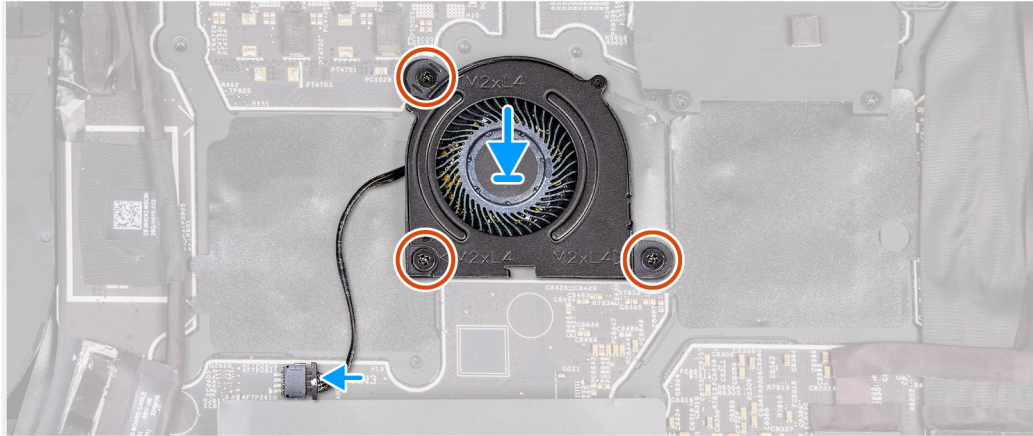
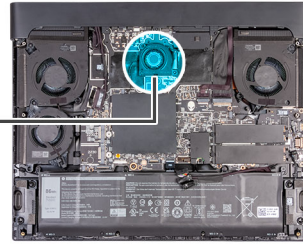
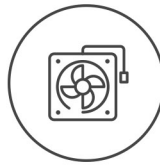

### Steps

1. Place and align the screws on the system board with the screw holes on the fan.
2. Replace the three screws (M2x4) that secure the fan to the palm-rest and keyboard assembly.
3. Connect the fan cable to the system board.

### Next steps

1. Install the [base cover](#).
2. Follow the procedure in [After working inside your computer](#).

## Rear-I/O cover

### Removing the rear-I/O cover

#### Prerequisites

1. Follow the procedure in [Before working inside your computer](#).
2. Remove the [base cover](#).

#### About this task

The following image(s) indicate the location of the rear-I/O cover and provides a visual representation of the removal procedure.

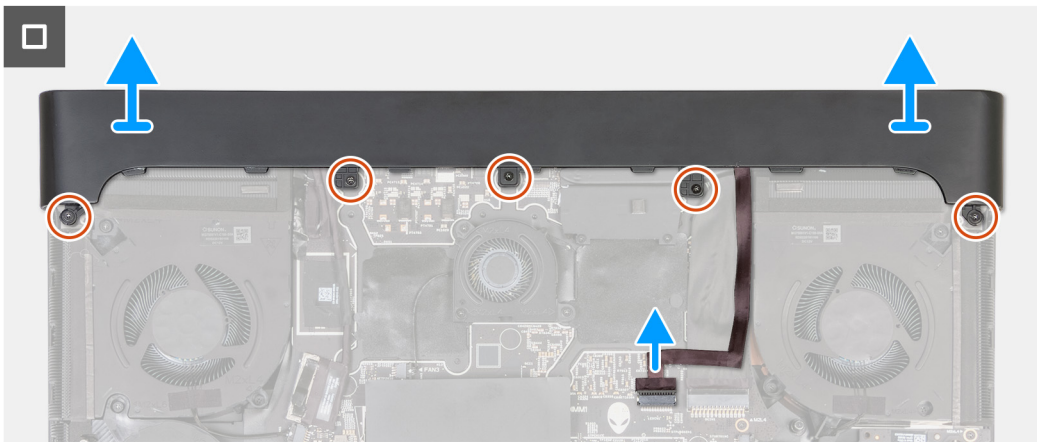
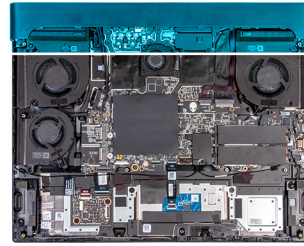

### Steps

1. Remove the two screws (M2.5x5) that secure the rear I/O-cover to the palm-rest and keyboard assembly.
2. Remove the five screws (M2x4) that secure the rear I/O-cover to the palm-rest and keyboard assembly.
3. Disconnect the Tron-light cable from the system board.
4. Firmly grasp the sides of your computer with both hands and push the rear I/O-cover outwards with your thumbs to release the rear I/O-cover from the palm-rest and keyboard assembly.
5. Remove the rear I/O-cover from the palm-rest and keyboard assembly.

## Installing the rear-I/O cover

### Prerequisites

If you are replacing a component, remove the existing component before performing the installation process.

### About this task

The following image(s) indicate the location of the rear-I/O cover and provides a visual representation of the installation procedure.



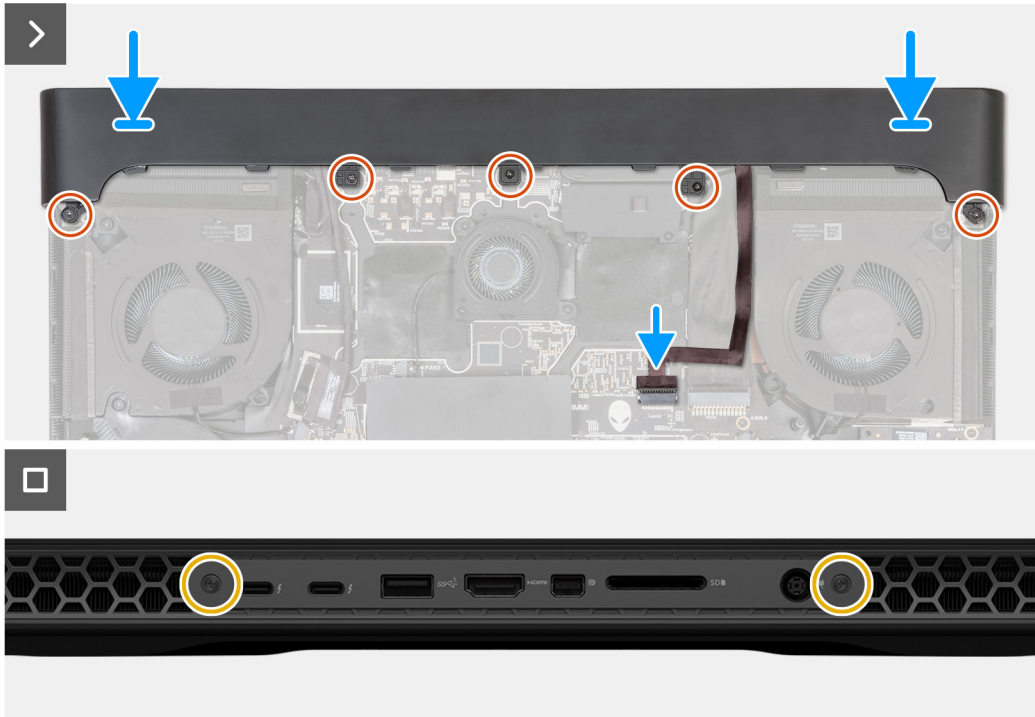
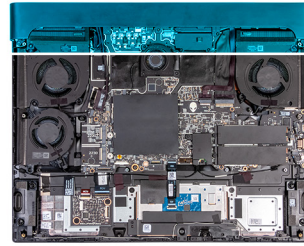

### Steps

1. With the correct orientation, slide the rear I/O-cover into the palm-rest and keyboard assembly, and snap it into place.
2. Replace the five screws (M2x4) that secure the rear I/O-cover to the palm-rest and keyboard assembly.
3. Connect the Tron-light cable to the system board.
4. Replace the two screws (M2.5x5) that secure the rear I/O-cover to the palm-rest and keyboard assembly.

### Next steps

1. Install the [base cover](#).
2. Follow the procedure in [After working inside your computer](#).

## I/O board

### Removing the I/O board

#### Prerequisites

1. Follow the procedure in [Before working inside your computer](#).
2. Remove the [base cover](#).
3. Remove the [battery](#).
4. Remove the [wireless card](#).
5. Remove the [2230 solid-state drive](#) in slot three and four.
6. Remove the [2280 solid state drive](#) or [2230 solid-state drive](#) in slot one and two, whichever applicable.

7. Remove the [small fan](#).
8. Remove the [top heat-sink](#).
9. Remove the [rear-I/O cover](#).
10. Follow the procedure from step 1 to step 9 in [Removing the system board](#).

**NOTE:** The system board can be removed and installed along with the fan and heat sink. This simplifies the removal and installation procedure and avoids breaking the thermal bond between the system board and heat sink.

### About this task

The following image(s) indicate the location of the I/O board and provides a visual representation of the removal procedure.



4x  
M2x2.5

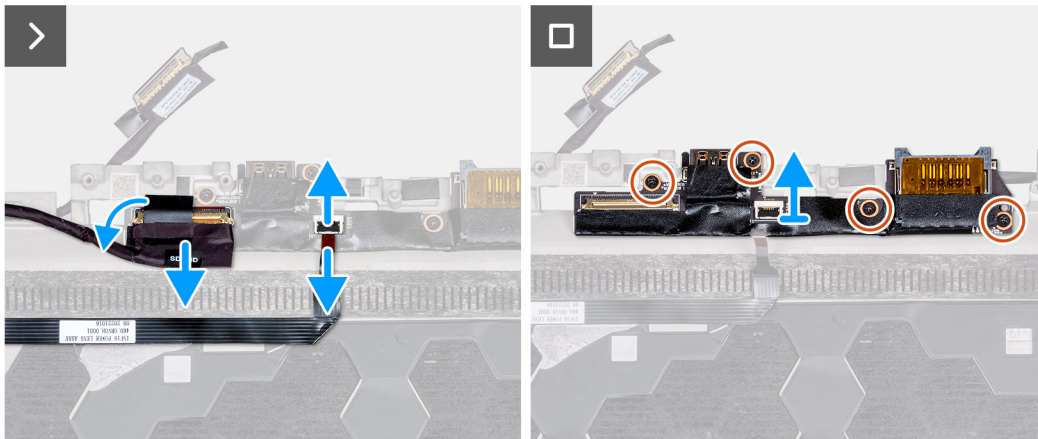
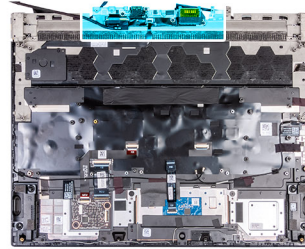

### Steps

1. Peel the tape securing the I/O board cable to the palm-rest and keyboard assembly.
2. Open the latch and disconnect the I/O board cable from the palm-rest and keyboard assembly.
3. Open the latch and disconnect the power-button cable from the I/O board.
4. Remove the four screws (M2x2.5) that secure the I/O board to the palm-rest and keyboard assembly.
5. Lift the I/O board off the palm-rest and keyboard assembly.

## Installing the I/O board

### Prerequisites

If you are replacing a component, remove the existing component before performing the installation process.

### About this task

The following image(s) indicate the location of the I/O board and provides a visual representation of the installation procedure.



4x  
M2x2.5

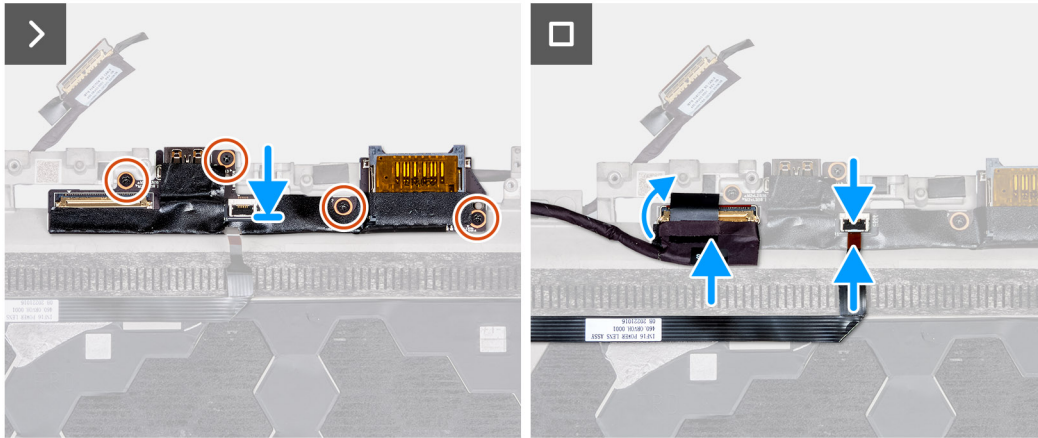
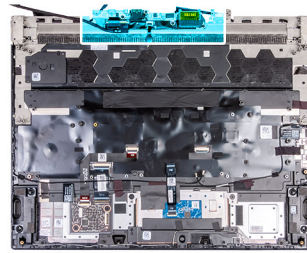

### Steps

1. Align the screw holes on the I/O board with the screw holes on the palm-rest and keyboard assembly.
2. Replace the four screws (M2x2.5) that secure the I/O board to the palm-rest and keyboard assembly.
3. Connect the I/O board cable to the palm-rest and keyboard assembly and adhere the tape to secure the I/O board cable.
4. Connect the power-button cable and close the latch to secure the cable.

### Next steps

1. Follow the procedure from step 1 to step 8 in [Installing the system board](#).  
**NOTE:** The system board can be removed and installed along with the fan and heat sink. This simplifies the removal and installation procedure and avoids breaking the thermal bond between the system board and heat sink.
2. Install the [2230 solid-state drive](#) in slot three and four.
3. Install the [2280 solid-state drive](#) or [2230 solid-state drive](#) in slot one and two, whichever applicable.
4. Install the [rear-I/O cover](#).
5. Install the [small fan](#).
6. Install the [top heat-sink](#).
7. Install the [wireless card](#).
8. Install the [battery](#).
9. Install the [base cover](#).
10. Follow the procedure in [After working inside your computer](#).

## Speakers

### Removing the speakers

#### Prerequisites

1. Follow the procedure in [Before working inside your computer](#).
2. Remove the [base cover](#).
3. Remove the [battery](#).

### About this task

The following image(s) indicate the location of the speakers and provides a visual representation of the removal procedure.

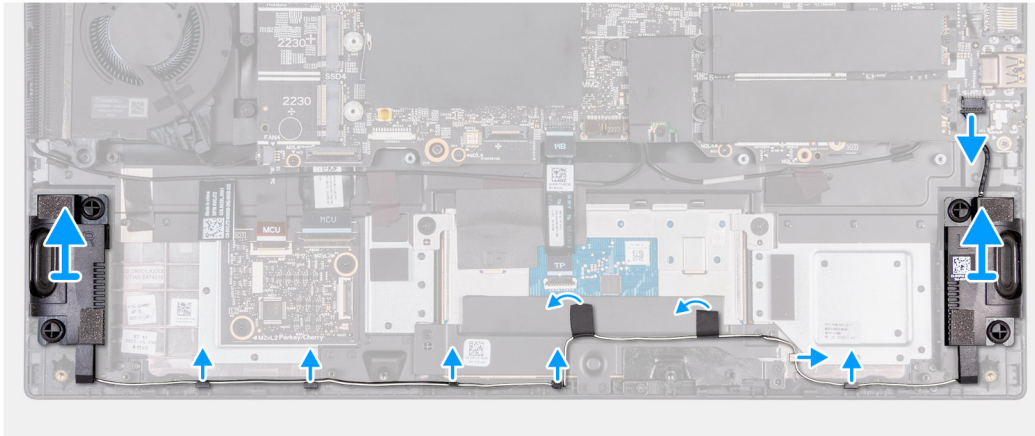
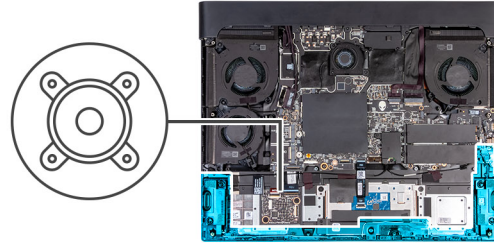

### Steps

1. Disconnect the speaker cable from the system board.
2. Peel the tapes that secure the speaker cable to the palm-rest and keyboard assembly.
3. Remove the speaker cable from the routing guides on the palm-rest and keyboard assembly.
4. Lift the right and left speaker, along with its cable, off the palm-rest and keyboard assembly.

## Installing the speakers

### Prerequisites

If you are replacing a component, remove the existing component before performing the installation process.

### About this task

The following image(s) indicate the location of the speakers and provides a visual representation of the installation procedure.

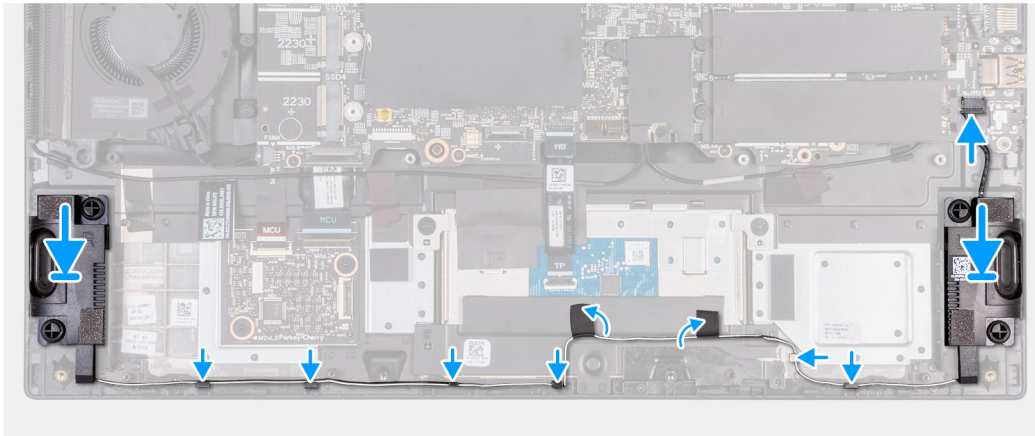
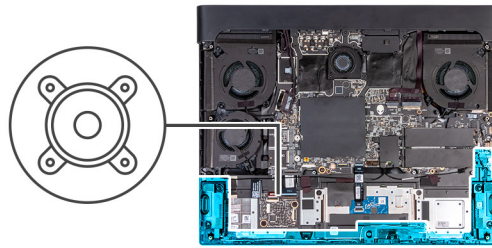

### Steps

1. Using the alignment posts, place the left and right speakers into their slots on the palm-rest and keyboard assembly.
  - (i) NOTE:** Ensure that the alignment posts are threaded through the rubber grommets on the speaker.
2. Route the speaker cable through the routing guides on the palm-rest and keyboard assembly.
3. Adhere the tape that secures the speaker cable to the palm-rest and keyboard assembly.
4. Connect the speaker cable to the system board.

### Next steps

1. Install the [battery](#).
2. Install the [base cover](#).
3. Follow the procedure in [After working inside your computer](#).

## Power-adapter port

### Removing the power-adapter port

#### Prerequisites

1. Follow the procedure in [Before working inside your computer](#).
2. Remove the [base cover](#).
3. Remove the [rear-I/O cover](#).
4. Remove the [top heat-sink](#).

#### About this task

The following image(s) indicate the location of the power-adapter port and provides a visual representation of the removal procedure.



2x  
M2x4

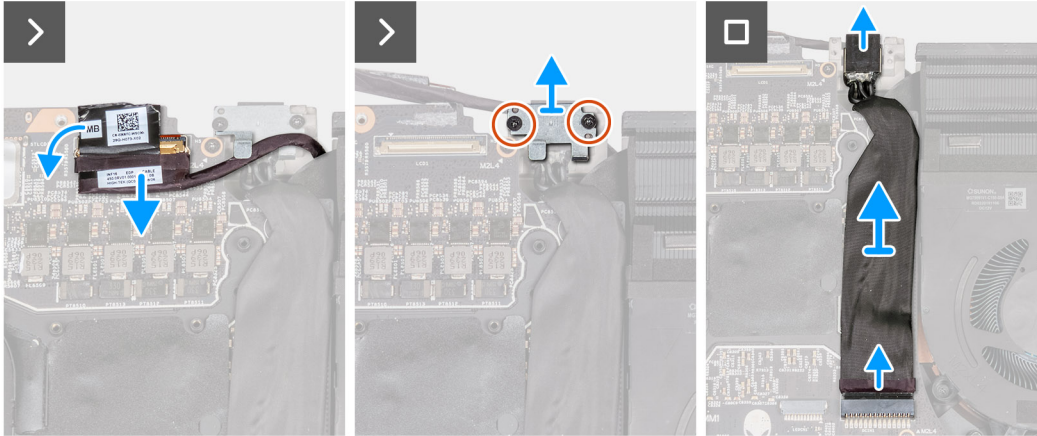

### Steps

1. Peel the tape that secures the display-cable connector latch to the system board.
2. Open the latch and disconnect the display cable from the system board.
3. Remove the two screws (M2x4) that secure the power-adapter port-bracket to the palm-rest and keyboard assembly.
4. Lift the power-adapter port bracket off the palm-rest and keyboard assembly.
5. Disconnect the power-adapter port-cable from the system board.
6. Peel the power-adapter port-cable from the Mylar.

## Installing the power-adapter port

### Prerequisites

If you are replacing a component, remove the existing component before performing the installation process.

### About this task

The following image(s) indicate the location of the power-adapter port and provides a visual representation of the installation procedure.



2x  
M2x4

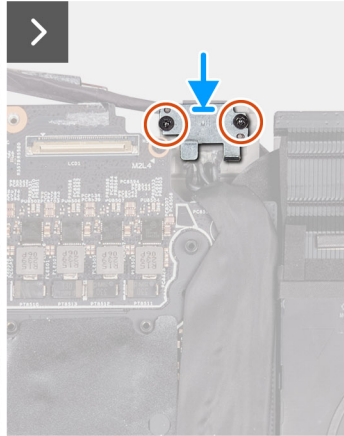
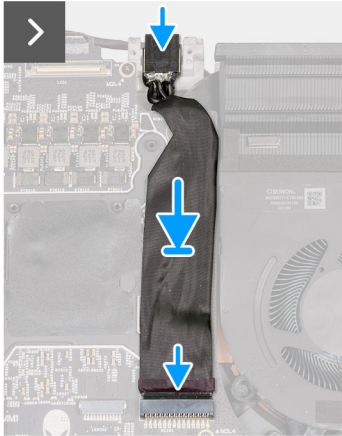
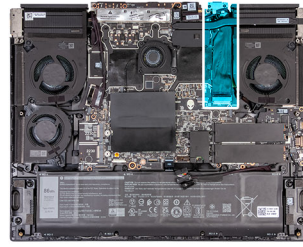

### Steps

1. Slide the power-adapter port at an angle into the slot on the palm-rest and keyboard assembly and adhere the power-adapter port cable to the Mylar.
2. Connect the power-adapter port cable to the system board.
3. Place the power-adapter port bracket on the power-adapter port.
4. Align the screw holes on the power-adapter port bracket to the screw holes on the palm-rest and keyboard assembly.
5. Replace the two screws (M2x4) that secure the power-adapter port bracket to the palm-rest and keyboard assembly.
6. Adhere the display cable to the system board.
7. Connect the display cable to the system board and close the latch to secure the cable.
8. Adhere the tape that secures the display-cable connector latch to the system board.

### Next steps

1. Install the [top heat-sink](#).
2. Install the [rear-I/O cover](#).
3. Install the [base cover](#).
4. Follow the procedure in [After working inside your computer](#).

## Touchpad

### Removing the touchpad

#### Prerequisites

1. Follow the procedure in [Before working inside your computer](#).
2. Remove the [base cover](#).
3. Remove the [battery](#).
4. Remove the [speakers](#).

#### About this task

The following image(s) indicate the location of the touchpad and provides a visual representation of the removal procedure.

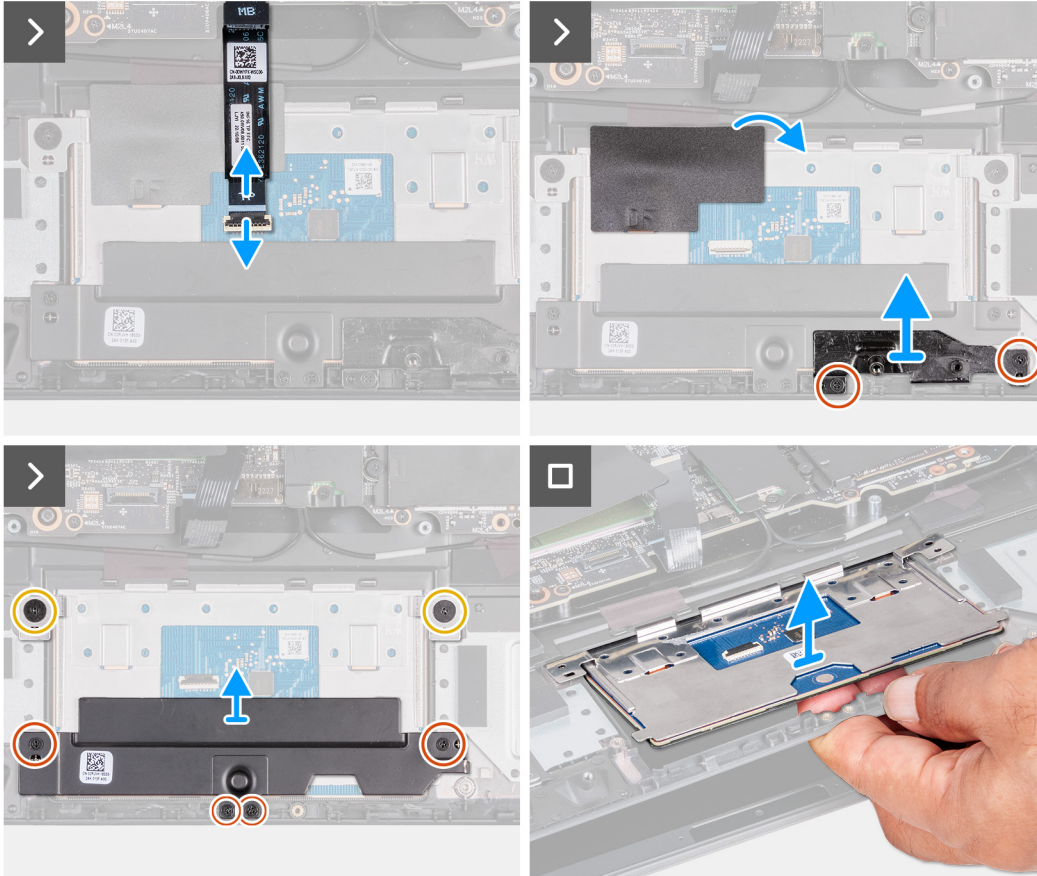
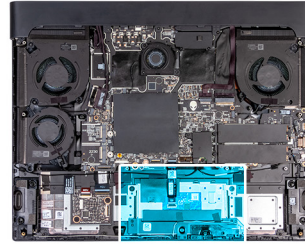

## Steps

1. Open the latch and disconnect the touchpad cable from the touchpad.
2. Peel the tape that secures the touchpad to the palm-rest and keyboard assembly.
3. Remove the two screws (M2x2.5) that secure the touchpad bracket to the palm-rest and keyboard assembly.
4. Remove the two screws (M2x2) that secure the touchpad to the palm-rest and keyboard assembly.
5. Remove the four screws (M2x2.5) that secure the touchpad bracket to the palm-rest and keyboard assembly.
6. Lift the touchpad bracket off the palm-rest and keyboard assembly.
7. Lift the touchpad from the palm-rest and keyboard assembly.

## Installing the touchpad

### Prerequisites

If you are replacing a component, remove the existing component before performing the installation process.

### About this task

The following image(s) indicate the location of the touchpad and provides a visual representation of the installation procedure.



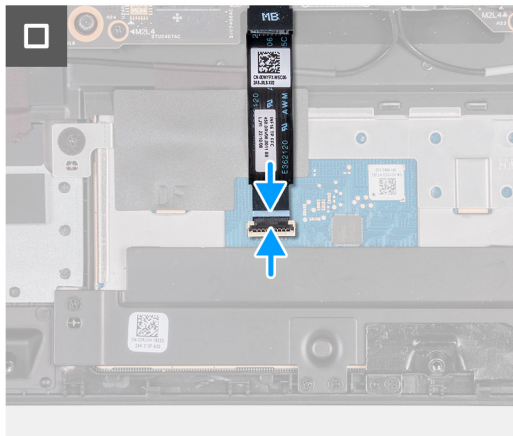
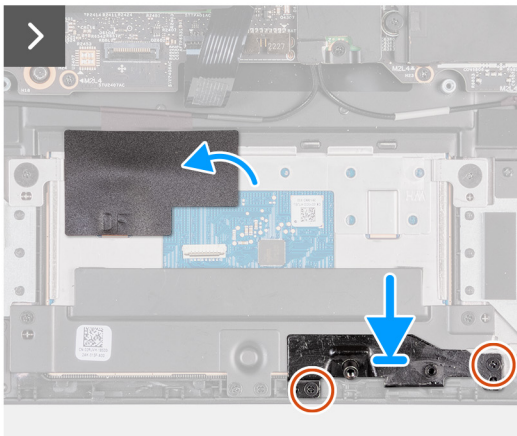
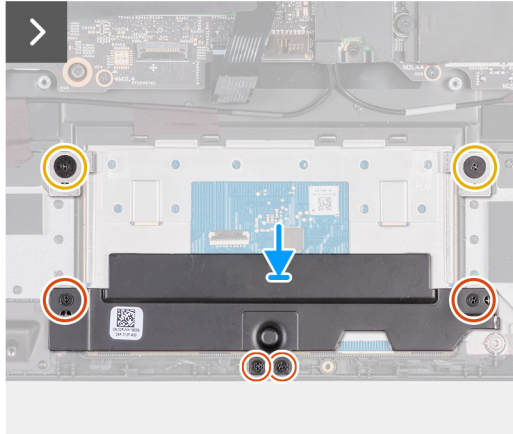
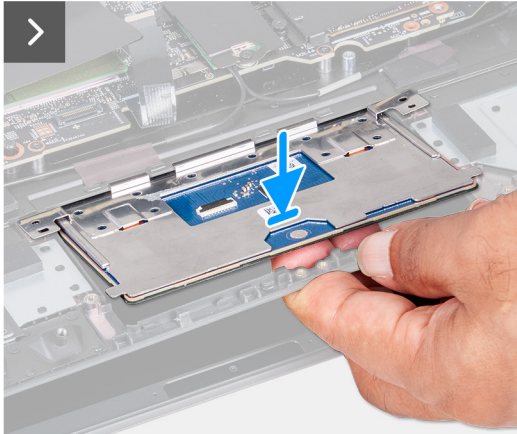
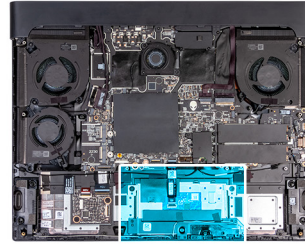

### Steps

1. At an angle slide the touchpad into the slot on the palm-rest and keyboard assembly.
2. Turn the computer over and open the display to ensure that the touchpad is equally aligned on all sides.

**(i) NOTE:** The image below shows the proper touchpad alignment for your computer.

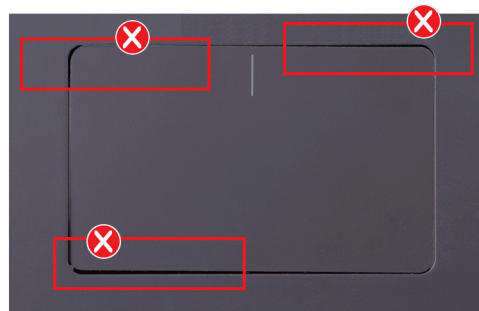

3. Close the display and turn the computer over.
4. Replace the two screws (M2x2) that secure the touchpad to the palm-rest and keyboard assembly.
5. Align the screw holes on the touchpad bracket to the screw holes on the palm-rest and keyboard assembly.

6. Replace the four screws (M2x2.5) that secure the touchpad bracket to the palm-rest and keyboard assembly.
7. Adhere the tape that secures the touchpad to the palm-rest and keyboard assembly.
8. Replace the two screws (M2x2.5) that secure the touchpad bracket to the palm-rest and keyboard assembly.
9. Connect the touchpad cable to the touchpad and close the latch to secure the cable.

#### Next steps

1. Install the [battery](#).
2. Install the [speakers](#).
3. Install the [base cover](#).
4. Follow the procedure in [After working inside your computer](#).

## Antennas

### Removing the antennas

#### Prerequisites

1. Follow the procedure in [Before working inside your computer](#).
2. Remove the [base cover](#).
3. Remove the [battery](#).
4. Remove the [wireless card](#).
5. Remove the [2230 solid-state drive](#) in slot three and four.
6. Remove the [2280 solid state drive](#) or [2230 solid-state drive](#) in slot one and two, whichever applicable.
7. Remove the [small fan](#).
8. Remove the [top heat-sink](#).
9. Remove the [rear-I/O cover](#).
10. Follow the procedure from step 1 to step 9 in [Removing the system board](#).

**NOTE:** The system board can be removed and installed along with the fan and heat sink. This simplifies the removal and installation procedure and avoids breaking the thermal bond between the system board and heat sink.

#### About this task

The following image(s) indicate the location of the antennas and provides a visual representation of the removal procedure.



4x  
M2.5x5

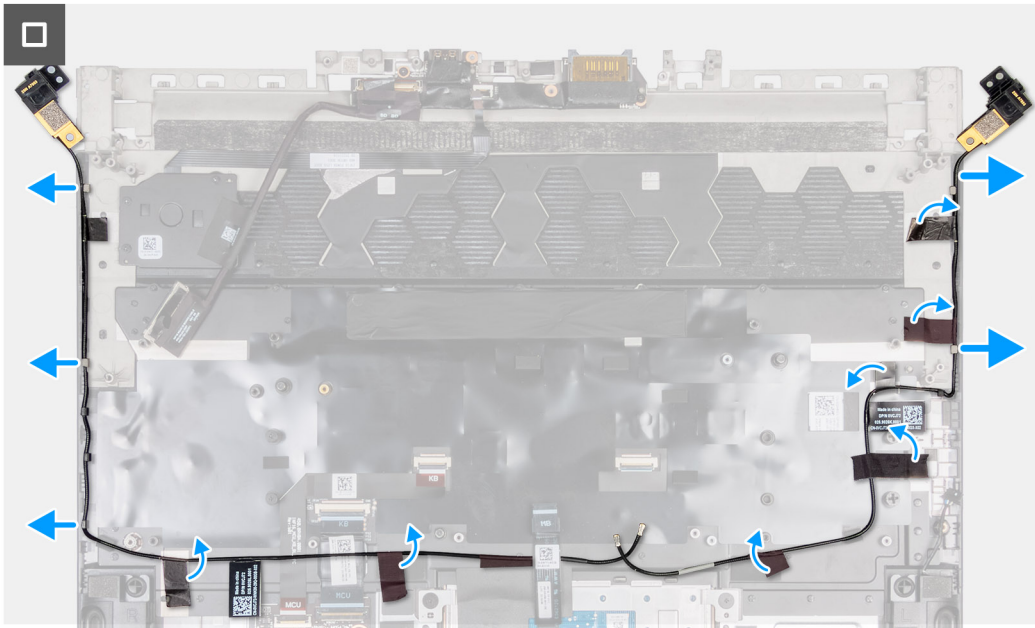
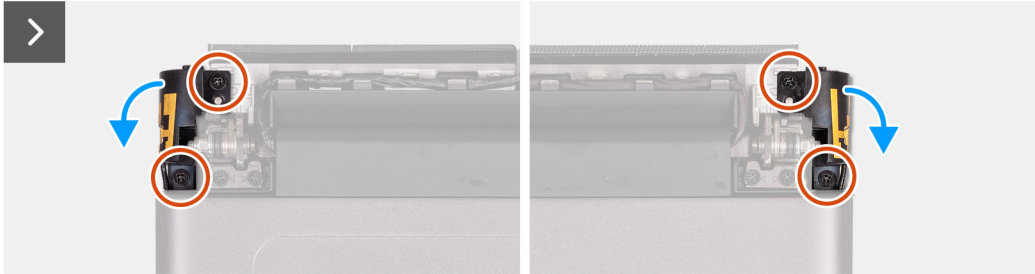
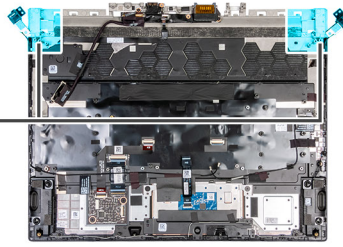

### Steps

1. Turn the computer over.
2. Remove the four screws (M2.5x5) that secure the antenna holder to the display assembly.
3. Disconnect the antenna holder from the display assembly.
4. Remove the antenna cables from the routing guides on the palm-rest and keyboard assembly.

## Installing the antennas

### Prerequisites

If you are replacing a component, remove the existing component before performing the installation process.

### About this task

The following image(s) indicate the location of the antennas and provides a visual representation of the installation procedure.



4x  
M2.5x5

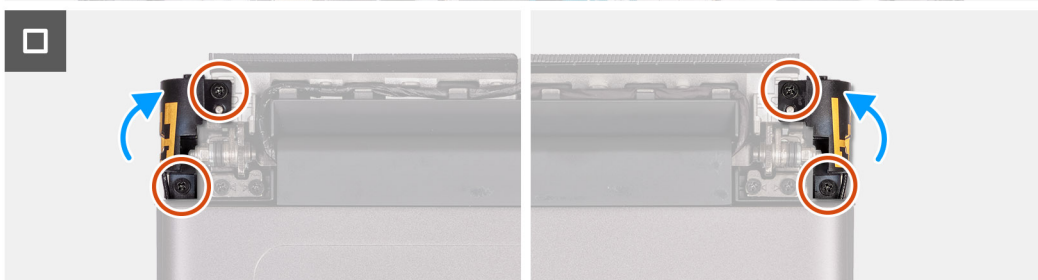
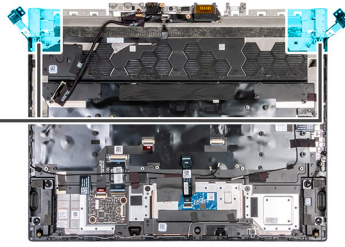

## Steps

1. Route the antenna cables through the routing guides on the palm-rest and keyboard assembly.
2. Align the screw holes on the antenna holder with the screw holes on the display assembly.
3. Replace the four screws (M2.5x5) that secure the antenna holder to the display assembly.
4. Turn over the computer.

## Next steps

1. Follow the procedure from step 1 to step 8 in [Installing the system board](#).  
**(i) NOTE:** The system board can be removed and installed along with the fan and heat sink. This simplifies the removal and installation procedure and avoids breaking the thermal bond between the system board and heat sink.
2. Install the [2230 solid-state drive](#) in slot three and four.
3. Install the [2280 solid-state drive](#) or [2230 solid-state drive](#) in slot one and two, whichever applicable.
4. Install the [rear-I/O cover](#).
5. Install the [small fan](#).
6. Install the [top heat-sink](#)
7. Install the [wireless card](#).
8. Install the [battery](#).
9. Install the [base cover](#).

10. Follow the procedure in [After working inside your computer.](#)

## Display assembly

### Removing the display assembly

#### Prerequisites

1. Follow the procedure in [Before working inside your computer.](#)
2. Remove the [base cover.](#)
3. Remove the [rear-I/O cover.](#)

#### About this task

The following image(s) indicate the location of the display assembly and provides a visual representation of the removal procedure.



10x  
M2.5x5

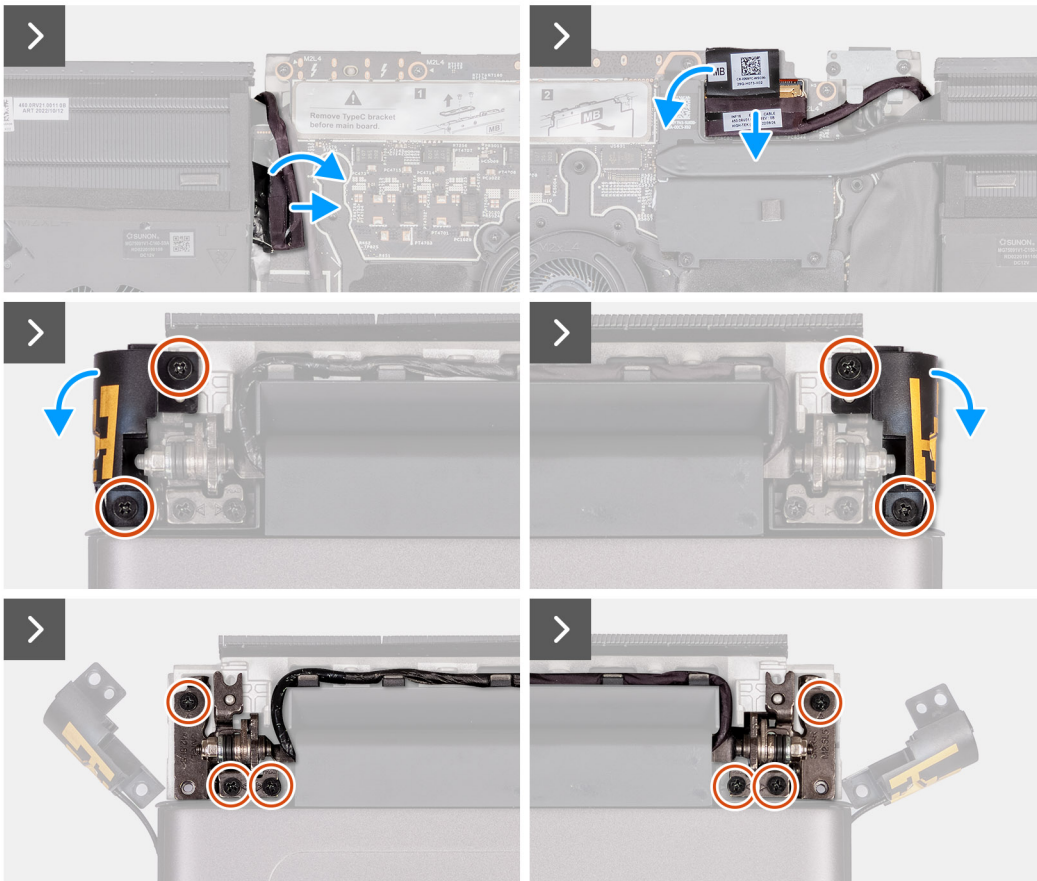

#### Steps

1. Peel the tape securing the camera cable to the system board.
2. Disconnect the camera cable from the system board.
3. Disconnect the display cable from the system board.

4. Peel the tapes securing the display cable to the system board and lift the display cable off the system board.
5. Turn the computer over.
6. Remove the four screws (M2.5x5) that secure the antenna holder to the palm-rest and keyboard assembly.
7. Remove the six screws (M2.5x5) that secure the display assembly to the palm-rest and keyboard assembly.



8. Lift the display assembly off the palm-rest and keyboard assembly.

## Installing the display assembly

### Prerequisites

If you are replacing a component, remove the existing component before performing the installation process.

### About this task

The following image(s) indicate the location of the display assembly and provides a visual representation of the installation procedure.



**10x**  
M2.5x5

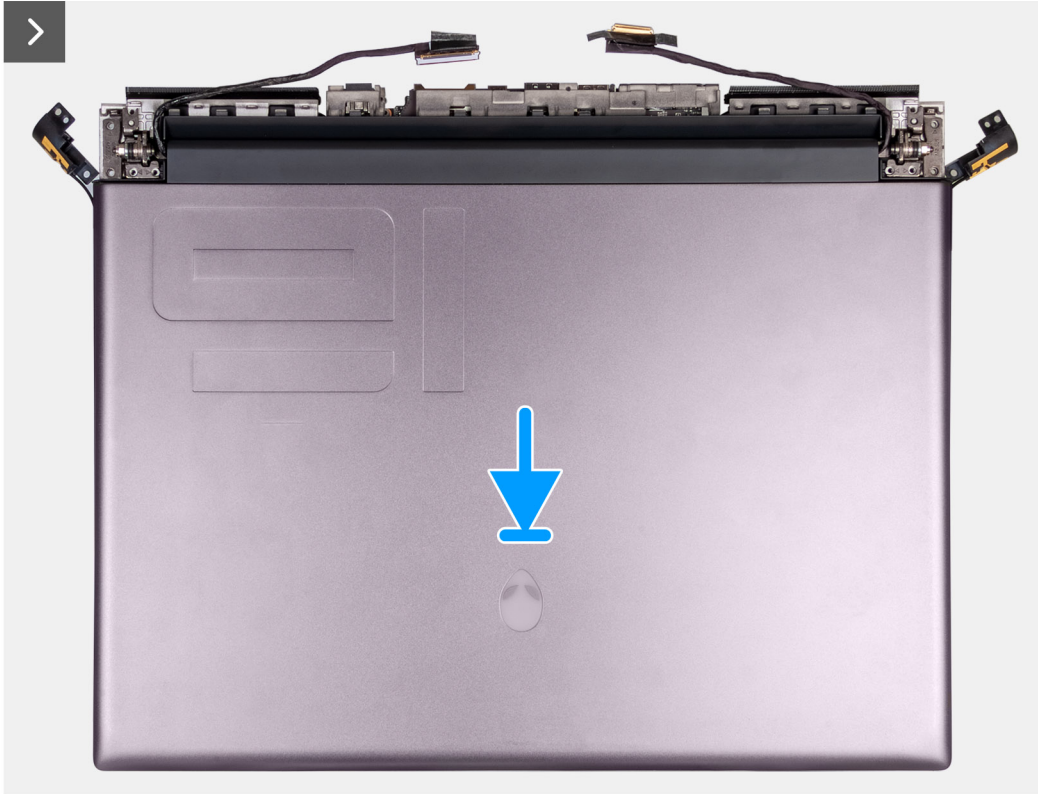
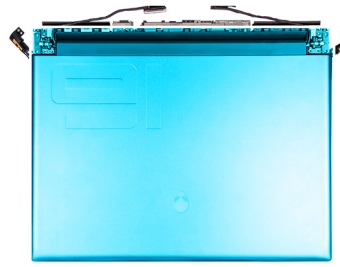

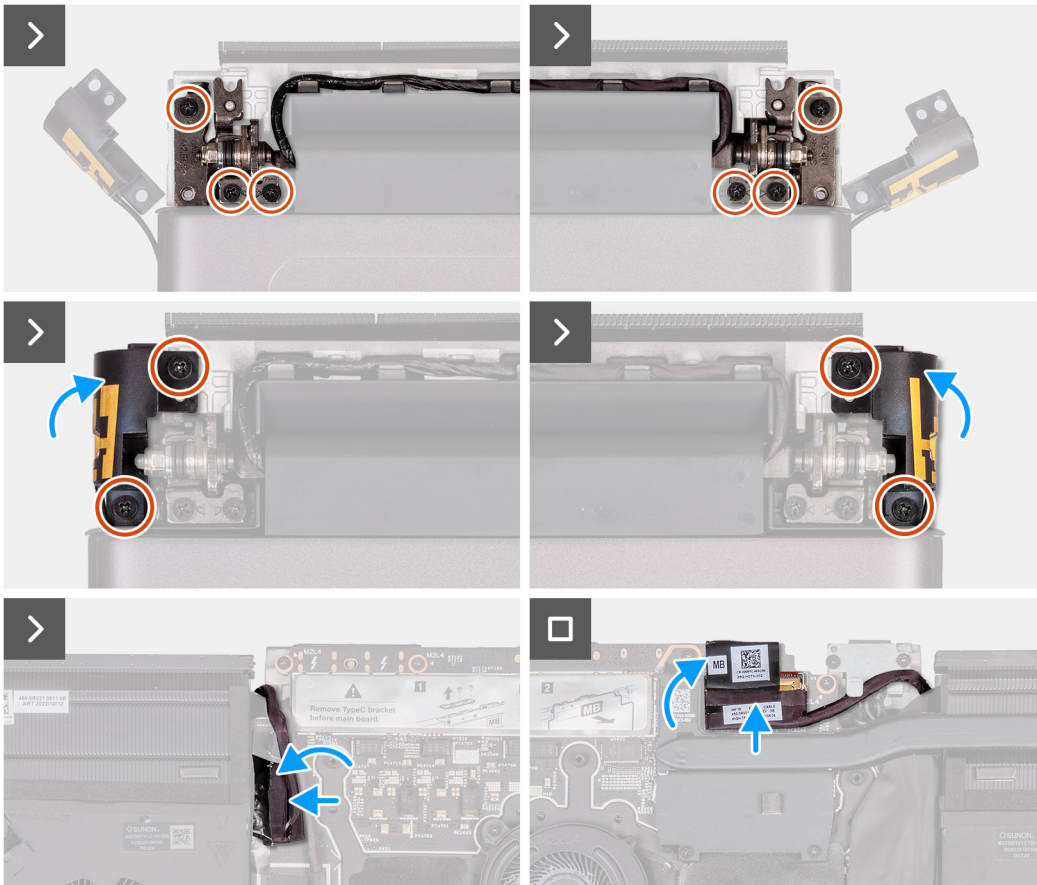

## Steps

1. Place the display assembly on the palm-rest and keyboard assembly.

**⚠ CAUTION: To avoid damaging the display, do not slide display assembly over the palm-rest and keyboard assembly.**

2. Align the screw holes on the display assembly to the screw holes on the palm-rest and keyboard assembly.
3. Replace the six screws (M2.5x5) that secure the display assembly to the palm-rest and keyboard assembly.
4. Place the antenna holder on the palm-rest and keyboard assembly.
5. Replace the four screws (M2.5x5) that secure the antenna holder to the palm-rest and keyboard assembly.
6. Turn over the computer.
7. Adhere the tape that secures the camera cable to the palm-rest and keyboard assembly.
8. Adhere the camera cable to the system board.
9. Connect the display cable to the system board and close the latch to secure the cable.
10. Adhere the tape that secures the display-cable connector latch to the system board.

## Next steps

1. Install the [rear-I/O cover](#).
2. Install the [base cover](#).
3. Follow the procedure in [After working inside your computer](#).



# Top heat-sink

## Removing the top heat-sink

### Prerequisites

1. Follow the procedure in [Before working inside your computer](#).
2. Remove the [base cover](#).
3. Remove the [rear-I/O cover](#).

### About this task

**CAUTION:** The heat sink may become hot during normal operation. Allow sufficient time for the heat sink to cool before you touch it.

**NOTE:** For maximum cooling of the processor, do not touch the heat transfer areas on the heat sink. The oils in your skin can reduce the heat transfer capability of the thermal grease.

The following image(s) indicate the location of the top heat-sink and provides a visual representation of the removal procedure.



4x  
M2x2.5

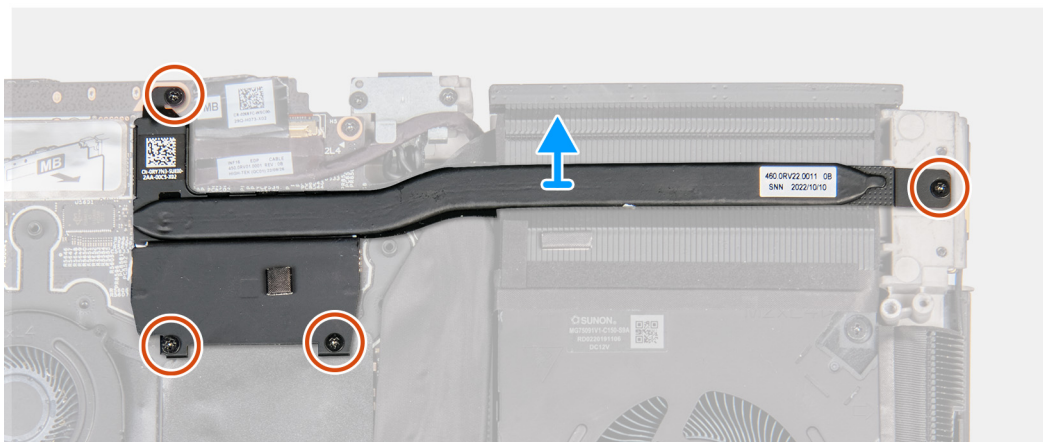
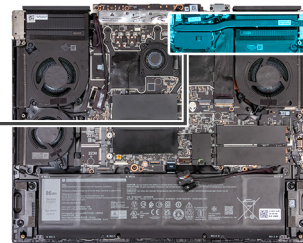

### Steps

1. Remove the four screws (M2x2.5) that secures the top heat-sink to the system board.
2. Lift the top heat-sink off the system board.

## Installing the top heat-sink

### Prerequisites

If you are replacing a component, remove the existing component before performing the installation process.

### About this task

The following image(s) indicate the location of the top heat-sink assembly and provides a visual representation of the installation procedure.



4x  
M2x2.5

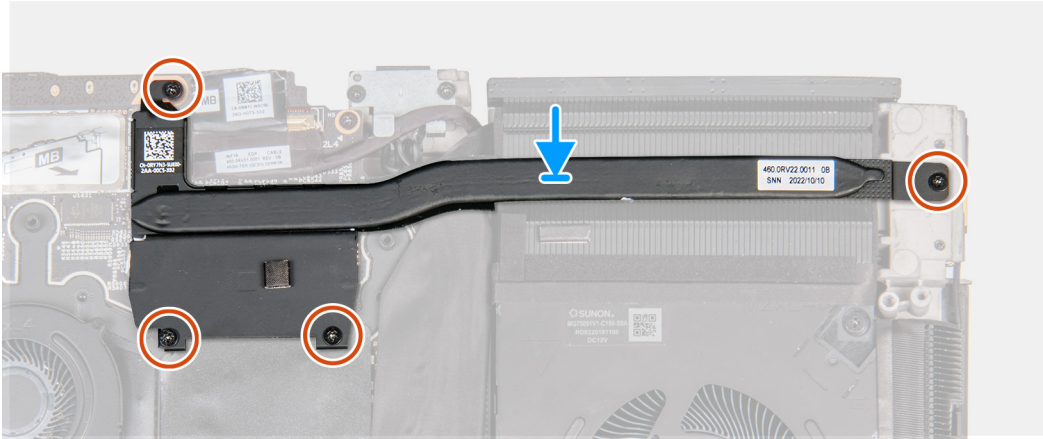
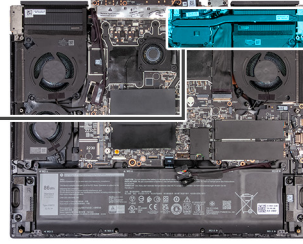

### Steps

1. Place the top heat-sink on the system board.
2. Align the screw holes on the top heat-sink to the screw holes on the system board.
3. Replace the four screws (M2x2.5) that secure the top heat-sink to the system board.

### Next steps

1. Install the [rear-I/O cover](#).
2. Install the [base cover](#).
3. Follow the procedure in [After working inside your computer](#).

## Keyboard-controller board

### Removing the keyboard-controller board

#### Prerequisites

1. Follow the procedure in [Before working inside your computer](#).
2. Remove the [base cover](#).
3. Remove the [battery](#).

#### About this task

The following image(s) indicate the location of the keyboard-controller board and provides a visual representation of the removal procedure.



2x  
M2x2

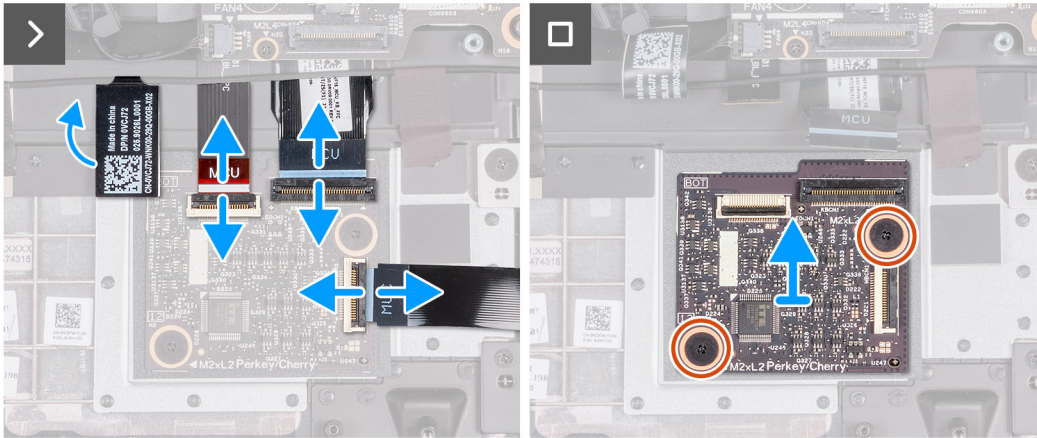
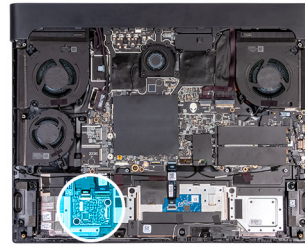

### Steps

1. Open the latch and disconnect the keyboard-backlight cable from the keyboard-controller board.
2. Open the latch and disconnect the keyboard cable from the keyboard-controller board.
3. Open the latch and disconnect the keyboard-controller board cable from the system board.
4. Remove the two screws (M2x2) that secures the keyboard-controller board to the palm-rest and keyboard assembly.
5. Lift the keyboard-controller board off the palm-rest and keyboard assembly.

## Installing the keyboard-controller board

### Prerequisites

If you are replacing a component, remove the existing component before performing the installation process.

### About this task

The following image(s) indicate the location of the keyboard-controller board and provides a visual representation of the installation procedure.



2x  
M2x2

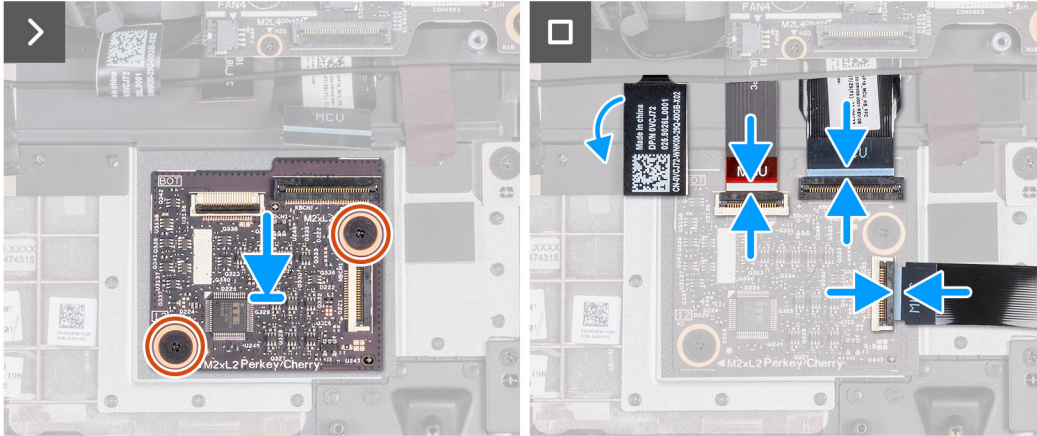
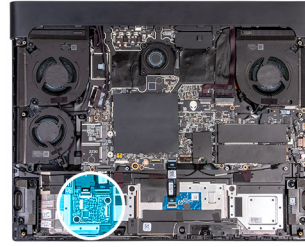

### Steps

1. Using the alignment posts, place the keyboard-controller board into the slot on the palm-rest and keyboard assembly.
2. Replace the two screws (M2x2) that secures the keyboard-controller board to the palm-rest and keyboard assembly.
3. Connect the keyboard-backlight cable to the keyboard-controller board and close the latch to secure the cable.
4. Connect the keyboard cable to the keyboard-controller board and close the latch to secure the cable.
5. Connect the keyboard-controller board cable to the system board and close the latch to secure the cable.

### Next steps

1. Install the [battery](#).
2. Install the [base cover](#).
3. Follow the procedure in [After working inside your computer](#).

## System board

### Removing the system board

#### Prerequisites

1. Follow the procedure in [Before working inside your computer](#).
2. Remove the [base cover](#).
3. Remove the [memory](#).
4. Remove the [2230 solid-state drive](#) in slot three and four.
5. Remove the [2280 solid state drive](#) or [2230 solid-state drive](#) in slot one and two, whichever applicable.
6. Remove the [wireless card](#)
7. Remove the [top heat-sink](#).
8. Remove the [small fan](#).
9. Remove the [rear-I/O cover](#).
10. Remove the [battery](#).

## About this task

**NOTE:** When removing this component, please refer to the techsheet bundled with the service kit.

The following image indicates the connectors on your system board.

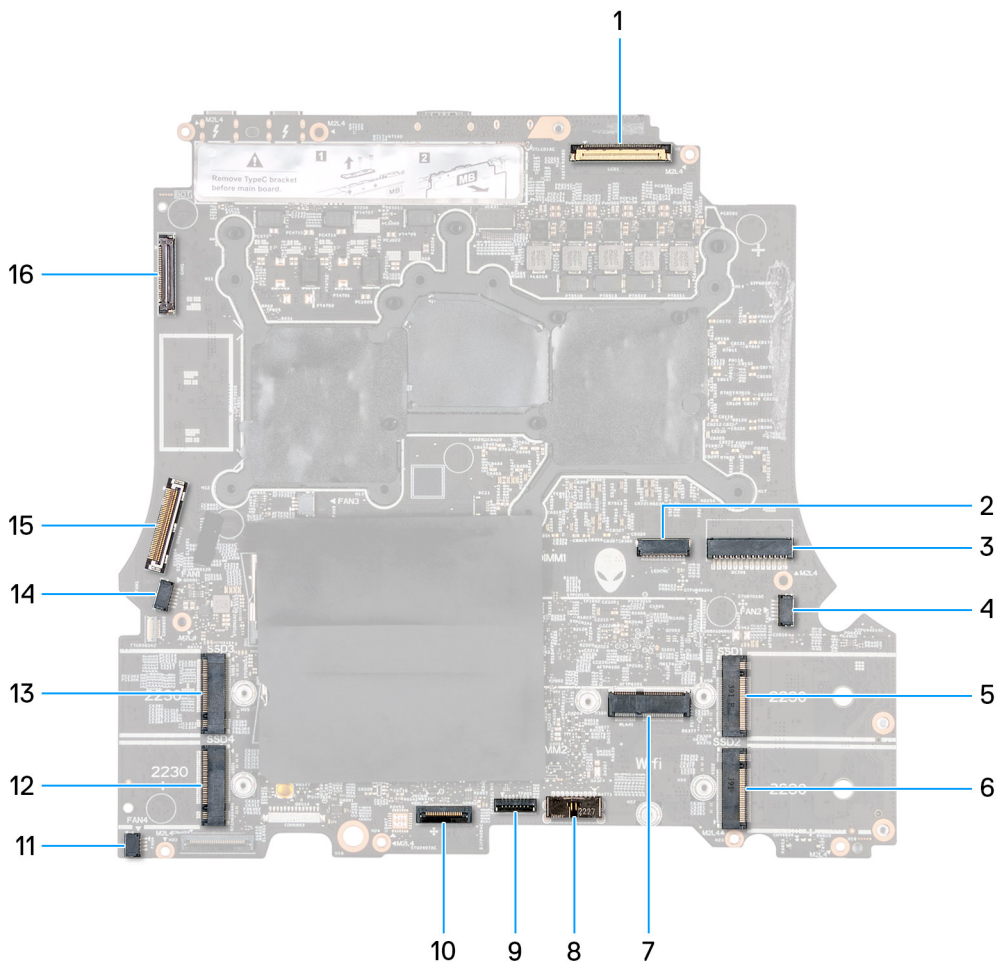

1. Display cable
2. Alien head LED-cable
3. Power-adapter cable
4. Right-fan cable
5. M.2 card slot for solid-state drive 1
6. M.2 card slot for solid-state drive 2
7. Wireless-card slot
8. Battery cable connector
9. Touchpad cable
10. Keyboard controller and keyboard backlight
11. Left-fan cable 1
12. M.2 card slot for solid-state drive 4
13. M.2 card slot for solid-state drive 3
14. Left-fan cable 2
15. Rear I/O board cable
16. Camera cable

**NOTE:** Computers shipped with NVIDIA GeForce RTX 4080/4090 graphics card have two M.2 2230 and two M.2 2280 solid-state drive slots, whereas computers shipped with NVIDIA GeForce RTX 4050/4060/4070 graphics card have only two M.2 2280 solid-state drive slots.

The following image(s) indicate the location of the system board and provides a visual representation of the removal procedure.



18x  
M2x4



1x  
M2x6



2x  
M2x2.5



2x  
M3x7.65, #2

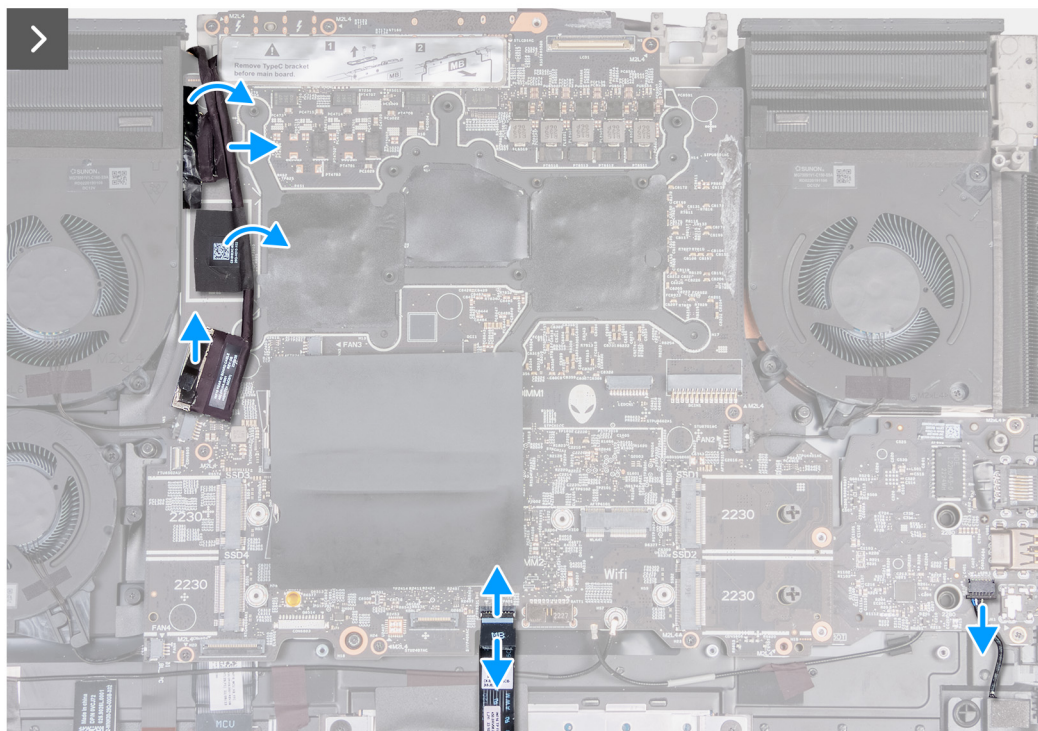
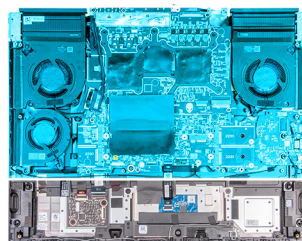

### Steps

1. Peel the tape that secures the rear I/O board cable to the system board.
2. Disconnect the rear I/O board cable from the system board.
3. Peel the tape that secures the camera cable to the system board.
4. Open the latch and disconnect the camera cable from the system board.
5. Open the latch and disconnect the touchpad cable from the system board.

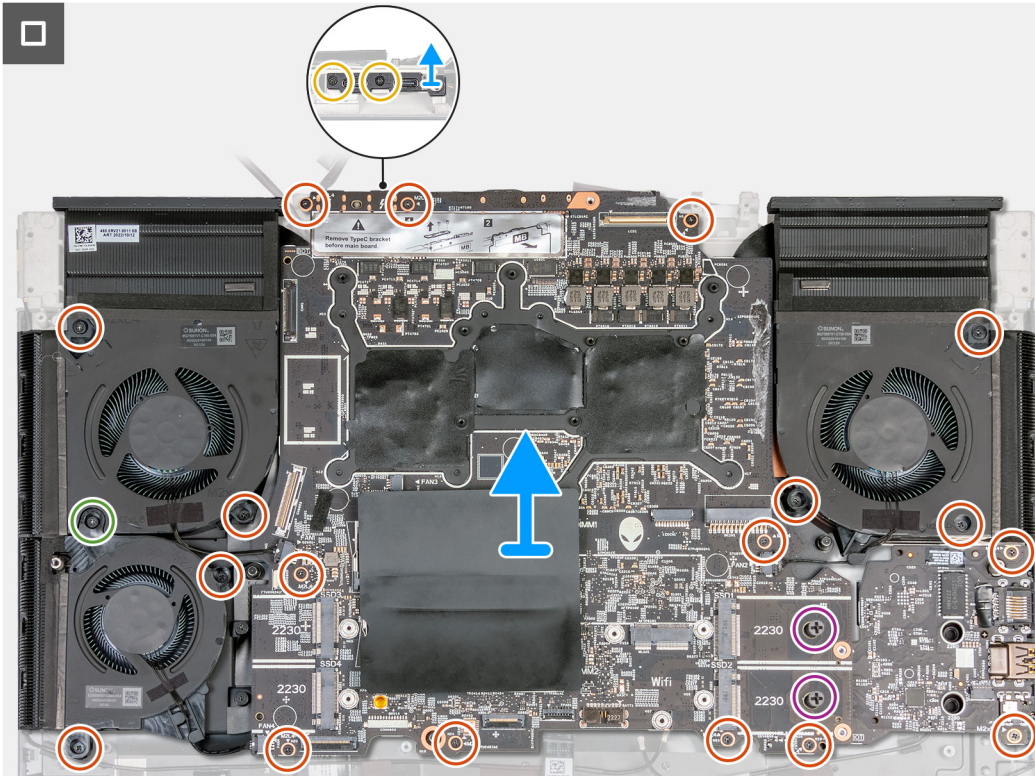

6. Remove the speaker cable from the system board.
7. Remove the two screws (M2x2.5) that secure the Type-C bracket to the system board.
8. Remove the eighteen screws (M2x4) and one screw (M2x6) that secures the system board to the palm-rest and keyboard assembly.
  - ⓘ **NOTE:** Remove the two screws (M3x7.65, #2) from the M.2 2230 SSD slots on the system board. This step is applicable only for the computers shipped with M.2 2230 solid-state drives.
9. After performing all the above steps, you are left with the system board.
10. Lift and turn the system board over.
11. Remove the [audio board](#).
12. Remove the [fan and heat-sink assembly](#).

## Installing the system board

### Prerequisites

If you are replacing a component, remove the existing component before performing the installation process.

### About this task

ⓘ **NOTE:** When installing this component, refer to the techsheet bundled with the service kit.

The following image indicates the connectors on your system board.

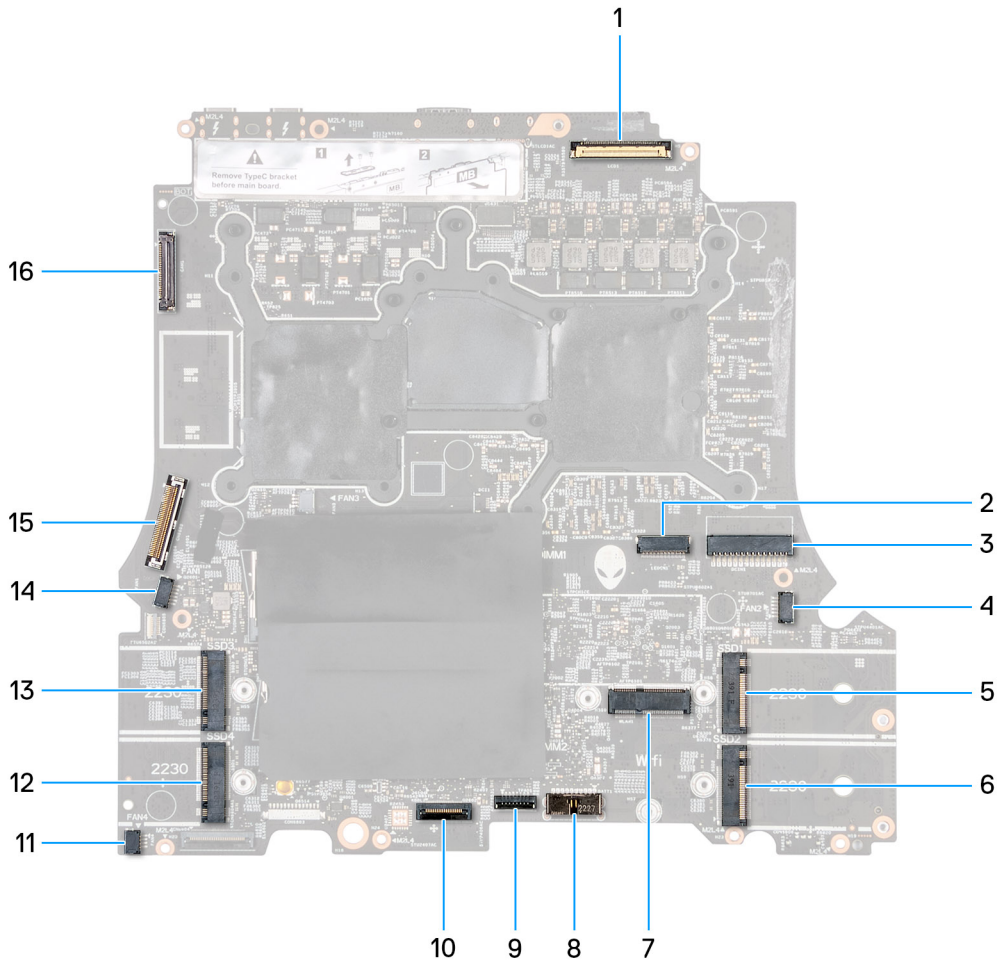

1. Display cable
2. Alien head LED-cable
3. Power-adapter cable
4. Right-fan cable
5. M.2 card slot for solid-state drive 1
6. M.2 card slot for solid-state drive 2
7. Wireless-card slot
8. Battery cable connector
9. Touchpad cable
10. Keyboard controller and keyboard backlight
11. Left-fan cable 1
12. M.2 card slot for solid-state drive 4
13. M.2 card slot for solid-state drive 3
14. Left-fan cable 2
15. Rear I/O board cable
16. Camera cable

The following image(s) indicate the location of the system board and provides a visual representation of the installation procedure.



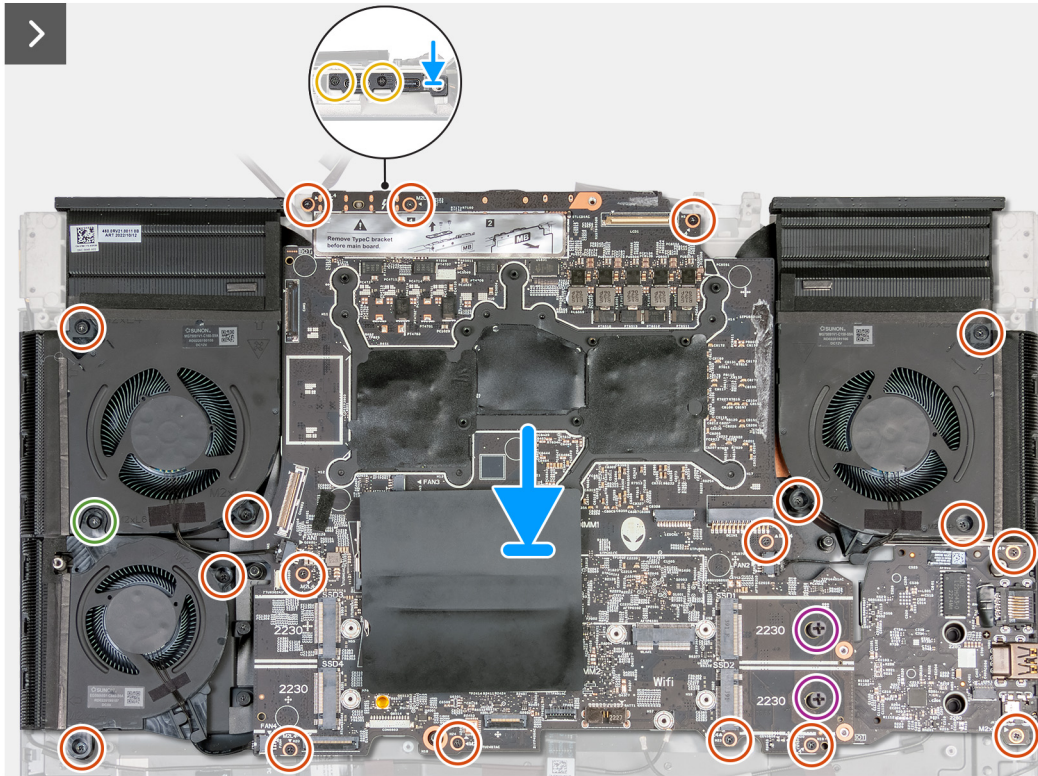
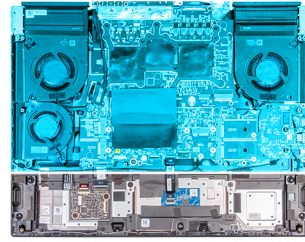

## Steps

1. Turn the system board over.
2. Install the [fan and heat-sink assembly](#).
3. Install the [audio board](#).
4. Turn the system-board assembly over.
5. Using the alignment posts, place the system-board assembly on the palm-rest and keyboard assembly.
6. Replace the eighteen screws (M2x4) and one screw (M2x6) that secure the system board to the palm-rest and keyboard assembly.
  - (i) **NOTE:** Replace the two screws (M3x7.65, #2) that secure the M.2 2230 SSD slots on the system board. This step is applicable only for the computers shipped with M.2 2230 solid-state drives.
7. Place the Type-C bracket on the system board and align the screw holes on the bracket to the screw holes on the system board.
8. Replace the two screws (M2x2.5) that secure the Type-C bracket to the system board.

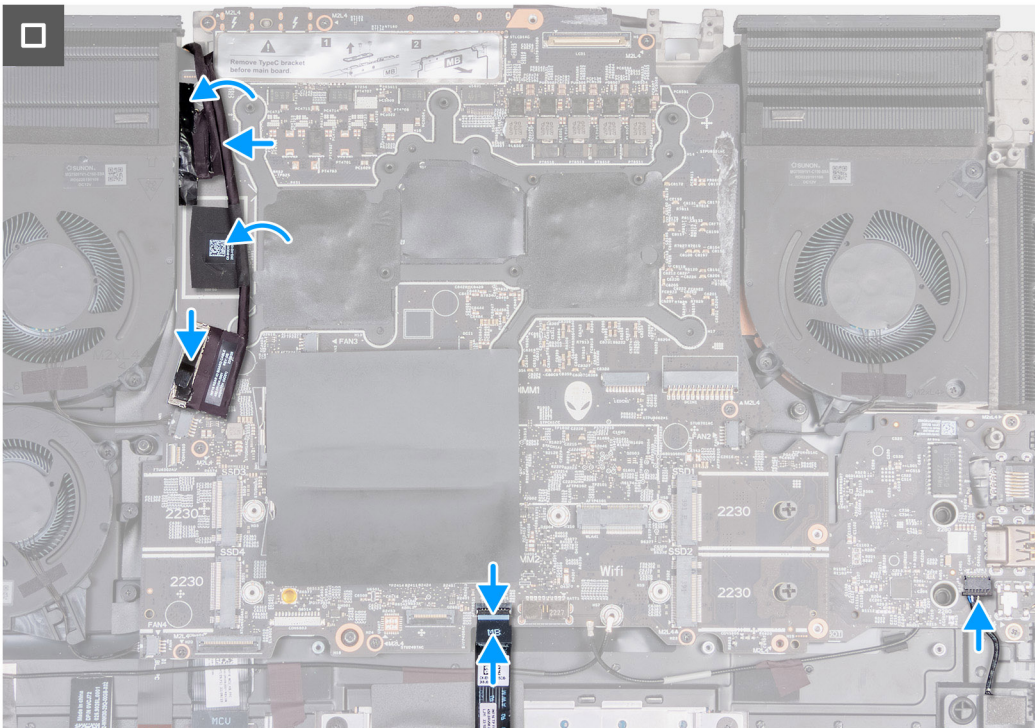

9. Connect the camera cable to the system board.
10. Adhere the tape securing the camera cable to the system board.
11. Connect the rear I/O board cable to the system board.
12. Connect the touchpad cable to the system board and close the latch to secure the cable.
13. Connect the speaker cable to the system board.

#### Next steps

1. Install the [battery](#).
2. Install the [rear-I/O cover](#).
3. Install the [small fan](#).
4. Install the [top heat-sink](#).
5. Install the [wireless card](#).
6. Install the [2230 solid-state drive](#) in slot three and four.
7. Install the [2280 solid-state drive](#) or [2230 solid-state drive](#) in slot one and two, whichever applicable.
8. Install the [memory](#).
9. Install the [base cover](#).
10. Follow the procedure in [After working inside your computer](#).

## Fan and heat-sink assembly

### Removing the fan and heat-sink assembly

#### Prerequisites

1. Follow the procedure in [Before working inside your computer](#).
2. Remove the [base cover](#).
3. Remove the [2230 solid-state drive](#) in slot three and four.
4. Remove the [2280 solid state drive](#) or [2230 solid-state drive](#) in slot one and two, whichever applicable.
5. Remove the [wireless card](#).
6. Remove the [top heat-sink](#).
7. Remove the [small fan](#).

8. Remove the [rear-I/O cover](#).
9. Remove the [battery](#).
10. Follow the procedure from step 1 to step 9 in [Removing the system board](#).
  - i **NOTE:** The system board can be removed and installed along with the memory, audio board, and fan and heat sink-assembly. This simplifies the removal and installation procedure and avoids breaking the thermal bond between the system board and heat sink.

**About this task**

- i **NOTE:** When installing this component, please refer to the techsheet bundled with the service kit.
- △ **CAUTION:** The heat sink may become hot during normal operation. Allow sufficient time for the heat sink to cool before you touch it.
- i **NOTE:** For maximum cooling of the processor, do not touch the heat transfer areas on the heat sink. The oils in your skin can reduce the heat transfer capability of the thermal grease.

The following image(s) indicate the location of the fan and heat-sink assembly and provides a visual representation of the removal procedure.

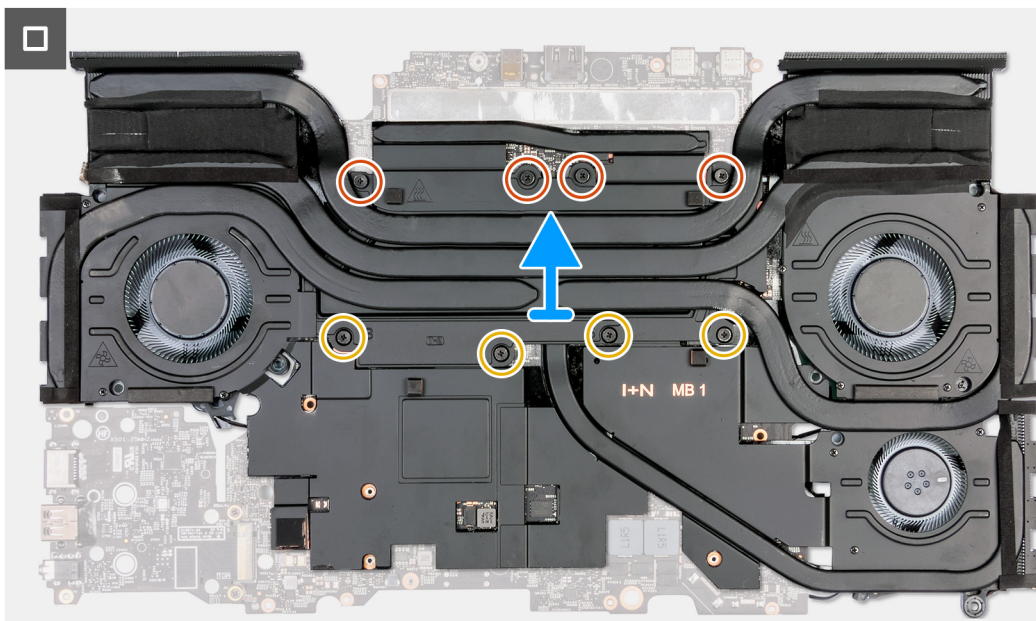
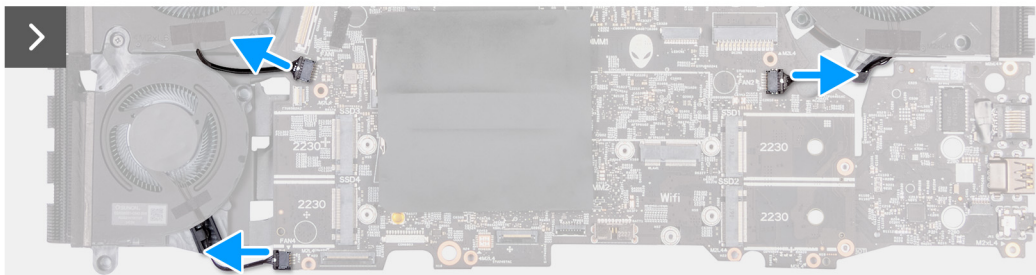
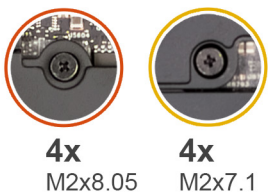

### Steps

1. Disconnect the right fan cable from the system board.
2. Disconnect the left fan cables from the system board.
3. Turn over the system-board assembly.
4. In reverse sequential order (8>7>6>5>4>3>2>1), loosen the eight captive screws that secure the fan and heat-sink assembly to the system board.
5. Lift the fan and heat-sink assembly off the system board.

 **CAUTION: Do not use an alcohol wipe to clean the thermal grease, the alcohol solution from the wipes will dissolve the Element 31 grease into conductive metal particles. If these conductive metal particles come into contact with the surface of the system board, it will cause the an electrical short when system is powered on.**

## Installing the fan and heat-sink assembly

### Prerequisites

If you are replacing a component, remove the existing component before performing the installation process.

### About this task

 **NOTE:** When installing this component, please refer to the techsheet bundled with the service kit. .

 **NOTE:** If either the system board or the fan and heat-sink assembly is replaced, use the thermal grease provided in the kit to ensure that thermal conductivity is achieved.

The following image(s) indicate the location of the fan and heat-sink assembly and provides a visual representation of the installation procedure.



4x  
M2x8.05



4x  
M2x7.1

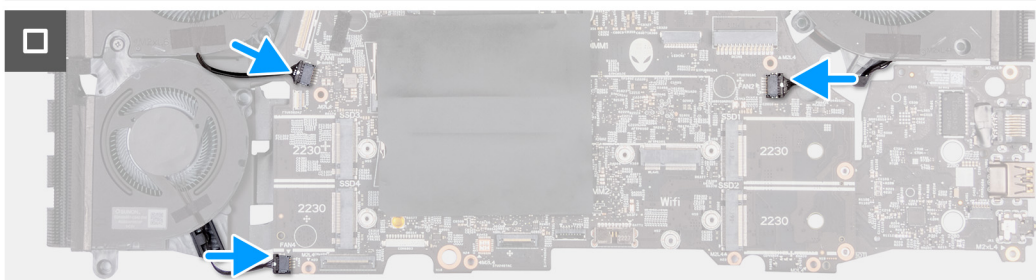
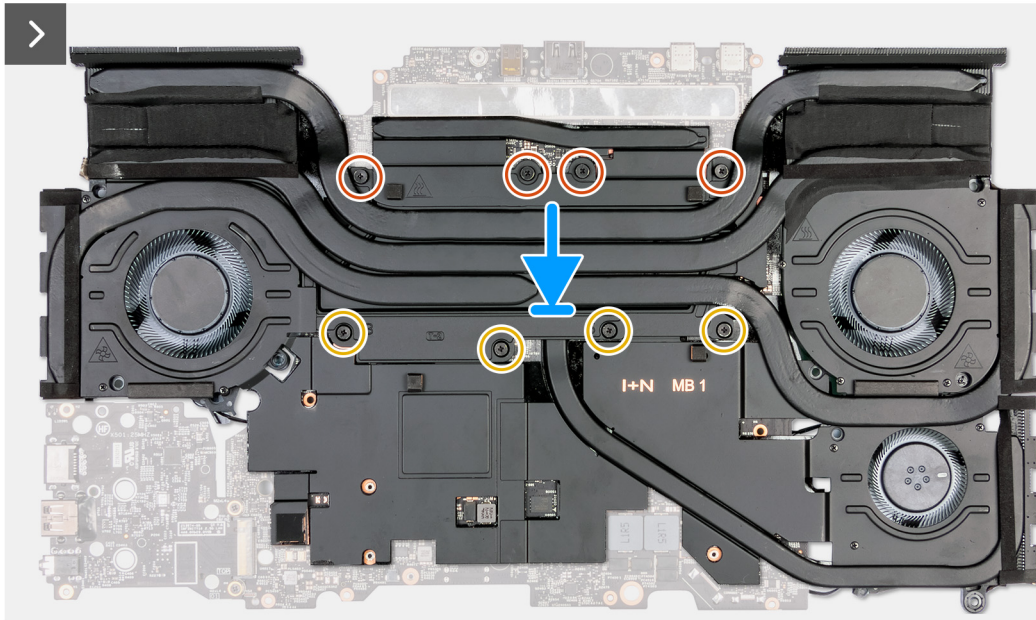

## Steps

1. **CAUTION:** Do not use an alcohol wipe to clean the Element 31 thermal grease off the surface of the processor, the alcohol solution from the wipes will dissolve the Element 31 grease into conductive metal particles. If these conductive metal particles come into contact with the surface of the system board, it will cause the an electrical short when your computer is powered on.

Place the fan and heat-sink assembly on the system board.

2. Align the screw holes on the fan and heat-sink assembly to the screw holes on the system board.
3. In sequential order (1>2>3>4>5>6>7>8), tighten the eight captive screws that secure the fan and heat-sink assembly to the system board.
4. Turn over the system-board assembly.
5. Connect the right and left fan cables to the system board.

## Next steps

1. Follow the procedure from step 5 to step 13 in [Installing the system board](#).
2. Install the [battery](#).
3. Install the [small fan](#).
4. Install the [top heat-sink](#).

5. Install the [rear-I/O cover](#).
6. Install the [wireless card](#).
7. Install the [2230 solid-state drive](#) in slot three and four.
8. Install the [2280 solid-state drive](#) or [2230 solid-state drive](#) in slot one and two, whichever applicable.
9. Install the [base cover](#).
10. Follow the procedure in [After working inside your computer](#).

# Audio board

## Removing the audio board

### Prerequisites

1. Follow the procedure in [Before working inside your computer](#).
  2. Remove the [base cover](#).
  3. Remove the [2230 solid-state drive](#) in slot three and four.
  4. Remove the [2280 solid state drive](#) or [2230 solid-state drive](#) in slot one and two, whichever applicable.
  5. Remove the [wireless card](#).
  6. Remove the [top heat-sink](#).
  7. Remove the [small fan](#).
  8. Remove the [rear-I/O cover](#).
  9. Remove the [battery](#).
  10. Follow the procedure from step 1 to step 9 in [Removing the system board](#).
- NOTE:** The system board can be removed and installed along with the memory, audio board, and fan and heat sink-assembly. This simplifies the removal and installation procedure and avoids breaking the thermal bond between the system board and heat sink.

### About this task

The following image(s) indicate the location of the ethernet and audio board and provides a visual representation of the removal procedure.



2x  
M2x4

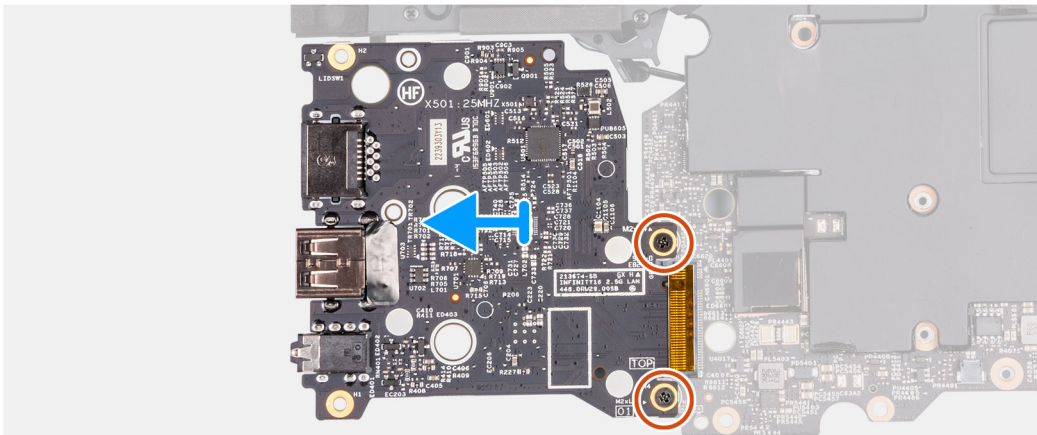
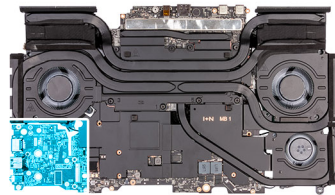

## Steps

1. Turn the system-board assembly over.
2. Remove the two screws (M2x4) that secure the audio board to the system-board assembly.
3. Slide and remove the audio board from the system-board assembly.

## Installing the audio board

### Prerequisites

If you are replacing a component, remove the existing component before performing the installation process.

### About this task

The following image(s) indicate the location of the ethernet and audio board and provides a visual representation of the installation procedure.



2x  
M2x4

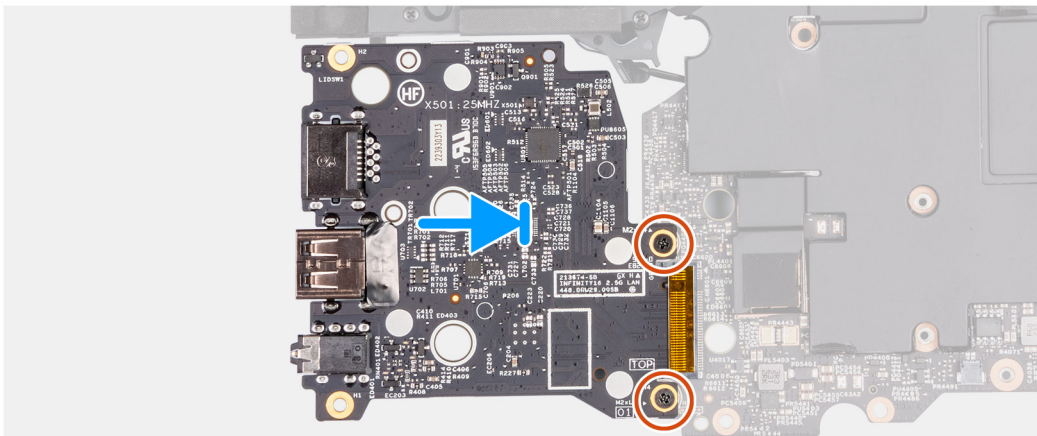
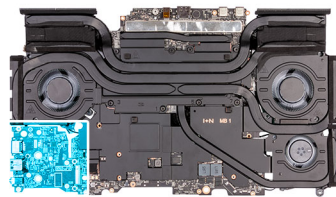

## Steps

1. Slide the audio board and connect to the system board.
2. Align the screw holes on the audio board to the screw holes on the system-board assembly.
3. Replace the two screws (M2x4) that secure the audio board to the system-board assembly.
4. Turn the system-board assembly over.

## Next steps

1. Follow the procedure from step 5 to step 13 in [Installing the system board](#).
2. Install the [battery](#).
3. Install the [small fan](#).
4. Install the [top heat-sink](#).
5. Install the [rear-I/O cover](#).
6. Install the [wireless card](#).
7. Install the [2230 solid-state drive](#) in slot three and four.
8. Install the [2280 solid-state drive](#) or [2230 solid-state drive](#) in slot one and two, whichever applicable.
9. Install the [base cover](#).
10. Follow the procedure in [After working inside your computer](#).

# Power button

## Removing the power button

### Prerequisites

1. Follow the procedure in [Before working inside your computer](#).
  2. Remove the [base cover](#).
  3. Remove the [2230 solid-state drive](#) in slot three and four.
  4. Remove the [2280 solid state drive](#) or [2230 solid-state drive](#) in slot one and two, whichever applicable.
  5. Remove the [wireless card](#).
  6. Remove the [top heat-sink](#).
  7. Remove the [rear-I/O cover](#).
  8. Remove the [battery](#).
  9. Follow the procedure from step 1 to step 9 in [Removing the system board](#).
- NOTE:** The system board can be removed and installed along with the memory, audio board, and fan and heat sink-assembly. This simplifies the removal and installation procedure and avoids breaking the thermal bond between the system board and heat sink.

### About this task

The following image(s) indicate the location of the power button and provides a visual representation of the removal procedure.

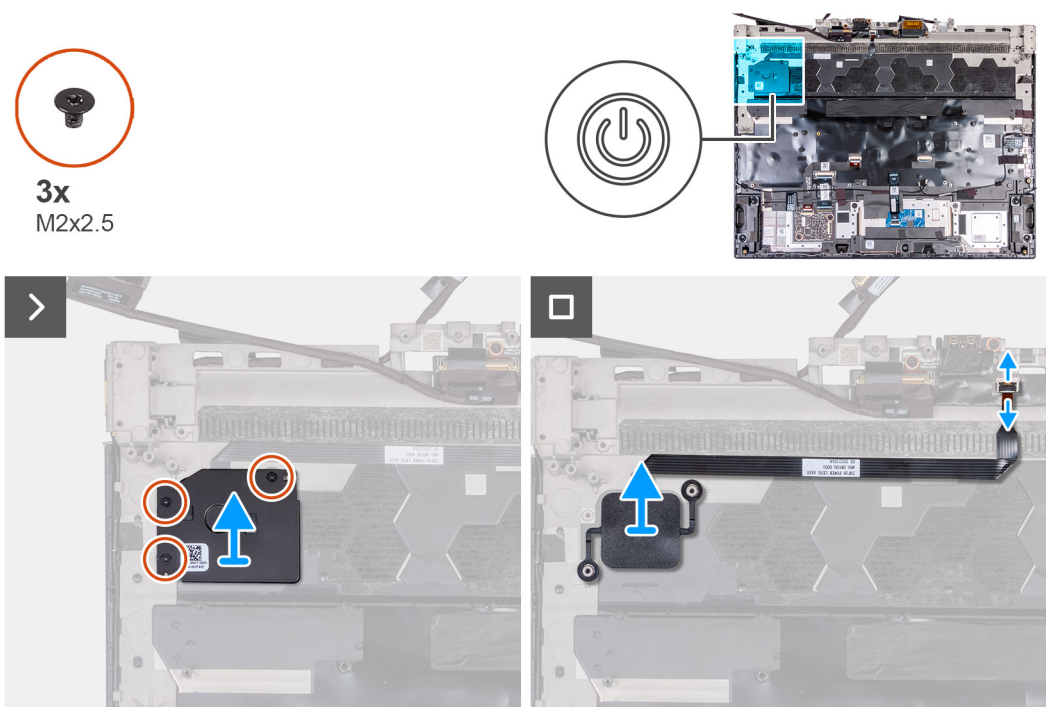

### Steps

1. Remove the three screws (M2x2.5) that secure the power-button bracket to the palm-rest and keyboard assembly.
2. Lift the power-button bracket off the power button.
3. Open the latch and disconnect the power-button cable from the palm-rest and keyboard assembly.
4. Lift the power button, along with its cable, off the palm-rest and keyboard assembly.



# Installing the power button

## Prerequisites

If you are replacing a component, remove the existing component before performing the installation process.

## About this task

The following image(s) indicate the location of the power button and provides a visual representation of the installation procedure.

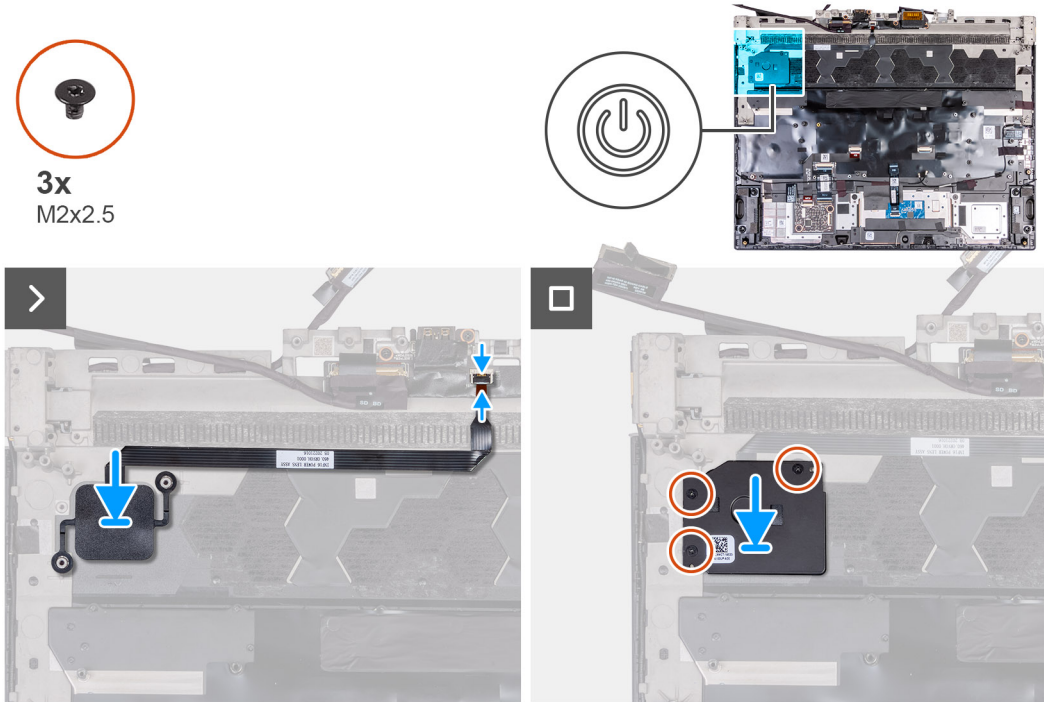

## Steps

1. Align and place the power button, along with its cable, into the slot on the palm-rest and keyboard assembly.
2. Connect the power-button cable and close the latch to secure the cable.
3. Align the screw holes on the power-button bracket to the screw holes on the palm-rest and keyboard assembly.
4. Replace the three screws (M2x2.5) that secure the power-button bracket to the palm-rest and keyboard assembly.

## Next steps

1. Follow the procedure from step 5 to step 13 in [Installing the system board](#).
2. Install the [battery](#).
3. Install the [top heat-sink](#).
4. Install the [rear-I/O cover](#).
5. Install the [wireless card](#).
6. Install the [2230 solid-state drive](#) in slot three and four.
7. Install the [2280 solid-state drive](#) or [2230 solid-state drive](#) in slot one and two, whichever applicable.
8. Install the [base cover](#).
9. Follow the procedure in [After working inside your computer](#).

# Palm-rest and keyboard assembly

## Removing the palm-rest and keyboard assembly

### Prerequisites

1. Follow the procedure in [Before working inside your computer.](#)
2. Remove the [base cover.](#)
3. Remove the [2230 solid-state drive](#) in slot three and four.
4. Remove the [2280 solid state drive](#) or [2230 solid-state drive](#) in slot one and two, whichever applicable.
5. Remove the [wireless card.](#)
6. Remove the [top heat-sink.](#)
7. Remove the [small fan.](#)
8. Remove the [rear-I/O cover.](#)
9. Remove the [battery.](#)
10. Remove the [speakers.](#)
11. Remove the [power-adaptor port.](#)
12. Remove the [touchpad.](#)
13. Remove the [display assembly.](#)
14. Remove the [keyboard-controller board.](#)
15. Follow the procedure from step 1 to step 9 in [Removing the system board.](#)

**NOTE:** The system board can be removed and installed along with the memory, audio board, and fan and heat sink-assembly. This simplifies the removal and installation procedure and avoids breaking the thermal bond between the system board and heat sink.

16. Remove the [power button.](#)

### About this task

The following image(s) indicate the location of the palm-rest and keyboard assembly and provides a visual representation of the removal procedure.

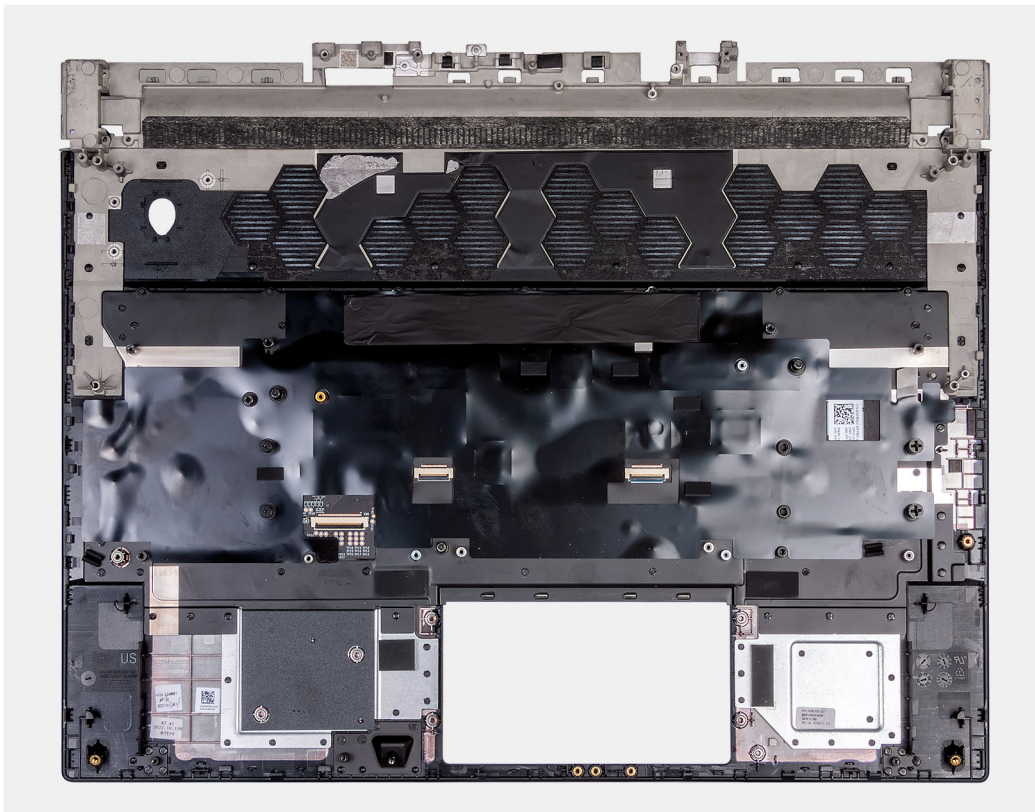

## Steps

After performing the pre-requisites you are left with the palm-rest and keyboard assembly.

- i** **NOTE:** Ensure that the solid-state drive mounts on slot one and two are removed from the old palm-rest and keyboard assembly before installing the new palm-rest and keyboard assembly. These solid-state drive mounts will be installed into the new palm-rest and keyboard assembly.

# Installing the palm-rest and keyboard assembly

## Prerequisites

If you are replacing a component, remove the existing component before performing the installation process.

## About this task

The following image(s) indicate the location of the palm-rest and keyboard assembly and provides a visual representation of the installation procedure.

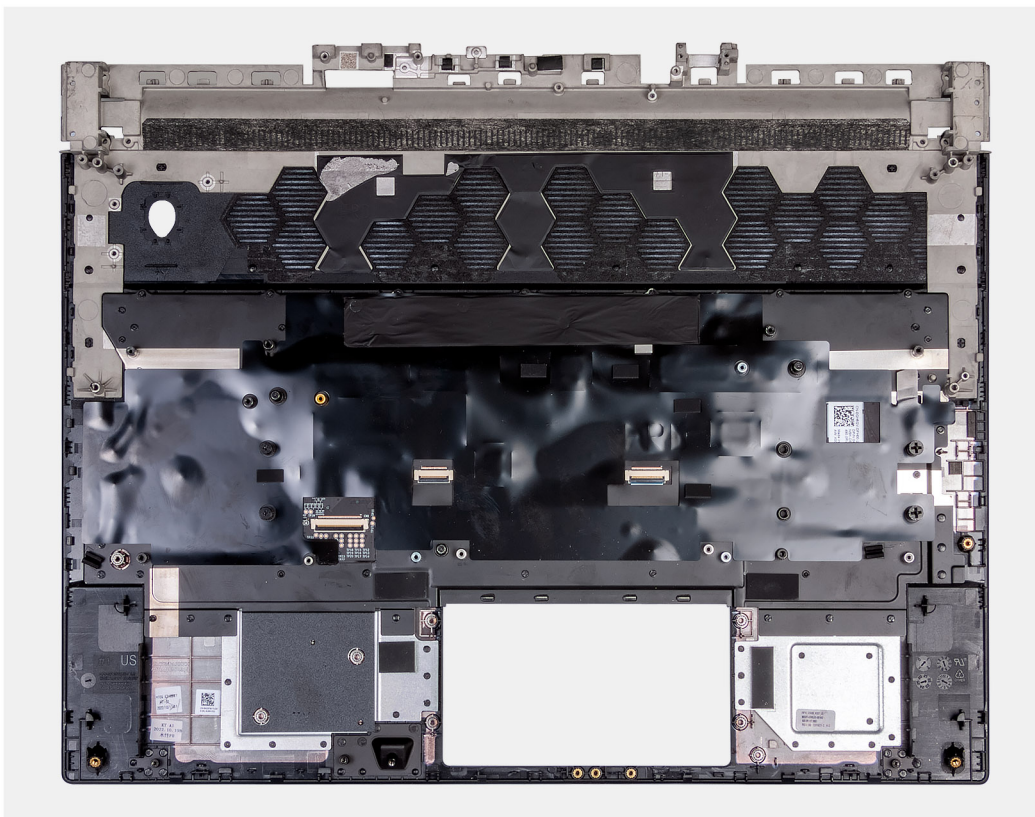

## Steps

Place the palm-rest and keyboard assembly on a flat and clean surface and perform the post-requisites to install the palm-rest and keyboard assembly.

- i** **NOTE:** Install the solid-state drive mounts on the slots from the old palm-rest and keyboard assembly into the new palm-rest and keyboard assembly.

## Next steps

1. Install the [power button](#).
2. Follow the procedure from step 5 to step 13 in [Installing the system board](#).
3. Install the [keyboard-controller board](#).
4. Install the [display assembly](#).

5. Install the [touchpad](#).
6. Install the [power-adapter port](#).
7. Install the [speakers](#).
8. Install the [small fan](#).
9. Install the [top heat-sink](#).
10. Install the [battery](#).
11. Install the [rear-I/O cover](#).
12. Install the [wireless card](#).
13. Install the [2230 solid-state drive](#) in slot three and four.
14. Install the [2280 solid-state drive](#) or [2230 solid-state drive](#) in slot one and four, whichever applicable.
15. Install the [base cover](#).
16. Follow the procedure in [After working inside your computer](#).

# Drivers and downloads

When troubleshooting, downloading or installing drivers it is recommended that you read the Dell Knowledge Based article, Drivers and Downloads FAQ [000123347](#).

# System setup

**CAUTION:** Unless you are an expert computer user, do not change the settings in the BIOS Setup program. Certain changes can make your computer work incorrectly.

**NOTE:** Before you change BIOS Setup program, it is recommended that you write down the BIOS Setup program screen information for future reference.

Use the BIOS Setup program for the following purposes:

- Get information about the hardware installed in your computer, such as the amount of RAM and the size of the hard drive.
- Change the system configuration information.
- Set or change a user-selectable option, such as the user password, type of hard drive installed, and enabling or disabling base devices.

## Entering BIOS setup program

### About this task

Turn on (or restart) your computer and press F2 immediately.

## Navigation keys

**NOTE:** For most of the System Setup options, changes that you make are recorded but do not take effect until you restart the system.

Keys	Navigation
<b>Up arrow</b>	Moves to the previous field.
<b>Down arrow</b>	Moves to the next field.
<b>Enter</b>	Selects a value in the selected field (if applicable) or follow the link in the field.
<b>Spacebar</b>	Expands or collapses a drop-down list, if applicable.
<b>Tab</b>	Moves to the next focus area.
<b>Esc</b>	Moves to the previous page until you view the main screen. Pressing Esc in the main screen displays a message that prompts you to save any unsaved changes and restarts the system.

## Boot Sequence

Boot Sequence allows you to bypass the System Setup–defined boot device order and boot directly to a specific device (for example: optical drive or hard drive). During the Power-on Self Test (POST), when the Dell logo appears, you can:

- Access System Setup by pressing F2 key
- Bring up the one-time boot menu by pressing F12 key

The one-time boot menu displays the devices that you can boot from including the diagnostic option. The boot menu options are:

- Removable Drive (if available)
- STXXXX Drive (if available)
  - NOTE:** XXX denotes the SATA drive number.
- Optical Drive (if available)
- SATA Hard Drive (if available)
- Diagnostics

The boot sequence screen also displays the option to access the System Setup screen.

# One time boot menu

To enter **one time boot menu**, turn on your computer, and then press F12 immediately.

**i** **NOTE:** It is recommended to shutdown the computer if it is on.

The one-time boot menu displays the devices that you can boot from including the diagnostic option. The boot menu options are:

- Removable Drive (if available)
- STXXX Drive (if available)
  - i** **NOTE:** XXX denotes the SATA drive number.
- Optical Drive (if available)
- SATA Hard Drive (if available)
- Diagnostics

The boot sequence screen also displays the option to access the System Setup screen.

# BIOS overview

The BIOS manages data flow between the computer's operating system and attached devices such as hard disk, video adapter, keyboard, mouse, and printer.

# System setup options

**i** **NOTE:** Depending on this computer and its installed devices, the items that are listed in this section may or may not be displayed.

**Table 3. System setup options—System information menu**

Overview	
BIOS Version	Displays the BIOS version number.
Service Tag	Displays the Service Tag of the computer.
Asset Tag	Displays the Asset Tag of the computer.
Manufacture Date	Displays the manufacture date of the computer.
Ownership Date	Displays the ownership date of the computer.
Express Service Code	Displays the express service code of the computer.
Ownership Tag	Displays the ownership tag of the computer.
Signed Firmware Update	Displays whether the signed firmware update is enabled. Default: Enabled
<b>BATTERY</b>	
Primary	
Battery Level	Displays the battery level.
Battery State	Displays the battery state.
Health	Displays the battery health information.
AC Adapter	Displays whether an AC adapter is connected. If connected, the AC adapter type.
<b>PROCESSOR</b>	
Processor Type	Displays the processor type.
Maximum Clock Speed	Displays the maximum processor clock speed.
Minimum Clock Speed	Displays the minimum processor clock speed.

**Table 3. System setup options—System information menu (continued)**

<b>Overview</b>	
Current Clock Speed	Displays the current processor clock speed.
Core Count	Displays the number of cores on the processor.
Processor ID	Displays the processor identification code.
Processor L2 Cache	Displays the processor L2 Cache size.
Processor L3 Cache	Displays the processor L3 Cache size.
Microcode Version	Displays the microcode version.
Intel Hyper-Threading Capable	Displays whether the processor is Hyper-Threading (HT) capable.
64-Bit Technology	Displays whether 64-bit technology is used.
<b>MEMORY</b>	
Memory Installed	Displays the total computer memory installed.
Memory Available	Displays the total computer memory available.
Memory Speed	Displays the memory speed.
Memory Channel Mode	Displays single or dual channel mode.
Memory Technology	Displays the technology that is used for the memory.
DIMM A Size	Displays the memory configuration of DIMM A.
DIMM B Size	Displays the memory configuration of DIMM B.
<b>DEVICES</b>	
Panel Type	Displays the Panel Type of the computer.
Video Controller	Displays the integrate graphics information of the computer.
Video Memory	Displays the video memory information of the computer.
Wi-Fi Device	Displays the Wi-Fi device installed in the computer.
Native Resolution	Displays the native resolution of the computer.
Video BIOS Version	Displays the video BIOS version of the computer.
Audio Controller	Displays the audio controller information of the computer.
Bluetooth Device	Displays whether a Bluetooth device is installed in the computer.
LOM MAC Address	Displays the MAC address of the LAN on Motherboard (LOM).
dGPU Video Controller	Displays the discrete graphics controller.

**Table 4. System setup options—Boot Configuration menu**

<b>Boot Configuration</b>	
<b>Boot Sequence</b>	
Boot Mode: UEFI only	Displays the boot mode of this computer.
Boot Sequence	Enables or disables Windows Boot Manager and UEFI Hard Drive. By default, Windows Boot Manager is selected By default, UEFI Hard Drive is selected
<b>Secure Boot</b>	
Enable Secure Boot	Enables secure boot using only validated boot software. Default: OFF
Secure Boot Mode	Displays the secure boot mode . Default: Deployed Mode



**Table 4. System setup options—Boot Configuration menu (continued)**

<b>Boot Configuration</b>	
<b>Expert Key Management</b>	
Enable Custom Mode	Allows the PK, KEK, db, and dbx security key databases to be modified. Default: OFF
Custom Mode Key Management	Allows for selection of key database. Default: PK

**Table 5. System setup options—Integrated Devices menu**

<b>Integrated Devices</b>	
<b>Date/Time</b>	
Date	Sets the computer date in MM/DD/YYYY format. Changes to the date take effect immediately.
Time	Sets the computer time in HH/MM/SS 24-hour format. You can switch between 12-hour and 24-hour clock. Changes to the time take effect immediately.
<b>Camera</b>	
Enable Camera	Enables or disables the camera. By default, Enable Camera is selected.
<b>Audio</b>	
Enable Audio	Enables or disables all integrated audio controller. Default: ON
Enable Microphone	Enables or disables microphone. By default, Enable Microphone is selected.
Enable Internal Speaker	Enables or disables internal speaker. By default, Enable Internal Speaker is selected.
<b>USB/Thunderbolt Configuration</b>	
Enable External USB Ports	Enables or disables all external USB ports in an OS environment. By default, Enable External USB Ports is selected.
Enable USB Boot Support	Enables or disables booting from USB mass storage devices such as external hard drive, optical drive, and USB drive. By default, Enable USB Boot Support is selected.
<b>Enable Thunderbolt Boot Support</b>	Enables or disables Thunderbolt™ adapter peripheral devices and USB devices connected to the Thunderbolt™ adapter to be used during BIO's pre-boot. Default: OFF
<b>Enable Thunderbolt (and PCIe behind TBT) pre-boot modules</b>	Enables or disables PCIe devices that are connected through a Thunderbolt™ adapter to run the PCIe device's UEFI Option ROM(s) during pre-boot. Default: OFF

**Table 6. System setup options—Storage menu**

<b>Storage</b>	
<b>SATA/NVMe Operation</b>	
SATA/NVMe Operation	Sets the operating mode of the integrated storage device controller. Default: RAID On

**Table 6. System setup options—Storage menu (continued)**

Storage	
<b>Storage Interface</b>	
Port Enablement	Enables or disables the onboard drives.
M.2 PCIe SSD-0	Enables or disables the M.2 PCIe SSD-0. Default: ON
M.2 PCIe SSD-1	Enables or disables the M.2 PCIe SSD-1. Default: ON
<b>SMART Reporting</b>	
Enable SMART Reporting	Enables or disables Self-Monitoring, Analysis, and Reporting Technology (SMART). Default: OFF
<b>Drive Information</b>	Displays the information of various onboard drives.

**Table 7. System setup options—Display menu**

Display	
<b>Display Brightness</b>	
Brightness on battery power	Sets the screen brightness when the computer is running on battery power. Default: 50
Brightness on AC power	Sets the screen brightness when the computer is running on AC power. Default: 100
<b>Full Screen Logo</b>	
Full Screen Logo	When turned on, the full screen logo is displayed if the image matches the screen resolution. Default: OFF
<b>Hybrid Graphics / Advanced Optimus</b>	
Enable Hybrid Graphics / Advanced Optimus (when available)	When turned on, the system allows both integrated and discrete graphics controllers to work together for optimized capability and battery life. When turned off, the discrete graphics controller will drive all displays to prioritize graphics capability over battery life. Default: On
	 <b>NOTE:</b> Linux is not supported with Hybrid Graphics enabled.

**Table 8. System setup options—Connection menu**

Connection	
<b>Network Controller Configuration</b>	
Integrated NIC	Controls the onboard LAN controller. Default: Enabled with PXE
<b>Wireless Device Enable</b>	
WLAN	Enable or disable internal WLAN devices. By default, WLAN is selected.
Bluetooth	Enable or disable internal Bluetooth devices. By default, Bluetooth is selected.

**Table 8. System setup options—Connection menu (continued)**

Connection	
<b>Enable UEFI Network Stack</b>	
Enable UEFI Network Stack	Enables or disables UEFI networking protocols, if they are installed and available. Default: ON
<b>HTTP(s) Boot Feature</b>	
HTTP(s) Boot	Enable or disable HTTP(s) Boot feature. Default: ON
HTTP(s) Boot Modes	Configures HTTP(s) Boot Modes. Default: Auto Mode. HTTP(s) Boot automatically extracts Boot URL from the Dynamic Host Configuration (DHCP).
	<b>NOTE:</b> Provisioning of the Certificate is required to connect to HTTPs Boot server.

**Table 9. System setup options—Power menu**

Power	
<b>Battery 1 Charge Mode</b>	
Battery 1 Charge Mode	Enables the computer to run on battery during peak power usage hours. Use the below options to prevent AC power usage between certain times of each day. Default: Adaptive. Battery settings are adaptively optimized based on your typical battery usage pattern.
<b>Advanced Configuration</b>	
Enable Advanced Battery Charge Configuration	Enables Advanced Battery Charge Configuration from the beginning of the day to a specified work period. Advanced Battery Charged maximizes battery health while still supporting heavy use during the work day. Default: OFF
<b>USB PowerShare</b>	
Enable USB PowerShare	Enables external devices such as phones and portable music players to be powered or charged using the stored system battery.. Default: OFF
<b>Thermal Management</b>	
Thermal Management	Enables the cooling fan and processor heat management to adjust system performance, noise, and temperature. Default: Optimized. Standard settings for cooling fan and processor heat management. This setting is a balance of performance, noise, and temperature.
<b>Block Sleep</b>	
Block Sleep	Blocks the computer from entering Sleep (S3) mode in the operating system. Default: OFF
	<b>NOTE:</b> If enabled, the computer will not go to sleep, Intel® Rapid Start will be disabled automatically, and the operating system power option will be blank if it was set to Sleep.
<b>Lid Switch</b>	
Enable Lid Switch	Enable or disable the lid switch. Default: ON
Power On Lid Open	Enables the computer to turn on from the off state whenever the lid is opened.

**Table 9. System setup options—Power menu (continued)**

Power	
	Default: ON
<b>Intel Speed Shift Technology</b>	
Intel Speed Shift Technology	Enables or disables the Intel Speed Shift Technology support. Setting this option to enable allows the operating system to select the appropriate processor performance automatically.
	Default: ON

**Table 10. System setup options—Security menu**

Security	
<b>Intel® Platform Trust Technology</b>	
Intel® Platform Trust Technology On	Enable or disable the Intel® Platform Trust Technology (PPT) feature in the OS. Default: ON
PPI Bypass for Clear Commands	Enables or disables the Trusted Platform Model (TPM) Physical Presence Interface (PPI). When enabled, the OS will skip BIOS Physical Presence Interface (PPI) user prompts when issuing the Clear command. Default: OFF
Clear	Enables or disables the computer to clear the PTT owner information, and returns the PTT to the default state. Default: OFF
<b>SMM Security Mitigation</b>	
SMM Security Mitigation	Enables or disables additional UEFI SMM Security Mitigation protections. Default: OFF
	<b>i</b> <b>NOTE:</b> This feature may cause compatibility issues or loss of functionality with some legacy tools and applications.
<b>Data Wipe on Next Boot</b>	
Start Data Wipe	When enabled, the BIOS will schedule a data wipe cycle for all storage devices that are connected to the system board on the next reboot. Default: OFF
<b>Absolute</b>	
Absolute	Enables, disables or permanently disable the BIOS module interface of the optional Absolute Persistence Module service from Absolute Software. Default: Enabled
<b>UEFI Boot Path Security</b>	
UEFI Boot Path Security	Determines if the system will prompt the user to enter the admin password (if set) when booting to a UEFI boot path device from the F12 boot menu. Default: Always Except Internal HDD.

**Table 11. System setup options—Passwords menu**

Passwords	
<b>Admin Password</b>	Enables you to set, change, or delete the administrator (admin) password. The admin password enables several security features
<b>System Password</b>	Enables you to set, change, or delete the system password.
<b>M.2 PCIe SSD-0</b>	Enables you to set, change, or delete the M.2 PCIe SSD-0 password.

**Table 11. System setup options—Passwords menu (continued)**

<b>Passwords</b>	
<b>Password Configuration</b>	
Upper Case Letter	Enforces password restriction that the password must contain at least one upper case letter. Default: OFF
Lower Case Letter	Enforces password restriction that the password must contain at least one lower case letter. Default: OFF
Digit	Enforces password restriction that the password must contain at least one digit. Default: OFF
Special Character	Enforces password restriction that the password must contain at least one special character. Default: OFF
Minimum Characters	Controls the minimum number of characters allowed for password. Default: 04
<b>Password Bypass</b>	
Password Bypass	Bypass the System (Boot) Password and the internal hard drive password prompts during a system restart. Default: Disabled
<b>Password Changes</b>	
Enable Non-Admin Password Changes	Bypass the System (Boot) Password and the internal hard drive password prompts during a system restart. Default: Disabled Enables or disables the user to change the system and hard drive password without the need for admin password. Default: ON
<b>Admin Setup Lockout</b>	
Enable Admin Setup Lockout	Enables or disables the user from entering BIOS Setup when an Admin Password is set. Default: OFF
<b>Master Password Lockout</b>	
Enable Master Password Lockout	Enables or disables master password support. Default: OFF  <b>NOTE:</b> Hard drive passwords must be cleared before the setting can be changed.
<b>Allow Non-Admin PSID Revert</b>	
Enable Allow Non-Admin PSID Revert	Controls access to the Physical Security ID (PSID) revert of NVMe hard-drives from the Dell Security Manager prompt. Default: OFF

**Table 12. System setup options—Update, Recovery menu**

<b>Update, Recovery</b>	
<b>UEFI Capsule Firmware Updates</b>	
Enable UEFI Capsule Firmware Updates	Enables or disables BIOS updates through UEFI capsule update packages.



**Table 12. System setup options—Update,Recovery menu (continued)**

Update,Recovery	
	Default: ON
<b>BIOS Recovery from Hard Drive</b>	
BIOS Recovery from Hard Drive	Enables the computer to recover from a bad BIOS image, as long as the Boot Block portion is intact and functioning.
	Default: ON
	<p><b>NOTE:</b> BIOS recovery is designed to fix the main BIOS block and cannot work if the Boot Block is damaged. In addition, this feature cannot work in the event of EC corruption, ME corruption, or a hardware issue. The recovery image must exist on an unencrypted partition on the drive.</p>
<b>BIOS Downgrade</b>	
Allow BIOS Downgrade	Controls flashing of the system firmware to previous revisions.
	Default: ON
<b>SupportAssist OS Recovery</b>	
	Enables or disables the boot flow for SupportAssist OS Recovery tool, in the event of certain system error.
	Default: ON
<b>BIOSConnect</b>	
BIOSConnect	Enables or disables cloud Service OS recovery if the main OS fails to boot within the number of failures equal or greater than the value specified by Dell Auto OS Recovery Threshold, and local Service does not boot, or is not installed.
	Default: ON
<b>Dell Auto OS Recovery Threshold</b>	
Dell Auto OS Recovery Threshold	Controls the automatic boot flow for SupportAssist System Resolution Console and for Dell operating system Recovery tool.
	Default: 2.

**Table 13. System setup options—System Management menu**

System Management	
<b>Service Tag</b>	Displays the Service Tag of the computer.
<b>Asset Tag</b>	Creates a system Asset Tag that can be used by an IT administrator to uniquely identify a particular system. Once set in BIOS, the Asset Tag cannot be changed.
<b>AC Behavior</b>	
Wake on AC	Enables or disables basic checks when AC power is applied to the device. The checks include determining how the AC Recovery option is set. The system will boot up if Wake on AC is enabled, the system will power off, if Wake on AC is disabled.
	Default: OFF
<b>Auto On Time</b>	
Auto On Time	Controls automatic powering up of system for defined days and times.
	Default: Every Day
<b>First Power On Date</b>	
Set Ownership Date	Enables the user to configure the Ownership date.
	Default: OFF

**Table 14. System setup options—Keyboard menu**

Keyboard	
<b>Fn Lock Options</b>	
Fn Lock Options	Enables or disables the Fn lock mode. Default: ON
Lock Mode	Controls operation of function keys F1-F12. Default: Lock Mode Standard
<b>Keyboard Backlight Timeout on AC</b>	
Keyboard Backlight Timeout on AC	Enables the user to define the timeout value for the keyboard backlight when an AC adapter is plugged into the system. Default: Never
<b>Keyboard Backlight Timeout on Battery</b>	
Keyboard Backlight Timeout on Battery	Enables the user to define the timeout value for the keyboard backlight when the system is operating only on battery power. Default: Never
<b>RGB Per Key Keyboard Language</b>	
	Enables the user to select the language that matches the keyboard installed on the system. Default: English US
	 <b>WARNING: Selecting the incorrect language may cause the keyboard and lighting malfunction.</b>
<b>RGB Per Key Keyboard Color</b>	
	Enables the user to select the keyboard color that matches the keyboard installed on the system. Default: Dark
	 <b>WARNING: Selecting the incorrect language may cause the keyboard and lighting malfunction.</b>

**Table 15. System setup options—Pre-boot Behavior menu**

Pre-boot Behavior	
<b>Adapter warnings</b>	
Enable Adapter warnings	Enables or disables the computer to display adapter warning messages when adapters with too little power capacity are detected. Default: ON
<b>Warnings and Errors</b>	
Warnings and Errors	Selects an action on encountering a warning or error during boot. Default: Prompt on Warnings and Errors. Stop, prompt, and wait for user input when warnings or errors are detected.
	 <b>NOTE:</b> Errors deemed critical to the operation of the computer hardware will always halt the computer.
<b>USB-C Warnings</b>	
	Specify the maximum number of characters allowed for Admin password. Default: 32
Enable Dock Warning Messages	Enable or disable dock warning messages. Default: ON
<b>Fastboot</b>	
Fastboot	Configures the speed of the UEFI boot process.

**Table 15. System setup options—Pre-boot Behavior menu (continued)**

Pre-boot Behavior	
<b>Extend BIOS POST Time</b>	Default: Thorough. Performs complete hardware and configuration initialization during boot.
Extend BIOS POST Time	Configures the BIOS POST (Power-On Self-Test) load time. Default: 0 seconds

**Table 16. System setup options—Virtualization Support menu**

Virtualization	
<b>Intel® Virtualization Technology</b>	
Enable Intel® Virtualization Technology (VT)	Enables the computer to run a virtual machine monitor (VMM). Default: ON
<b>VT for Direct I/O</b>	
Enable Intel® VT for Direct I/O	Enables the computer to perform Virtualization Technology for Direct I/O (VT-d). VT-d is an Intel method that provides virtualization for memory map I/O. Default: ON

**Table 17. System setup options—Performance menu**

Performance	
<b>Multi-Core Support</b>	
Active Cores	Changes the number of CPU cores available to the operating system. The default value is set to the maximum number of cores. Default: All
<b>Intel SpeedStep</b>	
Enable Intel® SpeedStep Technology	Enables or disables the Intel® SpeedStep Technology to dynamically adjust processor voltage and core frequency, decreasing average power consumption and heat production. Default: ON
<b>C-States Control</b>	
Enable C-State Control	Enables or disables the CPU's ability to enter and exit low-power states. Default: ON
Enable Adaptive C-States for Discrete Graphics	Allows to dynamically detect high usage of discrete graphics and adjust system parameters for higher performance during that time period. Default: ON
<b>Intel Turbo Boost Technology</b>	
Enable Intel® Turbo Boost Technology	Enabled or disabled the Intel® TurboBoost mode of the processor. If enabled, the Intel® TurboBoost driver increases the performance of the CPU or graphics processor. Default: ON
<b>Intel Hyper-Threading Technology</b>	
Enable Intel® Hyper-Threading Technology	Enabled or disabled the Intel® Hyper-Threading mode of the processor. If enabled, the Intel® Hyper-Threading increases the efficiency of the processor resources when multiple threads run on each core. Default: ON



**Table 17. System setup options—Performance menu (continued)**

Performance	
<b>Extreme Memory Profile</b>	
Extreme Memory Profile	Enables the user to select one of two alternate memory time profiles, in order to take advantage of the fastest possible memory performance. Default: DIMM profile
<b>TCC Activation Offset</b>	
TCC Activation Offset	Enables user to adjust CPU's Tcc offset to moderate the performance of the CPU. Default: 00

**Table 18. System setup options—System Logs menu**

System Logs	
<b>BIOS Event Log</b>	
Clear BIOS Event Log	Select keep or clear BIOS events. Default: Keep Log
<b>Thermal Event Log</b>	
Clear Thermal Event Log	Select keep or clear Thermal events. Default: Keep Log
<b>Power Event Log</b>	
Clear Power Event Log	Select keep or clear Power events. Default: Keep Log

## System and setup password

**Table 19. System and setup password**

Password type	Description
System password	Password that you must enter to log on to your system.
Setup password	Password that you must enter to access and make changes to the BIOS settings of your computer.

You can create a system password and a setup password to secure your computer.

 **CAUTION:** The password features provide a basic level of security for the data on your computer.

 **CAUTION:** Anyone can access the data stored on your computer if it is not locked and left unattended.

 **NOTE:** System and setup password feature is disabled.

## Assigning a system setup password

### Prerequisites

You can assign a new **System or Admin Password** only when the status is in **Not Set**.

### About this task

To enter the system setup, press F12 immediately after a power-on or reboot.

## Steps

1. In the **System BIOS** or **System Setup** screen, select **Security** and press Enter.  
The **Security** screen is displayed.
2. Select **System/Admin Password** and create a password in the **Enter the new password** field.  
Use the following guidelines to assign the system password:
  - A password can have up to 32 characters.
  - At least one special character: ! " # \$ % & ' ( ) \* + , - . / : ; < = > ? @ [ \ ] ^ \_ ` { | }
  - Numbers 0 through 9.
  - Upper case letters from A to Z.
  - Lower case letters from a to z.
3. Type the system password that you entered earlier in the **Confirm new password** field and click **OK**.
4. Press Esc and save the changes as prompted by the pop-up message.
5. Press Y to save the changes.  
The computer restarts.

## Deleting or changing an existing system setup password

### Prerequisites

Ensure that the **Password Status** is Unlocked (in the System Setup) before attempting to delete or change the existing System and/or Setup password. You cannot delete or change an existing System or Setup password, if the **Password Status** is Locked.

### About this task

To enter the System Setup, press F12 immediately after a power-on or reboot.

## Steps

1. In the **System BIOS** or **System Setup** screen, select **System Security** and press Enter.  
The **System Security** screen is displayed.
2. In the **System Security** screen, verify that **Password Status** is **Unlocked**.
3. Select **System Password**, update, or delete the existing system password, and press Enter or Tab.
4. Select **Setup Password**, update, or delete the existing setup password, and press Enter or Tab.  
 **NOTE:** If you change the System and/or Setup password, reenter the new password when prompted. If you delete the System and/or Setup password, confirm the deletion when prompted.
5. Press Esc and a message prompts you to save the changes.
6. Press Y to save the changes and exit from System Setup.  
The computer restarts.

## Clearing CMOS settings

### About this task

 **CAUTION:** Clearing CMOS settings will reset the BIOS settings on your computer.

## Steps

1. Remove the [base cover](#).
2. Disconnect the battery cable from the system board.
3. Press the power button for 20 seconds.
4. Wait for one minute.
5. Connect the battery cable to the system board.
6. Install the [base cover](#).

# Clearing BIOS (System Setup) and System passwords

## About this task

To clear the system or BIOS passwords, contact Dell technical support as described at [www.dell.com/contactdell](http://www.dell.com/contactdell).

 **NOTE:** For information on how to reset Windows or application passwords, refer to the documentation accompanying Windows or your application.

# Updating the BIOS

## Updating the BIOS in Windows

### Steps

1. Go to [www.dell.com/support](http://www.dell.com/support).
2. Click **Product support**. In the **Search support** box, enter the Service Tag of your computer, and then click **Search**.  
 **NOTE:** If you do not have the Service Tag, use the SupportAssist feature to automatically identify your computer. You can also use the product ID or manually browse for your computer model.
3. Click **Drivers & Downloads**. Expand **Find drivers**.
4. Select the operating system installed on your computer.
5. In the **Category** drop-down list, select **BIOS**.
6. Select the latest version of BIOS, and click **Download** to download the BIOS file for your computer.
7. After the download is complete, browse the folder where you saved the BIOS update file.
8. Double-click the BIOS update file icon and follow the on-screen instructions.  
For more information about how to update the system BIOS, search in the Knowledge Base Resource at [www.dell.com/support](http://www.dell.com/support).

## Updating the BIOS using the USB drive in Windows

### Steps

1. Follow the procedure from step 1 to step 6 in [Updating the BIOS in Windows](#) to download the latest BIOS setup program file.
2. Create a bootable USB drive. For more information, search the Knowledge Base Resource at [www.dell.com/support](http://www.dell.com/support).
3. Copy the BIOS setup program file to the bootable USB drive.
4. Connect the bootable USB drive to the computer that needs the BIOS update.
5. Restart the computer and press **F12**.
6. Select the USB drive from the **One Time Boot Menu**.
7. Type the BIOS setup program filename and press **Enter**.  
The **BIOS Update Utility** appears.
8. Follow the on-screen instructions to complete the BIOS update.

## Updating the BIOS from the F12 One-Time boot menu

Update your computer BIOS using the BIOS update.exe file that is copied to a FAT32 USB drive and booting from the F12 One-Time boot menu.

### About this task

#### BIOS Update

You can run the BIOS update file from Windows using a bootable USB drive or you can also update the BIOS from the F12 One-Time boot menu on the computer.

Most of the Dell computers built after 2012 have this capability, and you can confirm by booting your computer to the F12 One-Time Boot Menu to see if BIOS FLASH UPDATE is listed as a boot option for your computer. If the option is listed, then the BIOS supports this BIOS update option.

 **NOTE:** Only computers with BIOS Flash Update option in the F12 One-Time boot menu can use this function.

### Updating from the One-Time boot menu

To update your BIOS from the F12 One-Time boot menu, you need the following:

- USB drive formatted to the FAT32 file system (key does not have to be bootable)
- BIOS executable file that you downloaded from the Dell Support website and copied to the root of the USB drive
- AC power adapter that is connected to the computer
- Functional computer battery to flash the BIOS

Perform the following steps to perform the BIOS update flash process from the F12 menu:

 **CAUTION: Do not turn off the computer during the BIOS update process. The computer may not boot if you turn off your computer.**

### Steps

1. From a turn off state, insert the USB drive where you copied the flash into a USB port of the computer.
2. Turn on the computer and press F12 to access the One-Time Boot Menu, select BIOS Update using the mouse or arrow keys then press Enter.  
The flash BIOS menu is displayed.
3. Click **Flash from file**.
4. Select external USB device.
5. Select the file and double-click the flash target file, and then click **Submit**.
6. Click **Update BIOS**. The computer restarts to flash the BIOS.
7. The computer will restart after the BIOS update is completed.

# Troubleshooting

## Handling swollen Lithium-ion batteries

Like most laptops, Dell laptops use lithium-ion batteries. One type of lithium-ion battery is the lithium-ion polymer battery. Lithium-ion polymer batteries have increased in popularity in recent years and have become standard in the electronics industry due to customer preferences for a slim form factor (especially with newer ultra-thin laptops) and long battery life. Inherent to lithium-ion polymer battery technology is the potential for swelling of the battery cells.

Swollen battery may impact the performance of the laptop. To prevent possible further damage to the device enclosure or internal components leading to malfunction, discontinue the use of the laptop and discharge it by disconnecting the AC adapter and letting the battery drain.

Swollen batteries should not be used and should be replaced and disposed of properly. We recommend contacting Dell product support for options to replace a swollen battery under the terms of the applicable warranty or service contract, including options for replacement by a Dell authorized service technician.

The guidelines for handling and replacing Lithium-ion batteries are as follows:

- Exercise caution when handling Lithium-ion batteries.
- Discharge the battery before removing it from the system. To discharge the battery, unplug the AC adapter from the system and operate the system only on battery power. When the system will no longer power on when the power button is pressed, the battery is fully discharged.
- Do not crush, drop, mutilate, or penetrate the battery with foreign objects.
- Do not expose the battery to high temperatures, or disassemble battery packs and cells.
- Do not apply pressure to the surface of the battery.
- Do not bend the battery.
- Do not use tools of any type to pry on or against the battery.
- If a battery gets stuck in a device as a result of swelling, do not try to free it as puncturing, bending, or crushing a battery can be dangerous.
- Do not attempt to reassemble a damaged or swollen battery into a laptop.
- Swollen batteries that are covered under warranty should be returned to Dell in an approved shipping container (provided by Dell)—this is to comply with transportation regulations. Swollen batteries that are not covered under warranty should be disposed of at an approved recycling center. Contact Dell product support at <https://www.dell.com/support> for assistance and further instructions.
- Using a non-Dell or incompatible battery may increase the risk of fire or explosion. Replace the battery only with a compatible battery purchased from Dell that is designed to work with your Dell computer. Do not use a battery from other computers with your computer. Always purchase genuine batteries from <https://www.dell.com> or otherwise directly from Dell.

Lithium-ion batteries can swell for various reasons such as age, number of charge cycles, or exposure to high heat. For more information on how to improve the performance and lifespan of the laptop battery and to minimize the possibility of occurrence of the issue, search Dell Laptop Battery in the Knowledge Base Resource at [www.dell.com/support](http://www.dell.com/support).

## Locate the Service Tag or Express Service Code of your Dell computer

Your Dell computer is uniquely identified by a Service Tag or Express Service Code. To view relevant support resources for your Dell computer, we recommend entering the Service Tag or Express Service Code at [www.dell.com/support](http://www.dell.com/support).

For more information on how to find the Service Tag for your computer, see [Locate the Service Tag for your Dell Laptop](#).

## System-diagnostic lights

### Power and battery-status light

The power and battery status light indicates the power and battery status of the computer. These are the power states:

**Solid white:**Power adapter is connected and the battery has more than 5% charge.

**Amber:**Computer is running on battery and the battery has less than 5% charge.

**Off:**

- Power adapter is connected, and the battery is fully charged.
- Computer is running on battery, and the battery has more than 5% charge.
- Computer is in sleep state, hibernation, or turned off.

The power and battery-status light may also blink red or blue according to pre-defined "beep codes" indicating various failures.

For example, the power and battery-status light blinks red two times followed by a pause, and then blinks blue three times followed by a pause. This 2,3 pattern continues until the computer is turned off, indicating no memory or RAM is detected.

The following table shows different power and battery-status light patterns and associated problems.

**NOTE:** The following diagnostic light codes and recommended solutions are intended for Dell service technicians to troubleshoot problems. You should only perform troubleshooting and repairs as authorized or directed by the Dell technical support team. Damage due to servicing that is not authorized by Dell is not covered by your warranty.

**Table 20. Diagnostic-light LED codes**

Diagnostic light codes	Problem description
2,1	Processor failure
2,2	System board: BIOS or ROM (Read-Only Memory) failure
2,3	No memory or RAM (Random-Access Memory) detected
2,4	Memory or RAM (Random-Access Memory) failure
2,6	System-board or chipset error
2,7	Display failure - SBIOS message
3,1	RTC power failure
3,3	Recovery image not found
3,4	Recovery image found but invalid
3,5	Power-rail failure
3,6	System BIOS Flash incomplete

## SupportAssist diagnostics

### About this task

The SupportAssist diagnostics (previously known as ePSA diagnostics) performs a complete check of your hardware. The SupportAssist diagnostics is embedded in the BIOS and is launched by it internally. The SupportAssist diagnostics provides a set of options for particular devices or device groups. It allows you to:

- Run tests automatically or in an interactive mode.
- Repeat tests
- Display or save test results
- Run thorough tests to introduce additional test options and provide extra information about the failed device(s)
- View status messages that indicate if the tests are completed successfully
- View error messages that indicate if problems were encountered during the test

**NOTE:** Some tests are meant for specific devices and require user interaction. Ensure that you are present in front of the computer when the diagnostic tests are performed.

For more information, see [SupportAssist Pre-Boot System Performance Check](#).

# Recovering the operating system

When your computer is unable to boot to the operating system even after repeated attempts, it automatically starts Dell SupportAssist OS Recovery.

Dell SupportAssist OS Recovery is a standalone tool that is preinstalled in all Dell computers installed with Windows operating system. It consists of tools to diagnose and troubleshoot issues that may occur before your computer boots to the operating system. It enables you to diagnose hardware issues, repair your computer, back up your files, or restore your computer to its factory state.

You can also download it from the Dell Support website to troubleshoot and fix your computer when it fails to boot into their primary operating system due to software or hardware failures.

For more information about the Dell SupportAssist OS Recovery, see *Dell SupportAssist OS Recovery User's Guide* at [www.dell.com/serviceabilitytools](http://www.dell.com/serviceabilitytools). Click **SupportAssist** and then, click **SupportAssist OS Recovery**.

# Backup media and recovery options

It is recommended to create a recovery drive to troubleshoot and fix problems that may occur with Windows. Dell proposes multiple options for recovering Windows operating system on your Dell PC. For more information, see [Dell Windows Backup Media and Recovery Options](#).

# WiFi power cycle

## About this task

If your computer is unable to access the internet due to WiFi connectivity issues a WiFi power cycle procedure may be performed. The following procedure provides the instructions on how to conduct a WiFi power cycle:

 **NOTE:** Some ISPs (Internet Service Providers) provide a modem/router combo device.

## Steps

1. Turn off your computer.
2. Turn off the modem.
3. Turn off the wireless router.
4. Wait for 30 seconds.
5. Turn on the wireless router.
6. Turn on the modem.
7. Turn on your computer.

# Drain residual flea power (perform hard reset)

## About this task

Flea power is the residual static electricity that remains in the computer even after it has been powered off and the battery is removed.

For your safety, and to protect the sensitive electronic components in your computer, you are requested to drain residual flea power before removing or replacing any components in your computer.

Draining residual flea power, also known as a performing a "hard reset", is also a common troubleshooting step if your computer does not power on or boot into the operating system.

## To drain residual flea power (perform a hard reset)

## Steps

1. Turn off your computer.
2. Disconnect the power adapter from your computer.
3. Remove the base cover.

4. Remove the battery.
5. Press and hold the power button for 20 seconds to drain the flea power.
6. Install the battery.
7. Install the base cover.
8. Connect the power adapter to your computer.
9. Turn on your computer.

 **NOTE:** For more information about performing a hard reset, search in the Knowledge Base Resource at [www.dell.com/  
support](http://www.dell.com/support).





# Getting help and contacting Alienware

## Self-help resources



You can get information and help on Alienware products and services using these online self-help resources:

**Table 21. Alienware products and online self-help resources**

Self-help resources	Resource location
Information about Alienware products and services	<a href="http://www.alienware.com">www.alienware.com</a>
My Dell app	
Tips	
Contact Support	In Windows search, type <b>Contact Support</b> , and press <b>Enter</b> .
Online help for operating system	<a href="http://www.dell.com/support/windows">www.dell.com/support/windows</a>
Access top solutions, diagnostics, drivers and downloads, and learn more about your computer through videos, manuals and documents.	Your Alienware computer is uniquely identified by a Service Tag or Express Service Code. To view relevant support resources for your Dell computer, enter the Service Tag or Express Service Code at <a href="http://www.dell.com/support">www.dell.com/support</a> .  For more information on how to find the Service Tag for your computer, see <a href="#">Locate the Service Tag on your computer</a> .
Videos providing step-by-step instructions to service your computer	<a href="http://www.youtube.com/alienwareservices">www.youtube.com/alienwareservices</a>

## Contacting Alienware

To contact Alienware for sales, technical support, or customer service issues, see [www.alienware.com](http://www.alienware.com).

-  **NOTE:** Availability varies by country/region and product, and some services may not be available in your country/region.
-  **NOTE:** If you do not have an active Internet connection, you can find contact information about your purchase invoice, packing slip, bill, or Dell product catalog.