



OWNER'S MANUAL

Smart 3D Blu-ray Disc Player with Magic Remote

Please read this manual carefully before operating
your set and retain it for future reference.

BP730

P/NO : SAC35673402

Safety Information



CAUTION: TO REDUCE THE RISK OF ELECTRIC SHOCK DO NOT REMOVE COVER (OR BACK) NO USER-SERVICEABLE PARTS INSIDE REFER SERVICING TO QUALIFIED SERVICE PERSONNEL.



This lightning flash with arrowhead symbol within an equilateral triangle is intended to alert the user to the presence of uninsulated dangerous voltage within the product's enclosure that may be of sufficient magnitude to constitute a risk of electric shock to persons.



The exclamation point within an equilateral triangle is intended to alert the user to the presence of important operating and maintenance (servicing) instructions in the literature accompanying the product.

WARNING: This product contains chemicals known to the State of California to cause cancer and birth defects or other reproductive harm. ***Wash hands after handling.***

WARNING: TO PREVENT FIRE OR ELECTRIC SHOCK HAZARD, DO NOT EXPOSE THIS PRODUCT TO RAIN OR MOISTURE.

WARNING: Do not install this equipment in a confined space such as a book case or similar unit.

CAUTION: Do not block any ventilation openings. Install in accordance with the manufacturer's instructions.

Slots and openings in the cabinet are provided for ventilation and to ensure reliable operation of the product and to protect it from over heating. The openings shall be never be blocked by placing the product on a bed, sofa, rug or other similar surface. This product shall not be placed in a built-in installation such as a bookcase or rack unless proper ventilation is provided or the manufacturer's instruction has been adhered to.



CAUTION : CLASS 1M VISIBLE AND INVISIBLE LASER RADIATION WHEN OPEN. DO NOT VIEW DIRECTLY WITH OPTICAL INSTRUMENTS

Use of controls, adjustments or the performance of procedures other than those specified herein may result in hazardous radiation exposure.

CAUTION concerning the Power Cord

Most appliances recommend they be placed upon a dedicated circuit;

That is, a single outlet circuit which powers only that appliance and has no additional outlets or branch circuits. Check the specification page of this owner's manual to be certain. Do not overload wall outlets. Overloaded wall outlets, loose or damaged wall outlets, extension cords, frayed power cords, or damaged or cracked wire insulation are dangerous. Any of these conditions could result in electric shock or fire. Periodically examine the cord of your appliance, and if its appearance indicates damage or deterioration, unplug it, discontinue use of the appliance, and have the cord replaced with an exact replacement part by an authorized service centre. Protect the power cord from physical or mechanical abuse, such as being twisted, kinked, pinched, closed in a door, or walked upon. Pay particular attention to plugs, wall outlets, and the point where the cord exits the appliance. To disconnect power from the mains, pull out the mains cord plug. When installing the product, ensure that the plug is easily accessible.

This device is equipped with a portable battery or accumulator.

Safety way to remove the battery or the battery from the equipment: Remove the old battery or battery pack, follow the steps in reverse order than the assembly. To prevent contamination of the environment and bring on possible threat to human and animal health, the old battery or the battery put it in the appropriate container at designated collection points. Do not dispose of batteries or battery together with other waste. It is recommended that you use local, free reimbursement systems batteries and accumulators. The battery shall not be exposed to excessive heat such as sunshine, fire or the like.

CAUTION: The apparatus shall not be exposed to water (dripping or splashing) and no objects filled with liquids, such as vases, shall be placed on the apparatus.

FCC Compliance Statement

This device complies with part 15 of the FCC rules. Operation is subject to the following two conditions:

- (1) This device may not cause harmful interference, and
- (2) This device must accept any interference received, including interference that may cause undesired operation.

NOTE: This equipment has been tested and found to comply with the limits for a Class B digital device, pursuant to Part 15 of the FCC Rules. These limits are designed to provide reasonable protection against harmful interference in a residential installation. This equipment generates, uses, and can radiate radio frequency energy and, if not installed and used in accordance with the instructions, may cause harmful interference to radio communications. However, there is no guarantee that interference will not occur in a particular installation.

If this equipment does cause harmful interference to radio or television reception, which can be determined by turning the equipment off and on, the user is encouraged to try to correct the interference by one or more of the following measures:

- Reorient or relocate the receiving antenna.
- Increase the separation between the equipment and receiver.

- Connect the equipment into an outlet on a circuit different from that to which the receiver is connected.
- Consult the dealer or an experienced radio/TV technician for help.

CAUTION: Any changes or modifications not expressly approved by the party responsible for compliance could void the user's authority to operate this equipment.

FCC RF Radiation Exposure Statement : This equipment complies with FCC radiation exposure limits set forth for an uncontrolled environment. This equipment should be installed and operated with minimum distance 20 cm between the radiator and your body. End users must follow the specific operating instructions for satisfying RF exposure compliance. This transmitter must not be co-located or operating in conjunction with any other antenna or transmitter.

FCC Radio Frequency Interference Requirements

This device is restricted to indoor use due to its operation in the 5.15 to 5.25 GHz frequency range.

FCC requires this product to be used indoors for the frequency range 5.15 to 5.25 GHz to reduce the potential for harmful interference to co-channel Mobile Satellite systems. High power radars are allocated as primary users of the 5.25 to 5.35 GHz and 5.65 to 5.85 GHz bands. These radar stations can cause interference with and/or damage this device. This device cannot be co-located with any other transmitter.

CAUTION: Regulations of the FCC and FAA prohibit airborne operation of radio-frequency wireless devices because their signals could interfere with critical aircraft instruments.

Responsible Party :

LG Electronics USA, Inc. 1000 Sylvan Avenue
Englewood Cliffs, NJ 07632

TEL. : +1-800-243-0000

Notes on Copyrights

- Because AACS (Advanced Access Content System) is approved as content protection system for Blu-ray Disc format, similar to use of CSS (Content Scramble System) for DVD format, certain restrictions are imposed on playback, analog signal output, etc., of AACS protected contents. The operation of this product and restrictions on this product may vary depending on your time of purchase as those restrictions may be adopted and/or changed by AACS after the production of this product.
- Furthermore, BD-ROM Mark and BD+ are additionally used as content protection systems for Blu-ray Disc format, which imposes certain restrictions including playback restrictions for BD-ROM Mark and/or BD+ protected contents. To obtain additional information on AACS, BD-ROM Mark, BD+, or this product, please contact an authorized Customer Service Centre.
- Many BD-ROM/DVD discs are encoded with copy protection. Because of this, you should only connect your player directly to your TV, not to a VCR. Connecting to a VCR results in a distorted picture from copy-protected discs.
- This product incorporates copyright protection technology that is protected by U.S. patents and other intellectual property rights. Use of this copyright protection technology must be authorized by Rovi Corporation, and is intended for home and other limited viewing uses only unless otherwise authorized by Rovi Corporation. Reverse engineering or disassembly is prohibited.
- Under the U.S. Copyright laws and Copyright laws of other countries, unauthorized recording, use, display, distribution, or revision of television programs, videotapes, BD-ROM discs, DVDs, CDs and other materials may subject you to civil and/or criminal liability.

Caution

- Watching a 3D content for a long period time may cause dizziness or tiredness.
- It is not recommended to watch a movie in 3D mode for infirm, child and pregnant woman.
- If you are experiencing headache, tiredness or dizziness while viewing contents in 3D, it is strongly recommended to stop the playback and rest until you feel normal.

IMPORTANT SAFETY INSTRUCTIONS

1. Read these instructions.
2. Keep these instructions.
3. Heed all warnings.
4. Follow all instructions.
5. Do not use this apparatus near water.
6. Clean only with dry cloth.
7. Do not block any ventilation openings. Install in accordance with the manufacturer's instructions.
8. Do not install near any heat sources such as radiators, heat registers, stoves, or other apparatus (including amplifiers) that produce heat.
9. Do not defeat the safety purpose of the polarized or grounding-type plug. A polarized plug has two blades with one wider than the other. A grounding type plug has two blades and a third grounding prong. The wide blade or the third prong are provided for your safety. If the provided plug does not fit into your outlet, consult an electrician for replacement of the obsolete outlet.
10. Protect the power cord from being walked on or pinched particularly at plugs, convenience receptacles, and the point where they exit from the apparatus.
11. Only use attachments/accessories specified by the manufacturer.
12. Use only with the cart, stand, tripod, bracket, or table specified by the manufacturer, or sold with the apparatus. When a cart is used, use caution when moving the cart/apparatus combination to avoid injury from tip-over.
13. Unplug this apparatus during lightning storms or when unused for long periods of time.
14. Refer all servicing to qualified service personnel. Servicing is required when the apparatus has been damaged in any way, such as power-supply cord or plug is damaged, liquid has been spilled or objects have fallen into the apparatus, the apparatus has been exposed to rain or moisture, does not operate normally, or has been dropped.



Table of Contents

1 Getting Started

- 2 Safety Information
- 8 Introduction
 - 8 – Playable discs and symbols used in this manual
 - 9 – About the “” symbol display
 - 9 – Regional code
- 10 Remote Control
 - 11 – Magic remote control functions
- 12 Front Panel
- 12 Rear Panel

2 Connecting

- 13 Connecting to Your TV
 - 14 – What is SIMPLINK?
 - 14 – Resolution setting
- 15 Connecting to an Amplifier
 - 16 – Connecting to an amplifier via HDMI output
 - 16 – Connecting to an amplifier via digital audio output
- 17 Connecting to your Home Network
 - 17 – Wired network connection
 - 17 – Wired network setup
 - 19 – Wireless network connection
 - 19 – Wireless network setup

3 System Setting

- 22 Initial Setup
- 23 Settings
 - 23 – Adjust the setup settings
 - 23 – [NETWORK] menu
 - 25 – [DISPLAY] menu
 - 27 – [LANGUAGE] menu
 - 27 – [AUDIO] menu
 - 29 – [LOCK] menu
 - 30 – [OTHERS] menu

4 Operating

- 31 Home Menu Display
 - 31 – Using [HOME] menu
 - 31 – Using the Smart Share
- 32 Playing the Linked Devices
 - 32 – Playing a disc
 - 32 – Playing Blu-ray 3D disc
 - 33 – Playing a file on disc/USB device
 - 34 – Playing a file on a network server
- 35 Using Home Network Server for PC
 - 35 – Installing Nero MediaHome 4 Essentials
 - 35 – Sharing files and folders
 - 36 – About Nero MediaHome 4 Essentials
 - 36 – System requirements
 - 37 General Playback
 - 37 – Basic operations for video and audio content
 - 37 – Basic operations for photo content
 - 38 – Resume playback
 - 38 – Last scene memory
- 39 On-Screen Display
 - 39 – To control video playback
 - 40 – To control photo view
- 41 Advanced Playback
 - 41 – Repeat playback
 - 41 – Repeating a specific portion
 - 41 – Playing from selected time
 - 42 – Selecting a subtitle language
 - 42 – Hearing a different audio
 - 42 – Watching from a different angle
 - 42 – Changing the TV Aspect Ratio
 - 43 – Changing subtitle Code Page
 - 43 – Changing the Picture Mode
 - 43 – Viewing content information
 - 44 – Changing content list view
 - 44 – Selecting a subtitle file
 - 45 – Listening to music during slide show
 - 45 – Converting 2D content to 3D
- 46 Advanced Features
 - 46 – Wi-Fi Direct™
 - 47 – Enjoying Miracast™
 - 47 – Enjoying BD-Live™
 - 48 – LG Tag On
 - 48 – LG AV Remote
 - 48 – Private Sound Mode

- 49 – Viewing information from Gracenote Media Database
- 50 Audio CD recording
- 51 Using the Premium
- 51 Using the LG Smart World
- 52 – Signing in
- 52 – Searching online content
- 53 Using the My Apps Menu

5 Troubleshooting

- 54 Troubleshooting
- 54 – General
- 55 – Network
- 56 – Picture
- 56 – Customer support
- 56 – Open source software notice

6 Appendix

- 57 About Magic Remote Control
- 58 Network Software Update
- 58 – Network update notification
- 58 – Software update
- 60 Additional Information
- 60 – File requirement
- 61 – AVCHD (Advanced Video Codec High Definition)
- 62 – About DLNA
- 62 – Certain system requirements
- 62 – Compatibility notes
- 63 Audio Output Specifications
- 65 Area Code List
- 66 Language Code List
- 67 Trademarks and Licenses
- 70 Specifications
- 71 Maintenance
- 71 – Handling the unit
- 71 – Notes on discs
- 72 Important Information Relating to Network Services

Some of the content in this manual may differ from your player depending on the software of the player or your service provider.

1

2

3













4

5

6

Introduction

Playable discs and symbols used in this manual

| Media/Term | Logo | Symbol | Description |
|--|---|---|---|
| Blu-ray |    | BD | <ul style="list-style-type: none"> Discs such as movies that can be purchased or rented. "Blu-ray 3D" discs and "Blu-ray 3D ONLY" discs. BD-R/RE discs that are recorded in BDAV format. |
| | | MOVIE MUSIC PHOTO | <ul style="list-style-type: none"> BD-R/RE discs that contain Movie, Music or Photo files. ISO 9660+JOLIET, UDF and UDF Bridge format |
| DVD-ROM DVD-R DVD-RW DVD+R DVD+RW (12 cm) |      | DVD | <ul style="list-style-type: none"> Discs such as movies that can be purchased or rented. Movie mode and finalized only Supports the dual layer disc also |
| | | AVCHD | Finalized AVCHD format |
| | | MOVIE MUSIC PHOTO | <ul style="list-style-type: none"> DVD±R/RW discs that contain Movie, Music or Photo files. ISO 9660+JOLIET, UDF and UDF Bridge format |
| DVD-RW (VR) (12 cm) |  | DVD | VR mode and finalized only |
| Audio CD (12 cm) |  | ACD | Audio CD |
| CD-R/RW (12 cm) |  | MOVIE MUSIC PHOTO | <ul style="list-style-type: none"> CD-R/RW discs that contain Movie, Music or Photo files. ISO 9660+JOLIET, UDF and UDF Bridge format |
| Note | – |  | Indicates special notes and operating features. |
| Caution | – |  | Indicates cautions for preventing possible damages from abuse. |

! Note

- Depending on the conditions of the recording equipment or the CD-R/RW (or DVD±R/RW) disc itself, some CD-R/RW (or DVD±R/RW) discs cannot be played on the unit.
- Depending on the recording software & the finalization, some recorded discs (CD-R/RW, DVD±R/RW, BD-R/RE) may not be playable.
- BD-R/RE, DVD±R/RW and CD-R/RW discs recorded using a personal computer or a DVD or CD Recorder may not play if the disc is damaged or dirty, or if there is dirt or condensation on the player's lens.
- If you record a disc using a personal computer, even if it is recorded in a compatible format, there are cases in which it may not play because of the settings of the application software used to create the disc. (Check with the software publisher for more detailed information.)
- This player requires discs and recordings to meet certain technical standards in order to achieve optimal playback quality.
- Pre-recorded DVDs are automatically set to these standards. There are many different types of recordable disc formats (including CD-R containing MP3 or WMA files) and these require certain pre-existing conditions to ensure compatible playback.
- Customers should note that permission is required in order to download MP3 / WMA files and music from the Internet. Our company has no right to grant such permission. Permission should always be sought from the copyright owner.
- You have to set the disc format option to [Mastered] in order to make the discs compatible with the LG players when formatting rewritable discs. When setting the option to Live System, you cannot use it on LG player. (Mastered/Live File System : Disc format system for windows Vista)

About the "⓪" symbol display

"⓪" may appear on your TV display during operation and indicates that the function explained in this owner's manual is not available on that specific media.

Regional code

This unit has a regional code printed on the rear of the unit. This unit can play only BD-ROM or DVD discs labelled same as the rear of the unit or "ALL".

Remote Control

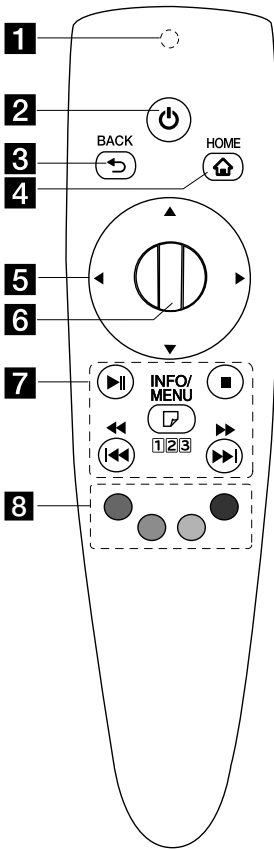

- 1 Remote Control Indicator:** (RF & Bluetooth transmitter) Blinks when operating.
- 2** **POWER** (⏻): Switches the unit ON or OFF.
- 3** **BACK** (⏪): Exits the menu or returns to the previous screen.
- 4** **HOME** (🏠): Displays the Home screen.
- 5** **Direction buttons:** Selects an option in the menu. If you press the navigation button while moving the pointer on the screen, the pointer disappears, and the Magic remote control works as a regular remote control. To display the pointer again, shake the Magic remote control from side to side.
- 6** **Wheel** (⦿): Selects menus or options and confirms your input; Scrolls the screen to search a menu on the web browser.
- 7** **▶|| (Play/Pause):** Starts playback. / Pauses playback.
■ (Stop): Stops playback.
◀◀/▶▶: Searches backward or forward. (Press and hold **◀◀/▶▶**)
◀◀/▶▶: Moves previous/next track or file.
□ (INFO/MENU): Displays or exits On-Screen Display.
1|2|3: If necessary, you can use a virtual numbered keypad. (Press and hold **□** (INFO/MENU))
- 8** **Colored (R, G, Y, B) buttons:** Use to navigate BD-ROM menus. They are also used as shortcut buttons for specific menus.

Magic remote control functions

The Magic remote control operates by pairing with your unit. Once you purchased the unit, please register the Magic remote control as follows;

To register the Magic remote control

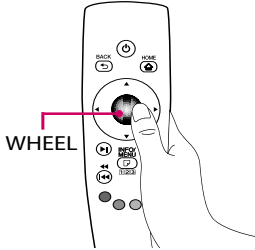

To use the Magic remote control, register it with your unit first.

1. Turn on the unit and wait for about 10 seconds and then press and hold **Wheel** button while pointing the remote control at the unit.
2. The remote control is automatically registered and registration completion message appears on the screen.

! Note

If you failed to register the Magic remote control, turn off the unit and try again.

Battery installation

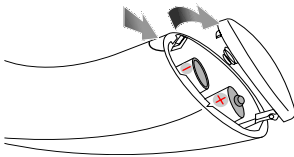

Open the battery cover at the bottom of the Remote Control, and insert two (1.5 V AA) alkaline batteries with **+** and **-** matched correctly.

! Caution

Do not mix old and new batteries, as this may damage the remote control.

How to use Magic remote control

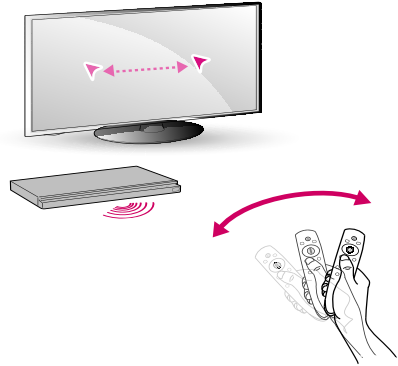

- Shake the remote control slightly to make the pointer appear on the screen.
- Shake the Magic remote control slightly to the right and left to make the pointer appear on the center of screen.
- The magic pointer disappears when the remote control is not moved for five seconds.

How to use Magic remote tip

- When you press the wheel, it also functions as Selection button.
- You can scroll through menus using the Wheel.
- Use your wrist to move the pointer more easily.

! Note

- If the Magic remote control's connection is unstable or has any problems, cancel the registration and try it again. (page 57)
- Depending on the content, the pointing of the magic remote control does not work. For controlling, please use the direction keys on the remote.

Front Panel

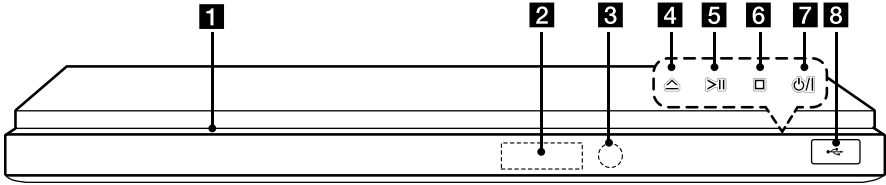

- 1** Disc Slot
- 2** Display Window
- 3** Remote Sensor
- 4** △ (OPEN / CLOSE)
- 5** >|| (PLAY / PAUSE)
- 6** □ (STOP)
- 7** ⏻ / | (POWER)
- 8** USB Port

Rear Panel

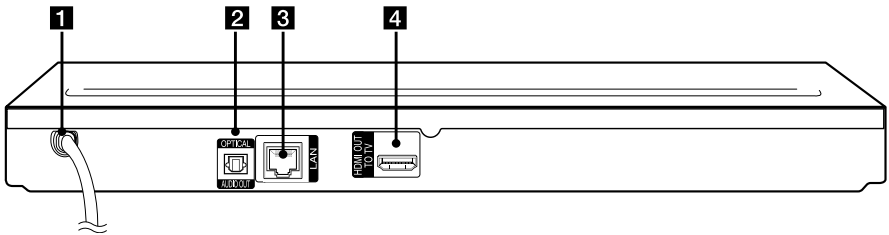

- 1** AC power cord
- 2** DIGITAL AUDIO OUT (OPTICAL)
- 3** LAN port
- 4** HDMI OUT

Connecting to Your TV

If you have a HDMI TV or monitor, you can connect it to this player using a HDMI cable (Type A, High Speed HDMI™ Cable). Connect the HDMI jack on the player to the HDMI jack on a HDMI compatible TV or monitor.

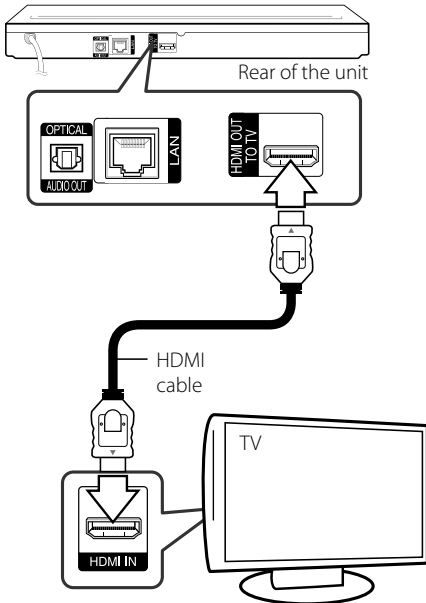

Set the TV's source to HDMI (refer to TV's Owner's manual).

! Note

Please refer to the manuals of your TV, Stereo System or other devices as necessary to make the best connections.

Additional Information for HDMI

- When you connect a HDMI or DVI compatible device make sure of the following:
 - Try switching off the HDMI/DVI device and this player. Next, switch on the HDMI/DVI device and leave it for around 30 seconds, then switch on this player.
 - The connected device's video input is set correctly for this unit.
 - The connected device is compatible with 720x480p, 1280x720p, 1920x1080i or 1920x1080p video input.
- Not all HDCP-compatible HDMI or DVI devices will work with this player.
 - The picture will not be displayed properly with non-HDCP device.

! Note

- If a connected HDMI device does not accept the audio output of the player, the HDMI device's audio sound may be distorted or may not output.
- When you use HDMI connection, you can change the resolution for the HDMI output. (Refer to "Resolution Setting" on page 14)
- Select the type of video output from the HDMI OUT jack using [HDMI Color Setting] option on the [Settings] menu (see page 26).
- Changing the resolution when the connection has already been established may result in malfunctions. To solve the problem, turn off the player and then turn it on again.
- When the HDMI connection with HDCP is not verified, TV screen is changed to black screen. In this case, check the HDMI connection, or disconnect the HDMI cable.
- If there are noises or lines on the screen, please check the HDMI cable (length is generally limited to 4.5 m).

What is SIMPLINK?



Some functions of this unit are controlled by the TV's remote control when this unit and LG TV's with SIMPLINK are connected through HDMI connection.

Controllable functions by LG TV's remote control; Play, Pause, Scan, Skip, Stop, Power Off, etc.

Refer to the TV owner's manual for the details of SIMPLINK function.

LG TV's with SIMPLINK function has the logo as shown above.

! Note

Depending on the disc type or playing status, some SIMPLINK operation may differ from your purpose or not work.

Resolution setting

The player provides several output resolutions for HDMI OUT jack. You can change the resolution using [Settings] menu.

1. Press HOME (⏠).
2. Use ◀/▶ to select the [Settings] and press **Wheel** (⦿). The [Settings] menu appears.
3. Use ▲/▼ to select [DISPLAY] option then press ▶ to move to the second level.
4. Use ▲/▼ to select the [Resolution] option then press **Wheel** (⦿) to move to the third level.



4. Use ▲/▼ to select the desired resolution then press **Wheel** (⦿) to confirm your selection.



Note

- If your TV does not accept the resolution you have set on the player, you can set resolution to 480p as follows:
 1. Press HOME (🏠) to disappear the HOME menu.
 2. Press □ (STOP) for more than 5 seconds.
- If you select a resolution manually and then connect the HDMI jack to TV and your TV does not accept it, the resolution setting is set to [Auto].
- If you select a resolution that your TV does not accept, the warning message will appear. After resolution change, if you cannot see the screen, please wait 20 seconds and the resolution will automatically revert back to the previous resolution.
- The 1080p video output frame rate may be automatically set to either 24 Hz or 60 Hz depending both on the capability and preference of the connected TV and based on the native video frame rate of the content on the BD-ROM disc.

Connecting to an Amplifier

Make one of the following connections, depending on the capabilities of your existing equipment.

- HDMI Audio connection (page 16)
- Digital Audio connection (page 16)

Since many factors affect the type of audio output, see "Audio Output Specifications" for details (page 63).

About Digital Multi-channel sound

A digital multi-channel connection provides the best sound quality. For this, you need a multi-channel Audio/Video Receiver that supports one or more of the audio formats supported by your player. Check the logos on the front of the Audio/Video receiver and the manual. (PCM Stereo, PCM Multi-Ch, Dolby Digital, Dolby Digital Plus, Dolby TrueHD, DTS and/or DTS-HD)

Connecting to an amplifier via HDMI output

Connect the player's HDMI OUT jack to the corresponding in jack on your amplifier using a HDMI cable.

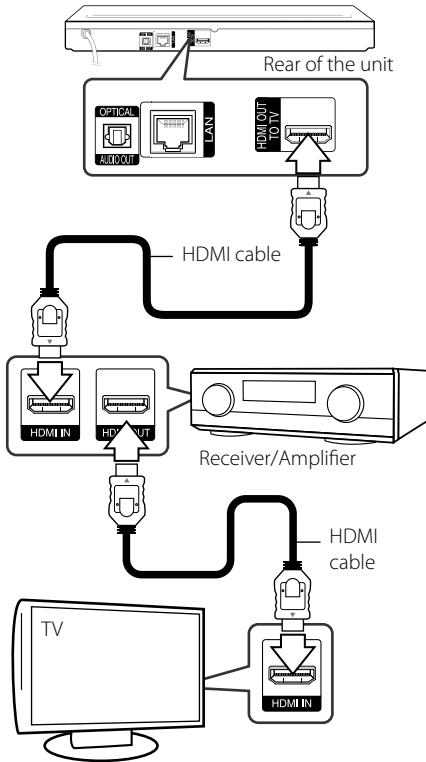

Connect the amplifier's HDMI output jack to HDMI input jack on your TV using a HDMI cable if your amplifier has HDMI output jack. (Refer to amplifier's owner's manual)

You will need to activate the player's digital output. (See "[AUDIO] Menu" on page 27)

Connecting to an amplifier via digital audio output

Connect the player's OPTICAL AUDIO OUT jack to the corresponding in jack on your amplifier using an optional digital audio cable.

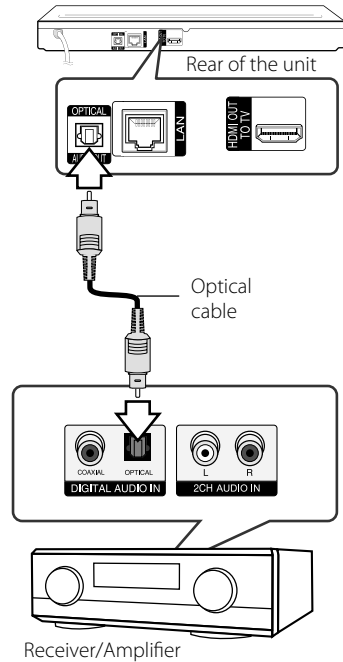

You will need to activate the player's digital output. (See "[AUDIO] Menu" on page 27.)

Connecting to your Home Network

This player can be connected to a local area network (LAN) via the LAN port on the rear panel or the internal wireless module.

By connecting the unit to a broadband home network, you have access to services such as software updates, BD-Live interactivity and on-line content services.

Wired network connection

Using a wired network provides the best performance, because the attached devices connect directly to the network and are not subject to radio frequency interference.

Please refer to the documentation for your network device for further instructions.

Connect the player's LAN port to the corresponding port on your Modem or Router using a commercially available LAN or Ethernet cable.

Note

- When plugging or unplugging the LAN cable, hold the plug portion of the cable. When unplugging, do not pull on the LAN cable but unplug while pressing down on the lock.
- Do not connect a modular phone cable to the LAN port.
- Since there are various connection configurations, please follow the specifications of your telecommunication carrier or internet service provider.
- If you want to access content from DLNA servers, this player must be connected to the same local area network with them via a router.
- To set your PC as a DLNA server, install the supplied Nero MediaHome 4 on your PC. (see page 35)

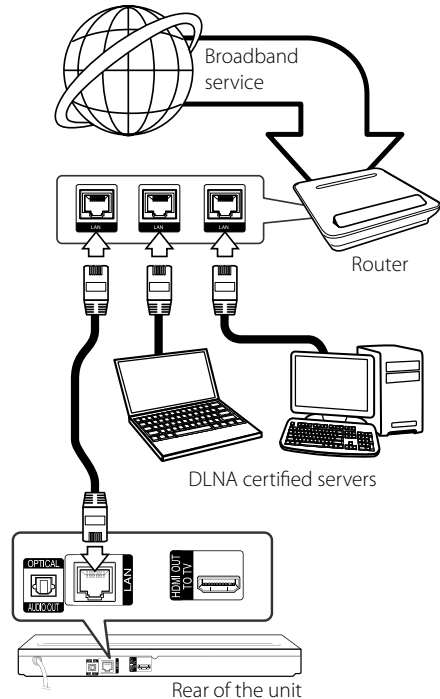

Wired network setup

If there is a DHCP server on the local area network (LAN) via wired connection, this player will automatically be allocated an IP address. After making the physical connection, a small number of home networks may require the player's network setting to be adjusted. Adjust the [NETWORK] setting as follow.

Preparation

Before setting the wired network, you need to connect the broadband internet to your home network.

1. Select [Connection Setting] option in the [Settings] menu then press **Wheel** (⊙).



2. Read the preparations for the network settings and then press **Wheel** (⊙) while [Start] is highlighted.



Network will automatically be connected to the unit.



Advanced Setting

If you want to set the network settings manually, use ▲/▼ to select [Advanced Setting] on the [Network Setting] menu and press **Wheel** (⊙).

1. Use ▲/▼ to select [Wired] and press **Wheel** (⊙).

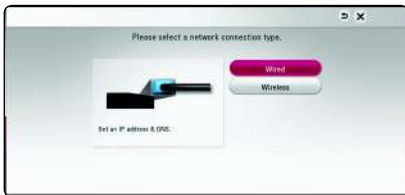

2. Use ▲/▼/◀/▶ to select the IP mode between [Dynamic] and [Static].

Normally, select [Dynamic] to allocate an IP address automatically.



Note

- If there is no DHCP server on the network and you want to set the IP address manually, select [Manual Input] then set [IP Address], [Subnet Mask], [Gateway] and [DNS Server].

3. Select [Next] and press **Wheel** (⊙) to apply network settings.



Network connection status is displayed on the screen.

4. Press **Wheel** (⊙) while [OK] is highlighted to finish the wired network settings.

Wireless network connection

Another connection option is to use an Access Point or a wireless router. The network configuration and connection method may vary depending on the equipment in use and the network environment.

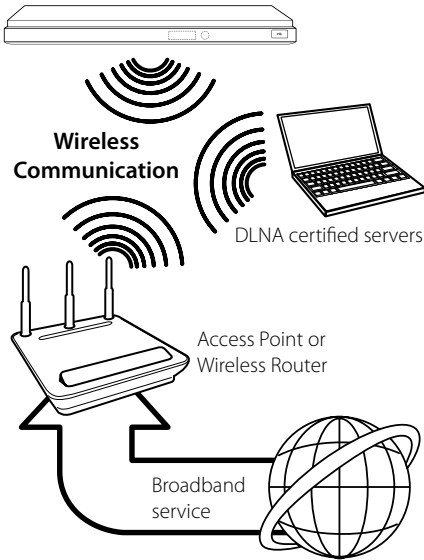

Refer to the setup instructions supplied with your access point or wireless router for detailed connection steps and network settings.

For best performance, a direct wired connection from this player to your home network's router or cable/DSL modem is always the best option. If you do choose to use the wireless option, note that performance can sometimes be affected by other electronic devices in the home.

Wireless network setup

For the wireless network connection, the player needs to be set up for network communication. This adjustment can be done from the [Settings] menu. Adjust the [NETWORK] setting as follow. Setting up the access point or the wireless router is required before connecting the player to the network.

Preparation

Before setting the wireless network, you need to:

- connect the broadband internet to the wireless home network.
- set the access point or wireless router.
- note the SSID and security code of the network.

1. Select [Connection Setting] option in the [Settings] menu then press **Wheel** (⦿).
2. Read the preparations for the network settings and then press **Wheel** (⦿) while [Start] is highlighted.



If wired network is not connected to the unit, all available networks are displayed on the screen.

3. Use ▲/▼ to select a desired SSID of wireless network and press **Wheel** (⦿).



If you have security on your access point, you need to input the security code as necessary.

! Note

If you use other characters than the english alphabet or digits for the SSID name of your access point or wireless router, it may be displayed differently.



Note

- WEP security mode generally have 4 keys available on an access point setting. If your access point or wireless router use WEP security, enter the security code of the key "No.1" to connect on your home network.
- An Access Point is a device that allows you to connect to your home network wirelessly.

4. Use ▲/▼/◀/▶ to select the IP mode between [Dynamic] and [Static]. Normally, select [Dynamic] to allocate an IP address automatically.

Note

If there is no DHCP server on the network and you want to set the IP address manually, select [Static] then set [IP Address], [Subnet Mask], [Gateway] and [DNS Server].

5. Select [Next] and press **Wheel** to apply network settings.



Network connection status is displayed on the screen.

6. Select [OK] and press **Wheel** to complete the network connection.

Advanced Setting

If you want to set the network settings manually, use ▲/▼ to select [Advanced Setting] on the [Network Setting] menu and press **Wheel**.

1. Use ▲/▼ to select [Wireless] and press **Wheel**.



[AP List] - Scans all available access points or wireless routers within range and display them as a list.

[Network name (SSID)] – Your access point may not be broadcasting its network name (SSID). Check your access point settings through your computer and either set your access point to broadcast SSID, or manually enter the network name in [Network name(SSID)].

[PBC] – If your access point or wireless router that supports the PBC (Push Button Configuration) method, select this option and press the Push Button on your access point within 120 counts. You do not need to know the network name (SSID) and security code of your access point.

[PIN] – If your access point supports the PIN Code configuration method based on WPS (Wi-Fi Protected Setup), select this option and note the code number on the screen. And then, enter the PIN number on a setting menu of your access point to connect. Refer to the documentation for your network device.

2. Follow the instructions of each connection method on the screen.

Note

To use PBC and PIN network connection, security mode of your access point must be set to OPEN or AES.

Notes on network connection

- Many network connection problems during set up can often be fixed by re-setting the router or modem. After connecting the player to the home network, quickly power off and/or disconnect the power cable of the home network router or cable modem. Then power on and/or connect the power cable again.
- Depending on the internet service provider (ISP), the number of devices that can receive internet service may be limited by the applicable terms of service. For details, contact your ISP.
- Our company is not responsible for any malfunction of the player and/or the internet connection feature due to communication errors/malfunctions associated with your broadband internet connection, or other connected equipment.
- The features of BD-ROM discs made available through the Internet Connection feature are not created or provided by our company, and our company is not responsible for their functionality or continued availability. Some disc related material available by the Internet Connection may not be compatible with this player. If you have questions about such content, please contact the producer of the disc.
- Some internet contents may require a higher bandwidth connection.
- Even if the player is properly connected and configured, some internet contents may not operate properly because of internet congestion, the quality or bandwidth of your internet service, or problems at the provider of the content.
- Some internet connection operations may not be possible due to certain restrictions set by the Internet service provider (ISP) supplying your broadband Internet connection.
- Any fees charged by an ISP including, without limitation, connection charges are your responsibility.
- A 10 Base-T or 100 Base-TX LAN port is required for wired connection to this player. If your internet service does not allow for such a connection, you will not be able to connect the player.
- You must use a Router to use xDSL service.
- A DSL modem is required to use DSL service and a cable modem is required to use cable modem service. Depending on the access method of and

subscriber agreement with your ISP, you may not be able to use the internet connection feature contained in this player or you may be limited to the number of devices you can connect at the same time. (If your ISP limits subscription to one device, this player may not be allowed to connect when a PC is already connected.)

- The use of a "Router" may not be allowed or its usage may be limited depending on the policies and restrictions of your ISP. For details, contact your ISP directly.
- The wireless network operate at 2.4 GHz radio frequencies that are also used by other household devices such as cordless telephone, *Bluetooth*® devices, microwave oven, and can be affected by interference from them.
- Turn off all unused network equipment in your local home network. Some devices may generate network traffic.
- For the purpose of the better transmission, placing the player from the access point as close as possible.
- In some instances, placing the access point or wireless router at least 0.45 m above the floor may improve the reception.
- Move closer to the access point if possible or re-orient the player so there is nothing between it and the access point.
- The reception quality over wireless depends on many factors such as type of the access point, distance between the player and access point, and the location of the player.
- Set your access point or wireless router to Infrastructure mode. Ad-hoc mode is not supported.

Initial Setup

When you turn on the unit for the first time, the initial setup wizard appears on the screen. Set the display language and network settings on the initial setup wizard.

1. Press **⏻** (POWER).

The initial setup wizard appears on the screen.

2. Use **▲/▼/◀/▶** to select a display language and press **Wheel** (⊙).



3. Try the some features of your Magic remote control by following the guide on the screen.



4. Read and prepare the preparations for the network settings and then press **Wheel** (⊙) while [Start] is highlighted.



If wired network is connected, the network connection setting will automatically be finished.

5. All available networks are displayed on the screen. Use **▲/▼** to select [Wired Network] or desired SSID of wireless network and press **Wheel** (⊙).



If you have security on your access point, you need to input the security code as necessary.

6. Use **▲/▼/◀/▶** to select the IP mode between [Dynamic] and [Static]. Normally, select [Dynamic] to allocate an IP address automatically.



7. Select [Next] and press **Wheel** (⊙) to apply network settings.



Network connection status is displayed on the screen.

For details on network settings, refer to "Connecting to your Home Network" on page 17.

8. Check all the settings that you have set in the previous steps.



Press **Wheel** (⊙) while [Finish] is highlighted to finish the initial setup settings. If there is any settings to be changed, use **▲/▼/◀/▶** to select **↶** and press **Wheel** (⊙).

Settings

Adjust the setup settings

You can change the settings of the player in the [Settings] menu.

1. Press HOME (🏠).



2. Use ◀/▶ to select the [Settings] and press **Wheel** (⦿). The [Settings] menu appears.

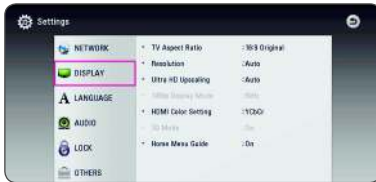

3. Use ▼/▲ to select the first setup option, and move to the second level.

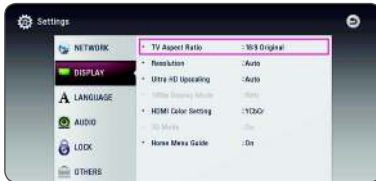

4. Use ◀/▶ to select a second setup option, and press **Wheel** (⦿) to move to the third level.



5. Use ▼/▲ to select a desired setting, and press **Wheel** (⦿) to confirm your selection.

[NETWORK] menu

The [NETWORK] settings are needed to use the software update, BD-Live and on-line content services.

Connection Setting

If your home network environment is ready to connect the player, the player needs to be set the wired or wireless network connection for network communication. (See "Connecting to your Home Network" on page 17.)

Connection Status

If you want to check the network status on this player, select the [Connection Status] options and press **Wheel** (⦿) to check whether a connection to the network and the internet have been established.

BD-LIVE connection

You can restrict Internet access when BD-Live functions are used.

[Permitted]

Internet access is permitted for all BD-Live contents.

[Partially permitted]

Internet access is permitted only for BD-Live contents which have content owner certificates. Internet access and AACSS Online functions are prohibited for all BD-Live contents without a certificate.

[Prohibited]

Internet access is prohibited for all BD-Live contents.

Smart Service Setting

[Country Setting]

Select your area for displaying proper online content service.

[Initialize]

Depending on the region, [Initialize] function may not be available.

Device Name

You can make a network name using virtual keyboard. This player will be recognised by the name you are entering on your home network.

Wi-Fi Direct

This player is a Wi-Fi Direct™ certified device. Wi-Fi Direct is the technology that devices to connect each other without connecting to an Access point or a router. Press **Wheel** (⦿) to display the Wi-Fi Direct menu. Refer to page 46 for the device connection.

Network Play

This function allows you to control the playback of media streamed from DLNA media server by a DLNA certified smartphone. Most DLNA certified smartphone has a function to control the playback media on your home network. Set this option to [On] for allowing your smartphone to control this unit. Refer to instructions of your DLNA certified smartphone or the application for more detailed information.

! Note

- This unit and the DLNA certified smartphone must be connected to the same network.
- To use the [Network Play] function using a DLNA certified smartphone, press HOME (🏠) to display the home menu before connecting to this unit.
- While controlling the unit using the [Network Play] function, the remote control may not work.
- Available file formats described on page 60 are not always supported on [Network Play] function.

[DISPLAY] menu

TV Aspect Ratio

Select a TV aspect ratio option according to your TV type.

[4:3 Letter Box]

Select when a standard 4:3 TV is connected. Displays theatrical images with masking bars above and below the picture.

[4:3 Pan Scan]

Select when a standard 4:3 TV is connected. Displays pictures cropped to fill your TV screen. Both sides of the picture are cut off.

[16:9 Original]

Select when a 16:9 wide TV is connected. The 4:3 picture is displayed with an original 4:3 aspect ratio, with black bars appearing at the left and right sides.

[16:9 Full]

Select when a 16:9 wide TV is connected. The 4:3 picture is adjusted horizontally (in a linear proportion) to fill the entire screen.



Note

You cannot select [4:3 Letter Box] and [4:3 Pan Scan] option when the resolution is set to higher than 720p.

Resolution

Sets the output resolution of the HDMI video signal. Refer to page 14 for details about the resolution setting.

[Auto]

If the HDMI OUT jack is connected to TVs providing display information (EDID), automatically selects the resolution best suited to the connected TV.

[480p]

Outputs 480 lines of progressive video.

[720p]

Outputs 720 lines of progressive video.

[1080i]

Outputs 1080 lines of interlaced video.

[1080p]

Outputs 1080 lines of progressive video.

Ultra HD Upscaling

This feature allows the unit to up-scale the original video resolution to Ultra HD resolution and output via HDMI connection.

[Auto]

If you connect a display capable of displaying Ultra HD resolution, this unit will output video signals in Ultra HD resolution automatically.

[Off]

The unit will turn off the Up-scaling feature.



Note

- This unit will output video signals in Ultra HD resolution when it plays BD-ROM disc formatted in 24 Hz.
- The playback pictures may be momentarily interrupted when the resolutions switch.

1080p Display Mode

When the resolution is set to 1080p, select [24 Hz] for smooth presentation of film material (1080p/24 Hz) with a HDMI-equipped display compatible with 1080p/24 Hz input.

! Note

- When you select [24 Hz], you may experience some picture disturbance when the video switches video and film material. In this case, select [60 Hz].
- Even when [1080p Display Mode] is set to [24 Hz], if your TV is not compatible with 1080p/24 Hz, the actual frame frequency of the video output will be 60 Hz to match the video source format.

HDMI Color Setting

Select the type of output from the HDMI OUT jack. For this setting, please refer to the manuals of your display device.

[YCbCr]

Select when connecting to a HDMI display device.

[RGB]

Select when connecting to a DVI display device.

3D Mode

Select the type of output mode for Blu-ray 3D disc playback.

[Off]

Blu-ray 3D disc playback will output as 2D mode like a normal BD-ROM disc playback.

[On]

Blu-ray 3D disc playback will output as 3D mode.

! Note

You cannot select [4:3 Letter Box] and [4:3 Pan Scan] option when the resolution is set to higher than 720p.

Home Menu Guide

This function allows you to display or delete the guide bubble on the Home Menu. Set this option to [On] for displaying guide.

[LANGUAGE] menu

Display Menu

Select a language for the [Settings] menu and on-screen display.

Disc Menu/Disc Audio/ Disc Subtitle

Select the language you prefer for the audio track (disc audio), subtitles, and the disc menu.

[Original]

Refers to the original language in which the disc was recorded.

[Other]

Press **Wheel** (⦿) to select another language. Enter the corresponding 4-digit number according to the language code list on page 66.

[Off] (Disc Subtitle only)

Turn off Subtitle.

! Note

Depending on the disc, your language setting may not work.

[AUDIO] menu

Each disc has a variety of audio output options. Set the player's Audio options according to the type of audio system you use.

! Note

Since many factors affect the type of audio output, see "Audio Output Specifications" on page 63 for details.

Digital Output

[PCM Stereo] (HDMI, OPTICAL)

Select if you connect this unit's HDMI OUT or DIGITAL AUDIO OUT jack to a device with two-channel digital stereo decoder.

[PCM Multi-Ch] (HDMI only)

Select if you connect this unit's HDMI OUT jack to a device with multi-channel digital decoder.

[DTS Re-Encode] (HDMI, OPTICAL)

Select if you connect this unit's HDMI OUT or DIGITAL AUDIO OUT jack to a device with DTS decoder.

[BitStream] (HDMI, OPTICAL)

Select if you connect this unit's DIGITAL AUDIO OUT and HDMI OUT jack to a device with LPCM, Dolby Digital, Dolby Digital Plus, Dolby TrueHD, DTS and DTS-HD decoder.

! Note

- When [Digital Output] option is set to [PCM Multi-Ch], the audio may output as PCM Stereo if the PCM Multi-Ch information is not detected from HDMI device with EDID.
- If the [Digital Output] option is set to [DTS Re-Encode], the DTS Re-Encode audio is outputted for BD-ROM discs with secondary audio and the original audio is outputted for the other discs (like [BitStream]).

Sampling Freq. (Digital Audio Output)

[48 kHz]

Select this if your A/V Receiver or Amplifier is not capable of handling 192 kHz and 96 kHz signal. When this choice is made, this unit automatically converts any 192 kHz and 96 kHz signals to 48 kHz so your system can decode them.

[96 kHz]

Select this if your A/V Receiver or Amplifier is not capable of handling 192 kHz signals. When this choice is made, this unit automatically converts any 192 kHz signals to 96 kHz so your system can decode them.

[192 kHz]

Select this if your A/V Receiver or Amplifier is capable of handling 192 kHz signals.

Check the documentation for your A/V Receiver or Amplifier to verify its capabilities.

DRC (Dynamic Range Control)

This function allows you to listen to a movie at a lower volume without losing clarity of sound.

[Off]

Turns off this function.

[On]

Compress the dynamic range of the Dolby Digital, Dolby Digital Plus or Dolby TrueHD audio output.

[Auto]

The dynamic range of the Dolby TrueHD audio output is specified by itself. And the dynamic range of the Dolby Digital and Dolby Digital Plus are operated as same as the [On] mode.

! Note

The DRC setting can be changed only when a disc is not inserted or the unit is in complete stop mode.

DTS Neo:6

If the player is connected to the multi-channel Audio Receiver by HDMI connection, set this option to enjoy the multi-channel surround sound with the 2-channel audio source.

[Off]

Outputs the stereo sound via front speakers.

[Music]

Outputs the multi-channel sounds that are optimized for listening to music.

[Cinema]

Outputs the multi-channel sounds that are optimized for watching movie.

! Note

- This function is not available on an on-line service.
- Only the audio source with less than 48 kHz sampling frequency is available for this function.
- This function is available only when [Digital Output] option is set to [PCM Multi-Ch].

[LOCK] menu

The [LOCK] settings affect only BD-ROM and DVD playback.

To access the any features in [LOCK] settings, you must enter the 4-digit security code you have created.

If you have not entered a password yet, you are prompted to do so. Enter a 4-digit password twice, and press **Wheel** (⦿) to create a new password.

Password

You can create or change the password.

[None]

Enter a 4-digit password twice, and press **Wheel** (⦿) to create a new password.

[Change]

Enter the current password and press **Wheel** (⦿). Enter a 4-digit password twice, and press **Wheel** (⦿) to create a new password.

If you forget your password

If you forget your password, you can clear it using the following steps:

1. Remove any disc that might be in the player.
2. Select [Password] option in the [Settings] menu.
3. Use colored buttons to enter "Red -> Green -> Yellow -> Green -> Yellow -> Blue".
The password is cleared.

DVD Rating

Blocks playback of rated DVD based on their content. (Not all discs are rated.)

[Rating 1-8]

Rating one (1) has the most restrictions and rating eight (8) is the least restrictive.

[Unlock]

If you select [Unlock], parental control is not active and the disc plays in full.

Blu-ray Disc Rating

Set an age limit of BD-ROM play. Use number buttons to input an age limit for BD-ROM viewing.

[255]

All BD-ROM can be played.

[0-254]

Prohibits play of BD-ROM with corresponding ratings recorded on them.

! Note

- The [Blu-ray Disc Rating] will be applied only for the Blu-ray disc that containing the Advanced Rating Control.
- For the region using MPAA rating level, refer to the table below as an example.

| Blu-ray Disc Rating | MPAA Rating |
|---------------------|----------------|
| 0 | G |
| 8 | PG |
| 13 | PG-13 |
| 17 | R |
| 18 | NC-17 |
| 255 | Not restricted |

Area Code

Enter the code of the area whose standards were used to rate the DVD video disc, based on the list on page 65.

[OTHERS] menu

Pointer

Sets the speed and size of the Magic remote control's magic pointer.

[Speed]

Sets the moving speed of the magic pointer.

[Size]

Chooses the size of the magic pointer.

Quick Start

This player can stay in standby mode with low power consumption, so that the player can instantly boot without delay when you turn on this unit. Set this option to [On] for activating [Quick Start] function.

! Note

- If [Quick Start] option is set to [On] and an AC power is accidentally re-connected to the player by power failure etc., the player automatically boots itself to be the standby status. Before operating the player, wait for a while until the player is in standby status.
- When [Quick Start] is set to [On], power consumption will be higher than when [Quick Start] is set to [Off].

Auto Power Off

The screen saver appears when you leave the player in Stop mode for about five minutes. If you set this option to [On], the unit automatically turns off within 20 minutes since the Screen Saver is displayed. Set this option to [Off] to leave the screen saver until the unit is operated by the user.

Initialize

[Factory Set]

You can reset the player to its original factory settings.

[Blu-ray Storage Clear]

Initializes the BD-Live contents from the connected USB storage.

! Note

If you reset the player to its original factory settings using [Factory Set] option, you have to set all the activation for the on-line services and network settings again.

Software

[Information]

Displays the current software version.

[Update]

You can update the software by connecting the unit directly to the software update server (see page 58).

Home Menu Display

Using [HOME] menu

The home menu appears when you press HOME (🏠). Use ▲/▼/◀/▶ to select a category and press Wheel (⦿).



! Note

Depending on the region, the [LG Smart World], [My Apps] service and [Search] function may not be available.

- 1 [Smart Share]** - Displays Smart Share menu.
- 2 [Premium]** - Displays the Premium home screen. (page 51)
- 3 [LG Smart World]** - Displays LG Apps titles provided to the unit. (page 51)
- 4 [My Apps]** - Displays the [My Apps] screen. (page 53)
- 5 [Settings]** - Adjusts the system settings.
- 6 [Q]** - Searches for desired LG Apps and other content.
- 7 [👤]** - Displays login menu.

Using the Smart Share

You can play video, photo and audio content on the unit by inserting a disc, connecting an USB device or using home network (DLNA).

1. Press HOME (🏠) to display the home menu.
2. Select [Smart Share] and press Wheel (⦿).

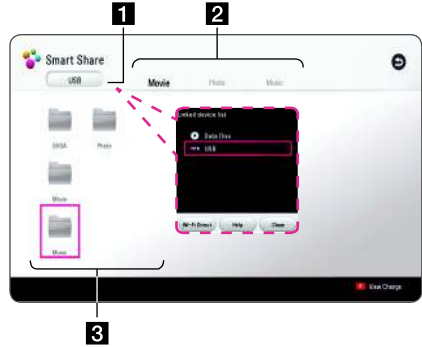

- 1** Displays all linked devices.
- 2** Displays video, photo or audio content.
- 3** Displays the file or folder on linked device.

Playing the Linked Devices

Playing a disc

BD DVD AVCHD ACD

1. Insert a disc in the disc slot.
For the most Audio CD, BD-ROM and DVD-ROM discs, playback starts automatically.
2. Press HOME (🏠) and then select [Smart Share].
3. Select disc icon.

Note

- Playback functions described in this manual are not always available in every file and media. Some functions can be restricted depending on many factors.
- Depending on the BD-ROM titles, a USB device connection may be needed for the proper playback.
- Unfinalized DVD-VR format discs may not be played on this player.
- Some DVD-VR discs are made with CPRM data by DVD RECORDER. This unit cannot support these kinds of discs.

Playing Blu-ray 3D disc

BD

This player can play Blu-ray 3D discs which contain separate views for the left and the right eyes.

Preparation

In order to play Blu-ray 3D title in stereoscopic 3D mode, you need to:

- Check your TV is 3D capable and has HDMI input(s).
- Wear 3D glasses to enjoy the 3D experience if it is necessary.
- Check whether the BD-ROM title is the Blu-ray 3D disc or not.
- Connect an HDMI cable (Type A, High Speed HDMI™ Cable) between the player's HDMI output and TV's HDMI input.

1. Press HOME (🏠), and set the [3D Mode] option on the [Settings] menu to [On] (page 26).
2. Insert a disc in the disc slot.
The playback starts automatically.
3. Refer to the owner's manual of your 3D-ready TV for the further instruction.

You may need to adjust the display settings and focus on your TV's setting for the improved 3D effect.

Caution

- Watching 3D content for a long period of time may cause dizziness or tiredness.
- It is not recommended for children, pregnant women and the infirm to watch movies in 3D mode.
- If you are experiencing headache, tiredness or dizziness while viewing contents in 3D, it is strongly recommended to stop the playback and rest until you feel normal.

Playing a file on disc/USB device

MOVIE MUSIC PHOTO

This player can play video, audio and photo files contained in the disc or USB device.

1. Insert a data disc in the disc slot or connect an USB device.

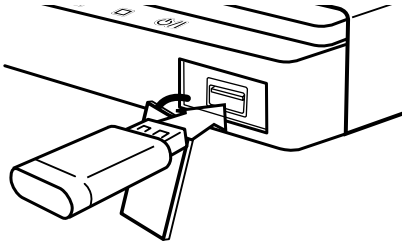

When you connect the USB device on the HOME menu, the player plays an audio file contained in the USB storage device automatically. If the USB storage device is containing various types of files, a menu for the file type selection will appear.

File loading may takes few minutes depending on the number of content stored in the USB storage device. Press **Wheel** (⦿) while [Cancel] is selected to stop loading.

2. Press HOME (⏠).
3. Select [Smart Share] and press **Wheel** (⦿).



4. Select the desired linked device in the category.
5. Select [Movie], [Photo] or [Music].
6. Select a file using **▲/▼/◀/▶**, and press **▶||** (Play/Pause) or **Wheel** (⦿) to play the file.

Notes on USB device

- This player supports USB flash drive/external HDD formatted in FAT32 and NTFS when accessing files (music, photo, movie). However, for BD-Live, use the USB flash drive / external HDD formatted in FAT32.
- This unit can support up to 4 partitions of the USB device.
- Do not extract the USB device during operation (play, etc.).
- An USB device which requires additional program installation when you have connected it to a computer, is not supported.
- USB device: USB device that supports USB1.1 and USB2.0.
- Video, audio and photo files can be played. For details of operations on each file, refer to relevant pages.
- Regular back up is recommended to prevent data loss.
- If you use an USB extension cable, USB HUB or USB Multi-reader, the USB device may not be recognized.
- Some USB device may not work with this unit.
- Digital camera and mobile phone are not supported.
- USB Port of the unit cannot be connected to PC. The unit cannot be used as a storage device.

Playing a file on a network server

MOVIE MUSIC PHOTO

This player can play video, audio and photo files located in a DLNA server through your home network.

1. Check the network connection and settings (page 17).
2. Press HOME (🏠).
3. Select [Smart Share] and press **Wheel** (⦿).

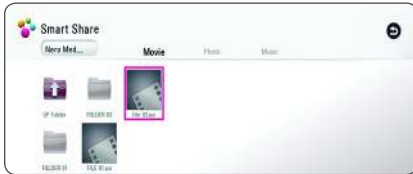

4. Select a DLNA media server in the category.
5. Select [Movie], [Photo] or [Music].
6. Select a file using ▲/▼/◀/▶, and press ►|| (Play/Pause) or **Wheel** (⦿) to play the file.

! Note

- The file requirements are described on page 60.
- The thumbnail of the unplayable files can be displayed, but those cannot be played on this player.
- The subtitle file name and video file name have to be the same and located at the same folder.
- The playback and operating quality may be affected by your home network condition.
- You may experience connection problems depending on your server's environment.
- To set your PC as a DLNA server, install the supplied Nero MediaHome 4 on your PC. (page 35)

Using Home Network Server for PC

DLNA stands for Digital Living Network Alliance, which allows users to access video, photo and audio files stored in server and enjoy them on TV via home networking.

Before connecting to PC to play a file, Nero MediaHome 4 Essentials program should be installed on your PC.

Installing Nero MediaHome 4 Essentials

Windows

Start up your computer, and insert the supplied CD-ROM disc into your computer's CD-ROM drive. An installation wizard will walk you through the quick and uncomplicated installation process. To install Nero MediaHome 4 Essentials, proceed as follows:

1. Close all Microsoft Windows programs and exit any anti-virus software that may be running.
2. Insert the supplied CD-ROM disc into your computer's CD-ROM drive.
3. Click [Nero MediaHome 4 Essentials].
4. Click [Run] to start installation.
5. Click [Nero MediaHome 4 Essentials]. The installation is prepared and the installation wizard appears.
6. Click the [Next] button to display the serial number input screen. Click [Next] to go to the next step.
7. If you accept all conditions, click [I accept the License Conditions] check box and click [Next]. Installation is not possible without this agreement.
8. Click [Typical] and click [Next]. The installation process is started.
9. If you want to take part in the anonymous collection of data, select the check box and click the [Next] button.
10. Click the [Exit] button to complete the installation.

MAC OS X

1. Start up your computer, and insert the supplied CD-ROM disc into your computer's CD-ROM drive.
2. Browse the CD-ROM drive and open the "MediaHome_4_Essentials_MAC" folder.
3. Double-click the "Nero MediaHome.dmg" image file. The Nero MediaHome window is opened.
4. In the Nero MediaHome window, drag the Nero MediaHome icon either to the Applications folder within the window or to any other desired location.
5. You can now start the application by double-clicking the Nero MediaHome icon in the location you dragged it to.

Sharing files and folders

On your computer, you must share the folder contained video, audio and/or photo content to play them on this player.

This part explains the procedure for selecting the shared folders on your computer.

1. Double-click the "Nero MediaHome 4 Essentials" icon.
2. Click [Network] icon on the left and define your network name in the [Network name] field. The Network name you enter will be recognized by your player.
3. Click [Shares] icon on the left.
4. Click [Local Folders] tab on the [Shares] screen.
5. Click [Add] icon to open the [Browse Folder] window.
6. Select the folder containing the files you want to share. The selected folder is added to the list of shared folders.
7. Click [Start Server] icon to start the server.

Note

- If the shared folders or files are not displayed on the player, click the folder on the [Local Folders] tab and click [Rescan Folder] at the [More] button.
- Visit www.nero.com for more information and software tools.

About Nero MediaHome 4 Essentials

Nero MediaHome 4 Essentials is a software for sharing video, audio and photo files stored on your computer to this unit as a DLNA-compatible digital media server.

! Note

- The Nero MediaHome 4 Essentials CD-ROM is designed for PCs and should not be inserted in this player or in any product other than a PC.
- The supplied Nero MediaHome 4 Essentials CD-ROM is a customized software edition only for sharing files and folders to this player.
- The supplied Nero MediaHome 4 Essentials software does not support following functions: Transcoding, Remote UI, TV control, Internet services and Apple iTunes.
- The supplied Nero MediaHome 4 Essentials software can be downloaded at
 - Windows : <http://www.nero.com/download.php?id=nmhlgewin>
 - Mac OS : <http://www.nero.com/download.php?id=nmhlgemac>
- This manual explains operations with the English version of Nero MediaHome 4 Essentials as examples. Follow the explanation referring to the actual operations of your language version.

System requirements

Windows PC

- Windows® XP (Service Pack 2 or higher), Windows Vista® (no Service Pack required), Windows® 7 (no Service Pack required), Windows® XP Media Center Edition 2005 (Service Pack 2 or higher), Windows Server® 2003
- Windows Vista® 64-bit edition (application runs in 32-bit mode)
- Windows® 7 64-bit edition (application runs in 32-bit mode)
- Hard drive space: 200 MB hard drive space for a typical installation of Nero MediaHome stand-alone
- 1.2 GHz Intel® Pentium® III or AMD Sempron™ 2200+ processors
- Memory: 256 MB RAM
- Graphics card with at least 32 MB video memory, minimum resolution of 800 x 600 pixels, and 16-bit color settings
- Windows® Internet Explorer® 6.0 or higher
- DirectX® 9.0c revision 30 (August 2006) or higher
- Network environment: 100 Mb Ethernet, WLAN

Macintosh

- Mac OS X 10.5 (Leopard) or 10.6 (Snow Leopard)
- Macintosh computer with an Intel x86 processor
- Hard drive space: 200 MB hard drive space for a typical installation of Nero MediaHome stand-alone
- Memory: 256 MB RAM

General Playback

Basic operations for video and audio content

To stop playback

Press ■ (STOP) during playback.

To pause playback

Press ►|| (Play/Pause) during playback.

Press ►|| (Play/Pause) to resume playback.

To scan forward or backward

Press and hold ◀◀ or ▶▶ to play fast forward or fast reverse during playback.

You can change the various playback speeds by pressing ◀◀ or ▶▶ repeatedly.

To slow down the playing speed

While the playback is paused, press ▶▶ repeatedly to play various speeds of slow motion.

To skip to the next/previous chapter/track/file

During playback, press ◀◀ or ▶▶ to go to the next chapter/track/file or to return to the beginning of the current chapter/track/file.

Press ◀◀ twice briefly to step back to the previous chapter/track/file.

In the file list menu of a server, there may have many types of content in a folder together. In this case, press ◀◀ or ▶▶ to go to the previous or next content with same type.

Basic operations for photo content

To play a slide show

Press ►|| (Play/Pause) to start slide show.

To stop a slide show

Press ■ (STOP) while slide show.

To pause a slide show

Press ►|| (Play/Pause) while slide show.

Press ►|| (Play/Pause) to re-start the slide show.

To skip to the next/previous photo

While viewing a photo in full screen, press ◀ or ▶ to go to the previous or next photo.

Resume playback

BD DVD AVCHD MOVIE ACD
MUSIC

The unit records the point where you pressed the **■** (STOP) depending on the disc.

If “**■**” (Resume Stop) appears on the screen briefly, press **▶||** (Play/Pause) to resume playback (from the scene point).

If you press **■** (STOP) twice or unload the disc, “**■**” (Complete Stop) appears on the screen. The unit will clear the stopped point.

! Note

- The resume point may be cleared when a button is pressed (for example; **⏻** (POWER), **△** (OPEN/CLOSE), etc).
- On BD-ROM discs with BD-J, the resume playback function does not work.
- If you press **■** (STOP) once during BD-ROM interactive title playback, the unit will be in Complete Stop mode.

Last scene memory

BD DVD

This unit memorizes the last scene from the last disc that is viewed. The last scene remains in memory even if you remove the disc from the unit or switch off the unit. If you load a disc that has the scene memorized, the scene is automatically recalled.

! Note

- Last Scene Memory function for a previous disc is erased once a different disc is played.
- This function may not work depending on the disc.
- On BD-ROM discs with BD-J, the last scene memory function does not work.
- This unit does not memorize settings of a disc if you switch off the unit before commencing to play it.

On-Screen Display

You can display and adjust various information and settings about the content.

To control video playback

BD DVD AVCHD MOVIE

You can control playback and set options while watching videos.

During playback, press INFO/MENU (□).

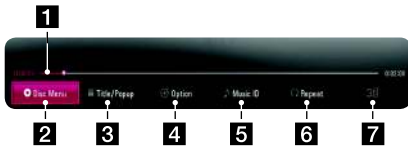

- 1** **Progress bar** - Displays the current position and total playing time.
- 2** **[Disc Menu]** - Accesses menu on a disc.
- 3** **[Title/Popup]** - Displays the DVD title menu or BD-ROM's pop-up menu, if available.
- 4** **[Option]** - Displays playback information.
- 5** **[Music ID]** - When connected to the network, can provide information about the current song during video playback.
- 6** **[Repeat]** - Repeats a desired section or sequence. (page 41)
- 7** **[3D]** - Adjusts the 3D setting. (page 45)

Displaying content information on-screen

BD DVD AVCHD MOVIE

1. During playback, press INFO/MENU (□).
2. Select an [Option] using ◀/▶, and press Wheel (⦿).

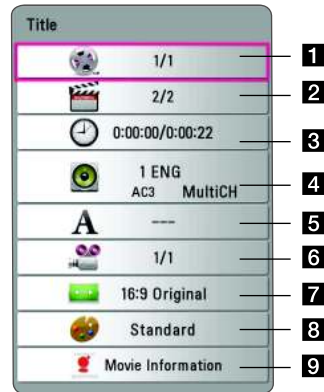

- 1** **Title** - Current title number/total number of titles
- 2** **Chapter** - Current chapter number/total number of chapters
- 3** **Time** - Elapsed playing time/total playback time
- 4** **Audio** - Selected audio language or channel
- 5** **Subtitle** - Selected subtitle.
- 6** **Angle** - Selected angle/total number of angles
- 7** **TV Aspect Ratio** - Selected TV aspect ratio
- 8** **Picture Mode** - Selected picture mode
- 9** **Movie Information** - Select this option and press Wheel (⦿) to display movie information from Gracenote Media Database (BD-ROM/ DVD only).

! Note

- If no button is pressed for a few seconds, the on-screen display disappears.
- A title number cannot be selected on some discs.
- Available items may differ depending on discs or titles.
- If an interactive Blu-ray Disc is playing back, some setting information is displayed on the screen but prohibited to be changed.
- To use the [Movie Information] option, the player must be connected to the broadband internet for accessing the Gracenote Media Database.
- LG is a licensee of Gracenote technology and is not responsible or liable for information from the Gracenote Media Database.

Setting the slide show option

You can use various options during viewing a photo in full screen.

1. While viewing pictures, press INFO/MENU (□).
2. Select an [Option] using ◀/▶, and press Wheel (⦿).

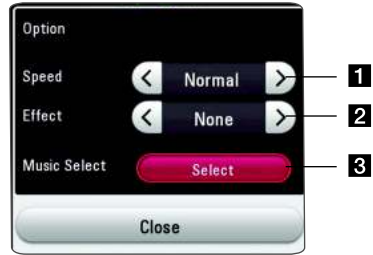

1 [Speed] - Use ◀/▶ to select a delaying speed between photos in a slide show.

2 [Effect] - Use ◀/▶ to select a transition effect between photos in a slide show.

3 [Music Select] - Select the background music for the slide show (page 45).

To control photo view

Controls playback and sets options while viewing pictures in full screen.

You can control playback and set options while viewing pictures in full screen.

While viewing pictures, press INFO/MENU (□).



1 [Slideshow] - Starts or pause slide show.

2 [Music] - Select the background music for the slide show.

3 [Option] - Displays slide show options.

4 [Rotate] - Rotates the photo clockwise.

5 [Zoom] - Displays the [Zoom] menu.

Advanced Playback

Repeat playback

**BD DVD AVCHD ACD MUSIC
MOVIE**

Blu-ray Disc / DVD / Video files

1. During playback, press INFO/MENU (□).
2. Select an [Repeat] using ◀/▶, and press **Wheel** (⦿).

A-B – Selected portion will be repeated continually.

Chapter – The current chapter will be played back repeatedly.

Title – The current title will be played back repeatedly.

All – All the titles or files will be played back repeatedly.

Off – Returns to normal playback.

Audio CDs/Audio files

During playback, select [Repeat] and press **Wheel** (⦿) repeatedly to select a desired repeat mode.

A-B – Selected portion will be repeated continually. (Audio CD only)

1 Track – The current track or file will be played back repeatedly.

A All – All the tracks or files will be played back repeatedly.

A R All – All the tracks or files will be played back repeatedly in random order.

R – The tracks or files will be played back in random order.

! Note

This function may not work on some disc or title.

Repeating a specific portion

BD DVD AVCHD ACD MOVIE

This player can repeat a portion you have selected.

1. During playback, press INFO/MENU (□).
2. Select an [Repeat] using ◀/▶, and press **Wheel** (⦿).
3. Select [A-B] and press **Wheel** (⦿).
4. Press **Wheel** (⦿) at the beginning of the portion you wish to repeat.
5. Press **Wheel** (⦿) at the end of the portion. Your selected portion will be repeated continually.

! Note

- You cannot select a portion less than 3 seconds.
- This function may not work on some disc or title.

Playing from selected time

BD DVD AVCHD MOVIE

1. During playback, press INFO/MENU (□).
2. Select an [Option] using ◀/▶, and press **Wheel** (⦿).
3. Select the [Time] option and then input the required start time in hours, minutes, and seconds from left to right.

For example, to find a scene at 2 hours, 10 minutes, and 20 seconds, enter “21020”.

Press ◀/▶ to skip the playback 60 seconds forward or backward.

4. Press **Wheel** (⦿) to start playback from selected time.

! Note

- This function may not work on some disc or titles.
- This function may not work depending on the file type and ability of the DLNA server.

Selecting a subtitle language

BD DVD AVCHD MOVIE

1. During playback, press INFO/MENU (□).
2. Select an [Option] using ◀/▶, and press **Wheel** (⦿).
3. Use ▲/▼ to select the [Subtitle] option.
4. Press ◀/▶ to select desired subtitle language.
By pressing **Wheel** (⦿), you can set various subtitle options.
5. Press BACK (⏪) to exit the On-Screen display.

! Note

Some discs allow you to change subtitle selections only via the disc menu. If this is the case, choose the appropriate subtitle from the selections on the disc menu.

Hearing a different audio

BD DVD AVCHD MOVIE

1. During playback, press INFO/MENU (□).
2. Select an [Option] using ◀/▶, and press **Wheel** (⦿).
3. Use ▲/▼ to select the [Audio] option.
4. Use ◀/▶ to select desired audio language, audio track or audio channel.

! Note

- Some discs allow you to change audio selections only via the disc menu. In this case, choose the appropriate audio from the selections on the disc menu.
- Immediately after you have switched sound, there may be a temporary discrepancy between the display and actual sound.
- On BD-ROM disc, the multi audio format (5.1CH or 7.1CH) is displayed with [MultiCH] in the on-screen display.

Watching from a different angle

BD DVD

If the disc contains scenes recorded at different camera angles, you can change to a different camera angle during playback.

1. During playback, press INFO/MENU (□).
2. Select an [Option] using ◀/▶, and press **Wheel** (⦿).
3. Use ▲/▼ to select the [Angle] option.
4. Use ◀/▶ to select desired angle.
5. Press BACK (⏪) to exit the On-Screen display.

Changing the TV Aspect Ratio

BD AVCHD MOVIE

You can change the TV aspect ratio setting during playback.

1. During playback, press INFO/MENU (□).
2. Select an [Option] using ◀/▶, and press **Wheel** (⦿).
3. Use ▲/▼ to select the [TV Aspect Ratio] option.
4. Use ◀/▶ to select desired option.
5. Press BACK (⏪) to exit the On-Screen display.

! Note

Even if you change the value of the [TV Aspect Ratio] option in On-Screen display, the [TV Aspect Ratio] option in the [Settings] menu is not changed.

Changing subtitle Code Page

MOVIE

If the subtitle is displayed in broken letter, you can change the subtitle code page to view the subtitle file properly.

1. During playback, press INFO/MENU (□).
2. Select an [Option] using ◀/▶, and press Wheel (⦿).
3. Use ▲/▼ to select the [Code Page] option.
4. Use ◀/▶ to select desired code option.

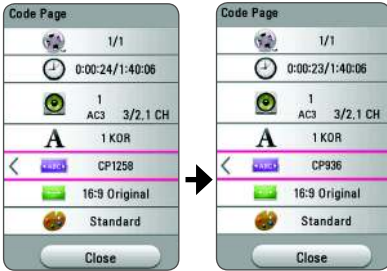

5. Press BACK (⏪) to exit the On-Screen display.

Changing the Picture Mode

BD DVD AVCHD MOVIE

You can change the [Picture mode] option during playback.

1. During playback, press INFO/MENU (□).
2. Select an [Option] using ◀/▶, and press Wheel (⦿).
3. Use ▲/▼ to select the [Picture Mode] option.
4. Use ◀/▶ to select desired option.
5. Press BACK (⏪) to exit the On-Screen display.

Setting the [User setting] option

1. During playback, press INFO/MENU (□).
2. Select an [Option] using ◀/▶, and press Wheel (⦿).
3. Use ▲/▼ to select the [Picture Mode] option.
4. Use ◀/▶ to select the [User setting] option, and press Wheel (⦿).

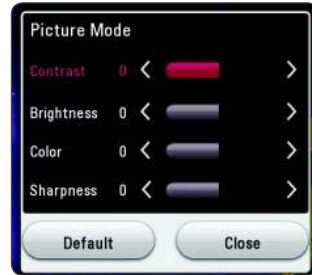

5. Use ▲/▼/◀/▶ to adjust the [Picture Mode] options.

Select [Default] option then press Wheel (⦿) to reset the all video adjustments.

6. Use ▲/▼/◀/▶ to select the [Close] option, and press Wheel (⦿) to finish setting.

Viewing content information

MOVIE

The player can display the content information.

1. Select a file using ▲/▼/◀/▶.
2. Press INFO/MENU (□) to display the option menu.

The file information appears on the screen.

! Note

The information displayed on the screen may not correct comparing actual content information.

Changing content list view

MOVIE MUSIC PHOTO

On the [Smart Share] menu, you can change the content list view.

Press red (R) colored button repeatedly.



Selecting a subtitle file

MOVIE

If the subtitle file name is different from the video file name, you need to select the subtitle file on the [Movie] menu before playing the movie.

1. Use ▲/▼/◀/▶ to select the subtitle file you wish to play in the [Movie] menu.
2. Press **Wheel** (⦿).



Press **Wheel** (⦿) again to deselect the subtitle file. Selected subtitle file will be displayed when you play the video file.

! Note

- If you press ■ (STOP) during playback, the subtitle selection is cancelled.
- This function is not available for playing file on a server via home network.

Listening to music during slide show

PHOTO

You can display photo files while listening to audio files.

1. While viewing a photo in full screen, press INFO/MENU (□) to display the option menu.
2. Select an [Option] using ◀/▶, and press **Wheel** (⦿).
3. Use ▲/▼ to select [Music Select] option, and press **Wheel** (⦿) to display the [Music Select] menu.
4. Use ▲/▼ to select a device, and press **Wheel** (⦿).

Available device may differ depending on the location of the current photo file.

| Photo location | Available Device |
|----------------|------------------|
| Disc, USB | Disc, USB |
| DLNA server | DLNA server |

5. Use ▲/▼ to select a file or a folder you wish to play.



Select □ and press **Wheel** (⦿) to display the upper directory.

! Note

When selecting audio file from a server, folder selection is not available. Only file selection is available.

6. Use ▶ to select [OK], and press **Wheel** (⦿) to complete music selection.

Converting 2D content to 3D

BD DVD AVCHD MOVIE

This function allows you to convert 2D content to 3D. You can adjust 3D's depth and distance on the [3D] option while playing back.

1. During playback, press INFO/MENU (□).
2. Select an [3D], and press **Wheel** (⦿).
3. Use ▲/▼/◀/▶ to select desired options.
Select [Default] option then press **Wheel** (⦿) to reset the all adjustments.
4. Use ▲/▼/◀/▶ to select the [Close] option, and press **Wheel** (⦿) to finish setting.

! Note

- When you have set to Ultra HD resolution, if you select the [On] in [3D], the Ultra HD resolution is automatically changed to the original resolution.
- Movie files which is upper 30 fps (frame rate) may not be converted to 3D.

Advanced Features

Wi-Fi Direct™

Connecting to a Wi-Fi Direct™ certified device

MOVIE MUSIC PHOTO

This player can play movie, music and photo files located in a Wi-Fi Direct™ certified device. The Wi-Fi Direct™ technology make the player to be directly connected to a Wi-Fi Direct™ certified device without connecting to a network device such as an access point.

On Wi-Fi Direct™ certified device

1. Turn on the Wi-Fi Direct™ certified device and run its Wi-Fi Direct function.
2. Run DLNA application on the device.

On your player

3. Select [NETWORK] option in the [Settings] menu then press **Wheel** (⊙).
4. Select [Wi-Fi Direct] option, and press **Wheel** (⊙).



5. Select a Wi-Fi Direct™ device on the list using ▲/▼, and press **Wheel** (⊙).



Wi-Fi Direct™ connection will be proceeded, follow the procedure on the screen.

If you want to rescan available Wi-Fi Direct™ device, Select the [Refresh List] and press **Wheel** (⊙).

To select a server from the device list, files or folders must be shared by DLNA server from the connected Wi-Fi Direct™ device.

6. Select [Movie], [Photo] or [Music] using ▲/▼/◀/▶, and press **Wheel** (⊙).



7. Select a file using ▲/▼/◀/▶, and press **Wheel** (⊙) to play the file.

! Note

- For the purpose of the better transmission, placing the player from the Wi-Fi Direct™ certified server as close as possible.
- This unit can connect only 1 device at a time. Multiple connection is not available.
- If you try to connect wireless network while a device is connected by Wi-Fi Direct™ function, Wi-Fi Direct™ connection will be force disconnected.
- If this player and a Wi-Fi Direct™ device are connected to the different local area network, Wi-Fi Direct™ connection may not available.
- If a Wi-Fi Direct™ certified device is not in Wi-Fi direct standby mode, this product can not find the device.
- When you connect a Wi-Fi Direct™ certified device to your player, PIN network connection is not supported.
- This product cannot connect to a Wi-Fi direct™ device which is in Group Owner mode.

Enjoying Miracast™

You can mirror Miracast certified device's screen and sound onto TV screen through your player wirelessly.

On Miracast™ certified device

1. Turn on the Miracast certified device and run its [Miracast] function.

On your player

2. Press HOME (⏠).
3. Select [Miracast] and press **Wheel** (⦿).



4. Select a Miracast device on the list using ▲/▼, and press **Wheel** (⦿).

Miracast function will be proceeded automatically.

If you want to rescan available Miracast device, select [Refresh List] and press **Wheel** (⦿).

Note

- For the purpose of the better mirroring, place Miracast certified device from the player as close as possible.
- This unit can connect only 1 device at a time. Multiple connection is not available.
- While mirroring, Wireless network or Wi-Fi Direct cannot be used simultaneously.
- If a Miracast certified device is not in [Miracast] standby mode, this player cannot find the device.
- Depending on your wireless network condition, mirroring may be unstable.
- While mirroring, the screen may be cut off depending on your TV's setting. In this case, please adjust the display settings on your TV.

Enjoying BD-Live™

BD

BD-ROM supporting BD-Live that has a network extension function allows you to enjoy more functions such as downloading new movie trailers by connecting this unit to the internet.

1. Check the network connection and settings (page 17).
2. Insert an USB storage device to the USB port on the front panel.

An USB storage device is needed to download bonus content.

3. Press HOME (⏠), and set the [BD-LIVE connection] option on the [Settings] menu (page 23).

Depending on a disc, the BD-Live function may not be operated if [BD-LIVE connection] option is set to [Partially Permitted].

4. Insert a BD-ROM with BD-Live.

The operations may differ depending on the disc. Refer to the manual supplied with the disc.

**Caution**

Do not extract the connected USB device while content is being downloaded or a Blu-ray disc is still in the disc slot. Doing so may damage the connected USB device and BD-Live features may not operate properly with the damaged USB device anymore. If the connected USB device seems damaged from such an action, you can format the connected USB device from the PC and reuse it with this player.

**Note**

- Some BD-Live content may be restrictively accessed in some territories by content provider's own decision.
- It may take up to several minutes to load and start enjoying BD-Live content.
- For BD-Live, use the USB flash drive / external HDD formatted in FAT32 only.

LG Tag On

LG Tag On allows you to install and open "LG AV Remote" app to NFC-enabled phone.

1. Stick the supplied LG Tag On sticker on this player.

**Note**

We suggest you first think carefully about the sticker position, because it is difficult to remove after sticking it once.

2. Tag the back of your NFC-enabled phone over the LG Tag On sticker.
 - If "LG AV Remote" app is not installed on your NFC-enabled phone, the linked screen with "LG AV Remote" app is displayed.
 - If "LG AV Remote" app is installed on your NFC-enabled phone, "LG AV Remote" app is activated.

**Note**

- You must activate the NFC feature of your NFC-enabled phone for Android 4.0 or later.
- If your NFC-enabled phone's screen is locked, it will not read the LG Tag On sticker.
- If your smart phone case is plated with chrome, NFC is unavailable. Depending on your case's material or thickness, NFC may not be read well.

LG AV Remote

You can control this player with your iPhone or Android phone via your home network. This player and your phone must be connected to your wireless network device such as access point. Visit "Apple iTunes" or "Google Android Market (Google Play Store)" for detailed information of "LG AV Remote".

Private Sound Mode

By downloading "LG AV Remote" application on your smart phone or tablet, you can connect your headsets, and enjoy the sound from your player on your smart devices.

This feature transmits video signal to TV through HDMI and Audio signal to smart phone or tablet through Wi-Fi. For more detailed information, please refer to the Help menu on "LG AV Remote" application.

Viewing information from Gracenote Media Database

The player can access the Gracenote Media Database and load the music information so that Track name, Artist Name, Genre and other text information can be displayed on the list.

Audio CD

When you insert an Audio CD, the player starts playback automatically and loads the music title from the Gracenote Media Database.

If there is no music information from the database, music titles will not appear on the screen.

Music file

Select a music file using ▲/▼/◀/▶ and press INFO/MENU (□).

The player accesses to Gracenote Media Database for the music information.

Blu-ray Disc/DVD/Movie file

1. While listening to a music from the movie being played, press INFO/MENU (□).
2. Select a [Music ID] using ◀/▶, and press Wheel (⦿).

The player starts loading the music information from the Gracenote Media Database.

! Note

- The player must be connected to the broadband internet for accessing the Gracenote Media Database.
- If the music information is not in the Gracenote Media Database, message appears on the screen.
- Depending on the cases, it will takes a few minutes to load music information from the Gracenote Media Database.
- Information may be displayed in broken letters, if the language you selected is not available on the Gracenote Media Database.
- This function is not available for on-line content and content in DLNA servers.
- LG is a licensee of Gracenote technology and is not responsible or liable for information from the Gracenote Media Database.
- Audio CDs that users made for their only private purposes cannot be supported in this feature because they are not in the Gracenote Media Database.
- Supported music file extensions : mp3, wma, m4a, wav

Audio CD recording

You can record one desired track or all of the tracks in Audio CD to a USB storage device.

1. Insert a USB storage device to the USB port on the front panel.
2. Insert an Audio CD into the player.
The playback starts automatically.
3. Press red (R) colored button to start [CD Recording].

| | Stop mode | During playback |
|-----------------|-------------------|-----------------|
| Recording track | All of the tracks | playing track |
| Recording time | 4X speed | normal speed. |

Caution

The recording or copying features on this player are provided for your personal and non-commercial use. The making of unauthorized copies of copy-protected material, including computer programs, files, broadcasts and sound recordings, may be an infringement of copyrights and constitute a criminal offense. This equipment should not be used for such purposes. LG expressly disclaims any responsibility for illegal distribution or use of unauthorized content in commercial purpose.

**Be Responsible
Respect Copyrights**

Note

- For audio CD recording, use the USB flash drive / external HDD formatted in FAT32 only.
- Audio track is recorded to an audio file with 192 kbps.
- Recording times in the table above are approximate.
- Actual recording time for USB storage device varies depending on the USB storage device's ability.
- Make sure that there is minimum of 50 MB free space is needed when recording into the USB storage device.
- The length of the audio should be longer than 20 seconds for the proper recording.
- Do not turn off this player or extract the connected USB storage device during Audio CD recording.

Using the Premium

You can use various content services via Internet with the Premium feature.

1. Check the network connection and settings (page 17).
2. Press HOME (🏠).
3. Select the [Premium] using ◀/▶, and press **Wheel** (⦿).



4. Select an online service using ▲/▼/◀/▶, and press **Wheel** (⦿).

! Note

- For detailed information of each service, contact to the content provider or visit support link of the service.
- The content of Premium services and service related information, including user interface, is subject to changes. Please refer to the web site of each service for most up-to-date information.
- Using Premium features with wireless network connection may result in improper streaming speed by interference from household devices that are using radio frequencies.
- If you want to change the country setting, go to [Settings] > [NETWORK] > [Smart Service Setting] > [Country Setting]. Select [Manual] and press **Wheel** (⦿) on [Country Setting] menu.

Using the LG Smart World

You can use the LG application services on this player via Internet. You can easily find and download various applications from LG Smart World.

1. Check the network connection and settings (page 17).
2. Press HOME (🏠).
3. Select the [LG Smart World], and press **Wheel** (⦿).



4. Select a category using ◀/▶, and press **Wheel** (⦿).
5. Use ▲/▼/◀/▶ to select an application, and press **Wheel** (⦿) to display the information.
6. Press **Wheel** (⦿) while [Install] icon is highlighted. The application will be installed to the player.

To install an application to the player, user needs to sign in. Refer to page 52 for more information of signing in.



7. Press red (R) colored button to display the [My Apps] screen.
8. Select the installed application and press **Wheel** (⦿) to execute it.

! Note





- Depending on the region, the [LG Smart World], [My Apps] service and [Search] function may not be available.
- To install a paid application, you need to be a paid member. Visit www.lgappstv.com for more information.

Signing in



To use the [LG Smart World] feature, you need to sign in with your account.

1. On the home menu, select [] icon and press **Wheel** ().
2. Fill the [ID] and [Password] field using the virtual keyboard.

If you do not have an account, press red (R) colored button to register.





















3. Use  /  /  /  to select [OK], and press **Wheel** () to sign in with your account.
If you select the [Auto Sign In] check box, your ID and password are remembered and automatically signed in without entering them.

Note

To view the information of your account and applications, select [] icon and press **Wheel** () on the home menu, and select [My Page] option.

Searching online content

If you are having difficulties finding specific content from online services, you can use the all-in-one search function by entering keywords in the [] menu.

1. Press HOME ().
2. Select the [] icon on the home menu using  /  /  /  , and press **Wheel** ().
The [] menu appears on the screen.
3. Press **Wheel** (). The virtual keyboard appears automatically.
4. Use  /  /  /  to select letters then press **Wheel** () to confirm your selection on the virtual keyboard.
5. When you finish entering the keyword, select [] and press **Wheel** () to display search result.
6. Use  /  /  /  to select a desired content, and press **Wheel** () to move to the selected content directly.

Note

- Depending on the region, the [LG Smart World], [My Apps] service and [Search] function may not be available.
- The search function does not search content in every online services. It works only in certain online services.

Using the My Apps Menu

You can move or delete an installed application in the [My Apps] menu.

1. Press HOME (🏠).
2. Select the [My Apps], and press **Wheel** (⦿).



3. On the [My Apps] menu, press red (R) colored button.

Move an application

1. Select an application, and press **Wheel** (⦿) to display the options.
2. Use ▲/▼ to select [Move], and press **Wheel** (⦿).
3. Use ▲/▼/◀/▶ to select a position you want to move to, and press **Wheel** (⦿).

Delete an application

1. Select an application, and press **Wheel** (⦿) to display the options.
2. Use ▲/▼ to select [Delete], and press **Wheel** (⦿).
3. Use ◀/▶ to select [OK], and press **Wheel** (⦿) to confirm.

! Note

Depending on the region, the [LG Smart World], [My Apps] service and [Search] function may not be available.

Troubleshooting

General

| Symptom | Cause & Solution |
|--|---|
| The Power does not turned on. | <ul style="list-style-type: none"> • Plug the power cord into the wall outlet securely. |
| The unit does not start playback. | <ul style="list-style-type: none"> • Insert a playable disc. (Check the disc type, colour system, and regional code.) • Insert the disc with the playback side down. • Clean the disc. • Cancel the Rating function or change the rating level. |
| The connected USB storage device is not recognized. | <ul style="list-style-type: none"> • Try using different USB cable, some USB cables may not support enough current for normal USB operation. • If you use an USB extension cable or USB HUB, the USB devices may not be recognized. • An USB device which requires additional program installation when you have connected it to a computer is not supported. • This unit supports only USB Flash Drive and USB External HDD with FAT32 or NTFS format. |
| The angle cannot be changed. | <ul style="list-style-type: none"> • Multi-angles are not recorded on the DVD Video being played. |
| Cannot play movie, photo or music files. | <ul style="list-style-type: none"> • The files are not recorded in a format that the unit can play. • The unit does not support the codec of the movie file. |
| The remote control does not work properly. | <ul style="list-style-type: none"> • The remote control is not pointed at the remote sensor of the unit. • The remote control is too far from the unit. • There is an obstacle in the path of the remote control and the unit. • The batteries in the remote control are exhausted. |
| The unit is plugged in, but the power will not turn on or off. | <p>You can reset the unit as follows.</p> <ul style="list-style-type: none"> • Unplug the power cord, wait at least five seconds, and then plug it in again. |
| The unit is not operating normally. | |

Network

| Symptom | Cause & Solution |
|--|--|
| BD-Live feature does not work. | <ul style="list-style-type: none"> • The connected USB storage may not have enough space. Connect the USB storage with at least 1GB free space. • Ensure that the unit is correctly connected to the local area network and can access the internet (see page 17). • Your broadband speed may not fast enough to use the BD-Live features. Contact your Internet Service Provider (ISP) and increase the broadband speed is recommended. • The [BD-LIVE connection] option in the [Settings] menu is set to [Prohibited]. Set the option to [Permitted]. |
| Streaming video services (such as YouTube™, etc.) are often stopped or “buffer” during playback. | <ul style="list-style-type: none"> • Your broadband service speed may not be fast enough to stream video services. Contact your Internet Service Provider (ISP) and increase the broadband speed is recommended. |
| Media servers are not displayed on the device list. | <ul style="list-style-type: none"> • The firewall or anti-virus software on your media server is running. Turn off the firewall or anti-virus software running on your media server. • The player is not connected to the local area network that your media server is connected. |
| Cannot connect the player to the access point or wireless LAN router. | <ul style="list-style-type: none"> • The wireless communication may be interrupted from household devices that are using radio frequencies. Move the player away from them. |
| Access point is not displayed on the “Access point name” list. | <ul style="list-style-type: none"> • The access point or wireless LAN router may not broadcast its SSID. Set your access point to broadcast its SSID through your computer. • Your network device such as access point may not set with available frequency range and channel that this player can support. Try setting the frequency range and channel on the network device setting. |

Picture

| Symptom | Cause & Solution |
|--|---|
| There is no picture. | <ul style="list-style-type: none"> • Select the appropriate video input mode on the TV so the picture from the unit appears on the TV screen. • Connect the video connection securely. • Check the [HDMI Color Setting] in the [Settings] menu is set to the appropriate item that conforms to your video connection. • Your TV may not support the resolution you have set on the player. Change the resolution that your TV accepts. • The player's HDMI OUT jack is connected to a DVI device that does not support copyright protection. |
| Picture noise appears. | <ul style="list-style-type: none"> • You are playing a disc recorded in a colour system that is different from your TV. • Set the resolution which your TV accepts. |
| Blu-ray 3D disc playback does not output 3D views. | <ul style="list-style-type: none"> • Connect the player to your TV with HDMI cable (Type A, High Speed HDMI™ Cable). • Your TV may not support "HDMI 3D mandatory format". • The [3D Mode] option in the [Settings] menu is set to [Off]. Set the option to [On]. |

5

Customer support

You can update the Player using the latest software to enhance the products operation and/or add new features. To obtain the latest software for this player (if updates have been made), please visit <http://www.lg.com/global/support> or contact LG Electronics customer care centre.

Open source software notice

To obtain the corresponding source code under GPL, LGPL and other open source licenses, please visit <http://opensource.lge.com>. All referred license terms, warranty disclaimers and copyright notices are available to download with the source code.

About Magic Remote Control

To re-register the Magic remote control

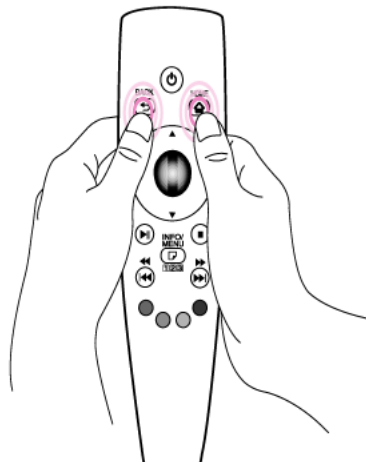

Press the HOME (🏠) and BACK (⏪) buttons at the same time for about 5 seconds. The Magic remote control will be unpaired with your unit.

! Note

- Press the BACK (⏪) button while pointing the remote control at the unit for 5 seconds to reset and re-register it.
- Set the speed and the shape of the Magic pointer that appears on the screen. Refer to the setting of the Magic pointer (page 30).
- If the Magic pointer has not been used for a certain period of time, it will disappear. When the Magic pointer disappears from the screen, shake the Magic remote control to the right and left. Then, it appears again.
- If you press the navigation button while moving the Magic pointer on the screen, the Magic pointer disappears, and the Magic remote control works as a regular remote control.

! Caution

- Use within an effective distance of 33 ft. (10 meters). Using the Remote Control from greater distances or when obstructions block the sight line may cause malfunctions.
- Electronic devices nearby may cause communication interference. Devices such as microwave oven and wireless LAN use the same frequency range (2.4 GHz) as the Magic remote control, which may interfere with the remote control.
- The Magic remote control may be broken if dropped or damaged in any other way.
- Do not drop or subject the Magic remote control to heavy impacts.

Network Software Update

Network update notification

From time to time, performance improvements and/or additional features or services may be made available to units that are connected to a broadband home network. If there is new software available and the unit is connected to a broadband home network, the player will inform you about the update as follows.

Option 1:

1. The update menu will appear on the screen when you turn off the player.
2. Use ◀/▶ to select a desired option and then press **Wheel** (⦿).



| | |
|----------|--|
| [OK] | Starts the software update. |
| [Cancel] | Exits the update menu and turns the power off. |

Option 2:

If the software update is available from the update server, the "Update" icon appears in the Home menu. Press blue (B) colored button to start the update procedure.

Software update

You can update the player using the latest software to enhance the products operation and/or add new features. You can update the software by connecting the unit directly to the software update server.

! Note

- Before updating the software in your player, remove any disc and USB Device from the player.
- Before updating the software in your player, turn the player off and then turn it back on.
- **During the software update procedure, do not turn off the player or disconnect AC power, or do not press any button.**
- If you cancel the update, turn off the power and turn it on for stable performance.
- This unit cannot be updated to previous software version.

1. Check the network connection and settings (page 17).
2. Select [Software] option in the [Settings] menu then press **Wheel** (⦿).
3. Select [Update] option, and press **Wheel** (⦿).



The player will check for the newest update.

! Note

- Pressing **Wheel** (⦿) while checking for the update will end the process.
- If there is no update available, the Message, "No update is found," appears. Press **Wheel** (⦿) to return to the [Home] menu.

4. If newer version exists, the message "Do you want to download it?" appears.
5. Select [OK] to start update. (Selecting [Cancel] will end the update.)
6. The player starts downloading the newest update from the server. (Downloading will take several minutes depending on your home network condition)
7. When downloading is completed, the message, "Download is complete. Do you want to update?" appears.
8. Select [OK] to start updating. (Selecting [Cancel] will end the update and downloaded file will not be re-usable. To update software the next time, the software update procedure has to be started from the beginning again.)

**Caution**

Do not turn off the power during the software update.

9. When update is completed, the power will be turned off automatically in a few seconds.
10. Turn the power back on. The system now operates with the new version.

**Note**

The Software Update function may not work properly depending on your internet environment. In this case, you can obtain the latest software from the authorized LG Electronics Service Center then update your player. Refer to "Customer support" on page 56.

Additional Information

File requirement

Video files

| File Location | File Extension | Codec Format | Audio Format | Subtitle |
|---------------|--|---|--|--|
| Disc, USB | “.avi”, “.mpg”, “.mpeg”, “.mkv”, “.mp4”, “.asf”, “.wmv”, “.m4v” (DRM free), “.vob”, “.3gp”, “.mov”, “.trp”, “.m2t”, “.mpe”, “.m1v”, “.m2v”, “.wm”, “.flv”, “.ts”, “.dat” | XVID, MPEG1 SS, H.264/ MPEG-4 AVC, MPEG2 PS, MPEG2 TS, VC-1 SM (WMV3) | Dolby Digital, DTS, MP3, WMA, AAC, AC3 | SubRip (.srt / .txt), SAMI (.smi), SubStation Alpha (.ssa/.txt), MicroDVD (.sub/.txt), VobSub (.sub), SubViewer 1.0 (.sub), SubViewer 2.0 (.sub/.txt), TMPlayer (.txt), DVD Subtitle System (.txt) |
| DLNA | “.avi”, “.mpg”, “.mpeg”, “.mkv”, “.mp4”, “.asf”, “.wmv”, “.m4v” (DRM free), “.mov”, “.trp”, “.m2t”, “.mpe”, “.m1v”, “.m2v”, “.flv”, “.ts” | XVID, MPEG1 SS, H.264/ MPEG-4 AVC, MPEG2 PS, MPEG2 TS, VC-1 SM (WMV3) | Dolby Digital, DTS, MP3, WMA, AAC, AC3 | SubRip (.srt / .txt), SAMI (.smi), SubStation Alpha (.ssa/.txt), MicroDVD (.sub/.txt), SubViewer 1.0 (.sub), SubViewer 2.0 (.sub/.txt), TMPlayer (.txt), DVD Subtitle System (.txt) |

Audio files

| File Location | File Extension | Sampling Frequency | Bitrate | Note |
|---------------|--|--|--|--|
| Disc, USB | “.mp3”, “.wma”, “.wav”, “.m4a” (DRM free), “.flac” | within 32 - 48 kHz (WMA), within 16 - 48 kHz (MP3) | within 32 - 192 kbps (WMA), within 32 - 320 kbps (MP3) | Some wav files are not supported on this player. |
| DLNA | “.mp3”, “.wma”, “.wav”, “.m4a” (DRM free) | within 32 - 48 kHz (WMA), within 16 - 48 kHz (MP3) | within 32 - 192 kbps (WMA), within 32 - 320 kbps (MP3) | Some wav files are not supported on this player. |

Photo files

| File Location | File Extension | Recommended Size | Note |
|-----------------|---------------------------------|--|---|
| Disc, USB, DLNA | “.jpg”, “.jpeg”, “.png”, “.gif” | Less than 4,000 x 3,000 x 24 bit/pixel Less than 3,000 x 3,000 x 32 bit/pixel | Progressive and lossless compression photo image files are not supported. |

- Supplied bundle DLNA server for Macintosh edition has limitations in file compatibility, such as ASF, WMA and WMV.

! Note

- The file name is limited to 180 characters.
- Maximum files/Folder: Less than 2000 (total number of files and folders)
- Depending on the size and number of the files, it may take several minutes to read the content on the media.
- File compatibility may differ depending on the server.
- Because the compatibility on DLNA server are tested on the bundle DLNA server (Nero MediaHome 4 Essentials Windows edition) environment, file requirements and playback functions may differ depending on media servers.
- The file requirements on page 60 are not always compatible. There may have some restrictions by file features and media server's ability.
- Playing video subtitle files are only available on DLNA media server created by supplied Nero MediaHome 4 Essentials software on this player package.
- The files from removable media such as USB drive, DVD-drive etc. on your media server may not be shared properly.
- This unit cannot support the ID3 Tag embedded MP3 file.
- The total playback time of audio file indicated on the screen may not correct for VBR files.
- HD video files contained on the CD/DVD or USB 1.0/1.1 may not played properly. Blu-ray Disc or USB 2.0 are recommended to play back HD video files.
- This player supports H.264/MPEG-4 AVC profile Main, High at Level 4.1. A file with higher level may not be supported.
- This player does not support files that are recorded with GMC*¹ or Qpel*².
 - *1 GMC – Global Motion Compensation
 - *2 Qpel – Quarter pixel

! Note

- A "avi" file which is encoded "WMV 9 codec" is not supported.
- This player supports UTF-8 files even it contains Unicode subtitle content. This player can not support the pure Unicode subtitle files.
- Depending on the types of file or ways of recording, it may not play back.
- A disc which was recorded by multi-session on normal PC is not supported on this player.
- To be playback a video file, video file name and Subtitle file name must be the same.
- When you play a video file with a extension such as ".ts", ".m2ts", ".mts", ".tp", ".Trp" or ".m2t", your player may not support subtitle files.
- The total playback time of audio file indicated on the screen may not correct for VBR files.
- Video / Audio codec compatibility may differ depending on video file.

AVCHD (Advanced Video Codec High Definition)

- This player can playback AVCHD format discs. These discs are normally recorded and used in camcorders.
- The AVCHD format is a high definition digital video camera format.
- The MPEG-4 AVC/H.264 format is capable of compressing images at higher efficiency than that of the conventional image compressing format.
- This player can playback AVCHD discs using "x.v.Color" format.
- Some AVCHD format discs may not play depending on the recording condition.
- AVCHD format discs need to be finalized.
- "x.v.Color" offers a wider color range than normal DVD camcorder discs.

About DLNA

This Player is a DLNA Certified digital media player that can display and play video, photo and audio content from your DLNA-compatible digital media server (PC and Consumer Electronics).

The Digital Living Network Alliance (DLNA) is a cross-industry organization of consumer electronics, computing industry and mobile device companies. Digital Living provides consumers with easy sharing of digital media through your home network.

The DLNA certification logo makes it easy to find products that comply with the DLNA Interoperability Guidelines. This unit complies with DLNA Interoperability Guidelines v1.5.

When a PC running DLNA server software or other DLNA compatible device is connected to this player, some setting changes of software or other devices may be required. Please refer to the operating instructions for the software or device for more information.

Certain system requirements

For high definition video playback:

- High definition display that has HDMI input jack.
- BD-ROM disc with high definition content.
- HDMI or HDCP capable DVI input on your display device is required for some content (as specified by disc authors).

For Dolby® Digital Plus, Dolby TrueHD and DTS-HD multi-channel audio playback:

- An amplifier/receiver with a built-in (Dolby Digital, Dolby Digital Plus, Dolby TrueHD, DTS or DTS-HD) decoder.
- Main, center, surround speakers and subwoofer as necessary for chosen format.

Compatibility notes

- Because BD-ROM is a new format, certain disc, digital connection and other compatibility issues are possible. If you experience compatibility problems, please contact an authorized Customer Service Center.
- This unit allows you to enjoy functions such as picture-in-picture, secondary audio and Virtual packages, etc., with BD-ROM supporting BONUSVIEW (BD-ROM version 2 Profile 1 version 1.1). Secondary video and audio can be played from a disc compatible with the picture-in-picture function. For the playback method, refer to the instructions in the disc.
- Viewing high-definition content and up-converting standard DVD content may require a HDMI-capable input or HDCP-capable DVI input on your display device.
- Some BD-ROM and DVD discs may restrict the use of some operation commands or features.
- Dolby TrueHD, Dolby Digital Plus and DTS-HD are supported with maximum 7.1 channels if you use HDMI connection for the audio output of the unit.
- You can use an USB device to store some disc related information, including downloaded online content. The disc you are using will control how long this information is retained.

Audio Output Specifications

| Jack/Setting Source | OPTICAL (DIGITAL AUDIO OUT) *3 | | |
|---------------------------|--------------------------------|------------------|---------------|
| | PCM Stereo | DTS Re-encode *4 | BitStream |
| Dolby Digital | PCM 2ch | DTS | Dolby Digital |
| Dolby Digital Plus | PCM 2ch | DTS | Dolby Digital |
| Dolby TrueHD | PCM 2ch | DTS 2ch | Dolby Digital |
| DTS | PCM 2ch | DTS | DTS |
| DTS-HD | PCM 2ch | DTS | DTS |
| Linear PCM 2ch | PCM 2ch | DTS | PCM 2ch |
| Linear PCM 5.1ch | PCM 2ch | DTS | PCM 2ch |
| Linear PCM 7.1ch | PCM 2ch | DTS | PCM 2ch |

| Jack/Setting Source | HDMI OUT | | | |
|---------------------------|------------|--------------|------------------|--------------------|
| | PCM Stereo | PCM Multi-Ch | DTS Re-encode *4 | BitStream *1 *2 |
| Dolby Digital | PCM 2ch | PCM 2ch | DTS | Dolby Digital |
| Dolby Digital Plus | PCM 2ch | PCM 2ch | DTS | Dolby Digital Plus |
| Dolby TrueHD | PCM 2ch | PCM 2ch | DTS 2ch | Dolby TrueHD |
| DTS | PCM 2ch | PCM 5.1ch | DTS | DTS |
| DTS-HD | PCM 2ch | PCM 7.1ch | DTS | DTS-HD |
| Linear PCM 2ch | PCM 2ch | PCM 2ch | DTS | Linear PCM 2ch |
| Linear PCM 5.1ch | PCM 2ch | PCM 5.1ch | DTS | Linear PCM 5.1ch |
| Linear PCM 7.1ch | PCM 2ch | PCM 7.1ch | DTS | Linear PCM 7.1ch |

*1 The secondary and interactive audio may not be included in the output bitstream if [Digital Output] option is set to [BitStream]. (Except LPCM Codec : the output always include interactive and secondary audio.)

*2 This player automatically selects the HDMI audio according to the decoding capability of the connected HDMI device even though [Digital Output] option is set to [BitStream].

*3 On the PCM audio output, the sampling frequency of DIGITAL AUDIO OUT is limited to 96 kHz.

*4 If the [Digital Output] option is set to [DTS re-encode], the audio output is limited to 48 kHz and 5.1Ch. If the [Digital Output] option is set to [DTS re-encode], the DTS Re-encode audio is outputted for BD-ROM discs, and the original audio is outputted for the other discs (like [BitStream]).

- If the HDMI OUT jack is connected to your TV with High Speed HDMI™ Cable and Dolby Digital Plus/Dolby TrueHD is outputted from HDMI OUT jack, DIGITAL AUDIO OUT jack is limited to "PCM 2ch" (When the HDMI and DIGITAL AUDIO OUT are connected simultaneously).

- The audio is outputted as PCM 48 kHz/16 bit for MP3/WMA file and PCM 44.1 kHz/16 bit for Audio CD during playback.
- You must select a digital audio output and a maximum sampling frequency that your Amplifier (or AV receiver) accepts using [Digital Output] and [Sampling Freq.] options on the [Settings] menu (page 27).
- With digital audio connection (DIGITAL AUDIO OUT or HDMI OUT), Disc Menu button sounds of BD-ROM may not be heard if the [Digital Output] option is set to [BitStream].
- If the audio format of the digital output does not match the capabilities of your receiver, the receiver will produce a strong, distorted sound or no sound at all.
- Multi-channel Digital Surround Sound via digital connection can only be obtained if your receiver is equipped with a Digital Multi-channel decoder.

Area Code List

Choose an area code from this list.

| Area | Code | Area | Code | Area | Code | Area | Code |
|----------------|------|---------------|------|--------------------|------|-----------------|------|
| Afghanistan | AF | Fiji | FJ | Monaco | MC | Singapore | SG |
| Argentina | AR | Finland | FI | Mongolia | MN | Slovak Republic | SK |
| Australia | AU | France | FR | Morocco | MA | Slovenia | SI |
| Austria | AT | Germany | DE | Nepal | NP | South Africa | ZA |
| Belgium | BE | Great Britain | GB | Netherlands | NL | South Korea | KR |
| Bhutan | BT | Greece | GR | Antilles | AN | Spain | ES |
| Bolivia | BO | Greenland | GL | New Zealand | NZ | Sri Lanka | LK |
| Brazil | BR | Hong Kong | HK | Nigeria | NG | Sweden | SE |
| Cambodia | KH | Hungary | HU | Norway | NO | Switzerland | CH |
| Canada | CA | India | IN | Oman | OM | Taiwan | TW |
| Chile | CL | Indonesia | ID | Pakistan | PK | Thailand | TH |
| China | CN | Israel | IL | Panama | PA | Turkey | TR |
| Colombia | CO | Italy | IT | Paraguay | PY | Uganda | UG |
| Congo | CG | Jamaica | JM | Philippines | PH | Ukraine | UA |
| Costa Rica | CR | Japan | JP | Poland | PL | United States | US |
| Croatia | HR | Kenya | KE | Portugal | PT | Uruguay | UY |
| Czech Republic | CZ | Kuwait | KW | Romania | RO | Uzbekistan | UZ |
| Denmark | DK | Libya | LY | Russian Federation | RU | Vietnam | VN |
| Ecuador | EC | Luxembourg | LU | Saudi Arabia | SA | Zimbabwe | ZW |
| Egypt | EG | Malaysia | MY | Senegal | SN | | |
| El Salvador | SV | Maldives | MV | | | | |
| Ethiopia | ET | Mexico | MX | | | | |

Language Code List

Use this list to input your desired language for the following initial settings: [Disc Audio], [Disc Subtitle] and [Disc Menu].

| Language | Code | Language | Code | Language | Code | Language | Code |
|-----------------|------|------------------|------|----------------|------|------------|------|
| Afar | 6565 | French | 7082 | Lithuanian | 7684 | Sindhi | 8368 |
| Afrikaans | 6570 | Frisian | 7089 | Macedonian | 7775 | Singhalese | 8373 |
| Albanian | 8381 | Galician | 7176 | Malagasy | 7771 | Slovak | 8375 |
| Amharic | 6577 | Georgian | 7565 | Malay | 7783 | Slovenian | 8376 |
| Arabic | 6582 | German | 6869 | Malayalam | 7776 | Spanish | 6983 |
| Armenian | 7289 | Greek | 6976 | Maori | 7773 | Sudanese | 8385 |
| Assamese | 6583 | Greenlandic | 7576 | Marathi | 7782 | Swahili | 8387 |
| Aymara | 6588 | Guarani | 7178 | Moldavian | 7779 | Swedish | 8386 |
| Azerbaijani | 6590 | Gujarati | 7185 | Mongolian | 7778 | Tagalog | 8476 |
| Bashkir | 6665 | Hausa | 7265 | Nauru | 7865 | Tajik | 8471 |
| Basque | 6985 | Hebrew | 7387 | Nepali | 7869 | Tamil | 8465 |
| Bengali; Bangla | 6678 | Hindi | 7273 | Norwegian | 7879 | Telugu | 8469 |
| Bhutani | 6890 | Hungarian | 7285 | Oriya | 7982 | Thai | 8472 |
| Bihari | 6672 | Icelandic | 7383 | Panjabi | 8065 | Tonga | 8479 |
| Breton | 6682 | Indonesian | 7378 | Pashto, Pushto | 8083 | Turkish | 8482 |
| Bulgarian | 6671 | Interlingua | 7365 | Persian | 7065 | Turkmen | 8475 |
| Burmese | 7789 | Irish | 7165 | Polish | 8076 | Twi | 8487 |
| Byelorussian | 6669 | Italian | 7384 | Portuguese | 8084 | Ukrainian | 8575 |
| Chinese | 9072 | Japanese | 7465 | Quechua | 8185 | Urdu | 8582 |
| Croatian | 7282 | Kannada | 7578 | Rhaeto-Romance | 8277 | Uzbek | 8590 |
| Czech | 6783 | Kashmiri | 7583 | Rumanian | 8279 | Vietnamese | 8673 |
| Danish | 6865 | Kazakh | 7575 | Russian | 8285 | Volapük | 8679 |
| Dutch | 7876 | Kirghiz | 7589 | Samoan | 8377 | Welsh | 6789 |
| English | 6978 | Korean | 7579 | Sanskrit | 8365 | Wolof | 8779 |
| Esperanto | 6979 | Kurdish | 7585 | Scots Gaelic | 7168 | Xhosa | 8872 |
| Estonian | 6984 | Laotian | 7679 | Serbian | 8382 | Yiddish | 7473 |
| Faroese | 7079 | Latin | 7665 | Serbo-Croatian | 8372 | Yoruba | 8979 |
| Fiji | 7074 | Latvian, Lettish | 7686 | Shona | 8378 | Zulu | 9085 |
| Finnish | 7073 | Lingala | 7678 | | | | |

Trademarks and Licenses



Blu-ray Disc™, Blu-ray™, Blu-ray 3D™, BD-Live™, BONUSVIEW™ and the logos are trademarks of the Blu-ray Disc Association.



“DVD Logo” is a trademark of DVD Format/Logo Licensing Corporation.



Java is a trademark of Oracle and/or its affiliates.



The terms HDMI and HDMI High-Definition Multimedia Interface, and the HDMI logo are trademarks or registered trademarks of HDMI Licensing LLC in the United States and other countries.

“x.v.Colour” is a trademark of Sony Corporation.



Manufactured under license from Dolby Laboratories. Dolby and the double-D symbol are trademarks of Dolby Laboratories.



Manufactured under license under U.S. Patent Nos: 5,956,674; 5,974,380; 6,226,616; 6,487,535; 7,212,872; 7,333,929; 7,392,195; 7,272,567 & other U.S. and worldwide patents issued & pending. DTS-HD, the Symbol, & DTS-HD and the Symbol together are registered trademarks & DTS-HD Master Audio is a trademark of DTS, Inc. Product includes software. © DTS, Inc. All Rights Reserved.



DLNA®, the DLNA Logo and DLNA CERTIFIED® are trademarks, service marks, or certification marks of the Digital Living Network Alliance.



The Wi-Fi CERTIFIED Logo is a certification mark of the Wi-Fi Alliance.



The Wi-Fi Protected Setup Mark is a trademark of the Wi-Fi Alliance.



“AVCHD” and the “AVCHD” logo are trademarks of Panasonic Corporation and Sony Corporation.



Gracenote®, Gracenote logo and logotype, and the “Powered by Gracenote” logo are either registered trademarks or trademarks of Gracenote, Inc. in the United States and/or other countries.

Music recognition technology and related data are provided by Gracenote®.

Portions of the content is copyright © Gracenote or its providers.

Gracenote® End User License Agreement

This application or device contains software from Gracenote, Inc. of Emeryville, California (“Gracenote”). The software from Gracenote (the “Gracenote Software”) enables this application to perform disc and/or file identification and obtain music-related information, including name, artist, track, and title information (“Gracenote Data”) from online servers or embedded databases (collectively, “Gracenote Servers”) and to perform other functions. You may use Gracenote Data only by means of the intended End-User functions of this application or device.

You agree that you will use Gracenote Data, the Gracenote Software, and Gracenote Servers for your own personal non-commercial use only. You agree not to assign, copy, transfer or transmit the Gracenote Software or any Gracenote Data to any third party. YOU AGREE NOT TO USE OR EXPLOIT GRACENOTE DATA, THE GRACENOTE SOFTWARE, OR GRACENOTE SERVERS, EXCEPT AS EXPRESSLY PERMITTED HEREIN.

You agree that your non-exclusive license to use the Gracenote Data, the Gracenote Software, and Gracenote Servers will terminate if you violate these restrictions. If your license terminates, you agree to cease any and all use of the Gracenote Data, the Gracenote Software, and Gracenote Servers. Gracenote reserves all rights in Gracenote Data, the Gracenote Software, and the Gracenote Servers, including all ownership rights. Under no circumstances will Gracenote become liable for any payment to you for any information that you provide. You agree that Gracenote, Inc. may enforce its rights under this Agreement against you directly in its own name.

The Gracenote service uses a unique identifier to track queries for statistical purposes. The purpose of a randomly assigned numeric identifier is to allow the Gracenote service to count queries without knowing anything about who you are. For more information, see the web page for the Gracenote Privacy Policy for the Gracenote service.

The Gracenote Software and each item of Gracenote Data are licensed to you “AS IS.” Gracenote makes no representations or warranties, express or implied, regarding the accuracy of any Gracenote Data from in the Gracenote Servers. Gracenote reserves the right to delete data from the Gracenote Servers or to change data categories for any cause that Gracenote deems sufficient. No warranty is made that the Gracenote Software or Gracenote Servers are error-free or that functioning of Gracenote Software or Gracenote Servers will be uninterrupted. Gracenote is not obligated to provide you with new enhanced or additional data types or categories that Gracenote may provide in the future and is free to discontinue its services at any time.

GRACENOTE DISCLAIMS ALL WARRANTIES EXPRESS OR IMPLIED, INCLUDING, BUT NOT LIMITED TO, IMPLIED WARRANTIES OF MERCHANTABILITY, FITNESS FOR A PARTICULAR PURPOSE, TITLE, AND NON-INFRINGEMENT. GRACENOTE DOES NOT WARRANT THE RESULTS THAT WILL BE OBTAINED BY YOUR USE OF THE GRACENOTE SOFTWARE OR ANY GRACENOTE SERVER. IN NO CASE WILL GRACENOTE BE LIABLE FOR ANY CONSEQUENTIAL OR INCIDENTAL DAMAGES OR FOR ANY LOST PROFITS OR LOST REVENUES.

© Gracenote, Inc. 2009

Cinavia Notice

This product uses Cinavia technology to limit the use of unauthorized copies of some commercially-produced film and videos and their soundtracks. When a prohibited use of an unauthorized copy is detected, a message will be displayed and playback or copying will be interrupted.

More information about Cinavia technology is provided at the Cinavia Online Consumer Information Center at <http://www.cinavia.com>. To request additional information about Cinavia by mail, send a postcard with your mailing address to: Cinavia Consumer Information Center, P.O. Box 86851, San Diego, CA, 92138, USA.

This product incorporates proprietary technology under license from Verance Corporation and is protected by U.S. Patent 7,369,677 and other U.S. and worldwide patents issued and pending as well as copyright and trade secret protection for certain aspects of such technology. Cinavia is a trademark of Verance Corporation. Copyright 2004-2012 Verance Corporation. All rights reserved by Verance. Reverse engineering or disassembly is prohibited.

Specifications

| General | |
|------------------------|---|
| Power requirements | Refer to main label on the rear panel. |
| Power consumption | 16 W |
| Dimensions (W x H x D) | Approx. 430 mm x 37.5 mm x 203 mm (17" x 1.5" x 8") |
| Net Weight (Approx.) | 1.6 kg (3.5 lbs) |
| Operating temperature | 5 °C to 35 °C (41 °F to 95 °F) |
| Operating humidity | 5 % to 90 % |

| Outputs | |
|-----------------------------|----------------------------------|
| HDMI OUT (video/audio) | 19 pin (Type A, HDMI™ Connector) |
| DIGITAL AUDIO OUT (OPTICAL) | 3 V (p-p), Optical jack x 1 |

| System | |
|---------------------------------|---|
| Laser | Semiconductor laser |
| Wavelength | 405 nm / 650 nm |
| Signal system | Standard NTSC colour TV system |
| LAN port | Ethernet jack x 1, 10BASE-T / 100BASE-TX |
| Wireless LAN (internal antenna) | Integrated IEEE 802.11n (5 GHz and 2.4 GHz bands) wireless networking access, compatible with 802.11a/b/g Wi-Fi networks. |
| Bus Power Supply (USB) | DC 5 V  500 mA |

- Design and specifications are subject to change without notice.

Maintenance

Handling the unit

When shipping the unit

Please save the original shipping carton and packing materials. If you need to ship the unit, for maximum protection, re-pack the unit as it was originally packed at the factory.

Cleaning the unit

To clean the player, use a soft, dry cloth. If the surfaces are extremely dirty, use a soft cloth lightly moistened with a mild detergent solution. Do not use strong solvents such as alcohol, benzine, or thinner, as these might damage the surface of the unit.

Keeping the exterior surfaces clean

- Do not use volatile liquids such as insecticide spray near the unit.
- Wiping with strong pressure may damage the surface.
- Do not leave rubber or plastic products in contact with the unit for a long period of time.

Maintaining the unit

The unit is a high-tech, precision device. If the optical pick-up lens and disc drive parts are dirty or worn, the picture quality could be diminished. For details, please contact your nearest authorized service centre.

Notes on discs

Handling discs

Do not touch the playback side of the disc. Hold the disc by the edges so that fingerprints do not get on the surface. Never stick paper or tape on the disc.

Storing discs

After playing, store the disc in its case. Do not expose the disc to direct sunlight or sources of heat and never leave it in a parked car exposed to direct sunlight.

Cleaning discs

Fingerprints and dust on the disc can cause poor picture quality and sound distortion. Before playing, clean the disc with a clean cloth. Wipe the disc from the centre to out.

Do not use strong solvents such as alcohol, benzine, thinner, commercially available cleaners, or anti-static spray intended for older vinyl records.

Important Information Relating to Network Services

All information, data, documents, communications, downloads, files, text, images, photographs, graphics, videos, webcasts, publications, tools, resources, software, code, programs, applets, widgets, applications, products and other content (“Content”) and all services and offerings (“Services”) provided or made available by or through any third party (each a “Service Provider”) is the sole responsibility of the Service Provider from whom it originated.

The availability of and access to Content and Services furnished by the Service Provider through the LGE Device are subject to change at any time, without prior notice, including, but not limited to the suspension, removal or cessation of all or any part of the Content or Services.

Should you have any inquiry or problem related to the Content or Services, you may refer to the Service Provider’s website for the most up-to-date information. LGE is neither responsible nor liable for customer service related to the Content and Services. Any question or request for service relating to the Content or Services should be made directly to the respective Content and Service Providers.

Please note that LGE is not responsible for any Content or Services provided by the Service Provider or any changes to, removal of, or cessation of such Content or Services and does not warrant or guaranty the availability of or access to such Content or Services.

