

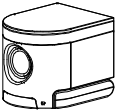

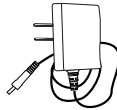

CAM340+ Quick Start Guide

Package Contents

CAM340+	Power Adapter (for USB 2.0)	USB cable	Quick Start Guide
			
Tripod screw	Warranty Card		
			

Overview

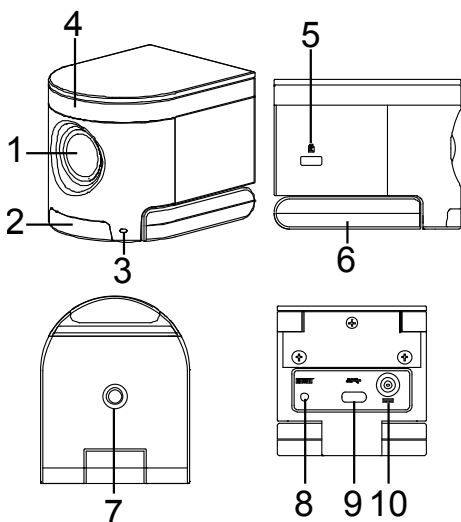

1. Lens
(Max. viewing angle 120°)
2. IR receiver
3. Status light
4. Microphone
5. Kensington slot
6. Mount clip
7. Tripod screw hole
8. RESET pin
9. USB type-C connector
10. DC power jack

Setup CAM340+

1. Install the CAM340+ on top of TV or on a tripod.

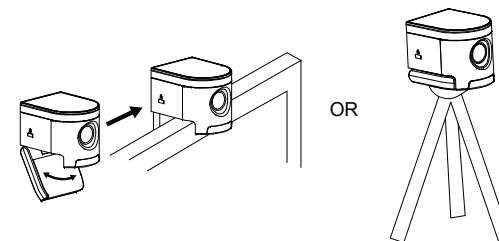

2. Connect CAM340+ to PC with provided USB cable. If you like to use type-C connector on newer PC, connect your adapter to USB cable, and then connect type-C side of adapter to PC.

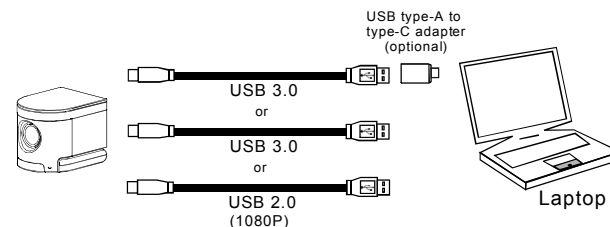

3. If you connect CAM340+ to USB2.0 port on PC, please connect provided power adapter to CAM340+ and wall when a warning (As figure shown) is displayed on PC.
[Note] The warning message display time is short.

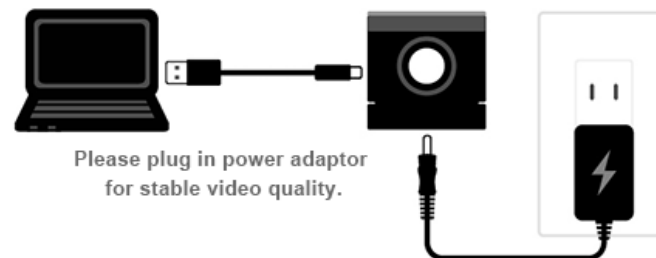

Please plug in power adaptor for stable video quality.

- Select CAM340+ as the camera or video device in your app. If you want to use CAM340+ microphone, please turn on the microphone function (Default is off) through the AVer PTZApp. Next, select CAM 340+ as your microphone or audio device. For multi-person conferences, it is recommended to use an external professional microphone or to use with the AVer professional speaker microphone device for the best conference results.

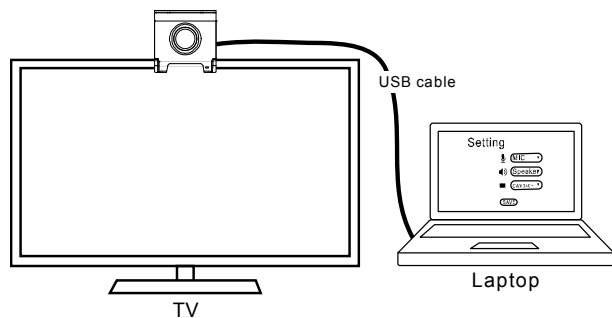

- For advanced setting and firmware update, please download AVer PTZApp from <http://www.aver.com/download-center>

Status LED

LED	Status
Amber	Not in use
Solid Green	Camera is operated now
Blinking green	Firmware updating

[Note]

CAM340+ is a Plug-n-Play Conference Camera. The system requires no special drivers. Please visit www.aver.com for more information.

Install AVer PTZApp

Please go to <http://www.aver.com/download-center> to download the AVer PTZApp. After downloading, double-click on the file and follow the on-screen instructions to complete the installation.

After installing the AVer PTZApp, double-click on the AVer PTZApp icon to run the application.

Use AVer PTZApp

- To run your video application, a plug-in request will be displayed on your video application interface. Click on it to accept the plug-in; your video application can now be control by AVer PTZApp and remote control.
- During your video call, you can use the AVer PTZApp to pan, tilt and zoom the camera in/out and enable/disable the backlight feature, set up camera brightness and sharpness. For more details, please refer to the user manual.
- If the CAM340+ is installed in the upside down position, please enable the "Flip" function in the AVer PTZApp, and the screen will display normally.

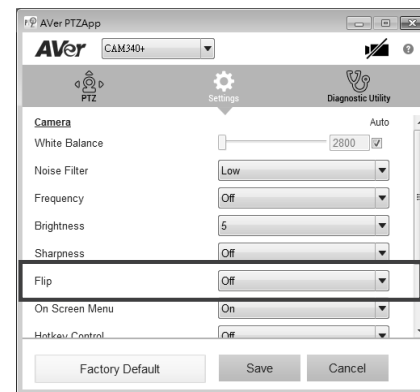

- For USB Data Transfer Mode, please select mode in Mac OS and Windows as:

- ✓ For Mac OS: **isochronous mode**
- ✓ For Windows: **Bulk mode**



Hotkey Control

Enable hotkey control to use keyboard control camera's movement and backlight function.

- Select "Settings"
- Set Hotkey Control to "On".

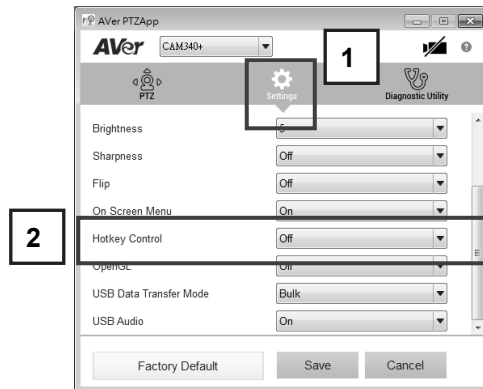

- A hotkey description as below figure shown:



- When hotkey control is enabled, a hotkey tip will display when mouse is moved to the PTZ control button in PTZ mode.

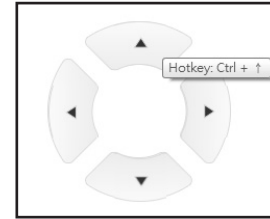

[Note] If the hotkey function is enabled after installed PTZApp, PTZApp auto launch next time PC reboot. Therefore, the customer can use all the hotkey commands since PTZApp is auto running in system tray.

Install EZLive

Please go to <http://www.aver.com/download-center> to download the AVer EZLive software. After downloading, double-click on the file and follow the on-screen instructions to complete the installation.

Use AVer EZLive

During a video call, EZLive can help user to do:

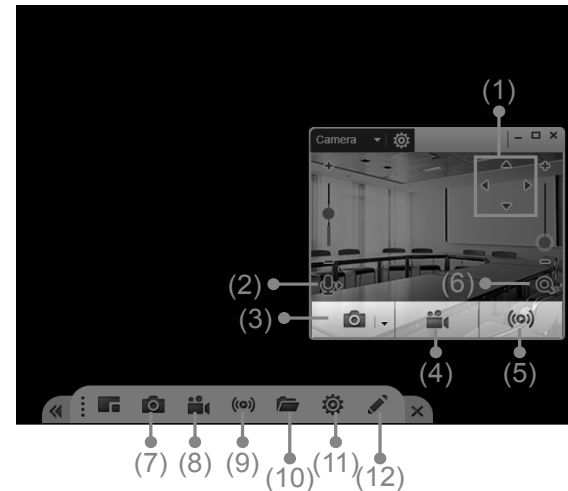

- Camera Zoom in/out
- Capture PC screen shot
- Record PC screen video
- Record PC screen video
- Set up livestream
- Open file management to retrieve photos and video files
- Livestream setting
- Drawing tool

- Camera ePTZ
- Volume control for the speaker connected
- Capture camera's still images
- Record video
- Live stream to Youtube, Livehouse.in, USTREAM...etc.

Remote Controller

The remote controller is an **optional accessory**. For the purchasing, please contact your dealer.

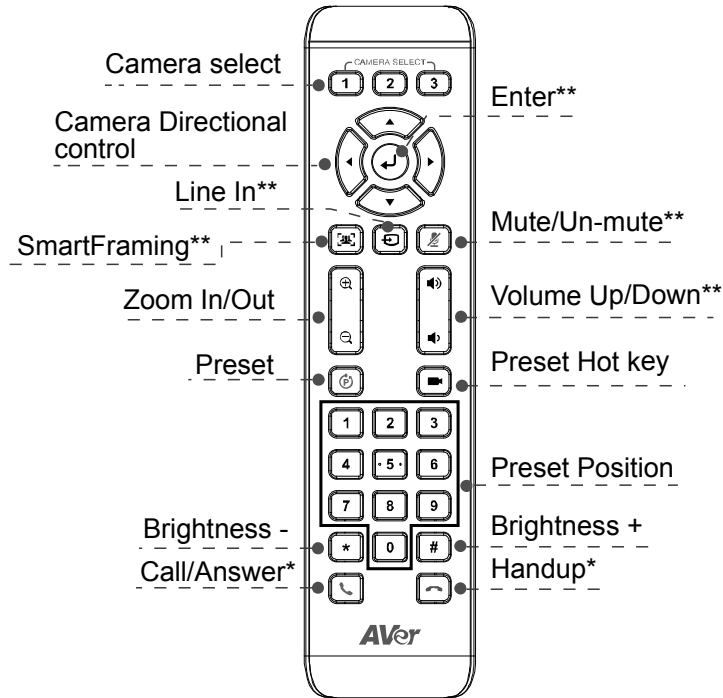

*Function requires AVer PTZApp

**Not support for CAM340+

AAA Batteries (required)

More Help

For FAQs, technical support, software and user manual download, please visit:

<http://www.aver.com/technical-support>

Contact Information

AVer Information Inc.

www.aver.com

8F, No.157, Da-An Rd., Tucheng Dist.,

New Taipei City

Taiwan

Tel: +886-2-2269-8535

Federal Communication Commission Interference Statement

This device complies with Part 15 of the FCC Rules. Operation is subject to the following two conditions: (1) This device may not cause harmful interference, and (2) this device must accept any interference received, including interference that may cause undesired operation.

This equipment has been tested and found to comply with the limits for a Class B digital device, pursuant to Part 15 of the FCC Rules. These limits are designed to provide reasonable protection against harmful interference in a residential installation. This equipment generates uses and can radiate radio frequency energy and, if not installed and used in accordance with the instructions, may cause harmful interference to radio communications. However, there is no guarantee that interference will not occur in a particular installation. If this equipment does cause harmful interference to radio or television reception, which can be determined by turning the equipment off and on, the user is encouraged to try to correct the interference by one of the following measures:

- Reorient or relocate the receiving antenna.
- Increase the separation between the equipment and receiver.
- Connect the equipment into an outlet on a circuit different from that to which the receiver is connected.
- Consult the dealer or an experienced radio/TV technician for help.

FCC Caution: Any changes or modifications not expressly approved by the party responsible for compliance could void the user's authority to operate this equipment.

CAUTION

Risk of explosion if battery is replaced by an incorrect type.
Dispose of used batteries in a safe and proper manner.