

Smart-UPS™ Modular Ultra Uninterruptible Power Supply

User Manual

SRYL5K15XLT18
SRYL5K20XLT18
SRYL10K15XLT18
SRYL10K20XLT18
SRYL15K15XLT18
SRYL15K20XLT18
SRYL20K20XLT18

SRYL5K15XLT24
SRYL5K20XLT24
SRYL10K15XLT24
SRYL10K20XLT24
SRYL15K15XLT24
SRYL15K20XLT24
SRYL20K20XLT24

SRYL4K13XLM24
SRYL9K13XLM24
SRYL13K13XLM24
SRYL4K18XLM24
SRYL9K18XLM24
SRYL13K18XLM24
SRYL18K18XLM24

EN TME23641B
10/2024

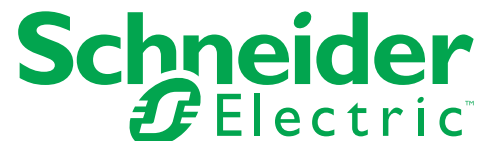

Legal Information

The Schneider Electric brand and any trademarks of Schneider Electric SE and its subsidiaries referred to in this guide are the property of Schneider Electric SE or its subsidiaries. All other brands may be trademarks of their respective owners.

This guide and its content are protected under applicable copyright laws and furnished for informational use only. No part of this guide may be reproduced or transmitted in any form or by any means (electronic, mechanical, photocopying, recording, or otherwise), for any purpose, without the prior written permission of Schneider Electric.

Schneider Electric does not grant any right or license for commercial use of the guide or its content, except for a non-exclusive and personal license to consult it on an "as is" basis. Schneider Electric products and equipment should be installed, operated, serviced, and maintained only by qualified personnel.

As standards, specifications, and designs change from time to time, information contained in this guide may be subject to change without notice.

To the extent permitted by applicable law, no responsibility or liability is assumed by Schneider Electric and its subsidiaries for any errors or omissions in the informational content of this material or consequences arising out of or resulting from the use of the information contained herein.

Content

Important Safety Instructions	5
Product Handling Guidelines.	5
Safety and General Information	5
Deenergizing safety	6
Electrical safety	6
Battery safety	7
Hardwire safety	8
Physical site security	8
Cybersecurity Guidelines	8
FCC Class A Radio Frequency Warning	10
VCCI-A Caution	10
Product Overview	11
Specifications	11
Environmental	11
Physical	11
Battery	12
Electrical	12
Wiring (Hardwire)	14
Package contents	15
Replacement Modules	16
Installation	16
Unpacking	16
Installing Optional Door Assembly	20
Install Power Module(s) and Battery Module(s)	21
Remove Blanking Panels	22
Remove Power Module and Battery Module	22
Rear Panel Features.....	24
UPS Frame	24
Battery Frame	25
Front Panel Features	25
UPS	25
Hardwiring.....	26
Connect Battery Frame.....	27
Connect a single battery frame to UPS	28
Connect multiple battery frames to UPS	29
Battery Cable Extension	30
Redundancy Configuration	31
Operation	32
Modes	32
Set the UPS to Manual Bypass Mode	35
One Line Diagram Status Indicators	36
Status LEDs	37
Start Up	38

Turn on / Turn off the UPS	38
LCD Display	40
UPS Menu Overview	45
Configuration	48
Startup configuration	48
General settings	50
Control	64
UPS	64
Display	66
Login to LCD Display	67
Update Firmware	69
Through USB	69
Through NMC web page	70
Download Log Files	71
Through USB	71
Through NMC web page	71
Emergency Power Off	72
Network Management Interface	74
Related Documents	75
IP Address Configuration	75
Smart Battery Management	76
Definitions	76
User interface	76
Maintenance	76
End of useful life	76
Recycling the BM	77
Recommended actions after installing new BM or XBP	77
Troubleshooting	78
Transport	81
Service	81
Limited Factory Warranty	82
APC Worldwide Customer Support	84

Important Safety Instructions

SAVE THESE INSTRUCTIONS - This manual contains important instructions that should be followed during installation and maintenance of APC™ Smart-UPS™ Modular Ultra series of equipment and batteries.



Read the Safety Guide supplied with the equipment to become familiar with the safety requirements before trying to install or operate the UPS.

Read the user documentation to become familiar with the equipment before trying to install or operate it.

The following special messages may appear throughout this document or on the equipment to warn of potential hazards or to call attention to information that clarifies or simplifies a procedure.



The addition of this symbol either to a “Danger” or “Warning” safety label indicates that an electrical hazard exists that will result in personal injury if the instructions are not followed.



This is the safety alert symbol. It is used to alert you to potential personal injury hazards. Obey all safety messages that follow this symbol to avoid possible injury or death.

DANGER
DANGER indicates a hazardous situation which, if not avoided, will result in death or serious injury.
WARNING
WARNING indicates a hazardous situation which, if not avoided, could result in death or serious injury.
CAUTION
CAUTION indicates a hazardous situation which, if not avoided, could result in minor or moderate injury.
NOTICE
NOTICE is used to address practices not related to physical injury.

Product Handling Guidelines

Inspect the package contents upon receipt. Notify the carrier and dealer if there is any damage.

<18 kg <40 lb	18-32 kg 40-70 lb	32-55 kg 70-120 lb	>55 kg >120 lb		

Safety and General Information

- Adhere to all national and local electrical codes.
- All wiring must be performed by a qualified electrician.
- Changes and modifications to this unit not expressly approved by Schneider Electric could void the warranty.

Electrical equipment should be installed and operated only by qualified personnel. No responsibility is assumed by Schneider Electric for any consequences arising out of the use of this material.

- This UPS is only for Professional Business Applications and not for Consumer Applications.
- This UPS is intended for indoor use only.
- This UPS must be installed in dedicated IT environments only.
- Do not operate this UPS in direct sunlight, in contact with fluids, or where there is excessive dust or humidity.
- Be sure the air vents on the UPS are not blocked. Allow adequate space for proper ventilation.
- The equipment is heavy. Always practice safe lifting techniques adequate for the weight of the equipment.
- Be sure that the depth of the rack is at least 1070 mm.
- Be sure that a clear space of 300 mm (minimum), for ventilation, is available from the front and rear surfaces
 - of the rack, when the UPS is installed in a rack.
 - of the UPS, when the UPS is installed in tower orientation.
- Do not move or ship the rack after installing the UPS.
- The battery modules are heavy. Remove the battery modules before installing the UPS and External Battery Packs (XBPs), in a rack.
- Always install XBPs at the bottom in rack-mount configurations. The UPS must be installed above the XBPs.
- Always install peripheral equipment above the UPS in rack-mount configurations.
- Additional safety information can be found in the Safety Guide supplied with this unit.
- This UPS must be installed by service personnel or a qualified electrician.

Deenergizing safety

- The UPS contains internal battery modules and may present a shock hazard even when disconnected from AC and DC power.
- Before installing the UPS or any accessory be sure that the:
 - Mains circuit breaker is in **OFF** position or the UPS is disconnected from AC source
 - Internal UPS battery modules are removed
 - XBP(s) is(are) disconnected

Electrical safety

- The connection to the branch circuit (mains) must be performed by a qualified electrician.
- The protective earth conductor for the UPS carries the leakage current from the load devices (computer equipment). An insulated ground conductor is to be installed as part of the branch circuit that supplies input power to the UPS. The conductor must have the same size and insulation material as the grounded and ungrounded branch circuit supply conductors. The conductor will typically be green and with or without a yellow stripe.

- The UPS input ground conductor must be properly bonded to protective earth at the service panel. If the UPS input power is supplied by a separately derived system, the ground conductor must be properly bonded at the supply transformer or motor generator set.
- Connect only SELV circuits to all the communication ports.

Battery safety



WARNING

RISK OF CHEMICAL HAZARD AND EXCESSIVE SMOKE

- Replace the battery modules at least every 10 years or at the end of its service life, whichever is earlier.
- Replace the battery modules immediately when the UPS indicates battery replacement is necessary.
- Replace the battery modules with the same number as originally installed in the equipment.

Failure to follow these instructions can result in death or serious injury.

- Schneider Electric uses Lithium Ion batteries. Under normal use and handling, there is no contact with the internal components of the battery.
- The replaceable battery module (RBM) typically lasts for 10 years. Environmental factors impact battery life. Elevated ambient temperatures, poor quality mains power causing frequent short duration discharges will shorten battery life.
- CAUTION: Before installing or replacing the RBM, remove conductive jewelry such as chains, wrist watches and rings. High energy through conductive materials could cause severe burns.
- CAUTION: Do not place or use the RBM or XBP near heat or fire. Do not crush, do not dispose off a RBM or XBP in a fire. The batteries may explode.
- CAUTION: Do not open the RBM enclosure. Doing so will expose the cell terminals which pose an energy hazard.
- CAUTION: Do not open the RBM or mutilate the cells inside. Released chemical is harmful to the skin and eyes. It may be toxic.
- CAUTION: RBM can present a risk of electric shock and burns by high short-circuit current.
- CAUTION: Failed RBMs can reach temperatures that exceed the burn thresholds for touchable surfaces.
- Do not use a dropped, damaged or deformed RBM.
- Do not short circuit the RBM.
- Do not drive nails into the RBM.
- Do not strike the RBM with a hammer.
- The XBPs should be replaced by qualified personnel only.
- The RBMs can be replaced by the user.
NOTE: Live swap of RBM should be performed by qualified personnel only.

Hardwire safety

- Verify that all branch circuit (mains) and low voltage (control) circuits are de-energized, and locked out before installing cables or making connections, whether in the junction box or to the UPS.
- Wiring must be done only by a qualified electrician.
- Check national and local codes before wiring.
- Strain relief is required for all hardwiring (supplied with select products). Snap in type strain reliefs are recommended.
- All openings that allow access to UPS hardwire terminals must be covered. Failure to do so may result in personal injury or equipment damage.
- Select wire size and connectors according to national and local codes.

Physical site security

Recommendations to secure the site, to prevent physical attacks:

- Secure the front panel of your device and deploy the device in a secure location.
- Secure the front panel by installing the device inside cabinets or the device is protected by physical restraints that prevent unauthorized access or removal from restricted areas. Cabinets should be locked with a suitable key or other physical methods.

To secure the location (restricted area):

- Clearly mark the restricted area “for authorized personnel only”.
- Lock the doors to the restricted area.
- Grant access to restricted areas only to such personnel based on their job function.
- Give minimum indication of the purpose of the covered devices in restricted areas without identifying the presence of related functions.
- Provide control devices (for physical access), such as key card readers, locks for doors and cabinets. These physical access control devices should be tested before putting them to use as well as periodically.
- Be sure that resource custodian is able produce physical or electronic audit trails to record all personnel’s physical access to restricted areas for security incident investigation.
- Regularly review inventory of personnel having physical access to control devices and promptly remove any inappropriate access identified during such reviews.
- Consider physical security of cabling when insecure protocols like Modbus TCP are used.

Cybersecurity Guidelines



WARNING

POTENTIAL COMPROMISE OF SYSTEM AVAILABILITY, INTEGRITY, AND CONFIDENTIALITY

Use cybersecurity best practices to help prevent unauthorized access to the system software.

Failure to follow these instructions can result in death, serious injury, or equipment damage.

To know more about the latest cybersecurity news, sign up security notifications, or to report a vulnerability, visit [Schneider Electric Cybersecurity Support Portal](#).

Recommended Actions

NOTE: The list of recommended actions below is not a complete list of possible cybersecurity measures. It is meant to be a starting point to improve the security of your system.

Upgrades

- Always use the latest firmware for your Schneider Electric devices in order to get new features, cybersecurity fixes and improvements.
- **IMPORTANT:** Use only official Schneider Electric web pages to download firmware for Schneider Electric devices. Use only the update procedures from the product's user manual.
- Keep your devices up-to-date; check for new firmware, or accept firmware update prompts.
- Install the latest updates for the operating system.

Passwords

- The passwords must have a minimum of 8 characters.
- The password should not be easily found in the dictionary and a phrase is preferred.
- Change passwords frequently, at least once a year.
- Change the default password, immediately after first log in to the system and after a factory reset.
- Do not re-use passwords.

Network

- Schneider Electric devices should not have a publicly accessible IP address.
- Do not use port forwarding to access a Schneider Electric device from public internet.
- Schneider Electric devices should be on their own network segment. If your router supports a guest network or VLAN, it is preferable to locate the devices there.
- Use HTTPs in local network.

Data Localization

Data Localization refers to a mandatory legal or administrative requirement directly or indirectly requiring that data be stored or processed, exclusively or non-exclusively, within a specified jurisdiction.

If data localization laws apply in your region, we strongly recommend setting up this device or system in a way that would not conduct a data cross-border transfer directly or through other channels. Details of data localization laws may vary in different regions. Your legal team is the best resource to give you compliance advice for your specific situation.

Decommissioning

Before a device or system is permanently removed from your network perform a full factory reset to erase all data.

FCC Class A Radio Frequency Warning

NOTE: Applicable for XLT models only.

This equipment has been tested and found to comply with the limits for a Class A digital device, pursuant to part 15 of the FCC Rules. These limits are designed to provide reasonable protection against harmful interference when the equipment is operated in a commercial environment. This equipment generates, uses, and can radiate radio frequency energy and, if not installed and used in accordance with the instruction manual, may cause harmful interference to radio communications. Operation of this equipment in a residential area is likely to cause harmful interference in which case the user will be required to correct the interference at their own expense.

VCCI-A Caution

NOTE: Applicable for XLM models only.

この装置は、クラスA機器です。この装置を住宅環境で使用すると電波妨害を引き起こすことがあります。この場合には使用者が適切な対策を講ずるよう要求されることがあります。

VCCI-A

su1115a

Product Overview

APC Smart-UPS Modular Ultra is a high-performance, Uninterruptible Power Supply (UPS) designed to power high availability servers and other sensitive electronic equipment. It helps to provide conditioned, reliable AC power to connected equipment, as well as helps to provide protection from power blackouts, brownouts, swells, sags, and surges.

The UPS is modular in design and can be configured to deliver different output power at different levels of redundancy.

Specifications

Environmental

Temperature	Operating	0 to 40 °C (32 to 104 °F)
	Storage	With batteries: -15 to 45 °C (5 to 113 °F) Without batteries: -30 to 70 °C (-22 to 158 °F)
Maximum Elevation	Operating	0 - 3,000 m (0 - 10,000 ft)
	Storage	0 - 15,000 m (50,000 ft)
Humidity	0% to 95% relative humidity, non-condensing	
International Protection Code	IP20	

NOTE:

- Charge the Battery Modules (BM) immediately upon receipt or during first installation.
- Charge the Battery Modules (BM) at least every nine (9) months for storage temperatures up to 35 °C (95 °F) or every six (6) months for storage temperatures above 35 °C (95 °F).
- It is recommend to store the BM below 30 °C (86 °F).
- Environmental factors impact battery life. Elevated ambient temperatures, high humidity, and frequent short duration discharges caused due to poor quality mains power will shorten battery life.

Physical

Model	Dimensions without packaging (H x W x D)	Dimensions with packaging (H x W x D)	Net Weight ¹	Weight with packaging ²
SRYL5K15XLT18	924 x 600 x 900 mm (36.38 x 23.62 x 35.43 in)	1048 x 746 x 986 mm (41.25 x 29.37 x 38.81 in)	163.70 kg (360.90 lb)	186.10 kg (410.30 lb)
SRYL10K15XLT18			183.10 kg (403.67 lb)	202.50 kg (446.44 lb)
SRYL15K15XLT18			205.50 kg (453.10 lb)	224.90 kg (583.70 lb)
SRYL5K20XLT18			184.20 kg (406.10 lb)	206.55 kg (455.40 lb)
SRYL10K20XLT18			203.60 kg (448.90 lb)	225.65 kg (497.50 lb)
SRYL15K20XLT18			223.00 kg (491.65 lb)	245.40 kg (541.00 lb)
SRYL20K20XLT18			242.40 kg (534.40 lb)	264.75 kg (583.70 lb)

Model	Dimensions without packaging (H x W x D)	Dimensions with packaging (H x W x D)	Net Weight ¹	Weight with packaging ²
SRYL5K15XLT24 SRYL4K13XLM24	1198 x 600 x 900 mm (47.17 x 23.62 x 35.43 in)	1322 x 746 x 986 mm (52.05 x 29.37 x 38.82 in)	174.60 kg (384.95 lb)	197.96 kg (436.45 lb)
SRYL10K15XLT24 SRYL9K13XLM24			194.00 kg (427.70 lb)	216.36 kg (477.00 lb)
SRYL15K15XLT24 SRYL13K13XLM24			213.40 kg (470.50 lb)	235.76 kg (519.80 lb)
SRYL5K20XLT24 SRYL4K18XLM24			195.20 kg (430.35 lb)	217.56 kg (479.65 lb)
SRYL10K20XLT24 SRYL9K18XLM24			214.60 kg (473.10 lb)	236.96 kg (522.40 lb)
SRYL15K20XLT24 SRYL13K18XLM24			234.00 kg (515.90 lb)	256.36 kg (565.20 lb)
SRYL20K20XLT24 SRYL18K18XLM24			253.40 kg (558.65 lb)	275.76 kg (607.95 lb)

¹ Net weight includes the net weights of enclosure, frame(s), battery module(s) and power module(s).

² Weight with packaging includes the packaged weights of the enclosure and frames only.

Battery

Battery type	Lithium-ion
Battery module rating	180 V 2.47 Ah; 444.6 Wh

Electrical

CAUTION

RISK OF FIRE

Connect the UPS only to a circuit provided with recommended maximum branch circuit over-current protection in accordance with the National Electrical Code, ANSI/NFPA 70 and the Canadian Electrical Code, Part I, C22.1.

Failure to follow these instructions could result in equipment damage and minor or moderate injury.

Model	Input current rating	Branch current circuit breaker rating
SRYL5K15XLT18/SRYL5K15XLT24 SRYL10K15XLT18/SRYL10K15XLT24 SRYL15K15XLT18/SRYL15K15XLT24 SRYL4K13XLM24 SRYL9K13XLM24 SRYL13K13XLM24	100 A	100 A
SRYL5K20XLT18/SRYL5K20XLT24 SRYL10K20XLT18/SRYL10K20XLT24 SRYL15K20XLT18/SRYL15K20XLT24 SRYL20K20XLT18/SRYL20K20XLT24 SRYL4K18XLM24 SRYL9K18XLM24 SRYL13K18XLM24 SRUL18K18XLM24	125 A	125 A

Model	Output Voltage Setting	Connection	Max. Load Power
SRYL5K15XLT18 SRYL5K15XLT24	120/208 VAC	L1-N ¹ / L2-N ¹	2.5 kW / 2.5 kVA
		L1-L2 ²	4.3 kW / 4.3 kVA
SRYL5K20XLT18 SRYL5K20XLT24	120/240 VAC	L1-N ¹ / L2-N ¹	2.5 kW / 2.5 kVA
		L1-L2 ²	5 kW / 5 kVA
SRYL10K15XLT18 SRYL10K15XLT24	120/208 VAC	L1-N ¹ / L2-N ¹	5 kW / 5 kVA
		L1-L2 ²	8.6 kW / 8.6 kVA
SRYL10K20XLT18 SRYL10K20XLT24	120/240 VAC	L1-N ¹ / L2-N ¹	5 kW / 5 kVA
		L1-L2 ²	10 kW / 10 kVA
SRYL15K15XLT18 SRYL15K15XLT24	120/208 VAC	L1-N ¹ / L2-N ¹	7.5 kW / 7.5 kVA
		L1-L2 ²	13 kW / 13 kVA
SRYL15K20XLT18 SRYL15K20XLT24	120/240 VAC	L1-N ¹ / L2-N ¹	7.5 kW / 7.5 kVA
		L1-L2 ²	15 kW / 15 kVA
SRYL20K20XLT18 SRYL20K20XLT24	120/208 VAC	L1-N ¹ / L2-N ¹	10 kW / 10 kVA
		L1-L2 ²	17.30 kW / 17.30 kVA
	120/240 VAC	L1-N ¹ / L2-N ¹	10 kW / 10 kVA
		L1-L2 ²	20 kW / 20 kVA

¹ With no load applied on L1-L2.

² With no load applied on L1-N or L2-N.

Model	Output Voltage Setting	Connection	Max. Load Power
SRYL4K13XLM24 SRYL4K18XLM24	100/200 VAC	L1-N ¹ / L2-N ¹	2.2 kW / 2.2 kVA
		L1-L2 ²	4.4 kW / 4.4 kVA
SRYL9K13XLM24 SRYL9K18XLM24	100/200 VAC	L1-N ¹ / L2-N ¹	4.4 kW / 4.4 kVA
		L1-L2 ²	8.8 kW / 8.8 kVA
SRYL13K13XLM24 SRYL13K18XLM24	100/200 VAC	L1-N ¹ / L2-N ¹	6.6 kW / 6.6 kVA
		L1-L2 ²	13.2 kW / 13.2 kVA
SRYL18K18XLM24	100/200 VAC	L1-N ¹ / L2-N ¹	8.8 kW / 8.8 kVA
		L1-L2 ²	17.6 kW / 17.6 kVA

¹ With no load applied on L1-L2.

² With no load applied on L1-N or L2-N.

Input

Input Frequency	40 to 70 Hz (Auto Sensing)
Nominal Input Voltage	<ul style="list-style-type: none"> • 100/200 VAC (180°) • 120/208 VAC (120°) • 120/240 VAC (180°)

Output

Output Frequency	<ul style="list-style-type: none"> • 50/60 Hz ± 3 Hz (Auto Sense) • 50/60 Hz ± 0.1 Hz (User Selectable) • 50/60 Hz ± 3 Hz (User Selectable)
Nominal Output Voltage	<ul style="list-style-type: none"> • 100/200 VAC (180°) • 120/208 VAC (120°) • 120/240 VAC (180°)

Wiring (Hardwire)







Input

Model	Input		
	Wire Gauge	Tightening Torque	Connection
SRYL5K15XLT18 SRYL5K15XLT24 SRYL10K15XLT18 SRYL10K15XLT24 SRYL15K15XLT18 SRYL15K15XLT24 SRYL4K13XLM24 SRYL9K13XLM24 SRYL13K13XLM24	#3 AWG		
SRYL5K20XLT18 SRYL5K20KXLT24 SRYL10K20XLT18 SRYL10K20XLT24 SRYL15K20XLT18 SRYL15K20XLT24 SRYL20K20XLT18 SRYL20K20XLT24 SRYL4K18XLM24 SRYL9K18XLM24 SRYL13K18XLM24 SRYL18K18XLM24	#1 AWG	40 in-lb (4.5 N-m)	External Circuit Breaker 4 Wire (2Ø + N + ⊕)

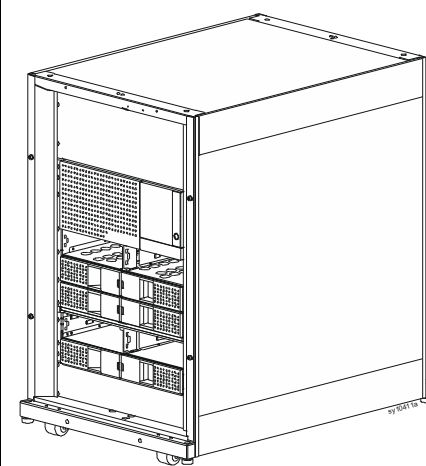
Output

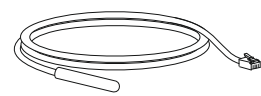
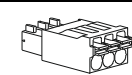
Model	Output		
	Wire Gauge	Torque	Connection
SRYL5K15XLT18 SRYL5K15XLT24 SRYL10K15XLT18 SRYL10K15XLT24 SRYL15K15XLT18 SRYL15K15XLT24 SRYL4K13XLM24 SRYL9K13XLM24 SRYL13K13XLM24	#3 AWG		
SRYL5K20XLT18 SRYL5K20KXLT24 SRYL10K20XLT18 SRYL10K20XLT24 SRYL15K20XLT18 SRYL15K20XLT24 SRYL20K20XLT18 SRYL20K20XLT24 SRYL4K18XLM24 SRYL9K18XLM24 SRYL13K18XLM24 SRYL18K18XLM24	#1 AWG	40 in-lb (4.5 N-m)	Distribution Panel 4 Wire (2Ø + N + ⊕)

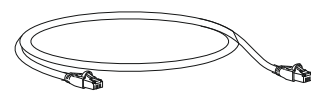
Package contents

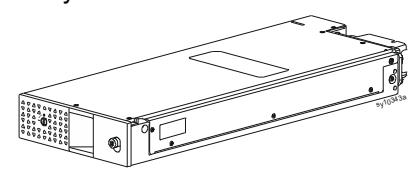
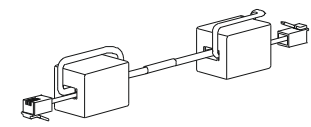
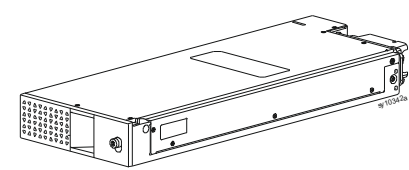
UPS frame / battery frame installed in an 18U or 24U enclosure 	Safety Guide 	APC Temperature Sensor (AP9335T) 
	Terminal block plug for MODBUS termination 	Terminal block plug for EPO termination 
	Ethernet cable - 7 ft (2134 mm) length 	CAN bus communication end termination dongle 
	Battery modules 	XBP communication cable ¹ 
	Power modules 	

¹ Supplied only with models containing Battery Frame. Refer table below for details.

Model	UPS Frame	XBP Frame	Power Modules	Battery Modules
SRYL5K15XLT18				
SRYL5K15XLT24	1	–	1	1
SRYL4K13XLM24				
SRYL10K15XLT18				
SRYL10K15XLT24	1	–	2	2
SRYL9K13XLM24				
SRYL15K15XLT18				
SRYL15K15XLT24	1	–	3	3
SRYL13K13XLM24				
SRYL5K20XLT18				
SRYL5K20XLT24	1	1	1	1
SRYL5K18XLM24				
SRYL10K20XLT18				
SRYL10K20XLT24	1	1	2	2
SRYL9K18XLM24				
SRYL15K20XLT18				
SRYL15K20XLT24	1	1	3	3
SRYL13K18XLM24				
SRYL20K20XLT18				
SRYL20K20XLT24	1	1	4	4
SRYL18K18XLM24				

NOTES:

- The numbers in the above table denote the quantity of the particular component.
- The power modules and battery modules are packaged separately.

Replacement Modules

Model	Description
SRYLBM	Replacement Battery Module
SRYLRMXBP	External Battery Pack (XBP) - Rack Mount
SRYL5KPMT	5 kVA / 5 kW Power Module - 208 VAC
SRYLIM	Intelligence Module
SRYLFSU6A	125 A, AC Tray
SRYLFSU6B	100 A, AC Tray
SRYLFSU1	SYCC - UPS Communication Card
SRYLFSU2	XRCC - XBP Communication Card
SRYLPD1	Power Distribution Unit (PDU) with 3 NEMA L5-20R outlets
SRYLPD2	PDU with 6 NEMA 5-20R outlets
SRYLPD3	PDU with 3 NEMA L5-30R outlets
SRYLPD4	PDU with 2 NEMA L14-30R outlets
SRYLPD5	PDU with 3 NEMA L6-30R outlets
SRYLPD7	PDU with 3 NEMA L6-20R outlets

Installation

Unpacking

⚠ CAUTION

RISK OF DROPPED OR FALLING EQUIPMENT

The equipment is heavy. Follow guidelines given in “Product Handling Guidelines” on page 5.

Failure to follow these instructions could result in equipment damage and minor or moderate injury.

- ❶ Cut open the shipping straps with a general-purpose knife.

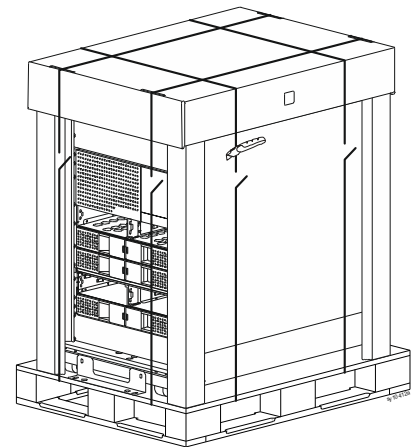

- ❷ Remove the cling wrap film.

3 Lift the top carton.

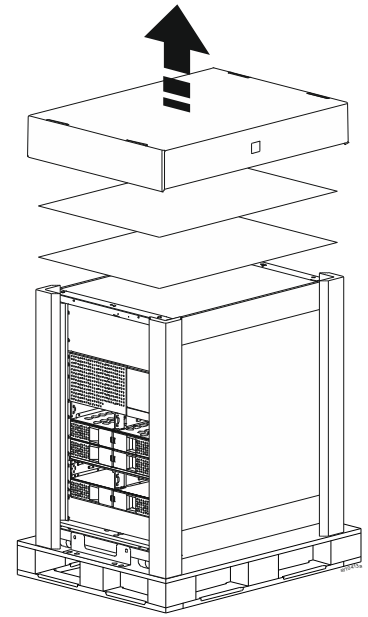

4 Remove the packaging corner posts (4x).

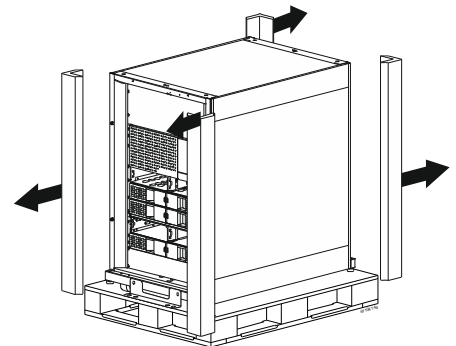

5 Lift off the polyethylene cover.

NOTE: Recycle the packaging materials or save them for reuse.

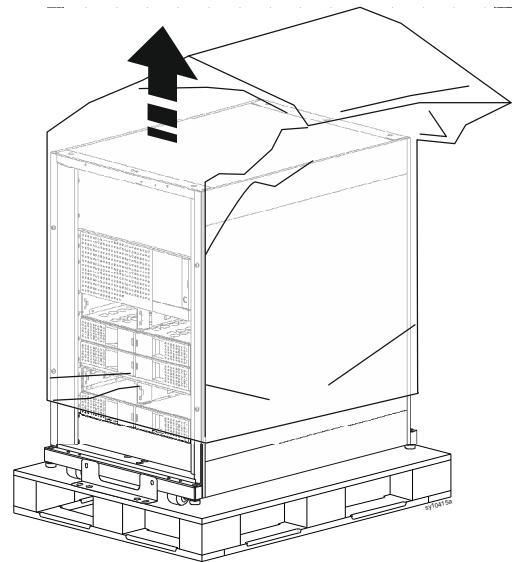

- 6** Unfasten the bolts securing the UPS to the shipping brackets at the front as well as the rear.

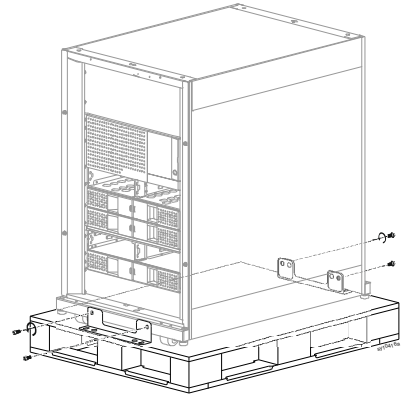

- 7** Unfasten the bolts securing the shipping bracket to the pallet at the rear.

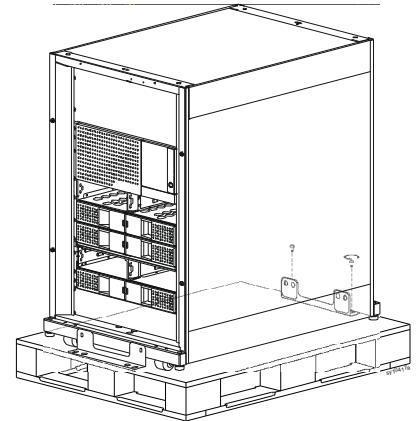

- 8** Remove the rear shipping bracket.

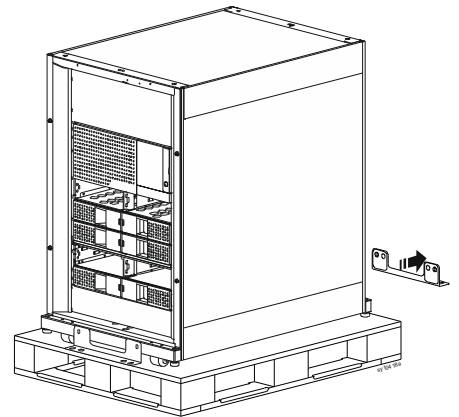

- 9** Move the UPS towards the rear of the pallet.

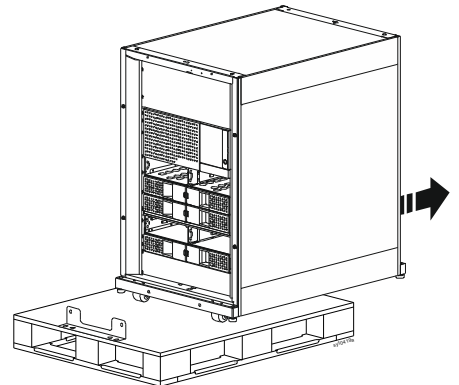

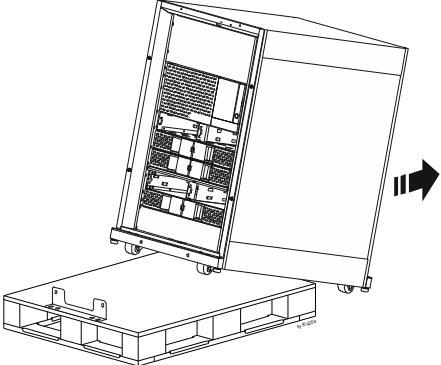
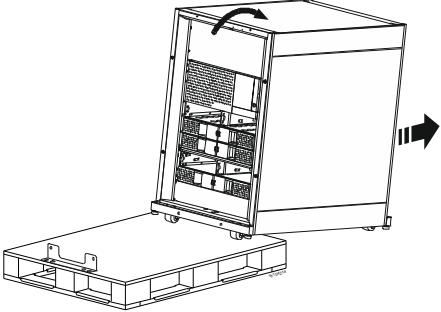
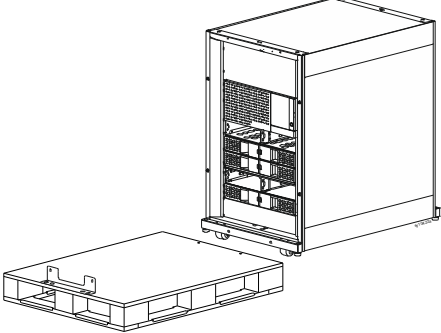
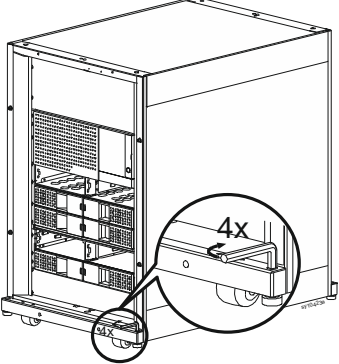
<p>10</p>	<p>Rest the rear castors on the ground and continue to move the UPS towards the rear till front castors are near the rear edge of the pallet.</p>	
<p>11</p>	<p>Tilt the UPS further so that the front castors are free from the pallet and continue to move the UPS backwards.</p>	
<p>12</p>	<p>Place the UPS on the floor.</p>	
<p>13</p>	<p>Position the UPS at the final location and lower the foot (4x) to prevent the UPS from moving.</p>	

Installing Optional Door Assembly (SRYLOPT18/SRYLOPT24)

1 Connect the hinges to the designated location using four screws..

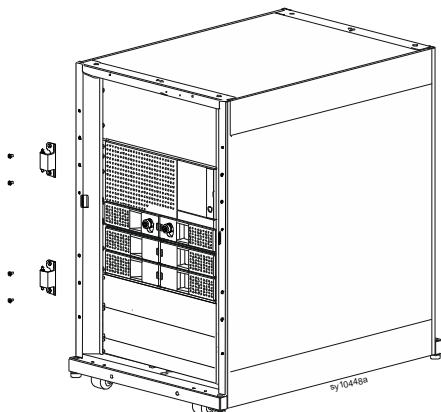

2 Install the door on the hinges, then connect the ground cable.

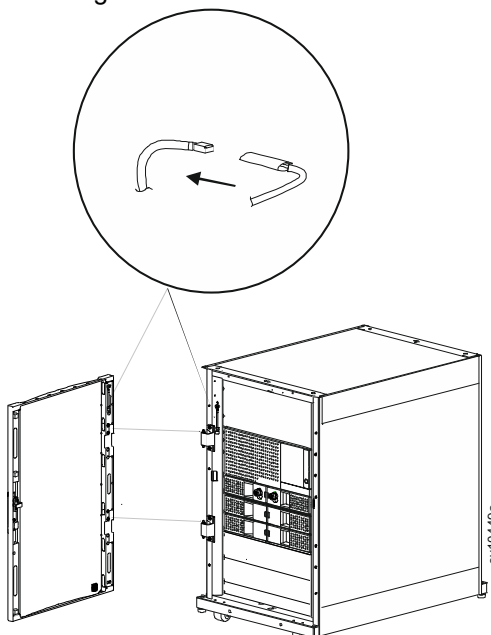

Install Power Module(s) and Battery Module(s)

NOTE: To provide clarity, the tower enclosure is not shown in the illustrations of this section.

CAUTION

RISK OF DROPPED OR FALLING EQUIPMENT

- The equipment is heavy. The approximate weight of the power module is 9.4 kg (20.72 lb) and that of the battery module is 10 kg (22 lb).
- Follow guidelines given in “Product Handling Guidelines” on page 5.
- Be sure to hold the module with both hands during installation.
- Do not use the finger hold to lift or carry the module.
- Install Power Module(s) in the UPS frame only.

Failure to follow these instructions could result in equipment damage and minor or moderate injury.

NOTE: The installation procedure is the same for both the power module and the battery module. A power module is used for illustrating the instructions.

- Power modules and battery modules can be installed in any of the 6 slots in the UPS frame.

NOTE: The UPS will recognize as many as 6 XBPs connected to the UPS. For each XBP added, recharge time will increase.

- Only battery modules can be installed in the battery frame.
- Remove the blanking panels, if required, in the UPS frame or the battery frame to install the modules. Refer “Remove Blanking Panels” on page 22 for details.

- a. Orient the module so the thumbscrew is towards the middle of the frame.
 - b. Slide in the module until the latch engages.

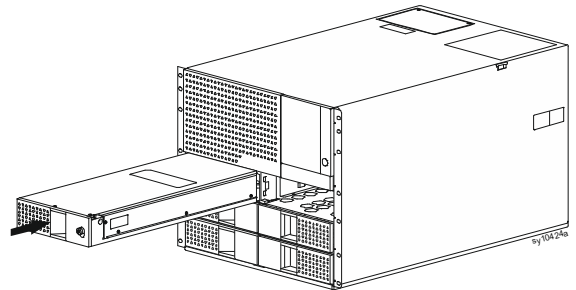

- Hand tighten the thumbscrew to enable the module and lock the latch.

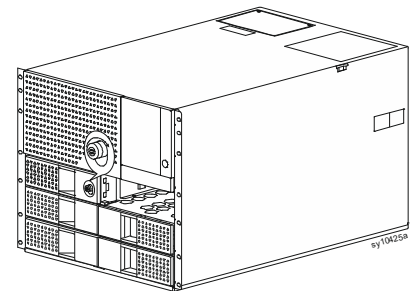

Remove Blanking Panels

NOTE: To provide clarity, the tower enclosure is not shown in the illustrations of this section.

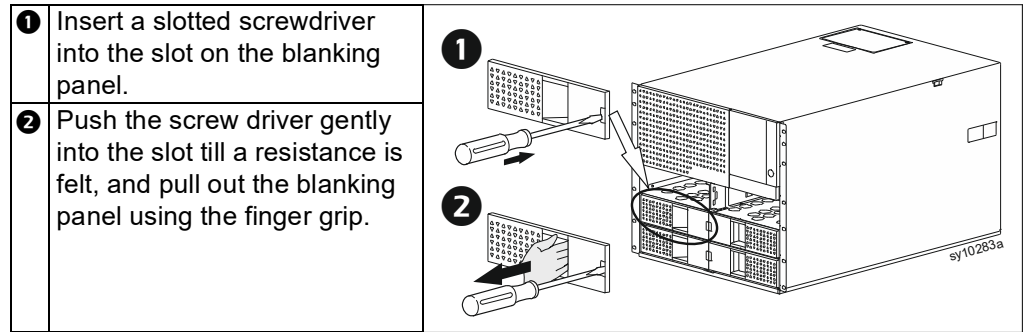

Remove Power Module and Battery Module

NOTE: To provide clarity, the tower enclosure is not shown in the illustrations of this section.

CAUTION	
<p>RISK OF DROPPED OR FALLING EQUIPMENT</p> <ul style="list-style-type: none"> • The equipment is heavy. The approximate weight of the power module is 9.4 kg (20.72 lb) and that of the battery module is 10 kg (22 lb). • Follow guidelines given in “Product Handling Guidelines” on page 5. • Be sure to hold the module with both hands during removal. • Do not use the finger hold to lift or carry the module. <p>Failure to follow these instructions could result in equipment damage and minor or moderate injury.</p>	

NOTE: The removal procedure is the same for both power module and battery module. A power module is used for illustrating the instructions except in step **1**.

NOTE: Before removing a power module, be sure that the connected load is well within the capacity of the remaining power modules. If not, disconnect some of the non-essential loads before removing a power module.

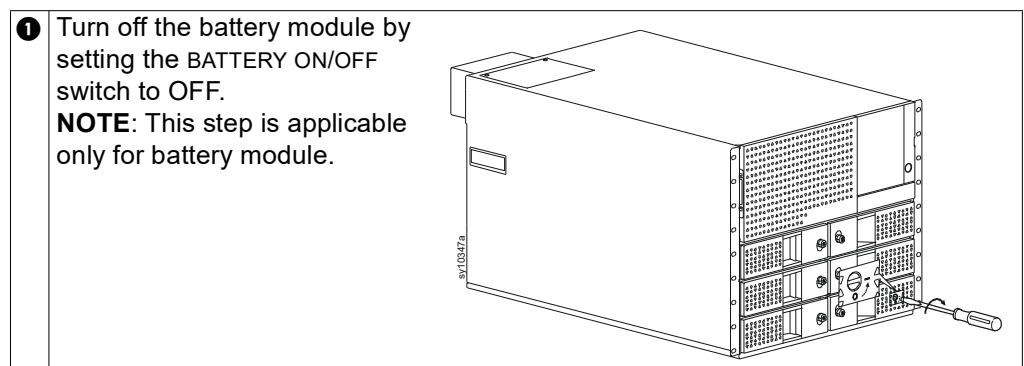

- 2 Loosen the thumbscrew to disable the module and unlock the latch.

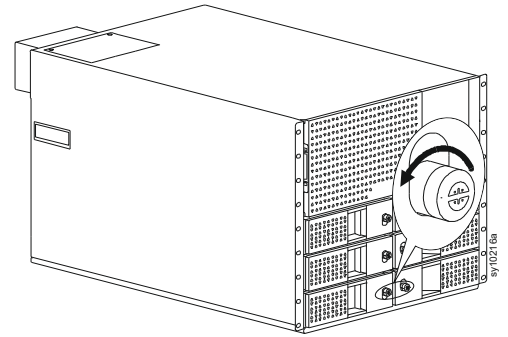

- 3 To release the latch:
- Left module: Slide the thumbscrew downwards.
 - Right module: Slide the thumbscrew upwards.

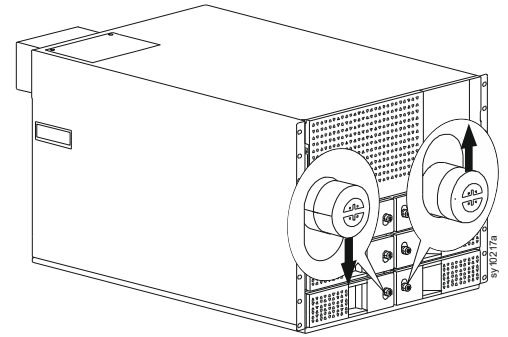

- 4
- a. Release the latch and pull the finger hold on the front face of the module until the latch clears the frame.
- NOTE:** Do not use the finger hold to pull the module completely from the frame.
- b. Support the module with both hands and pull out the module completely from the frame.

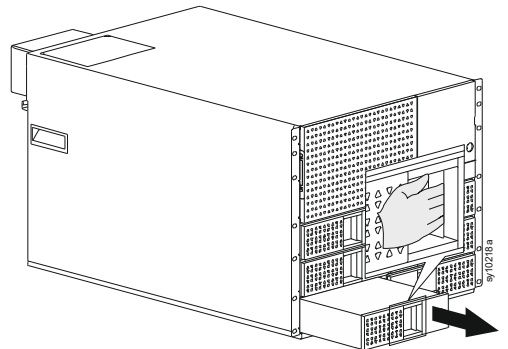

Rear Panel Features

UPS Frame

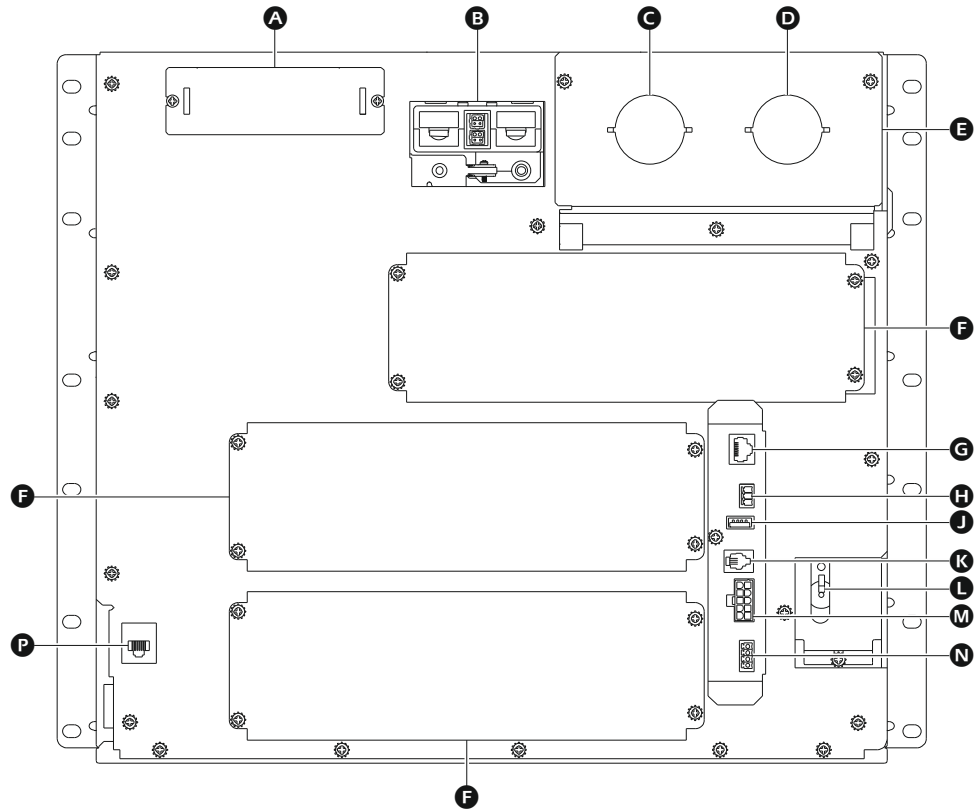

A SmartSlot	J USB port
B UPS battery connector	K XBP communication port NOTE: Insert the <i>CAN bus communication end termination dongle</i> when an XBP is not installed.
C Hardwire access (knockout) for output	
D Hardwire access (knockout) for input	
E Input/Output wiring tray	L SYSTEM ENABLE switch
F PDU cover plate	M Service bypass unit signal port
G Universal I/O port	N EPO port
H Modbus port NOTE: Terminate 150 ohm resistors (supplied) at each end of the bus when bus length is greater than 2000 ft when operating at 9600 baud or 1000 ft when operating at 19200 baud.	P Ethernet port

Battery Frame

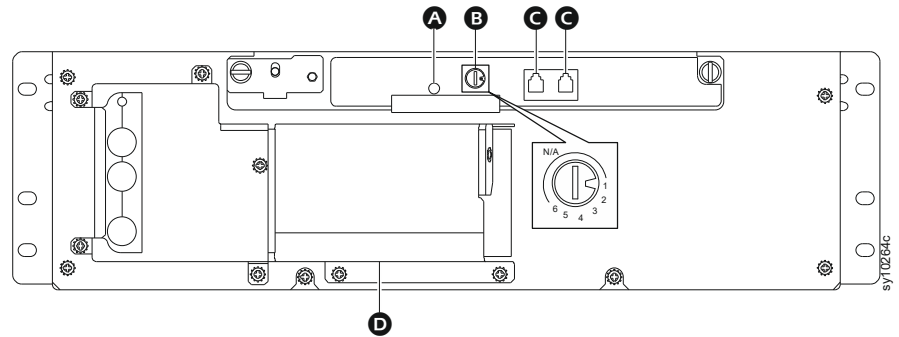

A	XBP Status LED The LED illuminates green when communication with the UPS is established. Otherwise the LED illuminates red.
B	FRAME# SETTING switch
C	Communication port
D	Battery connector

Front Panel Features

UPS

View after removing the front bezel

NOTE: **A** and **K** can be accessed only after removing the front

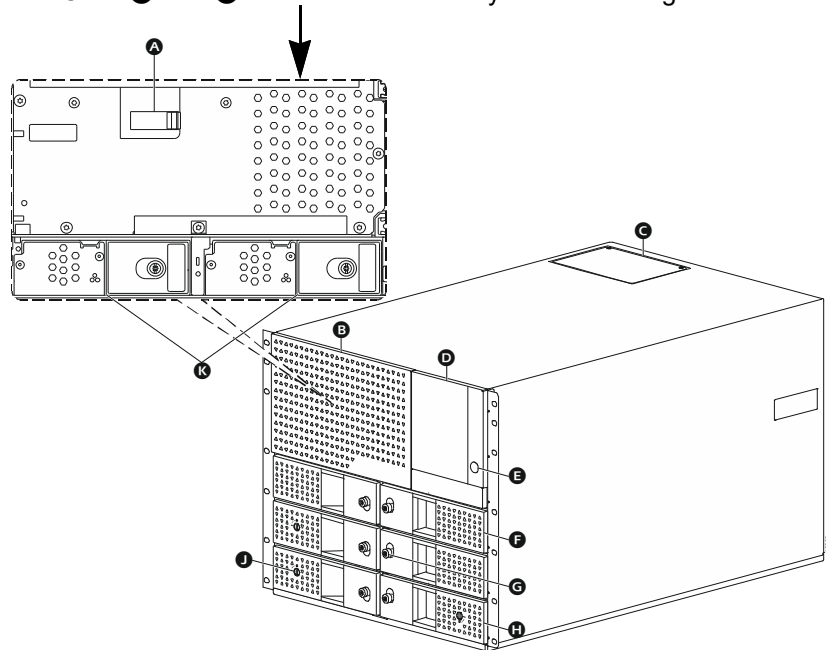

A	MANUAL BYPASS switch	F	Power module
B	Front Bezel	G	Thumbscrew
C	Hardwire terminal inspection cover	H	Battery module
D	LCD display	I	BATTERY ON/OFF switch
E	POWER ON button NOTE: refer to "Turn on without Utility Power" on page 39 for details.	J	Intelligence modules NOTE: Do not remove both Intelligence Modules from the UPS frame at the same time. The UPS will drop the connected load.
		K	

Hardwiring

NOTE: To provide clarity, the tower enclosure is not shown in the illustrations of this section.

⚠ CAUTION

RISK OF ELECTRIC SHOCK

- Hardwiring must be performed by a qualified electrician or service personnel.
- Adhere to all national and local electrical codes.

Failure to follow these instructions could result in equipment damage and minor or moderate injury.

NOTE: UPS with 125 A Input/Output wiring tray is used for illustration purposes. The instructions remain the same for UPS frame with 125 A Input/Output wiring tray and UPS with 100 A Input/Output wiring tray.

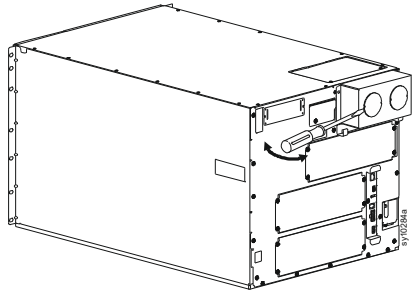
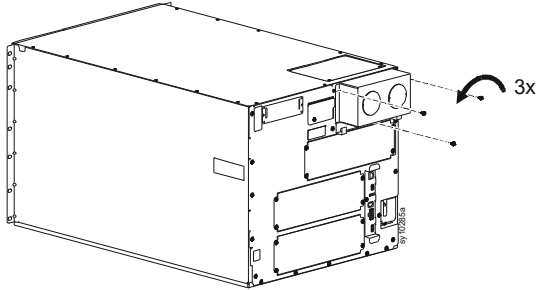
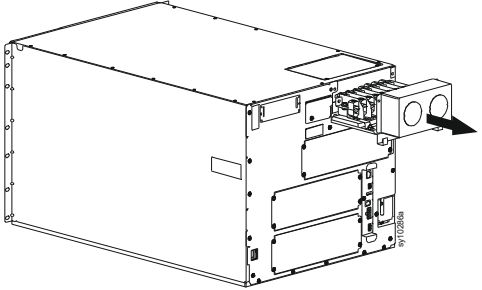
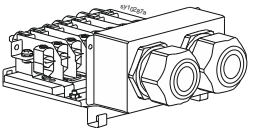
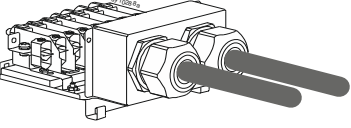
<p>1 Remove the knockouts.</p>	
<p>2 Locate the screws securing the Input/Output wiring tray to the UPS frame and unfasten them.</p> <p>NOTE: 2 screws secure the 100 A Input/Output wiring tray and 3 screws secure the 125 A Input/Output wiring tray.</p>	
<p>3 Remove the Input/Output wiring tray.</p>	
<p>4 Install appropriate strain relief (not supplied) for input power wiring and output power wiring.</p>	
<p>5 Insert the wires through the strain relief.</p>	

6 Secure the wires to the terminal block.

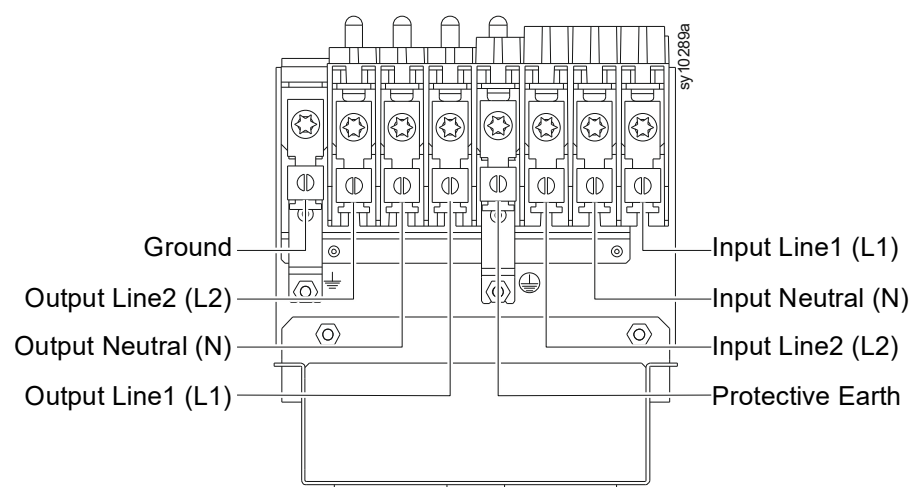

NOTE: Minimum tightening torque - 4.5 N m.

7 Install the wired Input/Output wiring tray.

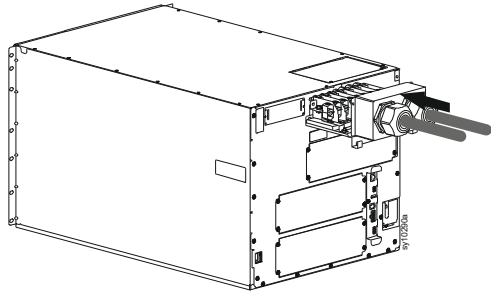

8 Secure the Input/Output wiring tray to the UPS frame using the screws removed in step **2**.

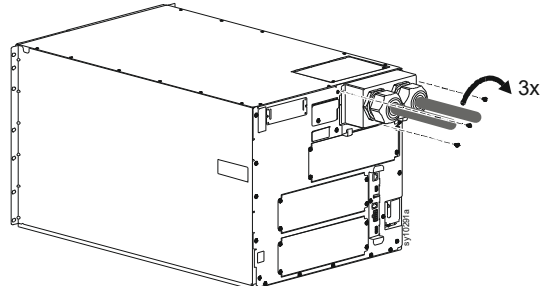

Connect Battery Frame

⚠ CAUTION

RISK OF ELECTRIC SHOCK

Battery frame installation must be performed by a qualified electrician or service personnel.

Failure to follow these instructions could result in equipment damage and minor or moderate injury.

Connect a single battery frame to UPS

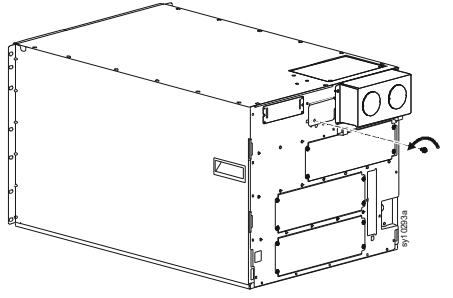
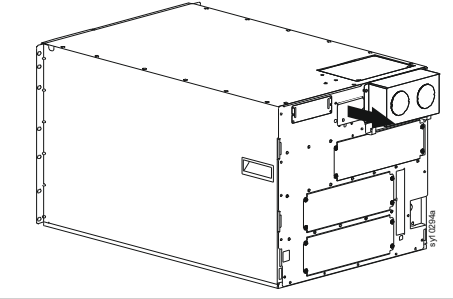
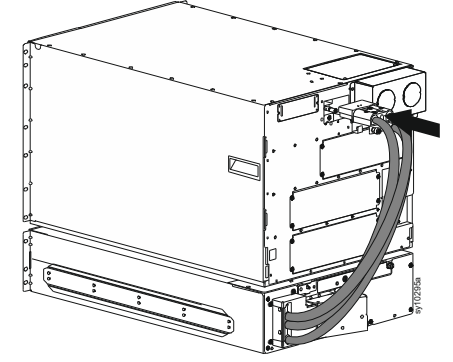
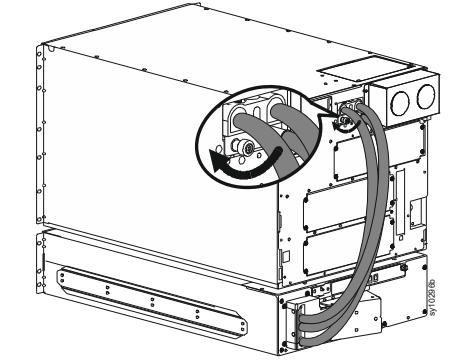
<p>1 Locate the screw securing the UPS battery connector cover to the UPS frame and unfasten it.</p>	
<p>2 Remove the UPS battery connector cover.</p>	
<p>3 Insert the XBP power cable connector into the UPS battery connector.</p>	
<p>4 Tighten the thumbscrew to secure the XBP power cable connector to the UPS battery connector.</p>	
<p>5 Set a unique identification (ID) number on the FRAME# SETTING switch (refer to “Battery Frame” on page 25 under Rear Panel Features section for identifying the FRAME# SETTING switch)).</p> <p>To identify the battery frame, the UPS will use the value on the label that the notch on the FRAME#SETTING switch points to.</p> <p>Set the Frame # setting switch so the notch points to a number from 1 to 6.</p>	
<p>6 Connect the XBP communication cable between the XBP communication port on the UPS frame and the communication port on the battery frame.</p>	
<p>7 Connect the CAN bus communication end termination dongle to the free communication port on the battery frame.</p>	

Connect multiple battery frames to UPS

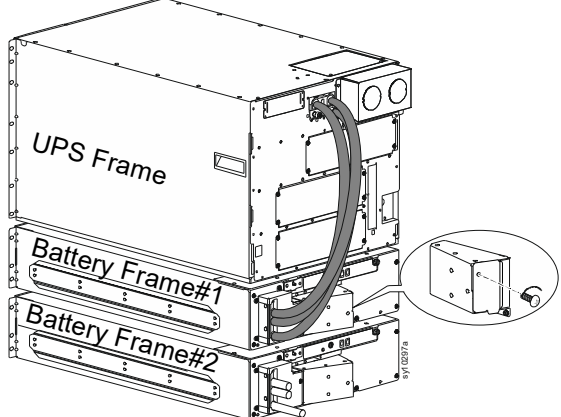
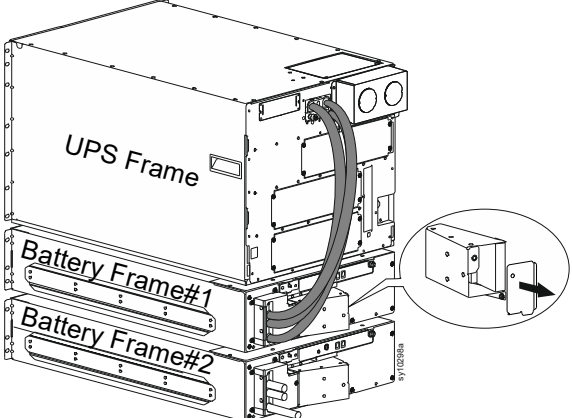
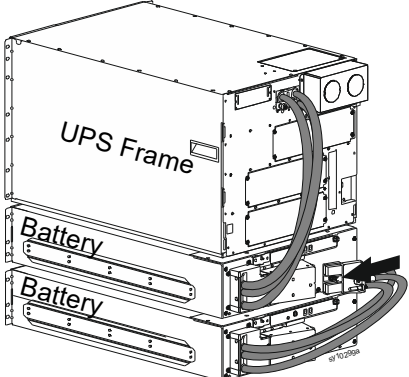
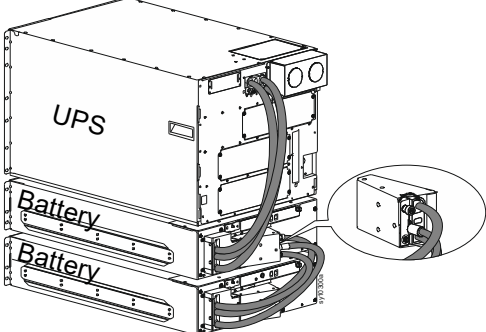
<p>1</p>	<p>Follow steps 1 to 6 in “Connect a single battery frame to UPS” on page 28 to connect the first battery frame to the UPS.</p> <p>A maximum of 6 battery frames can be attached to the UPS.</p>
<p>2</p>	<p>Locate the screw securing the battery connector cover to the battery frame (Battery Frame#1) and unfasten it.</p> 
<p>3</p>	<p>Remove the battery connector cover in Battery Frame#1.</p> 
<p>4</p>	<p>Insert the XBP power cable connector of battery frame#2 into the battery connector in Battery Frame#1.</p> 
<p>5</p>	<p>Tighten the thumbscrew to secure the XBP power cable connector of Battery Frame#2 to the battery connector in Battery Frame#1.</p> 

6	<p>Set a unique identification (ID) number on each Battery Frame connected on the FRAME# SETTING switch (refer “Battery Frame” on page 25 under Rear Panel Features section for identifying the FRAME# SETTING switch).</p> <p>The number (ID) that the notch on the FRAME# SETTING switch points to on the label will be the value used by the UPS to identify the battery frame.</p> <p>Set the FRAME# SETTING switch on each battery frame to a unique number.</p> <p>If the same number is used for multiple battery frames, the UPS will alert the user there is a conflict.</p>
7	<p>Connect the communication cable between the free communication ports on Battery Frame#1 and Battery Frame#2.</p>
8	<p>Connect the CAN bus communication end termination dongle to the free communication port on the Battery Frame#2.</p> <p>NOTE: The CAN bus communication end termination dongle should be connected to the free communication port on the last Battery Frame connected.</p>

Battery Cable Extension

A battery cable extension (SRYLOPT8) is available as an accessory (separate purchase) to connect battery frames to the UPS frame (or another battery frame) housed in different enclosures. The extension cable is 8 ft (2.43 m) long.

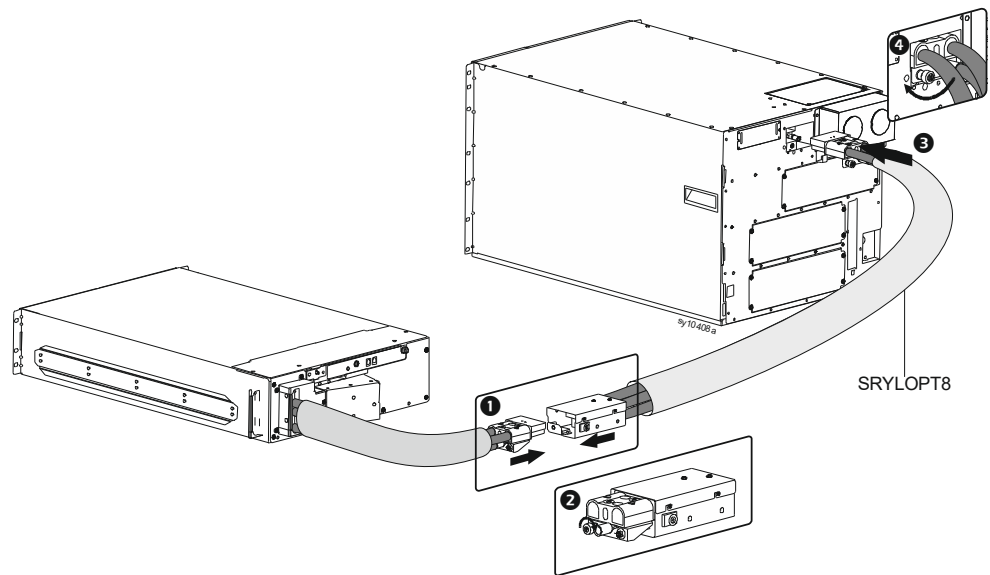

1	<p>Insert the XBP power cable connector into the battery connector in the battery cable extension (SRYLOPT8).</p>
2	<p>Tighten the thumbscrew to secure the XBP power cable connector to the battery connector in the battery cable extension.</p>
3	<p>Insert the power cable connector in the battery extension cable into the UPS battery connector.</p>
4	<p>Tighten the thumbscrew to secure the battery extension cable connector to the UPS battery connector.</p>
5	<p>Connect the XBP communication cable (supplied along with the battery cable extension) between the XBP communication port on the UPS frame and the communication port on the battery frame.</p>
6	<p>Connect the CAN bus communication end termination dongle to the free communication port on the last Battery Frame connected.</p>

Redundancy Configuration

The UPS frame has 6 universal slots that can accept power modules or battery modules. The XBP frame has 4 slots that accept only battery modules.

Redundancy reported by the Smart-UPS Modular Ultra system refers to the power module redundancy. Redundancy depends on the load power and the number of power modules installed.

Standard models are configured for N+0 redundancy at a specific load power.

If N+1 redundancy is required at that power level, an additional power module must be installed.

If N+2 redundancy is required, a second additional power module must be installed.

Another way to increase redundancy is to lower the load power.

The table below lists the minimum number of power modules required for the available redundancy alarm settings. For some configurations, an XBP frame must be added.

NOTE: If the load is low and the number of power modules is high, the system can report the current redundancy (refer to “UPS Menu Overview” on page 45) as greater than N+2.

Model	Load	Desired power module redundancy alarm level												
		N+0 / Never (as shipped)				N+1					N+2			
		UPS Frm	XBP Frm	PM	BM ¹	UPS Frm	XBP Frm	PM	BM ¹	Or lower load to	UPS Frm	XBP Frm	PM	BM ¹
SRYL5K15XLT18 SRYL5K15XLT24 SRYL5K20XLT18 SRYL5K20XLT24 SRYL4K13XLM24 SRYL4K18XLM24	Upto 2.5 kW per phase ²	1	–	1	1	1	–	2	1	–	1	–	3	1
SRYL10K15XLT18 SRYL10K15XLT24 SRYL10K20XLT18 SRYL10K20XLT24 SRYL9K13XLM24 SRYL9K18XLM24	Upto 5.0 kW per phase ²	1	–	2	2	1	–	3	2	< 2.5 kW per phase ²	1	–	4	2
SRYL15K15XLT18 SRYL15K15XLT24 SRYL15K20XLT18 SRYL15K20XLT24 SRYL13K13XLM24 SRYL13K18XLM24	Upto 7.5 kW per phase ²	1	–	3	3	1	1	4	3	< 5.0 kW per phase ²	1	1	5	3
SRYL20K20XLT18 SRYL20K20XLT24 SRYL18K18XLM24	Upto 10.0 kW per phase ²	1	1	4	4	1	1	5	4	< 7.5 kW per phase ²	1	1	6	4

¹ The number of battery modules does not affect the redundancy warning or the current redundancy reported. The number of battery modules required is based on the total load. Each battery can support 5 kW.

It is strongly recommended that the system have 1 battery module per power module for matched redundancy.

² Loading from L1 or L2 to Neutral; when output voltage is set to 100/200 V, the maximum load on a single power module is 2.3 kW per phase. All other values would be adjusted accordingly.

Abbreviations used in the table above

UPS Frm = UPS Frame

XBP Frm = XBP Frame

PM = Power Module

BM = Battery Module

Operation

Modes

On-line

The UPS supplies conditioned utility power to the connected equipment.

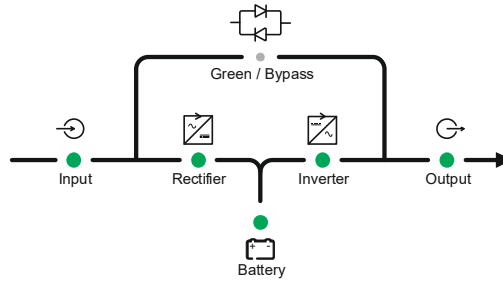

NOTE: The UPS will operate on-line when the load on the UPS is 100%, the input voltage is 95 to 150 V, and green mode is disabled.

On-battery

The UPS supplies conditioned battery power to the connected equipment.

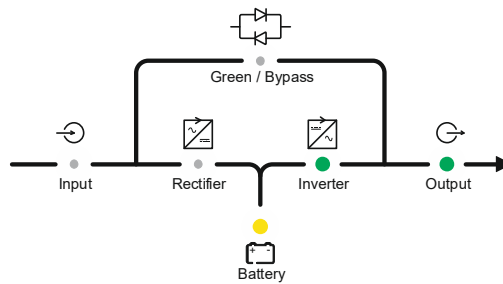

Green

The UPS supplies utility power directly (without conditioning) to the connected equipment.

In the event of a brown-out or a black-out the system switches to On-line mode or On-battery mode.

When enabling Green mode, consideration should be given to devices that may be highly sensitive to power fluctuations.

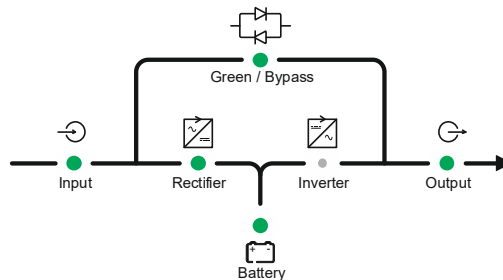

Bypass Mode

In Bypass mode, unconditioned utility power is directly supplied to the connected equipment.

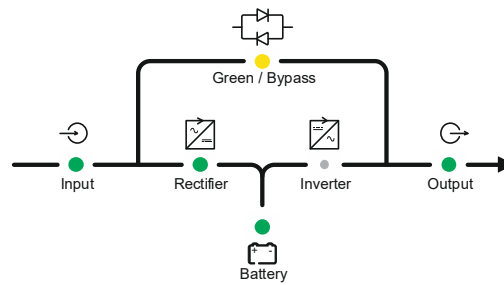

Temporary Bypass

When a temporary phenomenon, like the connected load being greater than the UPS rating but lesser than the utility power circuit breaker rating, the UPS goes into temporary bypass. The UPS comes back to on-line or on-battery mode automatically once the temporary phenomenon gets corrected, like non-essential loads being disconnected from the UPS. The UPS will not transfer to on-battery mode until the temporary phenomenon is corrected.

When the UPS is operating in this mode, the UPS status information will change to “Temp Bypass”.

Software Bypass

The user can intentionally command the UPS to operate in bypass mode through the LCD display (Home → Control → UPS → Put UPS in Bypass).

The UPS will operate in this mode as long as the utility power voltage is within the configured upper and lower voltage limits.

Refer to “Bypass” on page 52 for details.

The UPS will transfer to on-battery mode if the utility power voltage is not within the configured limit or in the event of a black out.

When the UPS is operating in this mode, the UPS status information will change to “Software Bypass”.

Manual Bypass

To go into this mode, set the MANUAL BYPASS switch to ON. The UPS transfers to internal maintenance bypass operation.

Refer to “Set the UPS to Manual Bypass Mode” on page 35 for instructions to set the UPS to this mode.

The UPS will operate in this mode as long as the MANUAL BYPASS switch is set to ON. To get the UPS back to on-line or on-battery mode, set the MANUAL BYPASS switch to OFF.

The UPS will not transfer to on-battery mode till the MANUAL BYPASS switch is set to OFF.

When the UPS is operating in this mode, the UPS status information will change to “Manual Bypass”.

Event Bypass

The UPS goes into Event Bypass and supplies unconditioned utility power directly to the connected equipment when the PMs cannot support the connected load.

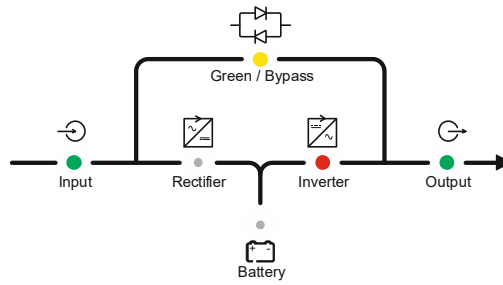

When the UPS transfers to this mode, the UPS status information will change to "Fault Bypass".

Contact customer support when the UPS transfers to this mode.

Standby Mode with AC Present

In this mode, the output is turned off and the internal systems and the battery charger are powered by the utility power.

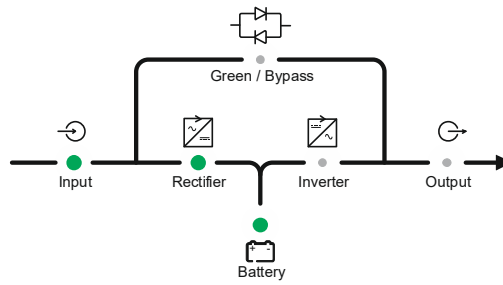

Standby Mode with AC Not Present

In this mode, the output is turned off and the internal systems are powered by the battery.

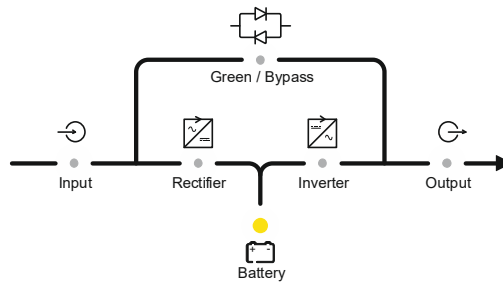

System Alarm

In this mode, the UPS output is turned off and the internal systems are powered by the battery, irrespective of whether utility power is available or not. Contact customer support to resolve the detected error.

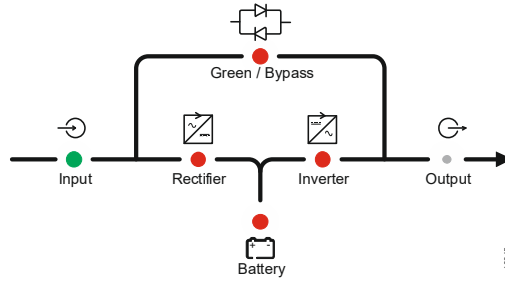

When the UPS goes into this mode, the LCD display screen will be illuminated red.

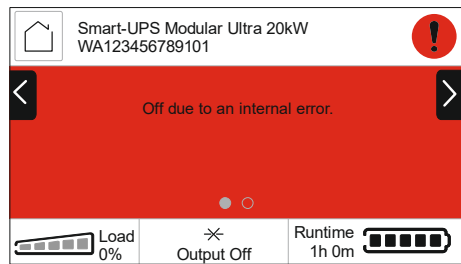

Set the UPS to Manual Bypass Mode



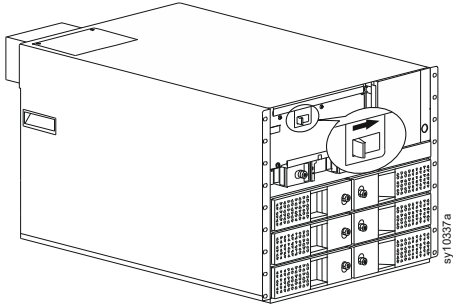



<p>1 Command the UPS to operate in bypass mode (command bypass) through the LCD display (Home → Control → UPS → Put UPS in Bypass).</p>	
<p>2 Open the front bezel.</p>	
<p>3 Remove the front bezel from its housing.</p>	

4	Set the MANUAL BYPASS switch to ON position.	
5	The LCD display will show an alert notification that the UPS is in Manual bypass mode.	

Set the MANUAL BYPASS switch to OFF to bring the UPS out of the manual bypass mode.

The UPS goes into temporary bypass mode for a short time and then returns to the state in which it was operating prior to setting it to manual bypass mode.

One Line Diagram Status Indicators

Function		LED Illumination	Description
	Input	● Green	Utility power is present and is within normal operating range.
		● Amber	Utility power is present but is outside normal operating range.
		● Not illuminated	Utility power is not present.
	Rectifier	● Green	Rectifier circuit is active.
		● Red	Rectifier circuit is not available.
		● Not illuminated	Rectifier circuit is not active.
	Bypass	● Green	Green function is active.
		● Red	Bypass function is not available.
		● Amber	Bypass function is active and the connected load is not protected from power outage and disturbance.
		● Not illuminated	Bypass or Green function is not active.
	Battery	● Green	Battery is available and is fully charged or charging.
		● Red	Battery is not available (disconnected or bad).
		● Amber	Battery is discharging.
		● Not illuminated	Battery is available but neither charging nor discharging.
	Inverter	● Green	Inverter circuit is active.
		● Red	Inverter circuit is not available.
		● Not illuminated	Inverter circuit is not active.
	Output	● Green	Power is being supplied to the connected load from the UPS.
		● Not illuminated	Output voltage is not available.

Status LEDs

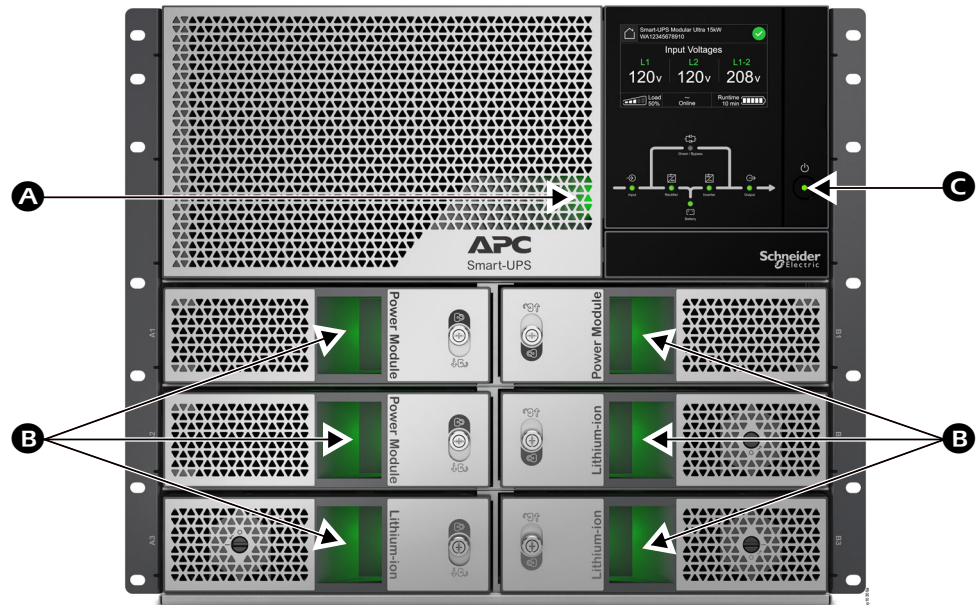

A	System Status LED
B	Module Status LEDs
C	Power ON button LED

Status LED Color	Status
System Status - (behind the bezel) reflects system status and matches the background color of the LCD display.	
Not illuminated	UPS is not powered on.
Illuminates Green	UPS is operating normally.
Illuminates Amber	UPS is experiencing an alarm condition or operating on battery.
Illuminates Red	UPS has detected an internal error.
Module Status represents the status of battery/power module. Check LCD display for details.	
Not illuminated	Module is not powered.
Blinks Green	Status LEDs blink every second when power module is in standby state. NOTE: This is applicable only for power module.
Illuminates Green	Module is operating normally.
Illuminates Amber	Module is operating but an alarm condition exists. (On-battery state is also an alarm since the battery is discharging.)
Illuminates Red	Module not available due to a detected internal error.
Power ON button LED.	
Not illuminated	UPS output is OFF.
Illuminates Green	UPS output is ON.

Start Up

CAUTION

RISK OF ELECTRIC SHOCK

- Set the utility power circuit breaker to OFF before installing or servicing the UPS.
- Disconnect BMs and XBPs before installing or servicing the UPS.
- The UPS contains BMs and XBPs that may present a shock hazard even when disconnected from the utility power.
- UPS AC hardwired and pluggable outlets may be energized by remote or automatic control at any time.
- Disconnect equipment from the UPS before servicing any equipment.
- Do not use the UPS as a safety disconnect.
- Use strain reliefs.
- Recommended input terminal screw torque: 40 lbf-in (4.5 Nm).

Failure to follow these instructions can result in equipment damage and minor or moderate injury.

NOTE: The UPS batteries will charge to 90% capacity in the first three hours of normal operation. **Do not expect full battery runtime capability during this initial charge period.**

1. Hardwire the equipment to the Output Hardwire terminals in the UPS or connect the equipment to the outlets on the rear panel of the UPS, if PDUs are installed.
2. Set the BATTERY ON/OFF switch (located on the front panel of the battery module(s)) to ON.
3. Connect the UPS to the building utility power.
4. Be sure that the SYSTEM ENABLE switch located on the rear panel of the UPS is set to ON.

Turn on / Turn off the UPS

The first time the UPS is turned on, the Setup Wizard screen will run. Follow the on-screen prompts to configure UPS settings. Refer to “UPS Menu Overview” on page 45 for details on individual settings.

Turn on

UPS goes to standby mode when utility voltage is applied at the AC input terminals. The LCD display illuminates and displays an *Initializing* screen, indicating that the system is getting initialized. This process takes approximately 1 minute. After successful initialization, user menus will be available on the LCD display.

To turn on the UPS output and supply power to the connected equipment:

1. Touch the HOME icon on the LCD display to access the Main menu.
2. Touch the Control option.
3. Touch the UPS option.
4. Touch Turn UPS on.
To turn on the UPS output immediately enable Skip UPS On Delay. To turn on the UPS output after the configured time delay, disable Skip UPS On Delay.
5. Touch the OK button.
6. Output will turn on.

Turn on without Utility Power

UPS can be turned on without the building utility power, through cold start.

To cold start the UPS, press the POWER ON button. Refer to “Front Panel Features” on page 25 for locating the POWER ON button.

This powers on the battery module(s) and wakes up the UPS. LCD display will turn on, displaying an *Initializing* screen, indicating that the system is getting initialized. This process takes approximately 1 minute. After successful initialization, user menus will be available on the LCD display.

To turn the output on and supply power to connected load:

1. Touch the HOME icon on the LCD display to access the Main menu.
2. Touch the Control option.
3. Touch the UPS option.
4. Touch the Turn UPS On without AC
5. Touch the OK button.
6. Output will turn on.

Turn off

To turn off the output power:

1. Touch the HOME icon on the LCD display.
2. Touch the Control option.
3. Touch the UPS option.
4. Touch Turn UPS off.
To turn off the UPS output immediately, enable Skip UPS Off Delay. To turn off the UPS output after the configured time delay, disable Skip UPS Off Delay.
5. Touch the OK button.

The UPS will continue to operate in standby mode, even after the output is turned off.

To completely turn off the UPS, disconnect the UPS from the utility power. The UPS will now continue to operate in standby mode, on battery power for approximately Ten (10) minutes, or until the battery charge gets depleted completely, whichever is earlier.

To completely turn off the UPS before the 10 minute timer expires:

1. Touch the HOME icon.
2. Touch the Control option.
3. Touch the UPS option.
4. Touch the Internal Power Off option.
5. Touch the OK button.

The UPS will turn off completely.

Total power off

The SYSTEM ENABLE switch controls the internal power for all the modules (intelligence, power, and battery). Setting the switch to STANDBY  disables the power. Setting the switch to ON allows the modules to turn ON.

To completely power down the system:

1. Set SYSTEM ENABLE switch to STANDBY .
2. Set Mains/Branch circuit breaker to OFF.
3. Disconnect internal battery modules
4. Disconnect external battery frames (if installed).
5. Disconnect maintenance bypass source (if provided).

LCD Display

NOTE: The LCD display screens may differ slightly on your unit.

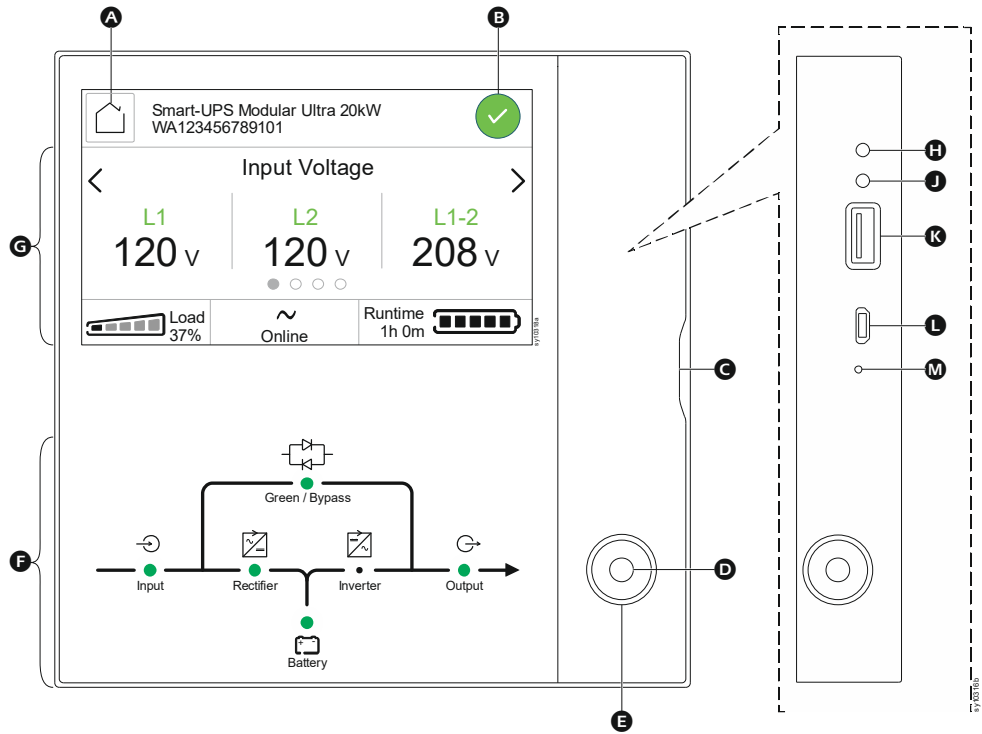

A HOME icon	Refer to “ UPS Network Management Card 3 - User Guide ”, for details of the below features,
B NOTIFICATION icon	
C Access door to front ports - H , J , K , L , and M	H Status LED
	J Link RX/TX (10/100/1000) LED
D Output status LED	K USB port
E POWER ON button	L Console port
F One line diagram	M RESET button
G UPS status screen	

Operating the LCD Display

- The LCD display is a touchscreen interface.
- Touch an icon to activate the button.

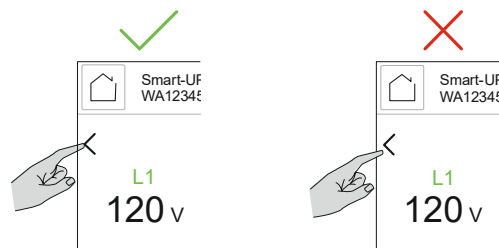

- Use the “<” and “>” to scroll through the screens and “^” and “v” to scroll through the options.
- A keypad will pop-up to update fields that require values to be entered.

- Touch the OK button to accept the selected option.
- **NOTE:** The OK button gets enabled only when a setting is changed. Otherwise, the button will be in disabled state.
- Touch the ESC button to return to the previous menu or
- Select the menu option you would like to return to.

NOTE: Use a dry microfiber (non-abrasive) cloth to clean the LCD display.

UPS Status Screen (Home Screen)

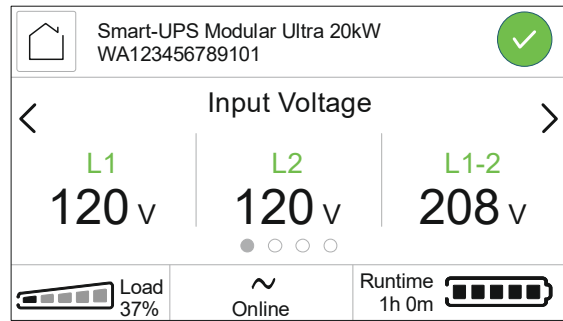

The status screen field provides key information on the UPS.

The menu will scroll through four screens automatically:

- Input Voltages
- Output Voltages
- Input/Output Frequency
- Output Power

The bottom of each screen will display the percentage of rated load the UPS is powering, the operating mode of the UPS, and the remaining runtime on battery.

In case of an UPS event, status updates will be displayed, defining the event or the condition that has occurred. The LCD display screen illuminates amber to indicate an alert and red to indicate an alarm depending on the severity of the event or condition.

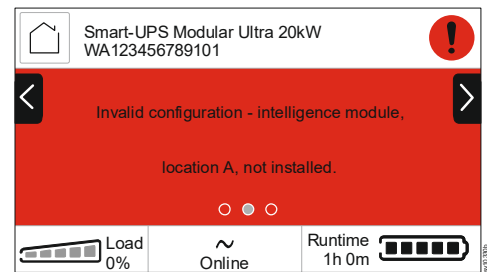
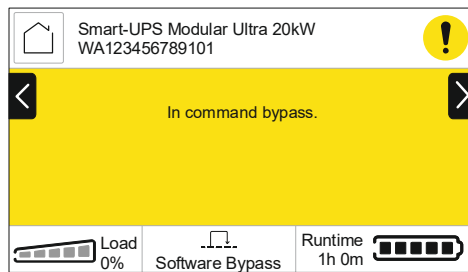

Typical Alert/Notification/Alarm Screens

On-battery alert

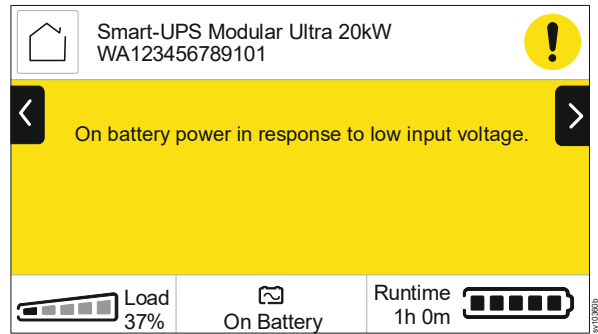

On-battery alert
(Home Screen - page 1)

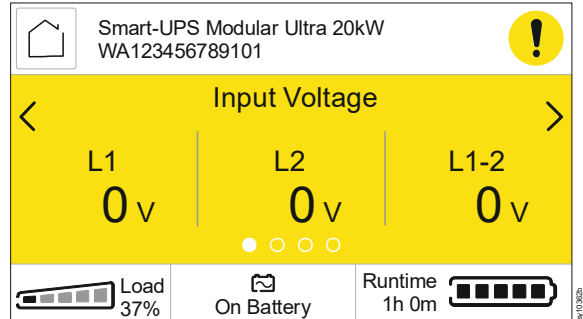

Output Off information
(Home Screen - page 2)

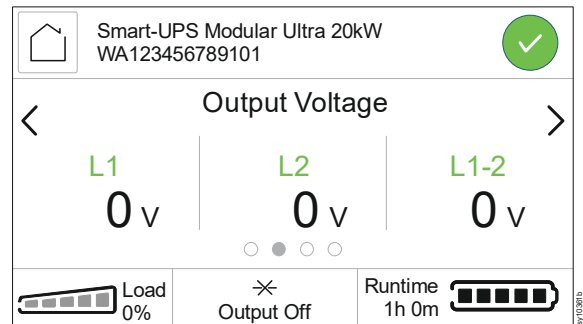

Low battery alarm (page 1)

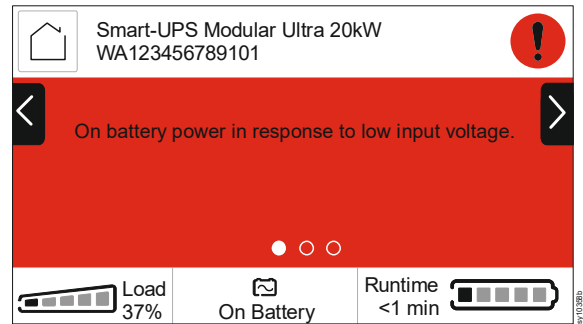

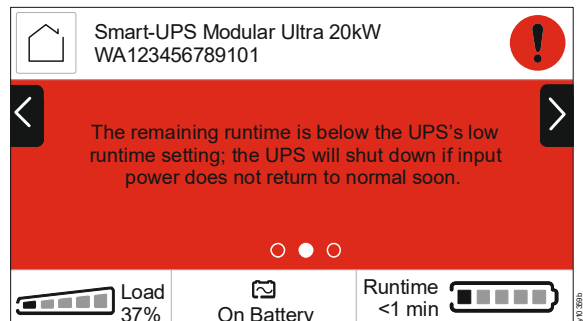

Low battery alarm (page 2)







Icons





The icons on the LCD display screen may vary depending on the installed firmware version.

	<p>Load icon: The approximate load capacity percentage is indicated by the number of illuminated load bar sections. Each bar represents approximately 20% of the load capacity.</p>
	<p>Home icon:</p> <ul style="list-style-type: none"> • Touch this icon on any screen to return to the Home screen. • Touch this icon, on the Home screen, to activate the Main Menu screen.

Operation Mode

	<p>On-Line mode: The UPS is supplying conditioned utility power to connected equipment.</p>
	<p>Bypass mode: In Bypass mode, unconditioned utility power is directly supplied to the connected equipment.</p>
	<p>Green mode: In Green mode, the UPS will supply conditioned utility power to the connected equipment.</p> <p>In the event of a utility power outage or brown out, there will be an interruption in power to the connected equipment (up to 10 ms) while the UPS switches to On-Line mode or Battery mode.</p> <p>When enabling Green mode, consideration should be given to devices that may be sensitive to power fluctuations.</p>
	<p>Battery mode: The UPS is supplying battery power to connected equipment.</p>
	<p>UPS output off: The UPS is not supplying power to the connected equipment.</p>

Notification

	<p>Normal: UPS is functioning normally and no alarms or events exist.</p>
	<p>Information: UPS status information is available.</p>
	<p>Alert: UPS has detected an alert condition.</p>
	<p>Alarm: UPS has detected an alarm condition.</p>

Battery Status Icon

	<p>Battery Charge Status: Indicates the battery charge status. Each illuminated bar represents approximately 20% charge.</p>
---	---

Main Menu Screen

Touch the HOME icon, on the Home Screen, to activate the Menu screen.

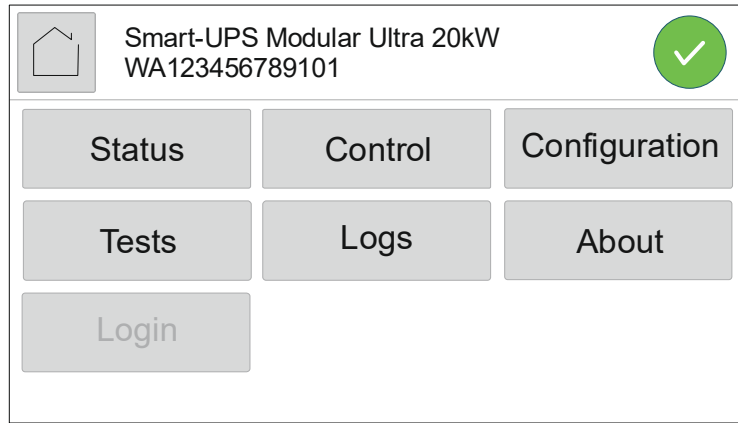

UPS Menu Overview

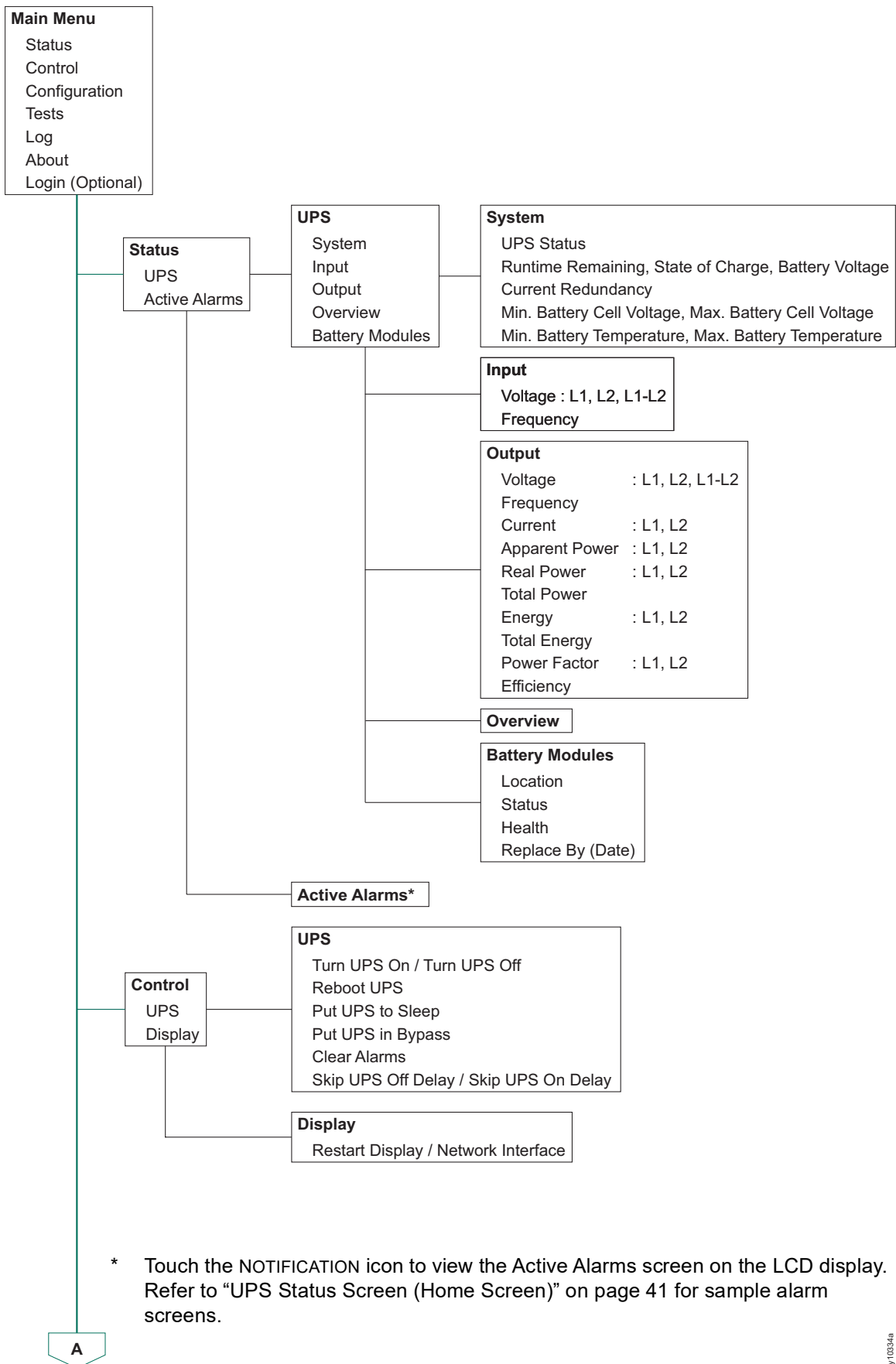

by 10334a

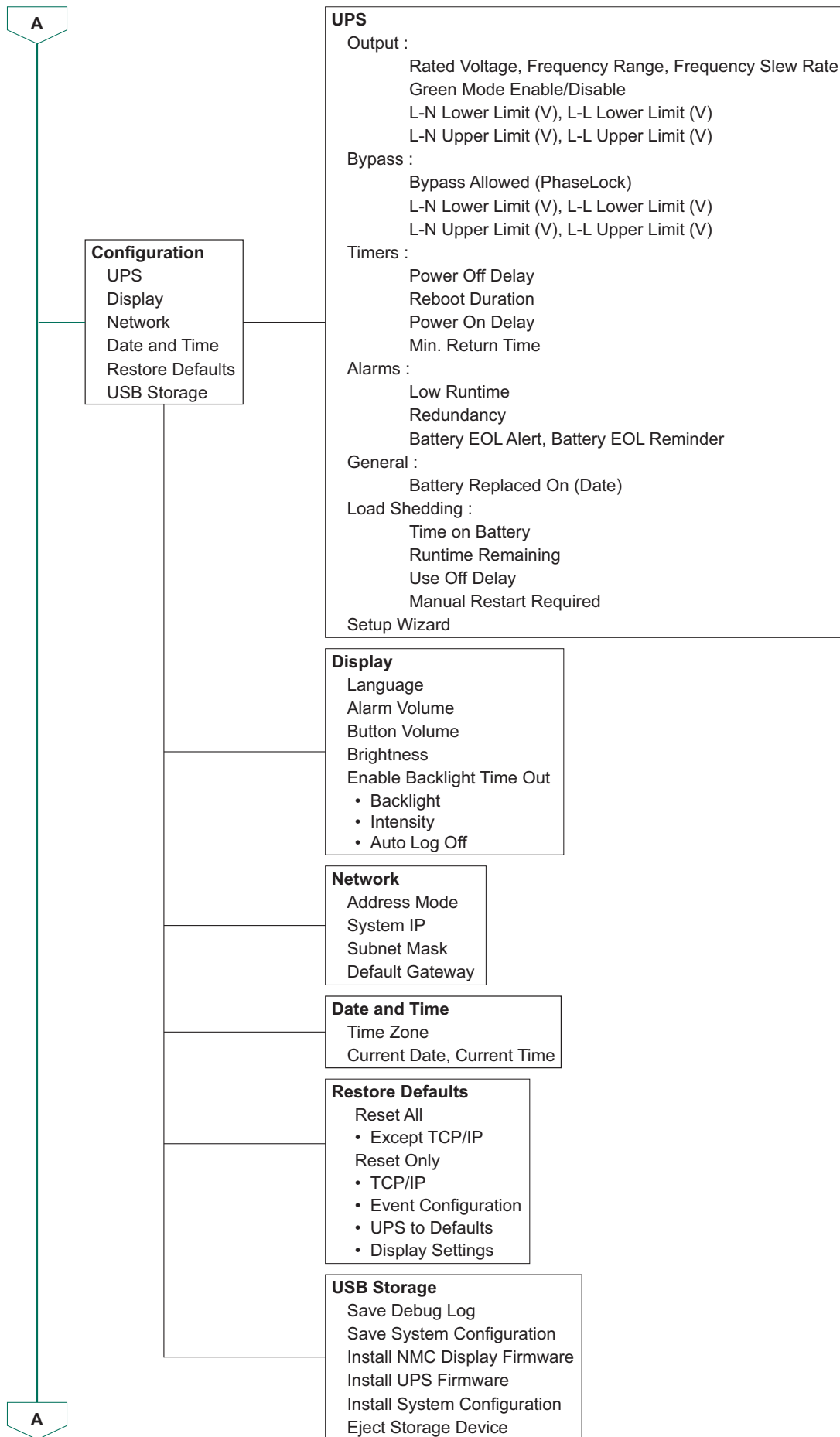

8Y10335a

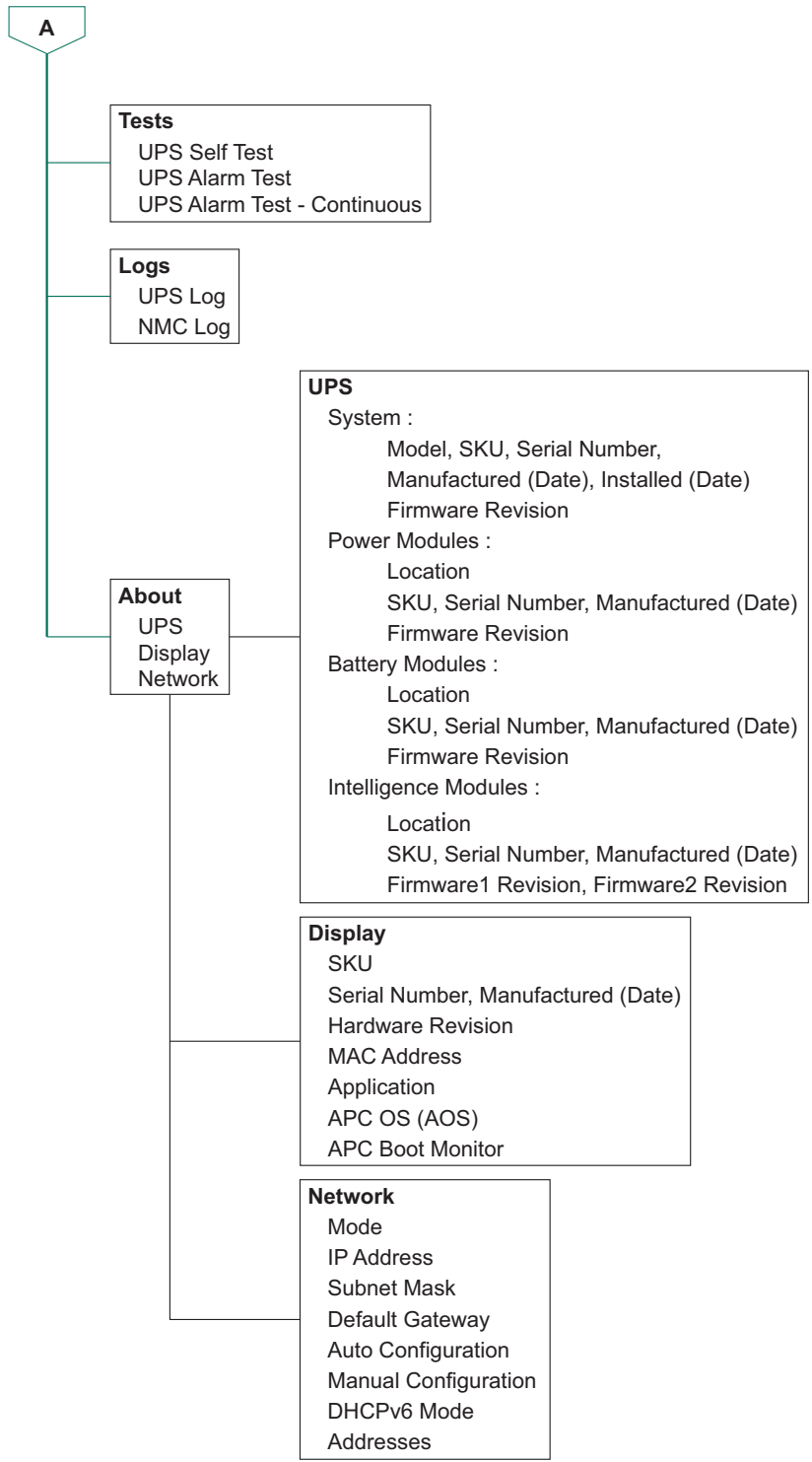

NOTE: Unless the User Mode is set to Locked (read only), the login credentials are required to access the NMC log from the display. In the Locked mode, the access is prohibited.

sy10336c

Configuration

There are three ways to select UPS configuration options.

1. The first time the UPS is turned on, the Setup Wizard screen will open. On each menu screen select the desired settings. Touch the OK button after selecting each setting.
The UPS will not turn on until the setup is completed.
2. Main Menu → Configuration → Restore Defaults. This screen allows the user to reset the UPS to factory (default) settings. Touch the OK button after selecting the UPS setting.
Refer to “UPS Menu Overview” on page 45 for details.
3. Configure settings using an external interface, such as the Network Management Web interface.

Startup configuration

NOTE: The configuration menu options vary according to the UPS models.

1. Set the language of LCD display

Options:

- English
- French
- Italian
- German
- Spanish
- Portuguese
- Japanese
- Russian
- Chinese
- Korean



2. Set Output Voltage

Options:

- 120/208 VAC
- 120/240 VAC
- 100/200 VAC

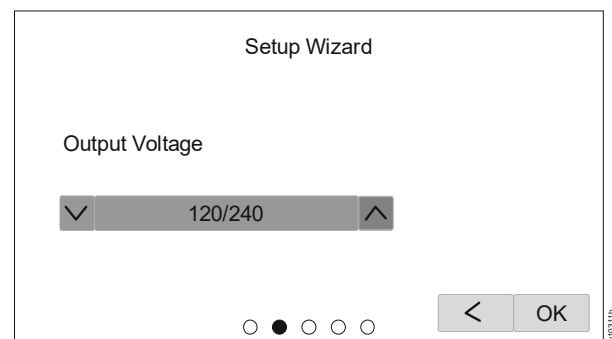

3. Set Alarm if Redundancy Under

Select the desired number of redundant power modules. If the number (of redundant power modules) falls below the set value, then the UPS will initiate an alarm.

Options:

- Never
- N+1
- N+2

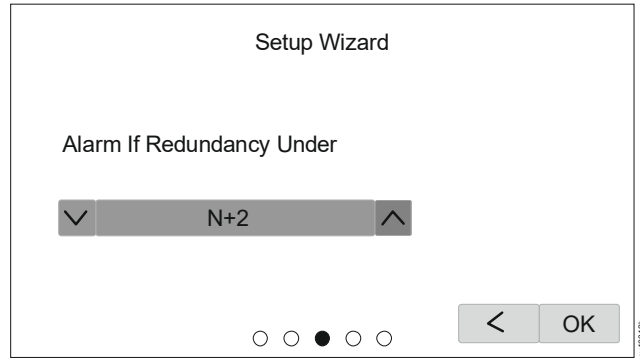

4. Set Time Zone, Current Date, and Time

NOTE: This is the NMC's Time Zone, Date, and Time settings. If the NTP (Network Time Protocol) is enabled in the NMC, then this screen will not appear on the LCD display.

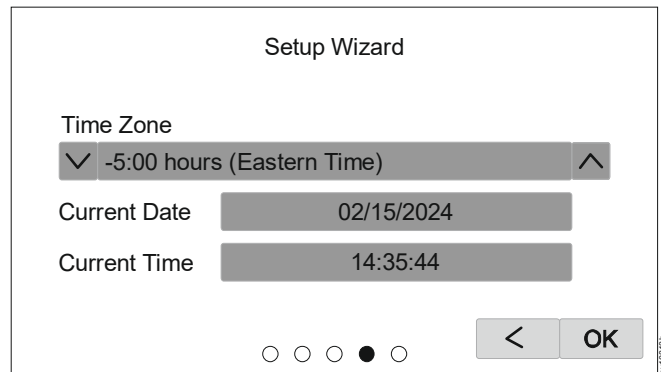

5. Set Installation Date

NOTE: If the Installation date is already set in the UPS, this screen will not appear on the LCD display.

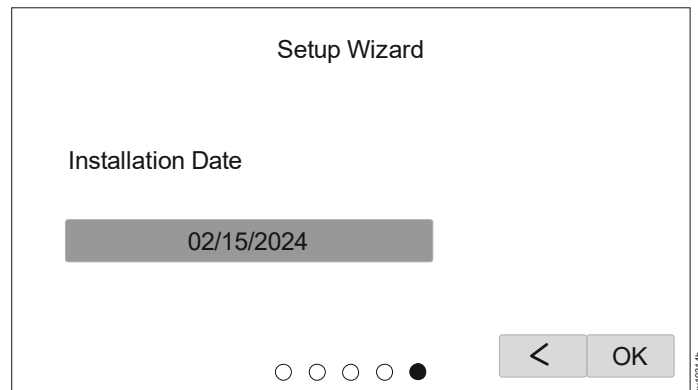

General settings

Configure these settings at any time, using the LCD display or the Network Management Web Interface.

The settings can be done in the following ways:

- Using the “**^**” and “**v**” buttons to navigate through the options available.
- Using the keypad, which pops up when a value field is touched.
- Touch the Check Box to either enable (checked) or disable (unchecked) it.

1. Output

(Home → Configuration → UPS → Output)

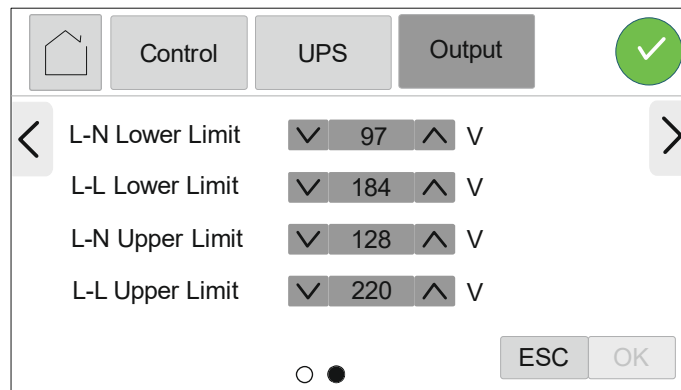
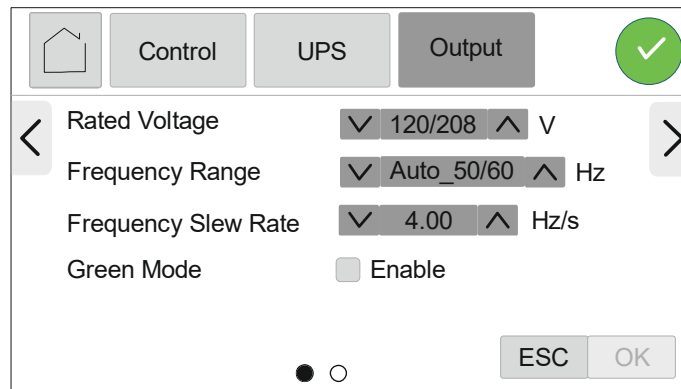

a. Rated Voltage

Set the output voltage for the UPS. This setting can only be changed when the UPS output is off.

Default Value: The value should be selected by the user during the initial startup.

Reset to factory default does not change the selected value.

Options:

- 120/208 VAC
- 120/240 VAC
- 100/200 VAC

b. Frequency Range

Set the output frequency for the UPS.

Default Value: Auto 50/60 \pm 3Hz

Options:

- Auto 50/60 \pm 3 Hz
- 50 \pm 0.1 Hz
- 50 \pm 3.0 Hz
- 60 \pm 0.1 Hz
- 60 \pm 3.0 Hz

c. Frequency Slew Rate

Select the rate of change of the output frequency in Hz per second.

Default Value: 1 Hz/sec

Options:

- 1 Hz/sec
- 2 Hz/sec
- 4 Hz/sec

d. Green Mode

Disable or enable Green mode operation.

Default Value: Disable

Options:

- Disable (unchecked "Enable")
- Enable

e. Output Lower Acceptable Voltage

If the UPS input voltage is between the lower acceptable voltage and the higher acceptable voltage, the UPS will operate in Green mode, if enabled.

If the output voltage goes outside the acceptable range, the UPS will switch from Green mode to On-line mode or to On-battery mode.

L-N Lower Limit:

Default Value: 100 V output: 92 V
120 V output: 106 V

Options: 100 V output: 86 to 92 V
120 V output: 97 to 106 V

L-L Lower Limit:

Default Value: 200 V output: 184 V
208 V output: 184 V
240 V output: 212 V

Options: 200 V output: 172 to 184 V
208 V output: 168 to 184 V
240 V output: 194 to 212 V

NOTE: If input voltage goes below the output lower acceptable voltage setting, it must rise to at least 5 V above the setting for Green mode to be acceptable.

f. Output Upper Acceptable Voltage

If the UPS input voltage is between the lower acceptable voltage and the higher acceptable voltage, the UPS will operate in Green mode, if enabled.

If the output voltage goes outside the acceptable range, the UPS will switch from Green mode to On-line mode or to On-battery mode.

L-N Upper Limit:

Default Value: 100 V output: 108 V
120 V output: 127 V

Options: 100 V output: 108 to 114 V
120 V output: 127 to 136 V

L-L Upper Limit:

Default Value: 200 V output: 216 V
208 V output: 220 V
240 V output: 254 V

Options: 200V output: 216 to 228 V
208 V output: 220 to 236 V
240 V output: 254 to 272 V

NOTE: If the input voltage goes above the output upper acceptable voltage setting, it must drop to 5 V below the upper setting for bypass to be acceptable.

2. Bypass

(Home → Configuration → UPS → Bypass)

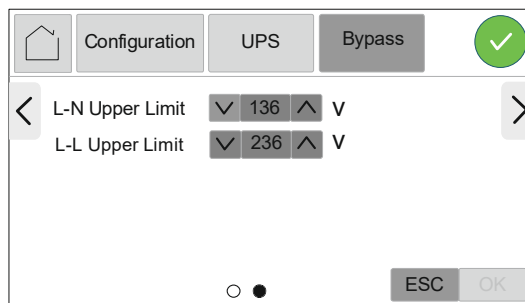
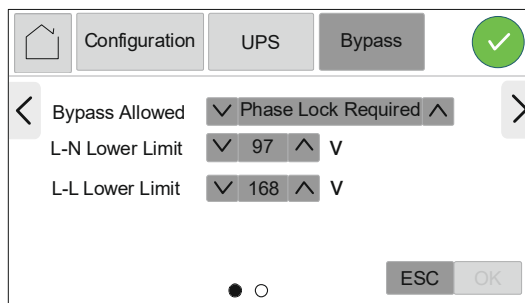

NOTE: If the input voltage goes below the L-N Lower Limit setting, the input voltage must rise to 7.6 V above the setting for the UPS to return to On-line mode. If the input voltage goes above the L-N Upper Limit setting, the input voltage must drop to 5 V below the setting for the UPS to return to On-line mode.

a. Bypass Allowed

“Phase Lock” refers to the condition where the input frequency matches the configured output frequency.

“Phase Lock Required” will only allow the UPS to enter Bypass/Green Mode under normal conditions where input frequency is equal to output frequency.

“Never Acceptable” will prevent the UPS from going into bypass mode during normal operation.

Default Value: Phase Lock Required

Options:

- Phase Lock Required
- Never Acceptable

b. Bypass Lower Acceptable Voltage

If the UPS input voltage is between the lower acceptable voltage and the higher acceptable voltage, the UPS can operate in Bypass mode.

L-N Lower Limit

Default Value: 100 V output: 86 V
120 V output: 97 V

Options: 100 V output: 82 to 92 V
120 V output: 92 to 106 V

L-L Lower Limit

Default Value: 200 V output: 172 V
208 V output: 168 V
240 V output: 194 V

Options: 200 V output: 164 to 184 V
208 V output: 160 to 184 V
240 V output: 184 to 212 V

c. Bypass Upper Acceptable Voltage

If the UPS input voltage is between the lower acceptable voltage and the higher acceptable voltage, the UPS can operate in Bypass mode.

L-N Upper Limit

Default Value: 100 V output: 114 V
120 V output: 136 V

Options: 100 V output: 108 to 130 V
120 V output: 127 to 148 V

L-L Upper Limit:

Default Value: 200 V output: 228 V
208 V output: 236 V
240 V output: 272 V

Options: 200 V output: 216 to 260 V
208 V output: 220 to 256 V
240 V output: 254 to 296 V

3. Timers

(Home → Configuration → UPS → Timers)

Setting	Value	Unit
Power Off Delay	90	s
Reboot Duration	8	s
Power On Delay	0	s
Min Return Runtime	0	s

ESC OK

a. Power Off Delay

Set the time delay for the UPS output to turn off after receiving the *Turn UPS Off* command.

Default: 90 seconds

Options: 0 to 32767 seconds

b. Reboot Duration

Set the time for the UPS to remain *off* after receiving the *Reboot UPS* command.

Default: 8 seconds

Options: 4 to 300 seconds

c. Power On Delay

Set the time delay for the UPS output to turn on after receiving the *Turn UPS On* command.

Default: 0 seconds

Options: 0 to 600 seconds

d. Min. Return Runtime

Set the minimum runtime that must be available for the UPS output to turn on after a shutdown.

Default: 0 seconds

Options: 0 to 32767 seconds

4. Alarms

(Home → Configuration → UPS → Alarms)

The screenshot shows the 'Alarms' configuration screen. At the top, there are navigation tabs: Home, Configuration, UPS, and Alarms (which is highlighted). A green checkmark icon is in the top right corner. Below the tabs, there are four settings:

- Low Runtime: 150 s
- Redundancy: Never
- Battery Alarm Warning: 183 d
- Battery Alarm Sleep: 14 d

At the bottom right, there are two buttons: ESC and OK. A small vertical text 'BY10321B' is visible on the right side of the screen.

a. Low Runtime

Set runtime remaining threshold, when the UPS should emit an audible alarm.

Default Value: 150 seconds

Options: 120 to 3600 seconds

b. Redundancy

Set the desired number of redundant power modules. If the number (of redundant power modules) falls below the set value, then the UPS will initiate an alert.

Default Value: Never

Options:

- Never
- N + 1
- N + 2

c. Battery Alarm Warning

Set the number of days prior to the estimated Battery EOL (End-of-Life), to receive an alert. When this date is reached, the UPS will emit an audible alarm and a message will appear on the LCD display screen.

Example: Using the default value, the Battery Alarm Warning will occur 183 days before the estimated EOL date.

To disable the notification/alarm, select -1.

Default Value: 183 days

Options:

- 0 to 730 days
- -1

d. Battery Alarm Sleep

The Battery Alarm Warning can be muted. Set the number of days for the next Battery Alarm Warning since it was muted.

To disable the notification, select -1.

Default Value: 14 days

Options:

- 0 to 365 days
- -1

5. General

(Home → Configuration → UPS → General)

The screenshot shows the 'General' configuration page for the UPS. At the top, there are four tabs: 'Home' (with a house icon), 'Configuration', 'UPS', and 'General'. The 'General' tab is highlighted with a green checkmark. Below the tabs, there are three settings:

- UPS Name:** A text field containing 'APC UPS'.
- Self-Test Schedule:** A dropdown menu showing 'Startup 14d since' with up and down arrow buttons.
- Battery Replaced On:** A date field containing '10/15/2021'.

At the bottom right, there are two buttons: 'ESC' and 'OK'. A small vertical text '© 2021 APC' is visible on the right side of the form.

a. UPS Name

Set the name of the UPS.

NOTE: This value needs to be entered by the user (no default value or options for this setting).

b. Self-Test Schedule

Set the interval at which the UPS should execute a Self-test.

Default: Startup + 7 days since last test

Options:

- Never
- On Startup
- Startup + 14 days since last test
- Startup + 7 days since last test

c. Battery Replaced On

Set the date on which the battery module was last replaced.

NOTE: This value needs to be entered by the user (no default value or options for this setting).

6. Load Shedding

(Home → Configuration → UPS → Load Shedding)

NOTE: The UPS can be configured to shed the connected load (Load Shedding) by turning off the output, while operating in On-battery mode, based on:

- The time duration the UPS is On Battery mode (“Time on Battery”) or
- The battery runtime remaining (“Runtime Remaining”) or
- Both of the above

The image shows two screenshots of the Load Shedding configuration interface. The top screenshot displays the following settings:

- Time On Battery:** Enable (unchecked), value: 32767 s
- Runtime Remaining:** Enable (unchecked), value: 5 s

The bottom screenshot displays the following settings:

- Use Off Delay:** Enable (unchecked)
- Manual Restart Required:** Enable (unchecked)

Both screenshots include navigation arrows, a green checkmark icon, and ESC/OK buttons. A radio button indicator at the bottom of each screen shows the first option is selected.

a. Time On Battery

Enable this feature to set the time duration the UPS supplies battery power to the connected load before load shedding.

Default: Disabled (box unchecked)

Options:

- Enable
- Disable

b. Time On Battery

NOTE: This feature will be enabled only when the Time On Battery is set to Enable. Set the time duration for which the UPS supplies battery power to the connected load before load shedding.

Default: 32767 seconds

Options: 5 to 32767 seconds

c. Runtime Remaining

To conserve battery power, the UPS can turn off the output when the runtime remaining threshold is reached.

Default: Disabled (box unchecked)

Options:

- Enable
- Disable

d. Runtime Remaining

NOTE: This feature will be enabled only when the Remaining Runtime is set to Enable.

Set the runtime threshold when the UPS will turn off the output.

Default: 0 seconds

Options: 0 to 3600 seconds

e. Use Off Delay

Enable this option for turning off the UPS output after the *Power Off Delay* time set, once the load shedding threshold is met when the UPS is On-battery mode. Refer to "Timers" on page 54,

Default: Disabled (box unchecked)

Options:

- Enable
- Disable

f. Manual Restart Required

Enable this option to manually restart the UPS after the UPS output was turned off due to load shedding while operating in On-battery mode.

The UPS output gets turned off once the load shedding threshold is reached while the UPS is in On-battery mode. After the utility power is restored, the UPS goes into Standby with AC mode and remains in that mode till the UPS is manually restarted.

Default: Disabled (box unchecked)

Options:

- Enable
- Disable

7. Display

(Home → Configuration → Display)

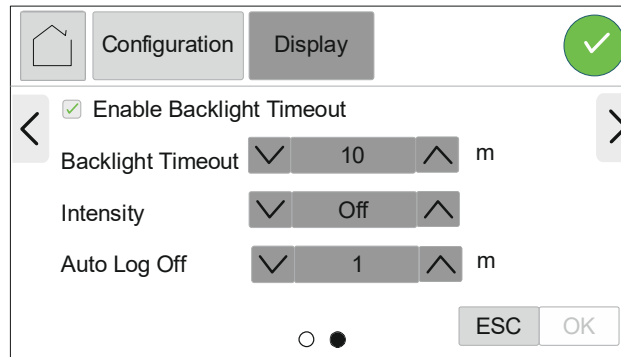
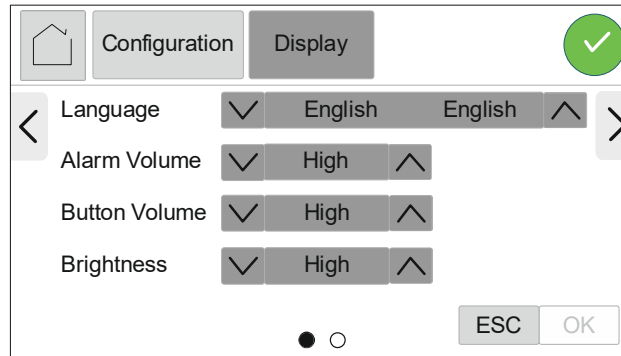

a. Language

Set the required language of the LCD display.

NOTE: Language options will vary by model and firmware version.

Default: English

Options:

- English
- French
- Italian
- German
- Spanish
- Portuguese
- Japanese
- Russian
- Chinese
- Korean

b. Alarm Volume

When set to off, the UPS will never emit an audible tone when an alarm condition occurs.

Default: High

Options:

- High
- Medium
- Low
- Off

c. Button Volume

When set to off, the UPS will never emit an audible tone when buttons are touched.

Default: High

Options:

- High
- Medium
- Low
- Off

d. Brightness

Adjust the brightness of the backlight in the LCD display.

Default: High

Options:

- High
- Medium
- Low

e. Enable Backlight Timeout

To conserve energy, backlight illumination of the LCD display can be dimmed or turned off when no events are active.

Full display interface illumination turns on when the UPS changes status as a result of an event or when the LCD display is touched.

Default: Enabled (box checked)

Options:

- Enable
- Disable

f. Backlight Timeout

NOTE: This setting will be available only when Backlight Timeout is enabled.

Set the time after which the backlight illumination should turn off.

Default: 10 minutes

Options: 1 to 60 minutes

g. Intensity

Adjust LCD brightness after the Backlight Timeout has expired.

Default: Off

Options:

- Off
- Very Low
- Low
- Medium

h. Auto Log Off

NOTE: This setting will be effective only if the Login feature in the Main Menu is enabled (refer to “Login to LCD Display” on page 67 for details on enabling Login feature). Set the time for which the LCD display can remain inactive, after which the login credentials must be re-entered.

Default: 1 minute

Options:

- 1 minute
- 5 minutes
- 10 minutes
- 30 minutes
- 60 minutes

8. Network

(Home → Configuration → Network)

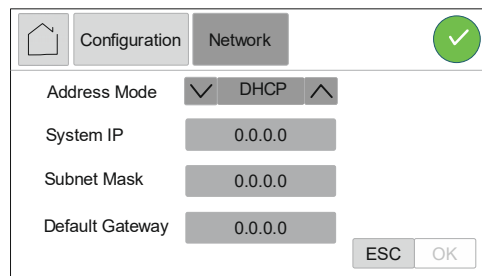

a. Address Mode

Scroll through the fields to set the IP address mode.

Default: DHCP

Options:

- Manual - the following settings get enabled when this option is selected:
 - System IP
 - Subnet Mask
 - Default Gateway
- DHCP
- BOOTP

9. Date and Time

(Home → Configuration → Date and Time)

Time Zone
 ▼ -5:00 hours (Eastern Time) ▲

Current Date 08/03/2022

Current Time 18:18:17

ESC OK

Allows the user to set the Time Zone, Date and Time. The time zone is in Universal Time Coordinated (UTC) time.

UTC is a coordinated time scale, maintained by the Bureau International des Poids et Mesures (BIPM)

Default: -5:00 hours (Eastern Time)

Options: About 20 different UTC time zones.

10. Restore Defaults

(Home → Configuration → Restore Defaults)

Reset All
 Exclude TCP/IP

Reset Only
 TCP/IP
 Event Configuration
 UPS to Defaults
 Display Settings

ESC OK

Allows the user to restore the UPS factory default settings.

Default: Reset All exclude TCP/IP

Options:

- Reset All
- Reset All excluding TCP/IP
- Reset only (check all desired)
 - TCP/IP
 - Event Configuration
 - UPS to Default
 - Display Settings

11.USB Storage

(Home → Configuration → USB Storage)

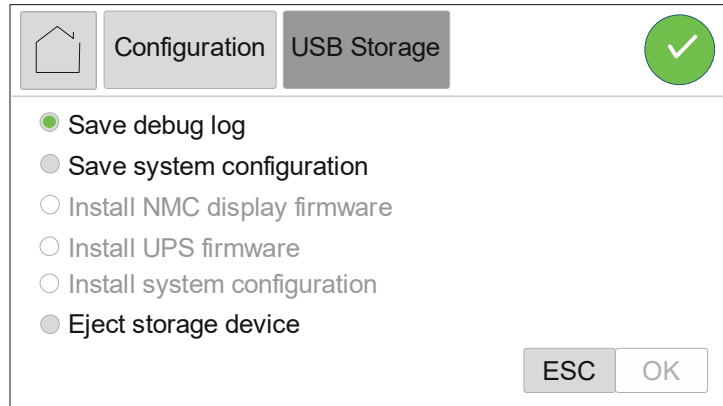

Use this feature to

- Save debug log or system configuration on a USB storage device.
- Install a signed version of NMC display firmware, UPS firmware or system configuration from a USB storage device.

This screen gets enabled only when a USB storage device is inserted to the USB port either on the rear panel (refer to “Rear Panel Features” on page 24 for location) or on the LCD display (refer to “LCD Display” on page 40 for location).

The following options are enabled by default when a USB storage device is inserted into the USB port:

- Save debug log
- Save system configuration

The following options get enabled only when the inserted USB storage device contains a signed version of the installation files:

- Install NMC display firmware
- Install UPS firmware
- Install system configuration

To use this feature:

- Touch the appropriate option to enable the option.
- Touch the OK button.

To eject the storage device:

- Touch the Eject storage device option to enable it.
- Touch the OK button.

Control

UPS

Navigate through Home → Control → UPS to access the UPS Control features.

Depending on the status of the UPS, any of the following screens will appear.

To instruct the UPS to execute the selected command:

- i. Touch the appropriate command, to enable/disable the appropriate options.
- ii. Touch the OK button to execute the selected option.

1. UPS output is on and is working in Online mode

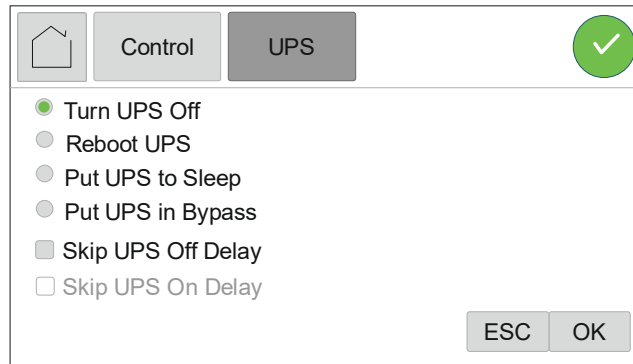

a. Turn UPS Off

Use this command to turn off the UPS output.

b. Reboot UPS

Use this command to reboot the UPS; turns the output off and turns it back on.

c. Put UPS to Sleep

Use this command to shutdown the UPS and restart after the Sleep Time Duration configured in Timers. Refer to “Timers” on page 54 for details.

NOTE: Sleep Time is available only through web GUI.

d. Put UPS in Bypass

Use this command to transfer the UPS to Software Bypass mode. Refer to “Software Bypass” on page 33 for details.

e. Clear UPS Alarms

NOTE: This command will be available only if there are active alarms.

Use this command to clear all existing UPS alerts and alarms.

f. Skip UPS Off Delay

Enable this option to turn off the UPS output immediately. If this command is not enabled, the UPS output will be turned off after the Power Off Delay configured in Timers. Refer to “Timers” on page 54 for details.

2. UPS output is off and utility power is available

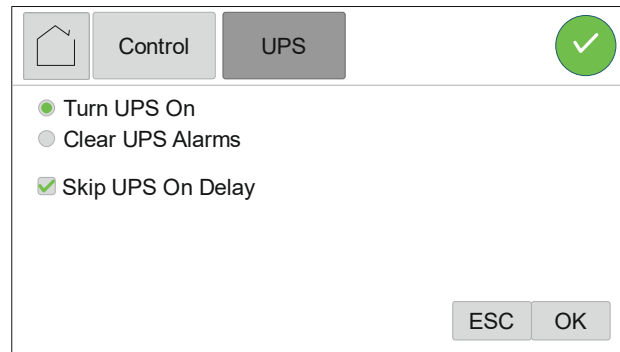

a. Turn UPS On

Use this command to turn on the UPS output.

b. Clear UPS Alarm

NOTE: This option will be available only if there are active alarms.

Use this command to clear all existing UPS alarms.

c. Skip UPS On Delay

Enable this option to turn on the UPS output immediately. If this option is not enabled, the UPS output will be turned on after the Power On Delay configured in Timers. Refer to "Timers" on page 54 for details.

3. UPS output is off and utility power is not available

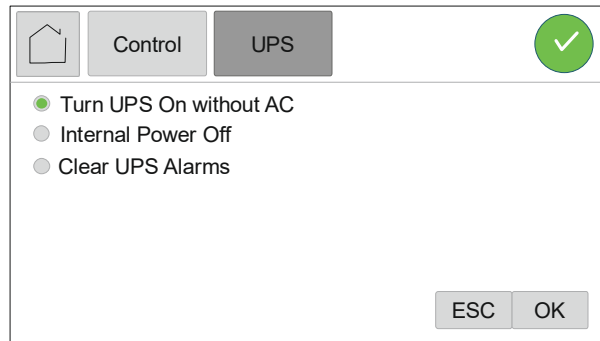

a. Turn UPS On without AC

Use this command to turn on the UPS output using battery power when utility power is not available.

b. Internal Power Off

Use this command to shutdown the UPS.

c. Clear UPS Alarms

NOTE: This command will be available only if there are active alarms in the UPS.

Use this command to clear all existing UPS alarms.

Display

Navigate through Home → Control → Display to access the Display Control features.

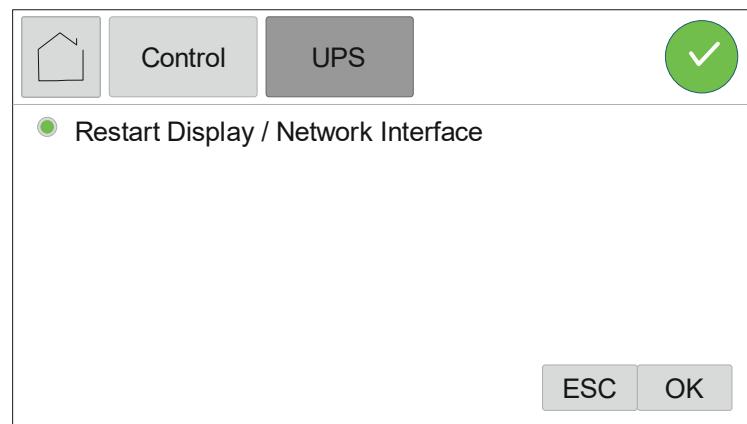

This feature is for restarting the LCD display and network Interface. Recommend to use this feature whenever the LCD display screens develops a lag or network gets disconnected or a reduction in data transfer speed is observed.

- i. Touch the Restart Display / Network Interface command, to enable it.
- ii. Touch the OK button to execute the command.

Login to LCD Display

1. Enable the Login feature:

- a. Login to the NMC web page to enable this feature.

NOTE: Refer to “Network Management Interface” on page 74 for details on logging in to the NMC web page.

- b. Navigate to Configuration → UPS → General, in the NMC webpage.
- c. Set User Mode field to Authentication Needed.

This allows the user to either Login from the Home screen or the user will be prompted for login credentials when the user attempts an action that requires authentication, e.g., changing a configuration parameter.

Once logged in, the user will stay logged in unless the user logs out from the menu described in “Logout of the LCD display” on page 68 or until there is no touchscreen activity for the time configured in the Auto Log Off Setting described in “Auto Log Off” on page 61 for details.

NOTE: Unless the User Mode is set to Locked (read only), the login credentials are required to access the NMC log from the display. In the Locked mode, the access is prohibited.

2. Login to the LCD display:

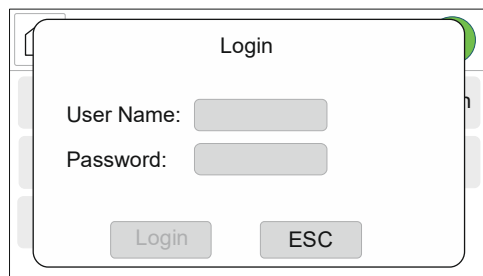
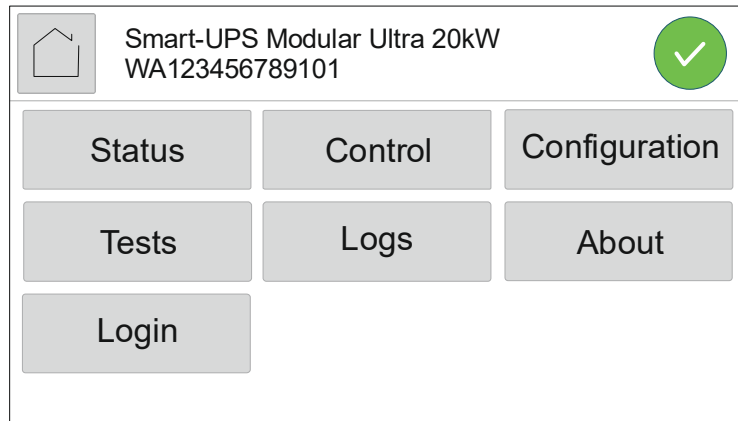

- a. Touch the HOME icon to enter the main menu.

- b. Touch the LOGIN button to open the Login Screen.
- c. Touch the shaded area, adjacent to the User Name field, to pop up the keypad.
- d. Tap ENTER button (↵) once the user name has been completed.
- e. Touch the shaded area adjacent to the Password field to pop up the keypad.
- f. Tap ENTER button (↵) once the password has been completed.
NOTE: The User Name and Password fields can be entered in either order but both must be entered before the LOGIN button is enabled.
- g. Enter the same username and password used for accessing the NMC webpage.
- h. Touch the LOGIN button to log into the LCD display.

3. Logout of the LCD display

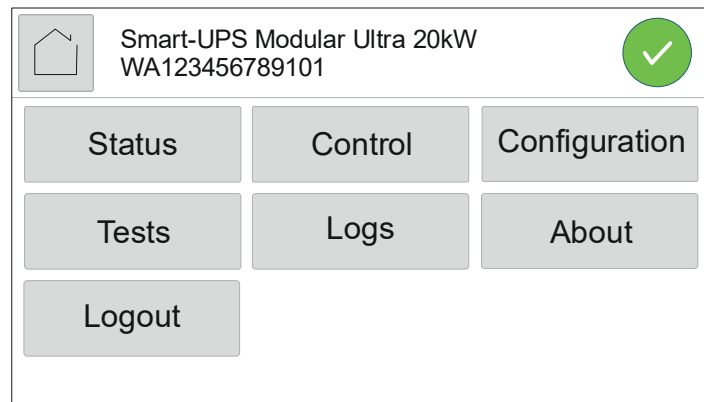

- a. Touch the HOME icon to enter the main menu.
- b. Touch the LOGOUT button and follow on-screen instructions to logout.

Update Firmware

- The UPS firmware can only be updated when the input voltage is within the on-line range.
- Any system will allow UPS firmware update if the output is off.
- A system running firmware version UPS 13.0 or later will also allow UPS firmware update if the system is in manual bypass.
- A system running firmware version UPS 14.0 or later will also allow UPS firmware update if the system output is on.
- NMC display firmware can be updated during any operating mode.

To enable UPS firmware upgrade with UPS in bypass or with the UPS output on:

1. Log into the NMC web page.
2. Navigate to the Configuration → UPS → Firmware Update → Settings page.
3. The NMC will show settings available based on the UPS firmware capabilities. For help logging in to the NMC web page or an explanation of the settings, refer to the NMC user documentation.

Through USB

1. Before starting the transfer, be sure that the USB storage device is formatted in FAT, FAT16, or FAT32.
2. Download the firmware upgrade file.
3. Create a folder named apcfirm on the USB storage device.
4. Copy the .nmc3 file to apcfirm folder.
5. Use a text editor to create a file named nmc3.rcf (the file extension must be .rcf, not .txt for example).
6. In nmc3.rcf, add a line for the firmware package to be upgraded. For example, to upgrade Smart-UPS application version v2.x,
type: NMC3=apc_hw21_su_2-x.nmc3.
7. Save the nmc3.rcf file in apcfirm folder.
8. UPS firmware can be placed in the root directory of the USB storage device.

For more details refer to “UPS Network Management Card 3 - User Guide”. This user guide can be downloaded from

https://www.apc.com/us/en/download/document/SPD_CCON-AYCEFJ_EN/.

NMC display firmware update

1. Insert the USB storage device, containing the NMC display firmware update, into the USB port located on the LCD display (refer to “LCD Display” on page 40 for details).
2. A pop-up screen appears acknowledging the connected USB storage device. Touch the OK button to continue.
3. Select *Install NMC display firmware* option on the pop-up screen and touch the OK button.
4. Wait for the NMC display to reboot; will take a couple of minutes to reboot.
5. **Status LED** (🔴 in “LCD Display” on page 40) will illuminate amber during the update.
6. Navigate to USB Storage to eject the storage device.
7. Select *Eject storage device* option and touch the OK button to eject the USB storage device.

UPS firmware update

1. Insert the USB storage device, containing the UPS firmware update, into the USB port located on the LCD display (refer to “LCD Display” on page 40 for details).
NOTE: Be sure that the USB drive supports USB v1.1 and is in FAT, FAT16 or FAT32 format.
2. A pop-up screen appears acknowledging the connected USB storage device. Touch the OK button to continue.
3. Select *Install the UPS firmware* option on the pop-up screen and touch the OK button.
4. A progress bar will appear and it will take approximately 15 minutes for the update to complete.

NOTES:

- The LCD screen will return to the home screen after 30 seconds unless it is touched once before 30 seconds.
 - To see the progress of update, navigate to Home → Configuration → USB Storage.
5. Navigate to USB Storage to eject the storage device.
 6. Select Eject storage device option and touch the OK button to eject the USB storage device.

Through NMC web page

1. Log in to the NMC web page (refer to the NMC user documentation).
2. Navigate to *Configuration* in the drop-down menu.
3. Select *Firmware update* option and click on the UPLOAD button.
4. Select choose file and navigate to the folder (on the local computer) containing the signed firmware package or drag and drop the signed firmware package (from the local computer) over the "CHOOSE FILE" button on the web page.
5. Click on UPDATE UPS button to commence the update.
6. When the progress bar indicates completion, the UPS will begin updating. This will take several minutes.
7. Log out from the NMC web page once the UPS completes updating.

Download Log Files

Through USB

1. Insert an USB storage device into the USB port located on the LCD display (refer to “LCD Display” on page 40 for details).
2. A pop-up screen appears acknowledging the connected USB storage device. Touch the OK button to continue.
3. Select *Save debug log* (refer to “USB Storage” on page 63 for details) and touch the OK button.
4. A prompt will appear once the export of log file is completed. The log file will be a compressed TAR file.
5. Select *Eject storage device* option and touch the OK button to eject the USB storage device.
6. Extract the configuration file (config.ini), data log (data.txt) and event log (event.txt) files from the TAR file.

Through NMC web page

1. Refer to “Support Screen” section in the NMC user guide for details to download the log files.

Emergency Power Off

Overview

The Emergency Power Off (EPO) option is a feature that will immediately disconnect all connected equipment from utility power. The UPS will shut down immediately and will not switch to battery power.

During an EPO event, the SYSTEM ENABLE switch will move to OFF position.

To power up the connected equipment again, set the SYSTEM ENABLE switch to ON position and power recycle the UPS, i.e., Turn off the utility power input and the BM(s) and turn them on again (the BM can be turned on and off through the BATTERY ON/OFF switch).

Normally open contacts

1. If the EPO switch or relay contacts are normally open, insert the wires from the switch or contacts at positions 1 and 2 of the EPO terminal block. Use 16-28 AWG wire.
2. Tighten the screws to secure the wires.

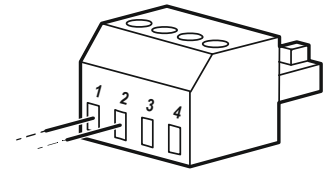

If the contacts are closed, the UPS will turn off and the connected equipment will not receive power.

Normally closed contacts

1. If the EPO switch or relay contacts are normally closed, insert the wires from the switch or contacts at positions 1 and 3 of the EPO terminal block. Use 16-28 AWG wire.
2. Insert a wire jumper between positions 1 and 2 of the EPO terminal block.
3. Tighten the screws to secure the wires.

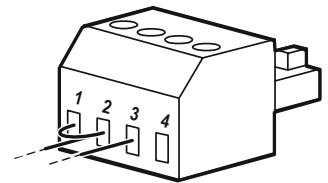

If the contacts are open, the UPS will turn off and the connected equipment will not receive power.

NOTE: Position 1 is the power source for the EPO circuit; it provides a few milliamperes of 24 V power.

If the normally closed (NC) EPO configuration is used, the EPO switch or relay should be rated for “dry” circuit applications. The switch or relay contact rating should be for low voltage and low current applications. This normally implies the contacts are gold plated.

The EPO interface is a Safety Extra Low Voltage (SELV) circuit. Connect the EPO interface only to other SELV circuits. The EPO interface monitors circuits that have no determined voltage potential. SELV circuits are controlled by a switch or relay properly isolated from utility power. To avoid damage to the UPS, do not connect the EPO interface to any circuit other than a SELV circuit.

Use one of the following cable types to connect the UPS to the EPO switch:

- CL2: Class 2 cable for general use.
- CL2P: Plenum cable for use in ducts, plenums, and other spaces used for environmental air.
- CL2R: Riser cable for use in a vertical run in a floor-to-floor shaft.

- CLEX: Limited use cable for use in dwellings and for use in raceways.
- Installation in Canada: Use only CSA certified-type ELC (Extra Low-voltage Control cable).
- Installation in countries other than Canada and USA: Use standard low voltage cable in accordance with national and local regulations.

Network Management Interface

Introduction

The UPS has an Ethernet port (refer to “Rear Panel Features” on page 24 for location) and a console port (refer to “LCD Display” on page 40 for location) that can be used to access the Network Management Interface.

The Network Management Interface has the same firmware, operation modes, and interaction with other APC products such as PowerChute® Network Shutdown.

Features

The Network Management Interface allows the UPS to function as a Web-based, IPv6 ready product.

The Network Management Interface can manage the UPS using multiple open standards such as:



Hypertext Transfer Protocol (HTTP)	Secure Shell (SSH)
Simple Network Management Protocol versions 1 and 3 (SNMPv1, SNMPv3)	Hypertext Transfer Protocol over Secure Sockets layer (HTTPS)
File Transfer Protocol (FTP)	Secure Copy (SCP)
Telnet	Syslog
RADIUS	Serial/Console interface

The Network Management Interface:

- Provides UPS control and Self-test scheduling features.
- Provides data and event logs.
- Enables set-up notifications through event logging, e-mail, and SNMP traps.
- Provides support for PowerChute Network Shutdown.
- Supports using a Dynamic Host Configuration Protocol (DHCP) or BOOTstrap Protocol (BOOTP) server to provide the network (TCP/IP) values.
- Provides the ability to export a user configuration (.ini) file from a configured UPS to one or more unconfigured UPS without conversion to a binary file.
- Provides a selection of security protocols for authentication and encryption.
- Communicates with StruxureWare Central and InfraStruxure Manager.
- Supports UPS firmware upgrade.
- Supports one universal input/output port for connection to a:
 - Temperature probe, AP9335T (supplied)
 - Temperature/humidity sensor, AP9335TH (optional)
 - Relay input/output connector that supports two input contacts and one output relay, AP9810 Dry Contact I/O Accessory (optional)
- Supports Wifi Device (AP9834) accessory (optional)
- Supports the following interfaces:
 - NMC WEB UI
 - Command Line Interface CLI
 - SNMP MIB Browser (MG-Soft, iReasoning etc.)

- EcoStruxure IT Data Center Expert
- StruxureWare Data Center Operation (SWDCO)
- EcoStruxure IT Gateway
- EcoStruxure IT Expert
- EcoStruxure IT Mobile Application (iOS and Android)
- EcoStruxure IT Advisor
- Connected Services App
- Netbotz-550

Related Documents

For related documents refer to

- NMC3 user guide:
https://www.apc.com/us/en/download/document/SPD_CCON-AYCEFJ_EN/
- NMC3 Command Line Interface (CLI) guide:
https://www.apc.com/us/en/download/document/SPD_CCON-AYCELJ_EN/

IP Address Configuration

The default TCP/IP configuration setting, DHCP, assumes that a properly configured DHCP server is available to provide TCP/IP settings to the Network Management Interface.

If the Network Management Interface obtains an IPv4 address from a DHCP server, use the LCD display to navigate Home → About → Network, to view the address.

To setup a static IPv4 address use the LCD display to navigate Home → Configuration → Network, to set the IP address, Subnet Mask and Gateway.

Smart Battery Management

Definitions

- **Battery Module (BM):** A string of battery cells arranged to produce a battery assembly with a connector. Replacement BMs can be ordered from our web site, www.apc.com.
- **External Battery Pack (XBP):** An enclosure that contains BM(s) and battery communication electronics.
- **User Interface (UI):** An interface by which a user can interact with the system. This may include a LCD display, a network management interface or PowerChute™ Network Shutdown software.

NOTE:

- Do not use a BM that is not approved by Schneider Electric.
- The system will not detect the presence of a BM not approved by Schneider Electric and may adversely affect the operation of the system.
- Use of a BM not approved by Schneider Electric will void the manufacturer's warranty.

User interface

View Status/Error notifications: The status of connected XBP(s) can be viewed on the LCD display using the menu options.

Battery Module Status LEDs: Refer to “Status LEDs” on page 37 for details.

To clear a detected internal error in the BM:

1. Disconnect the BM by disengaging the thumbscrew (located on the front panel of the BM).
2. Be sure that the **Battery Module Status** LED is not illuminated.
3. Tighten the thumbscrew to connect the BM.

If the detected internal error persists even after 3 attempts, then contact Customer Support.

System interfaces: BM status, alerts, and measurements can be viewed on the LCD display.

Maintenance

- **BM maintenance:** The APC BM uses Lithium-ion battery cells and does not require maintenance.
- **Battery health monitoring:** The battery energy output and voltage are monitored to assess the health of the installed batteries when the UPS is operating on battery. Battery health monitoring is done during a Self-test and when the UPS is operating on battery power.

End of useful life

- **Near end-of-life notification:** An alert message will appear on the LCD display screen when a BM is approaching the end of its useful life. For configuration details, refer to “Battery Alarm Warning” on page 55 and “Battery Alarm Sleep” on page 55. The estimated replacement date for each BM is available through the UI.

- **Needs replacement notification:** The replacement due date of a BM will appear on the LCD display. The BM must be replaced as soon as possible.
When a BM requires replacement, recommendation of the additional BM(s) nearing end of their useful life will also appear on the LCD display.

NOTE: Continued operation after the **Needs replacement notification** may cause damage to the batteries.

Recycling the BM

1. Remove the BM from the UPS or XBP.
2. Recycle the BM.
CAUTION: Do not disassemble the BM.

Recommended actions after installing new BM or XBP

The following actions should be performed after installing a new BM or XBP:

- When a new BM or XBP is installed, the **Battery Module Status** LED illuminates green in the BM(s), indicating that the BM or XBP is detected by the system and is working normally.
If **Battery Module Status** LED illuminates either Red or Amber in any of the BM(s), refer to “Status LEDs” on page 37 for details.
- Verify that the UPS is connected to input power and output power is turned on.
 - Use the LCD display to navigate to the status menus to verify that the UPS recognizes the BM(s) or XBP.
 - Be sure that the connected load to the UPS is greater than 400 watts. This information will appear on the LCD display.
 - Once the battery module is fully charged, perform a Self-test by navigating Home → Tests → UPS Self-test. During this test, the UPS will change over to On-battery mode for a short time to assess the health of the BMs and XBP, if connected.
 - If at the time of XBP installation, UPS input power is not available, turn on the UPS output from battery power for 30 seconds. This will allow the UPS to detect all installed BM(s) or XBP(s). Refer to “Turn on / Turn off the UPS” on page 38 for instructions on how to turn the UPS on when input power is not available.
 - Allow the BMs to charge for 24 hours to ensure full runtime capability.

Troubleshooting

Use the table below to solve minor installation and operation problems.

Refer our web site, www.apc.com for assistance with complex UPS problems.

The UPS features firmware that can be upgraded.

Visit our web site, www.apc.com/Support, or contact your local Customer Care Center for more information.

Problem and Possible Cause	Solution
UPS is not turning on or there is no output	
The UPS is not connected to utility power.	Be sure that the hardwiring is secured both in the UPS and the utility power supply.
UPS output connections are not secured properly.	Be sure that the UPS output connections are secured properly.
SYSTEM ENABLE switch is set to OFF.	Turn on the SYSTEM ENABLE switch.
Thumbscrew on any of the PMs, or BMs, or IMs is not completely engaged.	Be sure that the thumbscrews on all the modules are completely engaged.
The LCD display screen shows very low or no utility power.	Check the utility power supply to be sure that the power quality is within acceptable limits.
The UPS has detected an internal error.	The LCD display screen will show a message to identify the alert and corrective action required.
UPS emits an alarm tone	
Normal UPS operation when running on battery power.	The UPS is operating on battery power. Refer to the status of the UPS displayed on the LCD display screen. Press any button to mute the audible alarm tone.
The UPS emits an audible alarm tone and the color of the UPS display interface changes to red or amber.	The UPS has detected an internal error. Refer to the LCD display screen for information.
UPS does not provide expected backup time	
The UPS BMs are weak due to a recent power outage or they are near the end of their service life.	Charge the BMs. Batteries require recharging after extended outages and wear out faster when put into service often or when operated at elevated temperatures. If the batteries are nearing the end of their service life, consider replacing the batteries even if the Replace Battery message is not displayed.

Problem and Possible Cause	Solution
The UPS is experiencing an overload condition.	<p>The connected equipment exceeds the specified maximum load. Visit our web site, www.apc.com for product specifications.</p> <p>The UPS will emit a sustained audible alarm until the overload condition is corrected.</p> <p>Disconnect nonessential equipment from the UPS to correct the overload condition.</p> <p>NOTE: If the problem still persists, disconnect the UPS from the utility power source and turn off the SYSTEM ENABLE switch and start up the UPS again.</p>
The UPS experiences an overload condition	
A power module has been removed from the UPS frame.	<p>NOTE: Removing a power module could result in overload of the remaining power modules.</p> <p>Replace the power module or reduce the connected load to be well within the capacity of the power modules available in the UPS frame.</p>
UPS operates on battery power while connected to utility power	
The UPS is performing a Self-test.	Wait for the UPS to complete the Self-test.
The utility power circuit breaker has tripped.	Be sure that the utility power circuit breaker is rated for the connected load of the UPS.
There is very high, very low, or distorted input line voltage.	<p>Navigate to the LCD display screen that shows input voltage. Be sure that the input voltage is within the specified operating limits.</p> <p>If no input voltage is indicated on the LCD display screen, contact Customer Support.</p>
The LCD display screen shows the message Waiting for Minimum Runtime.	<p>The UPS output does not turn on when the battery runtime is lower than the configured minimum return runtime.</p> <ul style="list-style-type: none"> • Wait till the battery gets charged or • Change the minimum return runtime setting through Home → Config → UPS → Timers menu.
LCD display screen shows Overload and the UPS emits an audible alarm tone	
The UPS is experiencing an overload condition.	<p>Rating of the connected equipment exceeds the capacity of the UPS.</p> <p>The UPS will emit an audible alarm tone until the overload condition is corrected.</p> <p>Disconnect nonessential equipment from the UPS to correct the overload condition.</p> <p>NOTE: If the problem still persists, disconnect the UPS from the utility power, turn off the SYSTEM ENABLE switch, and start up the UPS again.</p>

Problem and Possible Cause	Solution
LCD display screen shows UPS is operating in Bypass mode	
The UPS has gone into temporary bypass.	Check for the event, on the LCD display, which caused the UPS go into temporary bypass and take appropriate corrective action. If the UPS goes into temporary bypass whilst operating in green mode, be sure that the connected load does not exceed 105% of the UPS capacity.
The UPS received a command to operate in bypass mode.	No action required as the UPS has been commanded to operate in bypass mode by the user.
The MANUAL BYPASS switch is set to ON.	Be sure that the service personnel set the MANUAL BYPASS switch to OFF, after servicing the UPS.
The UPS has detected an internal error and automatically switched to event bypass mode.	The LCD display screen will show a message to identify the alert and corrective action required.
LCD display illuminates amber or red and displays an alert message and UPS emits an audible alarm	
The UPS has detected an alarm condition.	Follow the instructions on the LCD display screen. Touch any button to mute all audible alarms.
The LCD display screen shows the message Disconnected Battery .	Be sure that the BMs are completely inserted, the thumbscrew is completely engaged and the BATTERY ON/OFF switch is turned on.
Replace Battery alert is displayed	
The BM has a weak charge.	Allow the BM to recharge for at least 4 hours. Then, perform a Self-test. If the problem persists after recharging, replace the BM.
The replacement BM is not properly connected.	Be sure that the BMs are completely inserted, the thumbscrew is completely engaged and the BATTERY ON/OFF switch is set to ON.
The UPS is operating on battery power but not all Battery Module Status LEDs are amber	
This is a normal operation under certain circumstances.	The battery module status LED switches from green to amber if the discharge power is above a certain level (~150 W). If the UPS is supporting a small load and there are many battery modules, the power from an individual battery module might not be enough to switch from green to amber. The battery modules with green status LED lights are still available to support the load.

Transport

1. Shut down and disconnect all connected equipment.
2. Disconnect the unit from the utility power.
3. Disconnect all the BMs and XBPs (if applicable).
4. Follow the shipping instructions outlined in the Service section of this manual.

Service

If the unit requires service, do not return it to the dealer. Follow these steps:

1. Review the “Troubleshooting” on page 78 of the manual to eliminate common problems.
2. If the problem persists, contact Customer Support through our web site, www.apc.com.
 - a. Note the model number and serial number and the date of purchase. The model and serial numbers are located on the top left corner of the rear panel of the unit and are also available through the LCD display.
 - b. Call Customer Support. A technician will attempt to solve the problem over the phone. If this is not possible, the technician will issue a Return Material Authorization Number (RMA#).
 - c. If the unit is under warranty, the repairs are free.
 - d. Service procedures and returns may vary internationally. For country specific instructions, refer to the APC web site, www.apc.com.
3. Shipment of Lithium-ion Battery is highly regulated and the regulation is evolving. Pack the BM and UPS separately.
4. Always contact Customer Support to get the latest guidance on the shipment of Lithium-ion battery and UPS.
5. Pack the unit properly to avoid damage in transit. Do not use foam beads for packaging. Damage sustained in transit is not covered under the warranty.
6. Write the RMA# provided by Customer Support on the outside of the package.
7. Return the unit by insured, prepaid carrier to the address provided by Customer Support.

Limited Factory Warranty

Schneider Electric IT Corporation (SEIT), warrants its products to be free from defects in materials and workmanship for a period of five (5) years from the date of purchase. The SEIT obligation under this warranty is limited to repairing or replacing, at its own sole option, any such defective products. Repair or replacement of a defective product or part thereof does not extend the original warranty period.

This warranty applies only to the original purchaser who must have properly registered the product within 10 days of purchase. Products may be registered online at warranty.apc.com.

SEIT shall not be liable under the warranty if its testing and examination disclose that the alleged defect in the product does not exist or was caused by end user or any third person misuse, negligence, improper installation, testing, operation or use of the product contrary to SEIT recommendations of specifications. Further, SEIT shall not be liable for defects resulting from: 1) unauthorized attempts to repair or modify the product, 2) incorrect or inadequate electrical voltage or connection, 3) inappropriate on site operation conditions, 4) Acts of God, 5) exposure to the elements, or 6) theft. In no event shall SEIT have any liability under this warranty for any product where the serial number has been altered, defaced, or removed.

EXCEPT AS SET FORTH ABOVE, THERE ARE NO WARRANTIES, EXPRESS OR IMPLIED, BY OPERATION OF LAW OR OTHERWISE, APPLICABLE TO PRODUCTS SOLD, SERVICED OR FURNISHED UNDER THIS AGREEMENT OR IN CONNECTION HEREWITH.

SEIT DISCLAIMS ALL IMPLIED WARRANTIES OF MERCHANTABILITY, SATISFACTION AND FITNESS FOR A PARTICULAR PURPOSE.

SEIT EXPRESS WARRANTIES WILL NOT BE ENLARGED, DIMINISHED, OR AFFECTED BY AND NO OBLIGATION OR LIABILITY WILL ARISE OUT OF, SEIT RENDERING OF TECHNICAL OR OTHER ADVICE OR SERVICE IN CONNECTION WITH THE PRODUCTS.

THE FOREGOING WARRANTIES AND REMEDIES ARE EXCLUSIVE AND IN LIEU OF ALL OTHER WARRANTIES AND REMEDIES. THE WARRANTIES SET FORTH ABOVE CONSTITUTE SEIT'S SOLE LIABILITY AND PURCHASER EXCLUSIVE REMEDY FOR ANY BREACH OF SUCH WARRANTIES. SEIT WARRANTIES EXTEND ONLY TO ORIGINAL PURCHASER AND ARE NOT EXTENDED TO ANY THIRD PARTIES.

IN NO EVENT SHALL SEIT, ITS OFFICERS, DIRECTORS, AFFILIATES OR EMPLOYEES BE LIABLE FOR ANY FORM OF INDIRECT, SPECIAL, CONSEQUENTIAL OR PUNITIVE DAMAGES, ARISING OUT OF THE USE, SERVICE OR INSTALLATION OF THE PRODUCTS, WHETHER SUCH DAMAGES ARISE IN CONTRACT OR TORT, IRRESPECTIVE OF FAULT, NEGLIGENCE OR STRICT LIABILITY OR WHETHER SEIT HAS BEEN ADVISED IN ADVANCE OF THE POSSIBILITY OF SUCH DAMAGES. SPECIFICALLY, SEIT IS NOT LIABLE FOR ANY COSTS, SUCH AS LOST PROFITS OR REVENUE, WHETHER DIRECT OR INDIRECT, LOSS OF EQUIPMENT, LOSS OF USE OF EQUIPMENT, LOSS OF SOFTWARE, LOSS OF DATA, COSTS OF SUBSTITUANTS, CLAIMS BY THIRD PARTIES, OR OTHERWISE.

NOTHING IN THIS LIMITED WARRANTY SHALL SEEK TO EXCLUDE OR LIMIT SEIT LIABILITY FOR DEATH OR PERSONAL INJURY RESULTING FROM ITS NEGLIGENCE OR ITS FRAUDULENT MISREPRESENTATION OF TO THE EXTENT THAT IT CANNOT BE EXCLUDED OR LIMITED BY APPLICABLE LAW.

To obtain service under warranty you must obtain a Returned Material Authorization (RMA) number from customer support. Customers with warranty claims issues may access the SEIT worldwide customer support network through the APC web site: www.apc.com. Select your country from the country selection drop down menu. Open the Support tab at the top of the web page to obtain information for customer support in your region. Products must be returned with transportation charges prepaid and must be accompanied by a brief description of the problem encountered and proof of date and place of purchase.

APC Worldwide Customer Support

Customer support for this or any other APC product is available at no charge in any of the following ways:

- Visit our web site to access documents in the APC Knowledge Base and to submit customer support requests.
 - **www.apc.com** (Corporate Headquarters)
Connect to a localized APC web site for specific countries, each of which provides customer support information.
 - **www.apc.com/support/**
Global support for searching APC Knowledge Base and using e-support.
- Contact the APC Customer Support Center by telephone or e-mail.
 - Local, country specific centers: go to www.apc.com/support/contact for contact information.
 - For information on how to obtain local customer support, contact our representative or the distributor from whom you purchased your APC product.



Select models are ENERGY STAR® qualified.

For more information on your specific model refer to our web site, www.apc.com.

Schneider Electric

35 rue Joseph Monier
92500 Rueil Malmaison - France
Phone: +33 (0) 1 41 29 70 00
www.se.com

As standards, specifications, and designs change from time to time,
please ask for confirmation of the information given in this publication.

© 2024 Schneider Electric. All Rights Reserved.

EN TME23641B