

SAMSUNG

User Manual

S55CG97*

(Singapore only: S55CG970NE)

(Saudi Arabia only : S55CG97WNM)

The colour and the appearance may differ depending on the product, and the specifications are subject to change without prior notice to improve the performance.

The contents of this manual are subject to change without notice to improve quality.

© Samsung

Samsung owns the copyright for this manual.

Use or reproduction of this manual in parts or entirety without the authorization of Samsung is prohibited.

Trademarks other than that of Samsung are owned by their respective owners.

Contents

Before Using the Product

Safety Precautions

- 3 Electricity and Safety
- 4 Installation
- 5 Operation

Cleaning

Correct posture to use the product

Preparations

Installation

- 9 Attaching the Stand
- 10 Precautions for moving the product
- 11 Checking the space around the product
- 11 Adjusting the Product Tilt and Height
- 13 Rotating the Product
- 15 Attaching the BRACKET WALL

Control Panel

Connections

Connecting the product to the One Connect

Providing proper ventilation for your Product

Ports

- 21 Connecting the Product to a PC as a USB HUB

Tidying Up the Connected Cables

Precautions and Notes

Read After Installing the product

- 23 Picture sizes and input signals

Read Before Connecting a Computer (Supported Resolutions)

- 24 VESA DMT
- 25 VESA CVT

Supported Resolutions for Video Signals

- 26 CTA-861

Specifications

General

Appendix

Responsibility for the Pay Service (Cost to Customers)

- 29 Not a product defect
- 30 A Product damage caused by customer's fault
- 30 Others

FreeSync (for AMD graphics card)

- 32 The models in the Graphics Cards list supports FreeSync

Before Using the Product







Safety Precautions

Warning

A serious or fatal injury may result if instructions are not followed.

Caution

Personal injury or damage to properties may result if instructions are not followed.

CAUTION			
RISK OF ELECTRIC SHOCK. DO NOT OPEN.			
CAUTION: TO REDUCE THE RISK OF ELECTRIC SHOCK, DO NOT REMOVE COVER (OR BACK). THERE ARE NO USER SERVICEABLE PARTS INSIDE. REFER ALL SERVICING TO QUALIFIED PERSONNEL.			
	This symbol indicates that high voltage is present inside. It is dangerous to make any kind of contact with any internal part of this product.		AC voltage: Rated voltage marked with this symbol is AC voltage.
	This symbol indicates that this product has included important literature concerning operation and maintenance.		DC voltage: Rated voltage marked with this symbol is DC voltage.
	Class II product: This symbol indicates that a safety connection to electrical earth (ground) is not required. If this symbol is not present on a product with a mains lead, the product MUST have a reliable connection to protective earth (ground).		Caution. Consult instructions for use: This symbol instructs the user to consult the user manual for further safety related information.

Electricity and Safety

Warning

- Do not use a damaged power cord or plug, or a loose power socket.
- Do not use multiple products with a single power socket.
- Do not touch the power plug with wet hands.
- Insert the power plug all the way in so it is not loose.
- Connect the power plug to a grounded power socket (type 1 insulated devices only).

- Do not bend or pull the power cord with force. Be careful not to leave the power cord under a heavy object.
- Do not place the power cord or product near heat sources.
- Clean any dust around the pins of the power plug or the power socket with a dry cloth.

Caution

- Do not disconnect the power cord while the product is being used.
- Only use the power cord provided with your product by Samsung. Do not use the power cord with other products.
- Keep the power socket where the power cord is connected unobstructed.
 - The power cord must be disconnected to cut off power to the product when an issue occurs.
- Hold the plug when disconnecting the power cord from the power socket.

Installation

Warning

- DO NOT PLACE CANDLES, INSECT REPELLANTS OR CIGARETTES ON TOP OF THE PRODUCT. DO NOT INSTALL THE PRODUCT NEAR HEAT SOURCES.
- Keep the plastic packaging out of the reach of children.
 - Children may suffocate.
- Do not install the product on an unstable or vibrating surface (insecure shelf, sloped surface, etc.)
 - The product may fall and become damaged and/or cause an injury.
 - Using the product in an area with excess vibration may damage the product or cause a fire.
- Do not install the product in a vehicle or a place exposed to dust, moisture (water drips, etc.), oil, or smoke.
- Do not expose the product to direct sunlight, heat, or a hot object such as a stove.
 - The product lifespan may be reduced or a fire may result.
- Do not install the product within the reach of young children.
 - The product may fall and injure children.
- Edible oil (such as soybean oil) may damage or distort the product. Keep the product away from oil pollution. And do not install or use the product in the kitchen or near the kitchen stove.

Caution

- Do not drop the product while moving.
- Do not set down the product on its front.
- When installing the product on a cabinet or shelf, make sure that the bottom edge of the front of the product is not protruding.
 - The product may fall and become damaged and/or cause an injury.
 - Install the product only on cabinets or shelves of the right size.
- Set down the product gently.
 - Product failure or personal injury may result.
- Installing the product in an unusual place (a place exposed to a lot of fine dust, chemical substances, extreme temperatures or a significant presence of moisture, or a place where the product will operate continuously for an extended period of time) may seriously affect its performance.
 - Be sure to consult Samsung Customer Service Centre if you want to install the product at such a place.
- Before assembling the product, place the product down on a flat and stable surface so that the screen is facing downwards.
 - The product is curved. Placing pressure on the product when on a flat surface may damage the product. When the product is on the ground facing up or down, do not put pressure on it.

Operation

Warning

- There is a high voltage inside the product. Never disassemble, repair or modify the product yourself.
 - Contact Samsung Customer Service Centre for repairs.
- To move the product, first disconnect all the cables from it, including the power cable.
- If the product generates abnormal sounds, a burning smell or smoke, disconnect the power cord immediately and contact Samsung Customer Service Centre.
- Do not let children hang from the product or climb on top of it.
 - Children may become injured or seriously harmed.
- If the product is dropped or the outer case is damaged, turn off the power and disconnect the power cord. Then contact Samsung Customer Service Centre.
 - Continued use can result in a fire or electric shock.

- Do not leave heavy objects or items that children like (toys, sweets, etc.) on top of the product.
 - The product or heavy objects may fall as children try to reach for the toys or sweets resulting in a serious injury.
- During a lightning or thunderstorm, power off the product and remove the power cable.
- Do not drop objects on the product or apply impact.
- Do not move the product by pulling the power cord or any cable.
- If a gas leakage is found, do not touch the product or power plug. Also, ventilate the area immediately.
- Do not lift or move the product by pulling the power cord or any cable.
- Do not use or keep combustible spray or an inflammable substance near the product.
- Ensure the vents are not blocked by tablecloths or curtains.
 - An increased internal temperature may cause a fire.
- Do not insert metallic objects (chopsticks, coins, hairpins, etc) or objects that burn easily (paper, matches, etc) into the product (via the vent or input/output ports, etc).
 - Be sure to power off the product and disconnect the power cord when water or other foreign substances have entered the product. Then contact Samsung Customer Service Centre.
- Do not place objects containing liquid (vases, pots, bottles, etc) or metallic objects on top of the product.
 - Be sure to power off the product and disconnect the power cord when water or other foreign substances have entered the product. Then contact Samsung Customer Service Centre.

Caution

- Leaving the screen fixed on a stationary image for an extended period of time may cause afterimage burn-in or defective pixels.
 - Set the screen to power-saving mode or moving-picture screen saver when not using the product for an extended period of time.
- Disconnect the power cord from the power socket if you do not plan on using the product for an extended period of time (vacation, etc).
 - Dust accumulation combined with heat can cause a fire, electric shock or electric leakage.
- Use the product at the recommended resolution and frequency.
 - Your eyesight may deteriorate.

- Do not hold the product upside-down or move it by holding the stand.
 - The product may fall and become damaged or cause an injury.
- Looking at the screen too close for an extended period of time can deteriorate your eyesight.
- Do not use humidifiers or stoves around the product.
- Rest your eyes for more than 5 minutes or look at distance objects for every 1 hour of product use.
- Do not touch the screen when the product has been turned on for an extended period of time as it will become hot.
- Store small accessories out of the reach of children.
- Exercise caution when adjusting the product angle or stand height.
 - Your hand or finger may get stuck and injured.
 - Tilting the product at an excessive angle may cause the product to fall and an injury may result.
- Do not place heavy objects on the product.
 - Product failure or personal injury may result.

Cleaning

High-glossy models can develop white stains on the surface if an ultrasonic wave humidifier is used nearby.

 Contact your nearest Samsung Customer Service Centre if you want to clean the inside of the product (Service fee will be charged.)

Do not press the product screen with hands or other objects. There is a risk of damaging the screen.

 Exercise care when cleaning as the panel and exterior of advanced LCDs are easily scratched.

Take the following steps when cleaning.

1. Power off the product and PC.
2. Disconnect the power cord from the product.
 -  Hold the power cable by the plug and do not touch the cable with wet hands. Otherwise, an electric shock may result.
3. Wipe the product with a clean, soft and dry cloth.

Wet a soft cloth in water, wring it out well, and then use the cloth to wipe the exterior of the product clean.

 - Do not apply a cleaning agent that contains alcohol, solvent, or surfactant to the product.
 - Do not spray water or detergent directly on the product.
4. Connect the power cord to the product when cleaning is finished.
5. Power on the product and PC.

Correct posture to use the product

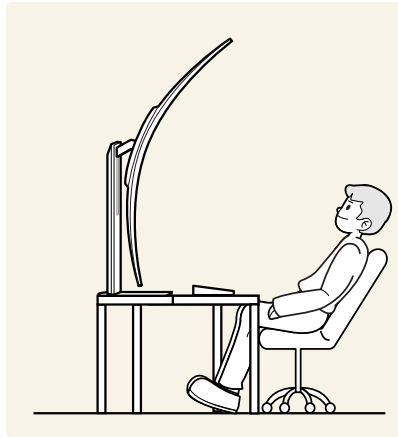
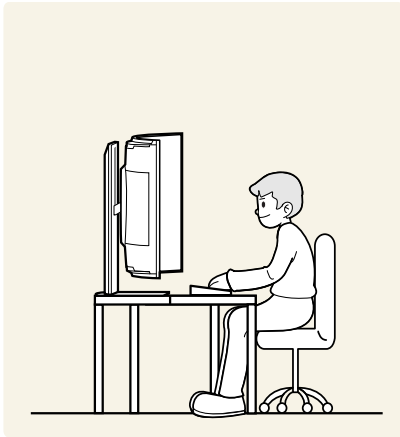

Use the product in the correct posture as follows:

- Straighten your back.
- The optimal viewing distance is over 80 cm.
- Keep your eyes directly in front of the screen.
- Adjust the angle so light does not reflect on the screen.
- Keep your forearms perpendicular to your upper arms and level with the back of your hands.
- Keep your elbows at about a right angle.
- Adjust the height of the product so you can keep your knees bent at 90 degrees or more, your heels attached to the floor, and your arms lower than your heart.
- Do the Eye exercises or blink frequently, then eye fatigue will be relieved.

Preparations

Installation

Attaching the Stand

 Before assembling the product, place the product down on a flat and stable surface so that the screen is facing downwards.

 Disassembly is the reverse order of assembly.

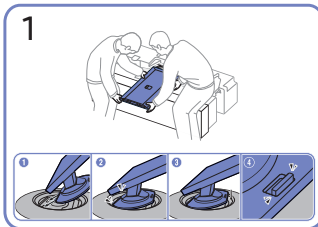
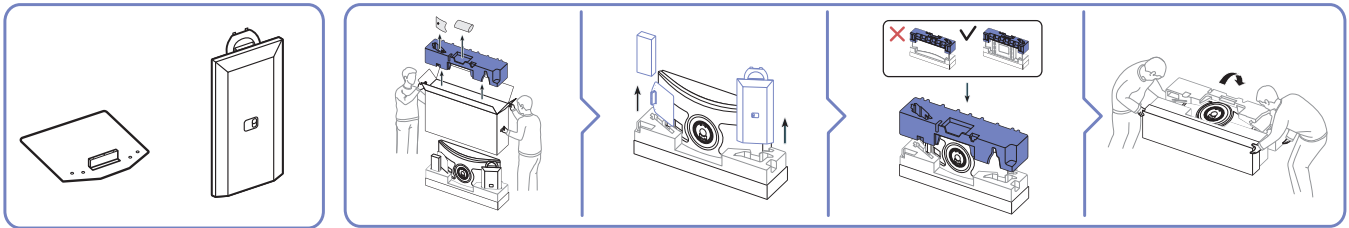

Push the stand neck into the main body in the direction of the arrow as shown in the figure.

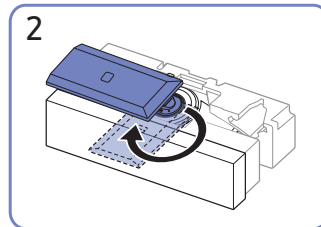

Turn the stand neck 90 degrees.

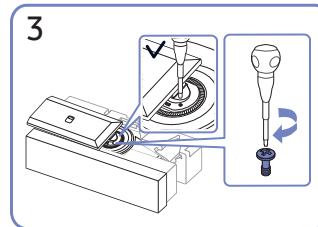

Tightly fasten the connecting screw at the centre of the stand neck.

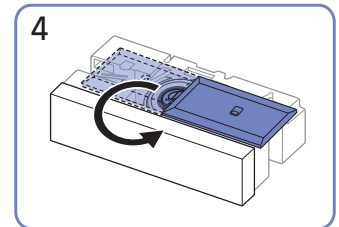

Turn the stand neck 180 degrees in the opposite direction.

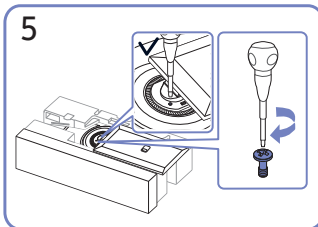

Tightly fasten the connecting screw at the centre of the stand neck.

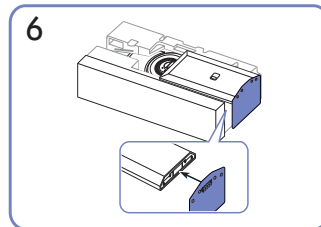

Put the stand base onto the stand neck as the direction shown in the figure. Check that the stand neck is firmly connected.

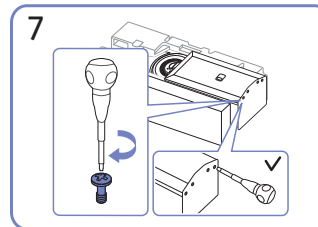

Tightly fasten the connecting screw at the bottom of the stand base.

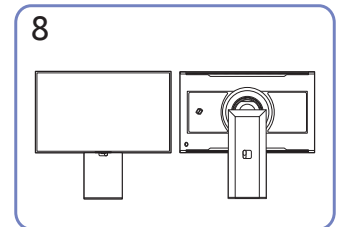

Stand assembly is complete.

Precautions for moving the product

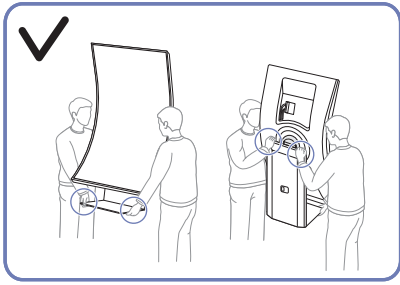

- Move the product by holding the stand bottom with one hand and the stand neck with the other.

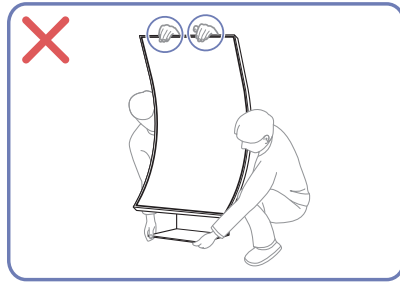

- Do not directly apply pressure on the screen.
- Do not hold the screen when moving the product.

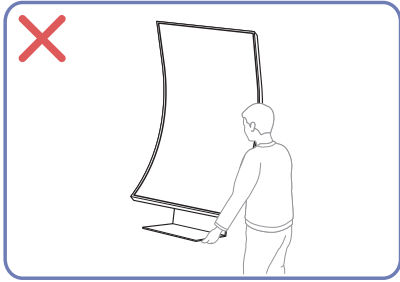

- The product is very heavy. Ensure that it is held by more than one person.



- Do not press down on the product. There is a risk of damaging the product.

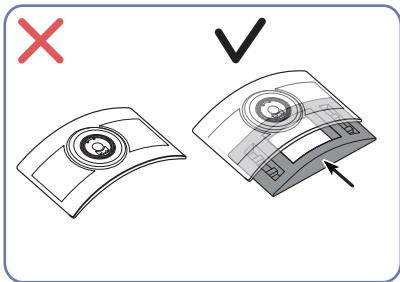

- Do not put the product on the floor with the cushion removed.

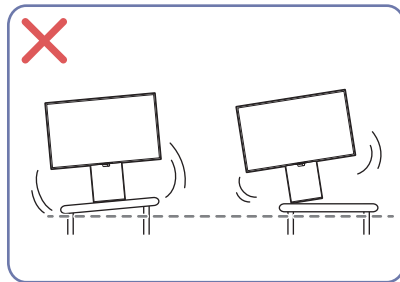

- Do not install the product on an unstable or vibrating surface (insecure shelf, sloped surface, etc.)
- When installing the product on a cabinet or shelf, make sure that the bottom edge of the front of the product is not protruding.

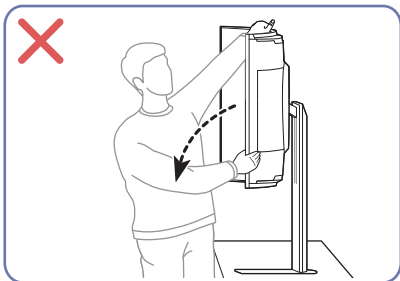

- Do not pull or hang onto the product.

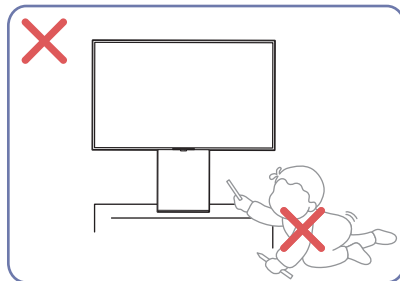

- Make sure that the product is kept out of the reach of children.

Checking the space around the product

Make sure to have enough space for ventilation when placing the product. An internal temperature rise may cause fire and damage the product. Maintain enough space around the product as shown in the diagram when installing the product.

 The exterior may differ depending on the product.

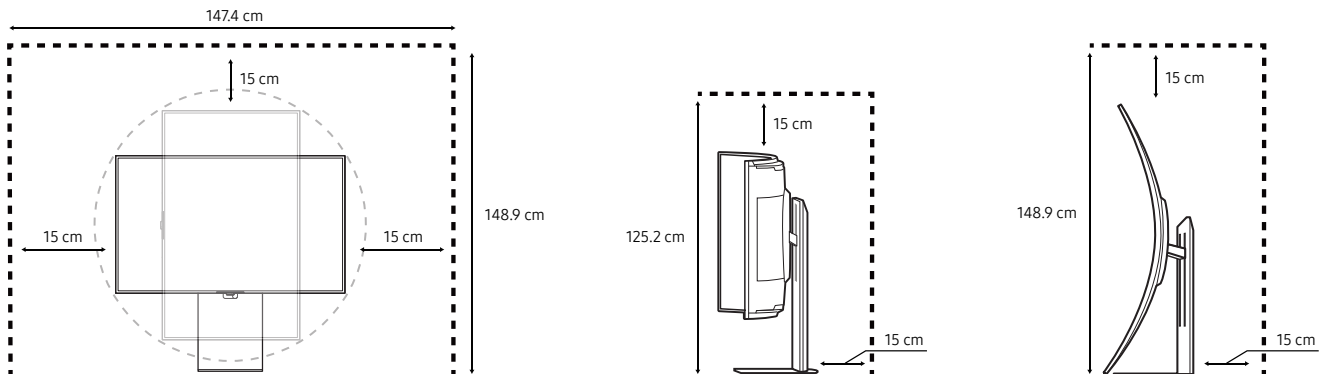

Adjusting the Product Tilt and Height

 The colour and shape of parts may differ from what is shown. Specifications are subject to change without notice to improve quality.

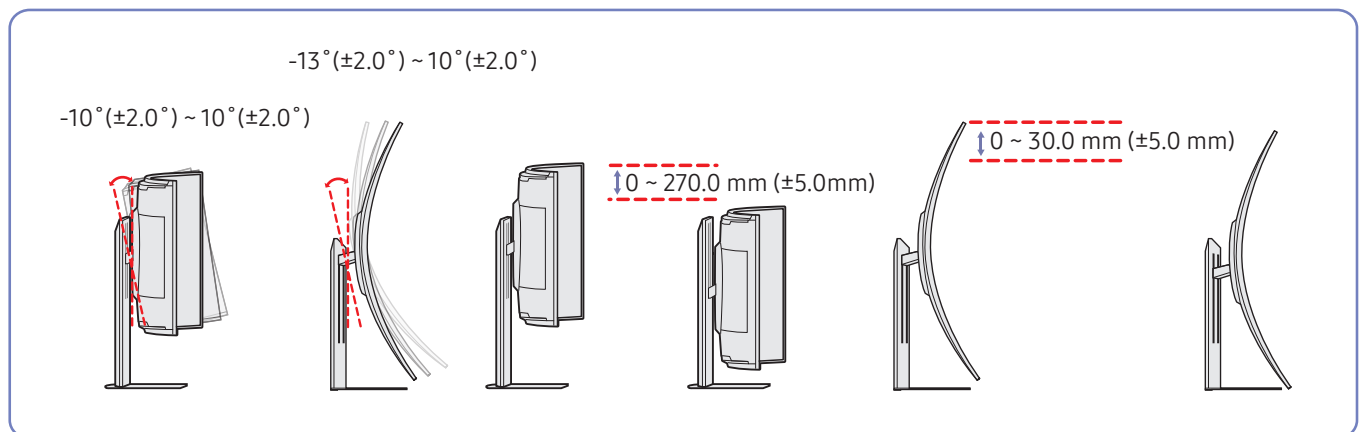

- The product tilt and height can be adjusted.
- The stand may slightly move at the stopped position while adjusting the height. This occurs as the pneumatic pressure is adjusted and is not a failure. This issue can be reduced by moving the product slowly.
- When adjusting the stand height, you may hear a noise. This noise is generated because the ball inside the stand slides when the stand height is adjusted. It is a normal noise and not a product malfunction.
- When adjusting the height, be careful and ensure that a cable is not caught in the gap.

Caution

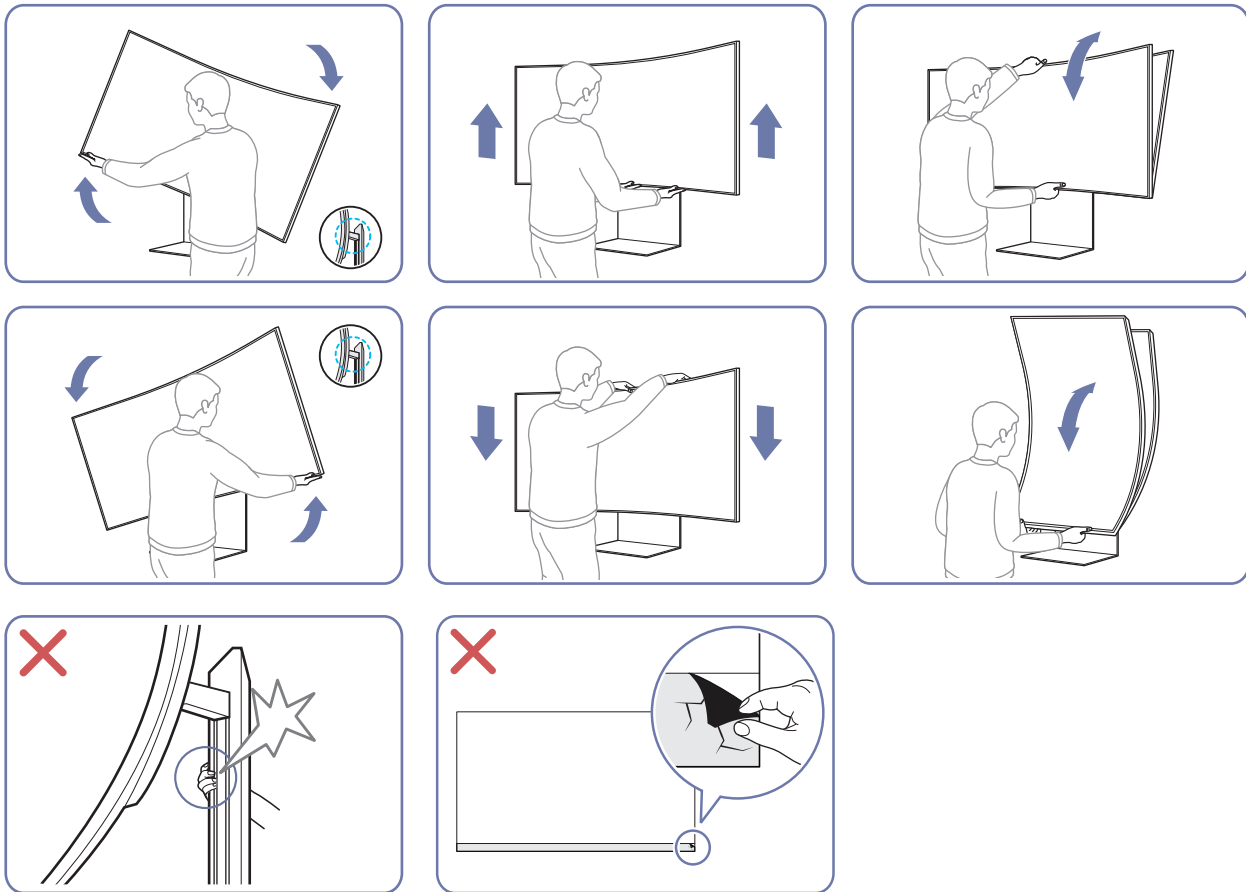

- Grasp the left and right sides of the monitor and adjust the swivel.
- Grasp the centre of the monitor and adjust the height.
- Do NOT hold the stand moving part with your hand when leveling the screen. Your hand may get hurt.
- Do not put an object around the lower part of the product. The product or object may get damaged when adjusting the product height.

After adjusting the product tilt and height, if the screen is not level, take the following actions.

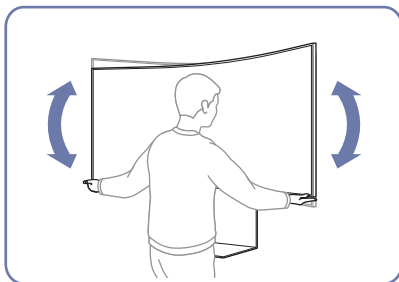

- Hold the bezel at both side edges and adjust the monitor angle until the screen becomes level. (Be careful not to directly hold the LCD display.)

Rotating the Product

 The colour and shape of parts may differ from what is shown. Specifications are subject to change without notice to improve quality.

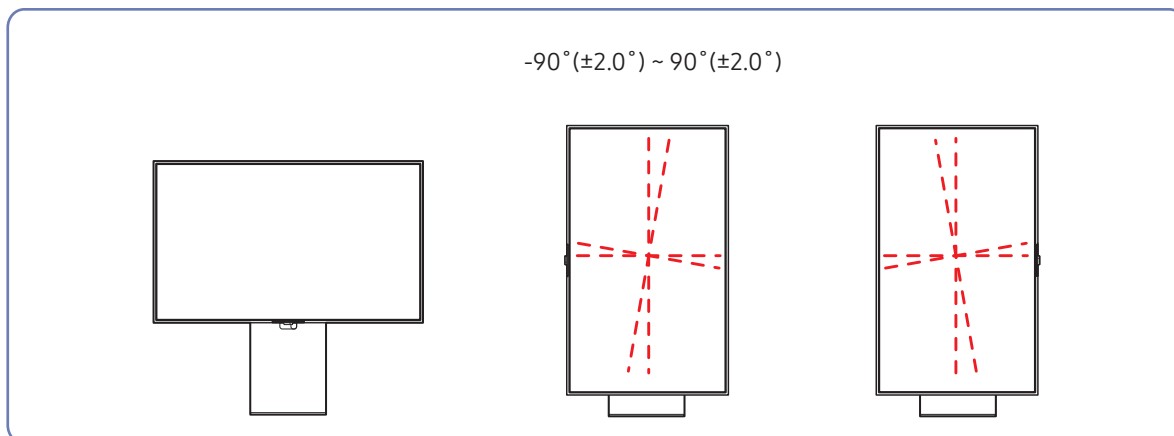

You can rotate your product as shown below.

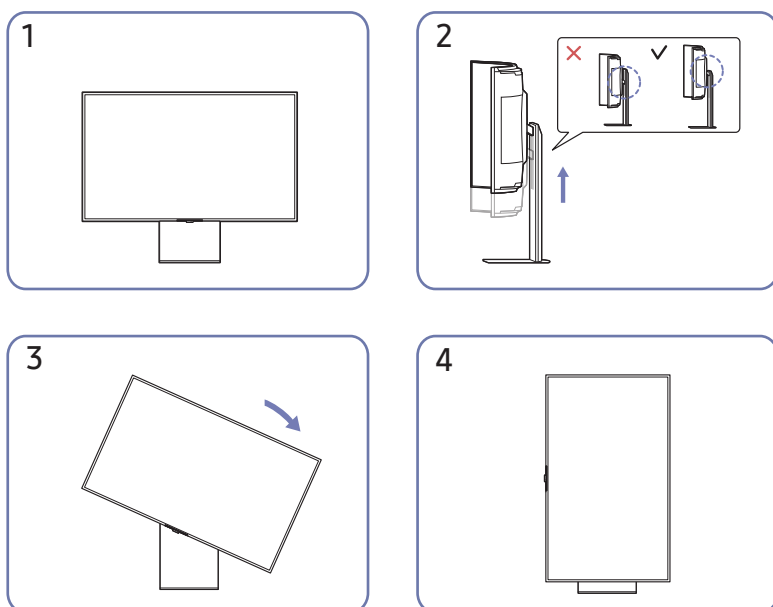

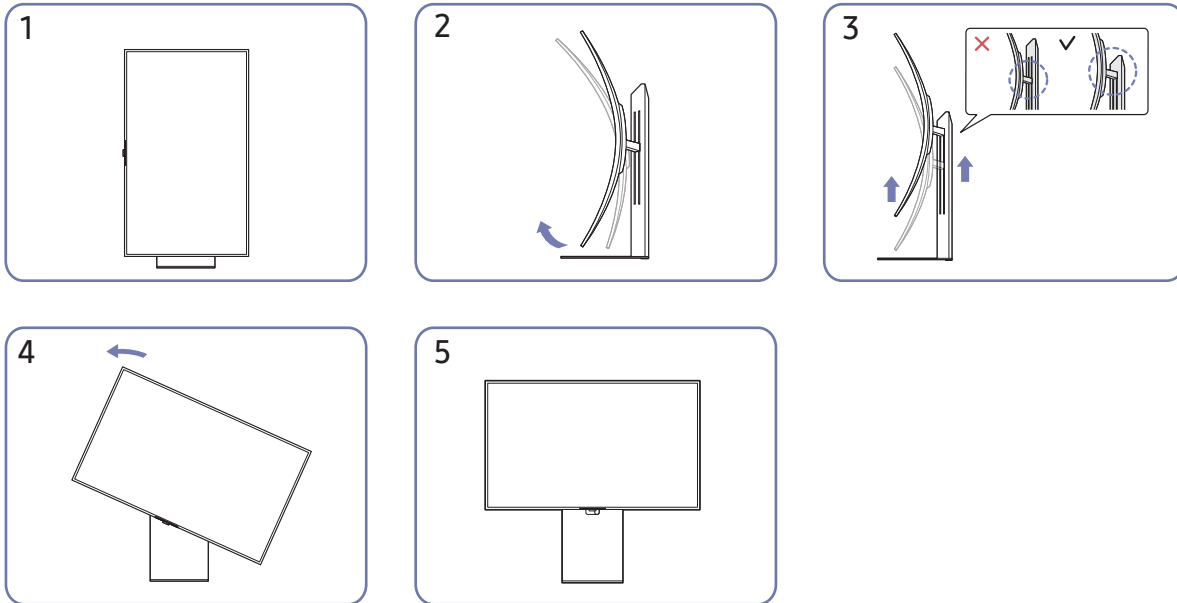

- Be sure to fully extend the stand before rotating the product.
- If the stand is not fully extended, the product may not be rotated due to the lock. If you rotate the product by force, the lock may become damaged.
- When rotating the product, be careful not to damage the product by hitting the object or stand.
- The product can be rotated left or right.
- After rotating the product, level it to fit the installation environment.

Attaching the BRACKET WALL

 The bracket may not be supplied, depending on the country and region.

 Power the product off and remove the power cable from the power socket.

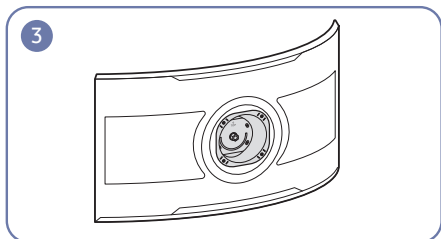
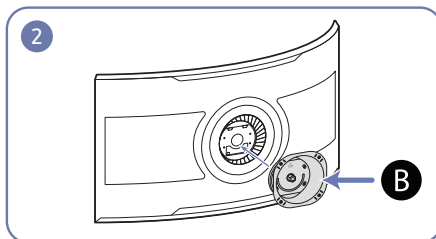
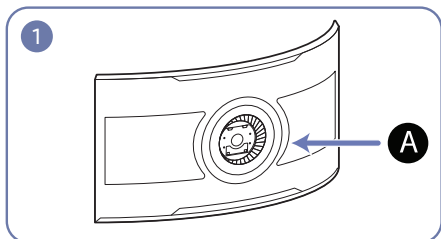

A Attach the BRACKET WALL here

B BRACKET WALL

Align **B** with **A** on the monitor, and tightly fasten the screws on **B**.

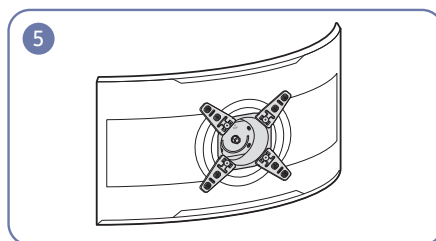
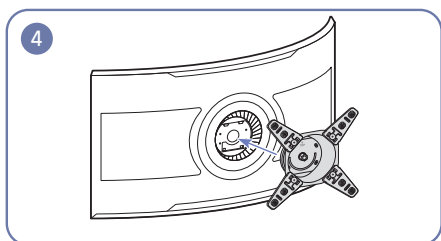
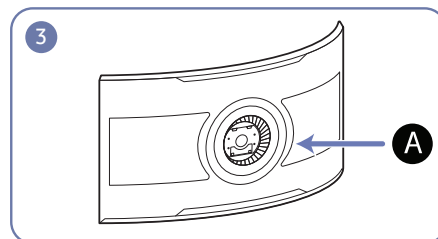
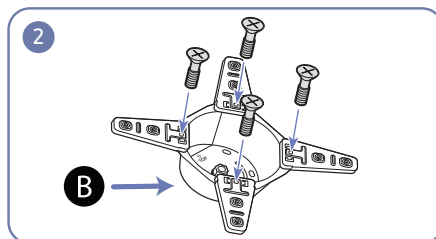
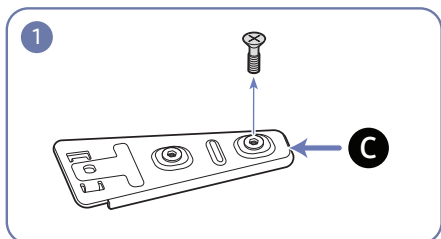

C Bracket Wall Sub

Remove the screws attached on **C**, and then use the removed screws to tighten **B** and **C**.

Align **B** with **A** on the monitor, and tightly fasten the screws on **B**.

Notes

- Using a screw longer than the standard length can damage the internal components of the product.
- The length of screws required for a wall mount that does not comply with the VESA standards may vary depending on the specifications.
- Do not use screws that do not comply with the VESA standards. Do not attach the wall-mount kit or desktop stand using excessive force. The product may get damaged or fall and cause personal injury. Samsung shall not be held liable for any damage or injury caused by using improper screws or attaching the wall-mount kit or desktop stand using excessive force.
- Samsung shall not be held liable for any product damage or personal injury caused by using a wall-mount kit other than the one specified or from an attempt to install the wall-mount kit on your own.
- To mount the product on a wall, ensure you purchase a wall-mount kit that can be installed 15 cm or farther away from the wall.
- Be sure to use a wall-mount kit that complies with the standards.
- To install the monitor using a wall mount, disconnect the stand base from the monitor.
- Do not mount the product at more than a 15 degree tilt.

Model name	VESA screw hole specs (A * B) in millimetres	C	Standard Screw	Quantity	
S55CG97*	200.0 x 200.0	8.0 ~ 10.0 mm	M8	4 EA	
Model name	VESA screw hole specs (A * B) in millimetres	C	Standard Screw	Quantity	
S55CG97*	300.0 x 300.0	8.0 ~ 10.0 mm	M8	4 EA	
	400.0 x 400.0				



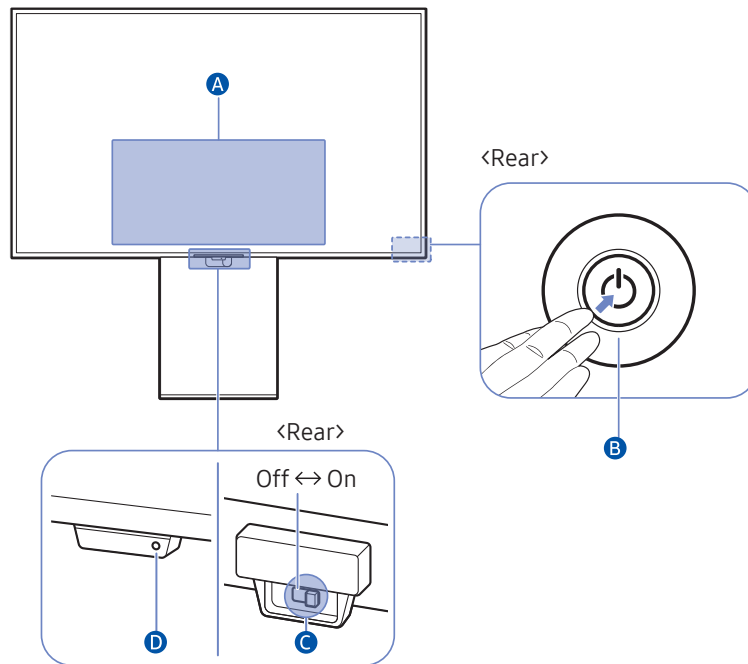

- The bracket may not be supplied, depending on the country and region.
- Do not install your Wall Mount Kit while your product is turned on. It may result in personal injury due to electric shock.

Control Panel

 You can turn on the product with the Power button at the rear of the product, and then use the Control menu. The Control menu appears when the Power button is pressed while the product is On.



A Control menu

-  Home
-  Settings
-  Return
-  Source
-  Power off

B Controller button

- Press  button: Display the Control menu. Select or run a focused item on the menu.
- Up/Down button: Moves up/down, or changes channels from a broadcast-related app.
- Left/Right button: Moves left/right, or changes the volume.

 The buttons may work differently depending on the situation.

C Microphone switch

You can turn on or off the microphone by using the switch at the bottom of the Product.

If microphone is turned off, All voice and sound features using microphone are not available.

- The position and shape of the microphone switch may differ depending on the model.
- During analysis using data from the microphone, the data is not saved.

D Power indicator

- The LED turns on when the product is turned off.
- The LED blinks when the product enters the standby mode.

 When 60 seconds elapses with no signal, the product enters the standby mode. In standby mode, the screen turns on again when any signal is input or any button is pressed on the remote control.

- The colour and shape of parts may differ from what is shown.
- When using the buttons (excluding Power) on the Samsung Smart Remote, the receiver LED does not blink.

Connections

Using various connectors, you can also connect external devices.

Read below before connecting the product.

1. Before connecting the product, check the shapes of both ports of the supplied signal cables and the shapes and locations of the ports on the product and external device.
2. Before connecting the product, make sure you remove the power cables from both the product and the external device to prevent damage to the product due to a short circuit or over current.
3. After all signal cables have been properly connected, connect the power cables back to the product and the external device.
4. After connecting is completed, make sure you read the manuals to acquaint yourself with the product functions, precautions and other information required to use the product properly.

Connecting the product to the One Connect

 The product turns off when the One Invisible Connection cable is disconnected, and turns on when it is connected.

-  Do not use the One Connect Box in the upside-down or upright position.
- Take care not to subject the cable to any of the actions below. The One Connect Cable contains a power circuit.



Bending



Twisting



Pulling



Pressing on



Electric shock







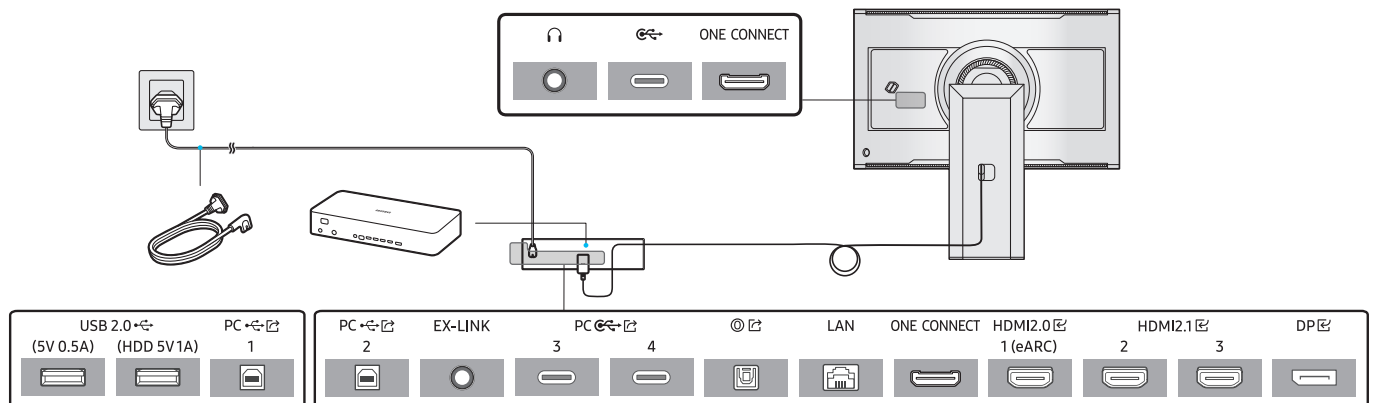

Providing proper ventilation for your Product

When you install your product and One Connect Box, maintain a distance of at least 10 cm between the One Connect Box with other objects (walls, cabinet sides, etc.) to ensure proper ventilation. Failing to maintain proper ventilation may result in a fire or a problem with the product caused by an increase in its internal temperature.

Ports

 The functions available may vary depending on the product model. The colour and shape of parts may differ from what is shown. Specifications are subject to change without notice to improve quality. Refer to the actual product.











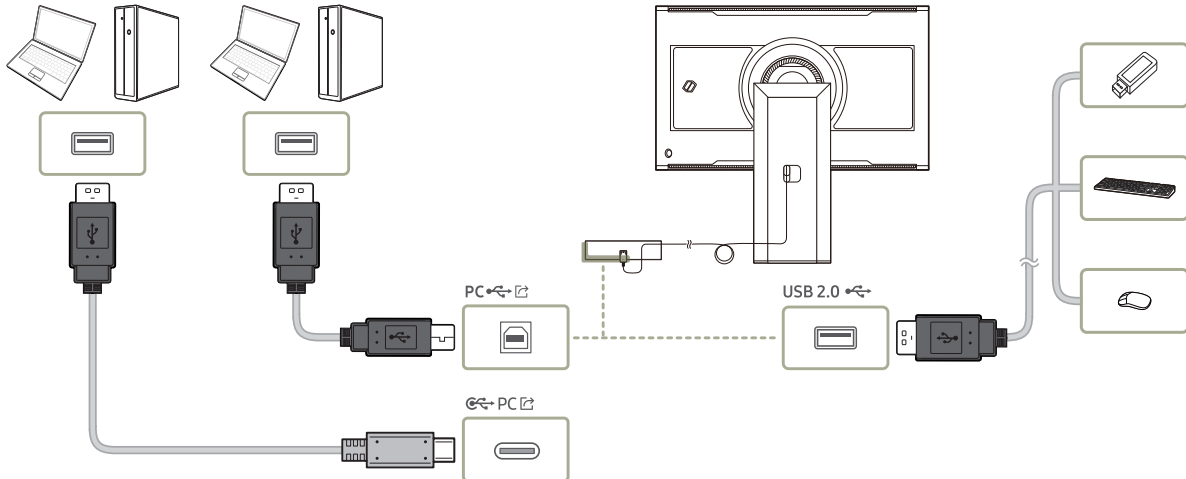



Port	Description
	Connect to an audio output device such as headphones or earphones.
	Connects to a USB camera.  This port does not support media content playback.  To play media content, use the USB port on the One Connect box.
USB 2.0  (5V 0.5A)	Connects to a USB device.  The USB ports on the product accept a maximum constant current of 0.5A. If the maximum value is exceeded, USB ports may not work.
USB 2.0  (HDD 5V1A)	Connects to a USB device or USB external hard drive.  The USB ports on the product accept a maximum constant current of 1.0A. If the maximum value is exceeded, USB ports may not work.
PC   1, 2	Connects to a PC, using a USB cable. This port is compatible with USB Type-B (USB 2.0) cables.  For more information about the USB Upstream, refer to “Connecting the Product to a PC as a USB HUB” .
EX-LINK	Dedicated to service technicians.
PC   3, 4	Connects to a PC, using a USB cable. This port is compatible with a USB Type-C cable. (USB hub connection is only supported.)  For more information about the USB Upstream, refer to “Connecting the Product to a PC as a USB HUB” .
	Connects to a audio device using the optical(digital) cable.
LAN	Use Cat7(*STP Type) cable for the connection. (10/100 Mbps) *Shielded Twisted Pair
ONE CONNECT	Use the provided One Invisible Connection to connect the product and One Connect.
HDMI2.0  1 (eARC) HDMI2.1  2, 3	Connects to a source device using a HDMI cable or HDMI-DVI cable.
DP 	Connects to a PC using a DP cable.

 For more information about connection to an external device, refer to [Home](#) > [Menu](#) > [Connected Devices](#) > [Connection Guide](#).

Connecting the Product to a PC as a USB HUB

Using the product as a hub, connect and use various source devices with the product at a time.



-  To detect and start a USB device faster, connect the USB device to the **USB 2.0** port on the product. The read/write rate will be affected by the USB device and your PC.
-  For USB-related problems caused by OS, drive programmes or software, please contact relevant suppliers.
-  With the launch of various USB devices on the market, we cannot guarantee that our products are matched with all USB devices.
-  When connecting an external hard drive, use the **USB (HDD 5V1A)** port. We recommend that you use an external hard drive with its own power adapter.
-  If there are multiple USB devices connected to the product, the product might not be able to recognize some or all the devices. USB devices that use high-power input should be connect to the **USB (HDD 5V1A)** port.
-  The battery can be charged in the power-saving mode, but it cannot be charged when the product is powered off.
-  Charging your USB device is not possible if the power cable is disconnected from the power socket.
-  The company is not liable for problems or damages to an external device caused by using an unauthorised cable for the connection.
-  Some products do not follow the USB standard, and it may cause a malfunction of the device.
-  For details on how to set the port by USB source and configure specific settings, refer to the **USB Input Port Setup** section in the e-Manual embedded in the product.
-  To switch the mouse, connected to the product, between multiple PCs connected to the product, ensure the **ESB (Easy Setting Box)** software is installed on the PCs. Details on how to install and use ESB can be found at www.samsung.com.

Tidying Up the Connected Cables

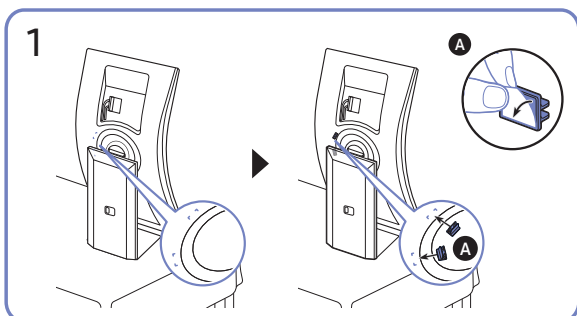
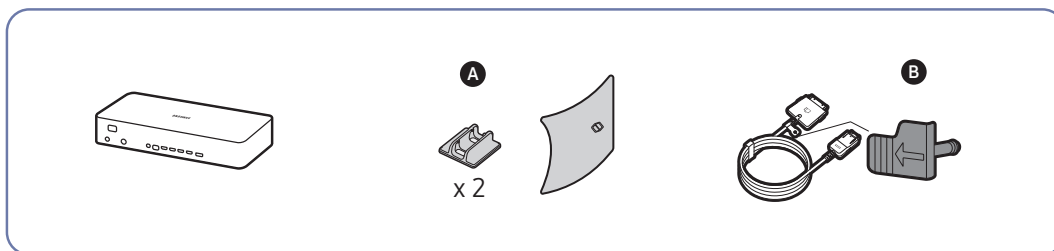

Attach the cable guides to the groove on the back of the monitor.

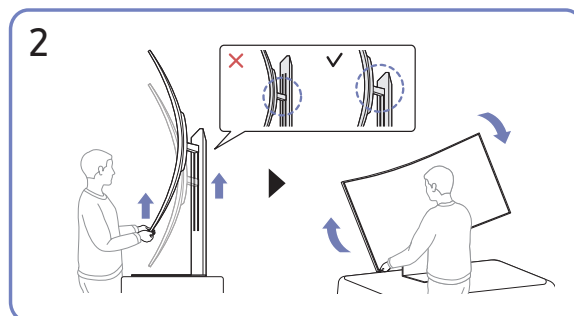

Raise the stand neck to its full height, and then rotate the monitor clockwise to switch it to landscape mode.

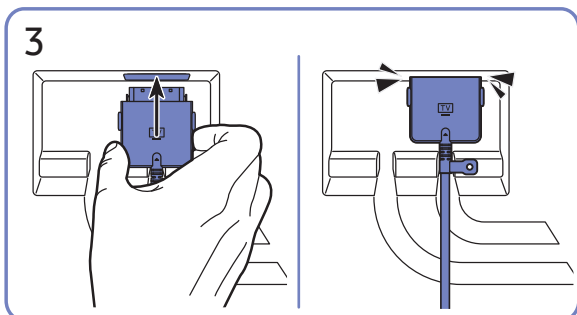

Connect the cables to the corresponding ports.

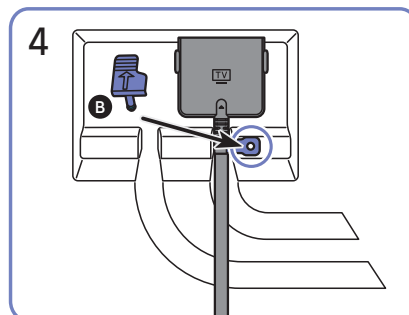

Insert the cable holder into the hole to fix the cables.

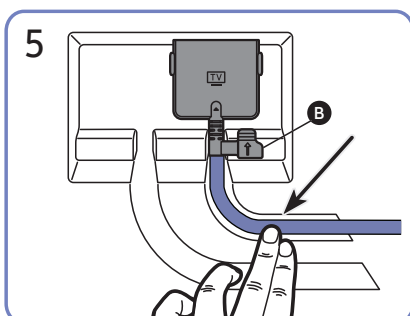

Push the cables into the grooves to tidy them up.

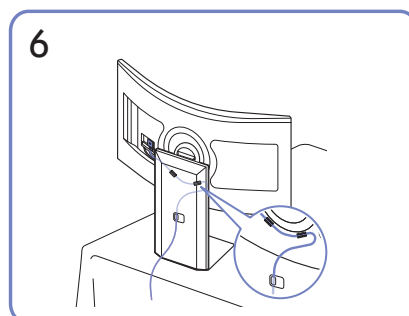

Pass the cables through the cable guides to tidy them up.

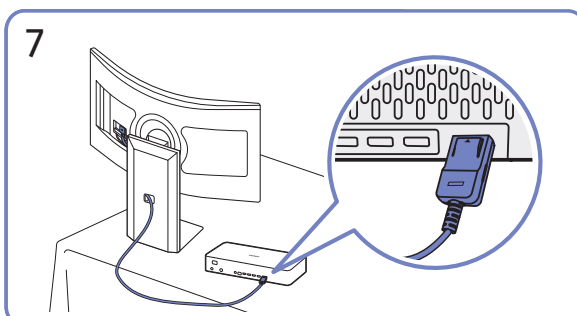

Connect the cables to One Connect.

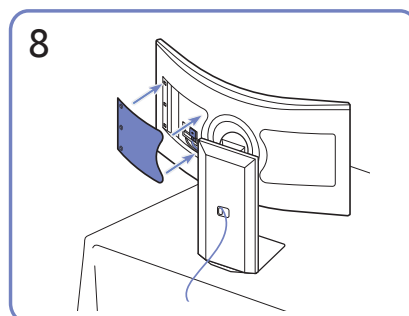

Close the rear cover to finish the process.

Precautions and Notes

You can get instructions and information that you must read after installation.

Read After Installing the product

Read this information after installing the product.

Picture sizes and input signals



The **Picture Size** is applied to the current source. The applied **Picture Size** will remain in effect whenever you select that source unless you change them.

When connecting an external input device

Input signal	Picture size
HDMI / DP (720p)	16:9 Standard, Custom, 4:3 Screen Size
HDMI / DP (1080i, 1080p)	16:9 Standard, Custom, 4:3 Screen Size
HDMI / DP (3840 x 2160p)	16:9 Standard, Custom
HDMI / DP (2560 x 1080p)	21:9 Wide Screen in Game Mode
HDMI / DP (3840 x 1600p @ 60 Hz)	21:9 Wide Screen in Game Mode
HDMI / DP (3840 x 1080p)	32:9 Wide Screen in Game Mode

When playing media files stored in a USB device



Input signal	Picture size
USB (720p)	16:9 Standard, Custom, 4:3 Screen Size
USB (1080i/p @ 60 Hz)	16:9 Standard, Custom, 4:3 Screen Size
USB (3840 x 2160p @ 24/30 Hz)	16:9 Standard, Custom
USB (3840 x 2160p @ 60 Hz)	16:9 Standard, Custom

-  The input ports for external devices may differ depending on the model and geographical area.
-  Available **Picture Size** may differ depending on the external device.
-  If the aspect ratio does not change although the display size has been set to 32:9 or 21:9 Wide Screen, change the display size from the connected external device

Read Before Connecting a Computer (Supported Resolutions)

Check the resolutions supported for PC input signals.

When you connect your product to a computer, set the computer's video card to one of the standard resolutions listed in the tables below or on the next pages. The product will automatically adjust to the resolution you choose. Note that the optimal and recommended resolutions are 3840 x 2160 at 165 Hz. Choosing a resolution not included in the tables can result in a blank screen or just the remote control sensor turning on. Refer to the user manual of your graphics card for compatible resolutions.

-  The native resolution is 3840 x 2160 at 165 Hz with the **Game Mode** set to **On**.
-  The native resolution is 3840 x 2160 at 120 Hz with the **Game Mode** set to **Off** and **Input Signal Plus** is **On**.
-  The native resolution is 3840 x 2160 at 30 Hz with the **Game Mode** set to **Off** and **Input Signal Plus** is **Off**.

VESA DMT

Resolution (Dots x lines)	Horizontal frequency (KHz)	Vertical frequency (Hz)	Clock frequency (MHz)	Polarity (horizontal / vertical)	HDMI IN
640 x 480	31.469	59.940	25.175	-/-	0
640 x 480	37.500	75.000	31.500	-/-	0
800 x 600	37.87	60.317	40.000	+/+	0
800 x 600	48.077	72.188	50.000	+/+	0
800 x 600	46.875	75.000	49.500	+/+	0
1024 x 768	48.363	60.004	65.000	-/-	0
1024 x 768	56.476	70.069	75.000	-/-	0
1024 x 768	60.023	75.029	78.750	+/+	0
1152 x 864	67.500	75.000	108.000	+/+	0
1280 x 720	45.000	60.000	74.250	+/+	0
1280 x 800	49.702	59.810	83.500	-/+	0
1280 x 1024	63.981	60.020	108.000	+/+	0
1280 x 1024	79.976	75.025	135.000	+/+	0
1440 x 900	55.935	59.887	106.500	-/+	0
1600 x 900	60.000	60.000	108.000	+/+	0
1680 x 1050	65.290	59.954	146.250	-/+	0

VESA CVT

Resolution (Dots x lines)	Horizontal frequency (KHz)	Vertical frequency (Hz)	Clock frequency (MHz)	Polarity (horizontal / vertical)	HDMI IN
2560 x 1440	88.787	59.951	241.500	+/-	0
1920 x 1080	192.788	164.917	401.000	+/-	0
2560 x 1440	182.996	119.998	497.750	+/-	0
2560 x 1440	257.169	164.958	699.500	+/-	0
3840 x 2160	385.750	164.991	1543.000	+/-	0

Supported Resolutions for Video Signals

Check the resolutions supported for video signals.

CTA-861

Resolution (Dots x lines)	Horizontal frequency (KHz)	Vertical frequency (Hz)	Clock frequency (MHz)	Polarity (horizontal / vertical)	HDMI IN
720 x 480	31.469	59.940	27.000	-/-	0
1280 x 720	45.000	60.000	74.250	+/+	0
1920 x 1080	67.500	60.000	148.500	+/+	0
1920 x 1080	135.000	120.000	297.000	+/+	0
3840 x 2160	67.500	30.000	297.000	+/+	0
3840 x 2160	135.000	60.000	594.000	+/+	0
3840 x 2160	270.000	120.000	1188.000	+/+	0

Specifications

General

Model Name		S55CG97*
Size		138.7 cm
Display area		1209.6 mm (H) x 680.4 mm (V)
Pixel Pitch		0.315 mm (H) x 0.315 mm (V)
Maximum Pixel Frequency		74.267985 MHz
Synchronization (PANEL Spec)	Horizontal Frequency	115.488 ~ 397.155 Khz
	Vertical Frequency	48 ~ 165 Hz
Resolution	Optimum Resolution	3840 x 2160 @ 165 Hz
	Maximum Resolution	(HDMI1: 3840 x 2160 @ 60 Hz)
Power Supply		AC100-240V~ 50/60Hz Refer to the label at the back of the product as the standard voltage can vary in different countries.
Signal connectors		HDMI DP
Environmental conditions		Operating Temperature: 0 °C to 40 °C (32 °F to 104 °F) Humidity: 10 % to 80 %, non-condensing
		Storage Temperature: -20 °C to 45 °C (-4 °F to 113 °F) Humidity: 5 % to 95 %, non-condensing

- Plug-and-Play

This product can be installed and used with any Plug-and-Play compatible systems. Two-way data exchange between the product and PC system optimises the product settings. Product installation takes place automatically. However, you can customise the installation settings if desired.

- Panel Dots (Pixels)

Due to the nature of the manufacturing of this product, approximately 1 pixel per million (1ppm) may be brighter or darker on the LCD panel. This does not affect product performance.

- The specifications are subject to change without notice to improve quality.

- For detailed device specifications, visit the Samsung website.

Appendix

Responsibility for the Pay Service (Cost to Customers)

When the service is requested, in spite of in warranty, we may charge you for a visit from a service technician in the following cases.

Not a product defect

Cleaning of the product, Adjustment, Explanation, Re-installation and etc.

- If a service technician is requested to give instructions on how to use product or simply adjusts options without disassembling product.
- If a defect is caused by external environmental factors (Internet, Antenna, Wired Signal, etc.)
- If a product is reinstalled or devices are connected additionally after installing the purchased product for the first time.
- If a product is reinstalled to move to a different spot or to move to a different house.
- If the customer requests instructions on how to use another company's product.
- If customer requests instructions on how to use the network or another company's Programme.
- If customer requests software installation and setup for the product.
- If a service technician removes/cleans dusts or foreign materials inside of the product.
- If customer requests an installation additionally after purchasing a product through home-shopping or online.

A Product damage caused by customer's fault

Product damage caused by customer's mishandling or wrong repair

If a product damage is caused by;

- External impact or drop.
- Use of supplies or separately sold product unspecified by Samsung.
- Repair from a person besides an engineer of outsourcing service company or partner of Samsung Electronics Co., Ltd.
- Remodeling or repairing the product by customer.
- Using it with incorrect voltage or non-authorized electrical connections.
- Not following the "cautions" in User Manual.

Others

- If product fails by natural disaster. (lightning, fire, earthquake, flood damage, etc)
 - If consumable components are all used up. (Battery, Toner, Fluorescent lights, Head, Vibrator, Lamp, Filter, Ribbon, etc.)
-  If customer requests a service in case the product has no defect, service fee may be charged. So please read User Manual first.

FreeSync (for AMD graphics card)





FreeSync technology is a solution that eliminates screen tearing without all the usual lag and latency.

This feature will eliminate screen tearing and lag during game play. Improve your gaming experience.



- **Game Mode - Off:** Disable **FreeSync**.
- **Game Mode - On:** Turn on the AMD graphics cards' **FreeSync** function. You may experience intermittent flickers when playing some games.

Apply the optimum resolution when using **FreeSync**.

The refresh rate setting method please refer to Q & A → [How can I change the frequency?](#)

-  This menu is not available when **Multi View Mode** is enabled.
-  The **FreeSync** feature is only enabled in **HDMI** (with the exception of the HDMI2.0 eARC port) or **DP** mode. Use the HDMI cable provided by the manufacturer when using **FreeSync**.
-  If the **FreeSync** function is in use and the text displayed on the PC screen looks blurry or corrupted, resolve the issue by changing the resolution of the PC screen to the recommended resolution.
-  If you set the **HDMI Mode** to **1.4**, the **FreeSync Premium pro** function is disabled.

If you use the **FreeSync** function while playing a game, the following symptoms may occur:

- The screen may flicker depending on the type of graphics card, the game option settings, or the video being played. Try the following actions: decrease the game setting values, change the current **Game Mode** to **Off**, or visit the AMD website to check your graphics driver's version and update it with the latest one.
- While you are using the **FreeSync** function, the screen may flicker due to variation of the output frequency from the graphics card.
- The response rate during the game may fluctuate depending on the resolution. A higher resolution generally decreases the response rate.
- The sound quality of the monitor may be degraded.
-  If you encounter any issues when using the function, contact the Samsung Service Centre.
-  If you change the screen resolution while the function is **On**, the screen may intermittently blank out due to the graphics card. Set **Game Mode** to **Off** and change the resolution.
-  The function is unavailable in the devices (e.g. AV devices) that have no AMD graphics card. If the function is applied, the screen may malfunction.

The models in the Graphics Cards list supports FreeSync

FreeSync can only be used with specific AMD graphics card models. Refer to the following list for supported graphics cards:

Make sure to install the latest official graphics drivers from AMD that support **FreeSync**.



For additional AMD graphics card models that support the **FreeSync** feature, visit the official AMD website.



When applying the **FreeSync** function via the HDMI cable, it may fail to work due to the bandwidth limitation of certain AMD graphics card.

- Radeon™ RX Vega series
- Radeon™ RX 500 series
- Radeon™ RX 400 series
- Radeon™ R9/R7 300 series (excluding R9 370/ X, R7 370/X, R7 265)
- AMD Radeon™ 5500 Series
- AMD Radeon™ 5700 Series
- Radeon™ Pro Duo (2016 edition)
- Radeon™ R9 Nano series
- Radeon™ R9 Fury series
- Radeon™ R9/R7 200 series (excluding R9 270/ X, R9 280/X)
- AMD Radeon™ 5600 Series
- AMD Radeon™ RX 6000 Series
- AMD Radeon™ RX 7000 Series