

MGB-TLB10-AO

Planet® MGB-TLB10 Compatible TAA 1000Base-BX SFP Transceiver (SMF, 1490nmTx/1310nmRx, 10km, LC, DOM, -40 to 85C)

Features

- INF-8074 and SFF-8472 Compliance
- Simplex LC Connector
- Industrial Temperature -40 to 85 Celsius
- Single-mode Fiber
- Hot Pluggable
- Excellent ESD Protection
- Metal with Lower EMI
- RoHS Compliant and Lead Free



Applications

- 1x Fibre Channel
- 1000Base-BX Ethernet
- Access (FTTx) and Enterprise

Product Description

This Planet® MGB-TLB10 compatible SFP transceiver provides 1000Base-BX throughput up to 10km over single-mode fiber (SMF) using a wavelength of 1490nmTx/1310nmRx via an LC connector. It is guaranteed to be 100% compatible with the equivalent Planet® transceiver. This easy to install, hot swappable transceiver has been programmed, uniquely serialized and data-traffic and application tested to ensure that it will initialize and perform identically. Digital optical monitoring (DOM) support is also present to allow access to real-time operating parameters. This transceiver is Trade Agreements Act (TAA) compliant. We stand behind the quality of our products and proudly offer a limited lifetime warranty.

AddOn's transceivers are RoHS compliant and lead-free.

TAA refers to the Trade Agreements Act (19 U.S.C. & 2501-2581), which is intended to foster fair and open international trade. TAA requires that the U.S. Government may acquire only "U.S. – made or designated country end products."



Regulatory Compliance

- ESD to the Electrical PINs: compatible with MIL-STD-883E Method 3015.4
- ESD to the LC Receptacle: compatible with IEC 61000-4-3
- EMI/EMC compatible with FCC Part 15 Subpart B Rules, EN55022:2010
- Laser Eye Safety compatible with FDA 21CFR, EN60950-1& EN (IEC) 60825-1,2
- RoHS compliant with EU RoHS 2.0 directive 2015/863/EU

Absolute Maximum Ratings

Parameter	Symbol	Min.	Typ.	Max.	Unit	Notes
Maximum Supply Voltage	V _{CC}	-0.5		4.0	V	1
Storage Temperature	T _S	-40		85	°C	2
Operating Case Temperature	T _C	-40		+85	°C	
Operating Humidity	RH	5		85	%	
Bit Error Rate	BER			10 ⁻¹²		
Data Rate	DR		1.25		Gbps	3
	DR		1.062		Gbps	4

Notes:

1. For electrical power interface
2. Ambient temperature
3. IEEE 802.3
4. FC-PI-2 Rev7.0

Electrical Characteristics (V_{CC}=3.14V to 3.46V, T_C=-40 °C to +85 °C)

Parameter	Symbol	Min.	Typ.	Max.	Unit	Notes
Power Supply Voltage	V _{CC}	3.14	3.3	3.46	V	
Power Supply Current	I _{CC}		200	300	mA	1
Transmitter						
Input differential impedance	R _{IN}		100		Ω	
Single ended data input swing	V _{IN_PP}	250		1200	mV	
Transmit disable voltage	V _D	V _{CC} -1.3		V _{CC}	V	
Transmit enable voltage	V _{EN}	V _{EE}		V _{EE} +0.8	V	
Transmit disable assert time				10	μs	
Receiver						
Single ended data output swing	V _{OUT_PP}	300	400	800	mV	
Data output rise/fall time (20%-80%)	t _r /t _f			300	ps	
LOS Assert	V _{LOS_A}	V _{CC} -0.5		V _{CC_HOST}	V	
LOS De-Assert	V _{LOS_D}	V _{EE}		V _{EE} +0.5	V	

Notes:

1. For electrical power interface

Optical Characteristics

Parameter	Symbol	Min.	Typ.	Max.	Unit	Notes
Transmitter						
Output Optical Power	PTX	-9		-3	dBm	1
Optical Center Wavelength	λ_c	1470	1490	1510	nm	
Optical Modulation Amplitude	OMA	174			μ W	2
Extinction Ratio	ER	9			dB	
Spectral Width (-20dB)	$\Delta\lambda$			1	nm	
Side Mode Suppression Ratio	SMSR	30				
Optical Rise/Fall Time (20%-80%)	t_r/t_f		150	260	ps	
Relative Intensity Noise	RIN			-120	dB/Hz	
Deterministic Jitter Contribution	DJ		30	60	ps	
Total Jitter Contribution	TJ		60	120	ps	
Receiver						
Receiver Overload	POL	-3			dBm	
Optical Center Wavelength	λ_c	1260		1360	nm	
Receiver Sensitivity @ 1.063Gb/s	RX_SEN1			-19.5	dBm	3
Receiver Sensitivity @ 1.25Gb/s	RX_SEN2			-19.5	dBm	4
Optical Return Loss	ORL	14			dB	
Optical Isolation	ISO	35			dB	
LOS Assert	LOS _A	-30			dBm	
LOS De-Assert	LOS _D			-24	dBm	
LOS Hysteresis	LOS _H	0.5			dB	

Notes:

1. Class 1 Product
2. Equivalent extinction ratio specification for FC
3. FC-PI-2 Rev7.0 2.
4. IEEE 802.3

Pin Descriptions

Pin	Symbol	Name/Descriptions	Ref.
1	VEET	Transmitter ground (common with receiver ground)	1
2	TX_FAULT	Transmitter Fault. Not supported	
3	TX_DISABLE	Transmitter Disable. Laser output disabled on high or open	2
4	MOD_DEF(2)	Module Definition 2. Data line for serial ID	3
5	MOD_DEF(1)	Module Definition 1. Clock line for serial ID	3
6	MOD_DEF(0)	Module Definition 0. Grounded within the module	3
7	Rate Select	No connection required	
8	LOS	Loss of Signal indication. Logic 0 indicates normal operation	4
9	VEER	Receiver ground (common with transmitter ground)	1
10	VEER	Receiver ground (common with transmitter ground)	1
11	VEER	Receiver ground (common with transmitter ground)	1
12	RD-	Receiver Inverted DATA out. AC coupled	
13	RD+	Receiver Non-inverted DATA out. AC coupled	
14	VEER	Receiver ground (common with transmitter ground)	1
15	VCCR	Receiver power supply	
16	VCCT	Transmitter power supply	
17	VEET	Transmitter ground (common with receiver ground)	1
18	TD+	Transmitter Non-Inverted DATA in. AC coupled	
19	TD-	Transmitter Inverted DATA in. AC coupled	
20	VEET	Transmitter ground (common with receiver ground)	1

Notes:

1. Circuit ground is isolated from chassis ground
2. Disabled: $T_{DIS} > 2V$ or open, Enabled: $T_{DIS} < 0.8V$
3. Should Be pulled up with 4.7k –10k ohm on host board to a voltage between 2V and 3.6V
4. LOS is open collector output



Pin-out of connector Block on Host board

Block Diagram of Transceiver

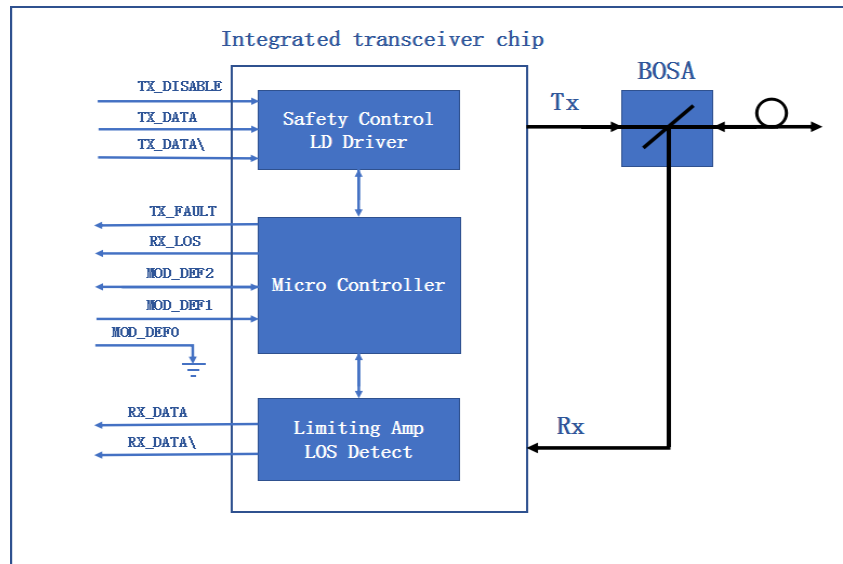

Mechanical Specifications

Small Form Factor Pluggable (SFP) transceivers are compatible with the dimensions defined by the SFP Multi-Sourcing Agreement (MSA).



EEPROM Information

EEPROM memory map specific data field description is as below:



Digital Diagnostic Functions

This transceiver supports the 2-wire serial communication protocol as defined in SFP MSA. Digital diagnostic information is accessible over the 2-wire interface at the address 0xA2. Digital diagnostics are internally calibrated by default. The internal micro control unit accesses the device operating parameters in real time, such as transceiver temperature, laser bias current, transmitted optical power, received optical power and transceiver supply voltage. The module implements the alarm function of the SFP MSA, alerts the user when a particular operating parameter exceeds the factory-set normal range.

Parameter	Symbol	Accuracy	Report Range		Unit	Notes
Temperature	Temp	±3	-40	95	°C	
Voltage	VCC	±0.1	2.7	3.9	V	
Bias Current	Ibias	±10	1	80	mA	
Tx Power	P _{TX}	±3	-12	2	dBm	
Rx Power	P _{RX}	±3	-30	0	dBm	

About AddOn Networks

In 1999, AddOn Networks entered the market with a single product. Our founders fulfilled a severe shortage for compatible, cost-effective optical transceivers that compete at the same performance levels as leading OEM manufacturers. Adhering to the idea of redefining service and product quality not previously had in the fiber optic networking industry, AddOn invested resources in solution design, production, fulfillment, and global support.

Combining one of the most extensive and stringent testing processes in the industry, an exceptional free tech support center, and a consistent roll-out of innovative technologies, AddOn has continually set industry standards of quality and reliability throughout its history.

Reliability is the cornerstone of any optical fiber network and is engrained in AddOn's DNA. It has played a key role in nurturing the long-term relationships developed over the years with customers. AddOn remains committed to exceeding industry standards with certifications from ranging from NEBS Level 3 to ISO 9001:2005 with every new development while maintaining the signature reliability of its products.

U.S. Headquarters

Email: sales@addonnetworks.com

Telephone: +1 877.292.1701

Fax: 949.266.9273

Europe Headquarters

Email: salesupportemea@addonnetworks.com

Telephone: +44 1285 842070