



SUPERSERVER®

5018D-MHR7N4P



USER'S MANUAL

1.0

The information in this User's Manual has been carefully reviewed and is believed to be accurate. The vendor assumes no responsibility for any inaccuracies that may be contained in this document, makes no commitment to update or to keep current the information in this manual, or to notify any person or organization of the updates. **Please Note: For the most up-to-date version of this manual, please see our web site at www.supermicro.com.**

Super Micro Computer, Inc. ("Supermicro") reserves the right to make changes to the product described in this manual at any time and without notice. This product, including software and documentation, is the property of Supermicro and/or its licensors, and is supplied only under a license. Any use or reproduction of this product is not allowed, except as expressly permitted by the terms of said license.

IN NO EVENT WILL SUPERMICRO BE LIABLE FOR DIRECT, INDIRECT, SPECIAL, INCIDENTAL, SPECULATIVE OR CONSEQUENTIAL DAMAGES ARISING FROM THE USE OR INABILITY TO USE THIS PRODUCT OR DOCUMENTATION, EVEN IF ADVISED OF THE POSSIBILITY OF SUCH DAMAGES. IN PARTICULAR, SUPERMICRO SHALL NOT HAVE LIABILITY FOR ANY HARDWARE, SOFTWARE, OR DATA STORED OR USED WITH THE PRODUCT, INCLUDING THE COSTS OF REPAIRING, REPLACING, INTEGRATING, INSTALLING OR RECOVERING SUCH HARDWARE, SOFTWARE, OR DATA.

Any disputes arising between manufacturer and customer shall be governed by the laws of Santa Clara County in the State of California, USA. The State of California, County of Santa Clara shall be the exclusive venue for the resolution of any such disputes. Super Micro's total liability for all claims will not exceed the price paid for the hardware product.

FCC Statement: This equipment has been tested and found to comply with the limits for a Class A digital device pursuant to Part 15 of the FCC Rules. These limits are designed to provide reasonable protection against harmful interference when the equipment is operated in a commercial environment. This equipment generates, uses, and can radiate radio frequency energy and, if not installed and used in accordance with the manufacturer's instruction manual, may cause harmful interference with radio communications. Operation of this equipment in a residential area is likely to cause harmful interference, in which case you will be required to correct the interference at your own expense.

California Best Management Practices Regulations for Perchlorate Materials: This Perchlorate warning applies only to products containing CR (Manganese Dioxide) Lithium coin cells. "Perchlorate Material-special handling may apply. See www.dtsc.ca.gov/hazardouswaste/perchlorate"

WARNING: Handling of lead solder materials used in this product may expose you to lead, a chemical known to the State of California to cause birth defects and other reproductive harm.

Manual Revision 1.0
Release Date: July 18, 2017

Unless you request and receive written permission from Super Micro Computer, Inc., you may not copy any part of this document.

Information in this document is subject to change without notice. Other products and companies referred to herein are trademarks or registered trademarks of their respective companies or mark holders.

Copyright © 2017 by Super Micro Computer, Inc.
All rights reserved.

Printed in the United States of America

Preface

About This Manual

This manual is written for professional system integrators and PC technicians. It provides information for the installation and use of the SuperServer 5018D-MHR7N4P. Installation and maintenance should be performed by experienced technicians only.

The SuperServer 5018D-MHR7N4P is a high-end server based on the SC-813MFTQC-R407CB rackmountable chassis and the X10SDV-7TP4F SoC motherboard.

Manual Organization

Chapter 1: Introduction

The first chapter provides a checklist of the main components included with the server system and describes the main features of the X10SDV-7TP4F motherboard and the SC813MFTQC-R407CB chassis.

Chapter 2: Server Installation

This chapter describes the steps necessary to install the SuperServer 5018D-MHR7N4P into a rack and check out the server configuration prior to powering up the system. If your server was ordered without processor and memory components, this chapter will refer you to the appropriate sections of the manual for their installation.

Chapter 3: System Interface

Refer here for details on the system interface, which includes the functions and information provided by the control panel on the chassis as well as other LEDs located throughout the system.

Chapter 4: Standardized Warning Statements

You should thoroughly familiarize yourself with this chapter for a general overview of safety precautions that should be followed when installing and servicing the SuperServer 5018D-MHR7N4P.

Chapter 5: Advanced Motherboard Setup

Chapter 5 provides detailed information on the X10SDV-7TP4F motherboard, including the locations and functions of connections, headers and jumpers. Refer to this chapter when adding or removing processors or main memory and when reconfiguring the motherboard.

Chapter 6: Advanced Chassis Setup

Refer to Chapter 6 for detailed information on the SC813MFTQC-R407CB server chassis. You should follow the procedures given in this chapter when installing, removing or reconfiguring hard drives and when replacing system power supply units and cooling fans.

Chapter 7: BIOS

The BIOS chapter includes an introduction to BIOS and provides detailed information on running the CMOS Setup Utility.

Appendix A: BIOS Error Beep Codes

Appendix B: System Specifications

Appendix C: UEFI BIOS Recovery Instructions

Notes

Table of Contents

Chapter 1 Introduction

1-1	Overview	1-1
1-2	Motherboard Features	1-2
	Processor	1-2
	Memory	1-2
	SATA	1-2
	PCI Expansion Slots	1-2
	Rear I/O Ports	1-2
	Graphics Controller	1-2
1-3	Server Chassis Features	1-3
	System Power	1-3
	Hard Drive Subsystem	1-3
	Front Control Panel	1-3
1-4	Contacting Supermicro	1-5

Chapter 2 Server Installation

2-1	Overview	2-1
2-2	Unpacking the System	2-1
2-3	Preparing for Setup	2-1
	Choosing a Setup Location	2-1
2-4	Warnings and Precautions	2-2
	Rack Precautions	2-2
	Server Precautions	2-2
	Rack Mounting Considerations	2-3
	Ambient Operating Temperature	2-3
	Reduced Airflow	2-3
	Mechanical Loading	2-3
	Circuit Overloading	2-3
	Reliable Ground	2-3
2-5	Installing the System into a Rack	2-4
	Identifying the Sections of the Rack Rails	2-4
	Installing the Rack Rails	2-4
	Installing the Server into the Rack	2-5
	Installing the Server into a Telco Rack	2-6

Chapter 3 System Interface

3-1	Overview	3-1
3-2	Control Panel Buttons	3-2
3-3	Control Panel LEDs	3-2

3-4	Drive Carrier LEDs.....	3-4
Chapter 4 Standardized Warning Statements for AC Systems		
4-1	About Standardized Warning Statements.....	4-1
	Warning Definition.....	4-1
	Installation Instructions.....	4-4
	Circuit Breaker.....	4-5
	Power Disconnection Warning.....	4-6
	Equipment Installation.....	4-8
	Restricted Area.....	4-9
	Battery Handling.....	4-10
	Redundant Power Supplies.....	4-12
	Backplane Voltage.....	4-13
	Comply with Local and National Electrical Codes.....	4-14
	Product Disposal.....	4-15
	Hot Swap Fan Warning.....	4-16
	Power Cable and AC Adapter.....	4-18
Chapter 5 Advanced Motherboard Setup		
5-1	Handling the Motherboard.....	5-1
	Precautions.....	5-1
5-2	Connecting Cables.....	5-2
	Connecting Data Cables.....	5-2
	Connecting Power Cables.....	5-2
	Connecting the Control Panel.....	5-2
5-3	I/O Ports.....	5-3
5-4	Installing Memory.....	5-4
5-5	Adding PCI Expansion Cards.....	5-5
5-6	Motherboard Details.....	5-6
	X10SDV-7TP4F Quick Reference.....	5-7
5-7	Connector Definitions.....	5-9
5-8	Jumper Settings.....	5-16
5-9	Onboard Indicators.....	5-19
5-10	SAS/SATA/M.2 Ports.....	5-21
5-11	Installing Drivers.....	5-22
	SuperDoctor® 5.....	5-23
5-13	Onboard Battery.....	5-24
Chapter 6 Advanced Chassis Setup		
6-1	Static-Sensitive Devices.....	6-1
	Precautions.....	6-1

	Unpacking	6-1
6-2	Control Panel	6-2
6-3	System Fans	6-3
6-4	Drive Bay Installation/Removal	6-3
	SATA Drive Installation.....	6-4
	SATA Backplane.....	6-5
6-5	Power Supply	6-7
	Power Supply Failure.....	6-7

Chapter 7 BIOS

7-1	Introduction.....	7-1
	Starting BIOS Setup Utility.....	7-1
	How To Change the Configuration Data	7-1
	How to Start the Setup Utility	7-2
7-2	Main Setup.....	7-2
7-3	Advanced Setup Configurations.....	7-4
7-4	Event Logs	7-28
7-5	IPMI.....	7-30
7-6	Security Settings	7-33
7-7	Boot Settings.....	7-36
7-8	Save & Exit	7-38

Appendix A BIOS Error Beep Codes

Appendix B System Specifications

Appendix C UEFI BIOS Recovery Instructions

Chapter 1

Introduction

1-1 Overview

The SuperServer 5018D-MHR7N4P is an embedded system comprised of two main subsystems: the SC813MFTQC-R407CB 1U chassis and the X10SDV-7TP4F single processor motherboard. Please refer to our website for information on operating systems that have been certified for use with the system (www.supermicro.com).

In addition to the motherboard and chassis, various hardware components have been included with the 5018D-MHR7N4P, as listed below:

- One 4-cm fan (FAN-0065L4)
- One riser card (RSC-RR1U-E8)
- One special I/O shield (MCP-260-00100-0B)

Note: For your system to work properly, please follow the links below to download all necessary drivers/utilities and the user's manual for your server.

- Supermicro product manuals: <http://www.supermicro.com/support/manuals/>
- Product drivers and utilities: <ftp://ftp.supermicro.com>
- Product safety info: http://www.supermicro.com/about/policies/safety_information.cfm

If you have any questions, please contact our support team at: support@supermicro.com

1-2 Motherboard Features

The SuperServer 5018D-MHR7N4P is built around the X10SDV-7TP4F, a single processor motherboard designed to provide maximum performance. Below are the main features of the X10SDV-7TP4F. (See Figure 1-1 for a block diagram).

Processor

The X10SDV-7TP4F supports a single Intel® Xeon® D-1537 1.7GHz-2.3GHz, 35W SoC processor (SoC = System on a Chip).

Memory

The X10SDV-7TP4F has four DIMM slots that can support up to 128 GB of ECC RDIMM (Registered DIMM) or 64 GB of ECC/non-ECC UDIMM (Unregistered DIMM) DDR4-2133/1866/1600 memory. See Chapter 5 for details.

SATA

A SATA controller is integrated into the chipset to provide four SATA 3.0 (6/Gbps) ports.

PCI Expansion Slots

The X10SDV-7TP4F has one M.2 PCI-E 3.0 x4 slot, an M Key for 2242/2280/22110 SSDs (Mux with I-SATA4) and one mini PCI-E 2.0 x1 slot with mSATA support (Mux with I-SATA5).

Rear I/O Ports

The rear I/O ports include a VGA port, two USB 3.0 ports, two 10 Gb SFP+ (Small Form-factor Pluggable) Ethernet LAN ports, two Gb Ethernet (RJ45) LAN ports and a dedicated IPMI LAN port.

Graphics Controller

The X10SDV-7TP4F features an integrated AST 2400 graphics controller.

1-3 Server Chassis Features

The SC813MFTQC-R407CB is an mini-ITX form factor chassis designed to be used in a 1U rackmount configuration. The following is a general outline of the main features of the SC813MFTQC-R407CB server chassis.

System Power

The SC813MFTQC-R407CB features a redundant 400W power supply. This power redundancy feature allows you to replace a failed power supply without shutting down the system.

Hard Drive Subsystem

The SC813MFTQC-R407CB was designed to support four hot-swappable 3.5" hard drives. Drives mount in carriers and may be removed and installed without powering down the system.

Front Control Panel

The control panel on the SC813MFTQC-R407CB provides you with system monitoring and control. LEDs indicate system power, HDD activity, network activity and system information (Information LED). A main power button and a system reset button are also included.

**Figure 1-1. X10SDV-7TP4F:
System Block Diagram**

Note: This is a general block diagram. Please see Chapter 5 for details.

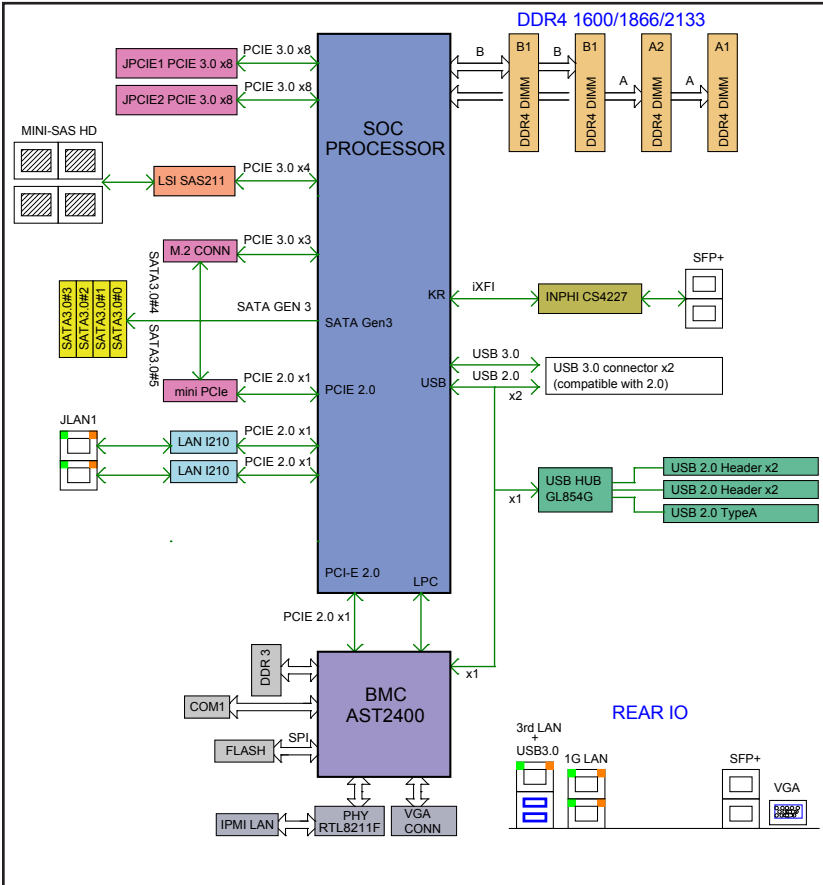

1-4 Contacting Supermicro

Headquarters

Address: Super Micro Computer, Inc.
980 Rock Ave.
San Jose, CA 95131 U.S.A.

Tel: +1 (408) 503-8000

Fax: +1 (408) 503-8008

Email: marketing@supermicro.com (General Information)
support@supermicro.com (Technical Support)

Web Site: www.supermicro.com

Europe

Address: Super Micro Computer B.V.
Het Sterrenbeeld 28, 5215 ML
's-Hertogenbosch, The Netherlands

Tel: +31 (0) 73-6400390

Fax: +31 (0) 73-6416525

Email: sales@supermicro.nl (General Information)
support@supermicro.nl (Technical Support)
rma@supermicro.nl (Customer Support)

Web Site: www.supermicro.nl

Asia-Pacific

Address: Super Micro Computer, Inc.
3F, No. 150, Jian 1st Rd.
Zhonghe Dist., New Taipei City 235
Taiwan (R.O.C)

Tel: +886-(2) 8226-3990

Fax: +886-(2) 8226-3992

Email: support@supermicro.com.tw

Web Site: www.supermicro.com.tw

Notes

Chapter 2

Server Installation

2-1 Overview

This chapter provides a quick setup checklist to get your SuperServer 5018D-MHR7N4P up and running. Following the steps in the order given should enable you to have the system operational within a minimal amount of time. This quick setup assumes that your system has come to you with the processor and memory preinstalled. If your system is not already fully integrated with a motherboard, processor, system memory etc., please turn to the chapter or section noted in each step for details on installing specific components.

2-2 Unpacking the System

You should inspect the box the 5018D-MHR7N4P was shipped in and note if it was damaged in any way. If the server itself shows damage, you should file a damage claim with the carrier who delivered it.

Decide on a suitable location for the rack unit that will hold the system. It should be situated in a clean, dust-free area that is well ventilated. Avoid areas where heat, electrical noise and electromagnetic fields are generated. You will also need it placed near a grounded power outlet. Read the Rack and Server Precautions in the next section.

2-3 Preparing for Setup

The box the system was shipped in should include two sets of rail assemblies, six rail mounting brackets and the mounting screws you will need to install the system into the rack. Follow the steps in the order given to complete the installation process in a minimal amount of time. Please read this section in its entirety before you begin the installation procedure outlined in the sections that follow.

Choosing a Setup Location

- Leave enough clearance in front of the rack to enable you to open the front door completely (~25 inches) and approximately 30 inches of clearance in the back of the rack to allow for sufficient airflow and ease in servicing. This product is for

installation only in a Restricted Access Location (dedicated equipment rooms, service closets and the like).

- This product is not suitable for use with visual display work place devices according to §2 of the German Ordinance for Work with Visual Display Units.

2-4 Warnings and Precautions

Rack Precautions

- Ensure that the leveling jacks on the bottom of the rack are fully extended to the floor with the full weight of the rack resting on them.
- In single rack installation, stabilizers should be attached to the rack. In multiple rack installations, the racks should be coupled together.
- Always make sure the rack is stable before extending a component from the rack.
- You should extend only one component at a time - extending two or more simultaneously may cause the rack to become unstable.

Server Precautions

- Review the electrical and general safety precautions in Chapter 4.
- Determine the placement of each component in the rack *before* you install the rails.
- Install the heaviest server components on the bottom of the rack first, and then work up.
- Use a regulating uninterruptible power supply (UPS) to protect the server from power surges, voltage spikes and to keep your system operating in case of a power failure.
- Allow the hot plug SATA drives and power supply modules to cool before touching them.
- Always keep the rack's front door and all panels and components on the servers closed when not servicing to maintain proper cooling.

Rack Mounting Considerations

Ambient Operating Temperature

If installed in a closed or multi-unit rack assembly, the ambient operating temperature of the rack environment may be greater than the ambient temperature of the room. Therefore, consideration should be given to installing the equipment in an environment compatible with the manufacturer's maximum rated ambient temperature (T_{mra}).

Reduced Airflow

Equipment should be mounted into a rack so that the amount of airflow required for safe operation is not compromised.

Mechanical Loading

Equipment should be mounted into a rack so that a hazardous condition does not arise due to uneven mechanical loading.

Circuit Overloading

Consideration should be given to the connection of the equipment to the power supply circuitry and the effect that any possible overloading of circuits might have on overcurrent protection and power supply wiring. Appropriate consideration of equipment nameplate ratings should be used when addressing this concern.

Reliable Ground

A reliable ground must be maintained at all times. To ensure this, the rack itself should be grounded. Particular attention should be given to power supply connections other than the direct connections to the branch circuit (i.e. the use of power strips, etc.).



Warning! To prevent bodily injury when mounting or servicing this unit in a rack, you must take special precautions to ensure that the system remains stable. The following guidelines are provided to ensure your safety:

- This unit should be mounted at the bottom of the rack if it is the only unit in the rack.
- When mounting this unit in a partially filled rack, load the rack from the bottom to the top with the heaviest component at the bottom of the rack.
- If the rack is provided with stabilizing devices, install the stabilizers before mounting or servicing the unit in the rack.

2-5 Installing the System into a Rack

This section provides information on installing the SuperServer 5018D-MHR7N4P into a rack unit with the rack rails provided. If the server has already been mounted into a rack, you can skip ahead to Sections 2-5 and 2-6.

There are a variety of rack units on the market, which may mean the assembly procedure will differ slightly. You should also refer to the installation instructions that came with the rack unit you are using.

Identifying the Sections of the Rack Rails

You may have received rack rail hardware with the SuperServer 5018D-MHR7N4P. Two front inner rails should already be attached to the chassis. Note that these two rails are left/right specific.

Locking Tabs: Both chassis rails have a locking tab, which serves two functions. The first is to lock the server into place when installed and pushed fully into the rack, which is its normal position.

Installing the Rack Rails

Determine where you want to place the SuperServer 5018D-MHR7N4P in the rack ([see Rack and Server Precautions in Section 2-3](#)). Position the chassis rail guides at the desired location in the rack, keeping the sliding rail guide facing the inside of the rack. Screw the assembly securely to the rack using the brackets provided. Attach the other assembly to the other side of the rack, making sure that both are at the exact same height and with the rail guides facing inward.



Warning: do not pick up the server with the front handles. They are designed to pull the system from a rack only.

Installing the Server into the Rack

Install the server into the rack by lining up the rear of the chassis rails with the front of the rack rails. Slide the chassis rails into the rack rails, keeping the pressure even on both sides (you may have to depress the locking tabs when inserting). See Figure 2-2.

When the server has been pushed completely into the rack, you should hear the locking tabs "click".

**Figure 2-2. Installing the Server into a Rack
(with optional front bezel shown)**

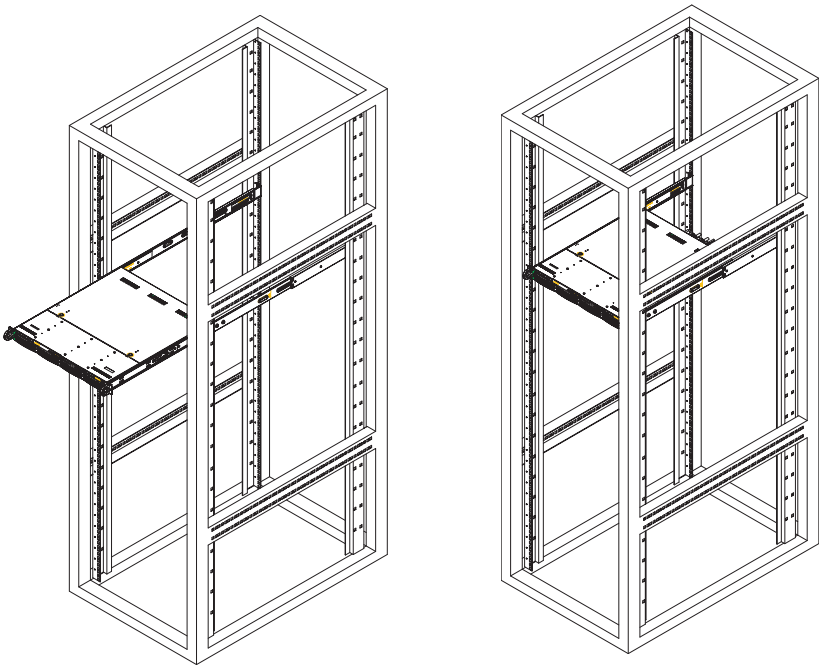

Note: figures are for illustrative purposes only. Always install servers starting from the bottom of a rack first.



Stability hazard. The rack stabilizing mechanism must be in place, or the rack must be bolted to the floor before you slide the unit out for servicing. Failure to stabilize the rack can cause the rack to tip over.

Installing the Server into a Telco Rack

To install the SuperServer 5018D-MHR7N4P into a Telco type rack, use two L-shaped brackets on either side of the chassis (four total). First, determine how far the server will extend out the front of the rack. Larger chassis should be positioned to balance the weight between front and back. If a bezel is included on your server, remove it. Then attach the two front brackets to each side of the chassis, then the two rear brackets positioned with just enough space to accommodate the width of the rack. Finish by sliding the chassis into the rack and tightening the brackets to the rack.

**Figure 2-3. Installing the Server into a Telco Rack
(with optional front bezel shown)**

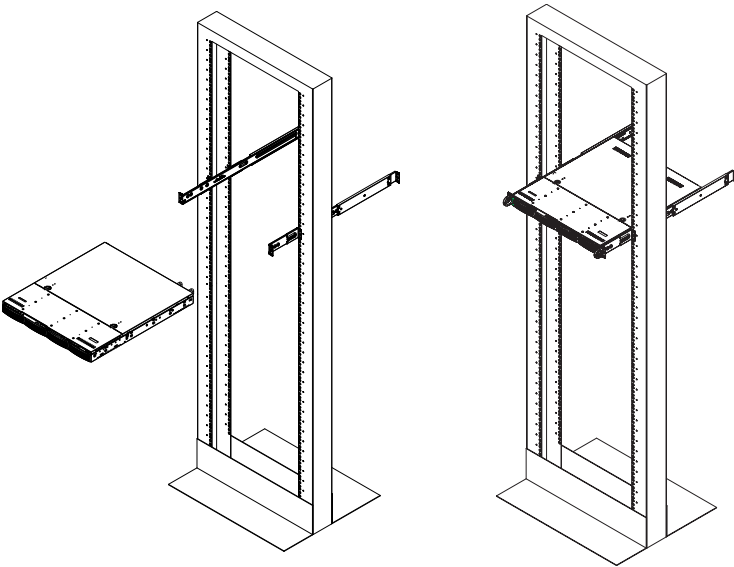

Note: figures are for illustrative purposes only. Always install servers starting from the bottom of a rack first.

Chapter 3

System Interface

3-1 Overview

There are several LEDs on the control panel as well as others on the drive carriers to keep you constantly informed of the overall status of the system as well as the activity and health of specific components. Most SC813M models have two push-buttons on the control panel: a reset button and an on/off switch. This chapter covers these buttons, and explains the meanings of all LED indicators and the appropriate responses you may need to take.

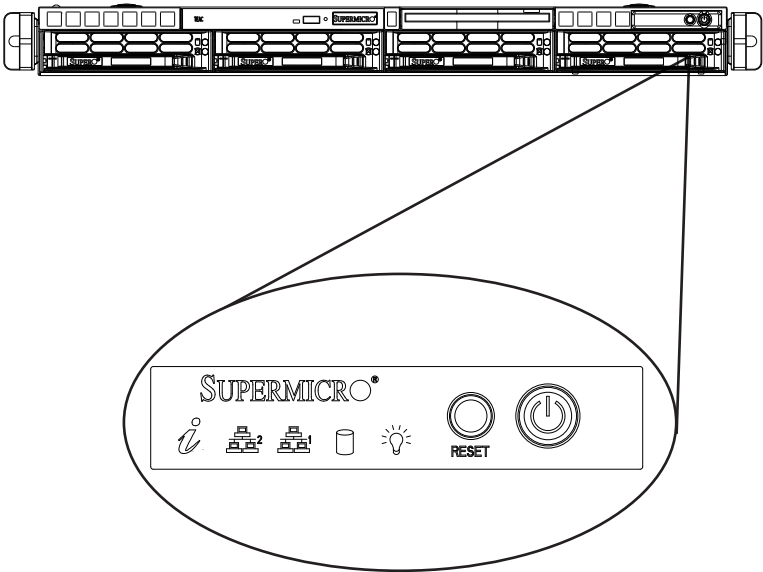

Figure 3-1. Chassis Control Panel

3-2 Control Panel Buttons

There are two push-buttons located on the front of the chassis. These are (in order from left to right) a reset button and a power on/off button.



Reset: The reset button is used to reboot the system.



Power: The main power switch is used to apply or remove power from the power supply to the server system. Turning off system power with this button removes the main power but keeps standby power supplied to the system. Therefore, you must unplug system before servicing.

3-3 Control Panel LEDs

The control panel located on the front of the SC813M chassis has five LEDs. These LEDs provide you with critical information related to different parts of the system. This section explains what each LED indicates when illuminated and any corrective action you may need to take.



Information LED

Information LED	
Status	Description
Solid red	An overheat condition has occurred. (This may be caused by cable congestion).
Blinking red (1Hz)	Fan failure, check for an inoperative fan.
Blinking red (0.25Hz)	Power failure, check for a non-operational power supply.
Solid blue	Local UID has been activated. Use this function to locate the server in a rack mount environment.
Blinking blue (300msec)	Remote UID is on. Use this function to identify the server from a remote location.



NIC2: Indicates network activity on GLAN2 when flashing.



NIC1: Indicates network activity on GLAN1 when flashing.



HDD: Indicates hard drive (SAS/SATA) activity when flashing.



Power: Indicates power is being supplied to the system's power supply units. This LED should normally be illuminated when the system is operating.

3-4 Drive Carrier LEDs

Your system supports SAS or SATA, but not both at the same time.

SAS/SATA Drives

Each SAS/SATA drive carrier has two LEDs.

- **Green:** Each drive carrier has a green LED. When illuminated, this green LED (on the front of the drive carrier) indicates drive activity. A connection to the SAS/SATA backplane enables this LED to blink on and off when that particular drive is being accessed.
- **Red:** The red LED indicates a SAS/SATA drive failure. If one of the SAS/SATA drives fail, you should be notified by your system management software. (Requires software support.)

Chapter 4

Standardized Warning Statements for AC Systems

4-1 About Standardized Warning Statements

The following statements are industry standard warnings, provided to warn the user of situations which have the potential for bodily injury. Should you have questions or experience difficulty, contact Supermicro's Technical Support department for assistance. Only certified technicians should attempt to install or configure components.

Read this appendix in its entirety before installing or configuring components in the Supermicro chassis.

These warnings may also be found on our web site at http://www.supermicro.com/about/policies/safety_information.cfm.

Warning Definition



Warning!

This warning symbol means danger. You are in a situation that could cause bodily injury. Before you work on any equipment, be aware of the hazards involved with electrical circuitry and be familiar with standard practices for preventing accidents.

警告の定義

この警告サインは危険を意味します。

人身事故につながる可能性がありますので、いずれの機器でも動作させる前に、電気回路に含まれる危険性に注意して、標準的な事故防止策に精通して下さい。

此警告符号代表危險。

您正处于可能受到严重伤害的工作环境中。在您使用设备开始工作之前，必须充分意识到触电的危险，并熟练掌握防止事故发生的标准工作程序。请根据每项警告结尾的声明号码找到此设备的安全性警告说明的翻译文本。

此警告符號代表危險。

您目前所處的工作環境可能讓您受傷。您使用任何設備之前，請注意觸電的危險，並且要熟悉預防事故發生的標準工作程序。請依照每一注意事項後的號碼找到相關的翻譯說明內容。

Warnung

WICHTIGE SICHERHEITSHINWEISE

Dieses Warnsymbol bedeutet Gefahr. Sie befinden sich in einer Situation, die zu Verletzungen führen kann. Machen Sie sich vor der Arbeit mit Geräten mit den Gefahren elektrischer Schaltungen und den üblichen Verfahren zur Vorbeugung vor Unfällen vertraut. Suchen Sie mit der am Ende jeder Warnung angegebenen Anweisungsnummer nach der jeweiligen Übersetzung in den übersetzten Sicherheitshinweisen, die zusammen mit diesem Gerät ausgeliefert wurden.

BEWAHREN SIE DIESE HINWEISE GUT AUF.

INSTRUCCIONES IMPORTANTES DE SEGURIDAD

Este símbolo de aviso indica peligro. Existe riesgo para su integridad física. Antes de manipular cualquier equipo, considere los riesgos de la corriente eléctrica y familiarícese con los procedimientos estándar de prevención de accidentes. Al final de cada advertencia encontrará el número que le ayudará a encontrar el texto traducido en el apartado de traducciones que acompaña a este dispositivo.

GUARDE ESTAS INSTRUCCIONES.

IMPORTANTES INFORMATIONS DE SÉCURITÉ

Ce symbole d'avertissement indique un danger. Vous vous trouvez dans une situation pouvant entraîner des blessures ou des dommages corporels. Avant de travailler sur un équipement, soyez conscient des dangers liés aux circuits électriques et familiarisez-vous avec les procédures couramment utilisées pour éviter les accidents. Pour prendre connaissance des traductions des avertissements figurant dans les consignes de sécurité traduites qui accompagnent cet appareil, référez-vous au numéro de l'instruction situé à la fin de chaque avertissement.

CONSERVEZ CES INFORMATIONS.

תקנון הצהרות אזהרה

הצהרות הבאות הן אזהרות על פי תקני התעשייה, על מנת להזהיר את המשתמש מפני חבלה פיזית אפשרית. במידה ויש שאלות או היתקלות בעיה כלשהי, יש ליצור קשר עם מחלקת תמיכה טכנית של סופרמיקרו. טכנאים מוסמכים בלבד רשאים להתקין או להגדיר את הרכיבים. יש לקרוא את הנספח במלואו לפני התקנת או הגדרת הרכיבים במאזני סופרמיקרו.

اَكْ فِ حَالَةٍ وَّكِي اَي تَتَسَبَّبُ فِ اَصَابَةِ جَسَدٍ هَذَا الزَّهْرُ عَ حُطْزٍ ! تَحْذَرُ .
قَبْلَ اَي تَعْوَلُ عَلٰى اَي هَعْدَاتٍ، وِ كِي عَلٰى عِلْنِ بِالْوَاخِطِزِ اَلْ اُجُوَّةِ عِي الذَّوَاتِزِ
الْكَهْزِبَائِةِ
وِ كِي عَلٰى دَرَاةٍ بِالْوَوَارِسَاتِ الْمَقَائِةِ لَوْ عَ وَقَعَ اَي حَادِثٍ
اَسْتَحْذَمُ رَقْنِ الْبِ اِي الْوَصْصِ فِ هَاةٍ كُلِّ تَحْذَرُ لِّلْعَثْرِ تَرْجُوْتَهَا

안전을 위한 주의사항

경고!

이 경고 기호는 위험이 있음을 알려 줍니다. 작업자의 신체에 부상을 야기 할 수 있는 상태에 있게 됩니다. 모든 장비에 대한 작업을 수행하기 전에 전기회로와 관련된 위험요소들을 확인하시고 사전에 사고를 방지할 수 있도록 표준 작업절차를 준수해 주시기 바랍니다.

해당 번역문을 찾기 위해 각 경고의 마지막 부분에 제공된 경고문 번호를 참조하십시오

BELANGRIJKE VEILIGHEIDSINSTRUCTIES

Dit waarschuwings symbool betekent gevaar. U verkeert in een situatie die lichamelijk letsel kan veroorzaken. Voordat u aan enige apparatuur gaat werken, dient u zich bewust te zijn van de bij een elektrische installatie betrokken risico's en dient u op de hoogte te zijn van de standaard procedures om ongelukken te voorkomen. Gebruik de nummers aan het eind van elke waarschuwing om deze te herleiden naar de desbetreffende locatie.

BEWAAR DEZE INSTRUCTIES

Installation Instructions



Warning!

Read the installation instructions before connecting the system to the power source.

設置手順書

システムを電源に接続する前に、設置手順書をお読み下さい。

警告

将此系统连接电源前,请先阅读安装说明。

警告

將系統與電源連接前·請先閱讀安裝說明。

Warnung

Vor dem Anschließen des Systems an die Stromquelle die Installationsanweisungen lesen.

¡Advertencia!

Lea las instrucciones de instalación antes de conectar el sistema a la red de alimentación.

Attention

Avant de brancher le système sur la source d'alimentation, consulter les directives d'installation.

יש לקרוא את הוראות התקנה לפני חיבור המערכת למקור מתח.

اقر إرشادات التركيب قبل توصيل النظام إلى مصدر للطاقة

시스템을 전원에 연결하기 전에 설치 안내를 읽어주시십시오.

Waarschuwing

Raadpleeg de installatie-instructies voordat u het systeem op de voedingsbron aansluit.

Circuit Breaker



Warning!

This product relies on the building's installation for short-circuit (overcurrent) protection. Ensure that the protective device is rated not greater than: 250 V, 20 A.

サーキット・ブレーカー

この製品は、短絡(過電流)保護装置がある建物での設置を前提としています。

保護装置の定格が250 V、20 Aを超えないことを確認下さい。

警告

此产品的短路(过载电流)保护由建筑物的供电系统提供,确保短路保护设备的额定电流不大于250V,20A。

警告

此產品的短路(過載電流)保護由建築物的供電系統提供,確保短路保護設備的額定電流不大於250V,20A。

Warnung

Dieses Produkt ist darauf angewiesen, dass im Gebäude ein Kurzschluss- bzw. Überstromschutz installiert ist. Stellen Sie sicher, dass der Nennwert der Schutzvorrichtung nicht mehr als: 250 V, 20 A beträgt.

¡Advertencia!

Este equipo utiliza el sistema de protección contra cortocircuitos (o sobrecorrientes) del edificio. Asegúrese de que el dispositivo de protección no sea superior a: 250 V, 20 A.

Attention

Pour ce qui est de la protection contre les courts-circuits (surtension), ce produit dépend de l'installation électrique du local. Vérifiez que le courant nominal du dispositif de protection n'est pas supérieur à :250 V, 20 A.

מוצר זה מסתמך על הגנה המותקנת במבנים למניעת קצר חשמלי. יש לוודא כי המכשיר המוגן מפני הקצר החשמלי הוא לא יותר מ-250VDC, 20A

هذا المنتج يعتمد على معدات الحماية مه الدوائر القصيرة التي تم تثبيتها في
المبنى
تأكد من أن تقييم الجهاز الوقائي ليس أكثر من : 20A, 250V

경고!

이 제품은 전원의 단락(과전류)방지에 대해서 전적으로 건물의 관련 설비에 의존합니다. 보호장치의 정격이 반드시 250V(볼트), 20A(암페어)를 초과하지 않도록 해야 합니다.

Waarschuwing

Dit product is afhankelijk van de kortsluitbeveiliging (overspanning) van uw elektrische installatie. Controleer of het beveiligde apparaat niet groter gedimensioneerd is dan 250V, 20A.

Power Disconnection Warning



Warning!

The system must be disconnected from all sources of power and the power cord removed from the power supply module(s) before accessing the chassis interior to install or remove system components.

電源切斷の警告

システムコンポーネントの取り付けまたは取り外しのために、シャーシ内部にアクセスするには、
システムの電源はすべてのソースから切斷され、電源コードは電源モジュールから取り外す必要があります。

警告

在你打开机箱并安装或移除内部器件前,必须将系统完全断电,并移除电源线。

警告

在您打開機殼安裝或移除內部元件前·必須將系統完全斷電·並移除電源線。

Warnung

Das System muss von allen Quellen der Energie und vom Netzanschlusskabel getrennt sein, das von den Spg.Versorgungsteilmodulen entfernt wird, bevor es auf den Chassisinnenraum zurückgreift, um Systemsbestandteile anzubringen oder zu entfernen.

¡Advertencia!

El sistema debe ser disconnected de todas las fuentes de energía y del cable eléctrico quitado de los módulos de fuente de alimentación antes de tener acceso el interior del chasis para instalar o para quitar componentes de sistema.

Attention

Le système doit être débranché de toutes les sources de puissance ainsi que de son cordon d'alimentation secteur avant d'accéder à l'intérieur du châssis pour installer ou enlever des composants de système.

אזהרה מפני ניתוק חשמלי

!אזהרה

יש לנתק את המערכת מכל מקורות החשמל ויש להסיר את כבל החשמלי מהספק לפני גישה לחלק הפנימי של המארז לצורך התקנת או הסרת רכיבים.

يجب فصل انظاؤ من جميع مصادر انطاقت وإزانت سهك انكهرباء من وحدة امداد

انطاقت قيم

انصلل إني اماناطق انداخييت نههيكم نتثييج أو إزانت مكنناث الجهاز

경고!

시스템에 부품들을 장착하거나 제거하기 위해서는 새시 내부에 접근하기 전에 반드시 전원 공급장치로부터 연결되어있는 모든 전원과 전기코드를 분리해주어야 합니다.

Waarschuwing

Voordat u toegang neemt tot het binnenwerk van de behuizing voor het installeren of verwijderen van systeem onderdelen, dient u alle spanningsbronnen en alle stroomkabels aangesloten op de voeding(en) van de behuizing te verwijderen

Equipment Installation



Warning!

Only trained and qualified personnel should be allowed to install, replace, or service this equipment.

機器の設置

トレーニングを受け認定された人だけがこの装置の設置、交換、またはサービスを許可されています。

警告

只有经过培训且具有资格的人员才能进行此设备的安装、更换和维修。

警告

只有經過受訓且具資格人員才可安裝、更換與維修此設備。

Warnung

Das Installieren, Ersetzen oder Bedienen dieser Ausrüstung sollte nur geschultem, qualifiziertem Personal gestattet werden.

¡Advertencia!

Solamente el personal calificado debe instalar, reemplazar o utilizar este equipo.

Attention

Il est vivement recommandé de confier l'installation, le remplacement et la maintenance de ces équipements à des personnels qualifiés et expérimentés.

אזהרה!

צוות מוסמך בלבד רשאי להתקין, להחליף את הציוד או לתת שירות עבור הציוד.

والمدربيه لتتركيب واستبدال أو خدمة هذا الجهاز يجب أن يسمح فقط للموظفیه المؤهليه

경고!

훈련을 받고 공인된 기술자만이 이 장비의 설치, 교체 또는 서비스를 수행할 수 있습니다.

Waarschuwing

Deze apparatuur mag alleen worden geïnstalleerd, vervangen of hersteld door geschoold en gekwalificeerd personeel.

Restricted Area



Warning!

This unit is intended for installation in restricted access areas. A restricted access area can be accessed only through the use of a special tool, lock and key, or other means of security. (This warning does not apply to workstations).

アクセス制限区域

このユニットは、アクセス制限区域に設置されることを想定しています。

アクセス制限区域は、特別なツール、鍵と錠前、その他のセキュリティの手段を用いてのみ出入りが可能です。

警告

此部件应安装在限制进出的场所。限制进出的场所指只能通过使用特殊工具、锁和钥匙或其它安全手段进出的场所。

警告

此装置僅限安裝於進出管制區域。進出管制區域係指僅能以特殊工具、鎖頭及鑰匙或其他安全方式才能進入的區域。

Warnung

Diese Einheit ist zur Installation in Bereichen mit beschränktem Zutritt vorgesehen. Der Zutritt zu derartigen Bereichen ist nur mit einem Spezialwerkzeug, Schloss und Schlüssel oder einer sonstigen Sicherheitsvorkehrung möglich.

¡Advertencia!

Esta unidad ha sido diseñada para instalación en áreas de acceso restringido. Sólo puede obtenerse acceso a una de estas áreas mediante la utilización de una herramienta especial, cerradura con llave u otro medio de seguridad.

Attention

Cet appareil doit être installée dans des zones d'accès réservés. L'accès à une zone d'accès réservé n'est possible qu'en utilisant un outil spécial, un mécanisme de verrouillage et une clé, ou tout autre moyen de sécurité.

אזור עם גישה מוגבלת

אזהרה!

יש להתקין את היחידה באזורים שיש בהם הגבלת גישה. הגישה ניתנת בעזרת 'כלי אבטחה בלבד' (מפתח, מנעול וכד.).

تخصيص هذه انحدئة نترك بُها ف مناطق محظورة تم .
،ممكن اننصل إن منطقت محظورة فقط من خلال استخداو أداة خاصت
أو أ وس هُت أخري نلالأما ققم ومفتاح

경고!

이 장치는 접근이 제한된 구역에 설치하도록 되어 있습니다. 특수 도구, 잠금 장치 및 키, 또는 기타 보안 수단을 통해서만 접근 제한 구역에 들어갈 수 있습니다.

Waarschuwing

Dit apparaat is bedoeld voor installatie in gebieden met een beperkte toegang. Toegang tot dergelijke gebieden kunnen alleen verkregen worden door gebruik te maken van speciaal gereedschap, slot en sleutel of andere veiligheidsmaatregelen.

Battery Handling



Warning!

There is the danger of explosion if the battery is replaced incorrectly. Replace the battery only with the same or equivalent type recommended by the manufacturer. Dispose of used batteries according to the manufacturer's instructions

電池の取り扱い

電池交換が正しく行われなかった場合、破裂の危険性があります。交換する電池はメーカーが推奨する型、または同等のものを使用下さい。使用済電池は製造元の指示に従って処分して下さい。

警告

電池更換不當會有爆炸危險。請只使用同類電池或製造商推薦的功能相當的電池更換原有電池。請按製造商的說明處理廢舊電池。

警告

電池更換不當會有爆炸危險。請使用製造商建議之相同或功能相當的電池更換原有電池。請按照製造商的說明指示處理廢棄舊電池。

Warnung

Bei Einsetzen einer falschen Batterie besteht Explosionsgefahr. Ersetzen Sie die Batterie nur durch den gleichen oder vom Hersteller empfohlenen Batterietyp. Entsorgen Sie die benutzten Batterien nach den Anweisungen des Herstellers.

Attention

Danger d'explosion si la pile n'est pas remplacée correctement. Ne la remplacer que par une pile de type semblable ou équivalent, recommandée par le fabricant. Jeter les piles usagées conformément aux instructions du fabricant.

¡Advertencia!

Existe peligro de explosión si la batería se reemplaza de manera incorrecta. Reemplazar la batería exclusivamente con el mismo tipo o el equivalente recomendado por el fabricante. Desechar las baterías gastadas según las instrucciones del fabricante.

אזהרה!

קיימת סכנת פיצוץ של הסוללה במידה והוחלפה בדרך לא תקינה. יש להחליף את הסוללה בסוג התואם מחברת יצרן מומלצת. סילוק הסוללות המשומשות יש לבצע לפי הוראות היצרן.

هناك خطر من انفجار في حالة اسبدال البطارية بطريقة غير صحيحة فاعيل
اسبدال البطارية
فقط بنفس النوع أو ما يعادلها مما أوصت به الشركة المصنعة
جخلص من البطاريات المسحمة وفقا لعمليات الشركة الصانعة

경고!

배터리가 올바르게 교체되지 않으면 폭발의 위험이 있습니다. 기존 배터리와 동일하거나 제조사에서 권장하는 동등한 종류의 배터리로만 교체해야 합니다. 제조사의 안내에 따라 사용된 배터리를 처리하여 주십시오.

Waarschuwing

Er is ontploffingsgevaar indien de batterij verkeerd vervangen wordt. Vervang de batterij slechts met hetzelfde of een equivalent type die door de fabrikant aanbevolen wordt. Gebruikte batterijen dienen overeenkomstig fabrieksvoorschriften afgevoerd te worden.

Redundant Power Supplies



Warning!

This unit might have more than one power supply connection. All connections must be removed to de-energize the unit.

冗長電源装置

このユニットは複数の電源装置が接続されている場合があります。
ユニットの電源を切るためには、すべての接続を取り外さなければなりません。

警告

此部件连接的电源可能不止一个·必须将所有电源断开才能停止给该部件供电。

警告

此装置连接的电源可能不只一个·必须切断所有电源才能停止对该装置的供电。

Warnung

Dieses Gerät kann mehr als eine Stromzufuhr haben. Um sicherzustellen, dass der Einheit kein Strom zugeführt wird, müssen alle Verbindungen entfernt werden.

¡Advertencia!

Puede que esta unidad tenga más de una conexión para fuentes de alimentación. Para cortar por completo el suministro de energía, deben desconectarse todas las conexiones.

Attention

Cette unité peut avoir plus d'une connexion d'alimentation. Pour supprimer toute tension et tout courant électrique de l'unité, toutes les connexions d'alimentation doivent être débranchées.

אם קיים יותר מספק אחד

אזהרה!

ליחידה יש יותר מחיבור אחד של ספק. יש להסיר את כל החיבורים על מנת לרוקן את היחידה.

قد يكون لهذا الجهاز عدة اتصالات بوحدات امداد الطاقة .
يجب إزالة كافة الاتصالات لغسل الوحدة عن الكهرباء

경고!

이 장치에는 한 개 이상의 전원 공급 단자가 연결되어 있을 수 있습니다. 이 장치에 전원을 차단하기 위해서는 모든 연결 단자를 제거해야만 합니다.

Waarschuwing

Deze eenheid kan meer dan één stroomtoevoeraansluiting bevatten. Alle aansluitingen dienen verwijderd te worden om het apparaat stroomloos te maken.

Backplane Voltage



Warning!

Hazardous voltage or energy is present on the backplane when the system is operating. Use caution when servicing.

バックプレーンの電圧

システムの稼働中は危険な電圧または電力が、バックプレーン上にかかっています。

修理する際にはご注意ください。

警告

当系统正在进行时·背板上有很危险的电压或能量·进行维修时务必小心。

警告

當系統正在進行時·背板上有危險的電壓或能量·進行維修時務必小心。

Warnung

Wenn das System in Betrieb ist, treten auf der Rückwandplatine gefährliche Spannungen oder Energien auf. Vorsicht bei der Wartung.

¡Advertencia!

Cuando el sistema está en funcionamiento, el voltaje del plano trasero es peligroso. Tenga cuidado cuando lo revise.

Attention

Lorsque le système est en fonctionnement, des tensions électriques circulent sur le fond de panier. Prendre des précautions lors de la maintenance.

מתח בפנל האחורי

אזהרה!

קיימת סכנת מתח בפנל האחורי בזמן תפעול המערכת. יש להיזהר במהלך העבודה.

هناك خطر من التيار الكهربائي أو الطاقة المخزنة على اللوحة عندما يكون النظام يعمل كهذا عند خدمة هذا الجهاز

경고!

시스템이 동작 중일 때 후면판 (Backplane)에는 위험한 전압이나 에너지가 발생할 수 있습니다. 서비스 작업 시 주의하십시오.

Waarschuwing

Een gevaarlijke spanning of energie is aanwezig op de backplane wanneer het systeem in gebruik is. Voorzichtigheid is geboden tijdens het onderhoud.

Comply with Local and National Electrical Codes



Warning!

Installation of the equipment must comply with local and national electrical codes.

地方および国の電気規格に準拠

機器の取り付けはその地方および国の電気規格に準拠する必要があります。

警告

设备安装必须符合本地与本国电气法规。

警告

設備安裝必須符合本地與本國電氣法規。

Warnung

Die Installation der Geräte muss den Sicherheitsstandards entsprechen.

¡Advertencia!

La instalación del equipo debe cumplir con las normas de electricidad locales y nacionales.

Attention

L'équipement doit être installé conformément aux normes électriques nationales et locales.

תיאום חוקי החשמל הארצי

אזהרה!

התקנת הציוד חייבת להיות תואמת לחוקי החשמל המקומיים והארציים.

تركيب المعدات الكهربائية يجب أن يمتثل للقوايه المحلية والطبية المتعلقة

بالكهرباء

경고!

현 지역 및 국가의 전기 규정에 따라 장비를 설치해야 합니다.

Waarschuwing

Bij installatie van de apparatuur moet worden voldaan aan de lokale en nationale elektriciteitsvoorschriften.

Product Disposal



Warning!

Ultimate disposal of this product should be handled according to all national laws and regulations.

製品の廃棄

この製品を廃棄処分する場合、国の関係する全ての法律・条例に従い処理する必要があります。

警告

本产品的废弃处理应根据所有国家的法律和规章进行。

警告

本產品的廢棄處理應根據所有國家的法律和規章進行。

Warnung

Die Entsorgung dieses Produkts sollte gemäß allen Bestimmungen und Gesetzen des Landes erfolgen.

¡Advertencia!

Al deshacerse por completo de este producto debe seguir todas las leyes y reglamentos nacionales.

Attention

La mise au rebut ou le recyclage de ce produit sont généralement soumis à des lois et/ou directives de respect de l'environnement. Renseignez-vous auprès de l'organisme compétent.

סילוק המוצר

!זהרה!

סילוק סופי של מוצר זה חייב להיות בהתאם להנחיות וחוקי המדינה.

التخلص النهائي من هذا المنتج ينبغي التعامل معه وفقا لجميع القوانين واللوائح الوطنية عند

경고!

이 제품은 해당 국가의 관련 법규 및 규정에 따라 폐기되어야 합니다.

Waarschuwing

De uiteindelijke verwijdering van dit product dient te geschieden in overeenstemming met alle nationale wetten en reglementen.

Hot Swap Fan Warning



Warning!



Hazardous moving parts. Keep away from moving fan blades. The fans might still be turning when you remove the fan assembly from the chassis. Keep fingers, screwdrivers, and other objects away from the openings in the fan assembly's housing.

ファン・ホットスワップの警告

警告!回転部品に注意。運転中は回転部(羽根)に触れないでください。シャーシから冷却ファン装置を取り外した際、ファンがまだ回転している可能性があります。ファンの開口部に、指、ドライバー、およびその他のものを近づけないで下さい。

警告!

警告！危險的可移動性零件。請務必與轉動的风扇叶片保持距離。當您從機架移除風扇裝置，風扇可能仍在轉動。小心不要將手指、螺絲起子和其他物品太靠近風扇

警告

危險的可移動性零件。請務必與轉動的風扇葉片保持距離。當您從機架移除風扇裝置，風扇可能仍在轉動。小心不要將手指、螺絲起子和其他物品太靠近風扇。

Warnung

Gefährlich Bewegende Teile. Von den bewegenden Lüfterblätter fern halten. Die Lüfter drehen sich u. U. noch, wenn die Lüfterbaugruppe aus dem Chassis genommen wird. Halten Sie Finger, Schraubendreher und andere Gegenstände von den Öffnungen des Lüftergehäuses entfernt.

¡Advertencia!

Riesgo de piezas móviles. Mantener alejado de las aspas del ventilador. Los ventiladores podran dar vuelta cuando usted quite el montaje del ventilador del chasis. Mandtenga los dedos, los destornilladores y todos los objetos lejos de las aberturas del ventilador

Attention

Pieces mobiles dangereuses. Se tenir a l'ecart des lames du ventilateur Il est possible que les ventilateurs soient toujours en rotation lorsque vous retirerez le bloc ventilateur du châssis. Prenez garde à ce que doigts, tournevis et autres objets soient éloignés du logement du bloc ventilateur.

אזהרה!

חלקים נעים מסוכנים. התרחק מלהבי המאוורר בפעולה כאשר מסירים את חלקי המאוורר מהמארז, יתכן והמאווררים עדיין עובדים. יש להרחיק למרחק בטוח את האצבעות וכלי עבודה שונים מהפתחים בתוך המאוורר

تحذير! أجزاء متحركة خطيرة. ابتعد عن شفرات المروحة المتحركة. من الممكن أن المراوح لا تزال تدور عند إزالة كتلة المروحة من الهيكل يجب إبقاء الأصابع ومفكات البراغي وغيرها من الأشياء بعيدا عن الفتحات في كتلة المروحة

경고!

움직이는 위험한 부품. 회전하는 송풍 날개에 접근하지 마세요. 채시로부터 팬 조립품을 제거할 때 팬은 여전히 회전하고 있을 수 있습니다. 팬 조립품 외관의 열려있는 부분들로부터 손가락 및 스크류드라이버, 다른 물체들이 가까이 하지 않도록 배치해 주십시오.

Waarschuwing

Gevaarlijk bewegende onderdelen. Houd voldoende afstand tot de bewegende ventilatorbladen. Het is mogelijk dat de ventilator nog draait tijdens het verwijderen van het ventilatorsamenstel uit het chassis. Houd uw vingers, schroevendraaiers en eventuele andere voorwerpen uit de buurt van de openingen in de ventilatorbehuizing.

Power Cable and AC Adapter



Warning!

Warning! When installing the product, use the provided or designated connection cables, power cables and AC. Using any other cables and adaptors could cause a malfunction or a fire. Electrical Appliance and Material Safety Law prohibits the use of UL or CSA -certified cables (that have UL/CSA shown on the code) for any other electrical devices than products designated by Supermicro only..

電源コードとACアダプター

製品を設置する場合、提供または指定および購入された接続ケーブル、電源コードとACアダプターを、該当する地域の条例や安全基準に適合するコードサイズやプラグと共に使用下さい。他のケーブルやアダプタを使用すると故障や火災の原因になることがあります。電気用品安全法は、ULまたはCSA認定のケーブル(UL/CSEマークがコードに表記)を Supermicroが指定する製品以外に使用することを禁止しています。

警告

安装此产品时,请使用本身提供的或指定的或采购的连接线,电源线和电源适配器。包含遵照当地法规和安全要求的合规的电源线尺寸和插头。使用其它线材或适配器可能会引起故障或火灾。除了Supermicro所指定的产品,电气用品和材料安全法律规定禁止使用未经UL或CSA认证的线材。(线材上会显示UL/CSA符号)。

警告

安装此产品时,请使用本身提供的或指定的或采购的连接线,电源线 and 电源适配器。包含遵照当地法规和安全要求的合规的电源线尺寸和插头。使用其它线材或适配器可能会引起故障或火灾。除了Supermicro所指定的产品,电气用品和材料安全法律规定禁止使用未经UL或CSA认证的线材。(线材上会显示UL/CSA符号)。

Warnung

Nutzen Sie beim Installieren des Produkts ausschließlich die von uns zur Verfügung gestellten Verbindungskabeln, Stromkabeln und/oder Adapter, die Ihre örtlichen Sicherheitsstandards einhalten. Der Gebrauch von anderen Kabeln und Adapter können Fehlfunktionen oder Feuer verursachen. Die Richtlinien untersagen das Nutzen von UL oder CAS zertifizierten Kabeln (mit UL/CSA gekennzeichnet), an Geräten oder Produkten die nicht mit Supermicro gekennzeichnet sind.

¡Advertencia!

Cuando instale el producto, utilice la conexión provista o designada o procure cables, Cables de alimentación y adaptadores de CA que cumplan con los códigos locales y los requisitos de seguridad, incluyendo el tamaño adecuado del cable y el enchufe. El uso de otros cables y adaptadores podría causar un mal funcionamiento o un incendio. La Ley de Seguridad de Aparatos Eléctricos y de Materiales prohíbe El uso de cables certificados por UL o CSA (que tienen el certificado UL / CSA en el código) para cualquier otros dispositivos eléctricos que los productos designados únicamente por Supermicro.Attention

Attention

Lors de l'installation du produit, utilisez les cables de connection fournis ou désigné ou achetez des cables, cables de puissance et adaptateurs respectant les normes locales et les conditions de securite y compris les tailles de cables et les prises electriques appropriées. L'utilisation d'autres cables et adaptateurs peut provoquer un dysfonctionnement ou un incendie. Appareils électroménagers et la Loi sur la Sécurité Matériel interdit l'utilisation de câbles certifiés- UL ou CSA (qui ont UL ou CSA indiqué sur le code) pour tous les autres appareils électriques sauf les produits désignés par Supermicro seulement.

AC כבלים חשמליים ומתאמי

!אזהרה

אשר נרכשו או AC כאשר מתקינים את המוצר, יש להשתמש בכבלים, ספקים ומתאמים הותאמו לצורך ההתקנה, ואשר הותאמו לדרישות הבטיחות המקומיות, כולל מידה נכונה של הכבל והתקע. שימוש בכל כבל או מתאם מסוג אחר, עלול לגרום לתקלה או קצר חשמלי. בהתאם לחוקי השימוש במכשירי החשמל וחוקי הבטיחות, קיים איסור להשתמש עבור UL/CSA) כאשר מופיע עליהם קוד של (UL-CSA או ב UL- בכבלים המוסמכים ב בלבד Supermicro כל מוצר חשמלי אחר, אלא רק במוצר אשר הותאם ע"י

عند تركيب المنتج، قم باستخدام التوصيلات المتوفرة أو المحددة أو قم بشراء الكابلات الكهربائية ومحوّلات التيار المتردد مع الالتزام بقوانين ومتطلبات السلامة المحلية بما في ذلك حجم الموصل والقابس السليم. استخدام أي كابلات ومحوّلات أخرى قد يتسبب في عطل أو حريق. يحظر قانون السلامة للأجهزة الكهربائية والمعدات استخدام مع أي معدات أخرى غير المنتجات المعنية (UL/CSA) والتي تحمل علامة CSA أو UL الكابلات المعتمدة من قبل Supermicro والمحددة من قبل

전원 케이블 및 AC 어댑터

경고! 제품을 설치할 때 현지 코드 및 적절한 굵기의 코드와 플러그를 포함한 안전 요구 사항을 준수하여 제공되거나 지정된 연결 혹은 구매 케이블, 전원 케이블 및 AC 어댑터를 사용하십시오.

다른 케이블이나 어댑터를 사용하면 오작동이나 화재가 발생할 수 있습니다. 전기 용품 안전법은 UL 또는 CSA 인증 케이블 (코드에 UL / CSA가 표시된 케이블)을 Supermicro가 지정한 제품 이외의 전기 장치에 사용하는 것을 금지합니다.

Stroomkabel en AC-Adapter

Waarschuwing! Bij het aansluiten van het Product uitsluitend gebruik maken van de geleverde Kabels of een andere geschikte aan te schaffen Aansluitmethode, deze moet altijd voldoen aan de lokale voorschriften en veiligheidsnormen, inclusief de juiste kabeldikte en stekker. Het gebruik van niet geschikte Kabels en/of Adapters kan een storing of brand veroorzaken. Wetgeving voor Elektrische apparatuur en Materiaalveiligheid verbied het gebruik van UL of CSA -gecertificeerde Kabels (met UL/CSA in de code) voor elke andere toepassing dan de door Supermicro hiervoor beoogde Producten.

Chapter 5

Advanced Motherboard Setup

This chapter describes the X10SDV-7TP4F motherboard including how to connect the data and power cables and install add-on cards. All motherboard jumpers and connections are described and a layout and quick reference chart are included in this chapter. Remember to close the chassis completely when you have finished working on the motherboard to protect and cool the system sufficiently.

5-1 Handling the Motherboard

Static electrical discharge can damage electronic components. To prevent damage to printed circuit boards, it is important to handle them very carefully (see Chapter 4). Also note that the size and weight of the motherboard can cause it to bend if handled improperly, which may result in damage. To prevent the motherboard from bending, keep one hand under the center of the board to support it when handling.

The following measures are generally sufficient to protect your equipment from static discharge.

Precautions

- Use a grounded wrist strap designed to prevent static discharge.
- Touch a grounded metal object before removing any board from its antistatic bag.
- Handle a board by its edges only; do not touch its components, peripheral chips, memory modules or gold contacts.
- When handling chips or modules, avoid touching their pins.
- Put the motherboard, add-on cards and peripherals back into their antistatic bags when not in use.

5-2 Connecting Cables

The cables include the data cables for the peripherals and control panel and the power cables.

Connecting Data Cables

The cables used to transfer data from the peripheral devices have been carefully routed in preconfigured systems to prevent them from blocking the flow of cooling air that moves through the system from front to back.

If you need to disconnect any of these cables, you should take care to reroute them as they were originally after reconnecting them (be aware of the pin 1 locations). If you are configuring the system, keep the airflow in mind when routing the cables.

Connecting Power Cables

The X10SDV-7TP4F has a 24-pin primary power supply connector designated "JPW1" for connection to the ATX power supply. Connect the appropriate connector from the power supply to JPW1 to supply power to the motherboard. See the Connector Definitions section in this chapter for power connector pin definitions.

In addition, the 8-pin JPV1 connector (to supply power for HDDs) may need to be connected to the power supply.

Connecting the Control Panel

JF1 contains header pins for various front control panel connectors. See Figure 5-1 for the pin locations of the various front control panel buttons and LED indicators. Please note that even and odd numbered pins are on opposite sides of each header. All JF1 wires have been bundled into single keyed ribbon cable to simplify their connection. Connect one end of this cable to JF1 and the other end to the Control Panel printed circuit board, located just behind the system status LEDs in the chassis.

See the Connector Definitions section in this chapter for details and pin descriptions of JF1.

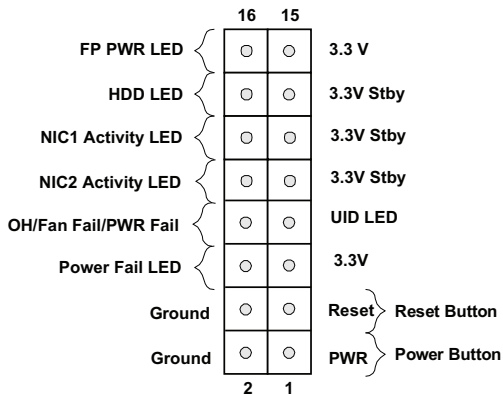

Figure 5-1. Front Control Panel Header Pins (JF1)

5-3 I/O Ports

See Figure 5-2 below for the descriptions of the various rear I/O ports.

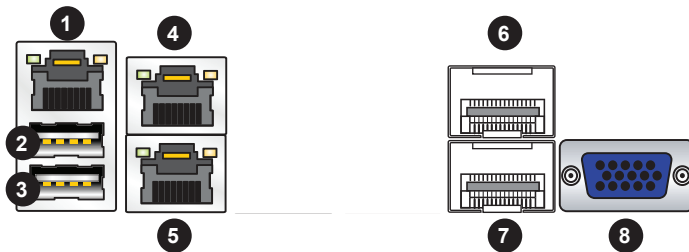

Figure 5-2. Rear I/O Ports

Rear I/O Ports		
1. IPMI LAN Port	4. LAN Port 2	7. LAN Port 7 (SPF+)
2. USB Port 1 (USB 3.0)	5. LAN Port 1	8. VGA Port
3. USB Port 0 (USB 3.0)	6. LAN Port 8 (SPF+)	

5-4 Installing Memory

Note: Check the Supermicro website for recommended memory modules.

CAUTION

Exercise extreme care when installing or removing DIMM modules to prevent any possible damage.

Installing DIMMs

1. Insert the desired number of DIMMs into the memory slots, starting with slots DIMMA1. Pay attention to the notch along the bottom of the module to prevent inserting the DIMM module incorrectly. See Figure 5-3.
2. Gently press down on the DIMM module until it snaps into place in the slot. Repeat step 1 to install to DIMM1B if needed.

Memory Support

The X10SDV-7TP4F has four DIMM sockets that can support up to 128 GB of ECC RDIMM (Registered DIMM) or 64 GB of ECC/non-ECC UDIMM (Unregistered DIMM) DDR4-2133/1866/1600 memory.

For the latest memory updates, please refer to our website. Please follow the tables below for correct installation.

Memory Installation Guidelines

When installing memory modules, the DIMM slots should be populated in the following order: DIMMA1 and DIMMB1 then DIMMA2 and DIMMB2.

- Always use DDR4 DIMM modules of the same size, type and speed. Mixing memory modules of different types and speeds is not allowed.
- The motherboard will support one DIMM module installed. However, for best memory performance, install DIMM modules in pairs.

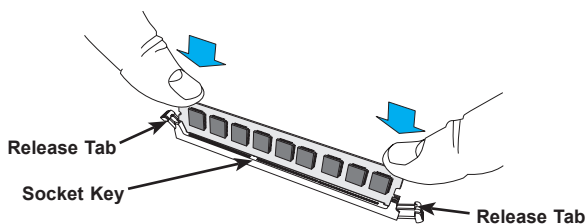

Figure 5-3. DIMM Installation

Recommended Population (Balanced)				
DIMMA1 Slot	DIMMB1 Slot	DIMMA2 Slot	DIMMB2 Slot	Total System Memory
4GB	4GB			8GB
4GB	4GB	4GB	4GB	16GB
8GB	8GB			16GB
8GB	8GB	8GB	8GB	32GB
16GB	16GB			32GB
16GB	16GB	16GB	16GB	64GB
32GB	32GB			64GB
32GB	32GB	32GB	32GB	128GB

5-5 Adding PCI Expansion Cards

PCI Expansion Slots

One RSC-RR1U-E8 riser card is used to support an expansion (add-on) card to the system.

PCI Card Installation

Before installing a PCI add-on card, make sure it is supported by the riser card. Begin by releasing the locking tab that corresponds to the slot you wish to populate. Insert the expansion card into the riser card by pushing down with your thumbs evenly on both sides of the card.

PCI Slot/Card Configurations

Riser Card

RSC-RR1U-E8 (pre-installed)

Expansion Card Supported

1x PCI-E 3.0 x8 card

5-6 Motherboard Details

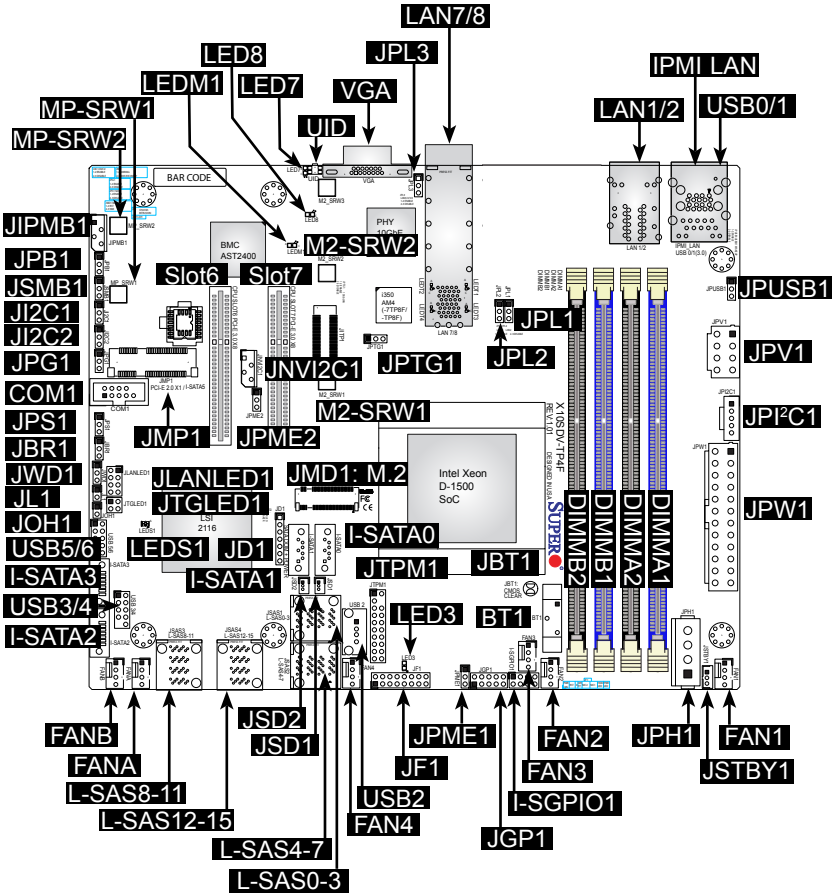

Figure 5-4. SUPER X10SDV-7TP4F Layout

Notes

- "■" indicates the location of pin 1.
- Jumpers and LED indicators not indicated are used for testing purposes only.

X10SDV-7TP4F Quick Reference

Jumper	Description	Default Setting
JBR1	BIOS Recovery	Pins 1-2 (Normal)
JBT1	CMOS Clear	See Section 5-8
J1 ² C1/J1 ² C2	SMB to PCI-Exp. Slots /Disable	Pins 2-3 (Disabled)
JPB1	BMC Enable/Disable (Debug use only)	Pins 1-2 (Enabled)
JPG1	VGA Enable/Disable	Pins 1-2 (Enabled)
JPL1	LAN1 Enable/Disable	Pins 1-2 (Enabled)
JPL2	LAN2 Enable/Disable	Pins 1-2 (Enabled)
JPME1	ME Recovery	Pins 1-2 (Normal)
JPME2	Manufacturing Mode	Pins 1-2 (Normal)
JPS1	SAS 2.0 Controller Enable/Disable	Pins 1-2 (Enabled)
JPTG1	10Gb Ethernet Enable/Disable	Pins 1-2 (Enabled)
JUSB1	USB Wakeup (USB0/1) Enable/Disable	Pins 1-2 (Enabled)
JWD1	Watch Dog	Pins 1-2 (Reset)

Connector	Description
COM1	COM1 Header
FAN1 ~ FAN4 FANA, FANB	CPU/System Cooling Fans
IPMI LAN	Dedicated IPMI LAN Port
I-SATA0 ~ I-SATA5	Intel SATA Ports (I-SATA0 / I-SATA1 support SuperDOM, I-SATA4 via M.2, I-SATA5 via Mini-PCIE mSATA)
I-SGPIO1	Serial Link General Purpose I/O Header
JD1	Speaker (Pins 1-3: Power LED, Pins 4-7: Speaker)
JF1	Front Panel Control Header
JGP1	General Purpose I/O Header
JIPMB1	4-pin External SMBus I ² C Header (for an IPMI Card)
JL1	Chassis Intrusion Header
JMD1	M.2 PCI-E 3.0 X4 / I-SATA4 Slot
JMP1	Mini PCI-E 2.0 X1 / I-SATA5 Slot
JNVI ² C1	NVMe I ² C Header

Table continued on next page.

Connector	Description
JOH1	Overheat LED Header
JPH1	4-pin Power Connector for HDDs
JPI ² C1	Power Supply SMBus I ² C Header
JPV1	12V 8-pin Power Connector (provides alternate power for special enclosure when the 24-pin ATX power is not in use)
JPW1	24-pin ATX Power Connector
JSD1, JSD2	SATA DOM (Device On Module) Power Connectors
JSMB1	SMBus Header
JSTBY1	5V Standby Power Header
JTGLED1	LAN7 ~ LAN8 Activity LED Header
JTPM1	Trusted Platform Module (TPM)/Port 80 Connector
LAN1, LAN2, LAN7, LAN8	Gigabit Ethernet (RJ45) Ports (LAN1 ~ LAN2) 10Gigabit Ethernet (SFP+) Ports (LAN7 ~ LAN8)
L-SAS0 ~ L-SAS15	SAS 2.0/SATA 3.0 Ports
M2-SRW1 ~ SRW3	M.2 Mounting Screws
MP-SRW1 ~ SRW2	PCI-E 2.0 x1 / I-SATA5 Slot Mounting Screws
Slot6, Slot7	CPU PCI-E 3.0 x8 Slot
UID	Unit ID Button
USB 0/1	Back Panel USB 3.0 Ports
USB 2	USB Type-A Connector
USB 3/4, 5/6	Front Access USB 2.0 Ports
VGA	VGA Port

LED	Description	Color/State	Status
LED3	Power LED	Green: On	System Power On
LED7	UID Switch LED	Blue: On	Unit Identified
LED8	Overheat/PWR Fail/Fan Fail LED	Red: Solid on Blinking	Overheat PWR Fail or Fan Fail
LEDM1	BMC Heartbeat LED	Green: Blinking	BMC: Normal
LEDT1	LAN7 Link Status	Green: On	LAN7 Normal
LEDT2	LAN7 Activity	Green: Blinking	LAN7 Active
LEDT3	LAN8 Link Status	Green: On	LAN8 Normal
LEDT4	LAN8 Activity	Green: Blinking	LAN8 Active

5-7 Connector Definitions

Power Connectors

The 24-pin ATX power connector at JPW1 is used to provide power to the motherboard. JPV1 is a 12V DC power connector that provides alternative power for special a enclosure when the 24-pin ATX power is not in use. The 4-pin HDD power connector JPH1 provides power to onboard HDD devices.

Note: Do not use the 8-pin DC power at JPV1 when the 24-pin ATX Power at JPW1 is connected to the power supply. Do not plug in both JPV1 and JPW1 at the same time.

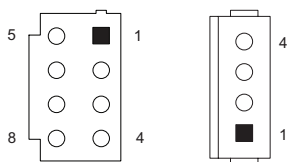

ATX Power 24-pin Connector Pin Definitions (JPW1)			
Pin#	Definition	Pin #	Definition
13	+3.3V	1	+3.3V
14	NC	2	+3.3V
15	COM	3	COM
16	PS_ON	4	+5V
17	COM	5	COM
18	COM	6	+5V
19	COM	7	COM
20	NC	8	PWR_OK
21	+5V	9	5VSB
22	+5V	10	+12V
23	+5V	11	+12V
24	COM	12	+3.3V

8-pin DC Power Pin Definitions (JPV1)	
Pin#	Definition
1-4	GND
5-8	12V

4-Pin HDD Power Pin Definitions (JPH1)	
Pin#	Definition
1	12V
2-3	GND
4	5V

Power LED

The Power LED connection is located on pins 15 and 16 of JF1. Refer to the table on the right for pin definitions.

Power LED Pin Definitions (JF1)	
Pin#	Definition
15	3.3V
16	PWR LED

HDD LED

The HDD LED connection is located on pins 13 and 14 of JF1. Attach a cable here to indicate the status of all HDD-related activities. See the table on the right for pin definitions.

HDD LED Pin Definitions (JF1)	
Pin#	Definition
13	3.3V Standby
14	HD LED

NIC1/NIC2 (LAN1/LAN2)

The NIC (Network Interface Controller) LED connection for LAN port 2 is located on pins 9 and 10 of JF1, and the LED connection for LAN port 1 is on pins 11 and 12. Attach NIC LED cables to their respective pins to display network activity. Refer to the table on the right for pin definitions.

LAN1/LAN2 LED Pin Definitions (JF1)	
Pin#	Definition
9-11	3.3V Standby
10-12	NIC Activity LED

Overheat (OH)/Fan Fail/PWR Fail/UID LED

Connect an LED cable to pins 7 and 8 of JF1 for Overheat/Fan Fail/Power Fail and UID LED indications. The blue LED on pin 7 works as the front panel UID LED indicator. The red LED on pin 8 works provides warnings of overheat, fan failure or power failure. The red LED takes precedence over the blue LED by default. Refer to the table on the right for pin definitions.

OH/Fan Fail/PWR Fail/Blue UID LED Pin Definitions (JF1)	
Pin#	Definition
7	Blue UID LED
8	OH/Fan Fail/Power Fail Cathode

Reset Button

The Reset Button connection is located on pins 3 and 4 of JF1. Attach it to a hardware reset switch on the computer case to reset the system. Refer to the table on the right for pin definitions.

Reset Button Pin Definitions (JF1)	
Pin#	Definition
3	Reset
4	Ground

Power Fail LED

The Power Fail LED connection is located on pins 5 and 6. Refer to the table on the right for pin definitions.

Power Fail Pin Definitions (JF1)	
Pin#	Definition
5	3.3V
6	Power Fail

Power Button

The Power Button connection is located on pins 1 and 2 of JF1. Momentarily contacting both pins will power on/off the system. This button can be configured as 4 Seconds Override or Instant Off (with a setting in the BIOS setting, see Chapter 7). Refer to the table on the right for pin definitions.

Power Button Pin Definitions (JF1)	
Pin#	Definition
1	Signal
2	Ground

Universal Serial Bus (USB)

Two USB 3.0 ports (USB0/1) are located on the I/O back panel. Two USB 2.0 headers (USB3/4 and USB5/6) and one USB Type-A header are also provided on the motherboard to provide front panel access. USB cables are not included. Refer to the tables on the right for pin definitions.

Back Panel USB 3.0 Pin Definitions			
Pin #	Definition	Pin #	Definition
1	+5V	5	+5V
2	USB_PN1	6	USB_PN0
3	USB_PP1	7	USB_PP0
4	Ground	8	Ground

Internal USB Port 2.0 Pin Definitions			
Pin #	Definition	Pin #	Definition
1	+5V	2	+5V
3	USB_PN2	4	USB_PN3
5	USB_PP2	6	USB_PP3
7	Ground	8	Ground
9	Key	10	NC

Gigabit Ethernet LAN Ports

Two Gigabit Ethernet ports (LAN1 and LAN2) and a dedicated IPMI LAN port are located on the rear I/O panel to provide network connections. These ports accept RJ45 type cables. Please refer to the LED Indicator Section for LAN LED information.

10G SFP+/Ethernet LAN Ports

Two 10 Gigabit SFP+ (Small-form Factor Pluggable) Ethernet LAN ports, supported by the SoC, are located at LAN7 and LAN8 on the rear I/O panel. Please refer to the 10G LAN LED section for 10G LAN LED information.

Unit Identifier Switch

A Unit Identifier (UID) switch and two LED indicators are located on the motherboard. The UID switch is located next to the VGA port on the back panel. The rear UID LED (LED7) is located next to the UID switch. The Front Panel UID LED is located at pin 7 of the Front Control Panel at JF1. Connect a cable to pin 7 on JF1 for Front Panel UID LED indication. When you press the UID switch, both the rear UID LED and the Front Panel UID LED Indicators will be turned on. Press the UID switch again to turn off both LED Indicators. These UID Indicators provide easy identification of a system unit that may be in need of service.

Note: UID can also be triggered via IPMI on the motherboard. For more information on IPMI, please refer to the IPMI User's Guide posted on our website at <http://www.supermicro.com>.

UID Switch	
Pin#	Definition
1	Ground
2	Ground
3	Button In
4	Button In

UID LED Status	
Color/State	Status
Blue: On	Unit Identified

Fan Headers

This motherboard has six 4-pin fan headers. Although pins 1-3 of the fan headers are backward compatible with the traditional 3-pin fans, we recommend you use 4-pin fans to take advantage of the fan speed control via Pulse Width Modulation through the BMC. This allows the fan speeds to be automatically adjusted based on the motherboard temperature.

Fan Header Pin Definitions	
Pin#	Definition
1	Ground (Black)
2	12V (Red)
3	Tachometer
4	PWM_Control

Chassis Intrusion

A Chassis Intrusion header is located at JL1 on the motherboard. Attach the appropriate cable from the header to the chassis to inform you of an intrusion when the chassis is opened.

Chassis Intrusion Pin Definitions (JL1)	
Pin#	Definition
1	Ground
2	Intrusion Input

TPM Header/Port 80 Header

A Trusted Platform Module/Port 80 header, located at JTPM1, provides Trusted Platform (TPM) support and Port 80 connection. Use this header to enhance system performance and data security. See the table on the right for pin definitions.

Note: Please go to the following link for more information on TPM: <http://www.supermicro.com/manuals/other/TPM.pdf>

TPM/Port 80 Header Pin Definitions			
Pin #	Definition	Pin #	Definition
1	LCLK	2	GND
3	LFRAME#	4	<(KEY)>
5	LRESET#	6	+5V
7	LAD 3	8	LAD 2
9	+3.3V	10	LAD1
11	LAD0	12	GND
13	NC	14	NC
15	+3V_DUAL	16	SERIRQ
17	GND	18	Ground
19	3.3V	20	NC

4-pin External I²C BMC Header

A System Management Bus header for IPMI 2.0 is located at JIPMB1. Connect the appropriate cable here to use the IPMI I²C connection on your system.

External I ² C Header Pin Definitions	
Pin#	Definition
1	Data
2	Ground
3	Clock
4	No Connection

DOM PWR Connector

The Disk-On-Module (DOM) power connectors, located at JSD1 and JSD2, provide 5V power to a solid state DOM storage device connected to the SATA port. See the table on the right for pin definitions.

DOM PWR Pin Definitions	
Pin#	Definition
1	5V
2	Ground
3	Ground

Overheat LED Header

The JOH1 header is used to connect an LED indicator to provide warnings of chassis overheating. Refer to the tables on the right for pin definitions.

Overheat LED Pin Definitions	
State	Definition
1	3.3V
2	OH Active

OH Status (Red LED)	
State	Definition
Off	Normal
Solid	Overheat

Speaker

On the JD1 header, pins 1-3 are used for the power LED and pins 4-7 are used for the speaker.

Speaker Connector Pin Definitions	
Pin#	Definition
1-3	Power LED
4-7	Speaker

Standby Power

The Standby Power header is located at JSTBY1 on the motherboard. See the table on the right for pin definitions.

Standby Power Pin Definitions	
Pin#	Definition
1	+5V Standby
2	Ground
3	No connection

Serial Link I/O Header

The Serial Link General Purpose Input/Output (SGPIO) header is used to communicate with the enclosure management chip in the system. See the table on the right for pin definitions.

Serial Link I/O Header Pin Definitions			
Pin#	Definition	Pin	Definition
1	NC	2	NC
3	Ground	4	DATA Out
5	Load	6	Ground
7	Clock	8	NC

System Management Bus Header

The System Management Bus header for additional slave devices or sensors is located as JSMB1. Refer to the table on the right for pin definitions.

SMBus Power Pin Definitions	
Pin#	Definition
1	Data
2	Ground
3	Clock

Power SMB (I²C) Header

The Power System Management Bus header at JPI²C1 monitors the power supply, fan and system temperature. Refer to the table on the right for pin definitions.

Standby Power Pin Definitions	
Pin#	Definition
1	+5V Standby
2	Ground
3	No connection

NVMe I²C Header

Connector JNVI²C is a management header for the Supermicro AOC NVMe PCI-E peripheral cards. Please connect the I²C cable to this connector.

General Purpose I/O Header

JGP1 is a general purpose I/O header. See the table on the right for pin definitions.

GPIO Header Pin Definitions			
Pin#	Definition	Pin	Definition
1	P3V3	2	GND
3	GP0	4	GP1
5	GP2	6	GP3
7	GP4	8	GP5
9	GP6	10	GP7

GPIO Register Address Table To Control JGPIO Pin Header				
JGPIO1 PIN#	SoC GPIO#	USE Select	IO Select	Level
1	Power			
2	Ground			
3	17	IO 0x500 [17]	IO 0x504 [17]	IO 0x50C [17]
4	68	IO 0x540 [4]	IO 0x544 [4]	IO 0x548 [4]
5	01	IO 0x500 [1]	IO 0x504 [1]	IO 0x50C [1]
6	69	IO 0x540 [5]	IO 0x544 [5]	IO 0x548 [5]
7	06	IO 0x500 [6]	IO 0x504 [6]	IO 0x50C [6]
8	70	IO 0x540 [6]	IO 0x544 [6]	IO 0x548 [6]
9	07	IO 0x500 [7]	IO 0x504 [7]	IO 0x50C [7]
10	71	IO 0x540 [7]	IO 0x544 [7]	IO 0x548 [7]

Note: Please refer to the Intel Xeon Processor D-1500 Product Family Datasheet for more information.

5-8 Jumper Settings

Explanation of Jumpers

To modify the operation of the motherboard, jumpers can be used to choose between optional settings. Jumpers create shorts between two pins to change the function of the connector. Pin 1 is identified with a square solder pad on the printed circuit board. See the diagram at right for an example of jumping pins 1 and 2. Refer to the motherboard layout page for jumper locations.

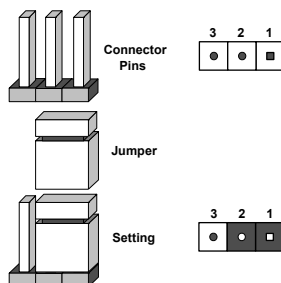

Note: On two-pin jumpers, "Closed" means the jumper is on and "Open" means the jumper is off the pins.

CMOS Clear

JBT1 is used to clear CMOS and will also clear any passwords. Instead of pins, this jumper consists of contact pads to prevent accidentally clearing the contents of CMOS.

To Clear CMOS

1. First power down the system and unplug the power cord(s).
2. Remove the onboard CMOS battery.
3. With the power disconnected, short the CMOS pads with a metal object such as a small screwdriver. 
4. Remove the screwdriver (or shorting device).
5. Replace the battery, reconnect the power cord(s) and power on the system.

Note: Do not use the PW_ON connector to clear CMOS.

VGA Enable/Disable

JPG1 allows you to enable or disable the VGA port. The default position is on pins 1 and 2 to enable VGA. See the table on the right for jumper settings.

VGA Enable/Disable Jumper Settings (JPG1)	
Jumper Setting	Definition
Pins 1-2	Enabled (Default)
Pins 2-3	Disabled

PCI-E Slot SMB Enable (I²C1/I²C2)

Use jumpers JI²C1/JI²C2 to enable PCI SMB (System Management Bus) support to improve system management for the onboard PCI-E slot. See the table on the right for jumper settings.

PCI Slot SMB Enable Jumper Settings	
Pin#	Definition
Pins 1-2	Enabled
Pins 2-3	Disabled (Default)

Watch Dog Timer Enable

Watch Dog is a system monitor that can reboot the system when a software application hangs. Close pins 1-2 to reset the system if an application hangs. Close pins 2-3 to generate a non-maskable interrupt signal for the application that hangs. See the table on the right for jumper settings. Watch Dog must also be enabled in the BIOS. The default time is ~ 5 minutes.

Watch Dog Jumper Settings	
Pin#	Definition
Pins 1-2	Reset (Default)
Pins 2-3	NMI
Open	LAN pairs set to default mode without reset or NMI

USB Wake-Up

Use the JPUSB1 jumper to enable the function of "System Wake-Up via USB devices" for USB0/1. This jumper allows you to "wake-up" the system by pressing a key on the USB keyboard or by clicking the USB mouse of your system. The JPUSB1 jumper is used together with the USB Wake-Up function in the BIOS. Enable both the jumper and the BIOS setting to enable this function. See the table on the right for jumper settings.

USB Wake-up Jumper Settings	
Pin#	Definition
Pins 1-2	Enabled (Default)
Pins 2-3	Disabled

Management Engine (ME) Recovery

Use JPME1 to select ME Firmware Recovery mode, which will limit resource allocation for essential system operation only in order to maintain normal power operation and management. In the single operation mode, online upgrade will be available via Recovery mode. See the table on the right for jumper settings.

ME Recovery Jumper Settings	
Pin#	Definition
Pins 1-2	Normal (Default)
Pins 2-3	ME Recovery

BIOS Recovery

Close pins 2 and 3 of jumper JBR1 for BIOS recovery. The default setting is on pins 1 and 2 for normal operation. See the table on the right for jumper settings.

BIOS Recovery Jumper Settings	
Pin#	Definition
Pins 1-2	Normal
Pins 2-3	BIOS Recovery

BMC Enabled

JPB1 allows you to enable the BMC (Baseboard Management Control) chip and the onboard IPMI connection for debugging purpose only. After the BMC is disabled, IPMI health and remote management functions are no longer supported. See the table on the right for jumper settings.

BMC Enabled Jumper Settings	
Pin#	Definition
Pins 1-2	Enabled (Default)
Pins 2-3	Disabled

Note: Please always keep BMC enabled to make sure that the platform operates reliably with the health monitor.

GbE LAN Ports Enable/Disable

Jumpers JPL1 and JPL2 are used to enable or disable LAN ports 1 and 2, respectively. See the table on the right for jumper settings.

GbE LAN Enable Jumper Settings	
Pin#	Definition
Pins 1-2	Enabled (Default)
Pins 2-3	Disabled

10GbE LAN Ports Enable/Disable

JPTG1 is used to enable or disable 10GbE support. See the table on the right for jumper settings.

10Gb Enable/Disable Jumper Settings	
Pin#	Definition
Pins 1-2	Enabled (Default)
Pins 2-3	Disabled

SAS Port Enable/Disable

Use JPS1 to enable the onboard SAS ports. See the table on the right for jumper settings.

SAS Port Enable/Disable Jumper Settings	
Pin#	Definition
1-2	Enabled
2-3	Disabled

ME Manufacturing Mode

Close JPME2 to bypass SPI flash security and force the system to use the Manufacturing Mode, which will allow the user to flash the system firmware from a host server to modify system settings. See the table on the right for jumper settings.

Manufacturing Mode Jumper Settings	
Pin#	Definition
Pins 1-2	Normal (Default)
Pins 2-3	Manufacturing Mode

5-9 Onboard Indicators

LAN Port LEDs

The Ethernet ports have two LEDs. On each port, one LED indicates activity when flashing while the other LED may be green, amber or off to indicate the speed of the connection. See the tables on the right for more information.

LAN Port Link Speed LED	
Color	Definition
Off	No Connection or 10 Mbps
Amber	1 Gbps
Green	100Mbps (10Gbps for 10GbE Port)

Overheat/PWR Fail/Fan Fail LED Settings		
Color	Status	Definition
Off		No Connection
Yellow	Flashing	Active

BMC Heartbeat LED

A BMC Heartbeat LED is located at LEDM1. See the table on the right for more information.

BMC Heartbeat LED Status	
Color/State	Definition
Green: Blinking	BMC: Normal

Onboard Power LED

An onboard Power LED is located at LED3 on the motherboard. When this LED is on, the system is on. Be sure to turn off the system and unplug the power cord before removing or installing components. See the table on the right for more information.

Onboard PWR LED Indicator LED Settings	
Color	Definition
Off	System Off (PWR cable not connected)
Green	System On

Overheat/PWR Fail/Fan Fail LED

An onboard Overheat/PWR Fail/Fan Fail LED is located at LED8. See the table on the right for more information.

Overheat/PWR Fail/Fan Fail LED Settings	
Color	Definition
Red Solid	Overheat
Red Blinking	Power Fail or Fan Fail

Unit Identification LED

A rear UID LED indicator (LED7) is located next to the Unit Identifier (UID) switch on the I/O back panel. The front panel UID LED is located at pin 7 of the Front Control Panel at JF1. Connect a cable to pin 7 on JF1 for front panel UID LED indication. When you press the UID switch, both rear UID LED and front panel UID LED Indicators will be turned on. Press the UID switch again to turn off both LED Indicators. These UID Indicators provide easy identification of a system unit that may be in need of service.

Note: UID can also be triggered via IPMI on the motherboard. For more information on IPMI, please refer to the IPMI User's Guide posted on our website at <http://www.supermicro.com>.

UID LED Status	
Color/State	Status
Blue: On	Unit Identified

10G LAN Activity LED

The 10G LAN Activity LED for LAN7 is located at LEDT2, and the 10G LAN LED Activity LED for LAN8 is located at LEDT4. When the LEDs are blinking, LAN7/LAN8 are active. See the table on the right for the definitions.

10G LAN Activity LED Indicator	
Color/State	Definition
LEDT2 Green: Blinking	LAN7 Active
LEDT4 Green: Blinking	LAN8 Active

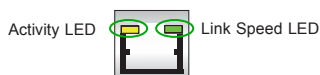

10G LAN Link Status LED

The 10G LAN Link status LED for LAN7 is located at LEDT1, and the 10G LAN Link status LED for LAN8 is located at LEDT3. When the LEDs are on, LAN7/LAN8 are working properly. See the table on the right for the colors and definitions.

10G LAN Link Status LED Indicator	
Color/State	Definition
LEDT1 Green: On	LAN7 Normal
LEDT3 Green: On	LAN8 Normal

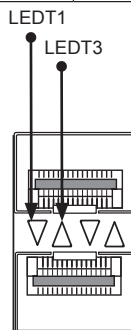

5-10 SAS/SATA/M.2 Ports

SATA Ports

This motherboard has six SATA 3.0 ports. I-SATA0 and I-SATA1 have built-in power pins to support Supermicro's SATA DOM (Disk On Module) solutions. I-SATA4 is via the JMD1 M.2 connector, I-SATA5 is via the JMP1 Mini PCI-E slot.

SAS Ports

Sixteen SAS 2.0/SATA 3.0 ports are located at JSAS1 ~ JSAS4 on the motherboard via four Mini-SAS HD cables. These SAS ports are supported by the LSI2116 SAS controller and provide serial-link signal connections.

M.2 Socket

M.2 is formerly known as Next Generation Form Factor (NGFF). The JMD1 M.2 connector is designed for internal mounting devices. The X10SDV series deploys an M key only dedicated for SSD devices with the ultimate performance capability in a PCI Express 3.0 X4 interface for native PCIe SSD support. The X10SDV M.2 is mux with the I-SATA4 port for legacy SATA SSD devices.

Mini PCI-E Slot

JMP1 is a mini PCI-E 2.0 X1 slot that is mux with I-SATA5.

5-11 Installing Drivers

The Supermicro FTP site contains drivers and utilities for your system at <ftp://ftp.supermicro.com>. Some of these must be installed, such as the chipset driver.

After accessing the FTP site, go into the CDR_Images directory and locate the ISO file for your motherboard. Download this file to create a CD/DVD of the drivers and utilities it contains. (You may also use a utility to extract the ISO file if preferred.)

Another option is to go to the Supermicro website at <http://www.supermicro.com/products/>. Find the product page for your motherboard here, where you may download individual drivers and utilities.

After creating a CD/DVD with the ISO files, insert the disk into the CD/DVD drive on your system and the display shown in Figure 5-5 should appear.

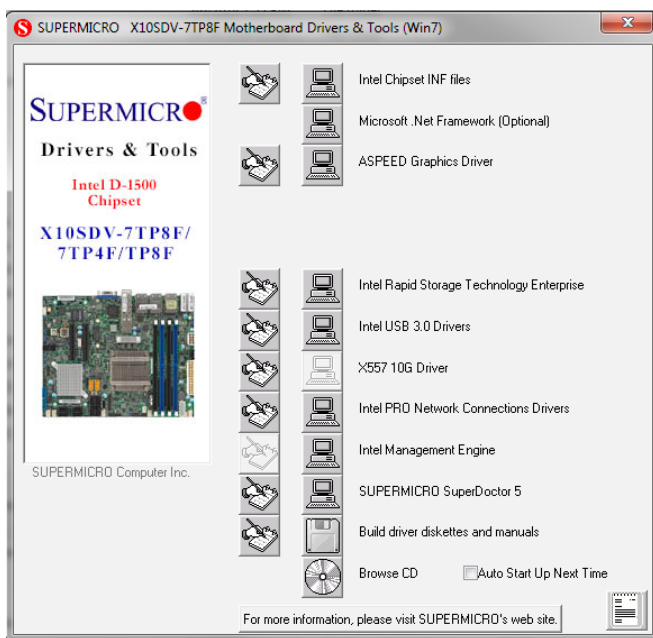

Figure 5-5. Driver Installation Display Screen

Note: Click the icons showing a hand writing on paper to view the readme files for each item. Click the computer icons to the right of these items to install each item (from top to the bottom) one at a time. **After installing each item, you must re-boot the system before moving on to the next item on the list.** The bottom icon with a CD on it allows you to view the entire contents.

SuperDoctor® 5

The Supermicro SuperDoctor 5 is a program that functions in a command-line or web-based interface in Windows and Linux operating systems. The program monitors system health information such as CPU temperature, system voltages, system power consumption, fan speed, and provides alerts via email or Simple Network Management Protocol (SNMP).

SuperDoctor 5 comes in local and remote management versions and can be used with Nagios to maximize your system monitoring needs. With SuperDoctor 5 Management Server (SSM Server), you can remotely control power on/off and reset chassis intrusion for multiple systems with SuperDoctor 5 or IPMI. SD5 Management Server monitors HTTP, FTP, and SMTP services to optimize the efficiency of your operation.

Note: The default User Name and Password for SuperDoctor 5 is admin / admin.

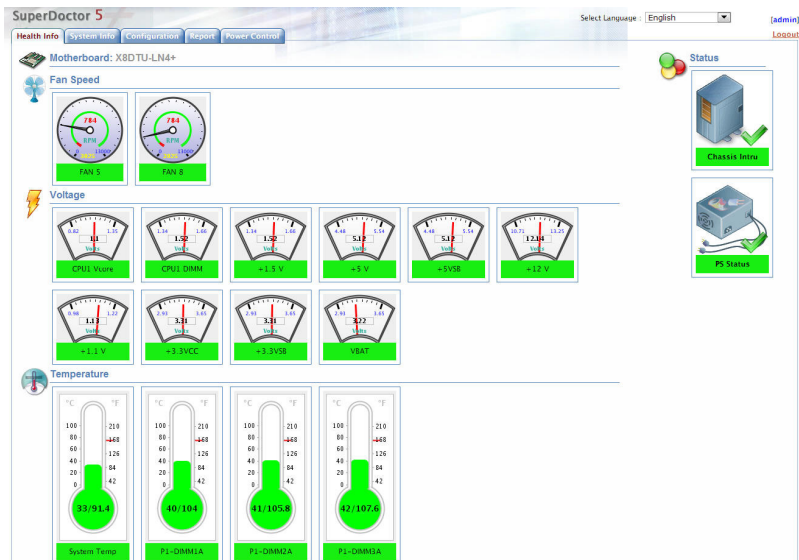

Figure 5-6. SuperDoctor 5 Interface Display Screen (Health Information)

Note: The SuperDoctor 5 program and User's Manual can be downloaded from the Supermicro website at http://www.supermicro.com/products/info/sms_sd5.cfm.

5-13 Onboard Battery

Caution: There is a danger of explosion if the onboard battery is installed in wrong orientation, which will reverse its polarities. This battery must be replaced only with the same or an equivalent type recommended by the manufacturer (CR2032). Dispose of used batteries according to the manufacturer's instructions.

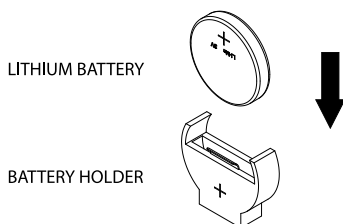

Figure 5-7. Installing the Onboard Battery

Please handle used batteries carefully. Do not damage the battery in any way; a damaged battery may release hazardous materials into the environment. Do not discard a used battery in the garbage or a public landfill. Please comply with the regulations set up by your local hazardous waste management agency to dispose of your used battery properly.

Chapter 6

Advanced Chassis Setup

This chapter covers the steps required to install components and perform maintenance on the SC813MFTQC-R407CB chassis. For component installation, follow the steps in the order given to eliminate the most common problems encountered. If some steps are unnecessary, skip ahead to the step that follows.

Tools Required: The only tool you will need to install components and perform maintenance is a Phillips screwdriver.

6-1 Static-Sensitive Devices

Electrostatic Discharge (ESD) can damage electronic components. To prevent damage to any printed circuit boards (PCBs), it is important to handle them very carefully. The following measures are generally sufficient to protect your equipment from ESD discharge.

Precautions

- Use a grounded wrist strap designed to prevent static discharge.
- Touch a grounded metal object before removing any board from its antistatic bag.
- Handle a board by its edges only; do not touch its components, peripheral chips, memory modules or gold contacts.
- When handling chips or modules, avoid touching their pins.
- Put the serverboard, add-on cards and peripherals back into their antistatic bags when not in use.
- For grounding purposes, make sure your computer chassis provides excellent conductivity between the power supply, the case, the mounting fasteners and the serverboard.

Unpacking

The serverboard is shipped in antistatic packaging to avoid static damage. When unpacking the board, make sure the person handling it is static protected.

Figure 6-1. Chassis Front View

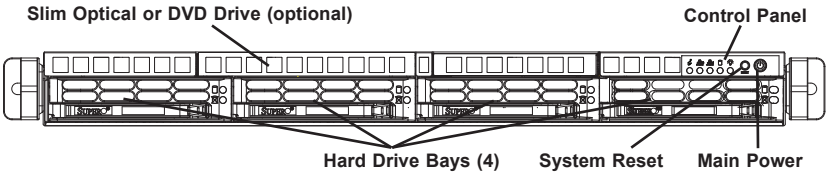
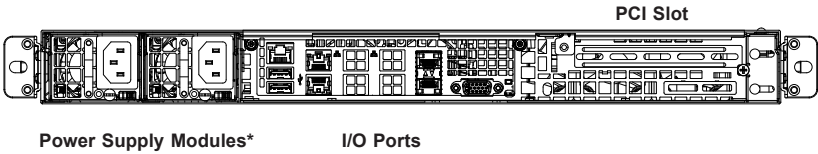

Figure 6-2. Chassis Rear View



6-2 Control Panel

The control panel (located on the front of the chassis) must be connected to the JF1 connector on the serverboard to provide you with system control buttons and status indicators. These wires have been bundled together in a ribbon cable to simplify the connection.

The LEDs inform you of system status. See Chapter 3 for details on the LEDs and the control panel buttons. Details on JF1 can be found in Chapter 5.

6-3 System Fans

Four 4-cm high-performance fans provide the cooling for the SuperServer 5018D-MHR7N4P.

The fans can adjust their speed according to the heat level sensed in the system, which results in more efficient and quieter fan operation. Fan speed is controlled by IPMI.

System Fan Failure

If a fan fails, you will need to have it replaced with the same type. Contact your vendor or Supermicro for information on replacement fans.

6-4 Drive Bay Installation/Removal

SATA Drives: Because of their hot swap capability, you do not need to access the inside of the chassis or power down the system to install or replace SAS/SATA drives. Proceed to the next step for instructions.

DVD-ROM Drive (optional): For installing/removing a DVD-ROM drive, you will need to gain access to the inside of the server by removing the top cover of the chassis. Proceed to the "DVD-ROM Drive Installation" section in this chapter for instructions. Note that only a "slim" DVD-ROM drive will fit into the 5018D-MHR7N4P.

Warning! Enterprise level hard disk drives are recommended for use in Supermicro chassis and servers. For information on recommended HDDs, visit the Supermicro web site at <http://www.supermicro.com/products/nfo/files/storage/SAS-1-CompList-110909.pdf>

SATA Drive Installation

Mounting a Drive in a Drive Carrier

The SATA drives are mounted in drive carriers to simplify their installation and removal from the chassis. These carriers also help promote proper airflow for the system. For this reason, even empty carriers without drives installed must remain in the chassis.

1. Install a new drive into the carrier with the printed circuit board side facing down so that the mounting holes align with those in the carrier.
2. Secure the drive to the carrier with six screws, as shown in Figure 6-4.

Installing/Removing SATA Drives

1. To remove a carrier, push the release button located beside the drive LEDs.
2. Swing the colored handle fully out and use it to pull the unit straight out (see Figure 6-5).

Warning! Use caution when working around the backplane. Do not touch the backplane with any metal objects and make sure no ribbon cables touch the backplane. Also, regardless of how many drives are installed, all four drive carriers must remain in the chassis to maintain proper airflow.

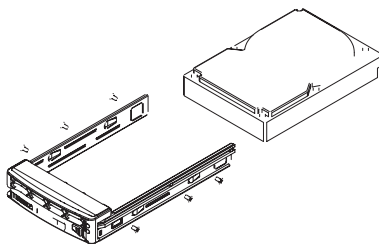

Figure 6-3. Mounting a Drive in a Carrier

SATA Backplane

The SATA drives plug into a backplane that provides power, drive ID and bus termination.

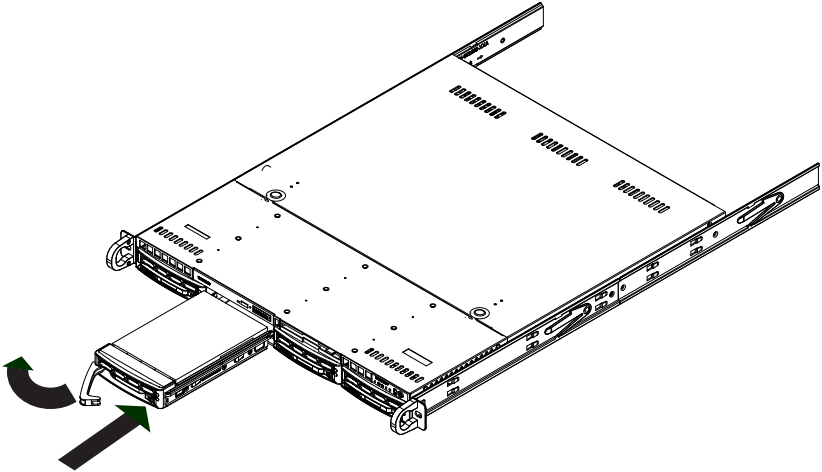

Figure 6-4. Removing a Drive from the Server

DVD-ROM Drive Installation (Optional)

The top cover of the chassis must be opened to gain full access to the DVD-ROM drive bay. The 5018D-MHR7N4P accommodates only slim DVD-ROM drives. Side mounting brackets (p/n MCP-220-81502-0N) are needed to mount a slim DVD-ROM drive into the server. You must power down the system before installing or removing a DVD-ROM drive.

Removing the Chassis Cover

1. While in a rack, grasp the two handles on either side and pull the unit straight out until it locks (you will hear a "click").
2. Depress the two buttons on the top of the chassis to release the top cover and at the same time, push the cover away from you until it stops. You can then lift the top cover from the chassis to gain full access to the inside of the server.

Removing/Installing a Drive

1. Power down the system and unplug the power cord from the rear of the power supply. Open the chassis cover
2. Secure the left rail (A) to the left side of the DVD drive using two screws (B).
3. Attach the right rail (C) to the right side of the DVD drive using two screws (D).
4. Carefully slide the DVD drive and into the chassis.
5. Plug the power cord into the power supply and power up the system.

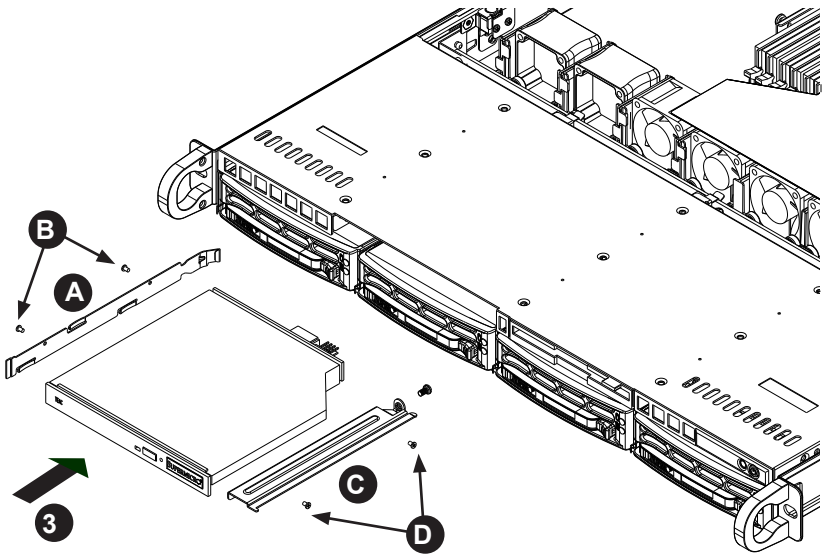

Figure 6-5. Installing a DVD-ROM Drive

6-5 Power Supply

The SuperServer 5018D-MHR7N4P has a 400 watt redundant power supply consisting of two power modules (PWS-407P-1R). Each power supply module has an auto-switching capability, which enables it to automatically sense and operate with an input voltage of 100-240V.

Power Supply Failure

If either of the two power supply modules fail, the other module will take the full load and allow the system to continue operation without interruption. The Power LED will illuminate and remain on until the failed unit has been replaced. Replacement units can be ordered directly from Supermicro. The power supply units have a hot-swap capability, meaning you can replace the failed unit without powering down the system.

Replacing the Power Supply

1. First unplug the AC power cord from the failed power supply module.
2. To remove the failed power unit, push its release tab to the side to unlock it, then pull the power supply straight out of the chassis.
3. Replace the failed unit with another unit with another of the same part number (the exact same power supply).

4. Carefully insert the new unit into position in the chassis and push it in until fully seated.
5. Reconnect the power cord to the new power supply.

Chapter 7

BIOS

7-1 Introduction

This chapter describes the AMI BIOS setup utility for the X10SDV-7TP4F motherboard. The ROM BIOS is stored in a Flash EEPROM and can be easily updated. This chapter describes the basic navigation of the AMI BIOS setup utility setup screens.

Note: For AMI BIOS Recovery, please refer to the UEFI BIOS Recovery Instructions in Appendix C.

Starting BIOS Setup Utility

To enter the AMI BIOS setup utility screens, press the <Delete> key while the system is booting up.

Note: In most cases, the <Delete> key is used to invoke the AMI BIOS setup screen. There are a few cases when other keys are used, such as <F1>, <F2>, etc.

Each main BIOS menu option is described in this manual. The Main BIOS setup menu screen has two main frames. The left frame displays all the options that can be configured. Grayed-out options cannot be configured. Options in blue can be configured by the user. The right frame displays the key legend. Above the key legend is an area reserved for a text message. When an option is selected in the left frame, it is highlighted in white. Often a text message will accompany it. (**Note:** the AMI BIOS has default text messages built in. Supermicro retains the option to include, omit, or change any of these text messages.)

The AMI BIOS setup utility uses a key-based navigation system called "hot keys". Most of the AMI BIOS setup utility "hot keys" can be used at any time during the setup navigation process. These keys include <F1>, <F4>, <Enter>, <ESC>, arrow keys, etc.

Note: Options printed in **Bold** are default settings.

How To Change the Configuration Data

The configuration data that determines the system parameters may be changed by entering the AMI BIOS setup utility. This setup utility can be accessed by pressing at the appropriate time during system boot.

How to Start the Setup Utility

Normally, the only visible Power-On Self-Test (POST) routine is the memory test. As the memory is being tested, press the <Delete> key to enter the main menu of the AMI BIOS setup utility. From the main menu, you can access the other setup screens. An AMI BIOS identification string is displayed at the left bottom corner of the screen, below the copyright message.

Warning: Do not update the BIOS unless your system has a BIOS-related issue. Flashing the wrong BIOS can cause irreparable damage to the system. In no event shall Supermicro be liable for direct, indirect, special, incidental, or consequential damages arising from a BIOS update. If you have to update the BIOS, do not shut down or reset the system while the BIOS is updating. This is to avoid possible boot failure.

7-2 Main Setup

When you first enter the AMI BIOS setup utility, you will enter the Main setup screen. You can always return to the Main setup screen by selecting the Main tab on the top of the screen. The Main BIOS Setup screen is shown below.

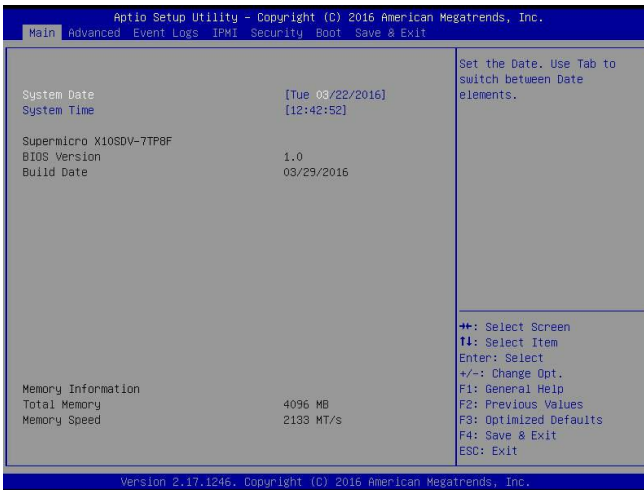

The following Main menu items will display:

System Date/System Time

Use this feature to change the system date and time. Highlight *System Date* or *System Time* using the arrow keys. Enter new values using the keyboard. Press the <Tab> key or the arrow keys to move between fields. The date must be entered in Day MM/DD/YY format. The time is entered in HH:MM:SS format.

Note: The time is in the 24-hour format. For example, 5:30 P.M. appears as 17:30:00.

The following BIOS items will also be displayed:

Supermicro X10SDV-7TP4F**Version****Build Date****Memory Information****Total Memory**

This displays the total size of memory available in the system.

7-3 Advanced Setup Configurations

Use the arrow keys to select Boot Setup and press <Enter> to access the submenu items.

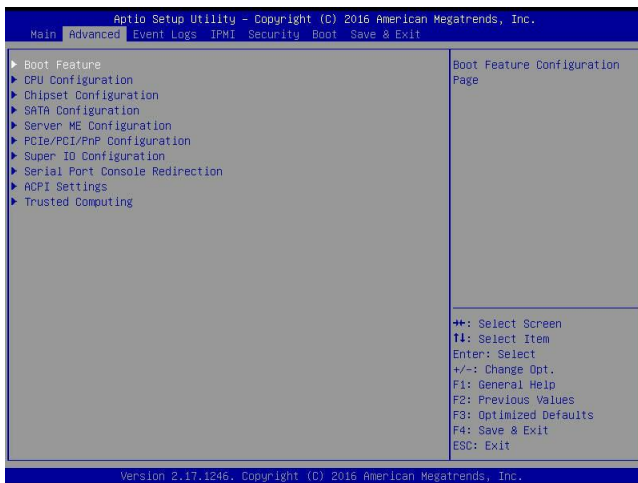

Warning: Take caution when changing the Advanced settings. An incorrect value, a very high DRAM frequency, or an incorrect DRAM timing setting may make the system unstable. When this occurs, revert to the default to the manufacture default settings.

► Boot Feature

Quiet Boot

Use this feature to select the screen display between the POST messages and the OEM logo upon bootup. Select Disabled to display the POST messages. Select Enabled to display the OEM logo instead of the normal POST messages. The options are **Enabled** and Disabled.

AddOn ROM Display Mode

Use this feature to set the display mode for the Option ROM. Select Keep Current to display the current AddOn ROM setting. Select Force BIOS to use the Option ROM display set by the system BIOS. The options are **Force BIOS** and Keep Current.

Startup NumLock State

Use this feature to set the Power-on state for the <Numlock> key. The options are Off and **On**.

Wait For 'F1' If Error

Use this feature to force the system to wait until the 'F1' key is pressed if an error occurs. The options are Disabled and **Enabled**.

INT19 (Interrupt 19) Trap Response

Interrupt 19 is the software interrupt that handles the boot disk function. When this item is set to Immediate, the ROM BIOS of the host adaptors will "capture" Interrupt 19 at bootup immediately and allow the drives that are attached to these host adaptors to function as bootable disks. If this item is set to Postponed, the ROM BIOS of the host adaptors will not capture Interrupt 19 immediately and allow the drives attached to these adaptors to function as bootable devices at bootup. The options are **Immediate** and Postponed.

Re-try Boot

If this item is enabled, the BIOS will automatically reboot the system from a specified boot device after its initial boot failure. The options are **Disabled**, Legacy Boot, and EFI Boot.

► Power Configuration**Watch Dog Function**

If enabled, the Watch Dog Timer will allow the system to reset or generate NMI based on jumper settings when it is expired for more than 5 minutes. The options are Enabled and **Disabled**.

Power Button Function

This feature controls how the system shuts down when the power button is pressed. Select 4 Seconds Override for the user to power off the system after pressing and holding the power button for 4 seconds or longer. Select Instant Off to instantly power off the system as soon as the user presses the power button. The options are 4 Seconds Override and **Instant Off**.

Restore on AC Power Loss

Use this feature to set the power state after a power outage. Select Stay-Off for the system power to remain off after a power loss. Select Power-On for the system power to be turned on after a power loss. Select Last State to allow the system to resume its last power state before a power loss. The options are Power On, Stay Off, and **Last State**.

► CPU Configuration

The following CPU information will be displayed:

- Processor ID
- Processor Frequency
- Processor Max Ratio
- Processor Min Ratio
- Microcode Revision
- L1 Cache RAM
- L2 Cache RAM
- L3 Cache Ram
- CPU Version

Clock Spread Spectrum

If this feature is set to Enabled, the BIOS utility will monitor the level of Electro-magnetic Interference caused by the components and will attempt to reduce the interference whenever needed. The options are **Disable** and Enable.

Hyper-Threading (ALL)

Select Enable to use Intel Hyper-Threading Technology to enhance CPU performance. The options are Disable and **Enable**.

Cores Enabled

Set a numeric value to enable the number of cores. (Please refer to Intel's website for more information.) Enter **0** to enable all cores.

Monitor/Mwait

Select Enabled to enable the Monitor/MWait instructions. The Monitor instruction monitors a region of memory for writes, and MWait instructions instruct the CPU to stop until the monitored region begins to write. The options are Disable and **Enable**.

Execute Disable Bit (Available if supported by the OS & the CPU)

Select Enabled to enable the Execute-Disable Bit which will allow the processor to designate areas in the system memory where an application code can execute and where it cannot, thus preventing a worm or a virus from flooding illegal codes to overwhelm the processor or damage the system during an attack. The default is **Enable**. (Refer to the Intel® and Microsoft® websites for more information.)

PPIN Control

Select Unlock/Enable to use the Protected-Processor Inventory Number (PPIN) in the system. The options are **Unlock/Enable** and Unlock/Disable.

Hardware Prefetcher (Available when supported by the CPU)

If set to Enabled, the hardware prefetcher will prefetch streams of data and instructions from the main memory to the L2 cache to improve CPU performance. The options are Disable and **Enable**.

Adjacent Cache Prefetch (Available when supported by the CPU)

The CPU prefetches the cache line for 64 bytes if this feature is set to Disabled. The CPU prefetches both cache lines for 128 bytes as comprised if this feature is set to **Enable**.

DCU Streamer Prefetcher (Available when supported by the CPU)

Select Enabled to enable the DCU (Data Cache Unit) Streamer Prefetcher which will stream and prefetch data and send it to the Level 1 data cache to improve data processing and system performance. The options are Disable and **Enable**.

DCU IP Prefetcher (Available when supported by the CPU)

Select Enabled for DCU (Data Cache Unit) IP Prefetcher support, which will prefetch IP addresses to improve network connectivity and system performance. The options are Disable and **Enable**.

Direct Cache Access (DCA)

Select Enabled to use Intel's DCA (Direct Cache Access) Technology to improve data transfer efficiency. The options are Disable, Enable, and **Auto**.

Intel® Virtualization Technology (Available when supported by the CPU)

Select Enabled to support Intel Virtualization Technology, which will allow one platform to run multiple operating systems and applications in independent partitions, creating multiple "virtual" systems in one physical computer. The options are Disable and **Enable**.

Note: If a change is made to this setting, you will need to reboot the system for the change to take effect. Refer to Intel's website for detailed information.

► Advanced Power Management Configuration

This section is used to configure the following CPU Power Management settings.

EIST (P-States)

EIST (Enhanced Intel SpeedStep Technology) allows the system to automatically adjust processor voltage and core frequency to reduce power consumption and heat dissipation. The options are Disable and **Enable**.

If the above is set to Enable, CPU P State will display:

► CPU P State Control

P State Domain

This feature allows the user to indicate the P-State domain for each logical process in the system. All processes indicate the same domain in the same package. The options are **ALL** and **ONE**.

P-State Coordination

This feature allows the user to change the P-State (Power-Performance State) coordination type. P-State is also known as "SpeedStep" for Intel processors. Select **HW_ALL** to change the P-State coordination type for hardware components only. Select **SW_ALL** to change the P-State coordination type for all software installed in the system. Select **SW_ANY** to change the P-State coordination type for a software program in the system. The options are **HW_All**, **SW_ALL**, and **SW_ANY**.

Energy Efficient P-State

Select **Enable** to support power-saving mode for P-State. The options are **Disable** and **Enable**.

Boot Performance Mode

This feature allows the user to select the performance state that the BIOS will set before the operating system handoff. The options are **Max Performance** and **Max Efficient**.

Turbo Mode

Select **Enable** for processor cores to run faster than the frequency specified by the manufacturer. The options are **Disable** and **Enable**.

► CPU HWPM State Control

Enable CPU HWPM

Select Enable for better CPU energy performance. The options are **Disable**, HWPM NATIVE MODE, and HWPM OOB MODE.

Enable CPU Autonomous Cstate

Use this feature to enable CPU Autonomous C State, which converts HALT instructions to Mwait. The options are Disable and **Enable**.

► CPU C State Control

CPU C State

Use this feature to enable the enhanced C State of the CPU. The options are Disable and **Enable**.

Package C State Limit

This feature allows the user to set the limit on the C State package register. The options are C0/C1 State, C2 State, C6 (Non Retention) State, and **C6 (Retention) state**.

CPU C3 Report

Select Enabled to allow the BIOS to report the CPU C3 State (ACPI C2) to the operating system. During the CPU C3 State, the CPU clock generator is turned off. The options are Enable and **Disable**.

CPU C6 Report

Select Enabled to allow the BIOS to report the CPU C6 State (ACPI C3) to the operating system. During the CPU C6 State, the power to all cache is turned off. The options are Disable and **Enable**.

Enhanced Halt State (C1E)

Select Enabled to use Enhanced Halt-State technology, which will significantly reduce the CPU's power consumption by reducing the CPU's clock cycle and voltage during a Halt-state. The options are Disable and **Enable**.

▶ CPU T State Control

ACPI (Advanced Configuration Power Interface) T-States

Select Enable to support CPU throttling by the operating system to reduce power consumption. The options are **Disable** and Enable.

▶ CPU Advanced PM Turning

▶ Energy Perf BIAS

Energy Performance Tuning

When enabled, this item selects whether the BIOS or Operating System can turn on the energy performance bias tuning. The options are Disable and **Enable**.

If the above is set to Disable, Energy Performance BIAS Setting will display:

Energy Performance BIAS Setting

This feature allows balancing Power Efficiency vs Performance. This will override whatever setting is in the Operating System. The options are Performance, **Balanced Performance**, Balanced Power, and Power.

Power/Performance Switch

This feature allows dynamic switching between Power and Performance power efficiency. The options are Disable and **Enable**.

Workload Configuration

This feature allows for optimization of workload. Balanced is recommended. The options are **Balanced** and I/O Sensitive.

▶ Program PowerCTL_MSR

PKG C-state Lat. Neg.

Use this feature to indicate whether latency should be negotiated with PCH for packaging C-States. The options are **Enable** and Disable.

SAPM Control

This feature indicates whether the PCU should control the System Agent PM using its power-performance tuning algorithm. The options are **Enable** and Disable.

Energy Efficient Turbo

Use this feature to enable energy efficient turbo mode. The options are **Enable** and Disable.

► DRAM RAPL Configuration

Override BW_LIMIT_TF

This feature allows the user to turn off the "Override BW_LIMIT_TF (Time Frame)" setting when the item "Running Average Limit for DRAM modules" (DRAM RAPL) is set to Enabled so that the DRAM RAPL setting can work properly. The default setting is 1.

DRAM RAPL Extended Range

Use this feature to set the DRAM Running Average Power Limit (RAPL) Extended Range. The options are Disable and **Enable**.

► Chipset Configuration

Warning: Setting the wrong values in the following features may cause the system to malfunction.

► North Bridge

This feature allows the user to configure the following North Bridge settings.

► IIO Configuration

EV DFX (Device Function On-Hide) Features

When this feature is set to Enable, the EV_DFX Lock Bits that are located on a processor will always remain clear during electric tuning. The options are **Disable** and Enable.

► IIO1 Configuration

M.2 PCI-E 3.0 X4

This item configures the link speed of the PCI-E port specified by the user. The options are Gen 1 (Generation 1) (2.5 GT/s), Gen 2 (Generation 2) (5 GT/s), and **Gen 3 (Generation 3) (8 GT/s)**.

CPU SLOT 6 PCI-E 3.0 X8

This item configures the link speed of the PCI-E port specified by the user. The options are Gen 1 (Generation 1) (2.5 GT/s), Gen 2 (Generation 2) (5 GT/s), and **Gen 3 (Generation 3) (8 GT/s)**.

CPU SLOT 7 PCI-E 3.0 X8

This item configures the link speed of the PCI-E port specified by the user. The options are Gen 1 (Generation 1) (2.5 GT/s), Gen 2 (Generation 2) (5 GT/s), and **Gen 3 (Generation 3) (8 GT/s)**.

►IOAT (Intel® IO Acceleration) Configuration**Enable IOAT**

Select Enable to enable Intel I/OAT (I/O Acceleration Technology) support, which significantly reduces CPU overhead by leveraging CPU architectural improvements and freeing the system resource for other tasks. The options are Disable and **Enable**.

No Snoop

Select Enable to support no-snoop mode for each CB device. The options are **Disable** and Enable.

►Intel® VT for Directed I/O (VT-d)**Intel VT for Directed I/O (VT-d)**

Select Enable to use Intel Virtualization Technology support for Direct I/O VT-d support by reporting the I/O device assignments to the VMM (Virtual Machine Monitor) through the DMAR ACPI Tables. This feature offers fully-protected I/O resource sharing across Intel platforms, providing greater reliability, security and availability in networking and data-sharing. The options are **Enable** and Disable.

ACS Control

Use this feature to program Access Control Services (ACS) to the PCI-E Root Port Bridges. The options are **Enable** and Disable.

Interrupt Remapping

Select Enable for Interrupt Remapping support to enhance system performance. The options are **Enable** and Disable.

► Memory Configuration

Enforce POR

Select Enable to enforce POR restrictions on DDR4 frequency and voltage programming. The options are **Enabled** and Disabled.

Memory Frequency

Use this feature to set the maximum memory frequency for onboard memory modules. The options are **Auto**, 1333, 1400, 1600, 1800, 1867, 2000, 2133, 2200, 2400, 2600, 2667, 2800, 2993, 3000, 3200, and Reserved (Do not select Reserved).

Data Scrambling

Select Enabled to enable data scrambling to enhance system performance and data integrity. The options are **Auto**, Disabled, and Enabled.

DRAM RAPL Baseline

Use this feature to set the run-time power-limit baseline for DRAM modules. The options are Disable, DRAM RAPL Mode 0, and **DRAM RAPL Mode 1**.

Set Throttling Mode

Throttling improves reliability and reduces power consumption in the processor via automatic voltage control during processor idle states. The options are Disabled and **CLTT** (Closed Loop Thermal Throttling).

A7 Mode

Select Enabled to support the A7 (Addressing) mode to improve memory performance. The options are **Enable** and Disable.

► DIMM Information

This item displays the status of a DIMM module specified by the user.

- DIMMA1
- DIMMB1
- DIMMA2
- DIMMB2

► Memory RAS (Reliability_Availability_Serviceability) Configuration

Use this submenu to configure the following Memory RAS settings.

Patrol Scrub

Patrol Scrubbing is a process that allows the CPU to correct correctable memory errors detected on a memory module and send the correction to the requestor (the original source). When this item is set to Enabled, the IO hub will read and write back one cache line every 16K cycles, if there is no delay caused by internal processing. By using this method, roughly 64 GB of memory behind the IO hub will be scrubbed every day. The options are **Enable** and Disable.

Patrol Scrub Interval

This feature allows you to decide how many hours the system should wait before the next complete patrol scrub is performed. Use the keyboard to enter a value from 0-24. The default setting is **24**.

Demand Scrub

Demand Scrubbing is a process that allows the CPU to correct correctable memory errors found on a memory module. When the CPU or I/O issues a demand-read command, and the read data from memory turns out to be a correctable error, the error is corrected and sent to the requestor (the original source). Memory is updated as well. Select Enable to use Demand Scrubbing for ECC memory correction. The options are Disable and **Enable**.

Device Tagging

Select Enable to support device tagging. The options are **Disable** and Enable.

► South Bridge

The following South Bridge information will display:

- USB Configuration
- USB Module Version
- USB Devices

Legacy USB Support

This feature enables support for legacy USB devices. Select Auto to disable legacy support if USB devices are not present. Select Disable to have USB devices available only for EFI applications. The options are **Enabled**, Disabled, and Auto.

XHCI Hand-Off

This is a work-around solution for operating systems that do not support XHCI (Extensible Host Controller Interface) hand-off. The XHCI ownership change should be claimed by the XHCI driver. The settings are **Enabled** and Disabled.

EHCI Hand-Off

This item is for the Operating Systems that do not support Enhanced Host Controller Interface (EHCI) hand-off. When this item is enabled, EHCI ownership change will be claimed by the EHCI driver. The settings are Enabled and **Disabled**.

USB 3.0 Support

Select Enabled for USB 3.0 support. The options are Smart Auto, **Auto**, Enabled, Disabled.

EHCI1

Select Enabled to enable EHCI (Enhanced Host Controller Interface) support on USB 2.0 connector #1 (at least one USB 2.0 connector should be enabled for EHCI support). The options are Disabled and **Enabled**.

EHCI2

Select Enabled to enable EHCI (Enhanced Host Controller Interface) support on USB 2.0 connector #2 (at least one USB 2.0 connector should be enabled for EHCI support). The options are Disabled and **Enabled**.

XHCI Pre-Boot Driver

Select Enabled to enable XHCI (Extensible Host Controller Interface) support on a pre-boot drive specified by the user. The options are **Enabled** and Disabled.

► SATA Configuration

When this submenu is selected, the AMI BIOS automatically detects the presence of the SATA devices that are supported by the Intel PCH chip and displays the following items:

SATA Controller

This item enables or disables the onboard SATA controller supported by the Intel PCH chip. The options are **Enabled** and Disabled.

Configure SATA as

Select IDE to configure a SATA drive specified by the user as an IDE drive. Select AHCI to configure a SATA drive specified by the user as an AHCI drive. Select RAID to configure a SATA drive specified by the user as a RAID drive. The options are IDE, **AHCI**, and RAID.

**If the item "Configure SATA as" is set to AHCI, the following items will display:*

SATA Frozen

Use this item to enable the HDD Security Frozen Mode. The options are **Disabled** and Enabled.

SATA AHCI LPM

Use this feature to enable the Link Power Management for SATA AHCI. The options are Disabled and **Enabled**.

Support Aggressive Link Power Mgmt

When this item is set to Enabled, the SATA AHCI controller manages the power usage of the SATA link. The controller will put the link in a low power mode during extended periods of I/O inactivity, and will return the link to an active state when I/O activity resumes. The options are Disabled and **Enabled**.

SATA RAID Option ROM/UEFI Driver (Available if "Configure SATA As" is set to RAID)

Select Enabled to use the SATA RAID Option ROM/UEFI driver for system boot. The options are **Enabled** and Disabled.

SATA Port 0~ Port 5

This item displays the information detected on the installed SATA drive on the particular SATA port.

- Model number of drive and capacity
- Software Preserve Support

Port 0 ~ Port 5 Hot Plug

This feature designates this port for hot plugging. Set this item to Enabled for hot-plugging support, which will allow the user to replace a SATA drive without shutting down the system. The options are **Enabled** and Disabled.

Port 0 ~ Port 5 Spin Up Device

On an edge detect from 0 to 1, set this item to allow the PCH to initialize the device. The options are Enabled and **Disabled**.

Port 0 ~ Port 5 SATA Device Type

Use this item to specify if the SATA port specified by the user should be connected to a Solid State drive or a Hard Disk Drive. The options are Hard Disk Drive and Solid State Drive.

****If the item "Configure SATA as" is set to IDE, the following items will display:***

SATA Frozen

Use this item to enable the HDD Security Frozen Mode. The options are **Disabled** and Enabled.

Port 0 ~ Port 5 SATA Device Type (Available when a SATA port is detected)

Use this item to specify if the SATA port specified by the user should be connected to a Solid State drive or a Hard Disk Drive. The options are Hard Disk Drive and Solid State Drive.

► Server ME (Management Engine) Configuration

This feature displays the following system ME configuration settings.

- General ME Configuration
- Operational Firmware Version
- ME Firmware Type
- Recovery Firmware Version
- ME Firmware Features
- ME Firmware Status #1
- ME Firmware Status #2
 - Current State
 - Error Code

► PCIe/PCI/PnP Configuration

The following information will display:

- PCI Bus Driver Version
- PCI Devices Common Settings:

PCI PERR/SERR Support

Select Enabled to allow a PCI device to generate a PERR/SERR number for a PCI Bus Signal Error Event. The options are Enabled and **Disabled**.

Above 4G Decoding (Available if the system supports 64-bit PCI decoding)

Select Enabled to decode a PCI device that supports 64-bit in the space above 4G Address. The options are **Disabled** and Enabled.

SR-IOV (Available if the system supports Single-Root Virtualization)

Select Enabled for Single-Root IO Virtualization support. The options are **Disabled** and Enabled.

Maximum Payload

Use this feature to select the setting for the PCI Express maximum payload size. The options are **Auto**, 128 Bytes, 256 Bytes, 512 Bytes, 1024 Bytes, 2048 Bytes, and 4096 Bytes.

Relaxed Ordering

Select Enable to enable Relaxed Ordering support which will allow certain transactions to violate the strict-ordering rules of PCI bus for a transaction to be completed prior to other transactions that have already been enqueued. The options are **Disabled** and Enabled.

Extended Tag

Use this item to allow a device to use the 8-bit tag field as a requester. The options are **Disabled** and Enabled.

ARI Forwarding

When this feature is enabled, the Downstream Port disables its traditional device number to 0 when turning Type1 Configuration Request into a Type0 Configuration Request. The default value is **Disabled**.

M.2 PCI-E 3.0 X4

Use this feature to select which firmware type to be loaded for the add-on card in this slot. The options are Disabled, **Legacy**, and EFI.

CPU SLOT 6 PCI-E 3.0 X8 OPROM

Use this feature to select which firmware type to be loaded for the add-on card in this slot. The options are Disabled, **Legacy**, and EFI.

CPU SLOT 7 PCI-E 3.0 X8 OPROM

Use this feature to select which firmware type to be loaded for the add-on card in this slot. The options are Disabled, **Legacy**, and EFI.

PCI-E 2.0 X1 OPROM

Use this feature to select which firmware type to be loaded for the add-on card in this slot. The options are Disabled, **Legacy**, and EFI.

Onboard SAS Option ROM

Use this feature to select which firmware to be loaded for the onboard SAS Option ROM. The options are Disabled, **Legacy**, and EFI.

Onboard LAN Option ROM Type

Use this feature to select which firmware to be loaded for the onboard LAN. The options are **Legacy** and EFI.

Onboard LAN1 Option ROM

Use this option to select the type of device installed in LAN Port1 used for system boot. The default setting for LAN1 Option ROM is **PXE**.

Onboard LAN2 ~ LAN8 Option ROM

Use this option to select the type of device installed in the specified LAN Ports used for system boot. The options are **Disabled** and PXE.

Onboard Video Option ROM

Use this item to select the Onboard Video Option ROM type. The options are Disabled, **Legacy**, and EFI.

VGA Priority

This feature allows the user to select the graphics adapter to be used as the primary boot device. The options are **Onboard** and Offboard.

Network Stack

Select Enabled enable PXE (Preboot Execution Environment) or UEFI (Unified Extensible Firmware Interface) for network stack support. The options are Enabled and **Disabled**.

****If "Network Stack" is set to Enabled, the four items below will become available for configuration:***

IPv4 PXE Support

Select Enabled to enable IPv4 PXE boot support. The options are Disabled and **Enabled**.

IPv6 PXE Support

Select Enabled to enable IPv6 PXE boot support. The options are **Disabled** and Enabled.

PXE boot wait time

Use this option to specify the wait time to press the ESC key to abort the PXE boot. Press "+" or "-" on your keyboard to change the value. The default setting is **0**.

Media detect count

Use this option to specify the number of times media will be checked. Press "+" or "-" on your keyboard to change the value. The default setting is **1**.

► Super IO Configuration**Super IO Chip AST2400****► Serial Port 1 Configuration**

This submenu allows the user the configure settings of Serial Port 1 or Serial Port 2.

Serial Port

Select **Enabled** to enable the selected onboard serial port. The options are **Disabled** and **Enabled**.

Device Settings

This item displays the status of a serial part specified by the user.

Change Port 1 Settings

This feature specifies the base I/O port address and the Interrupt Request address of a serial port specified by the user. Select **Auto** to allow the BIOS to automatically assign the base I/O and IRQ address.

The options for Serial Port 1 are **Auto**, (IO=3F8h; IRQ=4), (IO=3F8h; IRQ=3, 4, 5, 6, 7, 9, 10, 11, 12), (IO=2F8h; IRQ=3, 4, 5, 6, 7, 9, 10, 11, 12), (IO=3E8h; IRQ=3, 4, 5, 6, 7, 9, 10, 11, 12) and (IO=2E8h; IRQ=3, 4, 5, 6, 7, 9, 10, 11, 12).

► Serial Port Console Redirection**COM1 Console Redirection****Console Redirection**

Select **Enabled** to enable console redirection support for a serial port specified by the user. The options are **Disabled** and **Enabled**.

►COM1 Console Redirection Settings

This feature allows the user to specify how the host computer will exchange data with the client computer, which is the remote computer used by the user.

Terminal Type

This feature allows the user to select the target terminal emulation type for Console Redirection. Select VT100 to use the ASCII Character set. Select VT100+ to add color and function key support. Select ANSI to use the Extended ASCII Character Set. Select VT-UTF8 to use UTF8 encoding to map Unicode characters into one or more bytes. The options are ANSI, VT100, **VT100+**, and VT-UTF8.

Bits Per second

Use this feature to set the transmission speed for a serial port used in Console Redirection. Make sure that the same speed is used in the host computer and the client computer. A lower transmission speed may be required for long and busy lines. The options are 9600, 19200, 38400, 57600, and **115200** (bits per second).

Data Bits

Use this feature to set the data transmission size for Console Redirection. The options are 7 Bits and **8 Bits**.

Parity

A parity bit can be sent along with regular data bits to detect data transmission errors. Select Even if the parity bit is set to 0, and the number of 1's in data bits is even. Select Odd if the parity bit is set to 0, and the number of 1's in data bits is odd. Select None if you do not want to send a parity bit with your data bits in transmission. Select Mark to add a mark as a parity bit to be sent along with the data bits. Select Space to add a Space as a parity bit to be sent with your data bits. The options are **None**, Even, Odd, Mark and Space.

Stop Bits

A stop bit indicates the end of a serial data packet. Select 1 Stop Bit for standard serial data communication. Select 2 Stop Bits if slower devices are used. The options are **1** and **2**.

Flow Control

Use this feature to set the flow control for Console Redirection to prevent data loss caused by buffer overflow. Send a "Stop" signal to stop sending data when the receiving buffer is full. Send a "Start" signal to start sending data when the receiving buffer is empty. The options are **None** and Hardware RTS/CTS.

VT-UTF8 Combo Key Support

Select Enabled to enable VT-UTF8 Combination Key support for ANSI/VT100 terminals. The options are Disabled and **Enabled**.

Recorder Mode

Select Enabled to capture the data displayed on a terminal and send it as text messages to a remote server. The options are **Disabled** and Enabled.

Resolution 100x31

Select Enabled for extended-terminal resolution support. The options are Disabled and **Enabled**.

Legacy OS Redirection Resolution

Use this feature to select the number of rows and columns used in Console Redirection for legacy OS support. The options are 80x24 and **80x25**.

Putty KeyPad

This feature selects the settings for Function Keys and Keypad used for Putty, which is a terminal emulator designed for the Windows OS. The options are **VT100**, LINUX, XTERMR6, SC0, ESCN, and VT400.

Redirection After BIOS POST

Use this feature to enable or disable legacy console redirection after BIOS POST. When set to Bootloader, legacy console redirection is disabled before booting the OS. When set to Always Enable, legacy console redirection remains enabled when booting the OS. The options are **Always Enable** and Bootloader.

SOL Console Redirection

Select Enabled to use the SOL port for Console Redirection. The options are Disabled and **Enabled**.

****If the item above set to Enabled, the following items will become available for user's configuration:***

► SOL Console Redirection Settings

Use this feature to specify how the host computer will exchange data with the client computer, which is the remote computer used by the user.

Terminal Type

Use this feature to select the target terminal emulation type for Console Redirection. Select VT100 to use the ASCII Character set. Select VT100+ to add color and

function key support. Select ANSI to use the Extended ASCII Character Set. Select VT-UTF8 to use UTF8 encoding to map Unicode characters into one or more bytes. The options are ANSI, VT100, **VT100+**, and VT-UTF8.

Bits Per second

Use this feature to set the transmission speed for a serial port used in Console Redirection. Make sure that the same speed is used in the host computer and the client computer. A lower transmission speed may be required for long and busy lines. The options are 9600, 19200, 38400, 57600 and **115200** (bits per second).

Data Bits

Use this feature to set the data transmission size for Console Redirection. The options are 7 (Bits) and **8 (Bits)**.

Parity

A parity bit can be sent along with regular data bits to detect data transmission errors. Select Even if the parity bit is set to 0, and the number of 1's in data bits is even. Select Odd if the parity bit is set to 0, and the number of 1's in data bits is odd. Select None if you do not want to send a parity bit with your data bits in transmission. Select Mark to add a mark as a parity bit to be sent along with the data bits. Select Space to add a Space as a parity bit to be sent with your data bits. The options are **None**, Even, Odd, Mark and Space.

Stop Bits

A stop bit indicates the end of a serial data packet. Select 1 Stop Bit for standard serial data communication. Select 2 Stop Bits if slower devices are used. The options are **1** and **2**.

Flow Control

Use this feature to set the flow control for Console Redirection to prevent data loss caused by buffer overflow. Send a "Stop" signal to stop sending data when the receiving buffer is full. Send a "Start" signal to start sending data when the receiving buffer is empty. The options are None and Hardware RTS/CTS.

VT-UTF8 Combo Key Support

Select Enabled to enable VT-UTF8 Combination Key support for ANSI/VT100 terminals. The options are Disabled and **Enabled**.

Recorder Mode

Select Enabled to capture the data displayed on a terminal and send it as text messages to a remote server. The options are **Disabled** and Enabled.

Resolution 100x31

Select Enabled for extended-terminal resolution support. The options are Disabled and **Enabled**.

Legacy OS Redirection Resolution

Use this feature to select the number of rows and columns used in Console Redirection for legacy OS support. The options are 80x24 and **80x25**.

Putty KeyPad

This feature selects Function Keys and KeyPad settings for Putty, which is a terminal emulator designed for the Windows OS. The options are **VT100**, LINUX, XTERMR6, SCO, ESCN, and VT400.

Redirection After BIOS POST

Use this feature to enable or disable legacy Console Redirection after BIOS POST. When set to Bootloader, legacy Console Redirection is disabled before booting the OS. When set to Always Enable, legacy Console Redirection remains enabled when booting the OS. The options are **Always Enable** and Bootloader.

Serial Port for Out-of-Band Management/Windows Emergency Management Services (EMS)

The submenu allows the user to configure Console Redirection settings to support Out-of-Band Serial Port management.

EMS (Emergency Management Services) Console Redirection

Select Enabled to use a COM port selected by the user for EMS Console Redirection. The options are Enabled and **Disabled**.

****If the item above set to Enabled, the following items will become available for user's configuration:***

►EMS Console Redirection Settings

This feature allows the user to specify how the host computer will exchange data with the client computer, which is the remote computer used by the user.

Out-of-Band Mgmt Port

The feature selects a serial port in a client server to be used by the Microsoft Windows Emergency Management Services (EMS) to communicate with a remote host server. The options are **COM1** and COM2/SOL.

Terminal Type

Use this feature to select the target terminal emulation type for Console Redirection. Select VT100 to use the ASCII character set. Select VT100+ to add color and

function key support. Select ANSI to use the extended ASCII character set. Select VT-UTF8 to use UTF8 encoding to map Unicode characters into one or more bytes. The options are ANSI, VT100, VT100+, and **VT-UTF8**.

Bits Per Second

This item sets the transmission speed for a serial port used in Console Redirection. Make sure that the same speed is used in the host computer and the client computer. A lower transmission speed may be required for long and busy lines. The options are 9600, 19200, 57600, and **115200** (bits per second).

Flow Control

Use this item to set the flow control for Console Redirection to prevent data loss caused by buffer overflow. Send a "Stop" signal to stop sending data when the receiving buffer is full. Send a "Start" signal to start sending data when the receiving buffer is empty. The options are **None**, Hardware RTS/CTS, and Software Xon/Xoff.

Data Bits

Use this feature to set the data transmission size for Console Redirection. The options are 7 (Bits) and **8 (Bits)**.

Parity

A parity bit can be sent along with regular data bits to detect data transmission errors. Select Even if the parity bit is set to 0, and the number of 1's in data bits is even. Select Odd if the parity bit is set to 0, and the number of 1's in data bits is odd. Select None if you do not want to send a parity bit with your data bits in transmission. Select Mark to add a mark as a parity bit to be sent along with the data bits. Select Space to add a Space as a parity bit to be sent with your data bits. The options are **None**, Even, Odd, Mark and Space.

Stop Bits

A stop bit indicates the end of a serial data packet. Select 1 Stop Bit for standard serial data communication. Select 2 Stop Bits if slower devices are used. The options are **1** and **2**.

►ACPI Settings

WHEA Support

This feature Enables the Windows Hardware Error Architecture (WHEA) support for the Windows 2008 (or a later version) operating system. The options are Disabled and **Enabled**.

High Precision Event Timer

Select Enabled to activate the High Performance Event Timer (HPET) that produces periodic interrupts at a much higher frequency than a Real-time Clock (RTC) does in synchronizing multimedia streams, providing smooth playback and reducing the dependency on other timestamp calculation devices, such as an x86 RDTSC Instruction embedded in the CPU. The High Performance Event Timer is used to replace the 8254 Programmable Interval Timer. The options are Disabled and **Enabled**.

PCI AER Support

Select Enabled to enable the ACPI OS to manage PCI Advanced Error Reporting. The options are **Disabled** and Enabled.

► Trusted Computing

Configuration

Security Device Support

If this feature and the TPM jumper on the motherboard are both set to Enabled, onboard security devices will be enabled for TPM (Trusted Platform Module) support to enhance data integrity and network security. Please reboot the system for a change on this setting to take effect. The options are Disabled and **Enabled**.

TPM State

This feature changes the TPM State. The options are **Disabled** and Enabled.

Note: The system will restart to change the TPM State.

Pending operation

Use this item to schedule a TPM-related operation to be performed by a security device for system data integrity. Your system will reboot to carry out a pending TPM operation. The options are **None** and TPM Clear.

Device Select

Use this feature to select the TPM version. TPM 1.2 will restrict support to TPM 1.2 devices. TPM 2.0 will restrict support for TPM 2.0 devices. Select Auto to enable support for both versions. The default setting is **Auto**.

The following are informational status messages that indicate the current TPM State:

TPM Enabled Status**TPM Active Status****TPM Owner Status****TXT Support**

Intel TXT (Trusted Execution Technology) helps protect against software-based attacks and ensures protection, confidentiality and integrity of data stored or created on the system. Use this feature to enable or disable TXT Support. The options are **Disabled** and **Enabled**.

7-4 Event Logs

Use this feature to configure Event Log settings.

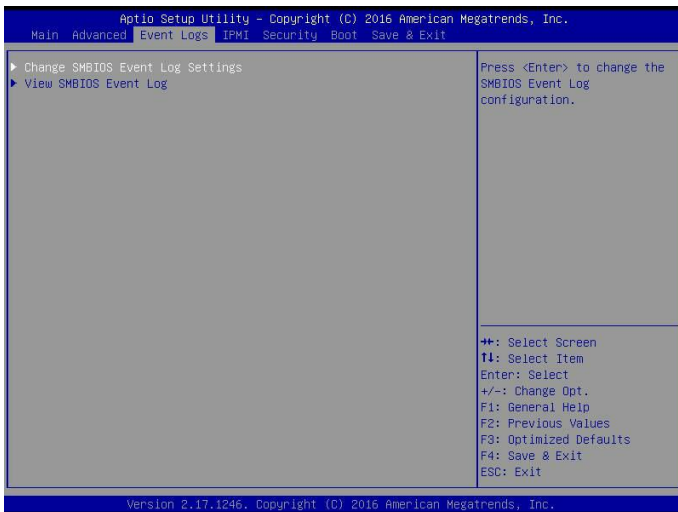

► Change SMBIOS Event Log Settings

Enabling/Disabling Options

SMBIOS Event Log

Change this item to enable or disable all features of the SMBIOS Event Logging during system boot. The options are **Enabled** and **Disabled**.

Runtime Error Logging Support

Select **Enabled** to support Runtime Error Logging. The options are **Enable** and **Disable**. If this item is set to **Enable**, the following item will be available for configuration:

Memory Corrected Error Enabling (Available when the item above - Runtime Error Logging Support is set to Enable)

Select **Enable** for the BIOS to correct a memory error if it is correctable. The options are **Disable** and **Enable**.

Memory Corr. Error Threshold

Use this item to enter the threshold value for correctable memory errors. The default setting is **10**.

PCI-Ex (PCI-Express) Error Enable

Select Yes for the BIOS to correct errors occurred in the PCI-E slots. The options are Yes and **No**.

Erasing Settings

Erase Event Log

If No is selected, data stored in the event log will not be erased. Select Yes, Next Reset, data in the event log will be erased upon next system reboot. Select Yes, Every Reset, data in the event log will be erased upon every system reboot. The options are **No**, Yes, Next reset, and Yes, Every reset.

When Log is Full

Select Erase Immediately for all messages to be automatically erased from the event log when the event log memory is full. The options are **Do Nothing** and Erase Immediately.

SMBIOS Event Long Standard Settings

Log System Boot Event

This option toggles the System Boot Event logging to enabled or disabled. The options are **Disabled** and Enabled.

MECI

The Multiple Event Count Increment (MECI) counter counts the number of occurrences that a duplicate event must happen before the MECI counter is incremented. This is a numeric value. The default value is **1**.

METW

The Multiple Event Time Window (METW) defines number of minutes must pass between duplicate log events before MECI is incremented. This is in minutes, from 0 to 99. The default value is **60**.

Note: After making changes on a setting, be sure to reboot the system for the changes to take effect.

►View SMBIOS Event Log

This section displays the contents of the SMBIOS Event Log.

7-5 IPMI

Use this feature to configure Intelligent Platform Management Interface (IPMI) settings.

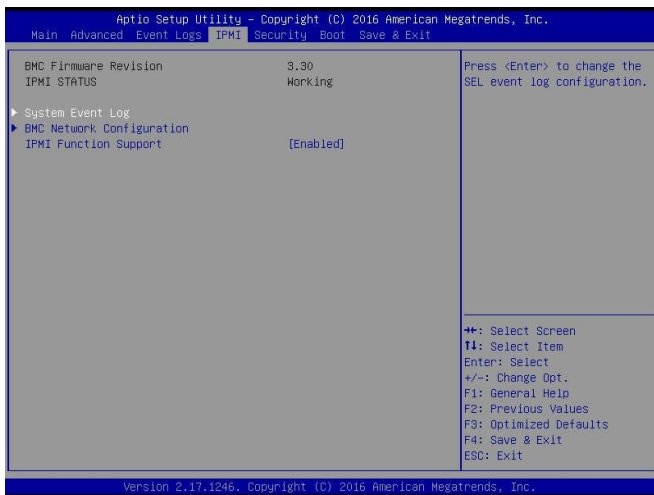

BMC Firmware Revision

This item indicates the IPMI firmware revision used in your system.

IPMI STATUS (Baseboard Management Controller)

This item indicates the status of the IPMI firmware installed in your system.

▶ System Event Log

Enabling/Disabling Options

SEL Components

Select Enabled for all system event logging at bootup. The options are **Enabled** and Disabled.

Erasing Settings

Erase SEL

Select Yes, On next reset to erase all system event logs upon next system reboot.
 Select Yes, On every reset to erase all system event logs upon each system reboot.
 Select No to keep all system event logs after each system reboot. The options are **No**, Yes, On next reset, and Yes, On every reset.

When SEL is Full

This feature allows the user to decide what the BIOS should do when the system event log is full. Select Erase Immediately to erase all events in the log when the system event log is full. The options are **Do Nothing** and Erase Immediately.

Note: After making changes on a setting, be sure to reboot the system for the changes to take effect.

►BMC Network Configuration

BMC Network Configuration

IPMI LAN Selection

This item displays the IPMI LAN setting. The default setting is **Failover**.

IPMI Network Link Status

This item displays the IPMI Network Link status. The default setting is **Shared LAN**.

Update IPMI LAN Configuration

Select Yes for the BIOS to implement all IP/MAC address changes at the next system boot. The options are **No** and Yes

Configuration Address Source (Available for configuration if "Update IPMI LAN Configuration" is set to Yes)

This feature allows the user to select the source of the IP address for this computer. If Static is selected, you will need to know the IP address of this computer and enter it to the system manually in the field. If DHCP is selected, the BIOS will search for a DHCP (Dynamic Host Configuration Protocol) server in the network that is attached to and request the next available IP address for this computer. The options are **DHCP** and Static. The following items are assigned IP addresses automatically if DHCP is selected.

Station IP Address

This item displays the Station IP address for this computer. This should be in decimal and in dotted quad form (i.e., 192.168.10.253).

Subnet Mask

This item displays the sub-network that this computer belongs to. The value of each three-digit number separated by dots should not exceed 255.

Station MAC Address

This item displays the Station MAC address for this computer. Mac addresses are 6 two-digit hexadecimal numbers.

Gateway IP Address

This item displays the Gateway IP address for this computer. This should be in decimal and in dotted quad form (i.e., 172.31.0.1).

VLAN (Available for configuration if "Update IPMI LAN Configuration" is set to Yes)

Use this feature to enable or disable the IPMI VLAN function. The options are **Disable** and **Enable**.

IPMI Function Support

Use this feature to enable IPMI support. The options are **Enabled** and **Disabled**. When **Disabled**, the system powers on quickly by removing BIOS support for extended IPMI features. The **Disable** option is for applications that require faster power on time without using Supermicro Update Manager (SUM) or extended IPMI features. The BMC network configuration in the BIOS setup is also invalid when IPMI Function Support is disabled. The general BMC function and motherboard health monitor such as fan control are still functioning even when this option is disabled.

7-6 Security Settings

This menu allows the user to configure the following security settings for the system.

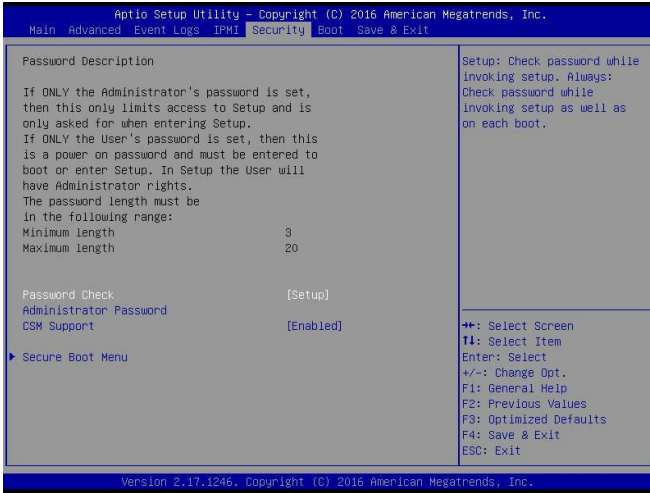

Password Check

Select Setup for the system to check for a password at Setup. Select Always for the system to check for a password at bootup or upon entering the BIOS Setup utility. The options are **Setup** and Always.

Administrator Password

Press Enter to create a new, or change an existing Administrator password.

CSM Support

Select Enabled to support the EFI Compatibility Support Module (CSM), which provides compatibility support for traditional legacy BIOS for system boot. The options are **Enabled** and Disabled.

► Secure Boot Menu

This section displays the contents of the following secure boot features:

- System Mode
- Secure Boot
- Vendor Keys

Secure Boot

Use this item to enable secure boot. The options are **Disabled** and Enabled.

Secure Boot Mode

Use this item to select the secure boot mode. The options are **Standard** and Custom.

▶Key Management

This submenu allows the user to configure the following Key Management settings.

Factory Default Key Provision

Select Enabled to install the default Secure-Boot keys set by the manufacturer. The options are **Disabled** and Enabled.

▶Enroll All Factory Default Keys

Select Yes to install all default secure keys set by the manufacturer. The options are **Yes** and No.

Save All Secure Boot Variables

This feature allows the user to decide if all secure boot variables should be saved.

▶Platform Key (PK)

This feature allows the user to configure the settings of the platform keys.

Set New Key

Select Yes to load the new platform keys (PK) from the manufacturer's defaults. Select No to load the platform keys from a file. The options are **Yes** and No.

▶Key Exchange Key (KEK)

Set New Key

Select Yes to load the KEK from the manufacturer's defaults. Select No to load the KEK from a file. The options are Yes and No.

Append Key

Select Yes to add the KEK from the manufacturer's defaults list to the existing KEK. Select No to load the KEK from a file. The options are Yes and No.

► Authorized Signatures**Set New Key**

Select Yes to load the database from the manufacturer's defaults. Select No to load the DB from a file. The options are Yes and No.

Append Key

Select Yes to add the database from the manufacturer's defaults to the existing DB. Select No to load the DB from a file. The options are Yes and No.

► Forbidden Signatures**Set New Key**

Select Yes to load the DBX from the manufacturer's defaults. Select No to load the DBX from a file. The options are Yes and No.

Append New Key

Select Yes to add the DBX from the manufacturer's defaults to the existing DBX. Select No to load the DBX from a file. The options are Yes and No.

► Authorized TimeStamps**Set New Key**

Select Yes to load the DBT from the manufacturer's defaults. Select No to load the DBT from a file. The options are Yes and No.

Append Key

Select Yes to add the DBT from the manufacturer's defaults list to the existing DBT. Select No to load the DBT from a file. The options are Yes and No.

7-7 Boot Settings

Use this feature to configure Boot Settings:

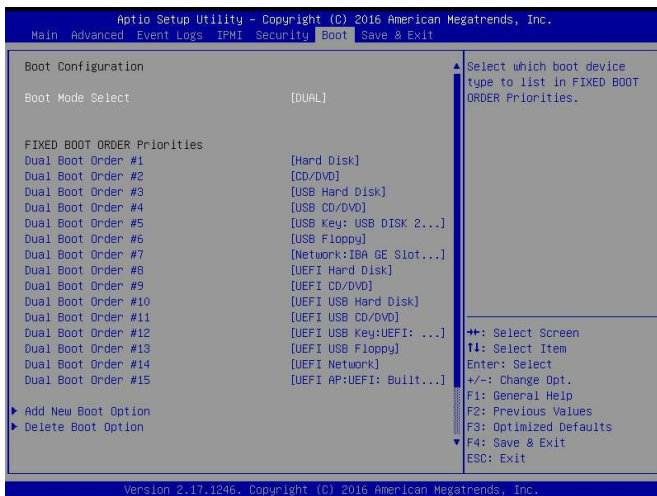

Boot Mode Select

Use this item to select the type of device that the system is going to boot from. The options are Legacy, UEFI, and **Dual**. The default setting is Dual.

Fixed Boot Order Priorities

This option prioritizes the order of bootable devices that the system to boot from. Press <Enter> on each entry from top to bottom to select devices.

- Dual Boot Order #1
- Dual Boot Order #2
- Dual Boot Order #3
- Dual Boot Order #4
- Dual Boot Order #5
- Dual Boot Order #6
- Dual Boot Order #7
- Dual Boot Order #8

- Dual Boot Order #9
- Dual Boot Order #10
- Dual Boot Order #11
- Dual Boot Order #12
- Dual Boot Order #13
- Dual Boot Order #14
- Dual Boot Order #15

▶ **Delete Boot Option**

Use this feature to remove a pre-defined boot device from which the system will boot during startup.

The settings are [any pre-defined boot device].

▶ **NETWORK Drive BBS Priorities**

This feature allows the user to specify which Network devices are boot devices.

- Legacy Boot Order #1
- 2nd Boot Device

▶ **UEFI Application Boot Priorities**

This feature allows the user to specify which UEFI devices are boot devices.

- UEFI Boot Order #1

7-8 Save & Exit

Select the Exit tab from the BIOS setup utility screen to enter the Exit BIOS Setup screen.

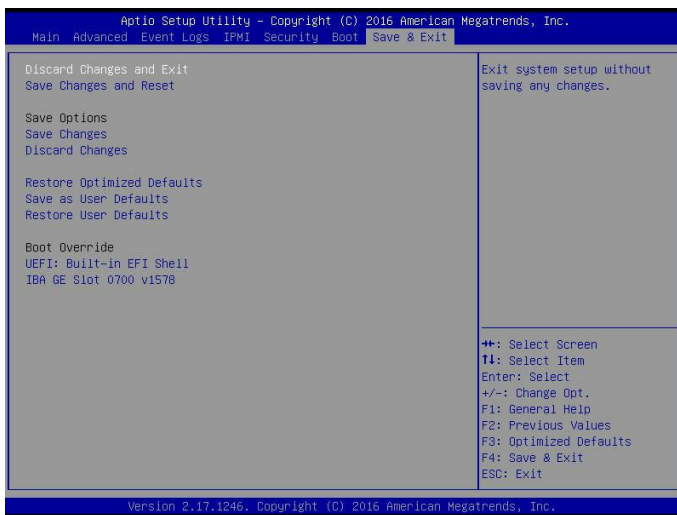

Discard Changes and Exit

Select this option to quit the BIOS Setup without making any permanent changes to the system configuration, and reboot the computer. Select Discard Changes and Exit from the Exit menu and press <Enter>.

Save Changes and Reset

When you have completed the system configuration changes, select this option to leave the BIOS setup utility and reboot the computer, so the new system configuration parameters can take effect. Select Save Changes and Exit from the Exit menu and press <Enter>.

Save Options

Save Changes

After completing the system configuration changes, select this option to save the changes you have made. This will not reset (reboot) the system.

Discard Changes

Select this option and press <Enter> to discard all the changes and return to the AMI BIOS utility Program.

Restore Defaults

To set this feature, select Restore Defaults from the Save & Exit menu and press <Enter>. These are factory settings designed for maximum system stability, but not for maximum performance.

Save As User Defaults

To set this feature, select Save as User Defaults from the Exit menu and press <Enter>. This enables the user to save any changes to the BIOS setup for future use.

Restore User Defaults

To set this feature, select Restore User Defaults from the Exit menu and press <Enter>. Use this feature to retrieve user-defined settings that were saved previously.

Boot Override

Listed on this section are other boot options for the system (i.e., Built-in EFI shell). Select an option and press <Enter>. Your system will boot to the selected boot option.

Notes

Appendix A

BIOS Error Beep Codes

During the POST (Power-On Self-Test) routines, which are performed upon each system boot, errors may occur.

Non-fatal errors are those which, in most cases, allow the system to continue to boot. These error messages normally appear on the screen.

Fatal errors will not allow the system to continue with bootup. If a fatal error occurs, you should consult with your system manufacturer for possible repairs.

These fatal errors are usually communicated through a series of audible beeps. The numbers on the fatal error list correspond to the number of beeps for the corresponding error.

Note: A PC buzzer must be connected to JD1 to hear the BIOS Error Beep Codes.

BIOS Error Beep Codes		
Beep Code/LED	Error Message	Description
1 beep	Refresh	Circuits have been reset. (Ready to power up)
5 short beeps + 1 long beep	Memory error	No memory detected in the system
8 beeps	Display memory read/write error	Video adapter missing or with faulty memory
OH LED On	System OH	System Overheat

Notes

Appendix B

System Specifications

Processor

Single Intel® Xeon/Pentium® D-1537 SoC embedded processor (SoC = System on a Chip)

BIOS

128 Mb AMI® SPI Flash EEPROM

Memory Capacity

Four SO-DIMM slots that can support up to 128 GB of ECC RDIMM (Registered DIMM) or 64 GB of ECC/non-ECC UDIMM (Unregistered DIMM) DDR4-1866/1600 memory

Note: see Section 5-5 for details.

Hard Drives

Four 3.5" hot-swappable SAS or SATA hard drives

Motherboard

X10SDV-7TP4F (Flex ATX form factor)

Dimensions: 9 x 7.25 in (229 x 184 mm)

Chassis

SC813MFTQC-R407CB (1U rackmount)

Dimensions: (WxHxD) 17.2 x 1.7 x 19.8 in. (437 x 43 x 503 mm)

Net Weight

31 lbs. (14.1 kg.)

System Input Requirements

AC Input Voltage: 100 - 240V AC auto-range

Rated Input Current: 6A (100V) to 3A (240V)

Rated Input Frequency: 50 to 60 Hz

Power Supply

Rated Output Power: 400W (Part# PWS-407P-1R)

Rated Output Voltages: +5V (25A), +3.3V (25A), +12V (33A), +5Vsb (3A), -12V (0.6A)

Operating Environment

Operating Temperature: 10° to 40° C (32° to 104° F)

Non-operating Temperature: -40° to 70° C (-40° to 158° F)

Operating Relative Humidity: 8% to 90% (non-condensing)

Non-operating Relative Humidity: 5% to 95% (non-condensing)

Regulatory Compliance

Electromagnetic Emissions: FCC Class A, EN 55032 Class A, EN 61000-3-2/-3-3, CISPR 22 Class A

Electromagnetic Immunity: EN 55024/CISPR 24, (EN 61000-4-2, EN 61000-4-3, EN 61000-4-4, EN 61000-4-5, EN 61000-4-6, EN 61000-4-8, EN 61000-4-11)

Safety: CSA/EN/IEC/UL 60950-1 Compliant, UL or CSA Listed (USA and Canada), CE Marking (Europe)

California Best Management Practices Regulations for Perchlorate Materials:
This Perchlorate warning applies only to products containing CR (Manganese Dioxide) Lithium coin cells. "Perchlorate Material-special handling may apply. See www.dtsc.ca.gov/hazardouswaste/perchlorate"

Notes

(continued from front)

The products sold by Supermicro are not intended for and will not be used in life support systems, medical equipment, nuclear facilities or systems, aircraft, aircraft devices, aircraft/emergency communication devices or other critical systems whose failure to perform be reasonably expected to result in significant injury or loss of life or catastrophic property damage. Accordingly, Supermicro disclaims any and all liability, and should buyer use or sell such products for use in such ultra-hazardous applications, it does so entirely at its own risk. Furthermore, buyer agrees to fully indemnify, defend and hold Supermicro harmless for and against any and all claims, demands, actions, litigation, and proceedings of any kind arising out of or related to such ultra-hazardous use or sale.

Appendix C

UEFI BIOS Recovery Instructions

Warning: Do not upgrade the BIOS unless your system has a BIOS-related issue. Flashing the wrong BIOS can cause irreparable damage to the system. In no event shall Supermicro be liable for direct, indirect, special, incidental, or consequential damages arising from a BIOS update. If you need to update the BIOS, do not shut down or reset the system while the BIOS is updating to avoid possible boot failure.

C-1 Overview to UEFI BIOS

The Unified Extensible Firmware Interface (UEFI) specification provides a software-based interface between the operating system and the platform firmware in the pre-boot environment. The UEFI specification supports an architecture-independent mechanism for add-on card initialization to allow the UEFI OS loader, which is stored in the add-on card, to boot up the system. UEFI offers a clean, hands-off control to a computer system at bootup.

C-2 Recovering the UEFI BIOS Image (Main BIOS Block)

A UEFI BIOS flash chip consists of a recovery BIOS block, which is comprised of two boot blocks and a main BIOS block (the main BIOS image). The boot block contains critical BIOS codes including memory detection and recovery codes for the user to flash a new BIOS image if the original main BIOS image is corrupted. When the system power is on, the boot block codes execute first. Then the main BIOS code will continue with system initialization and bootup.

Note: Follow the BIOS recovery instructions below when the main BIOS boot crashes.

C-3 Recovering the UEFI BIOS with a USB Device

This feature allows the user to recover a BIOS image using a USB device without the need of additional utilities. A device such as a USB flash drive or a USB CD/DVD ROM/RW can be used. A USB hard disk drive cannot be used for BIOS recovery at this time.

To perform UEFI BIOS recovery using an attached device, follow the instructions below.

1. Using a different system, copy the "Super.ROM" binary image file into the disc Root "\\" directory of a USB device or a writeable CD/DVD.

Note: If you cannot locate the "Super.ROM" file in your driver disk, visit our website at www.supermicro.com to download the BIOS image to a USB flash device and rename it "Super ROM".

2. Insert the USB device that contains the new BIOS image ("Super.ROM") into your USB drive and power on the system
3. While powering on the system, keep pressing <Ctrl> and <Home> simultaneously on your keyboard until you hear two short beeps. This may take from a few seconds to one minute.
4. After locating the new BIOS binary image, the system will enter the BIOS recovery menu as shown below.

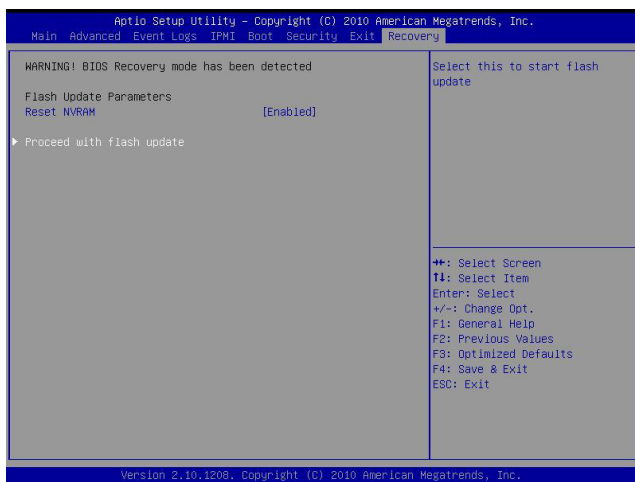

Note: At this point, you may decide if you want to start with BIOS Recovery. If you decide to proceed with BIOS Recovery, follow the procedures below.

5. When the screen shown above displays, use the arrow keys to select the item "Proceed with flash update" and press the <Enter> key. You will see the BIOS recovery progress as shown in the screen below.

Note: *Do not interrupt* the BIOS flashing until it has completed.

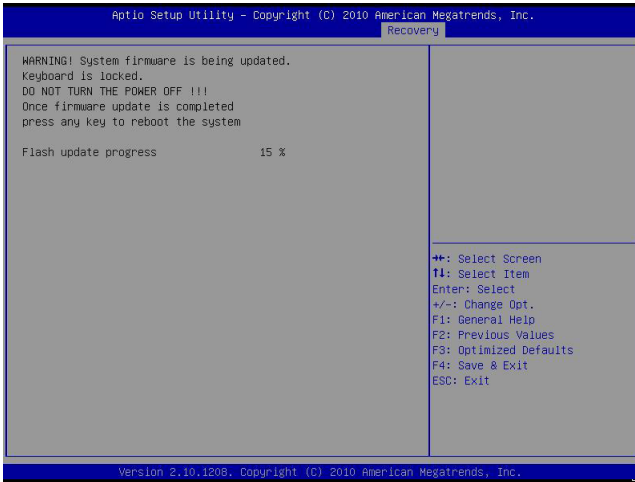

6. After the process has completed, press any key to reboot the system.

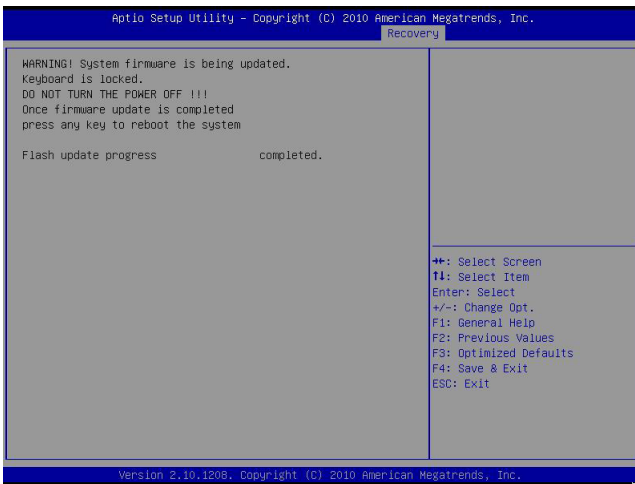

7. Using a different system, extract the BIOS package into a bootable USB flash drive.
8. When the DOS prompt appears, enter AMI.BAT BIOSname.###.

Note: Do not interrupt this process until BIOS flashing has completed.

9. After receiving the message that the BIOS update is complete, unplug the AC power cable from the power supply to clear CMOS, then plug the AC power cable in the power supply again to power on the system.
10. Press continuously to enter the BIOS Setup utility.
11. Press <F3> to load the default settings.
12. After loading the default settings, press <F4> to save the settings and exit the BIOS Setup utility.