

ViewSonic®



EP5540/EP5540T Multimedia Digital Poster User Guide

IMPORTANT: Please read this User Guide to obtain important information on installing and using your product in a safe manner, as well as registering your product for future service. Warranty information contained in this User Guide will describe your limited coverage from ViewSonic Corporation, which is also found on our web site at <http://www.viewsonic.com> in English, or in specific languages using the Regional selection box in the upper right corner of our website. "Antes de operar su equipo lea cuidadosamente las instrucciones en este manual"

Model No.: VS17520

Thank you for choosing ViewSonic

As a world leading provider of visual solutions, ViewSonic is dedicated to exceeding the world's expectations for technological evolution, innovation, and simplicity. At ViewSonic, we believe that our products have the potential to make a positive impact in the world, and we are confident that the ViewSonic product you have chosen will serve you well.

Once again, thank you for choosing ViewSonic !



Compliance Information

NOTE: This section addresses all connected requirements and statements regarding regulations. Confirmed corresponding applications shall refer to nameplate labels and relevant markings on unit.

FCC Statement

This device complies with Part 15 of the FCC Rules. Operation is subject to the following two conditions: (1) this device may not cause harmful interference, and (2) this device must accept any interference received, including interference that may cause undesired operation.

NOTE: This equipment has been tested and found to comply with the limits for a Class A/ Class B digital device, pursuant to Part 15 of the FCC Rules. These limits are designed to provide reasonable protection against harmful interference when the equipment is operated in a commercial environment. This equipment generates, uses, and can radiate radio frequency energy and, if not installed and used in accordance with the instructions, may cause harmful interference to radio communications. Operation of this equipment in a residential area is likely to cause harmful interference in which case the user will be required to correct the interference at his/her own expense.

- Reorient or relocate the receiving antenna.
- Increase the separation between the equipment and receiver.
- Connect the equipment into an outlet on a circuit different from that to which the receiver is connected.
- Consult the dealer or an experienced radio/TV technician for help.

Warning: To comply with the limits for the Class A/Class B digital device, pursuant to Part 15 of the FCC Rules, this device must be installed in computer equipment certified to comply with the Class A/Class B limits. All cables used to connect the computer and peripherals must be shielded and grounded. Operation with non-certified computers or non-shielded cables may result in interference to radio or television reception. Changes and modifications not expressly approved by the manufacturer could void the user's authority to operate this equipment.

For Canada

CAN ICES-3 (A/B)/NMB-3(A/B)

CE Conformity for European Countries

 The device complies with the EMC Directive 2014/30/EU and Low Voltage Directive 2014/35/EU.

Following information is only for EU-member states:

The mark shown to the right is in compliance with the Waste Electrical and Electronic Equipment Directive 2012/19/EU (WEEE).

The mark indicates the requirement NOT to dispose of the equipment as unsorted municipal waste, but use the return and collection systems according to local law.

If the batteries, accumulators and button cells included with this equipment, display the chemical symbol Hg, Cd, or Pb, then it means that the battery has a heavy metal content of more than 0.0005% Mercury or more than, 0.002% Cadmium, or more than 0.004% Lead.



Industry Canada Notice

This device complies with Canadian RSS-210. To prevent radio interference to the licensed service, this device is intended to be operated indoors and away from windows to provide maximum shielding. Equipment (or its transmitting antenna) that is installed outdoors is subject to licensing. The installer of this radio equipment must ensure that the antenna is located or pointed such that it does not emit RF field in excess of Health Canada limits for the general population; consult Safety Code 6, obtainable from Health Canada's website www.hc-sc.gc.ca/rpb.

R&TTE Compliance Statement

This device complies with the Essential Requirements of the R&TTE Directive of the European Union (1999/5/EC). This equipment meets the following conformance standards:

ETSI EN 300 328

EN 301 489-01

EN 301 489-17

EN 62311

Notified Countries: Germany, UK, Netherlands, Belgium, Sweden, Denmark, Finland, France, Italy, Spain, Austria, Ireland, Portugal, Greece, Luxembourg, Estonia, Latvia, Lithuania, Czech Republic, Slovakia, Slovenia, Hungary, Poland and Malta.

Declaration of RoHS2 Compliance

This product has been designed and manufactured in compliance with Directive 2011/65/EU of the European Parliament and the Council on restriction of the use of certain hazardous substances in electrical and electronic equipment (RoHS2 Directive) and is deemed to comply with the maximum concentration values issued by the European Technical Adaptation Committee (TAC) as shown below:

Substance	Proposed Maximum Concentration	Actual Concentration
Lead (Pb)	0.1%	< 0.1%
Mercury (Hg)	0.1%	< 0.1%
Cadmium (Cd)	0.01%	< 0.01%
Hexavalent Chromium (Cr ⁶⁺)	0.1%	< 0.1%
Polybrominated biphenyls (PBB)	0.1%	< 0.1%
Polybrominated diphenyl ethers (PBDE)	0.1%	< 0.1%
Bis (2-ethylhexyl) phthalate (DEHP)	0.1%	< 0.1%
Butyl benzyl phthalate (BBP)	0.1%	< 0.1%
Dibutyl phthalate (DBP)	0.1%	< 0.1%
Diisobutyl phthalate (DIBP)	0.1%	< 0.1%

Certain components of products as stated above are exempted under the Annex III of the RoHS2 Directives as noted below:

Examples of exempted components are:

1. Mercury in cold cathode fluorescent lamps and external electrode fluorescent lamps (CCFL and EEFL) for special purposes not exceeding (per lamp):
 - (1) Short length (≤ 500 mm): maximum 3.5 mg per lamp.
 - (2) Medium length (> 500 mm and $\leq 1,500$ mm): maximum 5 mg per lamp.
 - (3) Long length ($> 1,500$ mm): maximum 13 mg per lamp.
2. Lead in glass of cathode ray tubes.
3. Lead in glass of fluorescent tubes not exceeding 0.2% by weight.
4. Lead as an alloying element in aluminium containing up to 0.4% lead by weight.
5. Copper alloy containing up to 4% lead by weight.
6. Lead in high melting temperature type solders (i.e. lead-based alloys containing 85% by weight or more lead).
7. Electrical and electronic components containing lead in a glass or ceramic other than dielectric ceramic in capacitors, e.g. piezoelectronic devices, or in a glass or ceramic matrix compound.

Safety Precautions

FOR OPTIMUM PERFORMANCE, PLEASE NOTE THE FOLLOWING WHEN SETTING UP AND USING THE LCD COLOR MONITOR:

- DO NOT REMOVE MONITOR BACK COVER. There are no user serviceable parts inside and opening or removing covers may expose you to dangerous shock hazards or other risks. Refer all servicing to qualified service personnel.
- Do not spill any liquids into the cabinet or use your monitor near water.
- Do not insert objects of any kind into the cabinet slots, as they may touch dangerous voltage points, which can be harmful or fatal or may cause electric shock, fire or equipment failure.
- Do not place any heavy objects on the power cord. Damage to the cord may cause shock or fire.
- Do not place this product on a sloping or unstable cart, stand or table, as the monitor may fall, causing serious damage to the monitor.
- Do not place any objects onto the monitor and do not use the monitor outdoors.
- The inside of the fluorescent tube located within the LCD monitor contains mercury. Please follow the laws or rules of your municipality to dispose of the tube properly.
- Do not bend power cord.
- Do not use monitor in high temperature, humid, dusty, or oily areas.
- If monitor or glass is broken, do not come in contact with the liquid crystal and handle with care.
- Allow adequate ventilation around the monitor, so that heat can properly dissipate. Do not block ventilated openings or place the monitor near a radiator or other heat sources. Do not put anything on top of the monitor.
- The power cable connector is the primary means of detaching the system from the power supply. The monitor should be installed close to a power outlet, which is easily accessible.
- Handle with care when transporting. Save packaging for transporting.
- Please clean the holes of back cabinet to reject dirt and dust at least once a year because of set reliability.
- If using the cooling fan continuously, it's recommended to wipe holes a minimum of once a month.
- When installing the remote control batteries;
 - Align the batteries according to the (+) and (-) indications inside the case.
 - Align the (-) indication of the battery first inside the case.

WARNING:

Usage of other than specified head- or earphones can result in hearing loss due to excessive sound pressures.

CAUTION:

Immediately unplug your monitor from the wall outlet and refer servicing to qualified service personnel under the following conditions:

- When the power supply cord or plug is damaged.
- If liquid has been spilled, or objects have fallen into the monitor.
- If the monitor has been exposed to rain or water.
- If the monitor has been dropped or the cabinet damaged.
- If the monitor does not operate normally by following operating instructions.

Recommended Use**CAUTION:**

- For optimum performance, allow 20 minutes for warm-up.
- Rest your eyes periodically by focusing on an object at least 5 feet away. Blink often.
- Position the monitor at a 90° angle to windows and other light sources to minimize glare and reflections.
- Clean the LCD monitor surface with a lint-free, nonabrasive cloth. Avoid using any cleaning solution or glass cleaner!
- Adjust the monitor's brightness, contrast and sharpness controls to enhance readability.
- Avoid displaying fixed patterns on the monitor for long periods of time to avoid image persistence (after image effects).
- Get regular eye checkups.

Ergonomics

To realize the maximum ergonomic benefits, we recommend the following:

- Use the preset Size and Position controls with standard signals.
- Use the preset Color Setting.
- Use non-interlaced signals.
- Do not use primary color blue on a dark background, as it is difficult to see and may produce eye fatigue due to insufficient contrast.

Table Of Contents

1. Getting Started	1
1.1. Package Contents.....	1
1.2. Fastening the poster	1
2. Parts and Functions	4
2.1. Remote Control	4
2.1.1. Installing remote control Batteries	5
2.1.2. Aiming the remote control	5
3. Connections	6
4. Basic Operations	7
4.1. Turn on the display.....	7
4.2. First initiation	7
4.3. Float menu (for touch series only).....	7
4.3.1. Home Menu Overview	8
4.4. Home Menu Overview.....	9
5. File Explorer	10
6. vSignage overview (Content Management)	13
6.1. Dashboard.....	14
6.2. Campaign Manager.....	14
6.2.1. Campaign	15
6.3. Edit Presentation.....	18
6.4. Group Manager	25
6.5. User Scenario	26
7. System Settings	27
7.1. Network Settings	28
7.2. System update	30
8. Menu List	34
9. Using Auto Play	36
10. Using USB multi media player	38
10.1. Insert the USB drive with mutimedia content including photo, movie and music.	38
10.2. Switch the input source to USB mode.....	38
10.3. Playing Photo	39
10.4. Playing Music	40
10.5. Playing Movie.....	41

11. Supported media files format	42
12. Troubleshooting	43
13. Specifications	44
14. Other Information	45
Customer Support.....	45
Limited Warranty	46
Mexico Limited Warranty	48

Copyright Information

Copyright © ViewSonic Corporation, 2018. All rights reserved.

ViewSonic® and the three birds logo are registered trademarks of ViewSonic Corporation.

ENERGY STAR® is a registered trademark of the U.S. Environmental Protection Agency (EPA). As an ENERGY STAR® partner, ViewSonic Corporation has determined that this product meets the ENERGY STAR® guidelines for energy efficiency.

Disclaimer: ViewSonic Corporation shall not be liable for technical or editorial errors or omissions contained herein; nor for incidental or consequential damages resulting from furnishing this material, or the performance or use of this product.

In the interest of continuing product improvement, ViewSonic Corporation reserves the right to change product specifications without notice. Information in this document may change without notice.

No part of this document may be copied, reproduced, or transmitted by any means, for any purpose without prior written permission from ViewSonic Corporation.

Product Registration

To meet your future needs, and to receive any additional product information as it becomes available, please register your product on the Internet at: www.viewsonic.com.

The ViewSonic® Wizard CD-ROM also provides an opportunity for you to print the registration form, which you may mail or fax to ViewSonic.

For Your Records

Product Name:	EP5540_EP5540T ViewSonic Multimedia Digital Poster
Model Number:	VS17520
Document Number:	EP5540_EP5540T_UG_ENG Rev. 1A 06-14-18
Serial Number:	_____
Purchase Date:	_____

Product disposal at end of product life

ViewSonic respects the environment and is committed to working and living green. Thank you for being part of Smarter, Greener Computing.

Please visit ViewSonic website to learn more.

USA & Canada: <http://www.viewsonic.com/company/green/recycle-program/>

Europe: <http://www.viewsoniceurope.com/eu/support/call-desk/>

Taiwan: <https://recycle.epa.gov.tw/>

1. Getting Started

1.1. Package Contents

The following items are included in your product box.

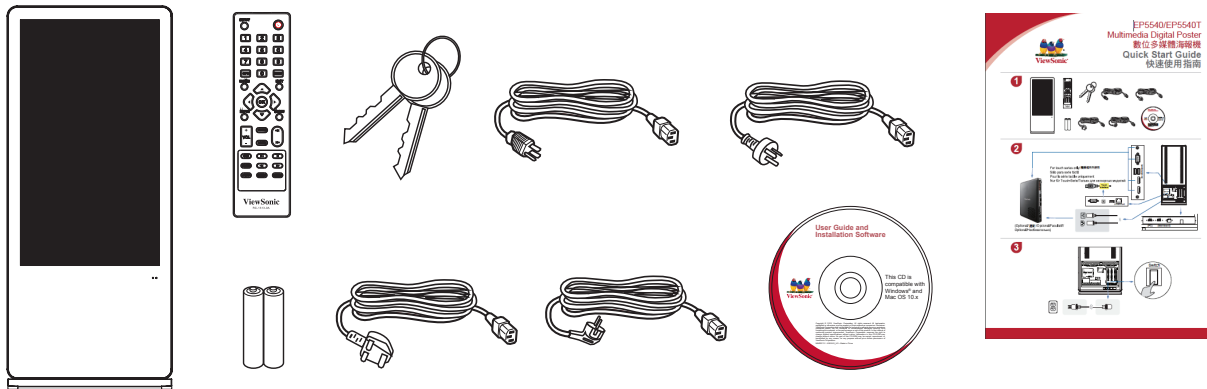

NOTE: The illustrations may differ slightly from the items shipped with your product.

1.2. Fastening the poster

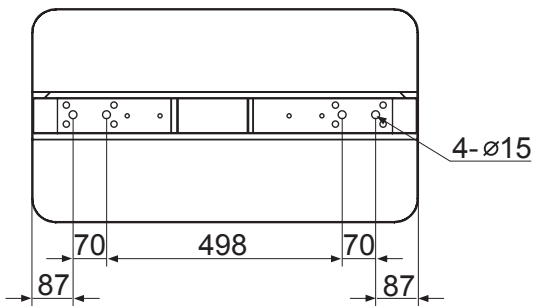

As illustrated in figure, positioning 4 holes on the earth and drill the holes at the corresponding position. The diameter of the hole on the earth should be smaller than the diameter of the screw. Fit the four fastening screws, fastening the poster to earth.

NOTES:

1. The appearance of this product in these illustrations may differ from your actual product, and is for comparative purposes only.
2. We may change the design and specifications without notice.

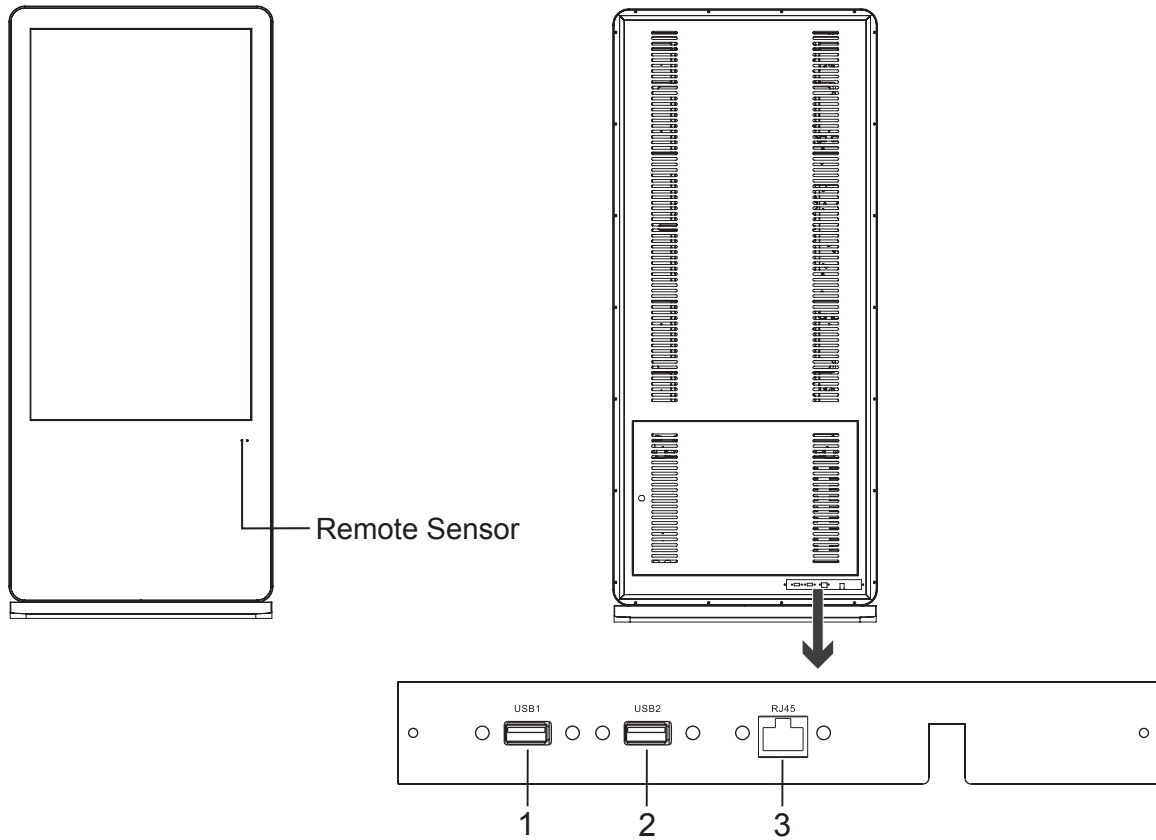

1. USB 1
USB for PC.
2. USB 2
USB for the poster. (Embedded Player)
3. RJ45
Enable connection to cable and log on to Internet.

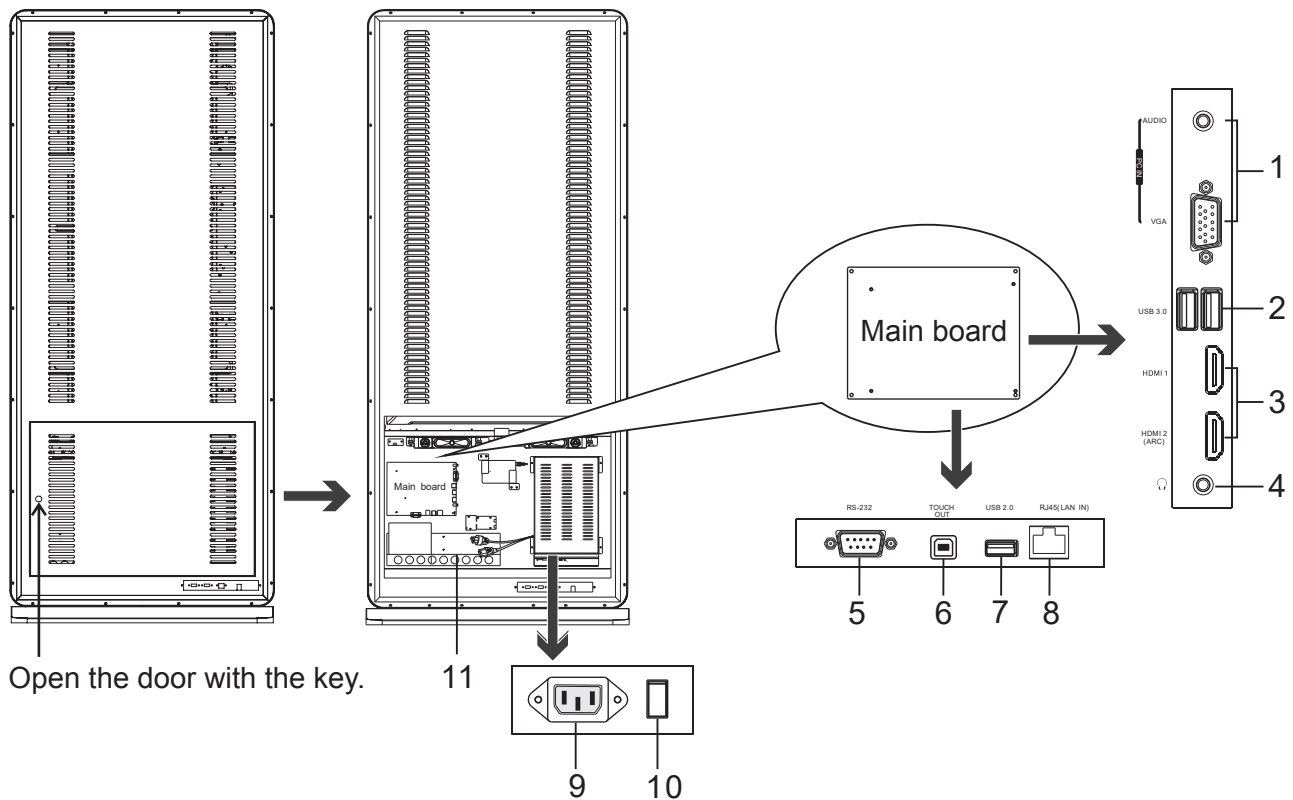

1. PC IN
Enable connection to PC or other external devices with VGA/AUDIO ports.
2. USB 3.0
Connect USB devices to these ports.
3. HDMI1/2 Input
To connect with those equipments with HDMI or DVI interface.
HDMI1: Connect the HDMI cable to the HDMI 1 ports on your display and peripheral device.
HDMI2(ARC): Connect an ARC-enabled home theater receiver to this jack.
4. 
Connect headphones to this jack. The Poster is the current audio output.
5. RS-232
For service, RS232 control and the other uses.
6. TOUCH OUT (for touch series only)
Output the touch for external devices connected to PC or HDMI port which support touch system.
7. USB 2.0
Connect USB devices to this port.
8. RJ45 (LAN IN)
Enable connection to cable and log on to Internet.
9. AC IN
Plug the AC cord into this jack and into a power outlet. (~100-240V 50Hz/60Hz)
10. Power Switch Push to (1) to connect the power, push to (O) to cut off.
11. AC OUT
~100-240V 50Hz/60Hz, Current Max.: 0.65A.

2. Parts and Functions

2.1. Remote Control

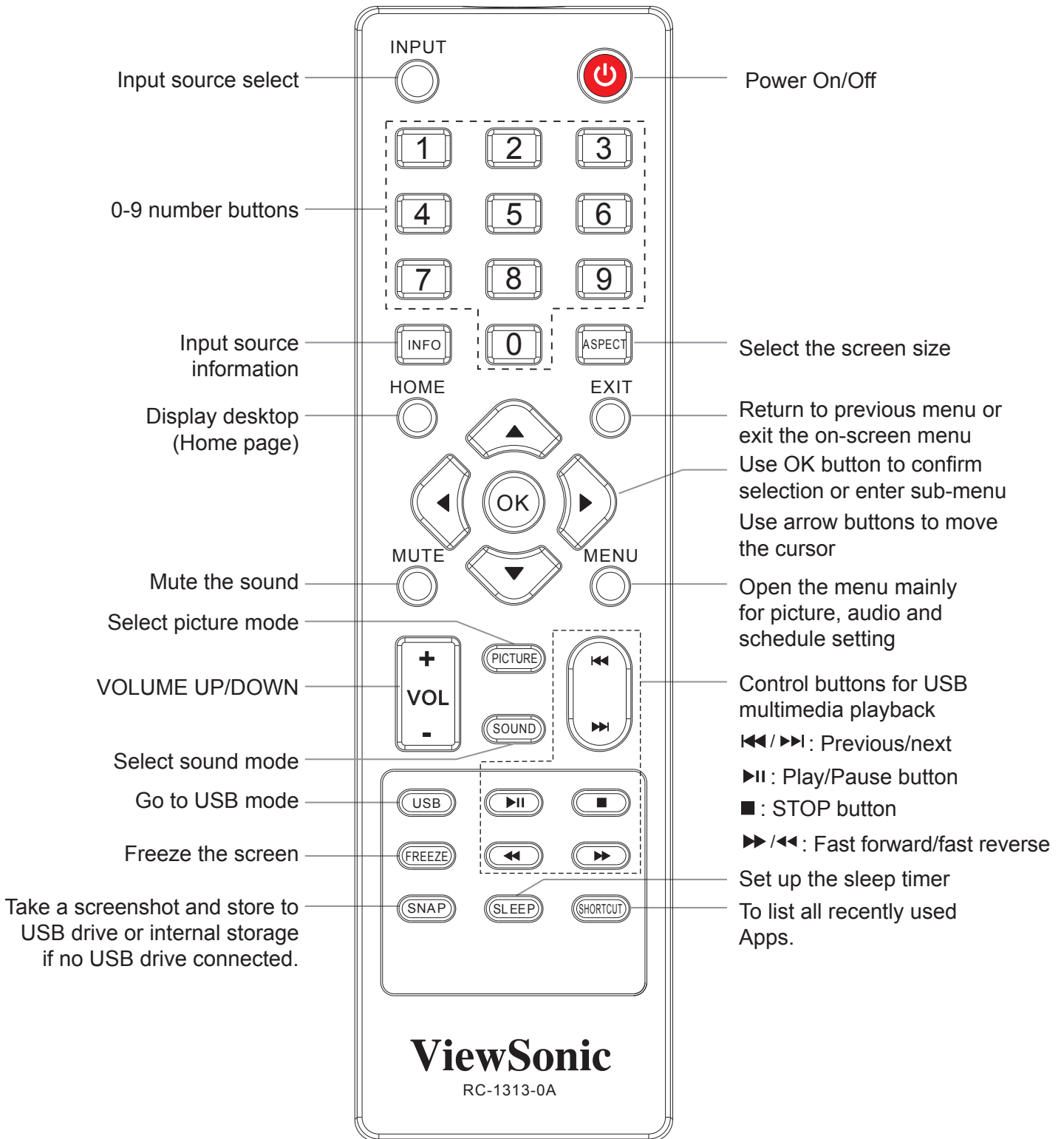

Notes:

- For touch model, some functions could be performed through touch directly instead of remote control.

2.1.1. Installing remote control Batteries

To install remote control batteries:

1. Open the battery cover.
2. Insert two AAA batteries into the battery compartment. Make sure that the + and – symbols on the batteries match the + and – symbols in the battery compartment.
3. Replace the cover.

Battery precautions:

Improper use of batteries can result in a leakage of chemicals and/or explosion. Be sure to follow the instructions below.

- Place batteries with their terminals corresponding to the (+) and (–) indications.
- Different types of batteries have different characteristics. Do not mix batteries of different types.
- Do not mix old and new batteries. Mixing old and new batteries can shorten the life of new batteries and/or cause old batteries to leak chemicals.
- Remove batteries as soon as they are non-operable. Chemicals that leak from batteries can cause a rash. If chemical leakage is found, wipe with a cloth.
- Dispose of batteries in a proper manner.
- If the remote control is not used for an extended period of time, remove the batteries.
- The batteries shall not be exposed to excessive heat such as sunshine, fire or the like.

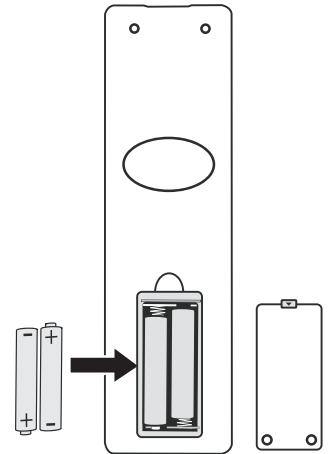

2.1.2. Aiming the remote control

Use the remote control by pointing it towards the remote sensor on the front of your display. Objects between the remote control and the remote sensor may prevent proper operation.

Cautions regarding use of remote control

- Do not expose the remote control to shock. In addition, do not expose the remote control to liquids, and do not place in an area with high humidity.
- Do not install or place the remote control under direct sunlight. The heat may cause deformation of the unit.
- The remote control may not work properly if the remote sensor window of the main unit is under direct sunlight or strong lighting. In such a case, change the angle of the lighting or the display set, or operate the remote control closer to the remote sensor window.

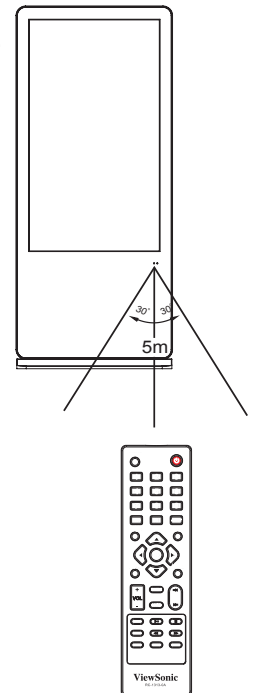

3. Connections

- Turn off the display and connected device.
- Check the plug type at the ends of cables.
- Make sure the fastened connection.

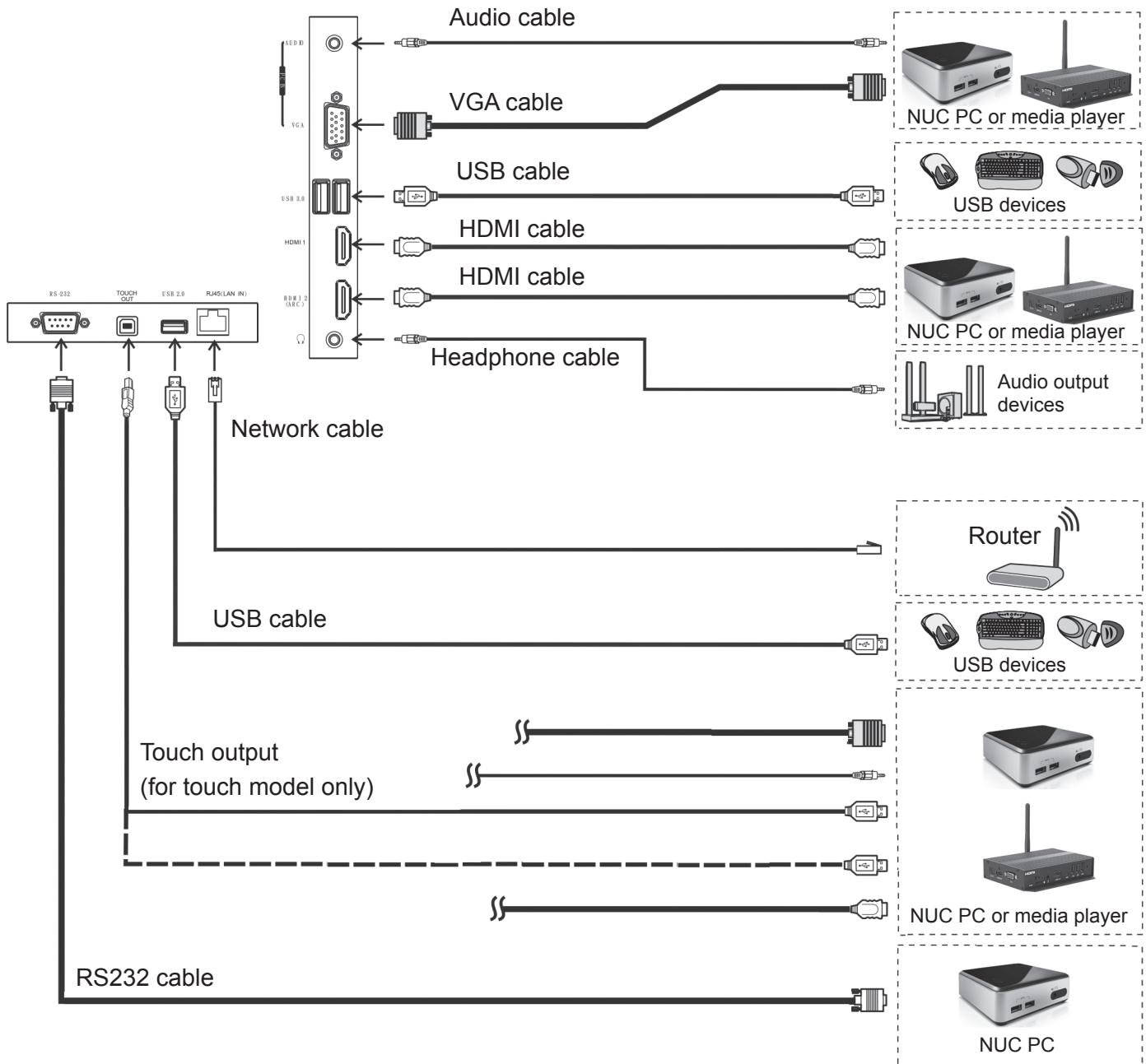

4. Basic Operations

4.1. Turn on the display

Plug AC power cord and turn on the AC **Power Switch**.

NOTE: If not receiving signal for around 5 minutes, display will turn off automatically.

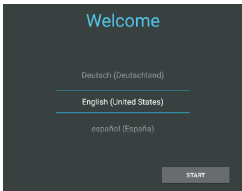

4.2. First initiation

The following installation menu will pop up for first-time power on.



Select desired menu language, then press **START** and turn to next page.





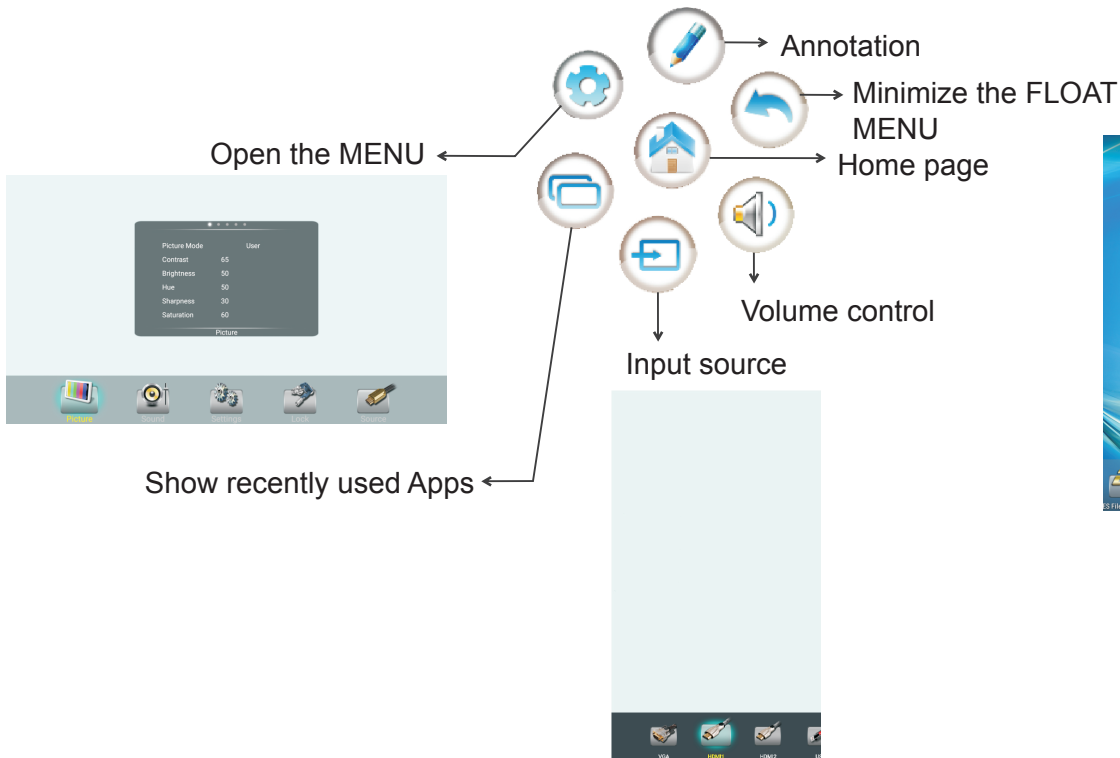

4.3. Float menu (for touch series only)

1. Set the **FLOAT MENU** to on in the Lock menu.
2. Slide up from bottom of the screen center by two or more fingers to call  in **HOME**.
3. Drag  to any place of the screen.
4. Click  to show control icons.



4.3.1. Home Menu Overview

In this mode, user can only use touch pen to operate.

Item		Description
	Annotation menu	Pop up sub-menu.
	Pen	Click to make annotation in the picture. Click to change color.
	Eraser	Click to erase symbols. Click to change eraser size.
	Screen shot	Click to screenshot the current image.
	Clean	Click to clean all the annotation.
	Cancel	Click to cancel previous step operation.
	Close	Click to close annotation menu.

4.4. Home Menu Overview

1. Press **HOME** button to show desktop menu.
2. Use arrow and **OK** button for desired selection.
3. Press **EXIT** button to leave.

The diagram illustrates the Home Menu Overview, which is a vertical menu with a blue background and the ViewSonic logo at the top. At the bottom, there are five application icons: ES File Explorer, Settings, Apps, USB Driver, and Browser. Lines connect these icons to their respective labels: 'File manager' for ES File Explorer, 'Mainly for network, Date & time, and Language setting.' for Settings, 'Installed application list.' for Apps, 'External USB storage' for USB Driver, and 'web Browser' for Browser. To the right, a smaller image shows a desktop environment with a space-themed wallpaper and a sidebar with icons for Home, Pictures, Stop, and Videos. Below the main menu, there are two more images: one showing the Settings application interface with sections for Device, Preferences, and Personal, and another showing the Apps application interface with a grid of installed applications.

5. File Explorer

1. Press ▲▼◀▶ button to select desktop menu option, press **OK** to confirm.
2. Press **EXIT** button to return to previous menu or exit the menu.





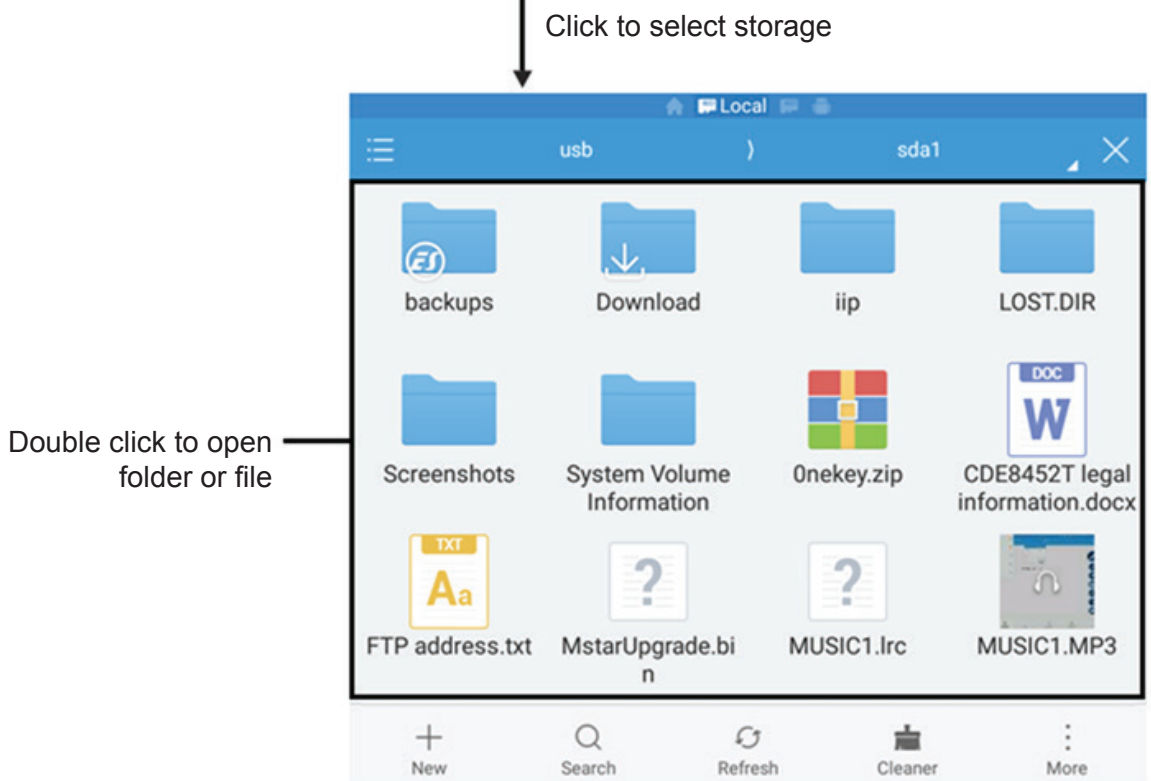
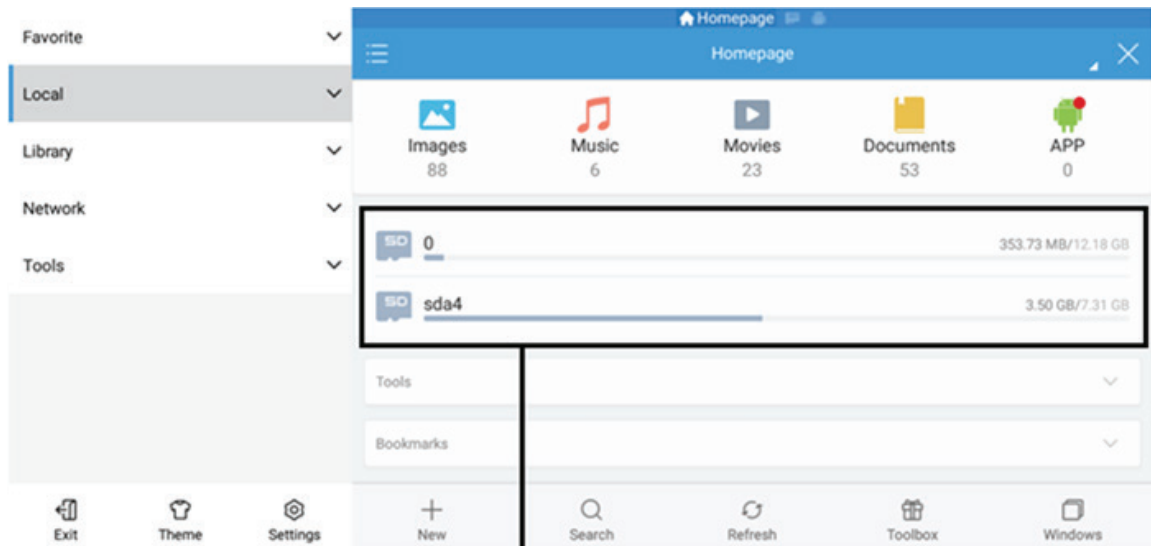



Item		Description
	Exit	Click to exit file manager.
	Theme	Click to change the theme.
	Settings	Click to entry setting menu page.

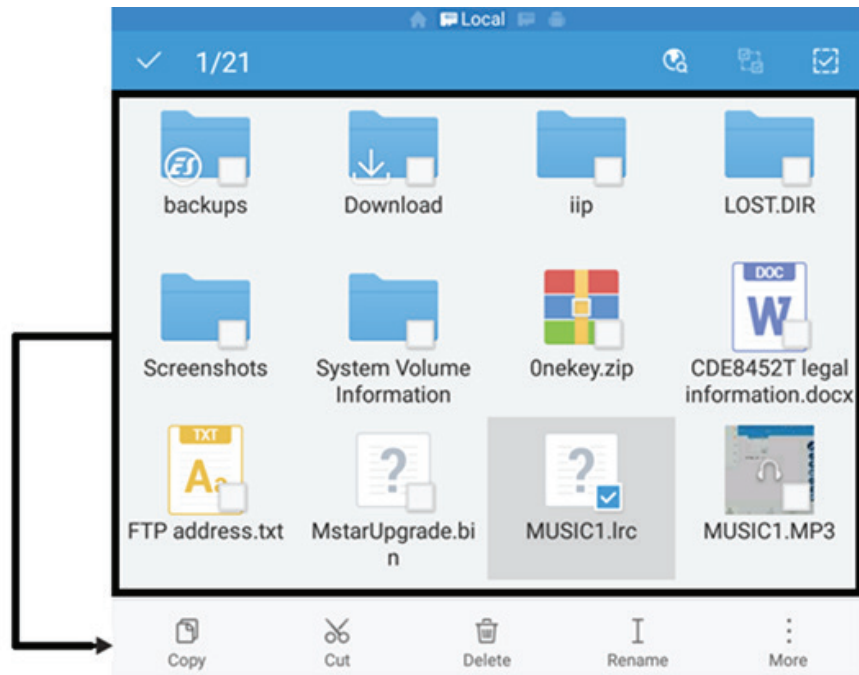

Item	Description	
	New	Click to add file or folder.
	Search	Click to search file or folder.
	Refresh	Click to refresh file status.
	Cleaner	Click to clean not necessary file.
	More	Click to show more functions.

Press and hold to show the file management tool



Item		Description
	Copy	Click to copy file.
	Cut	Click to cut file.
	Delete	Click to delete file.
	Rename	Click to rename file.
	More	Click to show more functions.

6. vSignage overview (Content Management)

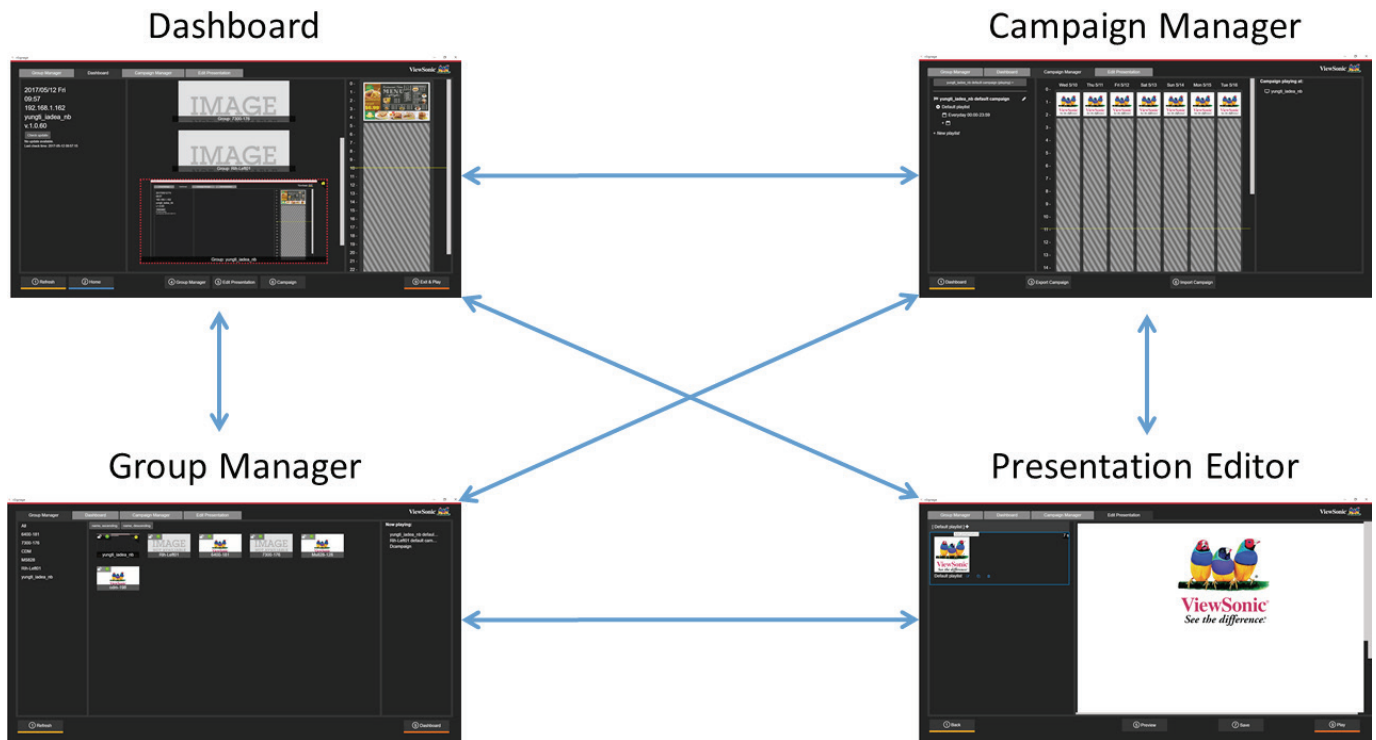

1. **Dashboard**: Information overview.
2. **Campaign Manager**: Edit schedule and manage playlist.
3. **Edit Presentation**: Edit play items
4. **Group Manager**: Group player and player setting.

6.1. Dashboard

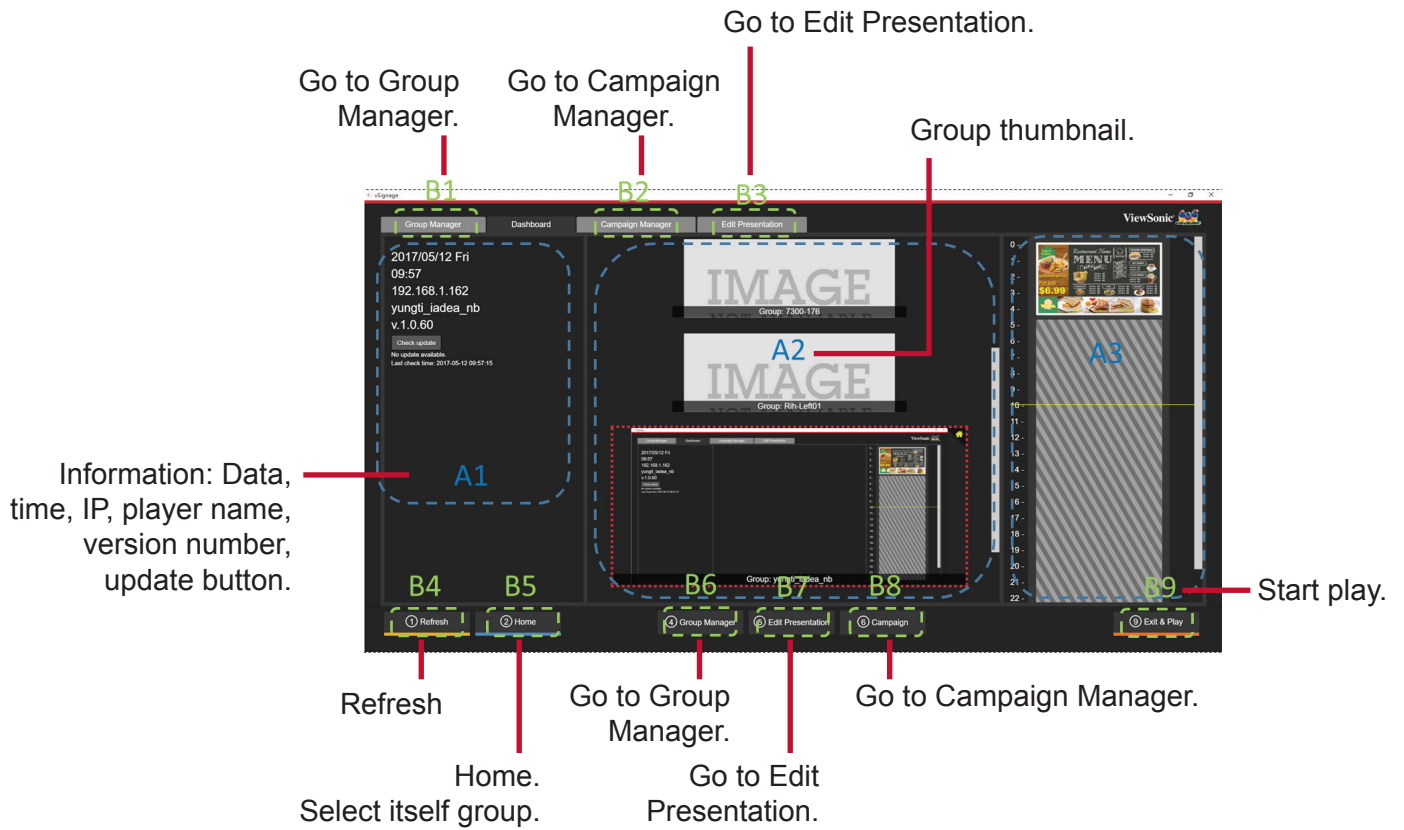

6.2. Campaign Manager

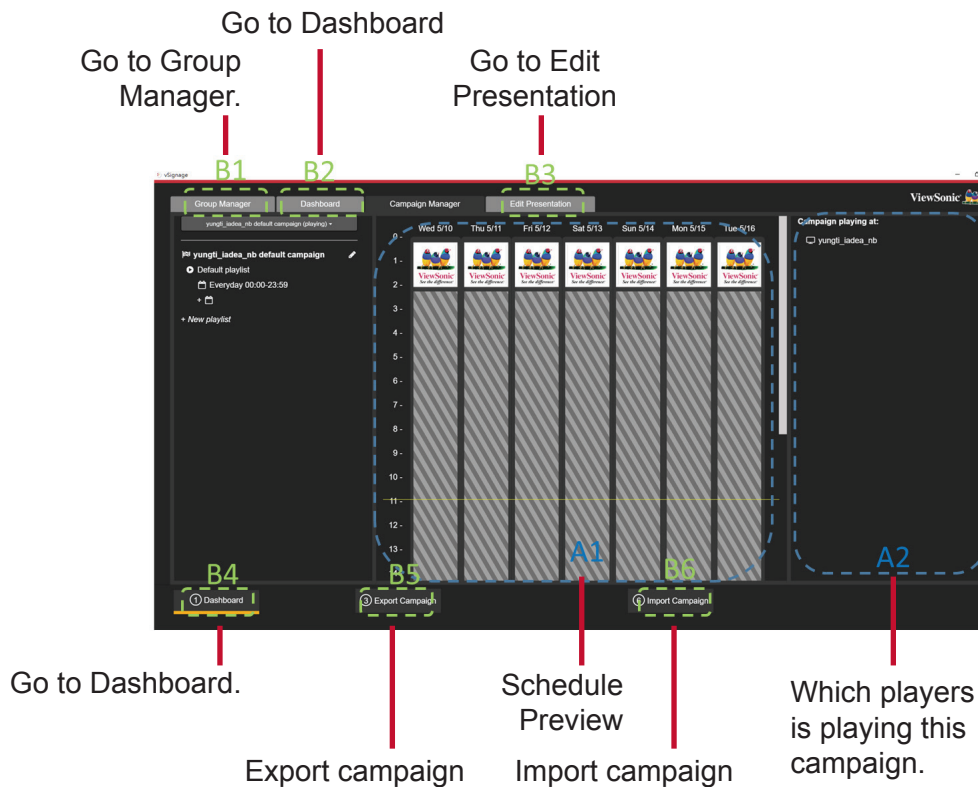

6.2.1. Campaign

Campaign is the whole playlist for player. A campaign contains several playlists. One playlist contains several presentations and could be played at several time slots.

1. Campaign Name: Change campaign name

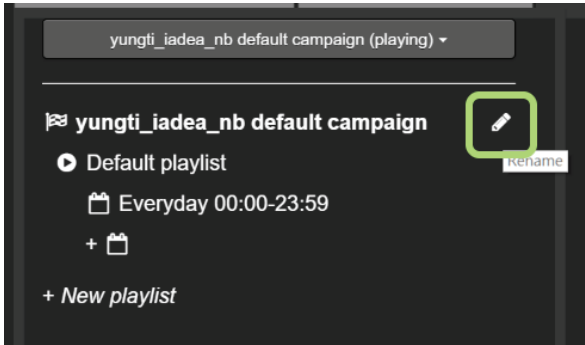

2. Playlist: Edit this playlist, go to Edit Presentation Page.

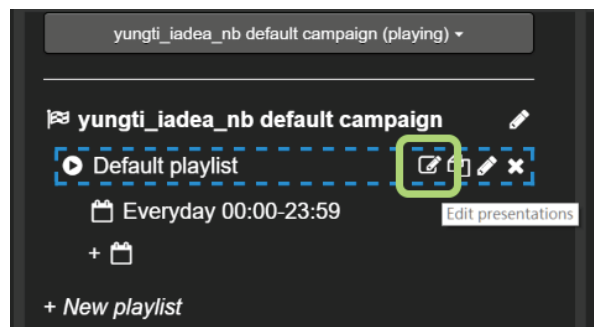

3. Copy: Copy this playlist.

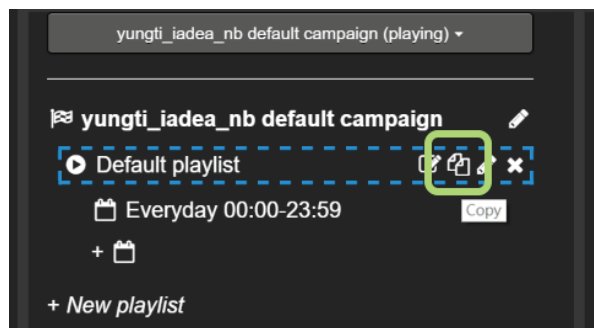

4. **Rename:** Rename this playlist.

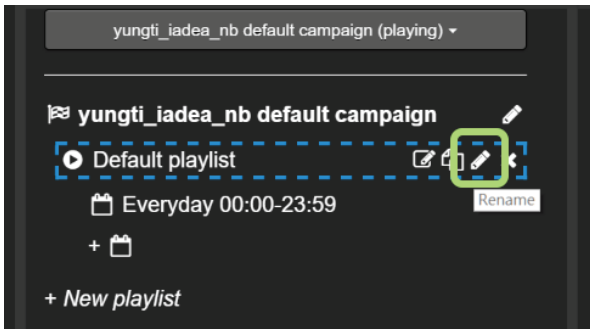

5. **Remove:** Remove this playlist.

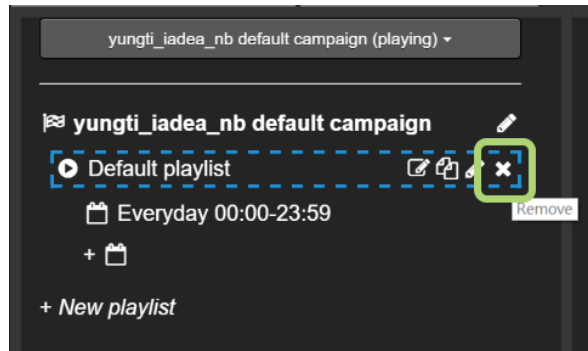

6. **Time slot:** Edit this time slot.

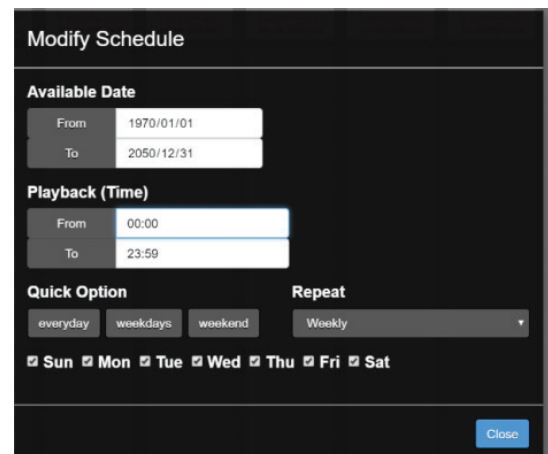
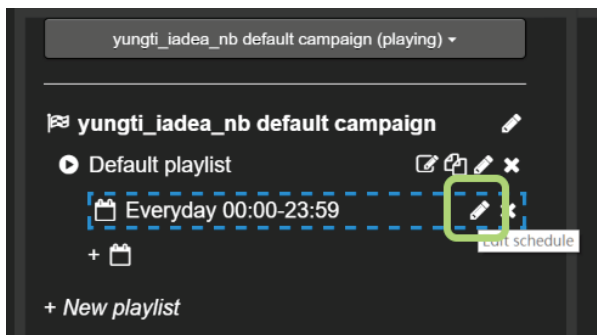

7. **Remove time slot:** Remove this time slot.

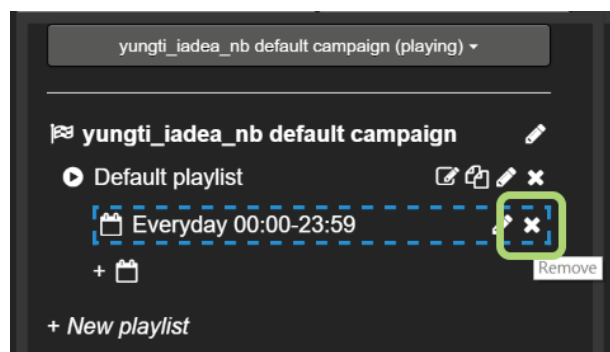

8. **Add time slot:** Add new time slot.

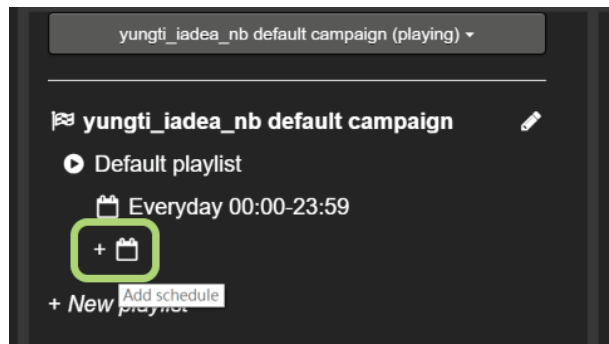

9. **Add new playlist:** Add the other playlist for this campaign.

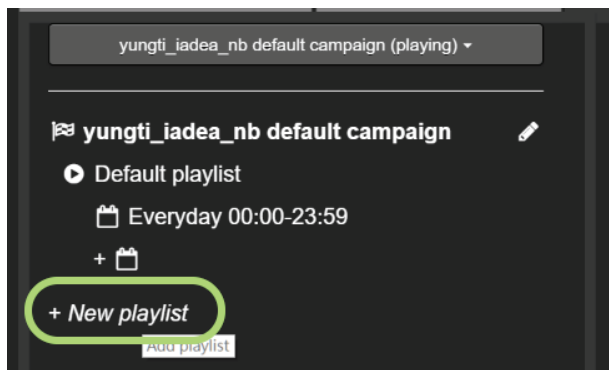

6.3. Edit Presentation

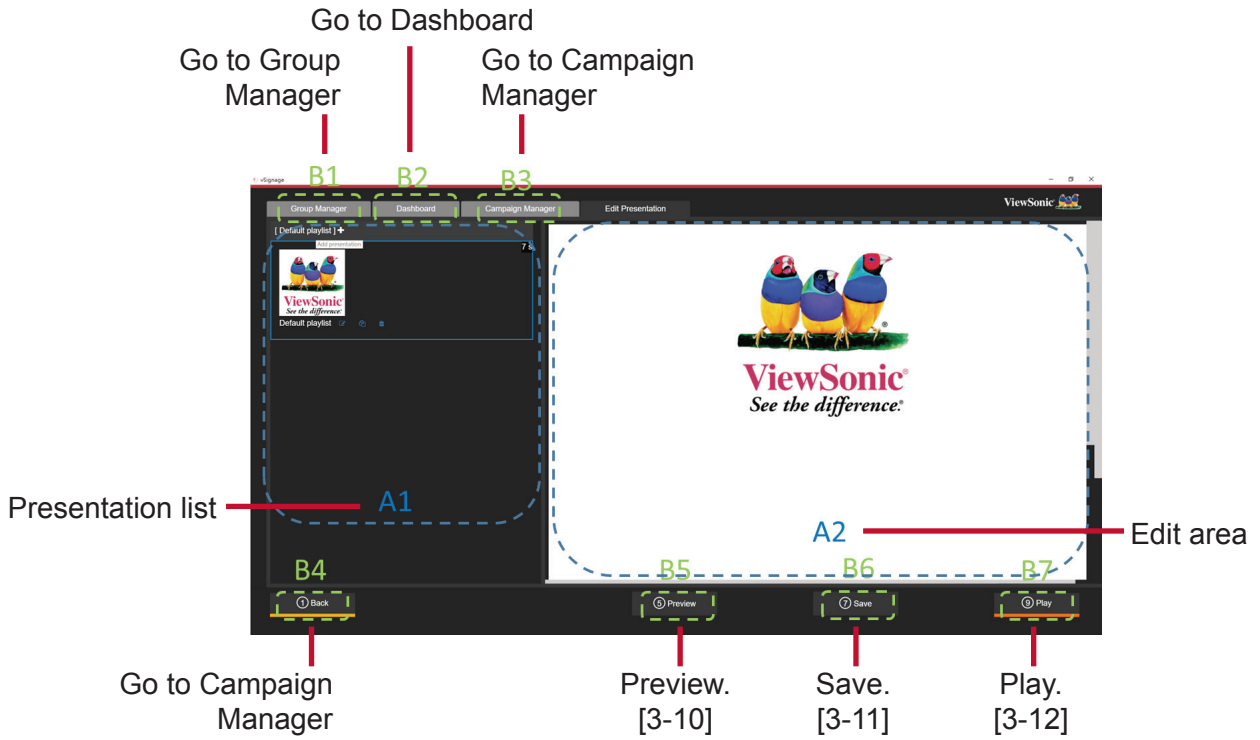

1. **Add presentation:** Add one presentation to this playlist.

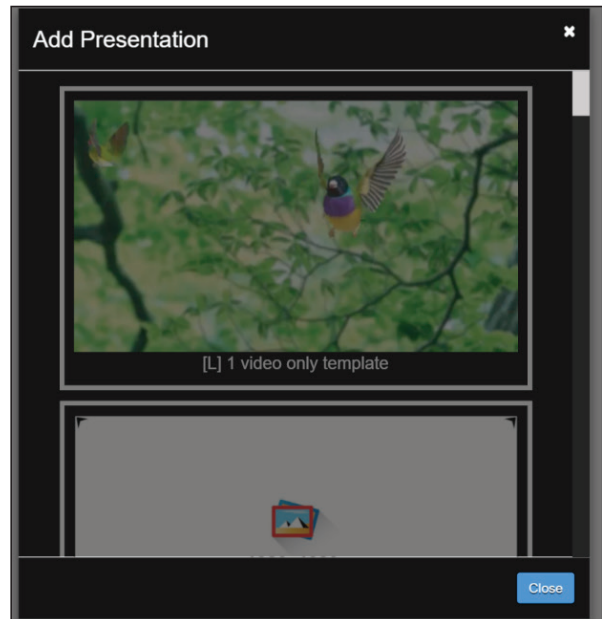
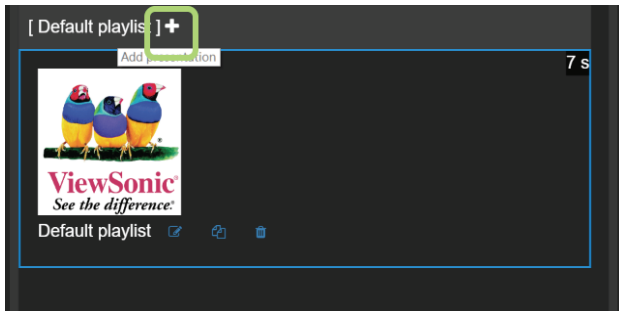

2. **Rename presentation:** Rename this presentation.

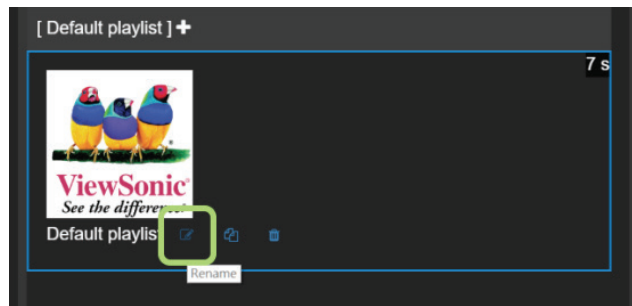

3. **Copy presentation:** Copy this presentation.

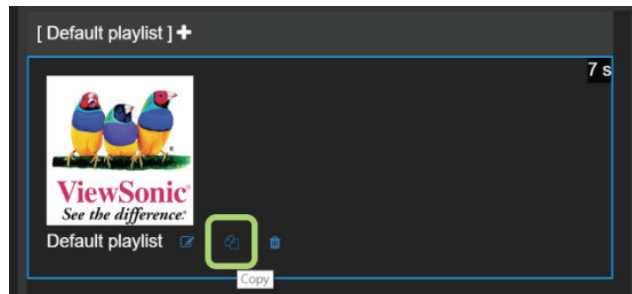

4. **Remove presentation:** Remove this presentation from this playlist.

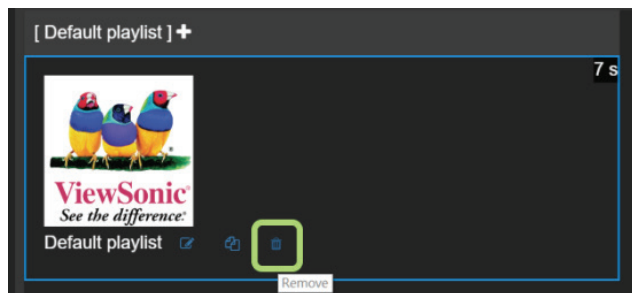

5. **Video Template:** Add "1 video only template"

- **Import Video / Change Video:** Click "Import" to import video and then change to another video.

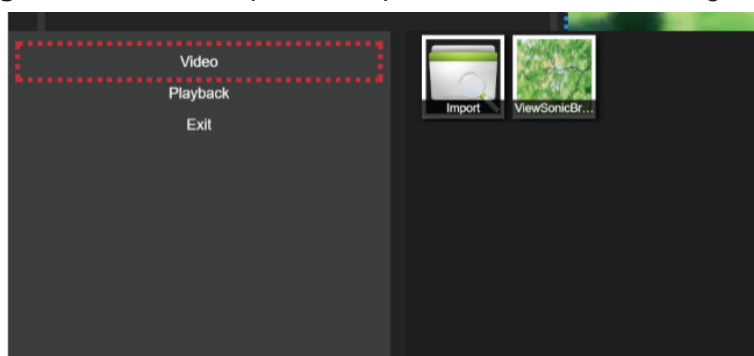

- **Change video setting:** Enable/disable loop / mute setting.

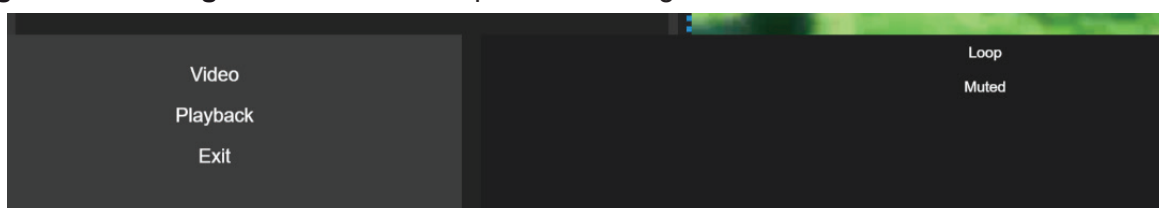

6. **Presentation – Change duration:** If you have more than two presentations in the playlist, you can change the playback duration for each presentation.

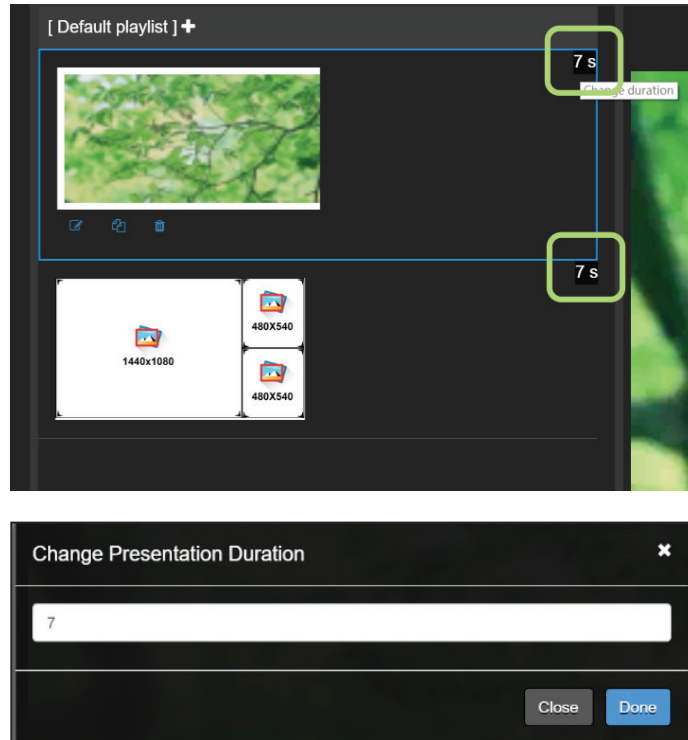

7. **Widget Template:** Add “3 widgets template”.



- 8. **Widget support 4 types:** Carousel (image and video), PowerPoint, RSS, Webpage. Click save after modify.

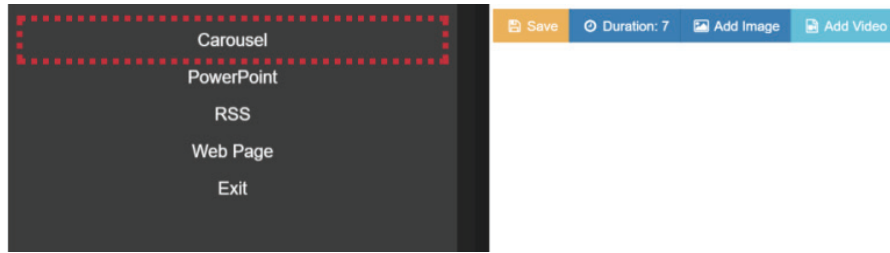

- **Carousel:** Import image or video.

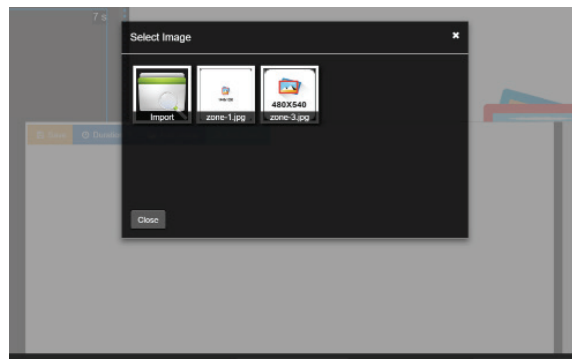

- **Carousel:** change duration: Duration only effect at image, video would play to the end.
- **PowerPoint:** Import one PowerPoint.

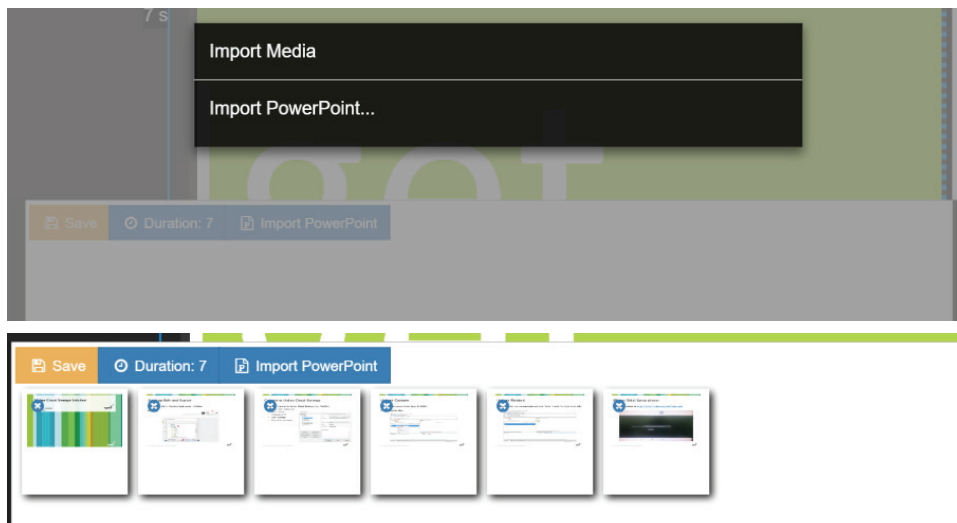

- **RSS:** Set RSS URL.

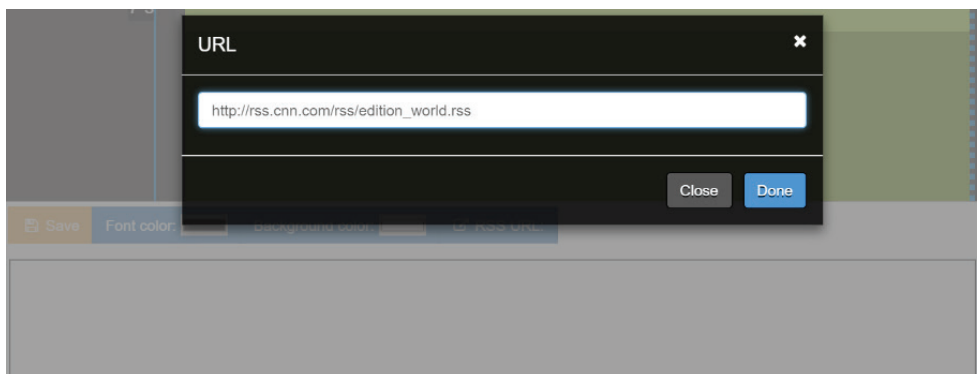

- **RSS:** Change color.

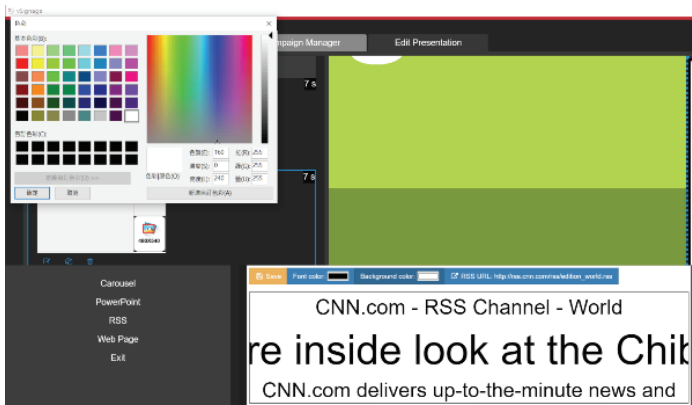

- **Web Page:** Set web page URL.

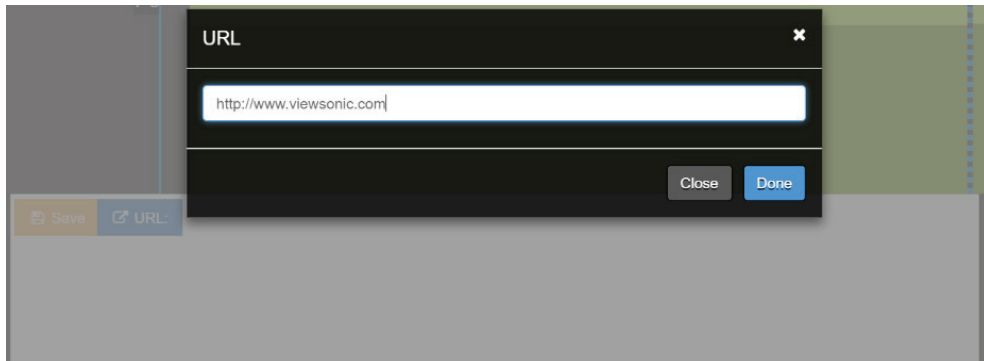

9. Image / Text template: Add "ViewSonic QSR 34 fields template".

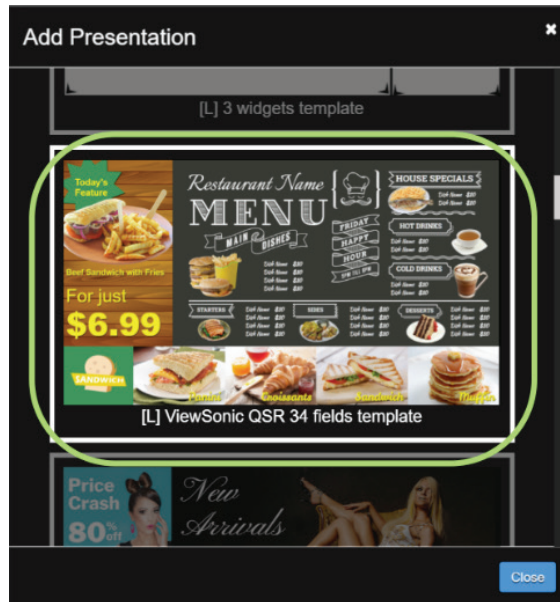

- **Image Zone:** Click the image area, user can change image.

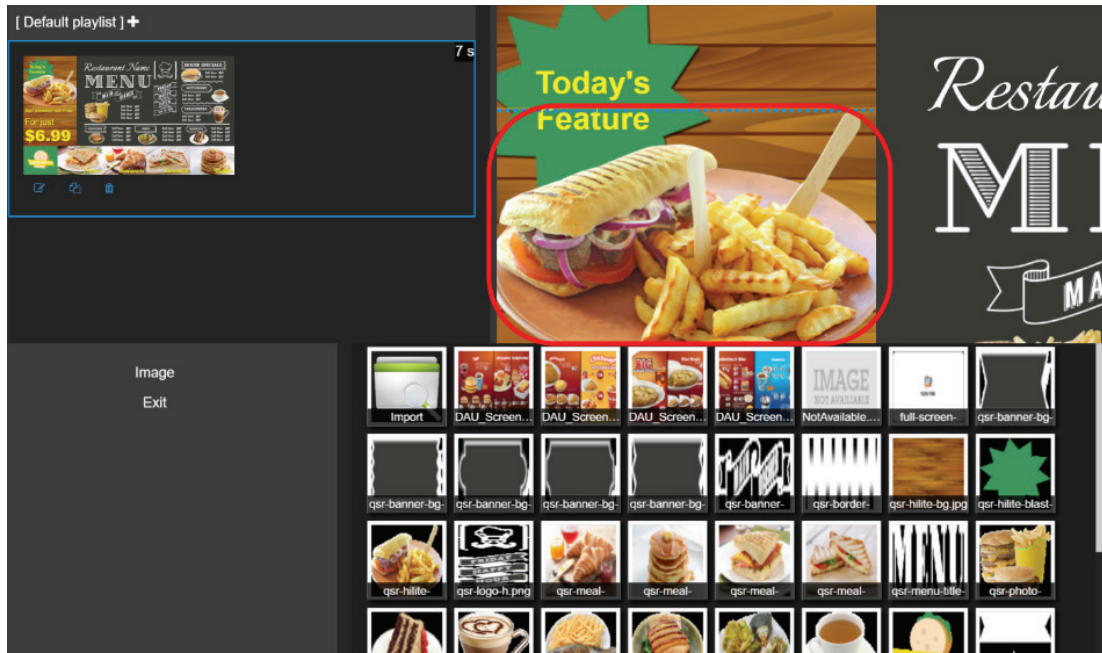

- **Text Zone:** Click the text area, user can change text and text setting.

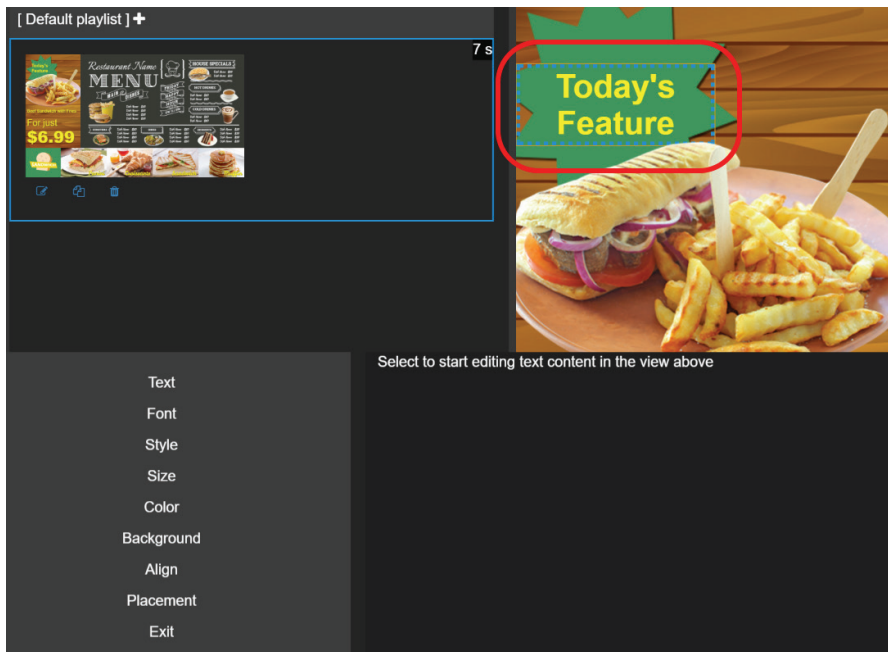

10. **Preview:** Click “5 Preview”, go to preview mode.



11. **Save:** Click “7 Save”, save the playlist and sync to other players.

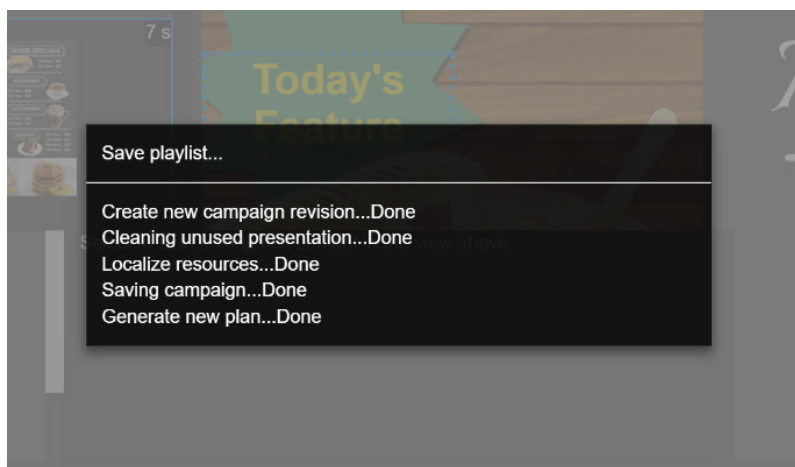

12. **Play:** Click “9 Play”, go to playback mode.

6.4. Group Manager

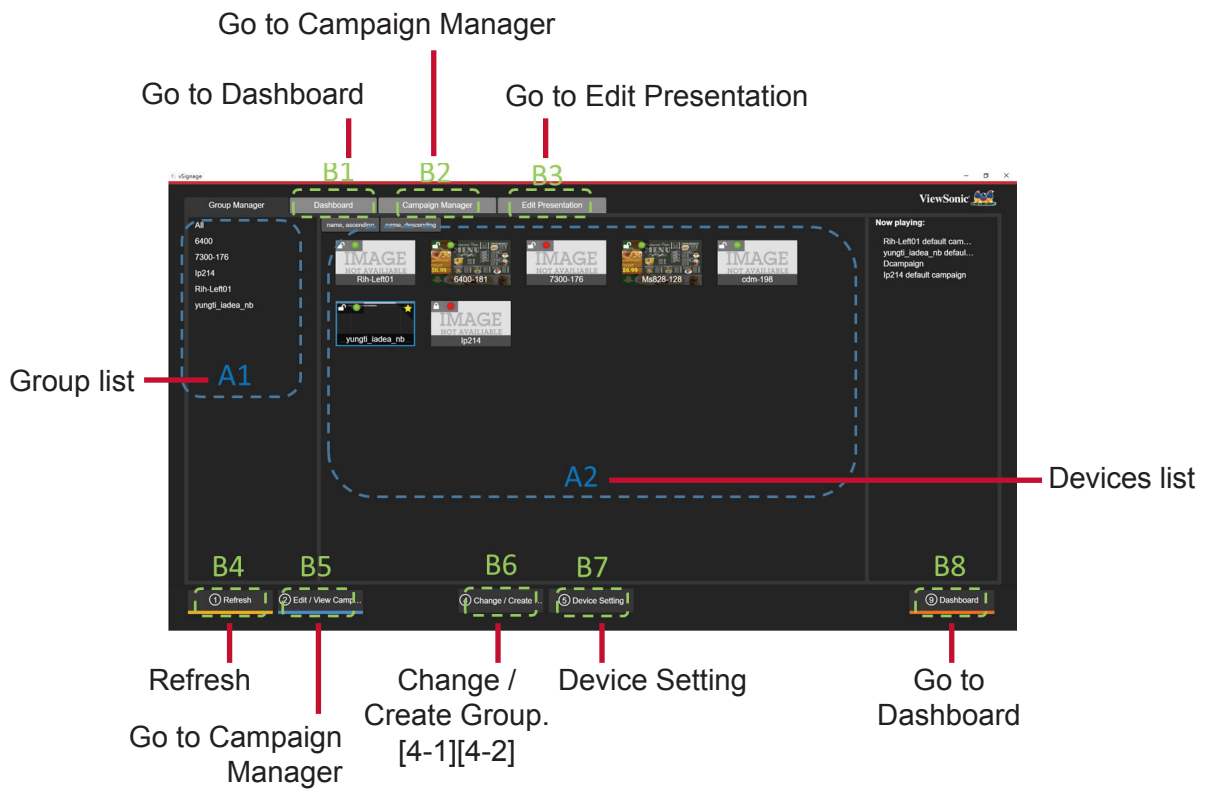

- Group Players
 - Player in the same group play the same campaign (content). Player would check update every 2 minutes.
 - Select several players
 - Click "4 Change / Create Group".
 - Dropdown box, select PC group, click "Join group".

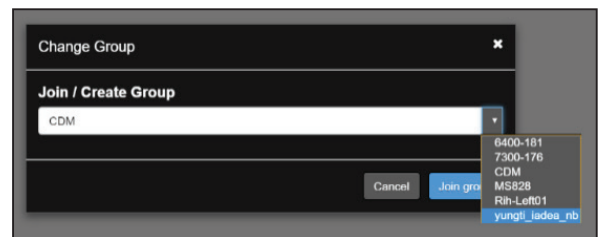
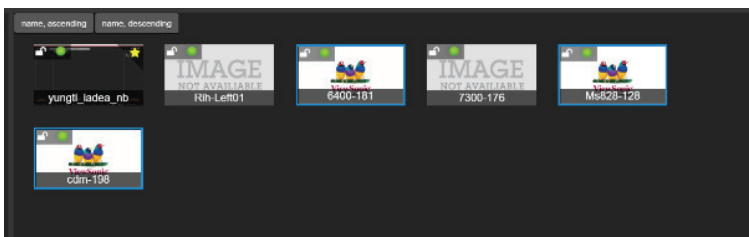

6.5. User Scenario

How to creative a sample campaign and sync to player?

1. At Dashboard,
 - a. Click “4 Group Manager”.
2. At Group Manager,
 - a. Select one player, set this player to user’s group. [4-1]
 - b. Click Tab: “Edit Presentation”.
3. At Edit Presentation,
 - a. Delete original presentation. [3-4]
 - b. Add Widget Template: 3 widgets template [3-7]
 - c. Use carousel at left zone. Add some images and videos. [3-8-1]
 - d. Use RSS at upper-right zone. Set RSS URL. [3-8-3]
 - e. Use Web page at right-lower zone. Set web page URL. [3-8-4]
 - f. Click “7 Save”. [3-11]

Wait a moment for player syncing content. After synced, player would play this three zone presentation.

7. System Settings

1. Press ▲▼◀▶ button to select desktop menu option, press **OK** to confirm.
2. Press **EXIT** button to leave.



Network Setting Apps manager Display system Storage.

Device

- Network
- Apps
- Storage
- About

Preferences

- Date & time
- Language
- Keyboard

Personal

- Security & Restrictions

Display information

Device name
EPS201T

Legal information

Model
EPS201T

Version
5.0.1

Build
aosp_piaya-userdebug 5.0.1 LRX22C V100 test-keys

The QR code leads to web site link for product upgrade or related information.

- To set default input method
- To set Android keyboard (AOSP)
- To set on-screen language
- To set Date and time
- Note:** Date & time synchronizes with web site automatically through internet. For manual setting, please turn “Automatic Data & time” to Off.
- To set Security and Restrictions
- Allow installation of apps from sources other than the Play Store.

7.1. Network Settings

1. Press ▲▼◀▶ button to select desktop menu option, press OK to confirm.
2. Press EXIT button to leave.

Wired network

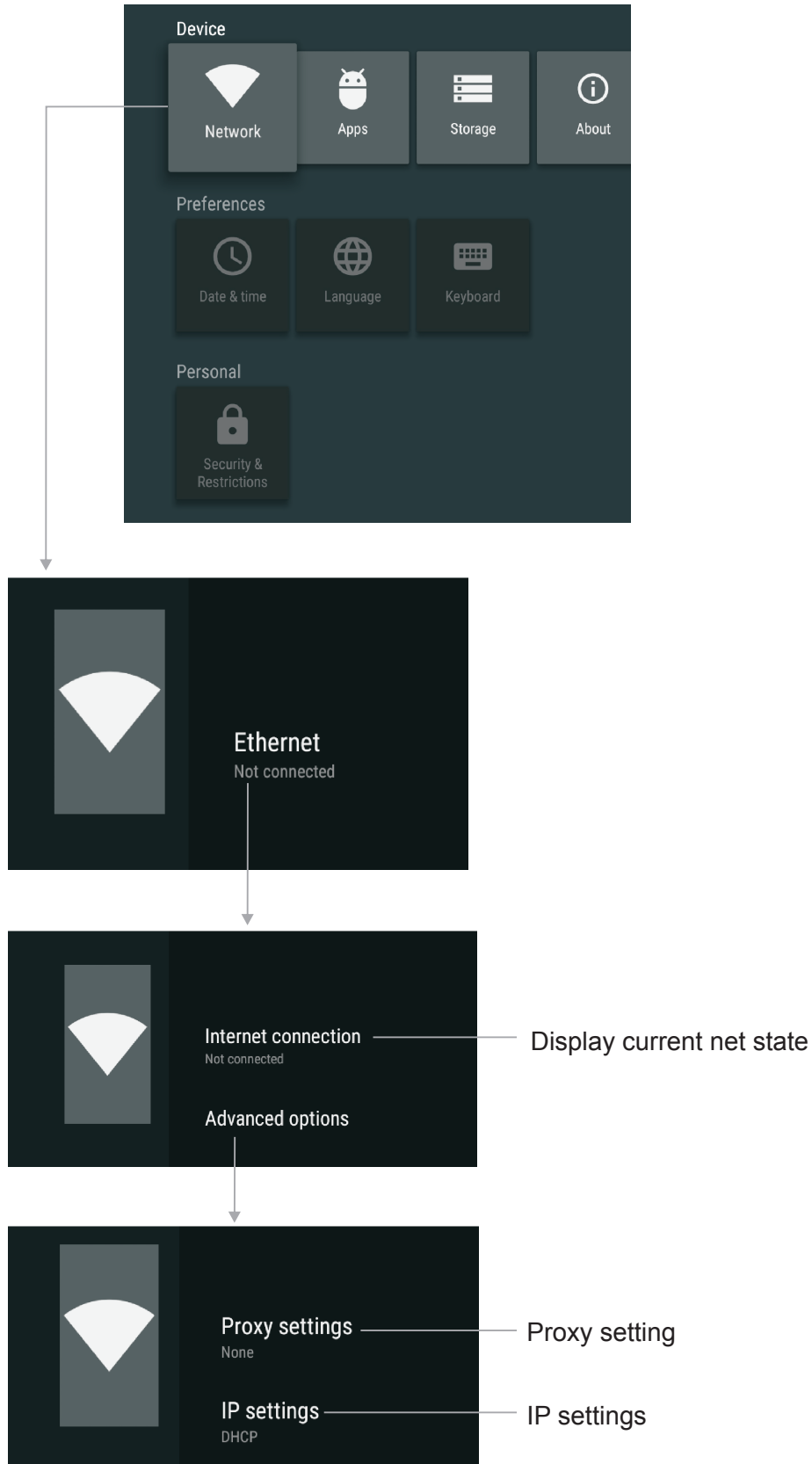

Wireless Network (USB WiFi dongle)

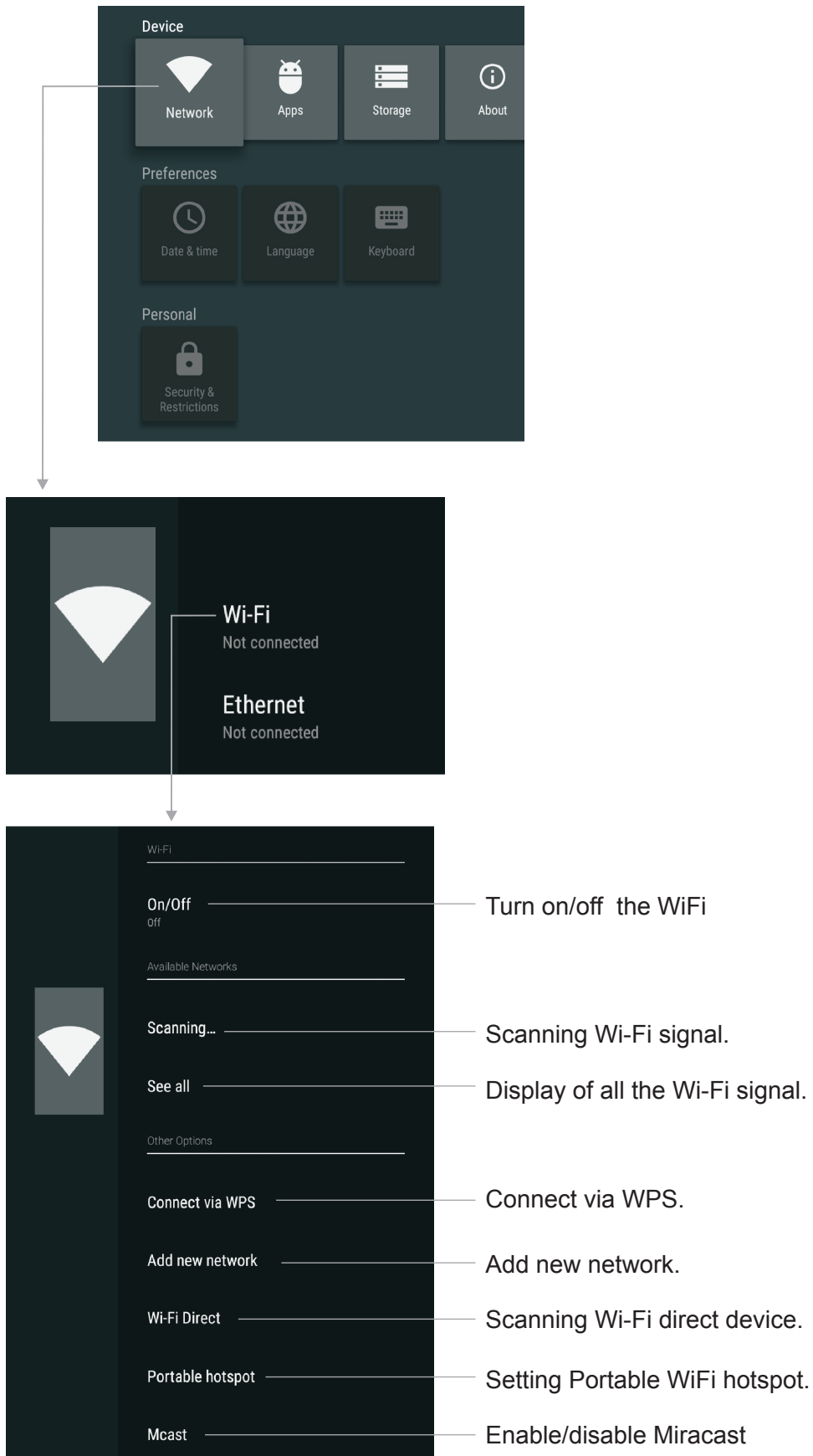

7.2. System update

1. Press ▲▼◀▶ button to entry About and then select System update.

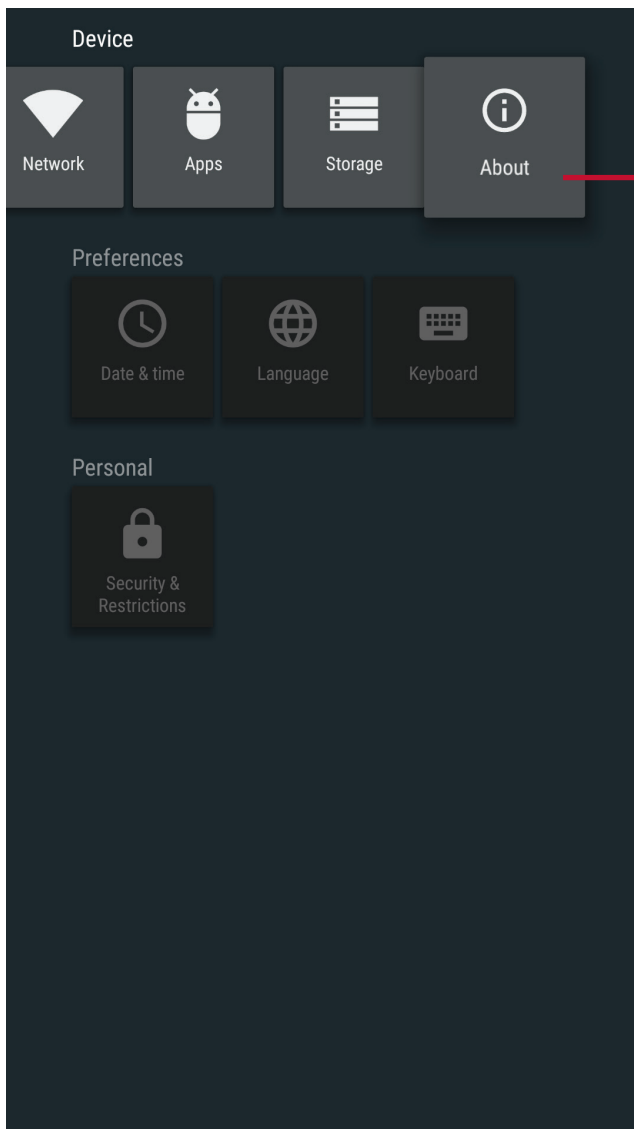

System update

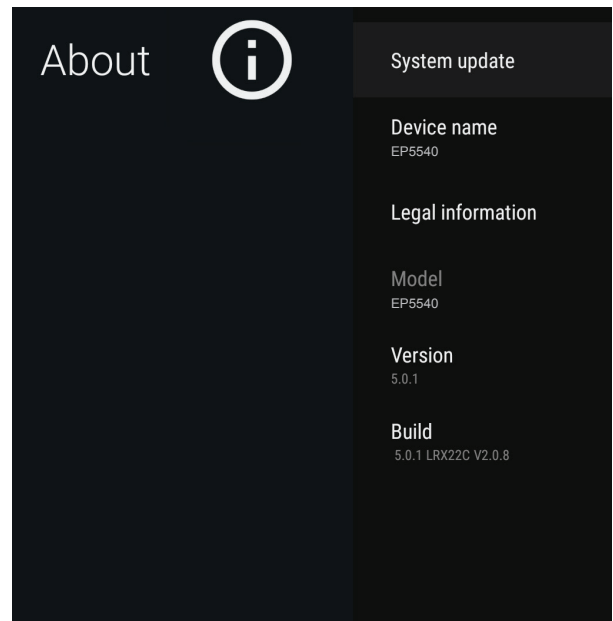

2. Select System net update

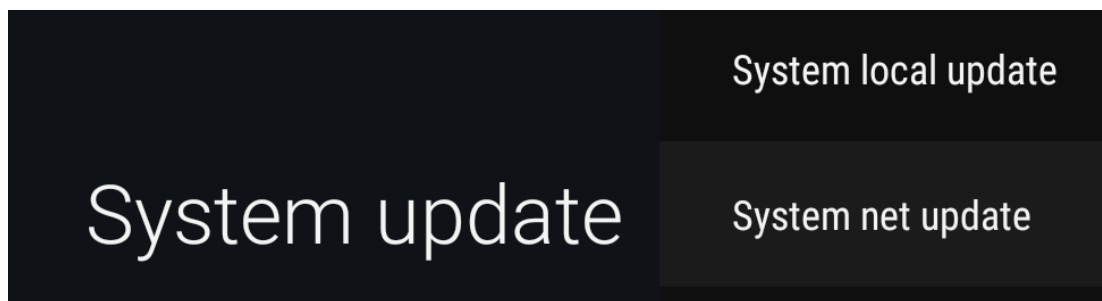

3. If the user is the latest firmware version, it will show “Your System is up-to-date”.

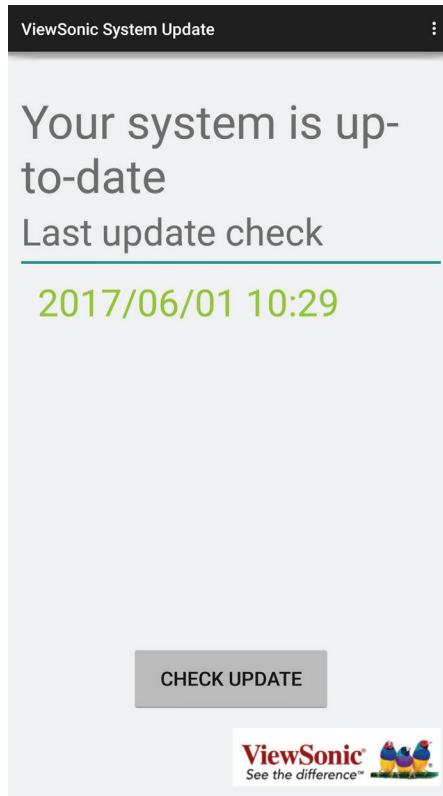

4. If you have a new firmware in the OTA server folder, it will automatically notify the user to upgrade. The user will click OK to start the download.

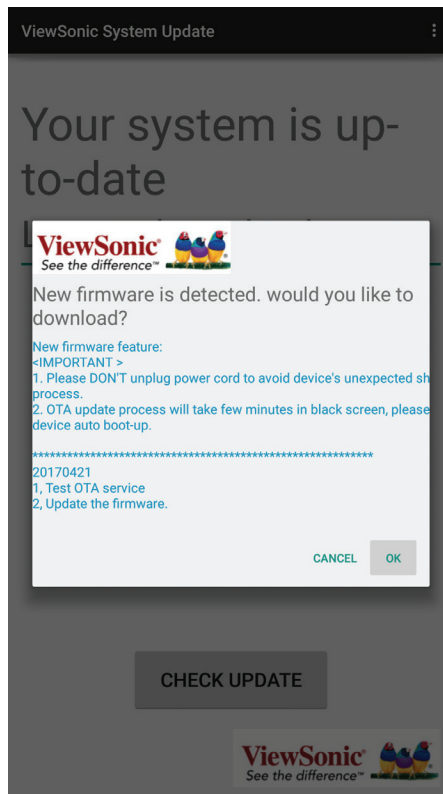

5. Start to download firmware

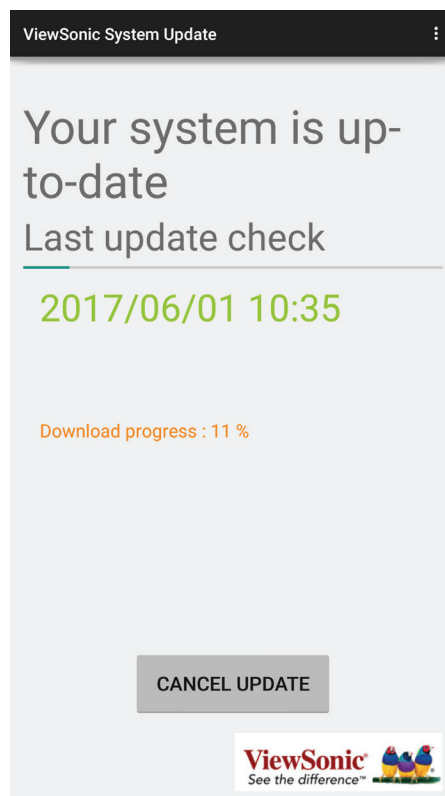

6. Complete the download screen

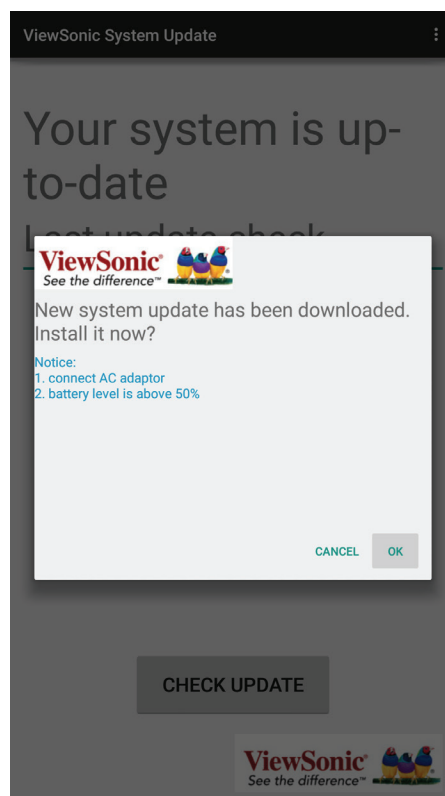

7. The user manually complete the OTA upgrade; successful upgrade will automatically restart, to retain the user's original data

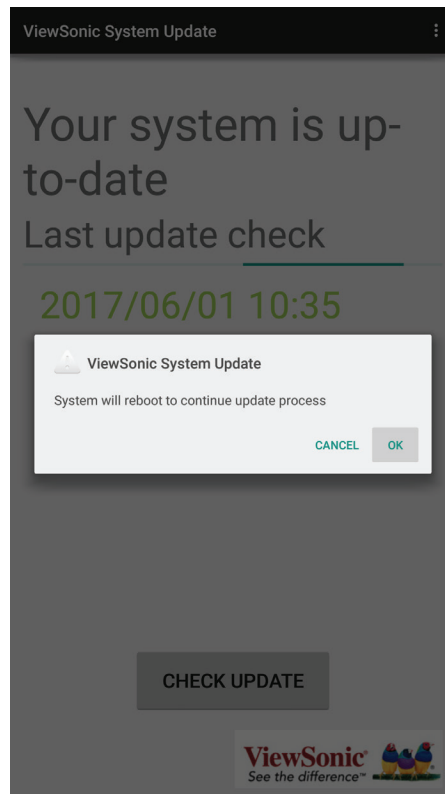

8. Menu List



Picture	Picture Mode	Select your favourite picture mode for each input.	
	Contrast	Adjust the contrast.	
	Brightness	Adjust the brightness.	
	Hue	Adjust the image hue. (Only for NTSC system)	
	Sharpness	Adjust the sharpness.	
	Saturation	Adjust the color saturation.	
	Anti-Flicker	Turn on/off the Anti-Flicker function.	
	Backlight	Set up the overall brilliance of the screen. The Anti-Flicker select Off, you can set the level of the Backlight as your desired.	
	Screen	Clock	Adjust the screen size.
		Phase	Adjust the focus of stable images.
		H-Position	Move the image right or left.
		V-Position	Move the image up or down.
		Auto Tune	Automatically adjust the image settings such as position and phase.
Color temperature	Select the color temperature.		
Bluelight Filter	Reduce the bluelight disturbance to sight, protect sight health. The Color temperature select User, you can set the level of the Bluelight Filter as your desired.		
Zoom Mode	Select the aspect ratio (display proportions) according to your video signal type or personal preference [16:9] / [4:3] / [Panorama] / [Just Scan] / [Zoom1] / [Zoom2]		
OverScan	Adjust the reproduction ratio, you may activate this function to obtain a cleaner picture.		
Image NR	Select the noise reduction mode to reduce picture noise.		



Sound	Sound Mode	Select your favourite sound mode for each input.
	Bass	Adjust Bass (low sounds).
	Treble	Adjust Treble (high sounds).
	Balance	Adjust volume level of right and left speakers.
	Surround	Turn the Surround sound effect on or off.
	Alone	Press OK to turn off the picture on your display and listen to the program audio only.



Setting	Menu Timeout	Select OSD menu display time.
	Data / Time	Display Date and Time.
	Off Timer	With Off Timer function On, the display will automatically turn off at a preset time.
	On Timer	<p>With On Timer function On, the display will automatically turn on at a preset source at a preset time.</p> <p>Highlight Period item, press ◀ or ▶ button to select Once, Everyday, Mon.~Fri., Mon.~Sat. or Sat.~Sun.</p>
Sleep Time	<p>Set the duration of time until the display automatically goes into Standby mode.</p> <p>[Off] / [10 Minutes] / [20 Minutes] / [30 Minutes] / [60 Minutes] / [90 Minutes] / [120 Minutes] / [180 Minutes] / [240 Minutes].</p>	

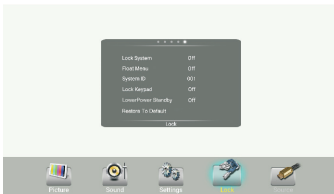
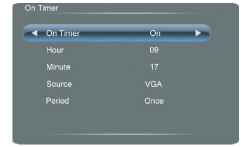

Lock	Set Password	<p>Password settings.</p> <p>(The default password is 0000 and the super one is "2580")</p>
	Float Menu	Turn on/off the float menu display.
	System ID	Setting the device ID. (The ID must be in the range of 1-98.)
	Lock Keypad	<p>The display buttons is locked.</p> <p>OFF: Select to enable the panel buttons.</p> <p>ON: Select to disable the panel buttons.</p>
	LowerPower Standby	Set to ON , the display goes into lower power standby mode, turn off the picture and audio. RS232 can wake up and turn on the display.
	Auto Play	Set to ON , the display will copy media file from external storage to internal storage then to play the media file automatically.
	Slideshow interval	Setting the photo slideshow interval.
	Restore To Default	Reset all settings to factory defaults.

9. Using Auto Play

1. Copy media content (see page 24 for supported media format) to the root directory of a USB Flash drive. USB Flash drive should be formatted as FAT32.
2. Using the ePoster remote control, press the Menu button.
3. Using the arrow buttons on the remote scroll to the right and select the Lock option.
4. Press OK to enter Lock menu



5. When prompted enter use the remote to enter the password (default standard user password is "0000" and super user is "2580").
6. Scroll down to Auto Play and change the option to On.

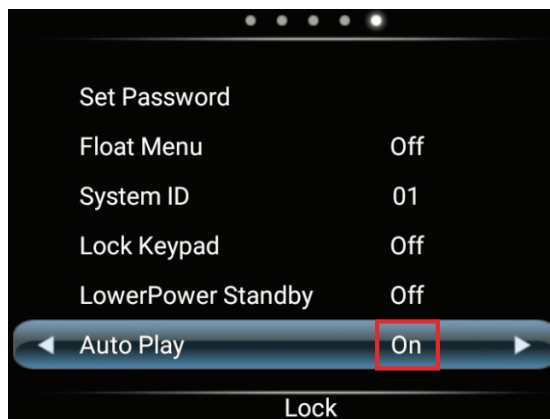

7. Press Exit to close Menu screen
8. Plug the USB drive into the USB2 (Mainboard) input of the ePoster. Files will be copied to the ePoster internal memory automatically.

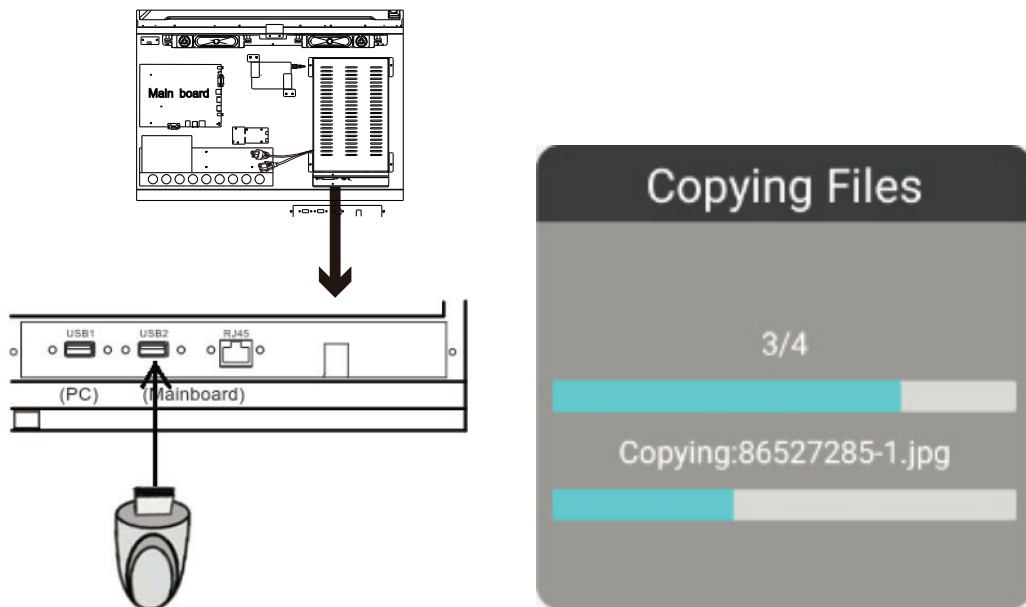

9. After the copying of files have completed, a “Please remove the USB disk” message will display. At this point, it is safe to remove the USB drive. Playback of the copied content will automatically begin.



10. Using USB multi media player

10.1. Insert the USB drive with multimedia content including photo, movie and music.

10.2. Switch the input source to USB mode.

Notes:

- It is recommended to back up your USB device data.
- Please name your files in English, Otherwise the file names can not be shown correctly.
- Some USB device may not be compatible with this display.

USB multi media interface introduction

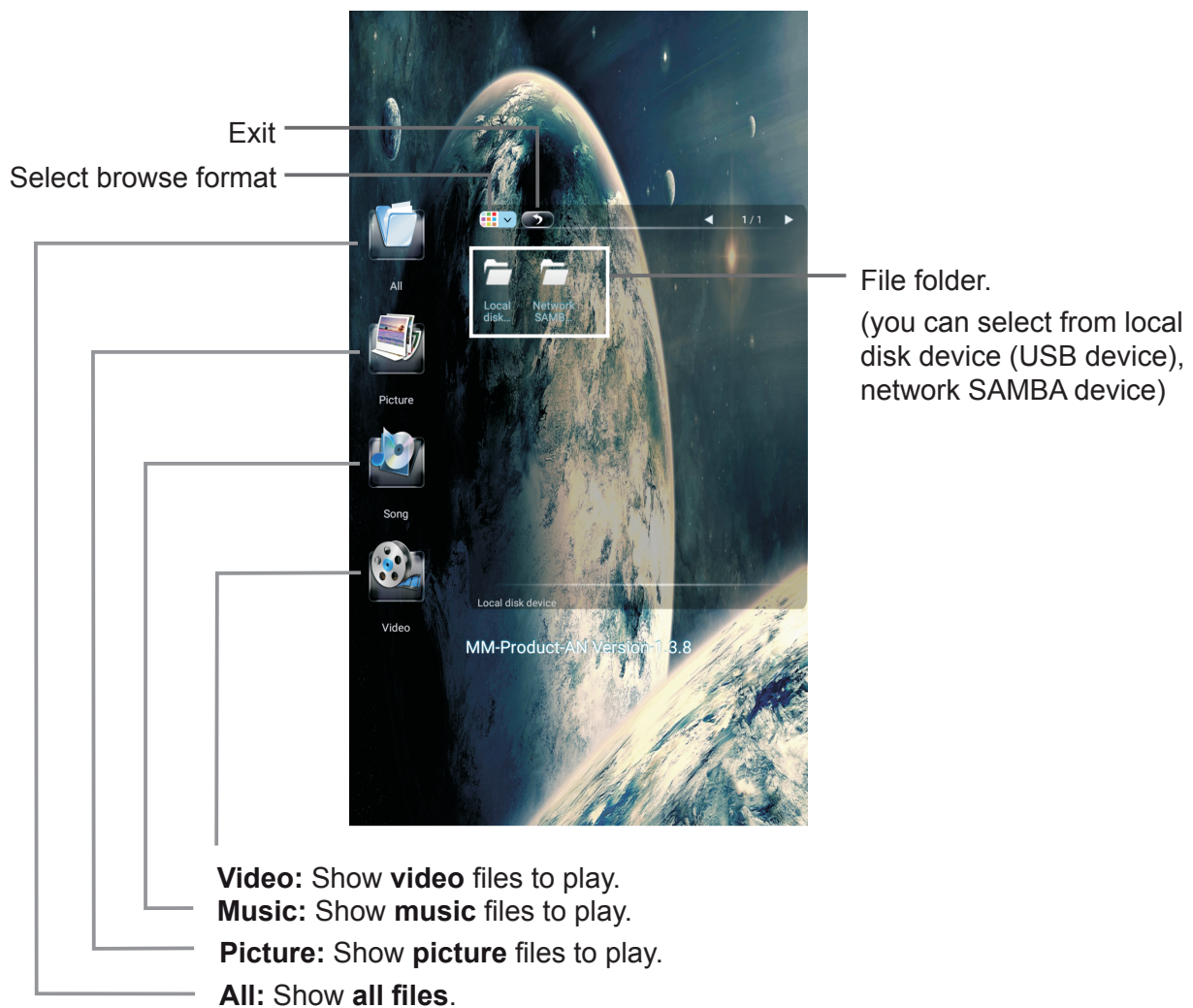

10.3. Playing Photo

Support photo (in JPG, BMP or PNG format).



Previous photo
Play/pause
Next photo
Show information
Zoom in
Zoom out

Notes: You can also use $\blacktriangleright/\parallel$ (Play/Pause), \blacksquare (STOP), $\blacktriangleleft\blacktriangleleft$ (Previous), $\blacktriangleright\blacktriangleright$ (Next) on the remote control to operate.

10.4. Playing Music

Support music (in MP3 or AAC format).



Previous song
Pause/Play
Next song
Repeat mode select
Show information
Show playlist

Repeat Mode

 repeat to play single music.

 repeat to play all music files in current folder when it plays to the end.

 no repeat when it plays to the end.

Notes: For touch model, when the control bar disappears during playback, please touch the lower portion of the screen to show it up.

10.5. Playing Movie

Support movie in MPG, MKV, DAT, MP4, MOV or VOB format.

Playing:10000BC_1080p.mov 1/2 *1 times speed

00:02 01:19

THE FOLLOWING **PREVIEW** HAS BEEN APPROVED FOR
ALL AUDIENCES
BY THE MOTION PICTURE ASSOCIATION OF AMERICA, INC.

THE FILM ADVERTISED HAS BEEN RATED
PG-13 PARENTS STRONGLY CAUTIONED
SOME MATERIAL MAY BE INAPPROPRIATE FOR CHILDREN UNDER 13
SEQUENCES OF INTENSE ACTION
AND VIOLENCE

www.filmratings.com www.mpaas.org

Previous movie
Fast reverse
Play/pause
Fast forward
Next movie
Skip to specific point by input time
Show playlist
Show information

Adjust the volume
AB Section repeat

Playing settings

A-B Section repeat
Section replay OFF
Set starting point A
Set ending point B

Current time : 00:00:20
Total time : 00:05:53
00:00:00

video subtitle close
breakpoint play close
video track
Choose Confirm Exit

A-B repeat : Trun the **Section Replay** to On, then set starting point A and ending point B.
No repeat: Turn the **Section Replay** to Off.

11. Supported media files format

Image	File extension	*.jpg, *.jpeg, *.bmp, *.png
	Codec	Standard RGB
	Max. Image resolution	Baseline JPEG : 15360x8704 Progressive JPEG: 1024x768 None Interlace PNG : 9600 x 6400 Interlace PNG: 1200x800 BMP : 9600 x 6400
	Max. File name length	128 letters
Video	File extension	*.mpg, *.mkv, *.mov, *.mp4, *.vob, *.dat
	Codec & Bitrate	MPEG-1 bitrate<40Mbps MPEG-4 bitrate<40Mbps H.264 bitrate<80Mbps
	File extension	*.mp3, *AAC,
Audio	File extension	*.mp3, *AAC,

*Practically supported format will depend on the paid royalties.

12. Troubleshooting

If, after reading these operating instructions, you have additional questions related to the use of your display, please call the services center in your local area.

Before calling service, please check the symptoms and follow suggested solutions.

Remote Control

Problem	Possible Solutions
Remote control does not operate	<ul style="list-style-type: none">• The batteries could be weak. Replace the batteries.• Check the orientation of the batteries.• Make sure the power cord is plugged in.

Video and Audio

Problem	Possible Solutions
No picture (screen not lit), No sound	<ul style="list-style-type: none">• Make sure the power cord is plugged in.• Press POWER on the display or on the remote control.
Dark, poor or no picture (Screen lit), good sound	<ul style="list-style-type: none">• Select a proper picture mode.• Adjust the brightness in the video setting.
No color/dark picture/abnormal color	<ul style="list-style-type: none">• Adjust the color saturation in the video setting.
Dotted lines or stripes	<ul style="list-style-type: none">• Move the display away from noise sources such as cars, neon signs, or hair dryers.
Good picture, no sound	<ul style="list-style-type: none">• The sound may be muted. Press MUTE again to cancel.
Audio noise	<ul style="list-style-type: none">• Communication problems may occur if infrared communication equipment (e.g., infrared cordless headphones) is used near the display. Move the infrared communication equipment away from the display until the noise is eliminated.

General

Problem	Possible Solutions
Some items can't be accessed	<ul style="list-style-type: none">• If a setting option appears in gray, this indicates that the settings option is unavailable in current input mode.
Remote control command is not effect in some cases.	<ul style="list-style-type: none">• During the timing of USB device detection (i.e. when the display is turned on with USB device connected, or when you plug in USB device during display working), the display may not act by remote control buttons in such case. Wait some time, then it is OK.
Control buttons do not operate	<ul style="list-style-type: none">• Disconnect the power cord and wait for a few seconds. Then re-plug the power cord and turn on the unit again.
POWER button responds slowly after power is connected.	<ul style="list-style-type: none">• When you push POWER SWITCH to power on the display, in about 3 seconds the POWER button starts to respond after pressed.

Note: If your problem is not solved, turn your unit off and then on again.

Cautions: Never attempt to repair a defective display yourself.

13. Specifications

Display:

Model No.		EP5540	EP5540T
Power Source		AC 100-240 V, 50 / 60 Hz	
Current Max.		1.8A	1.8A
Display panel	Visible screen size	55 inches (diagonal)	55 inches (diagonal)
	Number of pixels	3,840 × 2,160	3,840 × 2,160
Dimensions (W × D × H)		812×450×1900 mm 31.97×17.71×74.80 in	820×450×1900 mm 32.28×17.71×74.80 in
Net Weight		69.7 kg 153.66 lb	70 kg 154.32 lb
Operating conditions		Temperature: 0°C to 40°C 32°F to 104°F Humidity: 20% ~ 80% non-condensing	
Storage conditions		Temperature: -20°C to 60°C - 4°F to 140°F Humidity: 10% ~ 90% non-condensing	
Atmospheric pressure		86kPa ~ 106kPa	
Connection terminals of the Poster	PC IN	1	1
	USB	3	3
	HDMI Input	2	2
	RJ45 (LAN IN)	1	1
	Headphone	1	1
	RS-232	1	1
	TOUCH OUT	0	1

Notes:

1. Design and specifications are subject to change without notice.
2. Weight and dimensions shown are approximate.
3. Specifications and external appearance may be changed for the sake of improvement.

14. Other Information

Customer Support

For technical support or product service, see the table below or contact your reseller.

NOTE: You will need the product serial number.

Country/Region	Website	T= Telephone C = CHAT ONLINE	Email
Australia/New Zealand	www.viewsonic.com.au	AUS= 1800-880-818 NZ= 0800-008-822	service@au.viewsonic.com
Canada	www.viewsonic.com	T= 1-866-463-4775	service.ca@viewsonic.com
Europe	www.viewsoniceurope.com	www.viewsoniceurope.com/eu/support/call-desk/	
Hong Kong	www.hk.viewsonic.com	T= (852)-3102-2900	service@hk.viewsonic.com
India	www.in.viewsonic.com	T= 1800-419-0959	service@in.viewsonic.com
Korea	ap.viewsonic.com/kr/	T= 080-333-2131	service@kr.viewsonic.com
Latin America	www.viewsonic.com/la/	C= http://www.viewsonic.com/la/soporte/servicio-tecnico	soporte@viewsonic.com
<p>Nexus Hightech Solutions, Cincinnati #40 Desp. 1 Col. De los Deportes Mexico D.F. Tel: 55) 6547-6454 55)6547-6484 Other places please refer to http://www.viewsonic.com/la/soporte/servicio-tecnico#mexico</p>			
Macau	www.hk.viewsonic.com	T= (853)-2833-8407	service@hk.viewsonic.com
Middle East	ap.viewsonic.com/me/	Contact your reseller	service@ap.viewsonic.com
Puerto Rico & Virgin Islands	www.viewsonic.com	T= 1-800-688-6688 (English) C= http://www.viewsonic.com/la/soporte/servicio-tecnico	"service.us@viewsonic.com soporte@viewsonic.com"
Singapore/	www.viewsonic.com/sg/	T= 65 6461 6044	service@ap.viewsonic.com
Malaysia	www.viewsonic.com/my/	T= 1800 - 88 - 8997	service@ap.viewsonic.com
Thailand	www.viewsonic.com/th/	T= 02-7214091-3	service@ap.viewsonic.com
South Africa	ap.viewsonic.com/za/	Contact your reseller	service@ap.viewsonic.com
United States	www.viewsonic.com	T= 1-800-688-6688	service.us@viewsonic.com
Indonesia	www.viewsonic.com/id/	Contact your reseller	service@ap.viewsonic.com
Japan	www.viewsonic.com/jp/	T= 050-3388-6832	service@ap.viewsonic.com
Philippines	www.viewsonic.com/ph/	Contact your reseller	service@ap.viewsonic.com
Vietnam	www.viewsonic.com/vn/	Contact your reseller	service@ap.viewsonic.com
Taiwan	www.viewsonic.com/tw/	T= 0800-899-880	service@tw.viewsonic.com

Limited Warranty

ViewSonic® LCD Commercial Display

What the warranty covers:

ViewSonic warrants its products to be free from defects in material and workmanship, under normal use, during the warranty period. If a product proves to be defective in material or workmanship during the warranty period, ViewSonic will, at its sole option, repair or replace the product with a like product. Replacement product or parts may include remanufactured or refurbished parts or components.

Who the warranty protects:

This warranty is valid only for the first consumer purchaser.

What the warranty does not cover:

1. Any product on which the serial number has been defaced, modified or removed.
2. Damage, deterioration or malfunction resulting from:
 - a. Accident, misuse, neglect, fire, water, lightning, or other acts of nature, unauthorized product modification, or failure to follow instructions supplied with the product.
 - b. Any damage of the product due to shipment.
 - c. Removal or installation of the product.
 - d. Causes external to the product, such as electrical power fluctuations or failure.
 - e. Use of supplies or parts not meeting ViewSonic's specifications.
 - f. Normal wear and tear.
 - g. Any other cause which does not relate to a product defect.
3. Any product exhibiting a condition commonly known as "image burn-in" which results when a static image is displayed on the product for an extended period of time.
4. Removal, installation, one way transportation, insurance, and set-up service charges.

How to get service:

1. For information about receiving service under warranty, contact ViewSonic Customer Support (Please refer to Customer Support page). You will need to provide your product's serial number.
2. To obtain warranty service, you will be required to provide (a) the original dated sales slip, (b) your name, (c) your address, (d) a description of the problem, and (e) the serial number of the product.
3. Take or ship the product freight prepaid in the original container to an authorized ViewSonic service center or ViewSonic.
4. For additional information or the name of the nearest ViewSonic service center, contact ViewSonic.

Limitation of implied warranties:

There are no warranties, express or implied, which extend beyond the description contained herein including the implied warranty of merchantability and fitness for a particular purpose.

Exclusion of damages:

ViewSonic's liability is limited to the cost of repair or replacement of the product. ViewSonic shall not be liable for:

1. Damage to other property caused by any defects in the product, damages based upon inconvenience, loss of use of the product, loss of time, loss of profits, loss of business opportunity, loss of goodwill, interference with business relationships, or other commercial loss, even if advised of the possibility of such damages.
2. Any other damages, whether incidental, consequential or otherwise.
3. Any claim against the customer by any other party.
4. Repair or attempted repair by anyone not authorized by ViewSonic.

Effect of state law:

This warranty gives you specific legal rights, and you may also have other rights which vary from state to state. Some states do not allow limitations on implied warranties and/or do not allow the exclusion of incidental or consequential damages, so the above limitations and exclusions may not apply to you.

Sales outside the U.S.A. and Canada:

For warranty information and service on ViewSonic products sold outside of the U.S.A. and Canada, contact ViewSonic or your local ViewSonic dealer.

The warranty period for this product in mainland China (Hong Kong, Macao and Taiwan Excluded) is subject to the terms and conditions of the Maintenance Guarantee Card.

For users in Europe and Russia, full details of warranty provided can be found in www.viewsoniceurope.com under Support/Warranty Information.

Mexico Limited Warranty

ViewSonic® LCD Commercial Display

What the warranty covers:

ViewSonic warrants its products to be free from defects in material and workmanship, under normal use, during the warranty period. If a product proves to be defective in material or workmanship during the warranty period, ViewSonic will, at its sole option, repair or replace the product with a like product. Replacement product or parts may include re-manufactured or refurbished parts or components.

Who the warranty protects:

This warranty is valid only for the first consumer purchaser.

What the warranty does not cover:

1. Any product on which the serial number has been defaced, modified or removed.
2. Damage, deterioration or malfunction resulting from:
 - a. Accident, misuse, neglect, fire, water, lightning, or other acts of nature, unauthorized product modification, or failure to follow instructions supplied with the product.
 - b. Any damage of the product due to shipment.
 - c. Removal or installation of the product.
 - d. Causes external to the product, such as electrical power fluctuations or failure.
 - e. Use of supplies or parts not meeting ViewSonic's specifications.
 - f. Normal wear and tear.
 - g. Any other cause which does not relate to a product defect.
3. Any product exhibiting a condition commonly known as "image burn-in" which results when a static image is displayed on the product for an extended period of time.
4. Removal, installation, one way transportation, insurance, and set-up service charges.

How to get service:

For information about receiving service under warranty, contact ViewSonic Customer Support (Please refer to the attached Customer Support page). You will need to provide your product's serial number, so please record the product information in the space provided below on your purchase for your future use. Please retain your receipt of proof of purchase to support your warranty claim.

For Your Records

Product Name: _____

Model Number: _____

Document Number: _____

Serial Number: _____

Purchase Date: _____

Extended Warranty Purchase? _____ (Y/N)

If so, what date does warranty expire? _____

1. To obtain warranty service, you will be required to provide (a) the original dated sales slip, (b) your name, (c) your address, (d) a description of the problem, and (e) the serial number of the product.
2. Take or ship the product in the original container packaging to an authorized ViewSonic service center.
3. Round trip transportation costs for in-warranty products will be paid by ViewSonic.

Limitation of implied warranties:

There are no warranties, express or implied, which extend beyond the description contained herein including the implied warranty of merchantability and fitness for a particular purpose.

Exclusion of damages:

ViewSonic's liability is limited to the cost of repair or replacement of the product. ViewSonic shall not be liable for:

1. Damage to other property caused by any defects in the product, damages based upon inconvenience, loss of use of the product, loss of time, loss of profits, loss of business opportunity, loss of goodwill, interference with business relationships, or other commercial loss, even if advised of the possibility of such damages.
2. Any other damages, whether incidental, consequential or otherwise.
3. Any claim against the customer by any other party.
4. Repair or attempted repair by anyone not authorized by ViewSonic.

Contact Information for Sales & Authorized Service (Centro Autorizado de Servicio) within Mexico:	
Name, address, of manufacturer and importers: México, Av. de la Palma #8 Piso 2 Despacho 203, Corporativo Interpalmas, Col. San Fernando Huixquilucan, Estado de México Tel: (55) 3605-1099 http://www.viewsonic.com/la/soporte/index.htm	
NÚMERO GRATIS DE ASISTENCIA TÉCNICA PARA TODO MÉXICO: 001.866.823.2004	
Hermosillo: Distribuciones y Servicios Computacionales SA de CV. Calle Juarez 284 local 2 Col. Bugambilias C.P: 83140 Tel: 01-66-22-14-9005 E-Mail: disc2@hmo.megared.net.mx	Villahermosa: Compumantenimietnos Garantizados, S.A. de C.V. AV. GREGORIO MENDEZ #1504 COL, FLORIDA C.P. 86040 Tel: 01 (993) 3 52 00 47 / 3522074 / 3 52 20 09 E-Mail: compumantenimientos@prodigy.net.mx
Puebla, Pue. (Matriz): RENTA Y DATOS, S.A. DE C.V. Domicilio: 29 SUR 721 COL. LA PAZ 72160 PUEBLA, PUE. Tel: 01(52).222.891.55.77 CON 10 LINEAS E-Mail: datos@puebla.megared.net.mx	Veracruz, Ver.: CONEXION Y DESARROLLO, S.A DE C.V. Av. Americas # 419 ENTRE PINZÓN Y ALVARADO Fracc. Reforma C.P. 91919 Tel: 01-22-91-00-31-67 E-Mail: gacosta@qplus.com.mx
Chihuahua Soluciones Globales en Computación C. Magisterio # 3321 Col. Magisterial Chihuahua, Chih. Tel: 4136954 E-Mail: Cefeo@soluglobales.com	Cuernavaca Compusupport de Cuernavaca SA de CV Francisco Leyva # 178 Col. Miguel Hidalgo C.P. 62040, Cuernavaca Morelos Tel: 01 777 3180579 / 01 777 3124014 E-Mail: aquevedo@compusupportcva.com
Distrito Federal: QPLUS, S.A. de C.V. Av. Coyoacán 931 Col. Del Valle 03100, México, D.F. Tel: 01(52)55-50-00-27-35 E-Mail : gacosta@qplus.com.mx	Guadalajara, Jal.: SERVICRECE, S.A. de C.V. Av. Niños Héroes # 2281 Col. Arcos Sur, Sector Juárez 44170, Guadalajara, Jalisco Tel: 01(52)33-36-15-15-43 E-Mail: mmiranda@servicrece.com
Guerrero Acapulco GS Computación (Grupo Sesicomp) Progreso #6-A, Colo Centro 39300 Acapulco, Guerrero Tel: 744-48-32627	Monterrey: Global Product Services Mar Caribe # 1987, Esquina con Golfo Pérsico Fracc. Bernardo Reyes, CP 64280 Monterrey N.L. México Tel: 8129-5103 E-Mail: aydeem@gps1.com.mx
MERIDA: ELECTROSER Av Reforma No. 403Gx39 y 41 Mérida, Yucatán, México CP97000 Tel: (52) 999-925-1916 E-Mail: rrrb@sureste.com	Oaxaca, Oax.: CENTRO DE DISTRIBUCION Y SERVICIO, S.A. de C.V. Murguía # 708 P.A., Col. Centro, 68000, Oaxaca Tel: 01(52)95-15-15-22-22 Fax: 01(52)95-15-13-67-00 E-Mail: gpotai2001@hotmail.com
Tijuana: STD Av Ferrocarril Sonora #3780 L-C Col 20 de Noviembre Tijuana, Mexico	FOR USA SUPPORT: ViewSonic Corporation 14035 Pipeline Ave. Chino, CA 91710, USA Tel: 800-688-6688 E-Mail: http://www.viewsonic.com



ViewSonic®