

Yoga AIOi (27",10)

Lenovo
YOGA

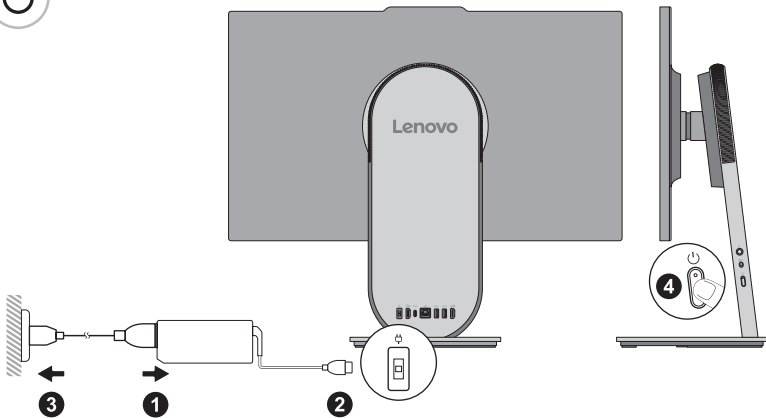



Turn to *User Guide* for USB transfer rates and more product information.



For selected models



Adjust the computer stand

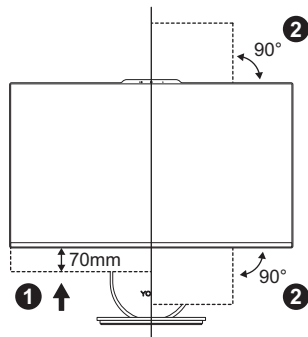
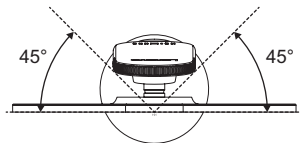
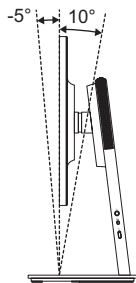



Wireless charging*

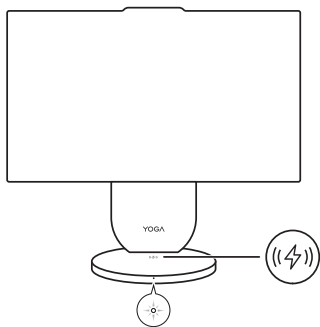

Switch mode

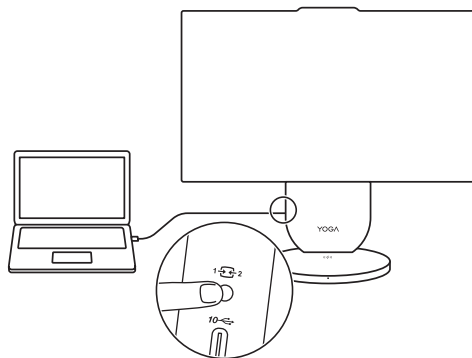



Screen sharing

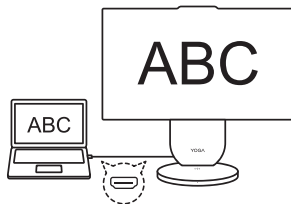
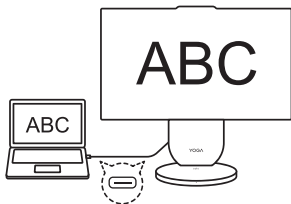

Reverse charging

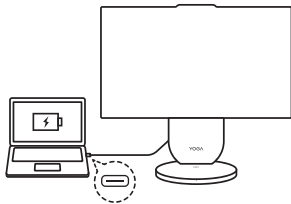

Speaker sharing





Camera sharing

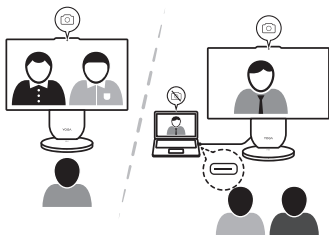

Keyboard and mouse sharing

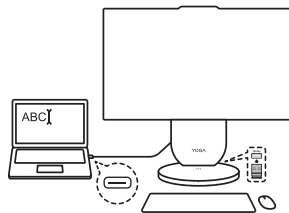

The above functions are only supported in certain modes.



User Guide Access

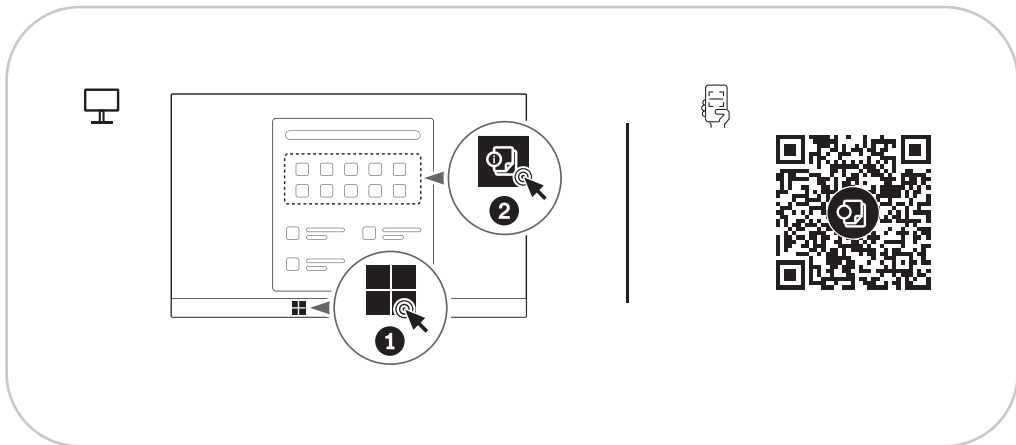

[English]

European Union (EU) / United Kingdom (UK) — radio frequency and power

This radio equipment operates with the following frequency bands and maximum radio-frequency power:

Technology	Frequency band [MHz]	Maximum transmit power
WLAN 802.11b/g/n/ax/be	2400 - 2483.5	< 20 dBm
WLAN 802.11a/n/ac/ax/be	5150 - 5725	< 23 dBm
WLAN 802.11a/n/ac/ax/be	5725 - 5875	< 13.98 dBm
WLAN 802.11ax/be	5945 - 6425	< 23 dBm
Bluetooth BR/EDR/LE	2400 - 2483.5	< 20 dBm
WPC	0.11 - 0.148	< -25.24@10m dBμA/m

Note: Not all wireless bands may be enabled depending on your product configuration. Usage of this device is limited to indoor locations in the bands 5150 - 5350 MHz and 5945 - 6425 MHz.



For FSC Mix logo only

First Edition
(February 2025)

© Copyright Lenovo 2025.

LENOVO, LENOVO logo, Yoga, and Yoga logo are trademarks of Lenovo. The terms HDMI and HDMI High-Definition Multimedia Interface are trademarks or registered trademarks of HDMI Licensing LLC in the United States and other countries. USB-C is a registered trademark of USB Implementers Forum. All other trademarks are the property of their respective owners.

LIMITED AND RESTRICTED RIGHTS NOTICE: If data or software is delivered pursuant to a General Services Administration "GSA" contract, use, reproduction, or disclosure is subject to restrictions set forth in Contract No. GS-35F-05925.