

**SAMSUNG**

**HW-K370 / KM37 / KM37C**  
**Wireless Subwoofer**  
**(PS-WK360)**  
**Wireless Receiver Module**  
**(SWA-8000S)**

**User manual**

**Wireless Audio - Soundbar**

**Imagine the possibilities**

Thank you for purchasing this Samsung product.  
To receive more complete service, please register your product at  
[www.samsung.com/register](http://www.samsung.com/register)

# FEATURES

## Samsung Remote App

Hold the control of your Soundbar in the palm of your hand with an Android smart device and the Samsung Audio Remote app. This convenient app lets you control all the Soundbar's basic functions such as power, volume, and the media controls, and lets you control customizable functions such as the equalizer.

## Surround Sound Expansion

The Surround Sound Expansion feature adds depth and spaciousness to your listening experience.

## TV SoundConnect

Listen to TV audio through the Soundbar by connecting your TV and the Soundbar via Bluetooth with TV SoundConnect. Easy connectivity and the absence of trailing wires between the Soundbar and TV allows you to showcase the slim and sleek design of both systems, while maintaining a clean look in your living environment. Easily control the Soundbar and TV from a single TV remote.

## USB Host Support

You can connect and play music files from external USB storage devices such as MP3 players, USB flash memory, etc. using the Soundbar's USB HOST function.

## Bluetooth Function

You can connect a Bluetooth device to the Soundbar and enjoy music with high quality stereo sound, all without wires!

## LICENSES



Manufactured under license from Dolby Laboratories. Dolby and the double-D symbol are trademarks of Dolby Laboratories.



For DTS patents, see <http://patents.dts.com>.  
Manufactured under license from DTS Licensing Limited. DTS, the Symbol, & DTS and the Symbol together are registered trademarks, and DTS 2.0 Channel is a trademark of DTS, Inc. © DTS, Inc. All Rights Reserved.





# SAFETY INFORMATION







- The following also applies to the Wireless Subwoofer (PS-WK360) and the SWA-8000S.

## SAFETY WARNINGS

TO REDUCE THE RISK OF ELECTRIC SHOCK, DO NOT REMOVE THE COVER (OR BACK).  
NO USER-SERVICEABLE PARTS ARE INSIDE. REFER SERVICING TO QUALIFIED SERVICE PERSONNEL.

	<b>CAUTION</b> <b>RISK OF ELECTRIC SHOCK.</b> <b>DO NOT OPEN.</b>			The lightning flash and arrowhead within the triangle indicates that there is dangerous voltage inside the product.
				The exclamation point within the triangle indicates that there are important instructions accompanying the product.

	Class II product : This symbol indicates that a safety connection to electrical earth (ground) is not required.
	AC voltage : Rated voltage marked with this symbol is AC voltage
	DC voltage : Rated voltage marked with this symbol is DC voltage.
	Caution. Consult instructions for use : This symbol instructs the user to consult the user manual for further safety related information.

### WARNING

- To reduce the risk of fire or electric shock, do not expose this apparatus to rain or moisture.
- To prevent injury, this apparatus must be securely attached to the floor/wall in accordance with the installation instructions.
- This product contains chemicals known to the State of California to cause cancer and birth defects or other reproductive harm.

### CAUTION

- Do not expose this apparatus to dripping or splashing. Do not put objects filled with liquids, such as vases on the apparatus.
- To turn this apparatus off completely, you must pull the power plug out of the wall socket. Consequently, the power plug must be easily and readily accessible at all times.

This product satisfies FCC regulations when shielded cables and connectors are used to connect the unit to other equipment. To prevent electromagnetic interference with electric appliances, such as radios and televisions, use shielded cables and connectors for connections.

FCC NOTE (for U.S.A.):

This equipment has been tested and found to comply with the limits for a Class B digital device, pursuant to Part 15 of the FCC Rules. These limits are designed to provide reasonable protection against harmful interference in a residential installation.

This equipment generates, uses and can radiate radio frequency energy and, if not installed and used in accordance with the instructions, may cause harmful interference to radio communications. However, there is no guarantee that interference will not occur in a particular installation.

If this equipment does cause harmful interference to radio or television reception, which can be determined by turning the equipment off and on, the user is encouraged to try to correct the interference by one or more of the following measures:

- Reorienting or relocating the receiving antenna.
- Increasing the separation between the equipment and receiver.
- Connecting the equipment to an outlet that is on a different circuit than the radio or TV.
- Consulting the dealer or an experienced radio/TV technician for help.

Caution : FCC regulations state that any unauthorized changes or modifications to this equipment may void the user's authority to operate it.

### Important Safety Instructions

Read these operating instructions carefully before using the unit. Follow all the safety instructions listed below. Keep these operating instructions handy for future reference.

- 1) Read these instructions.
- 2) Keep these Instructions.
- 3) Heed all warnings.
- 4) Follow all instructions.
- 5) Do not use this apparatus near water.
- 6) Clean only with a dry cloth.
- 7) Do not block any ventilation openings. Install in accordance with the manufacturer's instructions.
- 8) Do not install near any heat sources such as radiators, heat registers, stoves, or other apparatus (including amplifiers) that produce heat.
- 9) Do not defeat the safety purpose of the polarized or grounding-type plug. A polarized plug has two blades with one wider than the other. A grounding type plug has two blades and a third grounding prong. The wide blade or the third prong are provided for your safety. If the provided plug does not fit into your outlet, consult an electrician for replacement of the obsolete outlet.
- 10) Protect the power cord from being walked on or pinched particularly at plugs, convenience receptacles, and the point where they exit from the apparatus.
- 11) Only use attachments/accessories specified by the manufacturer.
- 12) Use only with the cart, stand, tripod, bracket, or table specified by the manufacturer, or sold with the apparatus. When a cart is used, use caution when moving the cart/apparatus combination to avoid injury from tip-over.
- 13) Unplug this apparatus during lightning storms or when unused for long periods of time.
- 14) Refer all servicing to qualified service personnel. Servicing is required when the apparatus has been damaged in any way, such as when the power-supply cord or plug is damaged, liquid has been spilled or objects have fallen into the apparatus, the apparatus has been exposed to rain or moisture, does not operate normally, or has been dropped.



## PRECAUTIONS

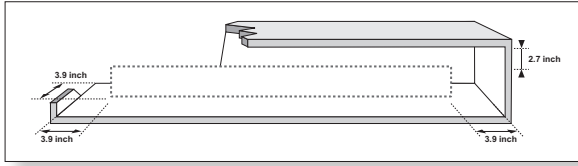

Ensure that the AC power supply in your house complies with the power requirements listed on the identification sticker located on the bottom of your product. Install your product horizontally, on a suitable base (furniture), with enough space around it for ventilation (3~4 inches). Make sure the ventilation slots are not covered. Do not place the unit on amplifiers or other equipment which may become hot. This unit is designed for continuous use. To fully turn off the unit, disconnect the AC plug from the wall outlet. Unplug the unit if you intend to leave it unused for a long period of time.

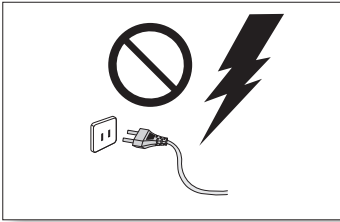

During thunderstorms, disconnect the AC plug from the wall outlet. Voltage peaks due to lightning could damage the unit.

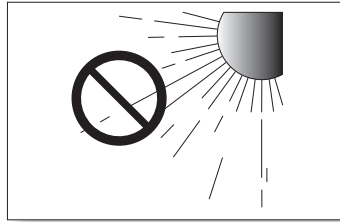

Do not expose the unit to direct sunlight or other heat sources. This could lead to overheating and cause the unit to malfunction.

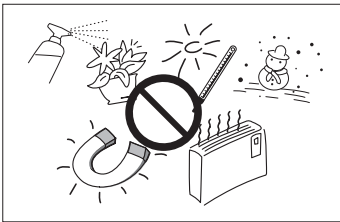

Protect the product from moisture (i.e. vases), and excess heat (e.g. a fireplace) or equipment creating strong magnetic or electric fields. Unplug the power cable from the AC wall socket if the unit malfunctions. Your product is not intended for industrial use. It is for personal use only. Condensation may occur if your product has been stored in cold temperatures. If transporting the unit during the winter, wait approximately 2 hours until the unit has reached room temperature before using.

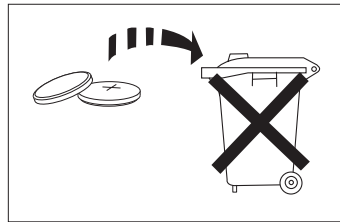

The battery used with this product contains chemicals that are harmful to the environment. Do not dispose of the battery in the general household trash. Do not expose the battery to excess heat, direct sunlight, or fire. Do not short circuit, disassemble, or overheat the battery. Danger of explosion if the battery is replaced incorrectly. Replace only with the same or equivalent type.



**WARNING: DO NOT INGEST BATTERY. CHEMICAL BURN HAZARD.** The remote control supplied with this product contains a coin/button cell battery. If the coin/button cell battery is swallowed, it can cause severe internal burns in just 2 hours and can lead to death. Keep new and used batteries away from children. If the battery compartment does not close securely, stop using the remote and make sure to keep it away from children. If you think the battery might have been swallowed or placed inside any part of the body, seek immediate medical attention.

# CONTENTS

## **2 GETTING STARTED**

- 2 Features
- 3 Safety Information
- 7 What's Included

## **8 DESCRIPTIONS**

- 8 Front / RIGHT SIDE Panel
- 9 Bottom Panel
- 10 Remote Control

## **13 INSTALLATION**

- 13 Installing the Soundbar
- 13 Installing the Wall Mount

## **18 CONNECTIONS**

- 18 **Connecting the Subwoofer and the SWA-8000S**
- 18 Connecting the Subwoofer and the SWA-8000S Automatically
- 18 Connecting the Subwoofer and the SWA-8000S Manually
- 19 Connecting the Surround Speakers
- 20 **Connecting to a TV**
- 20 Connecting to a TV Using a Digital Optical Cable
- 21 TV SoundConnect
- 23 **Connecting to External Devices**
- 23 Optical or Analog Audio Cable
- 24 USB

## **26 FUNCTIONS**

- 26 Input Mode
- 27 Bluetooth
- 30 Software Update

## **31 TROUBLESHOOTING**

- 31 Troubleshooting

## **32 APPENDIX**

- 32 Specifications



Figures and illustrations in this User Manual are provided for reference only and may differ from actual product appearance.

# WHAT'S INCLUDED

## BEFORE READING THE USER'S MANUAL

Note the following terms before reading the user manual.

### ► Icons used in this manual

Icon	Term	Definition
	<b>Caution</b>	Indicates a situation where a function does not operate or settings may be canceled.
	<b>Note</b>	Indicates tips or instructions on the page that help you operate a function.

Check for the supplied accessories shown below.



**Remote Control /  
Lithium Battery  
(3V : CR2032)**  
(AH59-02733B /  
4301-001042)



**Power Cord : 3 EA**  
(3903-000853)



**AC/DC Adapter: 2 EA**  
(BN44-00835A)

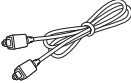

**Optical Cable**  
(AH39-00779A)



**Wall Mount Guide**  
(AH63-04369A)



**Holder-Screw: 2 EA**  
(AH61-04110A)



**Screw: 2 EA**  
(6003-001334)



**Bracket-Wall Mount L**  
(AH61-04106A)



**Bracket-Wall Mount R**  
(AH61-04114A)



- The appearance of the accessories may differ slightly from the illustrations above.
- Micro USB to USB adapter cable is sold separately. To purchase, contact a Samsung Service Center or Samsung Customer Care.

### ► Speaker Components



**Surround Speaker : 2 EA**



**Subwoofer**



**Speaker Cable : 2 EA**



**Wireless Receiver  
Module (SWA-8000S)**

# FRONT / RIGHT SIDE PANEL





## 1 + / - (Volume) Button

Controls the volume level.

The numeric value of the volume level appears in the front panel display.

## 2 (Source) Button

Selects the D.IN, AUX, BT, TV, or USB input.

- While the unit is powered on, pressing the  (Source) button for more than 3 seconds sets the button to act as the  (Mute) button. To cancel the  (Mute) button setup, press the  (Source) button for more than 3 seconds again.

## 3 (Power) Button

Turns the power on and off.

Right Side

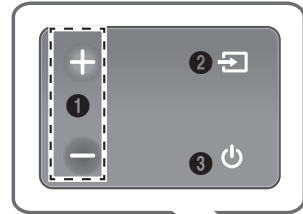

**Display** ■      ■ **Remote Control Sensor**

Displays the current mode.



- When you plug in the AC cord, the power button will begin working in 4 to 6 seconds.
- When you turn on this unit, there will be a 4 to 5 second delay before it produces sound.
- If you want to enjoy sound only from the Soundbar, you must turn off the TV's speakers in the Audio Setup menu of your TV. Refer to the owner's manual supplied with your TV.

# BOTTOM PANEL

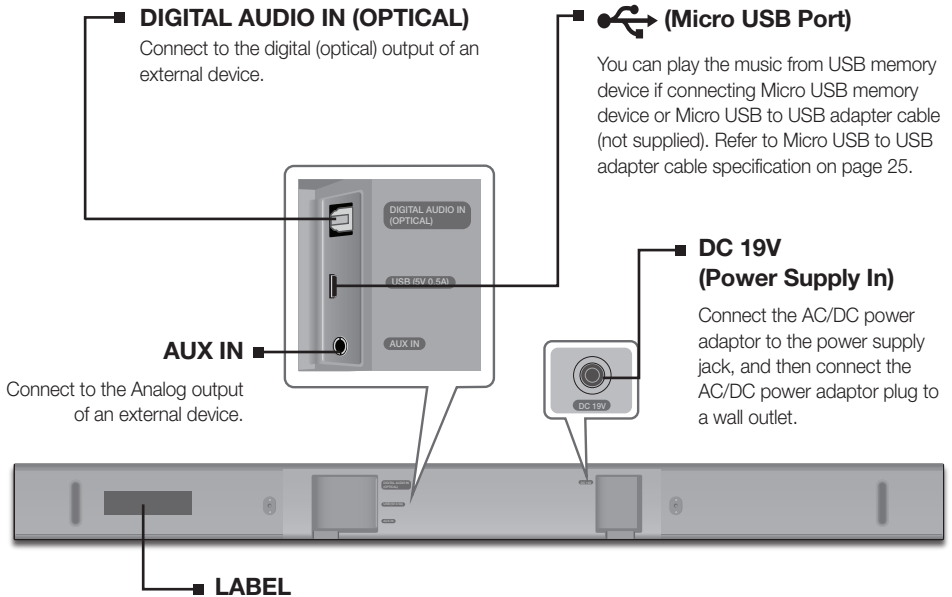

- When disconnecting the power cable of the AC/DC power adaptor from a wall outlet, pull the plug. Do not pull the cable.
- Do not connect this unit or other components to an AC outlet until all connections between components are complete.
- Make sure to rest the AC/DC Adapters flat on a table or the floor. If you place an AC/DC Adapter so that it is hanging with the AC cord input facing upwards, water or other foreign substances could enter the Adapter and cause the Adapter to malfunction.

# REMOTE CONTROL

**SOURCE**  
Press to select a source connected to the Soundbar.

**Mute**  
You can turn the volume down to 0 with the push of a button. Press again to restore the sound to the previous volume level.

**Repeat**  
Press to set the Repeat function during music playback from a USB device.  
**OFF - REPEAT** : Cancels Repeat Playback.  
**TRACK - REPEAT** : Plays a track repeatedly.  
**ALL - REPEAT** : Plays all tracks repeatedly.  
**RANDOM - REPEAT** : Plays tracks in random order. (A track that has already been played may be played again.)

**Skip Forward**  
If there is more than one file on the device you are playing, and you press the ►► button, the next file is selected.

**Bluetooth POWER**  
Press the **Bluetooth POWER** button on the remote to turn the Bluetooth POWER On function on and off. See pages 22 and 28 for details.

**(◐) SOUND**  
Surr.Sound adds depth and spaciousness to the sound. Pressing the **(◐) SOUND** button repeatedly cycles through the Surr.Sound settings : **ON - SURROUND SOUND, OFF - SURROUND SOUND**

Press and hold the ◀ button for about 5 seconds to turn the Auto Power Link function on or off.  
**OFF - POWER LINK, ON - POWER LINK**  
\* Auto Power Link  
Synchronizes the Soundbar to a connected Optical source via the Optical jack so it turns on automatically when you turn on your TV. (See page 20)  
• This function is only available in the D.IN mode.

**SOUND EFFECT**  
You can select from 6 different sound modes - **STANDARD (Original Sound), MUSIC, CLEAR VOICE, SPORTS, MOVIE, and NIGHT MODE** - depending on the content you want to listen to.  
Select the **STANDARD** mode if you want to enjoy the original sound.



- Soundbar is a Samsung proprietary name.
- Operate the TV using the TV's remote control.

**Power**  
Turns the Soundbar on and off.

**Volume**  
Adjusts the volume level of the unit.

**Play / Pause**  
Press the **▶||** button to pause a file temporarily.  
Press the **▶||** button again to play the selected file.

**Skip Back**  
If there is more than one file on the device you are playing, and you press the **◀◀** button, the previous file is selected.

**SOUND CONTROL**

Press to select **TREBLE**, **BASS**, **SUBWOOFER LEVEL**, **AUDIO SYNC**, **REAR SPEAKER**, or **REAR LEVEL**.

Then, use the **◀, ▶** buttons to adjust the Treble or Bass volume from -6 ~ +6, SUBWOOFER LEVEL volume from -12, -6 ~ +6.

Press and hold the **SOUND CONTROL** button for about 5 seconds to adjust the sound for each frequency band. 150Hz, 300Hz, 600Hz, 1.2KHz, 2.5KHz, 5KHz and 10KHz are selectable and each can be adjusted to a setting between -6 and +6.

- To adjust the woofer level using the Samsung Audio Remote mobile app, press the **◀◀, ▶▶** buttons to decrease or increase the woofer level within 3 seconds of pressing the **WOOFER** button.

If the Soundbar is connected to a digital TV and the video appears out of sync with the audio, press the **SOUND CONTROL** button to select **AUDIO SYNC** to sync the audio with the video. Use the **◀, ▶** buttons to set the audio delay between 0 ms and 300 ms. In USB mode, TV mode, and BT mode, the Audio Sync function is not available.

To control the volume of the rear speaker sound, select **REAR SPEAKER** in Sound Control, and then use the **◀, ▶** buttons to toggle the rear volume between OFF-RS and ON-RS.

To control the volume of the rear level sound, select **REAR LEVEL** in Sound Control, and then adjust the volume between RS -6~+6 using the **◀, ▶** buttons.

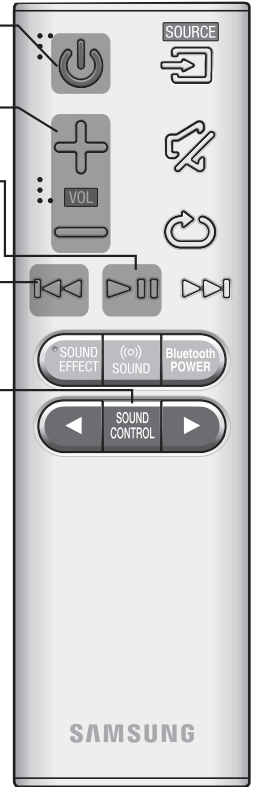

### ► Controlling the Soundbar using Your TV Remote Control

1. Press and hold the ((⦿)) **SOUND** button for more than 5 seconds while the Soundbar is turned on.
2. "ON - TV REMOTE" appears on the Soundbar's display.
3. In the TV's menu, set the TV speaker to external speaker.



- TV menus differ by manufacturer and model. Refer to the TV's user manual for further information.
- Only the VOLUME +/- and the MUTE buttons will be available to control the Soundbar.
- This function is not available when the Soundbar is in the TV SoundConnect mode.
- Manufacturers supporting this function:
  - VIZIO, LG, Sony, Sharp, PHILIPS, PANASONIC, TOSHIBA, GRUNDIG, Hisense, RCA
  - This function may not be compatible with your TV's remote depending on the remote control's manufacturer.
- To turn off this function, press the ((⦿)) **SOUND** button for 5 seconds. "OFF - TV REMOTE" appears on the Soundbar's display.

## INSTALLING THE BATTERY IN THE REMOTE CONTROL

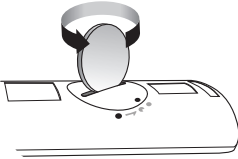

1. Use a suitable coin to turn the remote control's battery cover counterclockwise to remove it as shown in the figure above.

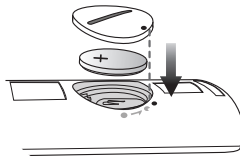

2. Insert a 3V lithium battery. Keep the positive (+) pole facing up when inserting the battery. Put the battery cover on and align the '•' marks side by side as shown in the figure above.

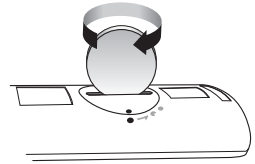

3. Use a suitable coin to turn the remote control battery cover clockwise as far as it will go to fix it in place.

# INSTALLING THE SOUNDBAR

## INSTALLING THE WALL MOUNT

### ► Installation Precautions

- Install on a vertical wall only.
- For the installation, avoid a location with high temperature or humidity, or a wall that cannot sustain the weight of the set.
- Check the strength of the wall. If the wall is not strong enough to support the unit, reinforce the wall or install the unit on a different wall that can support the unit's weight.
- Purchase and use the fixing screws or anchors appropriate for the kind of wall you have (plaster board, iron board, wood, etc.). If possible, fix the support screws into wall studs.
- Purchase wall mounting screws according to the type and thickness of the wall you will mount the Soundbar on.
  - Diameter: M5
  - Length: 1 3/8 inches or longer recommended.
- Connect cables from the unit to external devices before you install it on the wall.
- Make sure the unit is turned off and unplugged before you install it. Otherwise, it may cause an electric shock.

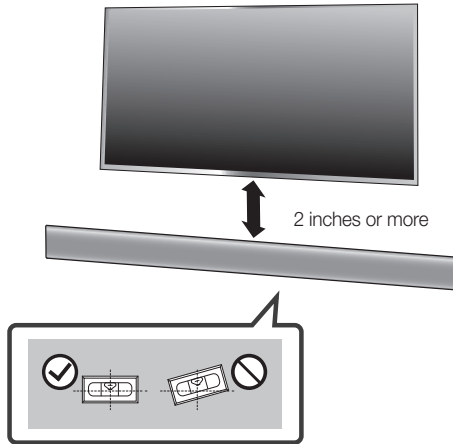

1. Place the **Wall Mount Guide** against the wall surface.
  - The **Wall Mount Guide** must be level.
  - If your TV is mounted on the wall, install the Soundbar at least 2 inches (5 cm) below the TV.

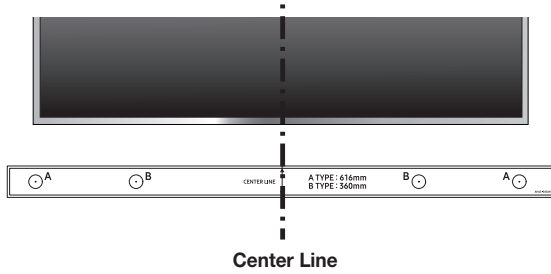

2. Align the Wall Mount Guide's **Center Line** with the center of your TV (if you are mounting the Soundbar below your TV), and then fix the **Wall Mount Guide** to the wall using tape.



- If you are not mounting below a TV, place the **Center Line** in the center of the installation area.

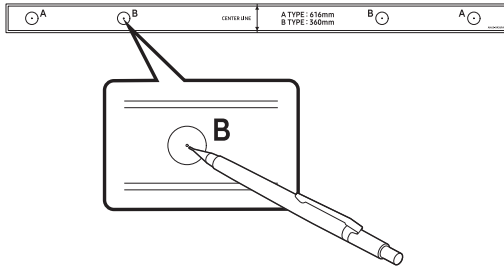

3. Push a pen tip or sharpened pencil tip through the center of the **B-TYPE** images on each end of the Guide to mark the holes for the supporting screws, and then remove the **Wall Mount Guide**.
4. Using an appropriately sized drill bit, drill a hole in the wall at each marking.



- If the markings do not correspond to the positions of studs, make sure you insert appropriate anchors or mollies into the holes before you insert the support screws. If you use anchors or mollies, make sure the holes you drill are large enough for the anchors or mollies you use.

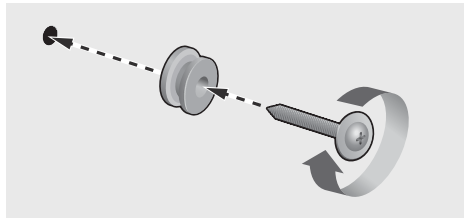

5. Push a screw (not supplied) through each **Holder-Screw**, and then screw each screw firmly into a support screw hole.

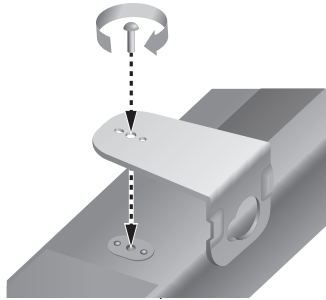

6. Use the two **Screws** (M4 x L14) to attach both **Bracket-Wall Mount L** and **R** to the Soundbar's bottom. For a proper fit, make sure to align the bumps on the Soundbar to the holes on the brackets.

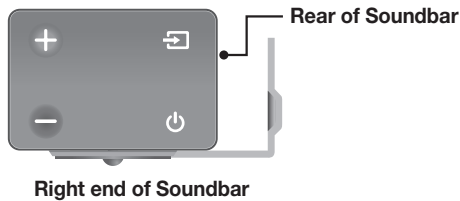

- When assembling, make sure the hanger part of the **Bracket-Wall Mounts** are located behind the rear of the Soundbar. See the illustration above.



- The left and right mounts are different shapes. Make sure to position them correctly.

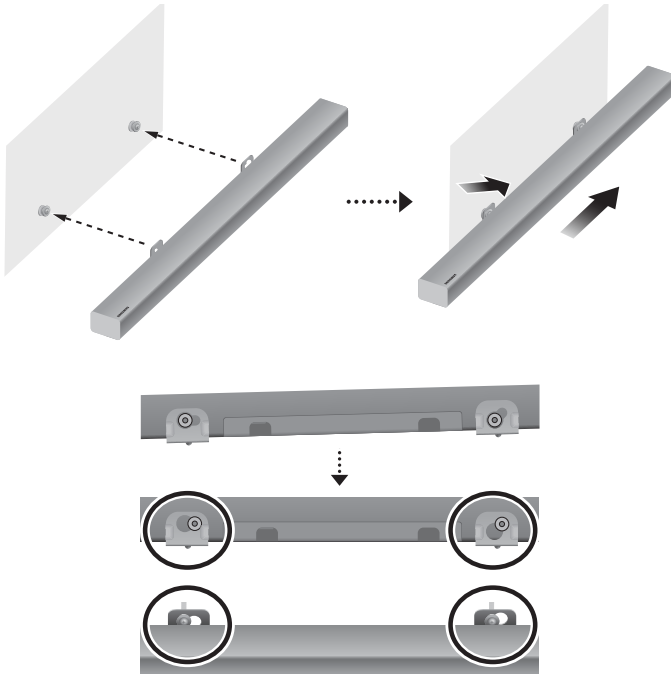

7. Install the Soundbar with the attached **Bracket-Wall Mounts** by hanging the **Bracket-Wall Mounts** on the **Holder-Screws** on the wall.



- Slightly tilt the Soundbar to insert both **Holder-Screw** heads into the **Bracket-Wall Mount** holes. Push the Soundbar in the direction of the arrow to make sure both sides are firmly fixed.

## DETACHING THE SOUNDBAR FROM THE WALL

1. To separate the Soundbar from the wall, push it in the direction of the arrow, tilt the Soundbar slightly, and then pull it away from the wall as shown.

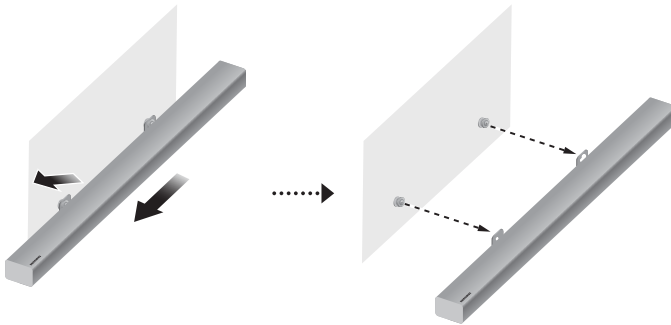

- Do not hang onto the installed unit and avoid striking or dropping the unit.
- Secure the unit firmly to the wall so that it does not fall off. If the unit falls off, it may cause an injury or damage the product.
- When the unit is installed on a wall, please make sure that children do not pull any of the connecting cables, as this may cause it to fall.
- For the optimal performance of a wall mount installation, install the speaker system at least 2 inches (5 cm) below the TV, if the TV is mounted on the wall.
- For your safety, if you do not mount the unit on the wall, install it on a secure, flat surface where it is unlikely to fall.







- Do not connect the power cord of this product or your TV to a wall outlet until all connections between components are complete.
- Before moving or installing this product, be sure to turn off the power and disconnect the power cord.

# CONNECTING THE SUBWOOFER AND THE SWA-8000S

## CONNECTING THE SUBWOOFER AND THE SWA-8000S AUTOMATICALLY

The linking IDs of the SWA-8000S wireless module and the subwoofer are preset at the factory. The subwoofer and the SWA-8000S should link (connect wirelessly) to the main unit automatically when you turn on the main unit, the subwoofer, and the SWA-8000S. Indicator LEDs on the rear of the subwoofer and SWA-8000S indicate the following:

<b>1</b>	<b>blue</b> 	Auto-connection is complete.
<b>2</b>	<b>blue blinking</b> 	Auto-connection is not complete.
<b>3</b>	<b>blue is not lit</b> 	<ol style="list-style-type: none"> <li>Is the power cord plugged into the outlet? If not, connect the power plug to the outlet.</li> <li>If the power cord is plugged in correctly, check the main unit. If your main unit is off (in standby mode), the subwoofer will also be in standby mode and the blue LED won't be lit.</li> </ol>
<b>4</b>	<b>red</b> 	<ol style="list-style-type: none"> <li>If your main unit is off (in standby mode), the SWA-8000S will also be in standby mode and the red LED will light. (SWA-8000S only)</li> </ol>



- When the subwoofer and the SWA-8000S are completely connected, the blue LED Link indicators on the subwoofer and the SWA-8000S stop blinking.

## CONNECTING THE SUBWOOFER AND THE SWA-8000S MANUALLY



If the blue LEDs do not stop blinking when the main unit, subwoofer, and SWA-8000S are turned on, please reset the linking ID by following the procedure below.

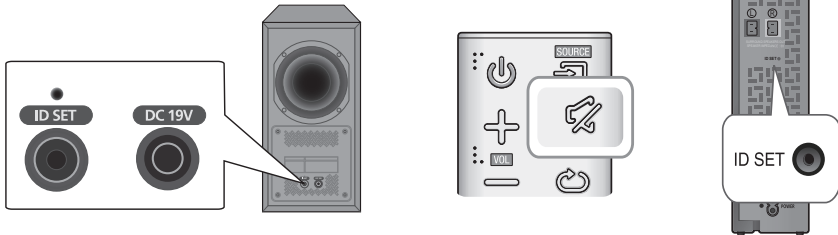

- Important: Before you begin, put the battery into the remote. See page 12 for instructions.



1. Plug the power cords of the main unit, subwoofer and the SWA-8000S into an AC wall outlet.
2. Press the **ID SET** button on the rear of the subwoofer and the SWA-8000S with a small, pointed object for 5 seconds.
  - The LINK indicators (Blue LEDs) on the subwoofer and the SWA-8000S blink quickly.

3. Press the  button on your remote control for 5 seconds while the main unit is turned OFF.
4. The ID SET message appears on the display of the main unit for a short period of time, and then disappears.
5. While the subwoofer's and the SWA-8000S's indicators are blinking blue, press the  button on your remote control or on the right side of the main unit to turn on the main unit.
6. The connection is complete if the blue LEDs on the subwoofer and the SWA-8000S stop blinking and glow continuously.
  - The main unit, the subwoofer and the SWA-8000S should now be linked (connected).
  - The LINK indicators (Blue LEDs) on the subwoofer and the SWA-8000S should be glowing continuously and not blinking.
  - If the LINK indicators are not solid blue, the linking process has failed. Turn off the main unit and start again from Step 2.
  - You can enjoy better sound from the wireless subwoofer by selecting a Sound Effect. (See page 10)



- Before moving or installing the product, be sure to turn off the power and disconnect the power cord.
- If you use a device that uses the same frequency (2.4GHz) as the Soundbar near the Soundbar, interference may cause some sound interruption.
- The maximum transmission distance of the wireless signal between the main unit and subwoofer is about 32.8 ft, but may vary depending on your operating environment. If a steel-concrete or metallic wall is between the main unit and the wireless subwoofer, the system may not operate at all because the wireless signal cannot penetrate metal.
- If the main unit doesn't make a wireless connection, repeat steps 1-6 starting on the previous page to re-set the connection between the main unit and wireless subwoofer.



- The wireless receiving antenna is built into the wireless subwoofer. Keep the unit away from water and moisture.
- For optimal listening performance, make sure that the area around the wireless subwoofer location is clear of any obstructions.

## CONNECTING THE SURROUND SPEAKERS

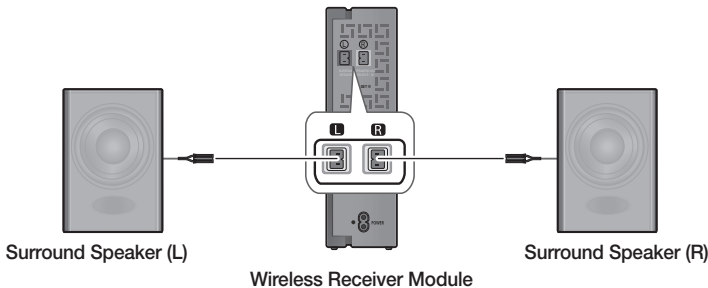

- Place these speakers to the side of your listening position. If there isn't enough room, place these speakers so they face each other. Position them about 2 to 3 feet above your ear, facing slightly downward.



- Surround speakers must be connected to the wireless receiver module.
- Each speaker has a colored label on its back or underside. Each cable has a single colored band near its end. Match the band on each cable to the speaker label by color, and then connect the cable to the speaker.

# CONNECTING TO A TV



- Important: Before you begin, put the battery into the remote. See page 12 for instructions.

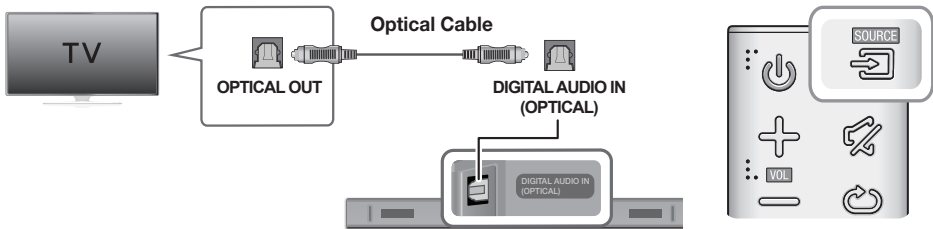

## CONNECTING TO A TV USING A DIGITAL OPTICAL CABLE



1. Connect the **DIGITAL AUDIO IN (OPTICAL)** jack on the Soundbar to the OPTICAL OUT jack of the TV with a digital optical cable.
2. Press the  (Source) button on the right side of the Soundbar or the **SOURCE** button on the remote control to select the **D.IN** mode.

### ► Auto Power Link

If you have connected the main unit to a TV with a digital optical cable, you can set Auto Power Link to ON and have the Soundbar turn on automatically when you turn the TV on.

1. Connect the Soundbar and a TV with a digital optical cable.
2. Press the  (Source) button on the main unit's right side or the **SOURCE** button on the remote control to select the **D.IN** mode.
3. Press and hold the  button on the remote control for about 5 seconds to toggle the Auto Power Link function on or off.



- Depending on the connected device, Auto Power Link may not function.
- This function is only available when the Soundbar is in the D.IN mode.

## TV SOUNDCONNECT

You can enjoy TV sound through your Soundbar when it is connected to a Samsung TV that supports the TV SoundConnect function.



1. Turn on the TV and Soundbar.
2. Press the  button on the main unit's right side or the **SOURCE** button on the remote control to select the **TV** mode.
3. On the TV, a message asking whether to enable the TV SoundConnect function appears.
4. Select **<Yes>** using the TV's remote control to finish connecting the TV and Soundbar.



- Switching the Soundbar's mode from TV to another mode automatically terminates TV SoundConnect.
- To connect the Soundbar to another TV, the existing connection must be terminated.
- To terminate the existing connection, press and hold the **▶||** button on the remote for 5 seconds or switch to another mode. To connect to the other TV, follow Steps 1 through 4 above.



- The TV SoundConnect (SoundShare) function is supported by some Samsung TVs released from 2012 on. Check whether your TV supports the TV SoundConnect (SoundShare) function before you begin. (For further information, refer to the TV's user manual.)
- If your Samsung TV was released before 2014, check the SoundShare setting menu.
- If the distance between the TV and Soundbar exceeds 16.4 ft, the connection may not be stable or the audio may stutter. If this occurs, relocate the TV or Soundbar so that they are within operational range, and then re-establish the TV SoundConnect connection.
- TV SoundConnect Operational Ranges:
  - Recommended pairing range: within 78.7 inches (within 2 m).
  - Recommended operational range: within 16.4 ft. (5 m).
- The Play/Pause, Next, and Prev buttons on the Soundbar or Soundbar's remote do not control the TV.

### ► Using the Bluetooth POWER On function

The Bluetooth POWER On function is available after you have successfully connected the Soundbar to a Bluetooth compatible TV using TV SoundConnect. When the Bluetooth POWER On function is ON, turning the connected TV on or off will turn the Soundbar's power on and off as well.

1. Connect the TV to your Soundbar using the TV SoundConnect function.
2. Press the **Bluetooth POWER** button on the Soundbar remote. **ON - BLUETOOTH POWER** appears on the Soundbar's display.
  - **ON - BLUETOOTH POWER** : The Soundbar turns on and off when you turn the TV on or off.
  - **OFF - BLUETOOTH POWER** : The Soundbar only turns off when you turn the TV off.



- This function is supported by some Samsung TVs released from 2013 on.
-

# CONNECTING TO EXTERNAL DEVICES

## OPTICAL OR ANALOG AUDIO CABLE

This unit comes equipped with one digital optical in jack and one analog audio (AUX) in jack, giving you two ways to connect it to external devices.

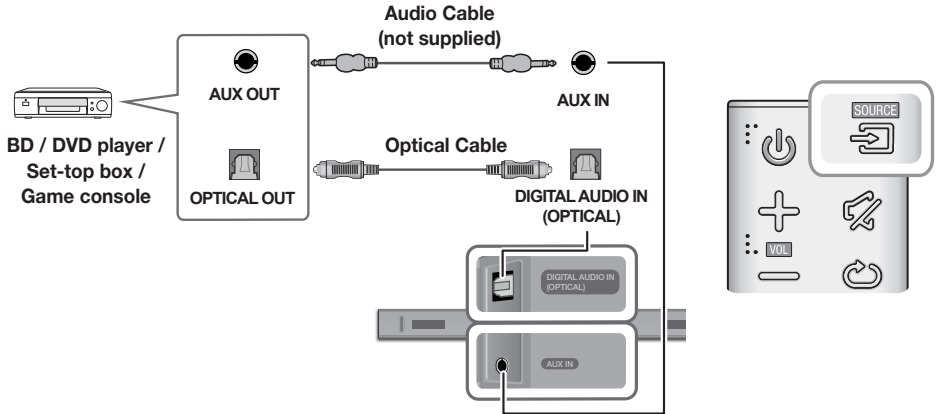

### ► AUX Cable

1. Connect **AUX IN** (Audio) on the main unit to the AUDIO OUT jack of the Source Device using an audio cable.
2. Press the  (Source) button on the right side of the Soundbar or the **SOURCE** button on the remote control to select the **AUX** mode.

### ► Optical Cable

1. Connect **DIGITAL AUDIO IN** (Audio) on the main unit to the OPTICAL OUT jack of the Source Device using a digital optical cable.
2. Press the  (Source) button on the right side of the Soundbar or the **SOURCE** button on the remote control to select the **D.IN** mode.

## USB

You can play music files located on USB storage devices through the Soundbar.

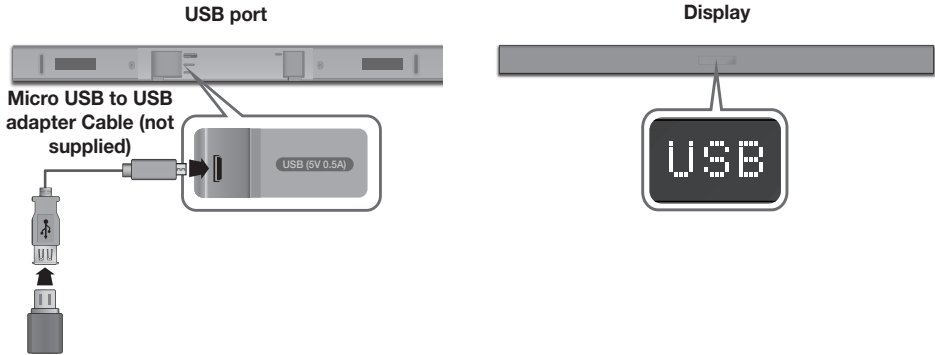

1. Connect a Micro USB to USB adapter cable with a male USB 2.0 Micro USB plug (Type B) on one end and a standard female 2.0 USB jack (Type A) on the other end to the micro USB jack on your Soundbar.



- The Micro USB to USB adapter cable is sold separately. To purchase, contact a Samsung Service Center or Samsung Customer Care.

2. Connect your USB device to the female end of the adapter cable.
3. Press the  button on the main unit's right side or the **SOURCE** button on the remote control to select the **USB** mode.
4. **USB** appears on the display screen.
  - The Soundbar connection to the USB device is complete.
  - The Soundbar automatically turns off (Auto Power Off) if no USB device has been connected for more than 5 minutes.

### ► Before you connect a USB device

Be aware of the following:

- If the file name of a file on a USB device exceeds 10 characters, it is not displayed on the Soundbar's display.
- This product may not be compatible with certain types of USB storage media.
- The Soundbar supports the FAT16 and FAT32 file systems.
  - The NTFS file system is not supported.
- Connect USB devices to the USB port of the product using a USB 2.0 Micro USB plug to standard female 2.0 USB jack adapter cable. Otherwise, you may encounter a USB compatibility problem.
- Do not connect multiple storage devices to the product via a multi-card reader. It may not operate properly.
- Digital camera PTP protocols are not supported.
- Do not remove the USB device while it is transferring files.
- DRM-protected music files (MP3, WMA) from commercial web sites cannot be played.
- External HDDs are not supported.
- Mobile phone devices are not supported.

- File Format Type Compatibility list:

Extension	Codec	Sampling Rate	Bitrate
*.mp3	MPEG 1 Layer2	16KHz ~ 48KHz	80kbps~320kbps
	MPEG 1 Layer3	16KHz ~ 48KHz	80kbps~320kbps
	MPEG 2 Layer3	16KHz ~ 48KHz	80kbps~320kbps
	MPEG 2.5 Layer3	16KHz ~ 48KHz	80kbps~320kbps
*.wma	Wave_Format_MSAudio1	16KHz ~ 48KHz	56kbps~128kbps
	Wave_Format_MSAudio2	16KHz ~ 48KHz	56kbps~128kbps
*.aac	AAC	16KHz ~ 96KHz	48kbps~320kbps
	AAC-LC	16KHz ~ 96KHz	128kbps~192kbps 5.1ch 320kbps
	HE-AAC	24KHz ~ 96KHz	48kbps~64kbps 5.1ch 160kbps
*.wav	-	16KHz ~ 48KHz	up to 3000kbps
*.ogg	OGG 1.1.0	16KHz ~ 48KHz	50kbps~500kbps
*.flac	FLAC 1.1.0, FLAC 1.2.1	16KHz ~ 96KHz	up to 3000kbps



- If there are too many folders and files stored on the USB device, it may take the Soundbar some time to access and play files.

# INPUT MODE

Press the  (Source) button on the main unit's right side or the **SOURCE** button on the remote control to select the mode you want.

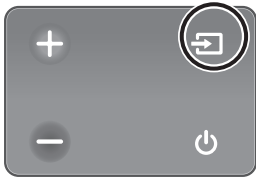

**Right Side of the Soundbar**

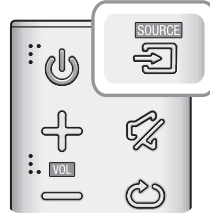

Input mode	Display
Optical Digital input	<b>D.IN</b>
AUX input	<b>AUX</b>
BLUETOOTH mode	<b>BT</b>
TV SoundConnect	<b>TV</b>
USB mode	<b>USB</b>

## AUTO POWER DOWN FUNCTION

The unit turns off automatically in the following situations.

- D.IN / BT / TV / USB Mode
  - If there is no audio signal for 5 minutes.
- AUX Mode
  - If the AUX cable is disconnected for 5 minutes.
  - If there is no KEY input for 8 hours when the AUX cable is connected.

To turn the Auto Power Down function ON or OFF, press and hold the **▶||** button for 5 seconds.

**ON - AUTO POWER DOWN / OFF - AUTO POWER DOWN** appears on the display.

# BLUETOOTH

You can connect a Bluetooth device to the Soundbar and enjoy music with high quality stereo sound, all without wires!

## TO CONNECT THE SOUNDBAR TO A BLUETOOTH DEVICE

Check if the Bluetooth device supports the Bluetooth compliant stereo headset function.

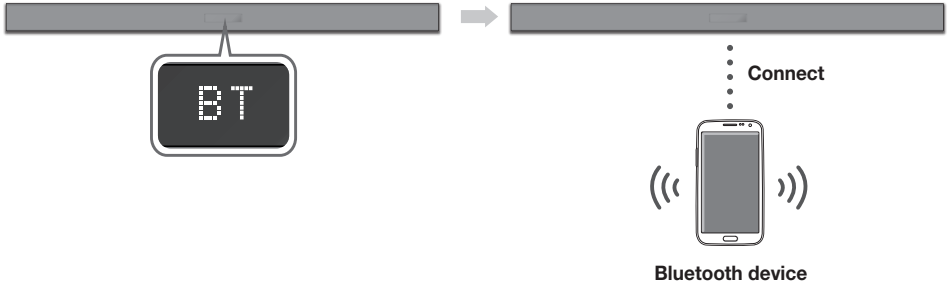

- Press the  (Source) button on the main unit's right side or the **SOURCE** button on the remote control to select the **BT** mode.
  - You will see **BT READY** on the front display of the Soundbar.
- Select the Bluetooth menu on the Bluetooth device you want to connect. (Refer to the Bluetooth device's user manual.)
- Select the Stereo headset menu on the Bluetooth device.
  - You will see a list of scanned devices.
- Select "**[AV] Samsung Soundbar Kxxx K-Series**" from the list.
  - When the Soundbar is connected to the Bluetooth device, it will display **[Bluetooth device name] → BT** on the front display.
  - The device name can only be displayed in English. An underline " \_ " will be displayed if the name is not in English.
  - If the Bluetooth device has failed to pair with the Soundbar, delete the previous Soundbar listing found by the Bluetooth device and have it search for the Soundbar again.
- Play music on the connected device.
  - You can listen to the music playing on the connected Bluetooth device over the Soundbar.
  - In **BT** mode, the Play / Pause / Next / Prev functions are not available. However, these functions are available on Bluetooth devices supporting AVRCP.



- If asked for a PIN code when connecting a Bluetooth device, enter <0000>.
- Only one Bluetooth device can be paired at a time.
- The Bluetooth connection will be terminated when you turn the Soundbar off.
- The Soundbar may not perform Bluetooth search or connection correctly under the following circumstances:
  - If there is a strong electrical field around the Soundbar.
  - If several Bluetooth devices are simultaneously paired with the Soundbar.
  - If the Bluetooth device is turned off, not in place, or malfunctions.
- Note that such devices as microwave ovens, wireless LAN adaptors, fluorescent lights, and gas stoves use the same frequency range as the Bluetooth device, which can cause electric interference.
- The Soundbar supports SBC data (44.1kHz, 48kHz).
- Connect only to a Bluetooth device that supports the A2DP (AV) function.
- You cannot connect the Soundbar to a Bluetooth device that supports only the HF (Hands Free) function.
- Once the set has been paired with a device, if the soundbar is in DIN, AUX, or USB mode and you select “[AV]samsung soundbar Kxxx K-ser” from your Bluetooth device’s list, the set will automatically change to BT mode.
  - Available only if the Soundbar is listed among the Bluetooth device’s paired devices. (The Bluetooth device and the Soundbar must have been previously paired at least once.)
- Soundbar will appear in the Bluetooth device’s searched devices list only when the Soundbar is displaying **BT READY**.
- In the TV SoundConnect mode, the Soundbar cannot be paired or connected to Bluetooth device.

## BLUETOOTH POWER ON (BLUETOOTH POWER)

If a previously paired Bluetooth device tries to pair with the Soundbar when the Bluetooth POWER On function is on and the Soundbar is turned off, the Soundbar turns on automatically.

1. Press the **Bluetooth POWER** button on the remote while the Soundbar is turned on.
2. **ON - BLUETOOTH POWER** appears on the Soundbar’s display.

## TO DISCONNECT A BLUETOOTH DEVICE FROM THE SOUNDBAR

You can disconnect a Bluetooth device from the Soundbar. For instructions, see the Bluetooth device’s user manual.

- The Soundbar will be disconnected.
- When the Soundbar is disconnected from the Bluetooth device, the Soundbar will display **BT DISCONNECTED** on the front display.

## TO DISCONNECT THE SOUNDBAR FROM A BLUETOOTH DEVICE

Press the **SOURCE** button on the remote control or the  (Source) button on the product’s right side to switch from **BT** to another mode or turn off the Soundbar.

- The connected Bluetooth device will wait a certain amount of time for a response from the Soundbar before terminating the connection. (Disconnection time may differ, depending on the Bluetooth device)



- In Bluetooth connection mode, the Bluetooth connection will be lost if the distance between the Soundbar and the Bluetooth device exceeds 16.4 ft (5 m).
- The Soundbar automatically turns off after 5 minutes in the Ready state.

### ► More About Bluetooth

Bluetooth is a technology that enables Bluetooth-compliant devices to interconnect easily with each other using a short wireless connection.

- A Bluetooth device may cause noise or malfunction, depending on usage, if:
  - A part of your body is in contact with the receiving/transmitting system of the Bluetooth device or the Soundbar.
  - It is subject to electrical variation from obstructions caused by a wall, corner, or office partition.
  - It is exposed to electrical interference from same frequency-band devices including medical equipment, microwave ovens, and wireless LANs.
- Pair the Soundbar with the Bluetooth device while they are close together.
- The further the distance between the Soundbar and Bluetooth device, the worse the quality is. If the distance exceeds the Bluetooth operational range, the connection is lost.
- In poor reception areas, the Bluetooth connection may not work properly.
- The Bluetooth connection only works when it is close to the unit. The connection will be automatically cut off if the Bluetooth device is out of range. Even within range, the sound quality may be degraded by obstacles such as walls or doors.
- This wireless device may cause electric interference during its operation.

## USING THE SAMSUNG AUDIO REMOTE APP

### ► Installing the Samsung Audio Remote App

To control the Soundbar with your smart device and the Samsung Audio Remote app, download the Samsung Audio Remote app from the Google Play store.

Market search : Samsung Audio Remote



### ► Launching the Samsung Audio Remote App

To launch and use the Samsung Audio Remote app, touch the Audio Remote icon on your smart device, and then follow the directions on the screen.



- The Samsung Audio Remote app is only compatible with Android mobile phones and mobile devices running Android OS 3.0 or later.

# SOFTWARE UPDATE

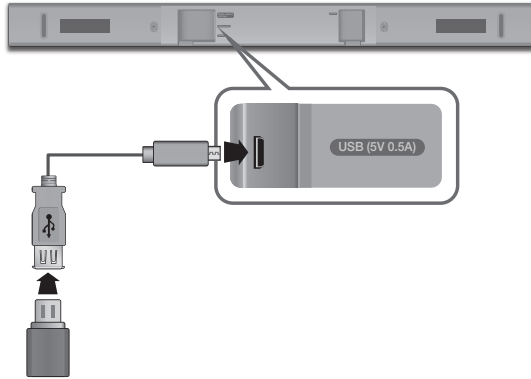

Samsung may offer updates for the Soundbar's system firmware in the future.

If an update is offered, you can update the firmware by connecting a USB device with the firmware update stored on it to the USB port on your Soundbar.

Note that if there are multiple update files, you must load them onto the USB device singly and use them to update the firmware one file at a time.

Please visit [samsung.com](http://samsung.com) or contact the Samsung call center to receive more information about downloading update files.



- This product has a DUAL BOOT function. If the firmware fails to update, you can update the firmware again.



- Connect a USB device containing the firmware upgrade to the standard end of a USB standard jack to USB Micro plug Adapter cable. Connect the USB Micro plug end of the cable to the USB jack on the main unit.
- Updating firmware may not work properly if audio files supported by the Soundbar are stored in the USB storage device.
- Do not disconnect the power or remove the USB device while updates are being applied. The main unit will turn off automatically after completing the firmware update.
- After the update, all settings are reset to their factory default settings. We recommend you write down your settings so that you can easily reset them after the update. Note that updating firmware resets the subwoofer connection too.

If the connection to the subwoofer is not re-established automatically after the update, refer to page 18.

If the firmware fails to update, we recommend formatting the USB device in FAT16 and trying again.

- Once the software update is completed, turn off the product and then press and hold the (▶||) button on the remote control for more than 5 seconds. "INIT" appears on the display and the unit is powered off. The upgrade is complete.
- Do not format the USB device in the NTFS format. The Soundbar does not support the NTFS file system.
- Depending on the manufacturer, some USB devices may not be supported.

# TROUBLESHOOTING

Refer to the table below if this product does not function properly. If the problem you are experiencing is not listed below or if the instructions below do not help, turn off the product, disconnect the power cord, and contact Samsung Electronics at 1-800-SAMSUNG (1-800-726-7864).

## The unit will not turn on.

- |  |   |
|--|---|
| • Is the power cord plugged into the outlet? | → Connect the power plug to the outlet. |
|--|---|

## A function does not work when the button is pressed.

- |   |   |
|---|---|
| • Is there static electricity in the air? | → Disconnect the power plug and connect it again. |
|---|---|

## Sound is not produced.

- |                                 |  |
|---------------------------------|--|
| • Is the Mute function on?      | → Press the  (Mute) button to cancel the Mute function.<br>→ Adjust the volume. |
| • Is the volume set to minimum? |  |

## The remote control does not work.

- |   |                               |
|---|-------------------------------|
| • Are the batteries drained?  | → Replace with new batteries. |
| • Is the distance between the remote control and main unit too far? | → Move closer to the unit.    |

## The TV SoundConnect (TV pairing) failed.

- |   |   |
|---|---|
| • Does your TV support TV SoundConnect?   | → TV SoundConnect is supported by some Samsung TVs released from 2012 on. Check your TV to see if it supports TV SoundConnect.  |
| • Is your TV firmware the latest version? | → Update your TV with the latest firmware.  |
| • Does an error occur when connecting?    | → Contact the Samsung Call Center.<br>→ Reset TV SoundConnect and connect again.<br>To reset the TV SoundConnect connection, press and hold the  button for 5 seconds. |

## The blue indicator on the rear of the subwoofer is not lit and the subwoofer is not producing sound.

- |  |   |
|--|---|
| • Is the main unit power on?   | → Check the power cord. If the power cord is plugged in correctly, check the main unit. If your main unit is off (in standby mode), the subwoofer will also be in standby mode and the blue LED won't be lit. |
| • Your subwoofer may not be connected to the main unit of the product. | → Try to connect your subwoofer again.<br>(See Page 18)   |

# SPECIFICATIONS

Model name		HW-K370, HW-KM37, HW-KM37C	
GENERAL	USB		5V / 0.5A
	Weight	Main Unit	3.3 lbs (1.5 Kg)
		Subwoofer (PS-WK360)	6.4 lbs (2.9 Kg)
		Surround Speaker	1.1 lbs (0.5 Kg)
		Rear (Surround) AMP (SWA-8000S)	1.8 lbs (0.8 Kg)
	Dimensions (W x H x D)	Main Unit	35.7 x 2.1 x 2.8 inches (907.5 x 53.5 x 70.5 mm)
		Subwoofer (PS-WK360)	6.1 x 11.8 x 11.5 inches (155.0 x 300.0 x 293.0 mm)
		Surround Speaker	3.0 x 5.0 x 3.0 inches (76.2 x 126.9 x 76.2 mm)
		Rear (Surround) AMP (SWA-8000S)	2.0 x 7.9 x 5.2 inches (50.0 x 201.3 x 132.0 mm)
	Operating Temperature Range		+41°F to +95°F
Operating Humidity Range		10 % to 75 %	
AMPLIFIER	Rated Output Power	Main Unit	35 W/CH x 2, 6 ohm, THD=10%, 1 kHz
		Subwoofer (PS-WK360)	60 W, 3 ohm, THD=10%, 100 Hz
		Rear (Surround) AMP (SWA-8000S)	35 W/CH x 2, 3 ohm, THD=10%, 1 kHz
	S/N Ratio (Analog Input)		65 dB
	Separation (1 kHz)		65 dB

\* Design and specifications are subject to change without prior notice.

\* S/N ratio, distortion, separation, and usable sensitivity are based on measurements using AES (Audio Engineering Society) guidelines.

\* Nominal specification

- Samsung Electronics Co., Ltd reserves the right to change the specifications without notice.
- Weight and dimensions are approximate.
- For more information about the power supply and power consumption, refer to the label attached to the product.
- Dispose unwanted electronics through an approved recycler. To find the nearest recycling location, go to our website: [www.samsung.com/recyclingdirect](http://www.samsung.com/recyclingdirect) or call (877) 278 - 0799.

## ※ Open Source License Notice

- To send inquiries and requests regarding open sources, contact Samsung via Email ([oss.request@samsung.com](mailto:oss.request@samsung.com)).

**※ Important Note About Service**

- An administration fee may be charged if either:
  - a. An engineer is called out to your home at your request and there is no defect in the product.
  - b. You bring the unit to a repair center and there is no defect in the product.
- You will be advised of the amount of the administration fee before any work is done or a home visit is made.
- If you have a problem with this product, we strongly recommend you read the appropriate section of this manual, review the Troubleshooting section on page 31, visit the Support page for your product at [www.samsung.com](http://www.samsung.com), or call Samsung Product Support (1-800-726-7864) to find an answer before you contact a service center for a repair.

# WARRANTY

## LIMITED WARRANTY TO ORIGINAL PURCHASER

This SAMSUNG brand product, as supplied and distributed by Samsung Electronics America, Inc. (SAMSUNG) and delivered new, in the original carton to the original consumer purchaser, is warranted by SAMSUNG against manufacturing defects in materials and workmanship for a limited warranty period of:

**One (1) Year Parts and Labor\***  
**(\*90 Days Parts and Labor for Commercial Use)**

This limited warranty begins on the original date of purchase, and is valid only on products purchased and used in the United States. To receive warranty service, the purchaser must contact SAMSUNG for problem determination and service procedures. Warranty service can only be performed by a SAMSUNG authorized service center. The original dated bill of sale must be presented upon request as proof of purchase to SAMSUNG or SAMSUNG's authorized service center. Transportation of the product to and from the service center is the responsibility of the purchaser.

SAMSUNG will repair or replace this product, at our option and at no charge as stipulated herein, with new or reconditioned parts or products if found to be defective during the limited warranty period specified above. All replaced parts and products become the property of SAMSUNG and must be returned to SAMSUNG. Replacement parts and products assume the remaining original warranty, or ninety (90) days, whichever is longer.

SAMSUNG's obligations with respect to software products distributed by SAMSUNG under the SAMSUNG brand name are set forth in the applicable end user license agreement. Non-SAMSUNG hardware and software products, if provided, are on an "AS IS" basis. Non-SAMSUNG manufacturers, suppliers, publishers, and service providers may provide their own warranties.

This limited warranty covers manufacturing defects in materials and workmanship encountered in normal, and except to the extent otherwise expressly provided for in this statement, noncommercial use of this product, and shall not apply to the following, including, but not limited to: damage which occurs in shipment; delivery and installation; applications and uses for which this product was not intended; altered product or serial numbers; cosmetic damage or exterior finish; accidents, abuse, neglect, fire, water, lightning or other acts of nature; use of products, equipment, systems, utilities, services, parts, supplies, accessories, applications, installations, repairs, external wiring or connectors not supplied and authorized by SAMSUNG, or which damage this product or result in service problems; incorrect electrical line voltage, fluctuations and surges; customer adjustments and failure to follow operating instructions, cleaning, maintenance and environmental instructions that are covered and prescribed in the instruction book; product removal or reinstallation; reception problems and distortion related to noise, echo, interference or other signal transmission and delivery problems. SAMSUNG does not warrant uninterrupted or error-free operation of the product.

THERE ARE NO EXPRESS WARRANTIES OTHER THAN THOSE LISTED AND DESCRIBED ABOVE, AND NO WARRANTIES WHETHER EXPRESS OR IMPLIED, INCLUDING, BUT NOT LIMITED TO, ANY IMPLIED WARRANTIES OF MERCHANTABILITY OR FITNESS FOR A PARTICULAR PURPOSE, SHALL APPLY AFTER THE EXPRESS WARRANTY PERIODS STATED ABOVE, AND NO OTHER EXPRESS WARRANTY OR GUARANTY GIVEN BY ANY PERSON, FIRM OR CORPORATION WITH RESPECT TO THIS PRODUCT SHALL BE BINDING ON SAMSUNG. SAMSUNG SHALL NOT BE LIABLE FOR LOSS OF REVENUE OR PROFITS, FAILURE TO REALIZE SAVINGS OR OTHER BENEFITS, OR ANY OTHER SPECIAL, INCIDENTAL OR CONSEQUENTIAL DAMAGES CAUSED BY THE USE, MISUSE OR INABILITY TO USE THIS PRODUCT, REGARDLESS OF THE LEGAL THEORY ON WHICH THE CLAIM IS BASED, AND EVEN IF SAMSUNG HAS BEEN ADVISED OF THE POSSIBILITY OF SUCH DAMAGES. NOR SHALL RECOVERY OF ANY KIND AGAINST SAMSUNG BE GREATER IN AMOUNT THAN THE PURCHASE PRICE OF THE PRODUCT SOLD BY SAMSUNG AND CAUSING THE ALLEGED DAMAGE. WITHOUT LIMITING THE FOREGOING, PURCHASER ASSUMES ALL RISK AND LIABILITY FOR LOSS, DAMAGE OR INJURY TO PURCHASER AND PURCHASER'S PROPERTY AND TO OTHERS AND THEIR PROPERTY ARISING OUT OF THE USE, MISUSE OR INABILITY TO USE THIS PRODUCT SOLD BY SAMSUNG NOT CAUSED DIRECTLY BY THE NEGLIGENCE OF SAMSUNG. THIS LIMITED WARRANTY SHALL NOT EXTEND TO ANYONE OTHER THAN THE ORIGINAL PURCHASER OF THIS PRODUCT, IS NONTRANSFERABLE AND STATES YOUR EXCLUSIVE REMEDY.

The benefits of this Limited Warranty extend only to the original purchaser of Samsung products from an authorized Samsung reseller. THIS LIMITED WARRANTY SHALL NOT APPLY TO ANY SAMSUNG PRODUCTS PURCHASED FROM UNAUTHORIZED RESELLERS OR RETAILERS, EXCEPT IN STATES WHERE SUCH RESTRICTION MAY BE PROHIBITED. For a list of Samsung authorized retailers, please go to: [http://www.samsung.com/us/peaceofmind/authorized\\_resellers.html](http://www.samsung.com/us/peaceofmind/authorized_resellers.html)

Some states do not allow limitations on how long an implied warranty lasts, or the exclusion or limitation of incidental or consequential damages, so the above limitations or exclusions may not apply to you. This warranty gives you specific legal rights, and you may also have other rights which vary from state to state.

To obtain warranty hardware service, please contact SAMSUNG customer care center.



Certification model only

# SAMSUNG

The party responsible for product compliance:

Samsung Electronics Co., LTD.  
America QA lab of Samsung  
19 Chapin Rd. Building D,  
Pine Brook New Jersey 07058

## QUESTIONS OR COMMENTS?

COUNTRY	CALL	OR VISIT US ONLINE AT	WRITE
U.S.A	1-800-SAMSUNG (1-800-726-7864)	<a href="http://www.samsung.com/us/support">www.samsung.com/us/support</a>	Samsung Electronics America, Inc. 85 Challenger Road Ridgefield Park, NJ 07660