

# OLYMPUS®

## DIGITAL CAMERA

# *E-M5* Mark II

## Instruction Manual

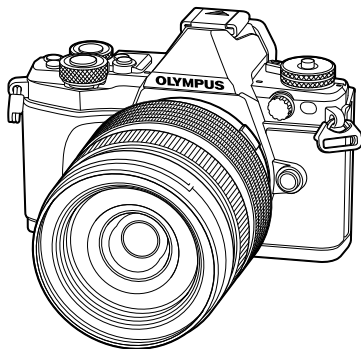

### Table of Contents

#### Quick task index

1. Preparation
2. Shooting
3. Playback
4. Menu functions
5. Connecting the camera to a smartphone
6. Connecting the camera to a computer and a printer
7. Battery, battery charger, and card
8. Interchangeable lenses
9. Using separately sold accessories
10. Information
11. SAFETY PRECAUTIONS

Model No. : E-M5 II

- Thank you for purchasing an Olympus digital camera. Before you start to use your new camera, please read these instructions carefully to enjoy optimum performance and a longer service life. Keep this manual in a safe place for future reference.
- We recommend that you take test shots to get accustomed to your camera before taking important photographs.
- The screen and camera illustrations shown in this manual were produced during the development stages and may differ from the actual product.
- If there are additions and/or modifications of functions due to firmware update for the camera, the contents will differ. For the latest information, please visit the Olympus website.

- This notice concerns the supplied flash unit and is chiefly directed to users in North America.

## Information for Your Safety

# IMPORTANT SAFETY INSTRUCTIONS



When using your photographic equipment, basic safety precautions should always be followed, including the following:

- Read and understand all instructions before using.
- Close supervision is necessary when any flash is used by or near children. Do not leave flash unattended while in use.
- Care must be taken as burns can occur from touching hot parts.
- Do not operate if the flash has been dropped or damaged - until it has been examined by qualified service personnel.
- Let flash cool completely before putting away.
- To reduce the risk of electric shock, do not immerse this flash in water or other liquids.
- To reduce the risk of electric shock, do not disassemble this flash, but take it to qualified service personnel when service or repair work is required. Incorrect reassembly can cause electric shock when the flash is used subsequently.
- The use of an accessory attachment not recommended by the manufacturer may cause a risk of fire, electric shock, or injury to persons.

## SAVE THESE INSTRUCTIONS

### Indications used in this manual

The following symbols are used throughout this manual.

<b>Cautions</b>	Important information on factors which may lead to a malfunction or operational problems. Also warns of operations that should be absolutely avoided.
 <b>Notes</b>	Points to note when using the camera.
 <b>Tips</b>	Useful information and hints that will help you get the most out of your camera.
	Reference pages describing details or related information.

# Table of Contents

<b>Quick task index</b>	<b>7</b>
<b>Names of parts</b> .....	<b>10</b>
<b>Preparation</b>	<b>12</b>
<b>Unpack the box contents</b> .....	<b>12</b>
<b>Charging and inserting the battery</b> .....	<b>13</b>
<b>Inserting the card</b> .....	<b>14</b>
Removing the card .....	14
<b>Attaching a lens to the camera</b> .....	<b>15</b>
<b>Using the monitor</b> .....	<b>16</b>
<b>Power on</b> .....	<b>17</b>
<b>Setting the date/time</b> .....	<b>18</b>
<b>Shooting</b>	<b>19</b>
<b>Information displays while shooting</b> .....	<b>19</b>
Monitor display when shooting .....	19
<b>Switching between displays</b> .....	<b>21</b>
Switching between shooting using live view and shooting using the viewfinder.....	21
Switching the information display .....	22
<b>Shooting still pictures</b> .....	<b>23</b>
Shooting with touch screen operations.....	25
Using iAUTO mode.....	26
Shooting in scene mode.....	28
Using art filters.....	30
Using PHOTO STORY .....	32
“Point-and-shoot” photography (P program mode).....	34
Choosing aperture (A aperture-priority mode) .....	35
Choosing shutter speed (S shutter-priority mode) .....	36
Choosing aperture and shutter speed (M manual mode).....	37
Shooting with long exposure time (BULB).....	37
Live composite photography (dark and light field composite) .....	38
<b>Recording movies</b> .....	<b>39</b>
Using movie mode (MOV).....	40
Taking photographs during movie recording (Movie+Photo Mode) .....	41
Using the silencing function when shooting a movie.....	41
<b>Shooting “My Clips”</b> .....	<b>42</b>
Editing “My Clips” .....	43
Shooting slow/quick motion movies .....	44
<b>Using shooting options</b> .....	<b>45</b>
Calling shooting options .....	45
Controlling exposure (exposure compensation).....	47
Locking the exposure (AE Lock).....	47
Setting the AF target (AF Area) .....	48
Using small target and group target (Setting AF target) .....	48
Face priority AF/pupil detection AF .....	49
Zoom frame AF/zoom AF (Super Spot AF).....	50
Choosing a focus mode (AF mode).....	51
Changing the brightness of highlights and shadows .....	52
Controlling color (Color Creator).....	52

Taking HDR (High Dynamic Range) images .....	53	Setting the color reproduction format (Color Space) .....	73
Choosing how the camera measures brightness (metering) .....	54	Movie sound options (recording sound with movies) .....	74
ISO sensitivity .....	54	Adding effects to a movie .....	74
Adjusting color (white balance) .....	55		
Making fine adjustments to white balance (white balance compensation) .....	56	<b>Playback</b> .....	<b>76</b>
Reducing camera shake (image stabilizer) .....	57	■ <b>Information display during playback</b> .....	<b>76</b>
Sequential shooting/using the self timer .....	58	Playback image information .....	76
Shooting without the vibration caused by shutter button operations (Anti-Shock [♦]) .....	59	Switching the information display .....	77
Shooting without shutter sound (Silent[♥]) .....	59	■ <b>Viewing photographs and movies</b> .....	<b>78</b>
Shooting still pictures in a higher resolution (High Res Shot) .....	60	Index display/ Calendar display .....	79
Setting the image aspect .....	60	Viewing still images .....	79
Selecting image quality (still image quality mode) .....	61	Volume .....	80
Selecting image quality (movie image quality mode) .....	62	Watching movies .....	81
Using a flash (flash photography) .....	63	Protecting images .....	81
Adjusting flash output (flash intensity control) .....	66	Erasing images .....	81
Assigning functions to buttons (Button Function) .....	66	Setting a transfer order on images ([Share Order]) .....	82
Processing options (picture mode) .....	70	Selecting images ([Share Order Selected], [On], [Erase Selected]) .....	82
Making fine adjustments to sharpness (sharpness) .....	71	■ <b>Using the touch screen</b> .....	<b>83</b>
Making fine adjustments to contrast (contrast) .....	71	Selecting and protecting images .....	83
Making fine adjustments to saturation (saturation) .....	71		
Making fine adjustments to tone (gradation) .....	72	<b>Menu functions</b> .....	<b>84</b>
		■ <b>Basic menu operations</b> .....	<b>84</b>
		■ <b>Using Shooting Menu 1/ Shooting Menu 2</b> .....	<b>85</b>
		Formatting the card (Card Setup) .....	85
		Deleting all images (Card Setup) .....	85
		Returning to default settings (Reset) .....	86

Registering Favorites settings (Myset).....	86	<b>Using the custom menus.....</b>	<b>100</b>
Processing options (Picture Mode).....	87	AF/MF .....	100
Image quality (  ).....	87	Button/Dial/Lever .....	101
Digital Zoom (Digital Tele-converter) .....	88	Release/ .....	101
Setting the self timer (/  ).....	88	Disp/ )/PC .....	102
Shooting automatically with a fixed interval (  ) time lapse shooting).....	89	Exp//ISO.....	104
Varying settings over a series of photographs (bracketing).....	90	Custom.....	105
Recording multiple exposures in a single image (multiple exposure).....	93	/Color/WB.....	105
Keystone correction and perspective control (Keystone Comp.).....	94	Record/Erase.....	106
Setting anti-shock/silent shooting (Anti-Shock[]/ Silent[]) .....	95	Movie .....	107
Setting hi-res shot (High Res Shot).....	95	Built-In EVF.....	109
Wireless remote control flash photography.....	95	Utility.....	109
<b>Using the playback menu .....</b>	<b>96</b>	AEL/AFL .....	110
Displaying images rotated (  ).....	96	MF Assist.....	111
Editing still images.....	96	Lever Function.....	111
Canceling all protections .....	98	Viewing camera images on TV .....	112
<b>Using the setup menu.....</b>	<b>99</b>	Choosing the control panel displays (  Control Settings ) .....	113
🕒 (Date/time setting) .....	99	Adding information displays....	114
🗣️ (Changing the display language).....	99	Shutter speeds when the flash fires automatically .....	115
📊 (Monitor brightness adjustment).....	99	Combinations of movie image sizes and compression rates.....	116
Rec View .....	99	Shooting self-portraits using the selfie assist menu .....	116
Wi-Fi Settings .....	99	Selecting the display style of the viewfinder .....	117
⚙️ Menu Display .....	99	<b>Connecting the camera to a smartphone</b> .....	<b>118</b>
Firmware.....	99	<b>Connecting to a smartphone... 119</b>	
		<b>Transferring images to a smartphone.....</b>	<b>120</b>
		<b>Shooting remotely with a smartphone.....</b>	<b>120</b>
		<b>Adding position information to images.....</b>	<b>121</b>

Changing the connection method .....	122
Changing the password.....	122
Cancelling a share order .....	123
Initializing wireless LAN settings.....	123

## Connecting the camera to a computer and a printer 124

Connecting the camera to a computer .....	124
Copying pictures to a computer .....	124
Installing the PC software .....	125
Direct printing (PictBridge) .....	127
Easy printing.....	127
Custom printing .....	128
Print reservation (DPOF) .....	129
Creating a print order.....	129
Removing all or selected pictures from the print order .....	130

## Battery, battery charger, and card 131

Battery and charger .....	131
Using your charger abroad .....	131
Usable cards .....	132
Record mode and file size/ number of storable still pictures .....	133

## Interchangeable lenses 134

M.ZUIKO DIGITAL lens specifications .....	135
---	-----

## Using separately sold accessories 139

Power Battery Holder (HLD-8) .....	139
External flash units designated for use with this camera .....	141
Wireless remote control flash photography.....	141
Other external flash units .....	143
Principal Accessories .....	143
System chart.....	144

## Information 146

Shooting tips and information	146
Error codes .....	148
Cleaning and storing the camera.....	150
Cleaning the camera .....	150
Storage .....	150
Cleaning and checking the image pickup device .....	150
Pixel Mapping - Checking the image processing functions....	151
Menu directory.....	152
Specifications .....	159

## SAFETY PRECAUTIONS 162

SAFETY PRECAUTIONS .....	162
--------------------------	-----

## Index 172

# Quick task index

## Shooting



Taking pictures with automatic settings	▶ iAUTO ( <b>iAUTO</b> )	26
Choosing an aspect ratio	▶ Aspect ratio	60
Quickly matching settings to the scene	▶ Scene mode ( <b>SCN</b> )	28
Pro-level photography made simple	▶ Live Guide	26
Adjusting the brightness of a photograph	▶ Exposure compensation	47
Taking pictures with a blurred background	▶ Live Guide	26
	▶ Aperture priority shooting	35
Taking pictures that stop the subject in motion or convey a sense of motion	▶ Live Guide	26
	▶ Shutter priority shooting	36
	▶ Scene mode ( <b>SCN</b> )	28
Taking pictures with the correct color	▶ White balance	55
	▶ One-touch white balance	56
Processing pictures to match the subject/ Taking monotone pictures	▶ Picture Mode	70
	▶ Art filter ( <b>ART</b> )	30
When the camera will not focus on your subject/Focusing on one area	▶ Using the touch screen	25
	▶ AF Area	48
	▶ Zoom frame AF/zoom AF	50
Focusing on a small spot in the frame/ confirming focus before shooting	▶ Zoom frame AF/zoom AF	50
Recomposing photographs after focusing	▶ C-AF+TR (AF tracking)	51
Taking photos without the flash	▶ DIS Mode/ISO	28/54
	▶ Image Stabilizer/Anti-shock shooting	57/59
Reducing camera shake	▶ Self-timer	58
	▶ Remote cable	143
Taking pictures of a subject against backlight	▶ Flash shooting	63
	▶ Gradation (Picture Mode)	72

Photographing fireworks	Bulb/time photography	37
	▶ Live composite photography	38
	Scene mode ( <b>SCN</b> )	28
Taking pictures without white subjects appearing too white or black subjects appearing too dark	Gradation (Picture Mode)	72
	▶ Histogram/ Exposure compensation	22/47
	Highlight&Shadow Control	52
Reducing image noise (mottling)	▶ Noise Reduct.	104
Optimizing the monitor/ adjusting monitor hue	▶ Monitor brightness adjustment/Live View Boost	99/102
Checking set effect before taking a picture	▶ Preview function	67
	▶ Test Picture	67
Checking horizontal or vertical orientation before shooting	▶ Level gauge	22
Shooting with deliberate composition	▶ Displayed Grid	102
Zooming in on photos to check focus	▶ AUTO [ ] (Rec View)	99
Self-portraits	▶ Self-timer	58
	▶ Scene mode ( <b>SCN</b> )	28
Sequential shooting	▶ Sequential shooting	58
Extending the useful life of the battery	▶ Quick Sleep Mode	110
Increasing the number of pictures that can be taken	▶ Record mode	61
Shooting remotely with a smartphone	▶ Shooting remotely with a smartphone	120
Shooting without recording the shutter sound	▶ Silent [♥]	59



## Playback/Retouch

Viewing images on a TV	▶ HDMI/Video Out	102
	▶ Playback on TV	112
Viewing slideshows with background music	▶ Slideshow	80
Brightening shadows	▶ Shadow Adj (JPEG Edit)	97
Dealing with red-eye	▶ Redeye Fix (JPEG Edit)	97
Printing made easy	▶ Direct printing	127
Commercial prints	▶ Creating a print order	129
Transferring images to a smartphone	▶ Transferring images to a smartphone	120
Adding location data to images	▶ Adding location data to images	121

## Camera Settings

Synchronizing the date and time	▶ Setting the date/time	18
Restoring default settings	▶ Reset	86
Saving the settings	▶ Myset	86
Changing the menu display language	▶ 	99
Turning off the auto focus sound	▶  (Beep sound)	103

## Names of parts

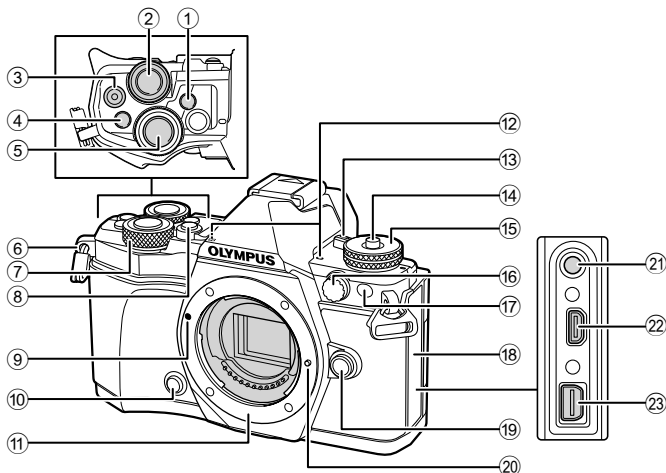

- |   |  |
|---|--|
| ①  (LV) button (Fn3) .....P. 21, 66                         | ⑭ Mode dial lock.....P. 23   |
| ② Rear dial* ()<br>.....P. 34–37, 46–47, 62, 68–69          | ⑮ Mode dial .....P. 23   |
| ③  (Movie)/ button .....P. 39, 66, 82                       | ⑯ External flash connector .....P. 143   |
| ④ Fn2 button .....P. 52, 68, 111                            | ⑰ Self-timer lamp/AF illuminator<br>.....P. 58/P. 100  |
| ⑤ Shutter button .....P. 24                                 | ⑱ Connector cover  |
| ⑥ Strap eyelet.....P. 12                                    | ⑲ Lens release button.....P. 15  |
| ⑦ Front dial* ().....P. 34–37, 79                           | ⑳ Lens lock pin  |
| ⑧ HDR button (Fn4) .....P. 53, 66                           | ㉑ Microphone connector (Third-party<br>commercial microphones can be used.<br>ø3.5 stereo mini-plug) |
| ⑨ Lens attachment mark .....P. 15                           | ㉒ HDMI connector (Type D).....P. 112   |
| ⑩  (Preview) button.....P. 67                               | ㉓ Multi-connector .....P. 112, 124, 127  |
| ⑪ Mount (Remove the body cap before<br>attaching the lens.) |  |
| ⑫ Stereo microphone .....P. 74, 82, 98                      |  |
| ⑬ ON/OFF lever .....P. 17                                   |  |

\* In this manual, the and icons represent operations performed using the front dial and rear dial.

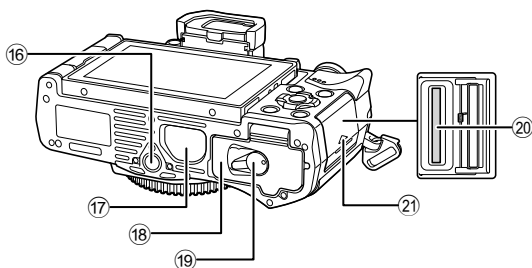
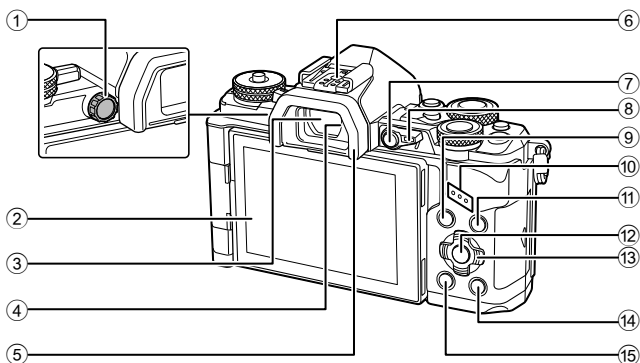

- |  |                                       |
|--|---------------------------------------|
| ① Diopter adjustment dial.....P. 21                    | ⑪ <b>INFO</b> button.....P. 22, 77    |
| ② Monitor (Touch screen)<br>.....P. 19, 21, 46, 76, 83 | ⑫ <b>OK</b> button.....P. 46–47, 84   |
| ③ Viewfinder.....P. 21                                 | ⑬ Arrow pad*.....P. 78                |
| ④ Eye sensor   | ⑭  (Playback) button.....P. 78        |
| ⑤ Eyecup.....P. 143                                    | ⑮  (Erase) button.....P. 81           |
| ⑥ Hot shoe.....P. 63, 141                              | ⑯ Tripod socket                       |
| ⑦ <b>Fn1</b> button.....P. 66                          | ⑰ PBH cover.....P. 139                |
| ⑧ Lever.....P. 34–37, 111                              | ⑱ Battery compartment cover.....P. 13 |
| ⑨ <b>MENU</b> button.....P. 84                         | ⑲ Battery compartment lock.....P. 13  |
| ⑩ Speaker  | ⑳ Card slot.....P. 14                 |
|  | ㉑ Card slot cover.....P. 14           |

\* In this manual, the icons represent operations performed using the arrow pad.

# 1 Preparation

## Unpack the box contents

The following items are included with the camera.  
If anything is missing or damaged, contact the dealer from whom you purchased the camera.



Camera



Body cap



Strap

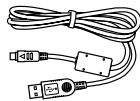

USB cable  
CB-USB6

- Flash case
- Computer software CD-ROM
- Instruction manual
- Warranty card



Flash  
FL-LM3



Lithium ion battery  
BLN-1



Lithium ion charger  
BCN-1

### Attaching the strap

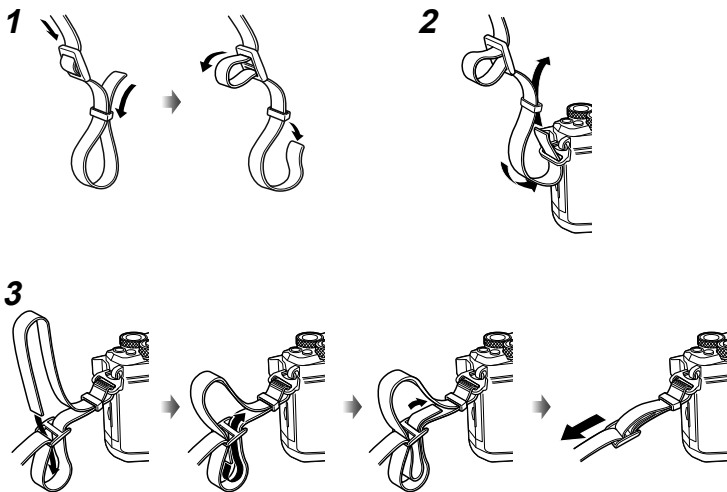

- Attach the strap on the other side in the same way.
- Lastly, pull the strap firmly, making sure that it is fastened securely.

## Charging and inserting the battery

### 1 Charging the battery.

#### Charging indicator

Charging in progress	Lights orange
Charging complete	Off
Charging error	Blinks orange

(Charging time: Up to approximately 4 hours)

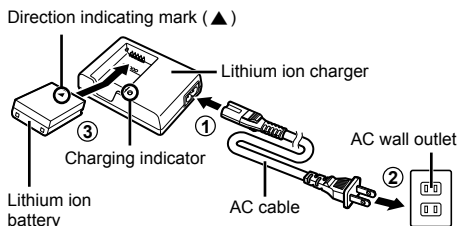

#### Cautions

- Unplug the charger when charging is complete.

### 2 Opening the battery compartment cover.

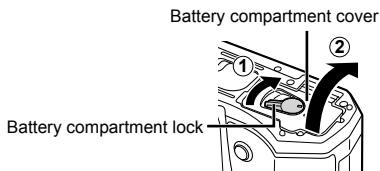

### 3 Loading the battery.

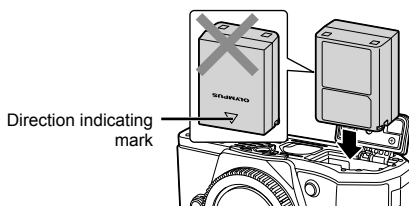

#### Removing the battery

Turn off the camera before opening or closing the battery compartment cover. To remove the battery, first push the battery lock knob in the direction of the arrow and then remove.

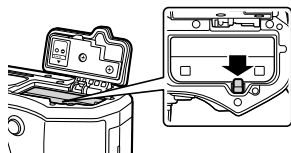

#### Cautions

- Contact an authorized distributor or service center if you are unable to remove the battery. Do not use force.

#### Notes

- It is recommended to set aside a backup battery for prolonged shooting in case the battery in use drains.
- Also read "Battery, battery charger, and card" (P. 131).

## Inserting the card

The following types of SD memory card (commercially available) can be used with this camera: SD, SDHC, SDXC, and Eye-Fi.

### Eye-Fi Cards

Read "Usable cards" (P. 132) before use.

### 1 Loading the card.

- Open the card slot cover.
- Slide the card in until it is locked into place.  
 "Usable cards" (P. 132)

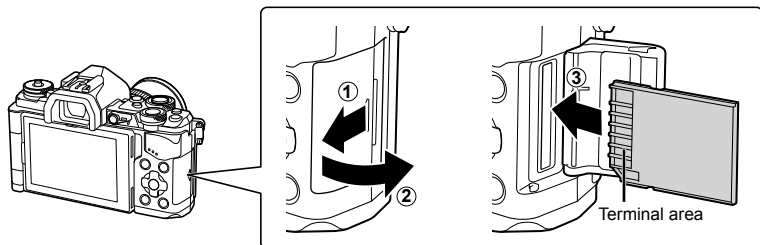

### Cautions

- Turn off the camera before loading or removing the battery or card.
- Do not forcibly insert a damaged or deformed card. Doing so may damage the card slot.

### 2 Closing the card slot cover.

- Close firmly until you hear a click.

### Cautions

- Be sure the card slot cover is closed before using the camera.

## Removing the card

Press the inserted card lightly and it will be ejected. Pull out the card.

### Cautions

- Do not remove the battery or card while the card write indicator (P. 19) is displayed.

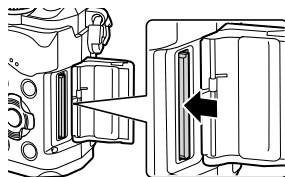

## Attaching a lens to the camera

### 1 Attach a lens to the camera.

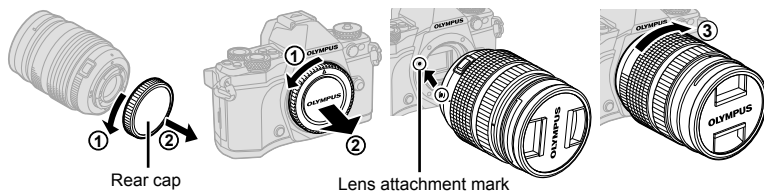

- Remove the rear cap of the lens and the body cap of the camera.
- Align the lens attachment mark (red) on the camera with the alignment mark (red) on the lens, then insert the lens into the camera's body.
- Rotate the lens clockwise until you hear it click (direction indicated by arrow ③).

### Cautions

- Make sure the camera is turned off when attaching or removing the lens.
- Do not press the lens release button.
- Do not touch internal portions of the camera.

### 2 Remove the lens cap.

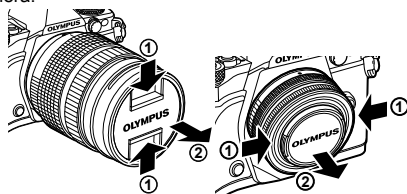

### ■ Removing the lens from the camera

Make sure the camera is turned off when removing the lens.

### 1 While pressing the lens release button, rotate the lens in the direction of the arrow.

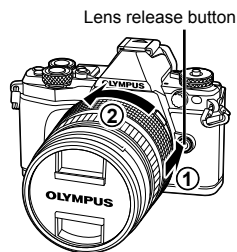

### Interchangeable lenses

Read "Interchangeable lenses" (P. 134).

## Using the monitor

You can change the orientation and angle of the monitor.

At the time of purchase, the monitor faces inwards. Please use the camera with the monitor facing outwards.

1

Preparation

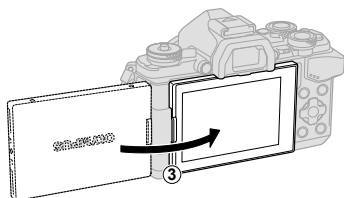
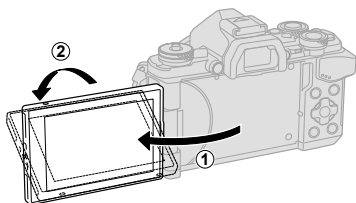

Lower angle/Upper angle

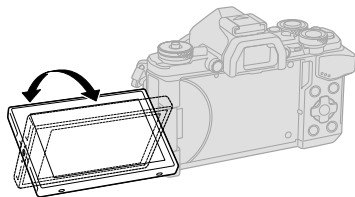

Self portrait

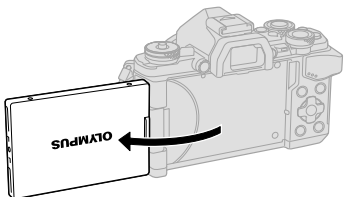

- When the monitor is in the selfie position, the display on the monitor will flip vertically.
- If you are using a power zoom lens, it will automatically move to the wide angle side when the monitor is set in the selfie position.
- When the monitor is in the selfie position, you can switch to the screen for taking self portraits.
  - ▶ “Shooting self-portraits using the selfie assist menu” (P. 116)



## Power on

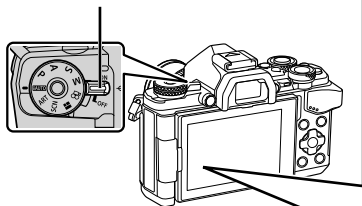

- 1 Move the **ON/OFF** lever to the **ON** position.
  - When the camera is turned on, the monitor will turn on.
  - To turn off the camera, return the lever to the **OFF** position.

### ■ ON/OFF lever



### ■ Monitor

#### Battery level

-  (green): Camera ready to shoot.  
(Displayed for about ten seconds after the camera is turned on.)
-  (green): Low battery
-  (blinks red): Charge the battery.



### Camera sleep operation

If no operations are performed for a minute, the camera enters “sleep” (stand-by) mode to turn off the monitor and to cancel all actions. The camera activates again when you touch any button (the shutter button,  button, etc.). The camera will turn off automatically if left in sleep mode for 4 hours. Turn the camera on again before use.

## Setting the date/time

Date and time information is recorded on the card together with the images. The file name is also included with the date and time information. Be sure to set the correct date and time before using the camera. Some functions cannot be used if the date and time have not been set.

### 1 Display the menus.

- Press the **MENU** button to display the menus.

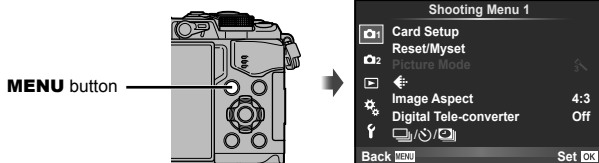

### 2 Select [Ⓜ] in the [f] (setup) tab.

- Use  $\Delta$   $\nabla$  on the arrow pad to select [f] and press  $\blacktriangleright$ .
- Select [Ⓜ] and press  $\blacktriangleright$ .

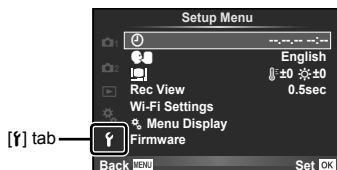

### 3 Set the date and time.

- Use  $\triangleleft$   $\triangleright$  to select items.
- Use  $\Delta$   $\nabla$  to change the selected item.
- Use  $\Delta$   $\nabla$  to select the date format.

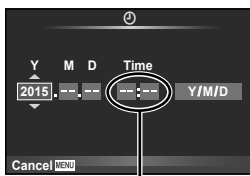

The time is displayed using a 24-hour clock.

### 4 Save settings and exit.

- Press **OK** to set the camera clock and exit to the main menu.
- Press the **MENU** button to exit the menus.

#### Cautions

- If the battery is removed from the camera and the camera is left for a while, the date and time may reset to the factory default setting.

#### Notes

- You can synchronize the time correctly by pressing **OK** at a time signal of 0 seconds while setting [min].

# 2 Shooting

## Information displays while shooting

### Monitor display when shooting

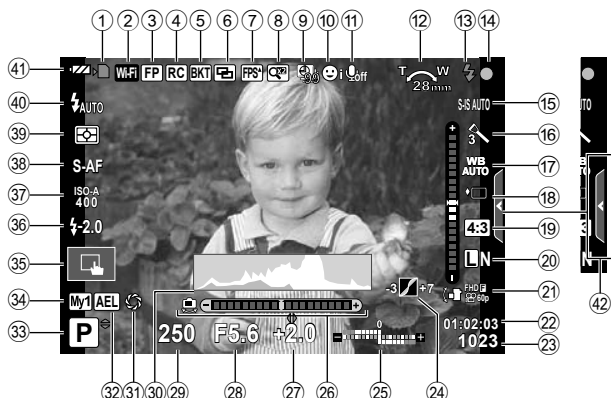

- |  |  |  |
|--|--|--|
| ① Card write indicator.....P. 14   | ⑩ Face priority/Eye priority.....P. 49   | ⑱ Aspect ratio.....P. 60                               |
| ② Wireless LAN connection<br>.....P. 118–123   | ⑪ Movie sound.....P. 74  | ⑲ Record mode (still images).....P. 61                 |
| ③ Super FP flash.....P. 141  | ⑫ Zoom operation direction/<br>Focal length/Internal temperature<br>warning $\text{C}/\text{F}$ .....P. 137/P. 149 | ⑲ Record mode (movies).....P. 62                       |
| ④ RC mode.....P. 141   | ⑬ Flash.....P. 63<br>(blinks: charging in progress,<br>lights up: charging completed)                              | ⑲ Available recording time                             |
| ⑤ Auto bracket/HDR.....P. 90/P. 53   | ⑭ AF confirmation mark.....P. 24   | ⑲ Number of storable still pictures...P. 133           |
| ⑥ Multiple exposure.....P. 93  | ⑮ Image stabilizer.....P. 57   | ⑲ Highlight and shadow control.....P. 52               |
| ⑦ High frame rate.....P. 102   | ⑯ Art filter.....P. 30   | ⑲ Top: Flash intensity control.....P. 66               |
| ⑧ Digital Tele-converter.....P. 88   | ⑰ Scene mode.....P. 28   | ⑲ Bottom: Exposure compensation<br>indicator.....P. 47 |
| ⑨ Time lapse shooting.....P. 89  | ⑰ Picture mode.....P. 70   | ⑲ Level gauge  |
| ⑩ Face priority/Eye priority.....P. 49   | ⑰ White balance.....P. 55  | ⑲ Exposure compensation value.....P. 47                |
| ⑪ Movie sound.....P. 74  | ⑰ Sequential shooting/Self-timer/<br>Anti-Shock shooting/Silent shooting/<br>High resolution shot.....P. 58, 59    | ⑲ Aperture value.....P. 34–37                          |
| ⑫ Zoom operation direction/<br>Focal length/Internal temperature<br>warning $\text{C}/\text{F}$ .....P. 137/P. 149 |  | ⑲ Shutter speed.....P. 34–37                           |
| ⑬ Flash.....P. 63<br>(blinks: charging in progress,<br>lights up: charging completed)                              |  | ⑲ Histogram.....P. 22                                  |
| ⑭ AF confirmation mark.....P. 24   |  | ⑲ Preview.....P. 67                                    |
| ⑮ Image stabilizer.....P. 57   |  | ⑲ AE Lock.....P. 110                                   |
| ⑯ Art filter.....P. 30   |  | ⑲ Shooting mode.....P. 23–40                           |
| ⑰ Scene mode.....P. 28   |  | ⑲ Myset.....P. 86                                      |
| ⑰ Picture mode.....P. 70   |  | ⑲ Shooting using touch screen<br>operations.....P. 25  |
| ⑰ White balance.....P. 55  |  | ⑲ Flash intensity control.....P. 66                    |
| ⑰ Sequential shooting/Self-timer/<br>Anti-Shock shooting/Silent shooting/<br>High resolution shot.....P. 58, 59    |  | ⑲ ISO sensitivity.....P. 54                            |
|  |  | ⑲ AF mode.....P. 51                                    |
|  |  | ⑲ Metering mode.....P. 54                              |
|  |  | ⑲ Flash mode.....P. 63                                 |
|  |  | ⑲ Battery check  |
|  |  | ⑲ Live guide recall.....P. 26                          |

## Monitor display during movie mode

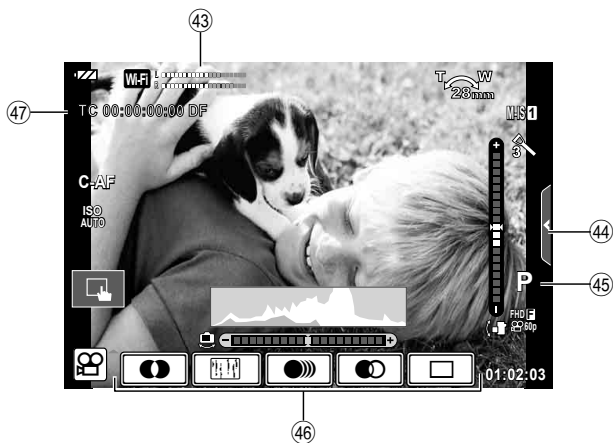

- ④③ Recording level meter.....P. 74, 107
- ④④ Silent shooting tab .....P. 41
- ④⑤ Shooting mode.....P. 74
- ④⑥ Movie effect .....P. 40
- ④⑦ Time code .....P. 108

## Switching between displays

### Switching between shooting using live view and shooting using the viewfinder

With this camera, you can select between two shooting methods: Shooting using the viewfinder and shooting using live view with the monitor. Press the  button to switch between shooting methods.

#### Shooting using live view

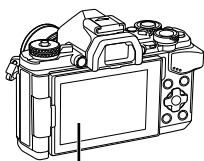

#### ■ Monitor



Live view display



#### Cursor



When setting shooting functions, if you press the  button, a cursor will appear on the LV super control panel. Touch the function you want to set.

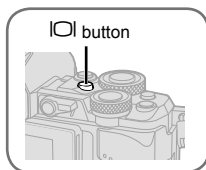

#### Shooting using the viewfinder

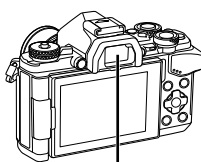

#### ■ Viewfinder

Automatically lights up when your eye moves close.

When the viewfinder is lit up, the monitor turns off.

#### If the display in the viewfinder looks blurry

Look through the viewfinder and rotate the diopter adjustment dial until the display is in sharp focus.

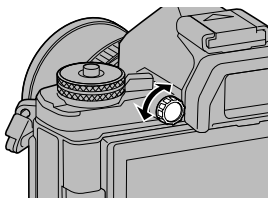

## Switching the information display

You can switch the information displayed in the monitor during shooting using the **INFO** button.

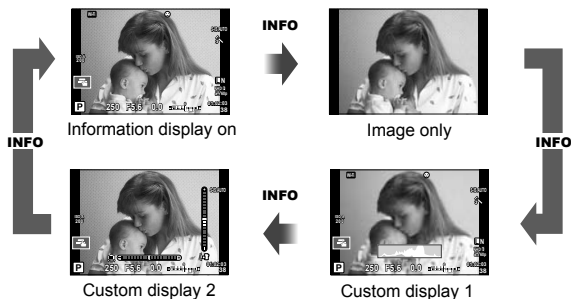

### Histogram display

Display a histogram showing the distribution of brightness in the image. The horizontal axis gives the brightness, the vertical axis the number of pixels of each brightness in the image. Areas above the upper limit at shooting are displayed in red, those below the lower limit in blue, and the area metered using spot metering in green.

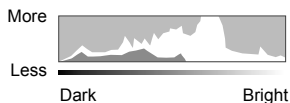

### Level gauge display

Indicate the orientation of the camera. The "tilt" direction is indicated on the vertical bar and the "horizon" direction on the horizontal bar. Use the indicators on the level gauge as a guide.

## Shooting still pictures

Use the mode dial to select the shooting mode, and then shoot the image.

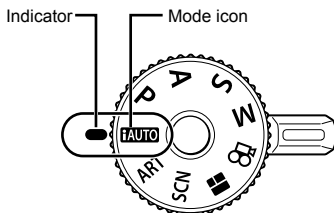

2

Shooting

### ■ Types of shooting modes

For how to use the various shooting modes, see the following.

<b>iAUTO</b> .....	P. 26	<b>B</b> .....	P. 32	<b>S</b> .....	P. 36
<b>SCN</b> .....	P. 28	<b>P</b> .....	P. 34	<b>M</b> .....	P. 37
<b>ART</b> .....	P. 30	<b>A</b> .....	P. 35	<b>B</b> .....	P. 39

**1** Press the mode dial lock to unlock it, and then turn to set the mode you wish to use.

- When the mode dial lock has been pressed down, the mode dial is locked. Each time you press the mode dial lock, it switches between locked/released.

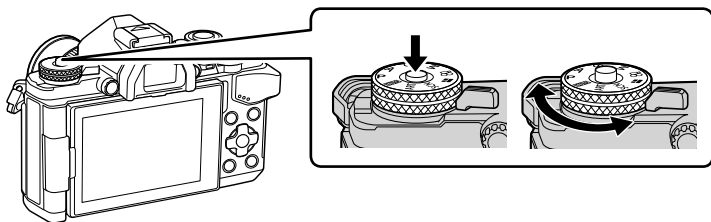

**2** Set up the camera and decide on the composition.

- Be careful that your fingers or the camera strap do not obstruct the lens or AF illuminator.



Landscape position

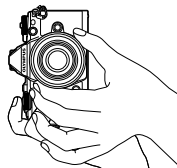

Portrait position

### 3 Adjust the focus.

- Display the subject in the center of the monitor, and lightly press the shutter button down to the first position (press the shutter button halfway).  
The AF confirmation mark (●) will be displayed, and a green frame (AF target) will be displayed in the focus location.

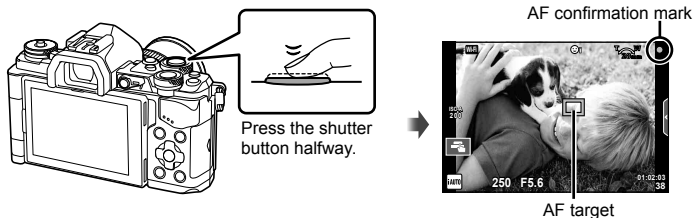

- The ISO sensitivity, shutter speed and aperture value that have been set automatically by the camera are displayed.
- If the AF confirmation mark blinks, the subject is not in focus. (P. 146)

### 4 Release the shutter.

- Press the shutter button all the way (fully).
- The shutter sounds and the picture is taken.
- The shot image will be displayed on the monitor.

#### Pressing the shutter button halfway and all the way down

The shutter button has two positions. The act of lightly pressing the shutter button to the first position and holding it there is called “pressing the shutter button halfway,” that of pressing it all the way down to the second position “pressing the shutter button all (or the rest of) the way down.”





## Shooting with touch screen operations

Tap  to cycle through touch screen settings.



Tap a subject to focus and automatically release the shutter. This function is not available in  mode.



Touch screen operations disabled.





Tap to display an AF target and focus on the subject in the selected area. You can use the touch screen to choose the position and size of the focus frame. Photographs can be taken by pressing the shutter button.



### ■ Previewing Your Subject ( )

- 1 Tap the subject in the display.
  - An AF target will be displayed.
  - Use the slider to choose the size of the frame.
  - Touch  to turn off the display of the AF target.



- 2 Use the slider to adjust the size of the AF target, and then tap  to zoom in at the frame position.
  - Use your finger to scroll the display when the picture is zoomed in.
  - Tap  to cancel the zoom display.

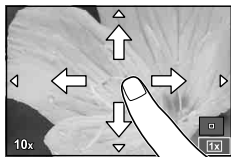

### Cautions

- The situations in which touch screen operations are not available include the following.  
Panorama/3D/e-portrait/multiple exposure/during bulb, time or live composite photography/one-touch white balance dialog/when buttons or dials are in use
- Do not touch the display with your fingernails or other sharp objects.
- Gloves or monitor covers may interfere with touch screen operation.

## Using iAUTO mode

A full auto mode in which the camera automatically optimizes settings for the current scene. The camera does all the work, which is convenient for beginners.

### Using live guides

Live guides make it easy to access a variety of advanced photographic techniques.

- 1 Set the mode dial to **iAUTO**.
- 2 Touch the tab to display the live guides.
  - Touch a guide item and press **OK** after selecting to display the slider of the level bar.

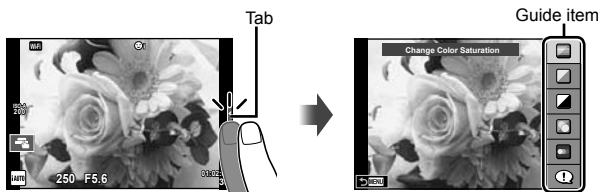

- 3 Use your finger to position the sliders.
  - Tap **OK** to enter the setting.
  - To cancel the live guide setting, tap **MENU** on the screen.
  - When [Shooting Tips] is selected, select an item and touch **OK** to display a description.
  - The effect of the selected level is visible in the display. If [Blur Background] or [Express Motions] is selected, the display will return to normal, but the selected effect will be visible in the final photograph.
- 4 To set multiple live guides, repeat Steps 2 and 3.
  - A check is displayed on the guide item for live guides that are already set.



- 5 Shoot.
  - To clear the live guide from the display, press the **MENU** button.

**Cautions**

- [Blur Background] and [Express Motions] cannot be set at the same time.
- If [RAW] is currently selected for image quality, image quality will automatically be set to [L+N+RAW].
- Live guide settings are not applied to the RAW copy.
- Pictures may appear grainy at some live guide setting levels.
- Changes to live guide setting levels may not be visible in the monitor.
- Frame rates drop when [Blurred Motion] is selected.
- The flash cannot be used with the live guide.
- Choosing live guide settings that exceed the limits of the camera exposure meters may result in pictures that are over or underexposed.

## Shooting in scene mode

Select a scene according to the subject.

### 1 Rotate the mode dial to **SCN**.

- A menu of scene menu will be displayed. Select a scene using the arrow pad ( $\Delta$   $\nabla$ ).
- On the scene menu screen, press  $\triangleright$  to display details of the scene mode on the camera monitor.
- Press  $\odot$  or press the shutter button halfway to select the highlighted item and exit the scene menu.

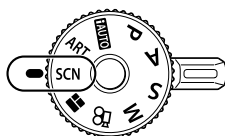

### ■ Types of scene modes



Portrait	High Key	Fireworks
e-Portrait	Low Key	Beach & Snow
Landscape	DIS Mode	Fisheye Effect
Landscape+Portrait	Macro	Wide-Angle
Sport	Nature Macro	Macro
Hand-Held Starlight	Candle	3D Photo
Night Scene	Sunset	Panning
Night+Portrait	Documents	
Children	Panorama (P. 29)	

### 2 Shoot.

- To choose a different setting, press  $\odot$  to display the scene menu.





### Cautions

- To maximize the benefits of the scene modes, some of the shooting function settings are disabled.
- In [e-Portrait] mode, two images are recorded: an unmodified image and a second image to which [e-Portrait] effects have been applied. Recording may take some time. In addition, when the image quality mode is [RAW], the image is recorded in RAW+JPEG.
- [Fisheye Effect], [Wide-Angle], and [Macro] are for use with optional converter lenses.
- Movies cannot be recorded in [e-Portrait], [Hand-Held Starlight], [Panorama], or [3D Photo] mode.
- In [Hand-Held Starlight], 8 frames are shot at one time and then combined. When the image quality mode is [RAW], a JPEG image is combined with the first RAW image and recorded in RAW+JPEG.

- [3D Photo] is subject to the following limitations.
  - [3D Photo] can be used only with a 3D lens.
  - The camera monitor cannot be used to playback images in 3D. Use a device that supports 3D display.
  - Focus is locked. In addition, flash and self-timer also cannot be used.
  - Image size is fixed at 1824 × 1024.
  - RAW photography is not available.
  - Frame coverage is not 100%.
- In [Panning], camera movement is detected and the optimal shutter speed is controlled when moving the camera to track a moving subject. It is convenient for shooting moving subjects as if the background is flowing.
  - In [Panning],  is displayed during panning detection, and  is displayed when nothing is detected.
  - When using a lens with an image stabilizer switch in [Panning], turn the image stabilizer switch off.
  - Sufficient panning effects may not be obtained in bright conditions. Use a commercially available ND filter to obtain effects more easily.

### Taking panoramas

If you have installed the supplied computer software, you can use it to join pictures together to form a panorama.  "Connecting the camera to a computer" (P. 124)

- 1 Select [Panorama] in **SCN** and press .
- 2 Use     to choose a pan direction.
- 3 Take a picture, using the guides to frame the shot.
  - Focus, exposure, and other settings are fixed at the values for the first shot.
- 4 Take the remaining images, framing each shot so that the guides overlap with the previous picture.

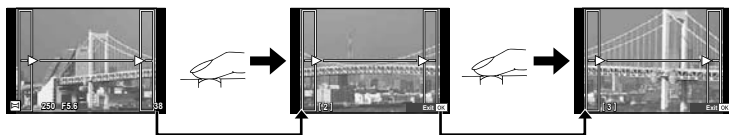
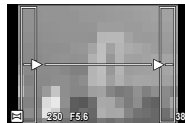



- A panorama may include up to 10 images. A warning indicator () is displayed after the tenth shot.

- 5 After taking the last shot, press  to end the series.

### Cautions

- During panorama shooting, the image previously taken for position alignment will not be displayed. With the frames or other markers for display in the images as a guide, set the composition such that the edges of the overlapping images overlap within the frames.















### Notes

- Pressing  before shooting the first frame returns to the scene mode selection menu. Pressing  in the midst of shooting ends the sequence of panorama shooting, and allows you to continue with the next one.

## Using art filters

Using art filters, you can easily have fun with artistic effects.

### ■ Types of art filters

 <b>Pop Art</b>	Creates an image that emphasizes the beauty of color.
 <b>Soft Focus</b>	Creates an image that expresses a soft tone atmosphere.
 <b>Pale&amp;Light Color</b>	Creates an image that expresses warm light by scattering overall light and slightly overexposing the image.
 <b>Light Tone</b>	Creates a high-quality image by softening both shadows and highlights.
 <b>Grainy Film</b>	Creates an image that expresses the roughness of black and white images.
 <b>Pin Hole</b>	Creates an image that looks as if it was taken using an old or toy camera by dimming the image perimeter.
 <b>Diorama</b>	Creates a miniature-like image by emphasizing saturation and contrast, and blurring unfocused areas.
 <b>Cross Process</b>	Creates an image that expresses a surreal atmosphere. Cross Process II creates an image that emphasizes magenta.
 <b>Gentle Sepia</b>	Creates a high-quality image by drawing out shadows and softening the overall image.
 <b>Dramatic Tone</b>	Creates an image that emphasizes the difference between brightness and darkness by partially increasing contrast.
 <b>Key Line</b>	Creates an image that emphasizes edges and adds an illustrative style.
 <b>Watercolor</b>	Creates a soft, bright image by removing dark areas, blending pale colors on a white canvas, and further softening contours.
 <b>Vintage</b>	Expresses an everyday shot in a nostalgic, vintage tone using printed film discoloration and fading.
 <b>Partial Color</b>	Impressively expresses a subject by extracting colors you want to emphasize and keeping everything else monotone.
 <b>ART BKT (Art Filter Bracket)</b>	Each time the shutter is released, the camera creates copies for all selected art filters.

**1** Rotate the mode dial to **ART**.

- A menu of art filters will be displayed. Select a filter using the arrow pad ( $\Delta$   $\nabla$ ).
- Press  $\odot$  or press the shutter button halfway to select the highlighted item and exit the art filter menu.

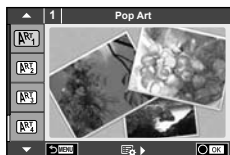
**2** Shoot.

- To choose a different setting, press  $\odot$  to display the art filter menu.

**ART bracketing**

When one shot is taken, images are recorded for each selected art filter. Press  $\triangleright$  to choose filters.

**Art effects**

Art filters can be modified and effects can be added. Pressing  $\triangleright$  in the art filter menu displays additional options.

**Modifying filters**

Option I is the original filter, while options II and on add effects that modify the original filter.

**Adding effects\***

Soft focus, pin-hole, frames, white edges, starlight, filter, tone, blur, shade effect

\* The effects available vary with the selected filter.

**Cautions**

- To maximize the benefits of the art filters, some of the shooting function settings are disabled.
- If [RAW] is currently selected for image quality, image quality will automatically be set to [L+N+RAW]. The art filter will be applied to the JPEG copy only.
- Depending on the subject, tone transitions may be ragged, the effect may be less noticeable, or the image may become more "grainy."
- Some effects may not be visible in live view or during movie recording.
- Playback may differ according to the filters, effects, or movie quality settings applied.

**Setting and taking partial color images**

You can create images that extract only the colors that you selected using the color ring.

Rotate the front dial ( $\odot$ ) or rear dial ( $\odot$ ) to select a color to extract. The effects will be displayed in live view.

If you want to change the extracted color after shooting, rotate the front dial ( $\odot$ ) or rear dial ( $\odot$ ) to display the color ring.









## Using PHOTO STORY

You can shoot a PHOTO STORY. Shoot with selected PHOTO STORY type.

### 1 Rotate the mode dial to .

- A PHOTO STORY menu will be displayed.

-  1: Standard
-  2: Speed
-  3: Zoom In/Out
-  4: Layout
-  5: Fun Frames
-  6: Works in progress







### 2 Use to choose the theme of the PHOTO STORY.

- You can display a detailed screen where you choose the variation or number of frames by using .
- You can choose different effects, number of frames and aspect ratios for each theme. You can also change the aspect ratio, the division pattern and the frame effect of individual images.

### Changing between variations

After pressing , use   to change the variation.

	Original PHOTO STORY
  	PHOTO STORY with effects and aspect ratios changed from the original PHOTO STORY. The number of images and arrangement of image regions can be altered for each theme of the PHOTO STORY.

- You can change the frame color and frame surrounding effect in each variation.
- Every theme and variation provides a different PHOTO STORY.

### 3 After finishing the settings, press .

- The monitor switches to PHOTO STORY display.
- The subject of current frame is displayed.
- Touch any of the frames not containing an image to set that frame as the current frame.
- Press the **MENU** button to change the theme.

### 4 Shoot an image for the first frame.

- The image you have shot is displayed in the first frame.



- To end shooting before taking all the frames, press the **MENU** button, and select an image saving method.



**[Save]:** Save images to an SD card and end shooting.

**[Finish later]:** Save images to an SD card and temporarily end shooting. Saved data can be called and shooting can be resumed later. (P. 33)

**[Discard]:** End shooting without saving images.



## 5 Shoot an image for the next frame.

- View and shoot the subject for the next frame.
- Press  to cancel the image in the directly preceding frame and retake the shot.
- Touch any frame to cancel the image in it and retake the shot. Touch the frame, and then touch .

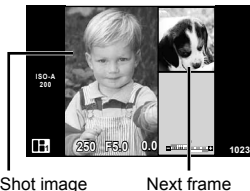

## 6 Once you have shot all the frames, press to save the image.







### Notes

- During the shooting of a PHOTO STORY, the following operations are available.  
Exposure compensation/Program shift/Flash shooting (except when the theme is [Speed])/Live control settings

### Cautions

- If the camera is turned off during shooting, all the data for images up to that point is cancelled and nothing is recorded on the memory card.
- If [RAW] is currently selected for image quality, image quality will automatically be set to [N+RAW]. The PHOTO STORY image is saved as JPEG and the images in the frames as RAW. RAW images are saved in [4:3].
- From among the [AF Mode], [S-AF], [MF] and [S-AF+MF] can be set. Also, the AF target is fixed to a single central point.
- The metering mode is fixed to digital ESP metering.
- The following operations are not available in PHOTO STORY mode.  
Movie/Sequential shooting (except when the theme is [Speed])/Self timer/INFO display/Face priority AF/Digital Tele-converter/Picture mode
- The following button operations are disabled.  
**Fn1/Fn2/INFO** etc.
- During the shooting of a PHOTO STORY, the camera will not go into sleep mode.  
If you temporarily saved partway through shooting, recording space for frames not yet taken is reserved on the SD card.

### Resuming shooting of works in progress

- 1 Set the mode dial to .
- 2 Use   to select Works in progress .
  - Partially saved data is displayed in the index.
  -  appears on partially saved data.
- 3 Select the data with which you want to resume shooting using the arrow pad, and press the  button.
  - Shooting resumes from the previous session.



## “Point-and-shoot” photography (P program mode)

**P** mode is a shooting mode where the camera automatically sets the optimal aperture and shutter speed according to subject brightness. Set the mode dial to **P**.



- The functions you can set with the dials depend on the position of the lever.

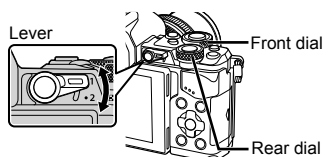

Dial	Position of the lever	
	1	2
	Exposure compensation	ISO
	Program shift	White balance

- The shutter speed and aperture selected by the camera are displayed.
- The shutter speed and aperture displays will blink if the camera is unable to achieve correct exposure.

Warning display example (blinking)	Status	Action
F2.8	The subject is too dark.	<ul style="list-style-type: none"> <li>Use the flash.</li> </ul>
F22	The subject is too bright.	<ul style="list-style-type: none"> <li>The metered range of the camera is exceeded. A commercially available ND filter (for adjusting the amount of light) is required.</li> </ul>

- The aperture value at the moment when its indication blinks varies with the lens type and focal length of the lens.
- When using a fixed [ISO] setting, change the setting. [ISO] (P. 54)

### Program shift (Ps)

In **P** and **ART** modes, you can choose different combinations of aperture value and shutter speed without altering exposure. An “s” appears next to the shooting mode display. To cancel program shift, press  $\Delta$   $\nabla$  until “s” is no longer displayed.

### Cautions

- Program shift is not available when you are using a flash.



Program shift

## Choosing aperture (A aperture-priority mode)

Mode **A** is a shooting mode where you choose the aperture and let the camera automatically adjust to the appropriate shutter speed. Rotate the mode dial to **A**. Larger apertures (lower F-numbers) decrease depth of field (the area in front of or behind the focus point that appears to be in focus), softening background details. Smaller apertures (higher F-numbers) increase depth of field.



Aperture value

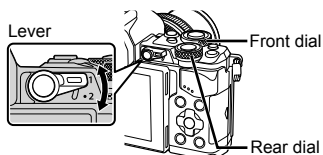

Dial	Position of the lever	
	1	2
	Exposure compensation	ISO
	Aperture value	White balance

### Setting the aperture value

Decreasing aperture value ←

→ Increasing aperture value

F2.8 ← F4.0 ← **F5.6** → F8.0 → F11

- The shutter speed display will blink if the camera is unable to achieve correct exposure.

Warning display example (blinking)	Status	Action
	The subject is underexposed.	<ul style="list-style-type: none"> <li>Decrease the aperture value.</li> </ul>
	The subject is overexposed.	<ul style="list-style-type: none"> <li>Increase the aperture value.</li> <li>If the warning display does not disappear, the metered range of the camera is exceeded. A commercially available ND filter (for adjusting the amount of light) is required.</li> </ul>

- The aperture value at the moment when its indication blinks varies with the lens type and focal length of the lens.
- When using a fixed [ISO] setting, change the setting. [ISO] (P. 54)

## Choosing shutter speed (S shutter-priority mode)

Mode **S** is a shooting mode where you choose the shutter speed and let the camera automatically adjust to the appropriate aperture. Rotate the mode dial to **S**.

A fast shutter speed can freeze a fast action scene without any blur. A slow shutter speed will blur a fast action scene. This blurring will give the impression of dynamic motion.



Shutter speed

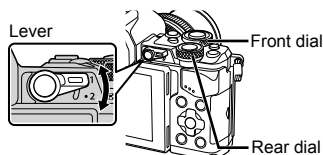

Dial	Position of the lever	
	1	2
	Exposure compensation	ISO
	Shutter speed	White balance

### Setting the shutter speed

Slower shutter speed ← → Faster shutter speed

60" ← 15 ← 30 ← **60** → 125 → 250 → 8000

- The aperture value display will blink if the camera is unable to achieve correct exposure.

Warning display example (blinking)	Status	Action
2000	The subject is underexposed.	<ul style="list-style-type: none"> <li>Set the shutter speed slower.</li> </ul>
125	The subject is overexposed.	<ul style="list-style-type: none"> <li>Set the shutter speed faster.</li> <li>If the warning display does not disappear, the metered range of the camera is exceeded. A commercially available ND filter (for adjusting the amount of light) is required.</li> </ul>

- The aperture value at the moment when its indication blinks varies with the lens type and focal length of the lens.
- When using a fixed [ISO] setting, change the setting. [ISO] (P. 54)

## Choosing aperture and shutter speed (M manual mode)



Mode **M** is a shooting mode where you choose both the aperture and shutter speed. They can be set even in bulb, time, and live composite photography, where the shutter remains open while the shutter button is pressed. Set the mode dial to **M**.

- The exposure determined by the aperture value and shutter speed you have set, and the difference relative to a suitable exposure measured by the camera are displayed on the monitor.
- Shutter speed can be set to values between 1/8000 and 60 seconds or to [BULB] or [LIVE TIME], or [LIVECOMP].

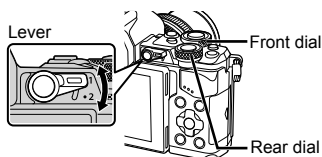

Difference from correct exposure



Dial	Position of the lever	
	1	2
	Aperture value	ISO
	Shutter speed	White balance

### Cautions

- If you change the aperture value and shutter speed, the display on the monitor (or viewfinder) will not change. To display the image as it is going to be shot, set [Live View Boost] (P. 102) in Custom Menu.
- Even when you have set [Noise Reduct.], noise and/or light spots may still be noticeable in the image displayed on the monitor and shot images under certain environmental conditions (temperature etc.) and camera settings.

### Noise in images

While shooting at slow shutter speeds, noise may appear on screen. These phenomena occur when the temperature rises in the image pickup device or image pickup device internal drive circuit, causing current to be generated in those sections of the image pickup device that are not normally exposed to light. This can also occur when shooting with a high ISO setting in a high-temperature environment. To reduce this noise, the camera activates the noise reduction function.  [Noise Reduct.] (P. 104)

## Shooting with long exposure time (BULB)

Use for night landscapes and fireworks. In **M** mode, set the shutter speed to [BULB] or [LIVE TIME].

**Bulb photography (BULB):** The shutter remains open while the shutter button is pressed. The exposure ends when the shutter button is released.

**Time photography (TIME):** The exposure begins when the shutter button is pressed all the way down. To end the exposure, press the shutter button all the way down again.

- During bulb, time, or live composite photography, the screen brightness changes automatically.  "Bulb/Time Monitor" (P. 104)

- When using [LIVE TIME], the progress of the exposure will be displayed in the monitor during shooting. The display can also be refreshed by touching the monitor.
- [Live Bulb] (P. 104) can be used to display the image exposure during bulb photography.

### Cautions

- There are limits on the available ISO sensitivity settings.
- To reduce camera blur, mount the camera on a sturdy tripod and use a remote cable (P. 143).
- During shooting, there are limits on the settings for the following functions.  
Sequential shooting/self-timer shooting/interval shooting/AE bracket shooting/image stabilizer/flash bracketing/multiple exposure\* etc.
- \* When an option other than [Off] is selected for [Live Bulb] or [Live Time] (P. 104)

## Live composite photography (dark and light field composite)

You can record a composite image from multiple shots while observing changes in bright flashes of light, such as fireworks and stars, without changing the brightness of the background.

- 1 Set an exposure time to be the reference in [Composite Settings] (P. 104).
- 2 In **M** mode, set the shutter speed to [LIVECOMP].
  - When the shutter speed is set to [LIVECOMP], you can display the [Composite Settings] by pressing the **MENU** button.
- 3 Press the shutter button once to prepare for shooting.
  - You can shoot when a message that indicates preparations are complete is displayed in the monitor.
- 4 Press the shutter button.
  - Live composite shooting begins. A composite image is displayed after each reference exposure time, allowing you to observe changes in light.
  - During composite shooting, the screen brightness changes automatically.
- 5 Press the shutter button to end shooting.
  - The maximum length of composite shooting is 3 hours. However, the available shooting time will vary depending on shooting conditions, and charging state of the camera.

### Cautions

- There are limits on the available ISO sensitivity settings.
- To reduce camera blur, mount the camera on a sturdy tripod and use a remote cable (P. 143).
- During shooting, there are limits on the settings for the following functions.  
Sequential shooting/self-timer shooting/interval shooting/AE bracket shooting/image stabilizer/flash bracketing etc.

## Recording movies

You can record movies when the mode dial is on any mode except **■** (PHOTO STORY).

- 1 Press the **⊙** button to begin recording.
  - You can change the focus location by touching the screen while recording.

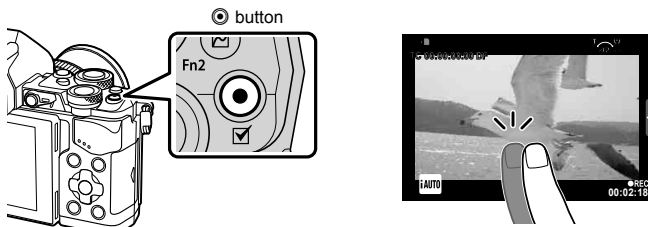

- 2 Press the **⊙** button again to end recording.

### Cautions

- When using a camera with a CMOS image sensor, moving objects may appear distorted due to the rolling shutter phenomenon. This is a physical phenomenon whereby distortion occurs in the filmed image when shooting a fast-moving subject or due to camera shaking. In particular, this phenomenon becomes more noticeable when using a long focal length.
- If the size of the movie file being recorded exceeds 4 GB, the file will be split automatically.
- When recording movies, use an SD card that supports an SD speed class of 10 or higher.
- To continuously record a movie of 4 GB or larger, do not set the image quality mode to All-Intra. Use another mode.
- If the camera is used for extended periods, the temperature of the image pickup device will rise and noise and colored fog may appear in images. Turn off the camera for a short time. Noise and colored fog may also appear in images recorded at high ISO sensitivity settings. If the temperature rises further, the camera will turn off automatically.
- When using a Four Thirds system lens, the AF will not operate while recording movies.
- The **⊙** button cannot be used to record movies in the following instances:
  - Multiple exposure (still photography also ends.)
  - shutter button pressed halfway/during bulb, time or composite photography/sequential shooting/Panorama/SCN mode (e-Portrait, Hand-Held Starlight, 3D)
  - time lapse shooting

## Using movie mode (🎥)

With movie mode (🎥), you can create movies that take advantage of the effects available in still photography mode. Use live control to select the settings. 🖱️ “Adding effects to a movie” (P. 74)

You can also apply an after-image effect or zoom in on an area of the image during movie recording.

### ■ Adding effects to a movie [Movie Effect]

- 1 Rotate the mode dial to 🎥.
- 2 Press the ⏻ button to begin recording.
  - Press the ⏻ button again to end recording.
- 3 Touch the on-screen icon of the effect you wish to use.

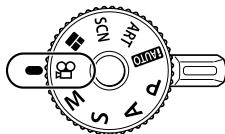

	<b>Art Fade</b>	Film with the selected picture mode effect. The fade effect is applied to the transition between scenes.
	<b>Old Film</b>	Randomly apply damage and dust-like noise similar to old movies.
	<b>Multi Echo</b>	Apply an after-image effect. After-images will appear behind moving objects.
	<b>One Shot Echo</b>	An after-image will appear for a short time after you press the button. The after-image will disappear automatically after a while.
	<b>Movie Tele-converter</b>	Zoom in on an area of the image without using the lens zoom. Zoom in on the selected position of the image even while the camera is kept fixed.

#### **Art Fade**

Touch the icon. The effect will be applied gradually when you release your finger.

#### **Old Film**

Touch the icon for the effect to be applied. Touch again to cancel the effect.

#### **Multi Echo**



Touch the icon to apply the effect. Touch again to cancel the effect.

#### **One Shot Echo**

Each touch of the icon adds to the effect.



## Movie Tele-converter

- 1 Touch the icon to display the zoom frame.
  - You can change the position of the zoom frame by touching the screen or using  $\Delta \nabla \langle \rangle$ .
  - Press and hold  $\odot$  to return the zoom frame to a central position.
- 2 Touch  or press the **Fn2** button to zoom in on the area in the zoom frame.
  - Touch  or press the **Fn2** button to return to the zoom frame display.
- 3 Touch  or press  $\odot$  to cancel the zoom frame and exit Movie tele-converter mode.

### Cautions

- The frame rate will drop slightly during recording.
- The 2 effects cannot be applied simultaneously.
- Use a memory card with an SD speed class of 10 or better. Movie recording may end unexpectedly if a slower card is used.
- When mode1 has been set for taking photographs during movie recording (P. 108), you cannot take photographs while using other movie effects than Movie Tele-converter.
- [e-Portrait] and [Diorama] cannot be used at the same time as Art Fade.
- The sound of touch operations and button operations may be recorded.
- Art Fade cannot be used when shooting clips.
- When shooting slow/quick motion movies, you cannot use other movie effects than Movie Tele-converter.

## Taking photographs during movie recording (Movie+Photo Mode)

- Press the shutter button during movie recording to record one of the frames of the movie as a photograph. To end movie recording, press the  $\odot$  button. The photograph and movie files will be recorded separately to the memory card. The record mode of the photographs will be  $\text{M/N}$  (16:9).
- There is also a way of recording a photograph of a higher quality.  [Movie+Photo Mode] (P. 108)

### Cautions

- You cannot take photographs while recording clips or slow/quick motion when [Movie+Photo Mode] is set to [mode1]. Set the frame rate to 30p or less. The number of photographs may be limited.
- The autofocus and metering used in movie mode may differ from that used to take photographs.

## Using the silencing function when shooting a movie

You can prevent the camera from recording operating sounds that occur due to camera operations while shooting.

The following functions are available as touch operations.

- Power zoom\*/headphone volume/recording volume/aperture/shutter speed/exposure compensation/ISO sensitivity
- \* Only available with power zoom lenses

Touch the silent shooting tab to display the function items.

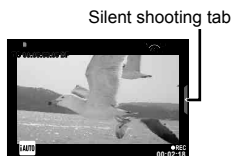

After touching an item, touch the displayed arrows to select the settings.









## Shooting “My Clips”



You can create a single My Clips movie file including multiple short movies (clips). You can also add still pictures to the My Clips movie.

### ■ Shooting

- 1 Rotate the mode dial to .
- 2 Press  to display the live control, and select movie image quality mode using the rear dial.









- 3 Use the front dial to select **MOV**  **30p** for shooting movie clips and press .
  - Press the **INFO** button to change [Frame Rate] and [Clip Recording Time].
- 4 Press the  button to start shooting.
  - The recording ends automatically when the preset shooting time has elapsed, and a screen for checking the recorded movie is displayed. Press the  button to save your clip and begin shooting the next one.
  - If you press the  button again during shooting, the shooting will continue while the button is held down (up to a maximum of 16 seconds).
- 5 Press the  button to shoot the next clip.
  - The confirmation screen will disappear and shooting of the next clip will start.
  - To delete the clip you have shot or save it in a different My Clips, perform the following on the confirmation screen.

	My Clips will be played back, starting from the beginning.
	Changes the My Clips in which to save the clip and the position at which to add the new clip.
	Deletes the shot clip without saving it.

- Press the shutter button half-way down to add the next shot. The clip is saved in the same My Clips as the previous clip.
- Clips with different frame rate and number of pixels will be stored in different My Clips.

### ■ Playback

You can play back the files in My Clips consecutively.

- 1 Press  and select an image marked .
- 2 Press  and select [Play My Clips] using  . Then press  again.
  - The files in My Clips will play back consecutively.
  - Press  to end the consecutive playback.

## Editing “My Clips”

You can create a single movie file from My Clips.

The shot clips are stored in My Clips. You can add movie clips and still pictures to My Clips. You can also add screen transition effects and art filter effects.

- 1 Press and then turn the rear dial to play back My Clips.

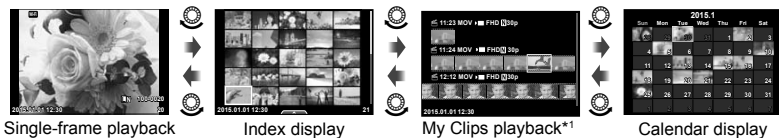

\*1 If one or more My Clips have been created, it will be displayed here (P. 42)

- 2 Use  $\Delta$   $\nabla$  or touch the screen to select My Clips to use.
- 3 Select an item using  $\Delta$   $\nabla$  and press the button.

<b>Play My Clips</b>	Plays back the files in My Clips in order, starting from the beginning.
<b>Play Movie</b>	When a movie file has been selected, you can control playback in movie mode.
<b>Rearrange Order</b>	Move or add files in My Clips.
<b>Preset Destination</b>	From the next time you shoot, movies shot in the same image quality mode will be added to this  My Clips.
<b>Delete My Clips</b>	Deletes all unprotected files from My Clips.
<b>Erase</b>	Press the  button during playback of the image you wish to delete from My Clips. Select [Yes] and press  to delete.

- 4 Display My Clips from which you wish to create the movie. Select [Export My Clips] and press .
- 5 Select an item using  $\Delta$   $\nabla$  and press the button.

<b>Clip Effects</b>	You can apply 6 types of art effects.
<b>Transition Effect</b>	You can apply fade effects.
<b>BGM</b>	Set [Joy] or [Off].
<b>Recorded Clip Volume</b>	Set BGM to [Joy] to set a volume for sounds recorded in the movie.
<b>Recorded Clip Sound</b>	Set [On] to create a movie with the recorded sound. This setting is only available when BGM is set to [Off].
<b>Preview</b>	Preview the files of the edited My Clips in order, starting from the first file.

- 6** When you have finished the editings, select [Begin Export] and press **OK**.
- The combined album is saved as a single movie.
  - Exporting a movie may take some time.
  - The maximum length for My Clips is 15 minutes and the maximum file size is 4 GB.
  - My Clips will be recorded in Full HD and Fine.

### Cautions

- It may take a while for My Clips to display after taking out, inserting, erasing, or protecting the card.
- You can record a maximum of 99 My Clips and a maximum of 99 cuts per clip. The maximum values may vary depending on the file size and length of My Clips.
- You cannot add movies other than clips to My Clips.

## Shooting slow/quick motion movies

You can create slow motion or quick motion movies.

You can set the recording speed using **MOV** in image quality mode.

- 1** Rotate the mode dial to **MOV**.

- 2** Press **OK** to display the live control, and select movie image quality mode using the rear dial.



- 3** Use the front dial to select **MOV** **FHD** **30p** (custom image quality mode) and press **OK**.

- 4** Use the rear dial to select a recording speed, then press **OK**.
- Increase the recording speed multiplication factor to shoot a quick motion movie.
  - Reduce the multiplication factor to shoot a slow motion movie.

- 5** Press the **REC** button to start shooting.
- Press the **OK** button again to end shooting.
  - The movie will be played back at a fixed speed so that it appears to be in slow motion or quick motion.

### Cautions

- Sound will not be recorded.
- Any picture mode art filters will be canceled.
- You cannot set slow/quick motion shooting when the bit rate is [All-Intra].
- You cannot set slow/quick motion shooting when the frame rate is [60p] or [50p].

## Using shooting options

### Calling shooting options

You can call up especially often-used shooting options using pre-allocated buttons. To select shooting options not assigned to buttons, use the LV super control panel that displays the current status of the shooting settings. Touch or use the arrow pad to select options and change the settings. When not using live view shooting, you can display the normal super control panel on the monitor.

#### LV super control panel

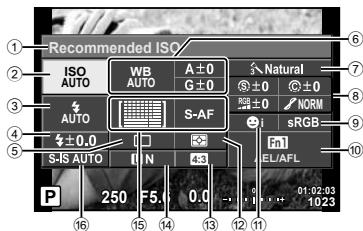

#### Super control panel

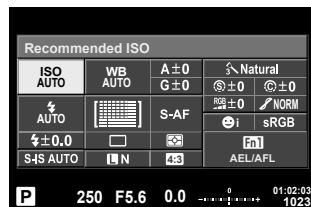

#### Settings that can be modified using LV super control panel

- |  |  |
|--|--|
| ① Currently selected option                | ⑨ Color space.....P. 73                |
| ② ISO sensitivity.....P. 54                | ⑩ Button function assignment.....P. 66 |
| ③ Flash mode.....P. 63                     | ⑪ Face priority.....P. 49              |
| ④ Flash intensity control.....P. 66        | ⑫ Metering mode.....P. 54              |
| ⑤ Sequential shooting/Self-timer.....P. 58 | ⑬ Aspect ratio.....P. 60               |
| ⑥ White balance.....P. 55                  | ⑭ Record mode.....P. 61, 62            |
| White balance compensation.....P. 56       | ⑮ AF mode.....P. 51                    |
| ⑦ Picture mode.....P. 70                   | AF target.....P. 48                    |
| ⑧ Sharpness (S).....P. 71                  | ⑯ Image stabilizer.....P. 57           |
| Contrast (C).....P. 71                     |  |
| Saturation (RGB).....P. 71                 |  |
| Gradation (L).....P. 72                    |  |
| B&W Filter (F).....P. 72                   |  |
| Picture tone (T).....P. 73                 |  |

#### Cautions

- Not displayed in movie mode and PHOTO STORY mode.
- When you are using the normal super control panel display, the camera will enter sleep mode if no operation is performed for 3 seconds. The camera can be reactivated by pressing the shutter button. "Quick Sleep Mode" (P. 110)

- 1 Press the **OK** button in **P/A/S/M** modes.
  - The super control panel is displayed.
- 2 Tap the desired item.
  - The item will be highlighted.
- 3 Turn the front dial to change a setting.

### Notes

- You can also perform operations using the dials. Use the rear dial to select items and the front dial to change settings.
- If you have set up a custom menu in advance, you can display the super control panel when using **FAUTO**, **SCN** or **ART**.

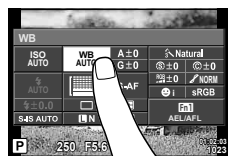

### Live control

In movie mode and PHOTO STORY mode, you can use live control to select the shooting function while checking the effect on the screen.

When the controls in **Control Settings** is set to [Live Control], you can use live control even in **FAUTO**, **P**, **A**, **S**, **M**, **ART** and **SCN** modes. (P. 102)

Live control screen

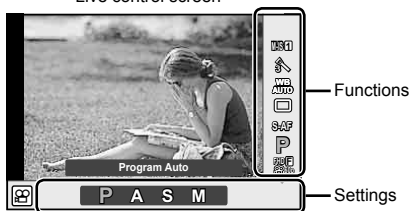

### Available settings

Image stabilizer* .....	P. 57	 mode* .....	P. 40
Picture mode* .....	P. 70	Flash mode .....	P. 63
Scene mode .....	P. 28	Flash intensity control .....	P. 66
Art filter mode .....	P. 30	Metering mode .....	P. 54
White balance* .....	P. 55	AF mode* .....	P. 51
Sequential shooting/Self-timer* .....	P. 58	ISO sensitivity* .....	P. 54
Aspect ratio .....	P. 60	Face priority* .....	P. 49
Record mode* .....	P. 62	Movie sound record* .....	P. 74

\* Available in  mode.

## 1 Press **OK** to display the live control.

- To hide the live control, press **OK** again.

## 2 Use the rear dial to select the settings, use the front dial to change the selected setting, and press **OK**.

- The selected settings take effect automatically if no operations are performed for about 8 seconds.

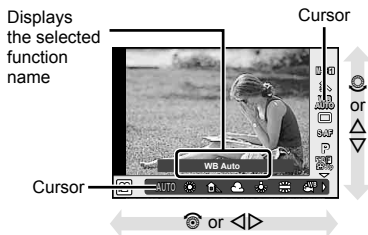

### Cautions

- Some items are not available in some shooting modes.

## Controlling exposure (exposure compensation)

Rotate the front dial to choose exposure compensation. Choose positive (“+”) values to make pictures brighter, negative (“-”) values to make pictures darker. Exposure can be adjusted by  $\pm 5.0$  EV.



Negative (-)



No compensation (0)



Positive (+)

### Cautions

- Exposure compensation is not available in **Auto**, **M**, or **SCN** mode.
- The viewfinder and live view display can only be changed up to  $\pm 3.0$  EV. If the exposure exceeds  $\pm 3.0$  EV, the exposure bar will begin flashing.
- Movies can be corrected in a range up to  $\pm 3.0$  EV.

## Locking the exposure (AE Lock)

You can lock just the exposure by pressing the **Fn1** button. Use this when you want to adjust the focus and exposure separately or when you want to shoot several images at the same exposure.

- If you press the **Fn1** button once, the exposure is locked and **AEL** is displayed.  
 “AEL/AFL” (P. 110)
- Press the **Fn1** button once again to release the AE Lock.

### Cautions

- The lock will be released if you operate the mode dial, **MENU** button, or **OK** button.

## Setting the AF target (AF Area)

Choose which of the 81 autofocus targets will be used for autofocus.

- 1 Press the arrow pad to display the AF target.
- 2 Use  $\Delta \nabla \triangleleft \triangleright$  to change to single target display and select the AF position.
  - “All targets” mode is restored if you move the cursor off the screen.

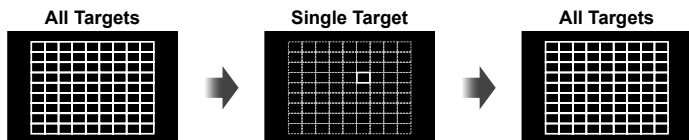

The camera automatically chooses from the full set of focus targets.

Select the focus target manually.

### Cautions





- When using a Four Thirds system lens, the camera automatically switches to single target mode.
- The size and number of the AF target changes depending on the [Digital Tele-converter], [Image Aspect], and group target settings.

## Using small target and group target (Setting AF target)

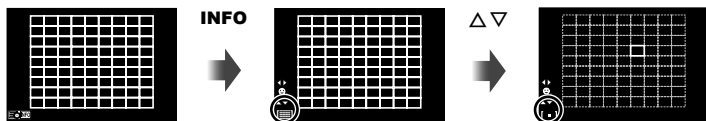
You can change the target selection method and target size. You can also select Face priority AF (P. 49).

- 1 Press the arrow pad to display the AF target.
- 2 Press the **INFO** button during AF target selection and choose a selection method using  $\Delta \nabla$ .



 <b>(All Targets)</b>	The camera selects automatically from among all the AF targets.
 <b>(Single Target)</b>	You select a single AF target.
 <b>(Small Target)</b>	The AF target can be reduced in size.
 <b>(Group Target)</b>	The camera automatically chooses from the targets in the selected group.

### Cautions

- When shooting movies, the camera automatically switches to single target mode.
- When using a Four Thirds system lens, the camera automatically switches to single target mode.



## Face priority AF/pupil detection AF

The camera detects faces and adjusts focus and digital ESP.

- 1 Press the arrow pad to display the AF target.
- 2 Press the **INFO** button.
  - You can change the AF target selection method.
- 3 Use  $\triangleleft \triangleright$  to select an option and press  $\odot$ .

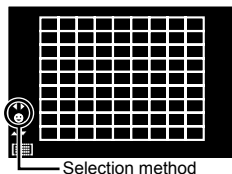

$\text{OFF}$ Face Priority Off	Face priority off.
$\odot$ Face Priority On	Face priority on.
$\odot$ Face & Eye Priority On	The autofocus system selects the pupil of the eye closest to the camera for face-priority AF.
$\odot$ Face & R. Eye Priority On	The autofocus system selects the pupil of the eye on the right for face-priority AF.
$\odot$ Face & L. Eye Priority On	The autofocus system selects the pupil of the eye on the left for face-priority AF.

- 4 Point the camera at your subject.
  - If a face is detected, it will be indicated by a white border.
- 5 Press the shutter button halfway to focus.
  - When the camera focuses on the face in the white border, the border will turn green.
  - If the camera is able to detect the subject's eyes, it will display a green frame over the selected eye. (pupil detection AF)
- 6 Press the shutter button the rest of the way down to shoot.

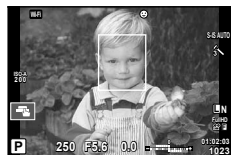

### Cautions

- Face priority applies only to the first shot in each sequence taken during sequential shooting.
- Depending on the subject and the art filter setting, the camera may not be able to correctly detect the face.
- When set to  $\text{[ESP]}$  (Digital ESP metering), metering is performed with priority given to faces.

### Notes

- Face priority is also available in [MF]. Faces detected by the camera are indicated by white frames.

## Zoom frame AF/zoom AF (Super Spot AF)

You can zoom in on a portion of the frame when adjusting focus. Choosing a high zoom ratio allows you to use autofocus to focus on a smaller area than is normally covered by the AF target. You can also position the focus target more precisely.

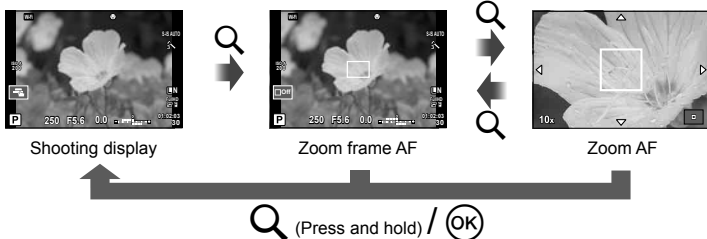

- 1 Pre-assign **Q** (zoom icon) to one of the buttons using [Button Function] (P. 66).
- 2 Press the **Q** button to display the zoom frame.
  - If the camera was focused using autofocus just before the button was pressed, the zoom frame will be displayed at the current focus position.
  - Use  $\Delta \nabla \triangleleft \triangleright$  to position the zoom frame.
  - Press the **INFO** button and use  $\Delta \nabla$  to choose the zoom ratio. ( $\times 3$ ,  $\times 5$ ,  $\times 7$ ,  $\times 10$ ,  $\times 14$ )
- 3 Press the **Q** button again to zoom in on the zoom frame.
  - Use  $\Delta \nabla \triangleleft \triangleright$  to position the zoom frame.
  - You can change the zoom ratio by rotating the front dial ( $\odot$ ) or rear dial ( $\ominus$ ).
- 4 Press the shutter button halfway to initiate autofocus.
  - The camera will focus using the subject in the frame at the center of the screen. To change the focus position, move it by touching the screen.



### Notes

- You can also display and move the zoom frame using touch screen operations.

### Cautions

- Zoom is visible only in the monitor and has no effect on the resulting photographs.
- When you are using a Four Thirds system lens, the AF will not operate with during zoom display.
- While zoomed in, a sound is made by the IS (Image Stabilizer).

## Choosing a focus mode (AF mode)

Select a focusing method (focus mode).

You can choose separate focusing methods for still photography mode and  mode.

- 1 Press the  button and select AF mode.

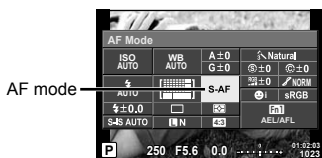

- 2 Select an item using the front dial and press the  button.

- The selected AF mode is displayed on the monitor.

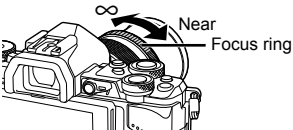
<b>S-AF</b> (single AF)	<p>The camera focuses once when the shutter button is pressed halfway. When the focus is locked, a beep sounds, and the AF confirmation mark and the AF target mark light up. This mode is suitable for taking pictures of still subjects or subjects with limited movement.</p>
<b>C-AF</b> (continuous AF)	<p>The camera repeats focusing while the shutter button remains pressed halfway. When the subject is in focus, the AF confirmation mark lights up on the monitor and the beep sounds when the focus is locked at the first time.</p> <p>Even if the subject moves or you change the composition of the picture, the camera continues trying to focus.</p> <ul style="list-style-type: none"> <li>• When using a Four Thirds system lens, this setting will change to [S-AF].</li> </ul>
<b>MF</b> (manual focus)	<p>This function allows you to manually focus on any position by operating the focus ring on the lens.</p> 
<b>S-AF+MF</b> (simultaneous use of S-AF mode and MF mode)	<p>After pressing the shutter button halfway to focus in [S-AF] mode, you can turn the focus ring to fine-adjust focus manually.</p>
<b>C-AF+TR</b> (AF tracking)	<p>Press the shutter button halfway to focus; the camera then tracks and maintains focus on the current subject while the shutter button is held in this position.</p> <ul style="list-style-type: none"> <li>• The AF target is displayed in red if the camera can no longer track the subject. Release the shutter button and then frame the subject again and press the shutter button halfway.</li> <li>• When using a Four Thirds system lens, this setting will change to [S-AF].</li> </ul>

### Cautions

- The camera may be unable to focus if the subject is poorly lit, obscured by mist or smoke, or lacks contrast.
- When using a Four Thirds system lens, AF will not be available during movie recording.
- You cannot set the AF mode if the MF focus latch of the lens is set to MF. (P. 136)

## Changing the brightness of highlights and shadows

When the multi-function button is set to [Highlight&Shadow Control], a setting screen will be displayed when you press the **Fn2** button. Adjust the shadow using the rear dial and the highlight using the front dial.

Press and hold the **OK** button to cancel the setting.

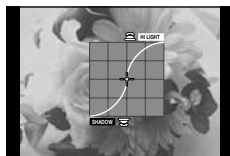

## Controlling color (Color Creator)

You can adjust the color of the subject while watching the changes on the display. Color Creator is one of the functions you can call up with the multi-function button. The multi-function button is assigned to **Fn2** in the initial settings.

### Assigning the color function to the multi-function button

- 1 Press and hold the **Fn2** button and rotate the front dial.
  - The multi-function menu is displayed.
- 2 Select the Color Creator and release the button.

### Using the color creator

- 1 Press the **Fn2** button.
  - An options screen will be displayed.

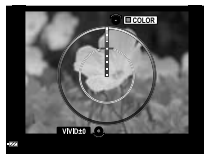
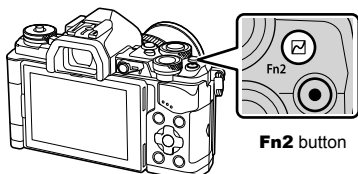

- 2 Set hue using the front dial and saturation using the rear dial.
  - Press and hold the **OK** button to cancel any changes.
  - Press the **MENU** button to exit the Color Creator without changing settings.
- 3 Press the **OK** button to save changes.
  - The settings are stored in **(C)** (Color Creator) of picture mode (P. 70).

### Cautions

- The white balance is fixed to AUTO.
- When the image quality mode is set to [RAW], the image is recorded in RAW+JPEG.

## Taking HDR (High Dynamic Range) images

The camera shoots several images and automatically combines them into an HDR image. You can also shoot several images and perform HDR imaging on a computer (HDR bracketing photography). Exposure compensation is available with [HDR1] and [HDR2] in **P**, **A**, and **S** modes. In mode **M**, exposure can be adjusted as desired for HDR photography.

- 1 Select a setting by turning the rear dial while holding down the **HDR** button.
  - A menu will be displayed on the screen.
  - Press the **HDR** button to switch HDR recording on or off.

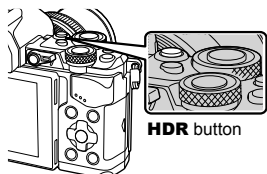

When shooting using live view

<b>HDR1</b>	Four shots are taken, each with a different exposure, and the shots are combined into one HDR image inside the camera.
<b>HDR2</b>	HDR2 provides a more impressive image than HDR1. ISO sensitivity is fixed to 200. Also, the slowest available shutter speed is 1 second and the longest available exposure is 4 seconds.
<b>3F 2.0EV</b>	HDR bracketing is performed. Select the number of images and the exposure difference. HDR imaging processing is not performed.
<b>5F 2.0EV</b>	
<b>7F 2.0EV</b>	
<b>3F 3.0EV</b>	
<b>5F 3.0EV</b>	

- 2 Shoot.
  - When you press the shutter button, the camera automatically shoots the set number of images.

### Cautions

- If you shoot with a slower shutter speed, there may be more noticeable noise.
- Attach the camera to a tripod or other stabilizing item and then shoot.
- The image displayed on the monitor or in the viewfinder while shooting will differ from the HDR-processed image.
- In the case of [HDR1] and [HDR2], the HDR-processed image will be saved as a JPEG file. When the image quality mode is set to [RAW], the image is recorded in RAW+JPEG. The only image recorded in RAW is the image with suitable exposure.
- If set to [HDR1]/[HDR2], the picture mode is fixed to [Natural] and the color setting is fixed to [sRGB]. [Full-time AF] does not operate.
- Flash photography, bracketing, multiple exposure and time lapse shooting cannot be used at the same time as HDR photography.

## Choosing how the camera measures brightness (metering)

Choose how the camera meters subject brightness.

- 1 Press the **OK** button and select metering.



- 2 Select an item using the front dial and press the **OK** button.

	<b>Digital ESP metering</b>	The camera meters exposure in 324 areas of the frame and optimizes exposure for the current scene or (if an option other than [OFF] is selected for [Face Priority]) portrait subject. This mode is recommended for general use.
	<b>Center weighted averaging metering</b>	This metering mode provides the average metering between the subject and the background lighting, placing more weight on the subject at the center.
	<b>Spot metering</b>	Choose this option to meter a small area (about 2% of the frame) with the camera pointed at the object you wish to meter. Exposure will be adjusted according to the brightness at the metered point.
	<b>Spot metering - highlight</b>	Increases spot metering exposure. Ensures bright subjects appear bright.
	<b>Spot metering - shadow</b>	Lowers spot metering exposure. Ensures dark subjects appear dark.

- 3 Press the shutter button halfway.

- Normally, the camera will start metering when the shutter button is pressed halfway and lock exposure while the shutter button is held in this position.

## ISO sensitivity

Increasing ISO sensitivity increases noise (graininess) but allows photographs to be taken when lighting is poor. The setting recommended in most situations is [AUTO], which starts at ISO 200 — a value that balances noise and dynamic range — and then adjusts ISO sensitivity according to shooting conditions.

- 1 Press **OK** to select ISO sensitivity.

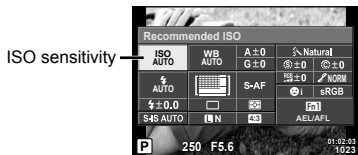

- 2 Select an item using the front dial and press the **OK** button.

<b>AUTO</b>	The sensitivity is set automatically according to the shooting conditions.
<b>LOW, 200 – 25600</b>	Sensitivity is set to the selected value.

## Adjusting color (white balance)

White balance (WB) ensures that white objects in images recorded by the camera appear white. [AUTO] is suitable in most circumstances, but other values can be selected according to the light source when [AUTO] fails to produce the desired results or you wish to introduce a deliberate color cast into your images.

- 1 Press  $\odot$  to select white balance.

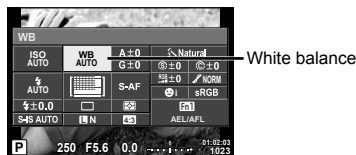

- 2 Select an item using the front dial and press the  $\odot$  button.

WB mode		Color temperature	Light conditions
<b>Auto white balance</b>	<b>AUTO</b>	—	Used for most light conditions (when there is a white portion framed on the monitor). Use this mode for general use.
<b>Preset white balance</b>		5300K	For shooting outdoors on a clear day, or to capture the reds in a sunset or the colors in a fireworks display
		7500K	For shooting outdoors in the shadows on a clear day
		6000K	For shooting outdoors on a cloudy day
		3000K	For shooting under a tungsten light
		4000K	For subjects lit by fluorescent lights
		—	For underwater photography
<b>One-touch white balance (P. 56)</b>		5500K	For flash shooting
		Color temperature set by one-touch WB.	Choose when a white or gray subject can be used to measure white balance and the subject is under mixed lighting or lit by an unknown type of flash or other light source.
<b>Custom white balance</b>	<b>CWB</b>	2000K–14000K	After pressing the <b>INFO</b> button, use $\triangleleft$ $\triangleright$ buttons to select a color temperature and then press $\odot$ .

### Cautions

- When [Color Creator] is set, the white balance is fixed to AUTO.

### One-touch white balance

Measure white balance by framing a piece of paper or other white object under the lighting that will be used in the final photograph. This is useful when shooting a subject under natural light, as well as under various light sources with different color temperatures.

- 1 Select [WB1], [WB2], [WB3] or [WB4] (one-touch white balance 1, 2, 3 or 4) and press the **INFO** button.
- 2 Photograph a piece of colorless (white or gray) paper.
  - Frame the object so that it fills the display and no shadows fall it.
  - The one-touch white balance screen appears.
- 3 Select [Yes] and press **OK**.
  - The new value is saved as a preset white balance option.
  - The new value is stored until one-touch white balance is measured again. Turning the power off does not erase the data.

#### Tips

- If the subject is too bright or too dark or visibly tinted, the message [WB NG Retry] will be displayed and no value will be recorded. Correct the problem and repeat the process from Step 1.

### Making fine adjustments to white balance (white balance compensation)

You can set and finely adjust the compensation values for both auto white balance and preset white balance.

- 1 Press **OK** and select the white balance that you want to correct.
- 2 Use the front dial to select the compensation axis and the rear dial to change the compensation value.

#### For compensation on the A axis (Red-Blue)

Move the bar in the + direction to emphasize red tones and in the – direction to emphasize blue tones.

#### For compensation on the G axis (Green-Magenta)

Move the bar in the + direction to emphasize green tones and in the – direction to emphasize magenta tones.



#### Notes

- To check the corrected white balance, press **OK**. A sample image shot with the current white balance settings will be displayed.
- To set the same white balance in all white balance modes, use [All **WB**] (P. 105).



## Reducing camera shake (image stabilizer)

You can reduce the amount of camera shake that can occur when shooting in low light situations or shooting with high magnification. The image stabilizer starts when you press the shutter button halfway.

- 1 Press the **OK** button and select the image stabilizer.

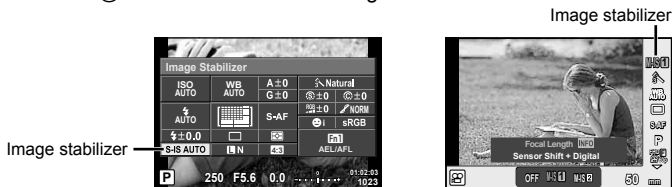

- 2 Select an item using the front dial and press the **OK** button.

Still picture	OFF	Still-I.S. Off	Image stabilizer is off.
	S-IS1	All Direction Shake I.S.	Image stabilizer is on.
	S-IS2	Vertical Shake I.S.	Image stabilization applies only to vertical ( <b>I</b> ) camera shake.
	S-IS3	Horizontal Shake I.S.	Image stabilization applies only to horizontal ( <b>H</b> ) camera shake. Use when panning the camera horizontally with the camera held in portrait orientation.
	S-IS AUTO	Auto I.S.	The camera detects the panning direction and applies the appropriate image stabilization.
Movie	OFF	Movie-I.S. Off	Image stabilizer is off.
	M-IS1	All Direction Shake I.S.	The camera uses both sensor shift (VCM) and electronic correction.
	M-IS2	All Direction Shake I.S.	The camera uses sensor shift (VCM) correction only. Electronic correction is not used.

### Choosing a focal length (Micro Four Thirds/Four Thirds System lenses excluded)

Use focal length information to reduce camera shake when shooting with lenses that are not Micro Four Thirds or Four Thirds system lenses.

- Select [Image Stabilizer], press the **INFO** button, use **<|>** to select a focal length, and press **OK**.
- Choose a focal length between 8 mm and 1000 mm.
- Choose the value that most closely matches to the one that is printed on the lens.

### Cautions

- The image stabilizer cannot correct excessive camera shake or camera shake that occurs when the shutter speed is set to the slowest speed. In these cases, it is recommended that you use a tripod.
- When using a tripod, set [Image Stabilizer] to [OFF].
- When using a lens with an image stabilization function switch, priority is given to the lens side setting.
- When priority is being given to the lens side image stabilization and the camera side is set to [S-IS AUTO], [S-IS1] is used instead of [S-IS AUTO].
- You may notice an operating sound or vibration when the image stabilizer is activated.







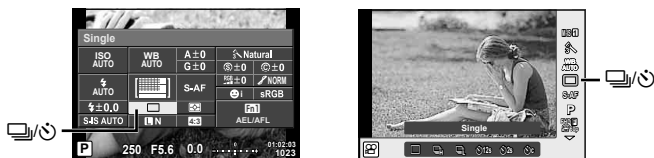







## Sequential shooting/using the self timer

Keep the shutter button pressed all the way down to take a series of photos. Alternatively, you can take pictures using the self timer.

- 1 Press the  button to select  (sequential shooting/self timer).





- 2 Select an item using the front dial and press the  button.

	<b>Single-frame shooting</b>	Shoots 1 frame at a time when the shutter button is pressed (normal shooting mode, single-frame shooting).
	<b>Sequential H</b>	Photographs are taken at about 10 frames per second (fps) while the shutter button is pressed all the way down. Focus, exposure, and white balance are fixed at the values for the first shot in each series.
	<b>Sequential L</b>	Photographs are taken at about 5 frames per second (fps) while the shutter button is pressed all the way down. Focus and exposure are fixed according to the options selected for [AF Mode] (P. 51) and [AEL/AFL] (P. 110).
	<b>Self-timer 12 SEC</b>	Press the shutter button halfway to focus, the rest of the way down to start the timer. First, the self-timer lamp lights up for approximately 10 seconds, then it blinks for approximately 2 seconds and the picture is taken.
	<b>Self-timer 2 SEC</b>	Press the shutter button halfway to focus, the rest of the way down to start the timer. The self-timer lamp blinks for approximately 2 seconds, and then the picture is taken.
	<b>Custom Self-timer</b>	Press the <b>INFO</b> button to set [  Timer], [Frame], [Interval Time], and [Every Frame AF]. Select a setting using  , and adjust the setting by using the front dial (  ). If [Every Frame AF] is set to [ON], each frame is automatically focused before shooting.
	<b>Anti-Shock[]</b>	The miniscule camera shaking caused by shutter movements can be reduced during continuous shooting and self-timer mode (P. 59).
	<b>Silent[]</b>	Shoot without recording the sound of the shutter in sequential shooting and self timer mode (P. 59).
	<b>High Res Shot</b>	Shoot still pictures in a higher resolution (P. 60).

### Notes

- To cancel the activated self-timer, press .

## Cautions





- When you are using , no confirmation image is displayed during shooting. The image is displayed again after shooting ends. When you are using , the image shot immediately before is displayed.
- The speed of sequential shooting varies depending on the lens you are using and the focus of the zoom lens.
- During sequential shooting, if the battery check blinks due to low battery, the camera stops shooting and starts saving the pictures you have taken on the card. The camera may not save all of the pictures depending on how much battery power remains.
- Fix the camera securely on a tripod for self-timer shooting.
- If you stand in front of the camera to press the shutter button when using the self-timer, the photograph may be out of focus.

## Shooting without the vibration caused by shutter button operations (Anti-Shock [)

To prevent camera shake caused by the small vibrations that occur during shutter operations, shooting is performed using an electronic front-curtain shutter.

This is used when shooting with a microscope or a super telephoto lens.





You can change the time between the shutter button is pressed all the way down and the shutter is released in [Anti-Shock[ Shooting menu 2. Set to [Off] to hide this setting item. (P. 95)

- 1 Press the  button to select / (sequential shooting/self timer).
- 2 Select one of the items marked  using the front dial and press the  button.
- 3 Shoot.
  - When the set time has elapsed, the shutter is released and the image is shot.

## Shooting without shutter sound (Silent[

In situations where the shutter sound is a problem, you can shoot without making a sound. Shooting is performed using electronic shutters for both the front and rear curtains so that the miniscule camera shaking caused by shutter movements can be reduced, just as in anti-shock shooting.

You can change the time between the shutter button is pressed all the way down and the shutter is released in [Silent[ Shooting menu 2. Set to [Off] to hide this setting item. (P. 95)

- 1 Press the  button to select / (sequential shooting/self timer).
- 2 Select one of the items marked  using the front dial and press the  button.
- 3 Shoot.
  - When the shutter is released, the monitor screen will go dark for a moment. No shutter sound will be emitted.





## Cautions

- If the subject is moving, it may cause distortion in the image.
- Distortion of the image may occur due to flickering from large movements of the subject or fluorescent lighting.

## Shooting still pictures in a higher resolution (High Res Shot)

When shooting an unmoving subject, you can shoot pictures in a higher resolution. A high resolution image is recorded by shooting several times while moving the imaging sensor. Please shoot with the camera fixed to a tripod or similar.

You can change the time between the shutter button is pressed all the way down and the shutter is released in [High Res Shot] in  Shooting menu 2. Set to [Off] to hide this setting item (P. 95). After setting high resolution shot, you can select the image quality of the high resolution shooting using image quality mode (P. 61).



- 1 Press the  button to select  (sequential shooting/self timer).
- 2 Select  using the front dial and press the  button.
- 3 Shoot.
  - If the camera is unstable,  will blink. Wait for the blinking to stop before shooting.

### Cautions

- Image quality is fixed to .
- When image quality is set to RAW+JPEG, the camera saves a single RAW image (extension ".ORI") before combining it into a High Res Shot. Pre-combination RAW images can only be played back on the software that comes with this camera.
- When shooting under fluorescent lighting etc., image quality may deteriorate.
- [Image Stabilizer] is set to [Off].

## Setting the image aspect

You can change the aspect ratio (horizontal-to-vertical ratio) when taking pictures. Depending on your preference, you can set the aspect ratio to [4:3] (standard), [16:9], [3:2], [1:1], or [3:4].

- 1 Press the  button and select an aspect ratio.
- 2 Use the front dial to select an aspect ratio and press the  button.

### Cautions

- JPEG images are cropped to the selected aspect ratio; RAW images, however, are not cropped but are instead saved with information on the selected aspect ratio.
- When RAW images are played back, the selected aspect ratio is shown by a frame.

## Selecting image quality (still image quality mode)

You can set an image quality mode for still images. Select a quality suitable for the application (such as for processing on PC, use on website etc.).

- 1 Press **OK** to select the image quality mode for still images.



Still image quality mode

- 2 Select an item using the **<>** and press the **OK** button.

Choose from JPEG (**L**F, **L**N, **M**N, and **S**N) and RAW modes. Choose a JPEG+RAW option to record both a JPEG and a RAW image with each shot. JPEG modes combine image size (**L**, **M**, and **S**) and compression ratio (SF, F, N, and B).

When you want to select a combination other than **L**F/**L**N/**M**N/**S**N, change the [**Set**] (P. 105) settings in Custom Menu.

After setting High Res Shot (P. 60), you can select between **S**L**F** and **S**L**F**+RAW.



### RAW image data

This format (extension “.ORF”) stores unprocessed image data for later processing. RAW image data cannot be viewed using other cameras or software, and RAW images cannot be selected for printing. JPEG copies of RAW images can be created using this camera.

**Info** “Editing still images” (P. 96)

## Selecting image quality (movie image quality mode)













Set a movie image quality mode suitable for the desired use.

- 1 Set the mode dial to .
- 2 Press the  button to display the live control, and select a movie image quality mode using the rear dial.



Movie image quality mode

- 3 Select an item using the front dial.
  - To change the settings in the image quality modes, press the **INFO** button and change settings using the rear dial.

Record mode	Application	Settings you can change
MOV  FHD  30p (Full HD Fine 30p)*1	Shooting clips (P. 42)	Frame rate Shooting time
MOV  FHD  60p (Full HD Fine 60p)*1	Setting 1	Frame rate
MOV  FHD  60p (Full HD Super Fine 60p)*1	Setting 2	Frame rate
MOV  FHD  30p (Full HD Fine 30p)*1	Setting 3	Frame rate
MOV  FHD  30p (Full HD Normal 30p)*1*3	Setting 4	Frame rate
MOV  FHD  30p (Full HD Fine 30p)*1	Custom	Type of movie, detailed settings, slow/quick motion shooting
HD (1280×720, Motion JPEG)*2	For computer playback or editing	—
SD (640×480, Motion JPEG)*2	For computer playback or editing	—

\*1 File format: MPEG-4 AVC/H.264. Files may be up to 4 GB in size. Individual movies may be up to 29 minutes in length.

\*2 Files may be up to 2GB in size.

\*3 All-Intra refers to a movie recorded without inter-frame compression. Movies in this format are suitable for editing but have a lower compression rate and consequently a larger data size.

- When Video output is set to PAL, a frame rate of 30p will become 25p and a frame rate of 60p will become 50p.
- Depending on the type of card used, recording may end before the maximum length is reached.

- 4 Press the  button to save changes.

## Using a flash (flash photography)

The flash can be set manually as required. The flash can be used for flash photography in a variety of shooting conditions.

- 1 Remove the hot shoe cover from the flash unit and attach the flash to the camera.
  - Slide the flash unit all the way in, stopping when it contacts the back of the shoe and is securely in place.

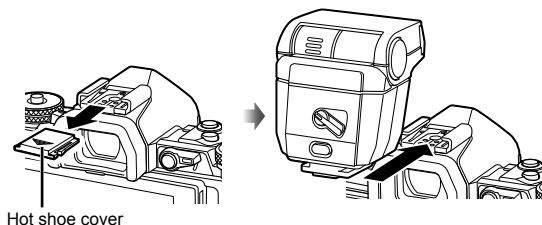

### Changing orientation of the flash

You can change the vertical and horizontal orientation of the flash unit. Bounce shooting is also possible.

#### Cautions

- Please be aware that with bounce shooting, the intensity of the flash may be insufficient.

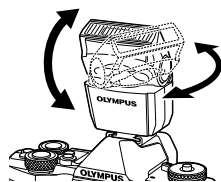

### Removing the flash unit

Press the UNLOCK switch while removing the flash unit.

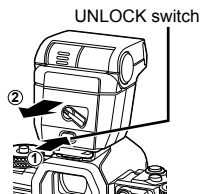

- 2 Move the flash ON/OFF lever to the ON position, and turn on the camera.
  - When not using the flash, return the lever to the OFF position.

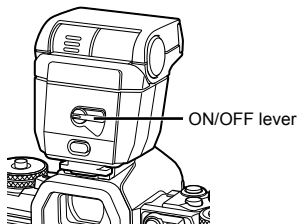

- 3 Press the  $\odot$  button and select flash mode.

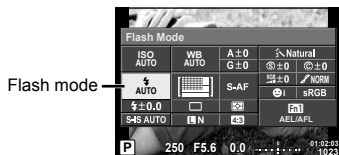

- 4 Select an item using the front dial and press the  $\odot$  button.

- The options available and the order in which they are displayed vary depending on the shooting mode.  $\odot$  "Flash modes that can be set by shooting mode" (P. 65)

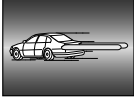
$\odot$ AUTO	Auto flash	The flash fires automatically in low light or backlight conditions.
$\odot$	Fill-in flash	The flash fires regardless of the light conditions.
$\odot$	Flash off	The flash does not fire.
$\odot$	Red-eye reduction flash	This function allows you to reduce the red-eye phenomenon. In <b>S</b> and <b>M</b> modes, the flash always fires.
$\odot$ SLOW	Slow synchronization (1st curtain)	Slow shutter speeds are used to brighten dimly-lit backgrounds.
$\odot$ SLOW	Slow synchronization (1st curtain)/Red-eye reduction flash	Combines slow synchronization with red-eye reduction.
$\odot$ SLOW2/ 2nd Curtain	Slow synchronization (2nd curtain)	The flash fires just before the shutter closes to create trails of light behind moving light sources. 
$\odot$ FULL, $\odot$ 1/4 etc.	Manual	For users who prefer manual operation. If you press the <b>INFO</b> button, you can use the dial to adjust the flash level.

### Cautions

- In [ $\odot$  (Red-eye reduction flash)], after the pre-flashes, it takes about 1 second before the shutter is released. Do not move the camera until shooting is complete.
- [ $\odot$  (Red-eye reduction flash)] may not work effectively under some shooting conditions.
- When the flash fires, the shutter speed is set to 1/250 sec. or slower. When shooting a subject against a bright background with the fill-in flash, the background may be overexposed.



## Flash modes that can be set by shooting mode

Shooting mode	LV super control panel	Flash mode	Flash timing	Conditions for firing the flash	Shutter speed limit	
P/A		Auto flash	1st curtain	Fires automatically in dark/backlit conditions	1/30 sec. – 1/250 sec.*	
		Auto flash (red-eye reduction)				
		Fill-in flash				Always fires
		Flash off	—	—	—	
		SLOW	Slow synchronization (red-eye reduction)	1st curtain	Fires automatically in dark/backlit conditions	60 sec. – 1/250 sec.*
		SLOW	Slow synchronization (1st curtain)			
		SLOW2	Slow synchronization (2nd curtain)			
S/M		Fill-in flash	1st curtain	Always fires	60 sec. – 1/250 sec.*	
		Fill-in flash (red-eye reduction)				
		Flash off	—	—	—	
		2nd-C	Fill-in flash/Slow synchronization (2nd curtain)	2nd curtain	Always fires	60 sec. – 1/250 sec.*

• **AUTO**, can be set in **AUTO** mode.

\* 1/250 seconds when using a separately sold external flash.











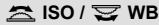









### Minimum range







The lens may cast shadows over objects close to the camera, causing vignetting, or be too bright even at minimum output.







Lens	Approximate distance at which vignetting occurs
17mm f1.8	0.25m
25mm f1.8	0.25m
45mm f1.8	0.5m
12–50mm EZ	0.35m
12–40mm PRO	0.6m 0.3m (Focal length: 16 mm or more)
40–150mm	0.5m

• External flash units can be used to prevent vignetting. To prevent photographs from being overexposed, select mode **A** or **M** and choose a high f-number, or reduce ISO sensitivity.



	Adjust exposure compensation.
	Adjust ISO sensitivity using the front dial and white balance using the rear dial.
	Adjust white balance using the front dial and ISO sensitivity using the rear dial.
<b>AEL/AFL</b>	AE lock or AF lock. The function changes according to the [AEL/AFL] setting. When AEL is selected, press the button once to lock the exposure and display  on the monitor. Press the button again to cancel the lock.
 <b>REC</b>	Press the button to record a movie.
 <b>(Preview)</b>	Aperture is stopped down to the selected value while the button is pressed. If [On] is selected for  Lock in Custom Menu, the aperture is held at the selected value even when releasing the button.
 <b>(One-touch white balance)</b>	The camera measures white balance when the button is pressed (P. 56).
 <b>(AF area)</b>	Choose the AF target.
 <b>Home</b>	Pressing the button selects the AF target position saved with  Set Home] (P. 100). Press the button again to return to AF target mode. If the camera is turned off when the home position is selected, the home position will be reset.
<b>MF</b>	Press the button to select manual focus mode. Press the button again to restore the previously selected AF mode.
<b>RAW</b> 	Press the button to toggle between JPEG and RAW+JPEG record modes.
 <b>TEST (Test Picture)</b>	Pictures taken while the button is pressed are displayed in the monitor but are not recorded to the memory card.
<b>Myset1 – Myset4</b>	Switches among the registered Myset settings when the button is pressed. Press the button again to return. The shooting mode will change regardless of the position of the mode dial.
	The button can be used to choose between  and  while the underwater case is attached. Press and hold the button to return to the previous mode. If you assign this function to a button, switching between  and  while using a lens with power zoom functionality will automatically set lens to the WIDE end or TELE end.
<b>Live Guide</b>	Press the button to display live guides.
 <b>(Digital Tele-converter)</b>	Press the button to turn digital zoom on or off.
 <b>(Keystone compensation)</b>	Press the button once to display options for keystone compensation and again to save changes and exit. To resume normal photography, press and hold the selected button.
 <b>(Magnify)</b>	Press the button to display the zoom frame. Press again to magnify the image. Press and hold the button to turn off the zoom frame.

<b>Peaking</b>	Each press of the button switches the monitor between display/non-display. When Peaking is displayed, histogram and highlight/shadow display are not available. When using Peaking, you can change colors and emphasis by pressing the <b>INFO</b> button.
<b>AF Stop</b>	Stops autofocus.
	Choose a sequential shooting or self timer option.
	Choose a flash mode.
<b>HDR</b>	Switches to HDR shooting with the saved settings.
<b>BKT</b>	Turns on BKT shooting using stored settings.
<b>Multi Function</b>	Press the button to recall the selected multi function*. When switching recalled functions, press the button while turning the dial.  "Multi-function button" (P. 68)
 <b>Lock (Touch panel lock)</b>	Press and hold the button to enable and disable touch panel operation.
<b>Electronic Zoom</b>	When using a lens with a power zoom function, after pressing the button, use the arrow pad for zooming operations.
 <b>(Monitor switching)</b>	Press this button to switch between displaying/hiding the preview. If the eye sensor is disabled, it switches between monitor display and EVF display.
 <b>Level Disp</b>	Press the button to display the level gauge and press it again to turn off the level gauge. The level gauge is available when [Style 1] or [Style 2] is set in [Built-in EVF Style].

\* Multi function:  (Highlight&Shadow Control),  (Color Creator),  (ISO sensitivity/White balance),  (White balance/ISO sensitivity),  (Magnify),  (Image Aspect)

### ■ Multi-function button (Multi Function)

When framing pictures in the viewfinder, you can adjust settings quickly using the multi-function button. At default settings, the **Fn2** button is assigned the role of the multi-function button.

#### Choosing a function

- 1 Press and hold the button to which the multi-function has been assigned and rotate the dial.
  - The menus are displayed.



- 2 Keep rotating the dial to select the desired function.
  - Release the button when the desired function is selected.

### Using multifunction options

Press the button to which the multi-function has been assigned. An option selection dialog will be displayed.

#### [Q] assigned to Fn2 button

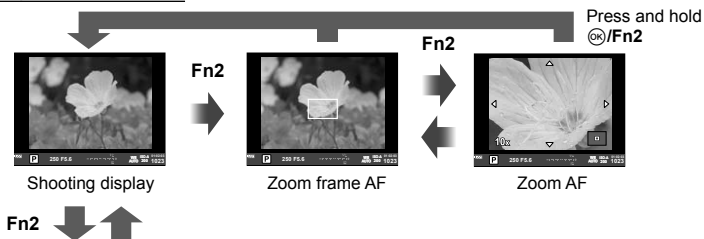

#### Other option assigned to Fn2 button



Highlight and shadow control options



Color Creator option



ISO sensitivity/white balance options



Aspect ratio options

Function	Front dial (☉)	Rear dial (☺)
(Highlight and shadow control) (P. 52)	Highlight control	Shadow control
(Color Creator) (P. 52)	Hue	Saturation
(ISO sensitivity/White balance)* (P. 54, 55)	ISO sensitivity	WB mode
(White balance/ISO sensitivity)* (P. 54, 55)	WB mode	ISO sensitivity
(Super Spot AF) (P. 50)	Zoom frame AF: Exposure compensation Zoom AF: Zoom in or out	
(Image Aspect) (P. 60)	Select an option	

\* Display by selecting with [Multi Function Settings] (P. 103).

## Processing options (picture mode)

Select a picture mode and make individual adjustments to contrast, sharpness, and other parameters (P. 69). Changes to each picture mode are stored separately.

- 1 Press the **OK** button and select picture mode.



- 2 Select an item using the front dial and press the **OK** button.

	<b>i-Enhance</b>	Produces more impressive-looking results suited to the scene.
	<b>Vivid</b>	Produces vivid colors.
	<b>Natural</b>	Produces natural colors.
	<b>Muted</b>	Produces flat tones.
	<b>Portrait</b>	Produces beautiful skin tones.
	<b>Monotone</b>	Produces black and white tone.
	<b>Custom</b>	Select one picture mode, set the parameters, and register the setting.
	<b>e-Portrait</b>	Produces smooth skin textures. Cannot be used with bracket photography or when shooting movies.
	<b>Color Creator</b>	Produces colors set using color creator (P. 52).
	<b>Pop Art</b>	Choose an art filter and select the desired effect. "Types of art filters" (P. 30)
	<b>Soft Focus</b>	
	<b>Pale&amp;Light Color</b>	
	<b>Light Tone</b>	
	<b>Grainy Film</b>	
	<b>Pin Hole</b>	
	<b>Diorama</b>	
	<b>Cross Process</b>	
	<b>Gentle Sepia</b>	
	<b>Dramatic Tone</b>	
	<b>Key Line</b>	
	<b>Watercolor</b>	
	<b>Vintage</b>	
	<b>Partial Color*</b>	

\* After choosing Partial Color using , press the **INFO** button to display the color ring.

## Making fine adjustments to sharpness (sharpness)

In the [Picture Mode] (P. 70) settings, you can make fine adjustments to sharpness alone and store the changes.

- 1 Press **OK** and select sharpness.
- 2 Adjust the sharpness using the front dial.



## Making fine adjustments to contrast (contrast)

In the [Picture Mode] (P. 70) settings, you can make fine adjustments to contrast alone and store the changes.

- 1 Press **OK** and select contrast.
- 2 Adjust the contrast using the front dial.



## Making fine adjustments to saturation (saturation)

In the [Picture Mode] (P. 70) settings, you can make fine adjustments to saturation alone and store the changes.

- 1 Press **OK** and select saturation.
- 2 Adjust the saturation using the front dial.



## Making fine adjustments to tone (gradation)

In the [Picture Mode] (P. 70) settings, you can make fine adjustments to tone alone and store the changes.

- 1 Press  $\odot$  and select tone.
- 2 Adjust the tone using the front dial.

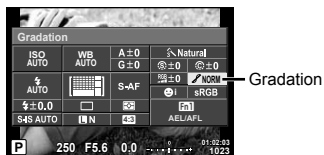

<b>AUTO:Auto</b>	Divides the image into detailed regions and adjusts the brightness separately for each region. This is effective for images with areas of large contrast in which the whites appear too bright or the blacks appear too dark.
<b>NORM:Normal</b>	Use [Normal] mode for general uses.
<b>HIGH:High Key</b>	Gradation for a bright subject.
<b>LOW:Low Key</b>	Gradation for a dark subject.

### ■ Applying filter effects to monotone pictures (B&W Filter)

In the monotone setting in [Picture Mode] (P. 70) settings, you can add and store a filter effect in advance. This creates a monotone image in which the color matching the filter color is brightened and the complementary color is darkened.

- 1 Press  $\odot$  and select [Picture Mode].
- 2 Select [Monotone] and then [B&W Filter].

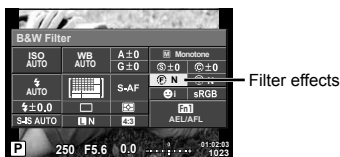

<b>N:Neutral</b>	Creates a normal black and white image.
<b>Ye:Yellow</b>	Reproduces clearly defined white cloud with natural blue sky.
<b>Or:Orange</b>	Slightly emphasizes colors in blue skies and sunsets.
<b>R:Red</b>	Strongly emphasizes colors in blue skies and brightness of crimson foliage.
<b>G:Green</b>	Strongly emphasizes colors in red lips and green leaves.



## ■ Adjusting the tone of a monotone image (Pict. Tone)

You can set and store a color tint for monotone images taken in [Picture Mode] (P. 70).

- 1 Press  $\odot$  and select [Picture Mode].
- 2 Select [Monotone] and then [Pict. Tone].

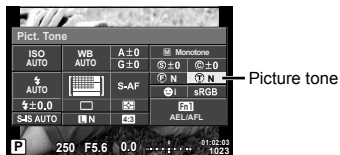

<b>N:Neutral</b>	Creates a normal black and white image.
<b>S:Sepia</b>	Sepia
<b>B:Blue</b>	Bluish
<b>P:Purple</b>	Purplish
<b>G:Green</b>	Greenish

## Setting the color reproduction format (Color Space)

You can select a format to ensure that colors are correctly reproduced when shot images are regenerated on a monitor or using a printer. This option is equivalent to the [Color Space] in  $\odot$  Custom Menu  $\odot$ .

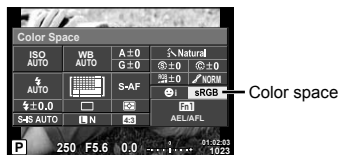

- 1 Press  $\odot$  and select color space.
- 2 Select a color format using the front dial.



<b>sRGB</b>	This is the RGB color space standard stipulated by the International Electrotechnical Commission (IEC). Normally, use [sRGB] as the standard setting.
<b>AdobeRGB</b>	This is a standard provided by Adobe Systems. Compatible software and hardware such as a display, printer etc. are required for a correct output of images.

## Movie sound options (recording sound with movies)



You can set the recording sound when shooting movies.

- 1 Rotate the mode dial to , and press the  button to select a movie sound.





- 2 Switch ON/OFF using the front dial and press the  button.

### Cautions

- When recording sound in a movie, the sound made by the lens and camera operating may be recorded. If desired, you can reduce these sounds by shooting with [AF Mode] set to [S-AF], or by limiting the amount of times you press the buttons.
- No sound is recorded in  (Diorama) mode.
- When recording sound with movies is set to [OFF],  is displayed.

## Adding effects to a movie



You can create movies that take advantage of the effects available in still photography mode. Set the mode dial to  to enable the settings.

- 1 Set the mode dial to , press the  button, and use the rear dial to select a shooting mode.



Shooting mode

- 2 Use the front dial to choose a shooting mode and press the  button.

<b>P</b>	Optimal aperture is set automatically according to the brightness of the subject.
<b>A</b>	Depiction of background is changed by setting the aperture. Use the rear dial (  ) to adjust the aperture.
<b>S</b>	Shutter speed affects how the subject appears. Use the rear dial to adjust the shutter speed. Shutter speed can be set to values between 1/30 s and 1/8000 s.
<b>M</b>	You control both aperture and shutter speed. Use the front dial (  ) to choose the aperture, the rear dial (  ) to select the shutter speed from values between 1/30 s and 1/8000 s. Sensitivity can be set manually to values between ISO 200 and 6400; auto ISO sensitivity control is not available.

**Cautions**

- The low end of the shutter speed changes according to the frame rate of the movie image quality.
- Stabilization is not possible when the camera shake is excessive.
- When the inside of the camera becomes hot, shooting is automatically stopped to protect the camera.
- With some art filters, [C-AF] operation is limited.
- Cards with an SD speed class of 10 or above are recommended for movie recording.

# 3 Playback

## Information display during playback

### Playback image information

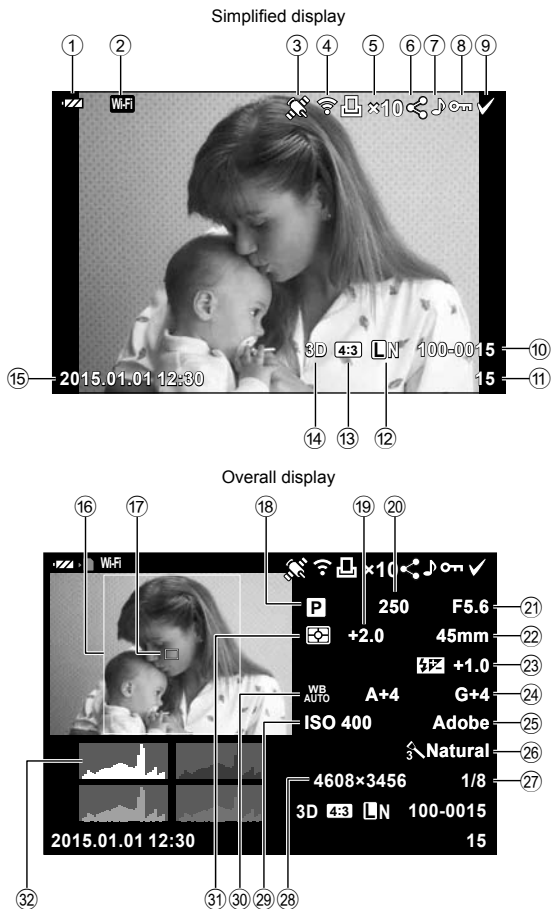

- ① Battery check .....P. 17
- ② Wireless LAN connection.....P. 118–123
- ③ Including GPS information .....P. 121
- ④ Eye-Fi upload complete .....P. 109
- ⑤ Print reservation  
Number of prints .....P. 129
- ⑥ Share order.....P. 82
- ⑦ Sound record .....P. 82
- ⑧ Protect .....P. 81
- ⑨ Image selected .....P. 82
- ⑩ File number.....P. 106
- ⑪ Frame number
- ⑫ Record mode .....P. 87
- ⑬ Aspect ratio.....P. 60
- ⑭ 3D image .....P. 28  
Temporarily saved image for PHOTO  
STORY.....P. 33
- ⑮ Date and time .....P. 18
- ⑯ Aspect border .....P. 60
- ⑰ AF target.....P. 48
- ⑱ Shooting mode.....P. 23–40
- ⑲ Exposure compensation .....P. 47
- ⑳ Shutter speed .....P. 34–37
- ㉑ Aperture value .....P. 34–37
- ㉒ Focal length .....P. 137
- ㉓ Flash intensity control.....P. 66
- ㉔ White balance compensation.....P. 56
- ㉕ Color space.....P. 106
- ㉖ Picture mode.....P. 70
- ㉗ Compression rate .....P. 116
- ㉘ Pixel count .....P. 105
- ㉙ ISO sensitivity .....P. 54
- ㉚ White balance .....P. 55
- ㉛ Metering mode.....P. 54
- ㉜ Histogram .....P. 22

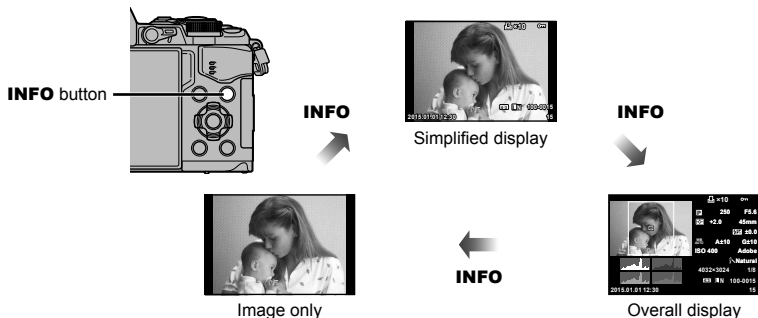

## Switching the information display

You can switch the information displayed during playback by pressing the **INFO** button.









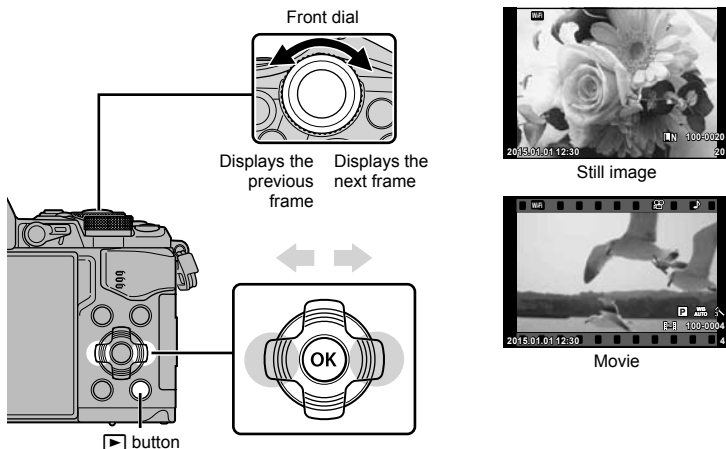











## Viewing photographs and movies



### 1 Press the button.

- Your most recent photograph or movie will be displayed.
- Select the desired photograph or movie using the front dial () or arrow pad (.
- Press the shutter button halfway to return to shooting mode.



<b>Rear dial</b> (  )	Zoom in (  ) / Index (  )
<b>Front dial</b> (  )	Previous (  ) / Next (  ) Operation also available during close-up playback.
<b>Arrow pad</b> (     )	Single-frame playback: Next (  ) / previous (  ) / playback volume (  ) Close-up playback: Scroll image You can display the next frame (  ) or the previous frame (  ) during close-up playback by pressing the <b>INFO</b> button. Index/My Clips/calendar playback: Highlight image
<b>Fn1</b>	Displays a zoom frame. Use touch operations to set the position of the frame and press <b>Fn1</b> to zoom in. To cancel, press <b>Fn1</b> .
<b>INFO</b>	View image info
	Select picture (P. 82)
<b>Fn2</b>	Protect picture (P. 81)
	Delete picture (P. 81)
	View menus (in calendar playback, press this button to exit to single-frame playback)

## Index display/Calendar display

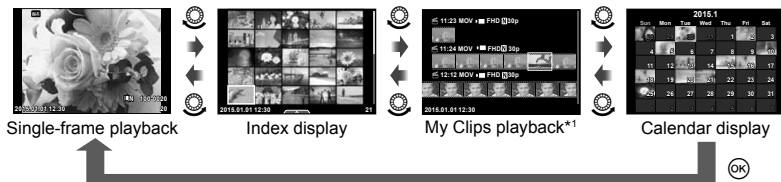

- From single-frame playback, rotate the rear dial to  for index playback. Rotate further for My Clips playback and further still for calendar playback.
- Turn the rear dial to  to return to single-frame playback.



\*1 If one or more My Clips have been created, it will be displayed here (P. 42).

## Viewing still images



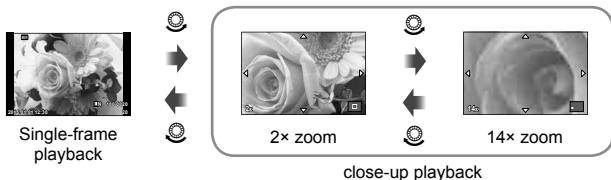

### Close-up playback

In single-frame playback, turn the rear dial to  to zoom in. Turn to  to return to single-frame playback.



### Rotate

Choose whether to rotate photographs.

- 1 Play the photograph back and press .
- 2 Select [Rotate] and press .
- 3 Press  to rotate the image counterclockwise,  to rotate it clockwise; the image rotates each time the button is pressed.
  - Press  to save settings and exit.
  - The rotated image is saved in its current orientation.
  - Movies, 3D photos, and protected images cannot be rotated.

## Slideshow

This function displays images stored on the card one after another.

- 1 Press **OK** during playback and select **[ ]**.



- 2 Adjust settings.

<b>Start</b>	Start the slideshow. Images are displayed in order, starting with the current picture.
<b>BGM</b>	Set [Joy] or turn BGM [Off].
<b>Slide</b>	Set type of slideshow to execute.
<b>Slide Interval</b>	Choose the length of time each slide is displayed from 2 to 10 seconds.
<b>Movie Interval</b>	Select [Full] to include full-length movie clips in the slideshow, [Short] to include only the opening portion of each clip.

- 3 Select [Start] and press **OK**.
  - The slideshow will start.
  - Press **OK** to stop the slideshow.

### Volume

Press **Δ**/**∇** during the slideshow to adjust the overall volume of the camera speaker.

Press **◀**/**▶** while the volume adjustment indicator is displayed to adjust the balance between the sound recorded with the image or movie and background music.

### Notes

- You can change [Joy] to different BGM. Record the data downloaded from the Olympus website onto the card, select [Joy] from [BGM] in step 2, and press **▷**. Visit the following website for the download.  
<http://support.olympus-imaging.com/bgmdownload/>

### Volume

Volume can be adjusted by pressing **Δ** or **∇** during single-frame and movie playback.





## Watching movies

Select a movie and press the **OK** button to display the playback menu. Select [Play Movie] and press the **OK** button to begin playback. Fast-forward and rewind using **</>**.

Press the **OK** button again to pause playback. While playback is paused, use **Δ** to view the first frame and **∇** to view the last frame. Use **</>** or the front dial (**⊙**) to view earlier and later frames. Press the **MENU** button to end playback.



### For movies of 4 GB or larger

For movies with a file size exceeding 4 GB, press **OK** to display the following menu.

[Play from Beginning]:	Plays back a split movie all the way through
[Play Movie]:	Plays back files separately
[Delete entire <b>⊞</b> ]:	Deletes all parts of a split movie
[Erase]:	Deletes files separately

### Cautions

- We recommend using the supplied PC software to play movies on a computer. Before launching the software for the first time, connect the camera to the computer.

## Protecting images

Protect images from accidental deletion. Display an image you wish to protect and press **OK** to display the playback menu. Select [**On**] and press **OK**, and then press **Δ** or **∇** to protect the image. Protected images are shown by a **On** (protect) icon. Press **Δ** or **∇** to remove protection.

You can also protect multiple selected images.

**☞** "Selecting images ([Share Order Selected], [**On**], [Erase Selected])" (P. 82)



### Cautions

- Formatting the card erases all images even if they have been protected.

## Erasing images

Display an image you want to delete and press the **⊞** button. Select [Yes] and press the **OK** button.

You can erase images without the confirmation step by changing the button settings.

**☞** [Quick Erase] (P. 106)

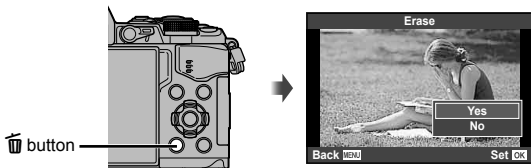

## Setting a transfer order on images ([Share Order])

You can select images you want to transfer to a smartphone in advance. You can also browse just the images included in the share order. When playing back images you want to transfer, press **OK** to display the playback menu. After selecting [Share Order] and pressing **OK**, press **△** or **▽** to set a share order on an image and display **↶**. To cancel a share order, press **△** or **▽**.

You can select images you want to transfer in advance and set a share order all at once. **☞** “Selecting images ([Share Order Selected], [On], [Erase Selected])” (P. 82), “Transferring images to a smartphone” (P. 120)

### Cautions

- You can set a share order on 200 frames.
- Share orders cannot include RAW images or Motion JPEG (**H264** or **H265**) movies.

## Selecting images ([Share Order Selected], [On], [Erase Selected])

You can select multiple images for [Share Order Selected], [On], or [Erase Selected].

Press the **☑** button in the index display screen (P. 79) to select an image; a **✓** icon will appear on the image. Press the **☑** button again to cancel the selection.

Press **OK** to display the menu, and then select from [Share Order Selected], [On], or [Erase Selected].



### Audio recording

Add an audio recording (up to 30sec. long) to the current photograph.

- 1 Display the image to which you want to add an audio recording and press **OK**.
  - Audio recording is not available with protected images.
  - Audio recording is also available in the playback menu.
- 2 Select **[M]** and press **OK**.
  - To exit without adding a recording, select [No].
- 3 Select **[M Start]** and press **OK** to begin recording.
  - To stop recording part-way through, press **OK**.
- 4 Press **OK** to end recording.
  - Images with audio recordings are indicated by a **M** icon.
  - To delete a recording, select [Erase] in Step 3.

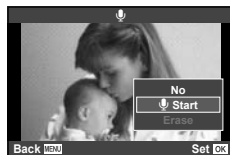
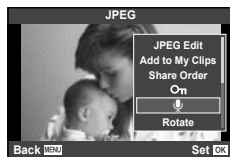

## Using the touch screen

You can use the touch panel to manipulate images.



### ■ Full-frame playback

#### Viewing additional images

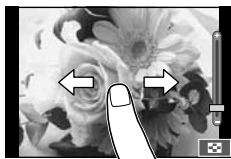
- Slide your finger to the left to view later frames, right to scroll view earlier frames.





#### Playback zoom

- Lightly touch the screen to display the slider and .
- Slide the bar up or down to zoom in or out.
- Use your finger to scroll the display when the picture is zoomed in.
- Tap  to display index playback.
- Tap  again for calendar playback and My Clips playback.



### ■ Index/My Clips/Calendar Playback

#### Page ahead/Page back

- Slide your finger up to view the next page, down to view the previous page.
- Use  or  to choose the number of images displayed.
- Tap  several times to return to single-frame playback.

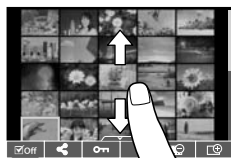





#### Viewing images

- Tap an image to view it full frame.

## Selecting and protecting images

In single-frame playback, lightly touch the screen to display the touch menu. You can then perform the desired operation by touching the icons in the touch menu.

	Select an image. You can select multiple images and delete them collectively.
	Images you want to share with a smartphone can be set.  “Setting a transfer order on images ([Share Order])” (P. 82)
	Protects an image.

### Cautions

- Do not touch the display with your fingernails or other sharp objects.
- Gloves and monitor covers may interfere with touch screen operation.

# 4 Menu functions

## Basic menu operations

The menus contain shooting and playback options that are not displayed by the live control, and let you customize the camera settings for easier use.

	Preliminary and basic shooting options
	Advanced shooting options
	Playback and retouch options
	Customizing camera settings (P. 100)*
	Camera setup (e.g., date and language)

\* Not displayed at default settings.

**1** Press the **MENU** button to display the menus.

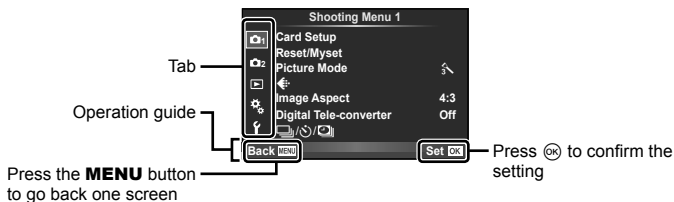

- A guide is displayed for about 2 seconds after you select an option.
- Press the **INFO** button to view or hide guides.

**2** Use  $\Delta$   $\nabla$  to select a tab and press  $\text{OK}$ .

**3** Select an item using  $\Delta$   $\nabla$  and press  $\text{OK}$  to display options for the selected item.

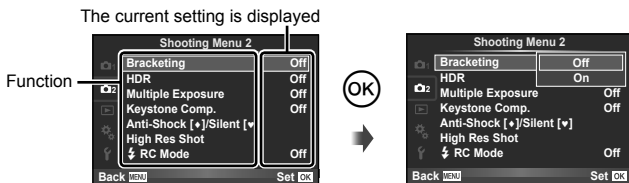

**4** Use  $\Delta$   $\nabla$  to highlight an option and press  $\text{OK}$  to select.

- Press the **MENU** button repeatedly to exit the menu.

### **Notes**

- For the default settings of each option, refer to “Menu directory” (P. 152).

## Using Shooting Menu 1/Shooting Menu 2



### Shooting Menu 1

- 1 Card Setup (P. 85)
- Reset/Myset (P. 86)
- Picture Mode (P. 87)
- ◀ (P. 87)
- Image Aspect (P. 60)
- Digital Tele-converter (P. 88)
- ⏏/⏏/⏏ (Sequential shooting/Self-timer/Time Lapse Settings) (P. 58, 88, 89)

### Shooting Menu 2

- 2 Bracketing (P. 90)
- HDR (P. 53)
- Multiple Exposure (P. 93)
- Keystone Comp. (P. 94)
- Anti-Shock [♦]/Silent[♥] (P. 95)
- High Res Shot (P. 95)
- ⚡ RC Mode (P. 95)

## Formatting the card (Card Setup)

Cards must be formatted with this camera before first use or after being used with other cameras or computers.

All data stored on the card, including protected images, is erased when the card is formatted.

When formatting a used card, confirm there are no images that you still want to keep on the card. ⏏ "Usable cards" (P. 132)

- 1 Select [Card Setup] in 1 Shooting Menu 1.
- 2 Select [Format] and press ⏏.

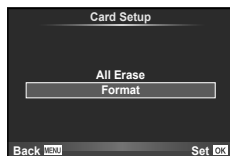

- 3 Select [Yes] and press ⏏.
  - Formatting is performed.

## Deleting all images (Card Setup)

All images taken are deleted. Protected images are not deleted.

- 1 Select [Card Setup] in 1 Shooting Menu 1.
- 2 Select [All Erase] and press ⏏.
- 3 Select [Yes] and press ⏏.
  - All images are deleted.

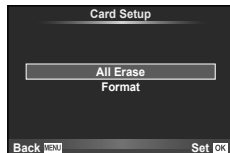

## Returning to default settings (Reset)

Camera settings can be easily restored to default settings.

- 1 Select [Reset/Myset] in Shooting Menu 1.
- 2 Select [Reset] and press .
  - Highlight [Reset] and press to choose the reset type.  
To reset all settings except the time, date, and a few others, highlight [Full] and press .
  - "Menu directory" (P. 152)
- 3 Select [Yes] and press .



## Registering Favorites settings (Myset)

### Saving Myset

You can save the current camera settings for modes other than shooting mode. Saved settings can be called up in **P**, **A**, **S**, and **M** modes.

- 1 Adjust settings in order to save.
  - 2 Select [Reset/Myset] in Shooting Menu 1.
  - 3 Select the desired destination ([Myset1]–[Myset4]) and press .
    - [Set] appears next to destinations ([Myset1]–[Myset4]) to which settings have already been saved. Selecting [Set] again overwrites the registered setting.
    - To cancel the registration, select [Reset].
  - 4 Select [Set] and press .
- Settings that can be saved to Myset "Menu directory" (P. 152)

### Using Myset

Sets the camera to the settings selected for Myset.

- 1 Select [Reset/Myset] in Shooting Menu 1.
- 2 Select the desired settings ([Myset1]–[Myset4]) and press .
- 3 Select [Yes] and press .



- The shooting mode does not change when MySet is executed from a menu.
- If you assign MySet to a button, you can execute it by simply pressing the button. With this operation, the shooting mode will change to the stored mode.
- You can also assign MySet to ART or **FAUTO** on the mode dial.

## Processing options (Picture Mode)

You can make individual adjustments to contrast, sharpness and other parameters in [Picture Mode] (P. 70) settings. Changes to each picture mode are stored separately.

- 1 Select [Picture Mode] in Shooting Menu 1.



- 2 Select an option with  $\Delta$   $\nabla$  and press  $\odot$ .
- 3 Press  $\triangleright$  to display settings for the selected option.

<b>Contrast</b>	✓	✓	✓	✓	P. 71
<b>Sharpness</b>	✓	✓	✓	✓	P. 71
<b>Saturation</b>	✓	✓	—	✓	P. 71
<b>Gradation</b>	✓	✓	✓	✓	P. 72
<b>Effect</b> (i-Enhance. Set level of enhancement)	✓	—	—	✓	—
<b>B&amp;W Filter</b> (Monotone)	—	—	✓	✓	P. 72
<b>Pict. Tone</b> (Monotone)	—	—	✓	✓	P. 73

### Tips

- You can reduce the number of picture mode options displayed in the menu.  
 [Picture Mode Settings] (P. 102)

### Cautions

- Changes to contrast have no effect at settings other than [Normal].

## Image quality ()

Select an image quality. You can select a separate image quality for photographs and movies. This is the same as the item in live control. “Selecting image quality (still image quality mode)” (P. 61), “Selecting image quality (movie image quality mode)” (P. 62)

- You can change the JPEG image size and compression ratio combination, and and pixel counts. Set], [Pixel Count] “Combinations of movie image sizes and compression rates” (P. 116)
- You can change the combination of movie compression format/frame rate, the shooting time of movie clips, and the effect of slow/quick motion shooting. “Movie Specification Settings” (P. 108)

## Digital Zoom (Digital Tele-converter)

Digital Tele-converter is used to zoom in beyond the current zoom ratio. The camera saves the center crop. Zoom is increased by about 2×.

- 1 Select [On] for [Digital Tele-converter] in Shooting Menu 1.
- 2 The view in the monitor will be enlarged by a factor of two.
  - The subject will be recorded as it appears in the monitor.

### Cautions

- Digital zoom is not available with multiple exposures, in mode, or when , , , , or is selected in **SCN** mode.
- This function is not available when [Movie Effect] is [On] in mode.
- When a RAW image is displayed, the area visible in the monitor is indicated by a frame.
- AF target drops.

## Setting the self timer ()

You can customize the self timer operation.

- 1 Select [//] in Shooting Menu 1.
- 2 Select [/] and press .
- 3 Select [C] (custom) and press .
- 4 Use to select the item and press .
  - Use to select the setting and press .



<b>Frame</b>	Sets the number of frames to be shot.
<b>Timer</b>	Sets the time after the shutter button is pressed until the picture is taken.
<b>Interval Time</b>	Sets the shooting interval for the second and subsequent frames.
<b>Every Frame AF</b>	Sets whether or not to perform AF right before a picture is taken with self timer.





## Shooting automatically with a fixed interval (Time lapse shooting)

You can set the camera to shoot automatically with a set time lapse. The shot frames can also be recorded as into a single movie. This setting is only available in **P/A/S/M** modes.

- 1 Select  in  Shooting Menu 1.



- 2 Select [Time Lapse Settings] and press .
- 3 Select [On], press  and make the following settings.

<b>Frame</b>	Sets the number of frames to be shot.
<b>Start Waiting Time</b>	Sets waiting time before starting to shot.
<b>Interval Time</b>	Sets interval between shots after shooting starts.
<b>Time Lapse Movie</b>	Sets recording format of frame sequence. [Off]: Records each frame as a still picture. [On]: Records each frame as a still picture and generates and records a single movie from the frame sequence.

- The image quality of the movie is [Motion JPEG (HD)] and the frame rate 10fps.

### 4 Shoot.



- Frames are shot even if the image is not in focus after AF. If you wish to fix the focus position, shoot in MF.
- [Rec View] operates for 0.5 seconds.
- If either of the time before shooting, or shooting interval is set to 1 minute 31 seconds or longer, the monitor and camera power will turn off after 1 minute. 10 seconds before shooting, the power will automatically turn on again. When the monitor is off, press the shutter button to turn it on again.

### Cautions



- If the AF mode is set to [C-AF] or [C-AF+TR], it is automatically changed to [S-AF].
- Touch operations are disabled during time lapse shooting.
- Cannot be used with HDR photography.
- It is not possible to combine time lapse shooting with bracketing, multiple exposure, and bulb, time or composite photography.
- The flash will not work if the flash charging time is longer than the interval between shots.
- If the camera automatically turns off in interval between shots, it will turn on in time for the next shot.
- If the any of the still pictures are not recorded correctly, the time lapse movie will not be generated.
- If there is insufficient space on the card, the time lapse movie will not be recorded.
- Time lapse shooting will cancelled if any of the following is operated: Mode dial, **MENU** button,  button, lens release button, or connecting the USB cable.
- If you turn off the camera, time lapse shooting will be cancelled.
- If there is not enough charge left on the battery, the shooting may end partway through. Make sure the battery is suitably charged before starting.

## Varying settings over a series of photographs (bracketing)

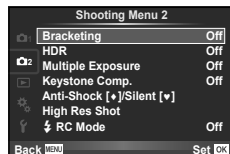

“Bracketing” refers to the act of varying settings automatically over a series of shots or a series of images to “bracket” the current value. You can store bracket shooting settings and turn bracket shooting off.

- 1 Select [Bracketing] in  Shooting Menu 2 and press .

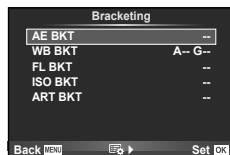

- 2 After selecting [On], press  and select a bracket shooting type.
  - When you select bracket shooting,  appears on the screen.



- 3 Press , select settings for parameters such as the number of shots, and then press the  button.
  - Continue to press the  button until you return to the screen in step 1.
  - If you select [Off] in step 2, bracket shooting settings will be saved and you can shoot normally.

### Cautions

- Cannot be used during HDR photography.
- Cannot be used at the same time as time lapse shooting.
- You cannot shoot during bracket shooting if there is not enough space on the camera's memory card for the selected number of frames.

### AE BKT (AE bracketing)

The camera varies the exposure of each shot. The modification amount can be selected from 0.3 EV, 0.7 EV, or 1.0 EV. In single-frame shooting mode, one photograph is taken each time the shutter button is pressed all the way down, while in sequential shooting mode the camera continues to take shots in the following order while the shutter button is pressed all the way down: no modification, negative, positive. Number of shots: 2, 3, 5, or 7

- The **[BKT]** indicator turns green during bracketing.
- The camera modifies exposure by varying aperture and shutter speed (mode **P**), shutter speed (modes **A** and **M**), or aperture (mode **S**).
- The camera brackets the value currently selected for exposure compensation.
- The size of the bracketing increment changes with the value selected for [EV Step].  “Using the custom menus” (P. 100)

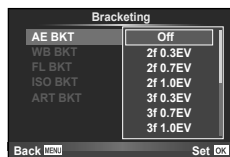

### WB BKT (WB bracketing)

Three images with different white balances (adjusted in specified color directions) are automatically created from one shot, starting with the value currently selected for white balance. WB bracketing is available in **P**, **A**, **S** and **M** modes.

- White balance can be varied by 2, 4, or 6 steps on each of the A–B (Amber–Blue) and G–M (Green–Magenta) axes.
- The camera brackets the value currently selected for white balance compensation.



### FL BKT (FL bracketing)

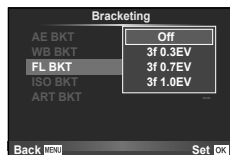

The camera varies flash level over three shots (no modification on the first shot, negative on the second, and positive on the third). In single-frame shooting, one shot is taken each time the shutter button is pressed; in sequential shooting, all shots are taken when the shutter button is pressed.

- The **[BKT]** indicator turns green during bracketing.
- The size of the bracketing increment changes with the value selected for [EV Step].  “Using the custom menus” (P. 100)



**ISO BKT (ISO bracketing)**

The camera varies the sensitivity over three shots while keeping the shutter speed and aperture fixed. The modification amount can be selected from 0.3 EV, 0.7 EV, or 1.0 EV. Each time the shutter button is pressed, the camera shoots three frames with the set sensitivity (or if auto sensitivity is selected, the optimal sensitivity setting) on the first shot, negative modification on the second shot, and positive modification on the third shot.

- The size of the bracketing increment does not change with the value selected for [ISO Step].  "Using the custom menus" (P. 100)
- Bracketing is performed regardless of the upper limit set with [ISO-Auto Set].  "Using the custom menus" (P. 100)

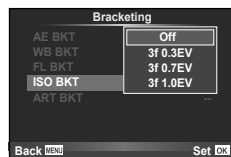
**ART BKT (ART bracketing)**

Each time the shutter is released, the camera records multiple images, each with a different art filter setting. You can turn art filter bracketing on or off separately for each picture mode.

- Recording may take some time.
- ART BKT cannot be combined with WB BKT or ISO BKT.

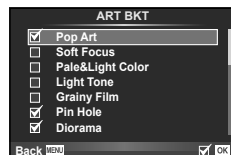

## Recording multiple exposures in a single image (multiple exposure)

Record multiple exposures in a single image, using the option currently selected for image quality.

1 Select [Multiple Exposure] in  Shooting Menu 2.

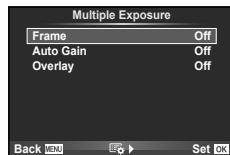

2 Adjust settings.

<b>Frame</b>	Select [2f].
<b>Auto Gain</b>	When set to [On], the brightness of each frame is set to 1/2 and the images are overlaid. When set to [Off], the images are overlaid with the original brightness of each frame.
<b>Overlay</b>	When set to [On], a RAW image recorded on a card can be overlaid with multiple exposures and stored as a separate image. The number of pictures taken is one.





-  is displayed in the monitor while multiple exposure is in effect.

3 Shoot.

-  is displayed in green when shooting starts.
- Press  to delete the last shot.
- The previous shot is superimposed on the view through the lens as a guide to framing the next shot.

### Tips

- To overlay 3 or more frames: Select RAW for  and use the [Overlay] option to make repeated multiple exposures.
- For more information on overlaying RAW images:  "Image overlay" (P. 98)

### Cautions



- The camera will not go to sleep while multiple exposure is in effect.
- Photographs taken with other cameras cannot be included in a multiple exposure.
- When [Overlay] is set to [On], the images displayed when a RAW image is selected are developed with the settings at the time of shooting.
- To set the shooting functions, cancel multiple exposure shooting first. Some functions cannot be set.
- Multiple exposure is cancelled automatically from the first picture in the following situations.
  - The camera is turned off/The  button is pressed/The **MENU** button is pressed/The shooting mode is set to a mode other than **P, A, S, M**/The battery power runs out/Any cable is connected to the camera
- When a RAW image is selected using [Overlay], the JPEG image for the image recorded in RAW+JPEG is displayed.
- When shooting multiple exposures using bracketing, priority is given to multiple exposure shooting. While the overlay image is being saved, bracketing is reset to the factory default setting.

## Keystone correction and perspective control (Keystone Comp.)

Use keystone correction for shots taken from the bottom of a tall building, or deliberately exaggerate the effects of perspective. This setting is only available in **P/A/S/M** modes.

- 1 Select [On] for [Keystone Comp.] in  Shooting Menu 2.







- 2 Adjust the effect in the display and frame the shot.
  - Use the front dial or rear dial for keystone correction.
  - Use  $\Delta$   $\nabla$   $\triangleleft$   $\triangleright$  to choose the area recorded.
  - Press and hold the  button to cancel any changes.
  - To adjust exposure compensation and other shooting options while keystone compensation is in effect, press the **INFO** button to view a display other than keystone compensation adjustment. To resume keystone compensation, press the **INFO** button until keystone compensation adjustment is displayed.
- 3 Shoot.
  - To end keystone compensation, select [Off] for [Keystone Comp.] in  Shooting Menu 2.

### Notes

- When [ (Keystone compensation)] (P. 67) is assigned to a button using [Button Function], press and hold the selected button to end keystone correction.

### Cautions

- Photos are recorded in RAW + JPEG format when [RAW] is selected for image quality.
- The desired results may not be obtained with converter lenses.
- Depending on the amount of correction, some AF targets may be outside the display area. An icon (, ,  or ) is displayed when the camera focuses on an AF target outside the display area.
- The following are not available during digital shift photography:
  - live bulb, live time, or composite photography/sequential shooting/bracketing/HDR/multiple exposure/digital tele-converter/movie/[C-AF] and [C-AF+TR] autofocus modes/full-time AF/[e-Portrait] and **ART** picture modes/custom self-timer/peaking/high resolution shot
- If a focus distance is selected for [Image Stabilizer], the correction will be adjusted for the selected focus distance. Except when using a Micro Four Thirds or Four Thirds lens, choose a focal length using the [Image Stabilizer] (P. 57) option.

## Setting anti-shock/silent shooting (Anti-Shock[♦]/Silent[♥])

By setting anti-shock/silent shooting you can select anti-shock or silent shooting when using sequential shooting or self timer (P. 58).



- 1 Select [Anti-Shock[♦]/Silent[♥]] in  Shooting Menu 2.
- 2 Select the item you wish to set.

<b>Anti-Shock[♦]</b>	Sets the time period between the shutter button being pressed all the way down and the shutter release when shooting in anti-shock mode. When this time period is set, the items will be marked with [♦] in sequential shooting/self timer mode. When not using anti-shock shooting, set to [Off]. Use this mode to suppress small vibrations caused by the operation of the shutter. Anti-shock mode is available in both sequential shooting (P. 58) and self timer (P. 58) modes.
<b>Silent[♥]</b>	Sets the time period between the shutter button being pressed all the way down and the shutter release when shooting in silent mode. When this time period is set, the items will be marked with ♥ in sequential shooting/self timer mode. When not using silent shooting, set to [Off].
<b>Noise Reduction[♥]</b>	Set to [AUTO] to reduce noise in long exposure shots when using silent shooting mode. During noise reduction processing, the sound of shutter operation can be heard.

## Setting hi-res shot (High Res Shot)

When you set hi-res shot, the items will be marked with  in sequential shooting/self timer mode (P. 58).

- 1 Select [High Res Shot] in  Shooting Menu 2.
- 2 Select the item you wish to set.

<b>High Res Shot</b>	Sets the time period between the shutter button being pressed all the way down and the shutter release when shooting in hi-res shot mode. When this time period is set,  will be displayed in sequential shooting/self timer mode. When not using hi-res shot, set to [Off].
<b> Charge Time</b>	Sets the time to wait for the flash to complete recharging when using a flash other than the dedicated flash that is supplied.



## Wireless remote control flash photography

The supplied flash unit and external flash units that offer a remote control mode and are designated for use with this camera can be used for wireless flash photography.

 "Wireless remote control flash photography" (P. 141)

## Using the playback menu

### Playback Menu

-  (P. 80)
-  (P. 96)
- Edit (P. 96)
- Print Order (P. 129)
- Reset Protect (P. 98)
- Connection to Smartphone (P. 119)











## 4

### Displaying images rotated ()

When set to [On], photographs taken with the camera rotated in portrait orientation are automatically rotated and displayed in portrait orientation.







### Editing still images

Recorded images can be edited and saved as new images.

- 1 Select [Edit] in the  Playback Menu and press .
- 2 Use   to select [Sel. Image] and press .
- 3 Use   to select the image to be edited and press 
  - [RAW Data Edit] is displayed if the picture is a RAW image, [JPEG Edit] if it is a JPEG image. If the image was recorded in RAW+JPEG format, both [RAW Data Edit] and [JPEG Edit] will be displayed. Select the menu for the image to be edited.
- 4 Select [RAW Data Edit] or [JPEG Edit] and press .

<b>RAW Data Edit</b>	Create a JPEG copy of a RAW image edited according to the settings.	
	<b>[Current]</b>	The JPEG copy is processed using the current camera settings. Adjust the camera settings before choosing this option.
	<b>[Custom1]</b>	Editing can be performed while changing the settings on the monitor. You can save the settings used.
	<b>[Custom2]</b>	
	<b>ART BKT</b>	The image is edited using settings for the selected art filter.



<b>JPEG Edit</b>	<p>Choose from the following options:</p> <p>[Shadow Adj]: Brightens a dark backlit subject.</p> <p>[Redeye Fix]: Reduces the red-eye phenomenon during flash shooting.</p> <p>[]: Use the front dial () or rear dial () to choose the size of the crop and  to specify the crop position.</p>
	<div data-bbox="671 163 913 323" style="text-align: right;">  </div> <p>[Aspect]: Changes the aspect ratio of images from 4:3 (standard) to [3:2], [16:9], [1:1], or [3:4]. After changing the aspect ratio, use  to specify the trimming position.</p> <p>[Black &amp; White]: Creates black and white images.</p> <p>[Sepia]: Creates sepia-toned images.</p> <p>[Saturation]: Sets the color depth. Adjust the color saturation checking the picture on the screen.</p> <p>[]: Converts the image file size to 1280 × 960, 640 × 480, or 320 × 240. Images with an aspect ratio other than 4:3 (standard) are converted to the closest image file size.</p> <p>[e-Portrait]: Makes skin look smooth and translucent. You may not be able to compensate depending on the image if face detection fails.</p>



**5** When the settings are complete, press .

- The settings will be applied to the image.

**6** Select [Yes] and press .

- The edited image is stored in the card.

**Cautions**

- 3D photos, movies, and temporarily saved files for PHOTO STORY cannot be edited.
- Red-eye correction may not work depending on the image.
- Editing of a JPEG image is not possible in the following cases:
  - When an image is processed on a PC, when there is not enough space in the card memory, when an image is recorded on another camera
- When resizing () an image, you cannot select a larger number of pixels than was originally recorded.
- [] and [Aspect] can only be used to edit images with an aspect ratio of 4:3 (standard).
- When [Picture Mode] is set to [ART], [Color Space] is locked to [sRGB].

### Image overlay

Up to 3 frames of RAW images taken with the camera can be overlaid and saved as a separate image.

The image is saved with the record mode set at the time the image is saved. (If [RAW] is selected, the copy will be saved in [L+N+RAW] format.)

- 1 Select [Edit] in the Playback Menu and press .
- 2 Use  $\Delta \nabla$  to select [Image Overlay] and press .
- 3 Select the number of images in the overlay and press .
- 4 Use  $\Delta \nabla \triangleleft \triangleright$  to select the RAW images that will be used in the overlay.
  - When you have selected the number of images specified in Step 3, the overlay will be displayed.

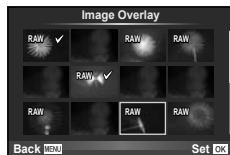

- 5 Adjust gain.
  - Use  $\triangleleft \triangleright$  to select an image and use  $\Delta \nabla$  to adjust gain.
  - Gain can be adjusted in the range 0.1–2.0. Check the results in the monitor.



- 6 Press . A confirmation dialog will be displayed; select [Yes] and press .

### Tips

- To overlay 4 or more frames, save the overlay image as a RAW file and use [Image Overlay] repeatedly.

### Audio recording

Add an audio recording (up to 30sec. long) to the current photograph.

This is the same function as during playback. (P. 82)

## Canceling all protections

This function lets you cancel the protection of several images at one time.

- 1 Select [Reset Protect] in the Playback Menu.
- 2 Select [Yes] and press .

## Using the setup menu

Use the **Y** Setup Menu to set the basic camera functions.



















Option	Description	
(Date/time setting)	Set the camera clock.	18
(Changing the display language)	You can change the language used for the on-screen display and error messages from English to another language.	—
(Monitor brightness adjustment)	You can adjust the brightness and color temperature of the monitor. Color temperature adjustment will affect only the monitor display during playback. Use <b>&lt;D&gt;</b> to highlight  (color temperature) or  (brightness) and <b>Δ</b> <b>▽</b> to adjust the value. Press the <b>INFO</b> button to switch between [Natural] and [Vivid] monitor color display.	
<b>Rec View</b>	Choose whether pictures are displayed immediately after shooting and for how long. This is useful for making a brief check of the picture you have just taken. Pressing the shutter button halfway while checking the picture lets you resume shooting immediately. [0.3sec]–[20sec]: Selects the number of seconds to display each picture. [Off]: The picture being recorded to the card is not displayed. [AUTO ]: Displays the image being recorded, and then switches to playback mode. This is useful for erasing a picture after checking it.	—
<b>Wi-Fi Settings</b>	Set up the camera to connect to a smartphone with wireless LAN connectivity using the wireless function on the camera.	122
<b>Menu Display</b>	Choose whether to display the custom menu.	—
<b>Firmware</b>	Your product's firmware version will be displayed. When you make inquiries about your camera or accessories or when you want to download software, you will need to state which version of each of the products you are using.	—

## Using the custom menu

Camera settings can be customized using the  Custom Menu.





### Custom Menu

-  AF/MF (P. 100)
-  Button/Dial/Lever (P. 101)
-  Release/ (P. 101)
-  Disp//PC (P. 102)
-  Exp//ISO (P. 104)
-   Custom (P. 105)
-  /Color/WB (P. 105)
-  Record/Erase (P. 106)
-  Movie (P. 107)
-  Built-In EVF (P. 109)
-   Utility (P. 109)



### AF/MF

MENU    

Option	Description	
<b>AF Mode</b>	Choose the AF mode. This is the same as the live control setting. You can set separate focusing methods for still photography mode and  mode.	51
<b>Full-time AF</b>	If [On] is selected, the camera will continue to focus even when the shutter button is not pressed halfway. Cannot be used when using a Four Thirds system lens.	—
<b>AEL/AFL</b>	Customize AF and AE lock.	110
<b>Reset Lens</b>	When set to [Off], the focus position of the lens is not reset even when the power is turned off. When set to [On], the focus of power zoom lenses is also reset.	—
<b>Bulb/Time Focusing</b>	You can change the focus position during exposure by using manual focus (MF). When set to [Off], rotation of the focus ring is disabled.	—
<b>Focus Ring</b>	You can customize how the lens adjusts to the focal point by selecting the rotational direction of the focus ring.	—
<b>MF Assist</b>	When set to [On], you can automatically switch to zoom or peaking in manual focus mode by rotating the focus ring.	111
<b>[] Set Home</b>	Choose the AF target position that will be saved as the home position.  appears in the AF target selection display while you choose a home position.	—
<b>AF Illuminat.</b>	Select [Off] to disable the AF illuminator.	—
<b>Face Priority</b>	You can select the face priority or eye priority AF mode. This is the same as the live control setting.	49
<b>AF Area Pointer</b>	If you select [Off], the AF target frame will not be displayed during confirmation.	—

Option	Description	
<b>Button Function</b>	Choose the function assigned to the selected button. <div style="border: 1px solid black; padding: 5px; margin: 5px 0;">                     [Fn1]Function, [Fn2]Function, [Fn3]Function,                      [Fn4]Function, [⊙]Function, [⊙]Function, [▶]Function,                      [▽]Function, [⊞]Function, [B+Fn]Function,                      [B+Fn2]Function, [L+Fn]Function                 </div>	66
<b>Dial Function</b>	You can change the function of the front dial and rear dial.	—
<b>Dial Direction</b>	Choose the direction in which the dial is rotated to adjust shutter speed or aperture. Change the program shift direction.	—
<b>Mode Dial Function</b>	You can assign registered Myset settings to any position on the mode dial. [Myset1] - [Myset4] (P. 86) can be selected when the settings are registered.	—
<b>Lever Function</b>	You can use the positioning of the lever to change the function of the dials and button.	111
<b>Opt. Grip Dial Func.</b>	You can set the function allocated to the dial on the external grip (HLD-8) between headphone volume and the front dial functions. This is possible during shooting.	—

Option	Description	
<b>Rls Priority S</b>	If [On] is selected, the shutter can be released even when the camera is not in focus. This option can be set separately for S-AF (P. 51) and C-AF (P. 51) modes.	—
<b>Rls Priority C</b>		
L fps	Choose the frame advance rates for [L], [H], [L], and [H]. Figures are the approximate maximums.	58, 59
H fps		
L fps		
H fps		
<b>Image Stabilizer</b>	Activates image stabilization for still image shooting and movie recording respectively.	57
<b>Image Stabilization</b>	Activates/deactivates image stabilization for continuous shooting.	—
<b>Half Way Rls With IS</b>	When set to [Off], the IS (Image Stabilization) function while the shutter button is pressed halfway will not be activated.	—
<b>Lens I.S. Priority</b>	If [On] is selected, priority is given to the lens function operation when using a lens with an image stabilization function.	—
<b>Release Lag-Time</b>	If [Short] is selected, the time lag between fully pressing the shutter button and the shot being taken can be shortened.*	—

\* This will shorten the battery life. Also make sure that the camera is not subject to sharp impacts while in use. Such impacts may cause the monitor to stop displaying subjects. If this happens, turn the power off and on again.

Option	Description																																			
HDMI	[HDMI Out]: Selecting the digital video signal format for connecting to a TV via an HDMI cable. [HDMI Control]: Select [On] to allow the camera to be operated using remotes for TVs that support HDMI control.	112																																		
Video Out	Choose the video standard ([NTSC] or [PAL]) used in your country or region.	112																																		
Control Settings	Choose the controls displayed in each shooting mode.	113																																		
	<table border="1"> <thead> <tr> <th rowspan="2">Controls</th> <th colspan="4">Shooting mode</th> </tr> <tr> <th>FAUTO</th> <th>P/A/S/M</th> <th>ART</th> <th>SCN</th> </tr> </thead> <tbody> <tr> <td>Live Control (P. 46)</td> <td>✓</td> <td>✓</td> <td>✓</td> <td>✓</td> </tr> <tr> <td>Live SCP (P. 45)</td> <td>✓</td> <td>✓</td> <td>✓</td> <td>✓</td> </tr> <tr> <td>Live Guide (P. 26)</td> <td>✓</td> <td>—</td> <td>—</td> <td>—</td> </tr> <tr> <td>Art Menu</td> <td>—</td> <td>—</td> <td>✓</td> <td>—</td> </tr> <tr> <td>Scene Menu</td> <td>—</td> <td>—</td> <td>—</td> <td>✓</td> </tr> </tbody> </table>		Controls	Shooting mode				FAUTO	P/A/S/M	ART	SCN	Live Control (P. 46)	✓	✓	✓	✓	Live SCP (P. 45)	✓	✓	✓	✓	Live Guide (P. 26)	✓	—	—	—	Art Menu	—	—	✓	—	Scene Menu	—	—	—	✓
	Controls			Shooting mode																																
			FAUTO	P/A/S/M	ART	SCN																														
	Live Control (P. 46)		✓	✓	✓	✓																														
	Live SCP (P. 45)		✓	✓	✓	✓																														
Live Guide (P. 26)	✓	—	—	—																																
Art Menu	—	—	✓	—																																
Scene Menu	—	—	—	✓																																
Press the <b>INFO</b> button to switch the screen contents.																																				
Info Settings	Choose the information displayed when the <b>INFO</b> button is pressed. [▶ Info]: Choose the information displayed in full frame playback. [LV-Info]: Choose the information displayed when the camera is in shooting mode. [Settings]: Choose the information displayed in index and calendar playback.	114, 115																																		
Displayed Grid	Select [Grid], [Grid], [Grid], [Grid] or [Grid] to display a grid on the monitor.	—																																		
Picture Mode Settings	Display only the selected picture mode when a picture mode is selected.	—																																		
Histogram Settings	[Highlight]: Choose the lower bound for the highlight display. [Shadow]: Choose the upper bound for the shadow display.	114																																		
Mode Guide	Choose [Off] to not display help for the selected mode when the mode dial is rotated to a new setting.	23																																		
Live View Boost	Shoot while checking the subject even under low-light conditions. In <b>M</b> mode, you can use this setting when shooting with BULB/TIME shooting and live composite. [ON1]: Prioritize smoothness of display. [ON2]: Prioritize image visibility in dark conditions. This will make the response to button operations on the camera slower.	—																																		
Frame Rate	Select [High] to reduce frame lag. However, the image quality may drop.	—																																		
Art LV Mode	[mode1]: The filter effect is always displayed. [mode2]: Filter effects are not visible in the monitor while the shutter button is pressed halfway. Choose for a smooth display.	—																																		

Option	Description	
<b>Expand LV Dyn. Range</b>	Set to [On] to expand the dynamic range of the live view. Available for HDR photography with [HDR1] or [HDR2].	—
<b>Flicker reduction</b>	Reduce the effects of flicker under some kinds of lighting, including fluorescent lamps. When flicker is not reduced by the [Auto] setting, set to [50Hz] or [60Hz] in accordance with the commercial power frequency of the region where the camera is used.	—
<b>LV Close Up Mode</b>	[mode1]: Pressing the shutter button halfway cancels zoom. [mode2]: Zoom is not cancelled when the shutter button is pressed halfway.	50
<b>Lock</b>	If [On] is selected, the preview switches between lock and release every time the button registered for preview is pressed.	—
<b>Peaking Settings</b>	You can change the edge enhancement color and intensity.	—
<b>Backlit LCD</b>	If no operations are performed for the selected period, the backlight will dim to save battery power. The backlight will not dim if [Hold] is selected.	—
<b>Sleep</b>	The camera will enter sleep (energy saving) mode if no operations are performed for the selected period. The camera can be reactivated by pressing the shutter button halfway.	—
<b>Auto Power Off</b>	When in sleep mode, the camera will automatically turn off after the set time has elapsed.	—
<b>(Beep sound)</b>	When set to [Off], you can turn off the beep sound that is emitted when the focus locks by pressing the shutter button.	—
<b>USB Mode</b>	Choose a mode for connecting the camera to a computer or printer. Choose [Auto] to display USB mode options every time the camera is connected. If  is selected, the camera can be controlled and images copied to a computer using special-purpose software that can be installed after downloading it from the website below.  is available in modes <b>P</b> , <b>A</b> , <b>S</b> , and <b>M</b> . <a href="http://support.olympus-imaging.com/oc1download/index/">http://support.olympus-imaging.com/oc1download/index/</a>	—
<b>Multi Function Settings</b>	Select the items to use in multi function mode.	—
<b>Menu Recall</b>	Set [Recall] to display the cursor at the last position of operation when you display a menu. The cursor position will be retained even when you turn off the camera.	—

Option	Description	
<b>EV Step</b>	Choose the size of the increments used when selecting shutter speed, aperture, exposure compensation, and other exposure parameters.	—
<b>Noise Reduct.</b>	This function reduces the noise that is generated during long exposures. [Auto]: Noise reduction is performed at slow shutter speeds, or when the internal temperature of the camera has risen. [On]: Noise reduction is performed with every shot. [Off]: Noise reduction off. • After shooting, processing time takes about the same amount of time as shooting time. • Noise reduction turns off automatically during sequential shooting. • This function may not work effectively with some shooting conditions or subjects.	37
<b>Noise Filter</b>	Choose the amount of noise reduction performed at high ISO sensitivities.	—
<b>ISO</b>	Set ISO sensitivity.	54
<b>ISO Step</b>	Select the increments available for choosing ISO sensitivity.	—
<b>ISO-Auto Set</b>	Choose the upper limit and default value used for ISO sensitivity when [Auto] is selected for ISO. [High Limit]: Choose the upper limit for auto ISO sensitivity selection. [Default]: Choose the default value for auto ISO sensitivity selection.	—
<b>ISO-Auto</b>	Choose the shooting modes in which [Auto] ISO sensitivity is available. [P/A/S]: Auto ISO sensitivity selection is available in all modes except <b>M</b> . ISO sensitivity is fixed at ISO200 in mode <b>M</b> . [All]: Auto ISO sensitivity selection is available in all modes.	—
<b>Metering</b>	Choose a metering mode according to the scene.	54
<b>AEL Metering</b>	Choose the metering method used for AE lock (P. 111). [Auto]: Use the currently selected metering method.	—
<b>Bulb/Time Timer</b>	Choose the maximum exposure for bulb and time photography.	—
<b>Bulb/Time Monitor</b>	Set the monitor brightness when [BULB], [TIME], or [COMP] is used.	—
<b>Live Bulb</b>	Choose the display interval during shooting. Some restrictions apply. The frequency drops at high ISO sensitivities. Choose [Off] to disable the display. Tap the monitor or press the shutter button halfway to refresh the display.	—
<b>Live Time</b>		—
<b>Composite Settings</b>	Set an exposure time to be the reference in composite photography (P. 38).	—



Option	Description	
<b>X-Sync.</b>	Choose the shutter speed used when the flash fires.	115
<b>Slow Limit</b>	Choose the slowest shutter speed available when a flash is used.	115
<b>[WB]+[☼]</b>	When set to [On], the exposure compensation value is added to the flash compensation value.	47, 66

Option	Description	
<b>Set</b>	<p>You can select the JPEG image quality mode from combinations of three image sizes and four compression rates.</p> <ol style="list-style-type: none"> <li>Use <math>\triangleleft</math> and <math>\triangleright</math> to select a combination ([☼-1] - [☼-4]) and use <math>\triangle</math> and <math>\nabla</math> to change.</li> <li>Press <math>\odot</math>.</li> </ol>	61
<b>Pixel Count</b>	<p>Choose the pixel count for [M]- and [S]-size images.</p> <ol style="list-style-type: none"> <li>Select [Middle] or [Small] and press <math>\triangleright</math>.</li> <li>Choose a pixel count and press <math>\odot</math>.</li> </ol>	61
<b>Shading Comp.</b>	<p>Choose [On] to correct peripheral illumination according to the type of lens.</p> <ul style="list-style-type: none"> <li>Compensation is not available for teleconverters or extension tubes.</li> <li>Noise may be visible at the edges of photographs taken at high ISO sensitivities.</li> </ul>	—
<b>WB</b>	Set the white balance. This is the same as the live control setting. You can also fine-tune the white balance for each mode.	55
<b>All [WB]</b>	<p>[All Set]: Use the same white balance compensation in all modes except [CWB].</p> <p>[All Reset]: Set white balance compensation for all modes except [CWB] to 0.</p>	—

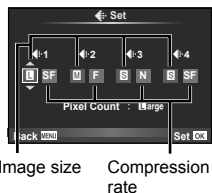
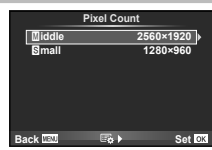



Image size      Compression rate



Option	Description	
<b>Keep Warm Color</b>	Select [Off] to eliminate “warm” colors from pictures taken under incandescent lighting.	—
<b>+WB</b>	Adjust white balance for use with a flash.	—
<b>Color Space</b>	You can select how colors are reproduced on the monitor or printer.	—

Option	Description	
<b>Quick Erase</b>	If [On] is selected, pressing the  button in the playback display will immediately delete the current image.	—
<b>RAW+JPEG Erase</b>	Choose the action performed when a photograph recorded at a setting of RAW+JPEG is erased in single-frame playback (P. 81). [JPEG]: Only the JPEG copy is erased. [RAW]: Only the RAW copy is erased. [RAW+JPEG]: Both copies are erased. • Both the RAW and JPEG copies are deleted when selected images are deleted or when [All Erase] (P. 85) is selected.	61
<b>File Name</b>	[Auto]: Even when a new card is inserted, the file numbers are retained from the previous card. File numbering continues from the last number used or from the highest number available on the card. [Reset]: When you insert a new card, the folder numbers starts at 100 and the file name starts at 0001. If a card containing images is inserted, the file numbers start at the number following the highest file number on the card.	—
<b>Edit Filename</b>	Choose how image files are named by editing the portion of the filename highlighted below in gray. sRGB: Pmdd0000.jpg _____ Pmdd Adobe RGB: _mdd0000.jpg _____ mdd	—
<b>Priority Set</b>	Choose the default selection ([Yes] or [No]) for confirmation dialogs.	—
<b>dpi Settings</b>	Choose the print resolution.	—

Option	Description	
<b>Copyright Settings*</b>	<p>Add the names of the photographer and copyright holder to new photographs. Names can be up to 63 characters long. [Copyright Info.]: Select [On] to include the names of the photographer and copyright holder in the Exif data for new photographs.</p> <p>[Artist Name]: Enter the name of the photographer.</p> <p>[Copyright Name]: Enter the name of the copyright holder.</p> <div style="border: 1px solid gray; padding: 5px; margin: 10px 0;"> <p>1) Highlight a character ① and press <b>OK</b> to add the highlighted character to the name ②.</p> <p>2) Repeat Step 1 to complete the name, then highlight [END] and press <b>OK</b>.</p> <ul style="list-style-type: none"> <li>To delete a character, press the <b>INFO</b> button to place the cursor in the name area ②, highlight the character, and press <b>⏏</b>.</li> </ul> </div> 	—

\* OLYMPUS does not accept liability for damages arising from disputes involving the use of [Copyright Settings]. Use at your own risk.









**Movie**

Option	Description	
<b>Mode</b>	Choose a movie record mode. This option can also be selected using the live control.	40
<b>Movie</b>	Choose [Off] to record silent movies. This option can also be selected using the live control.	74
<b>Recording Volume</b>	Adjust sensitivity separately for each microphone of the camera. Adjust the sensitivity using $\Delta$ $\nabla$ while checking the peak sound level picked up by the microphone over the previous few seconds.	—
<b>Volume Limiter</b>	If [On] is selected, the volume is automatically regulated when the volume picked up by the microphone is louder than normal.	—
<b>Wind Noise Reduction</b>	Reduce wind noise during recording.	—
<b>Plug-in Power</b>	Set to [Off] to stop supplying power to the microphone jack. This setting may be used when using a professional-grade microphone etc.	—
<b>PCM Recorder</b>	Set to [On] when a digital voice recorder is connected to the external microphone jack as an external microphone. Use a non-resistor-type cable for the connection.	—
<b>Headphone Volume</b>	You can use this to adjust the volume when connecting headphones to the separately sold HLD-8.	140



Option	Description	
<b>Time Code Settings</b>	Set the time codes to record when shooting a movie. [Time Code Mode]: Set [DF] (drop frame) to record time codes corrected for errors with respect to recording time and [NDF] (no drop frame) to record uncorrected time codes. [Count Up]: Set to [RR] (Rec run) to use time codes that only run during recording and [FR] (Free run) to use time codes that also run when recording has stopped, including when the camera is powered off. [Starting Time]: Set a starting time for the time code. Set [Current Time] to set the time code for the current frame to 00. To set to 00:00:00:00, select [Reset]. You can also set time codes using [Manual Input]. Time code is not recorded when the record mode for the movie is Motion JPEG ( or ).	—
<b>Info Settings</b>	You can select the content of the information displayed on the movie recording screen. To hide an item, select the item and press  to clear the checkmark.	—
<b>Movie Specification Settings</b>	You can set combinations of movie image size and compression format/bit rate in SET1 to SET4. After performing these settings, you can select them in movie image quality mode (P. 62). [Image Size]: Select between [FHD] (Full HD) and [HD]. [Compression/Bit Rate]: Select from [A-] (All-Intra)/[SF] (Super Fine)/[F] (Fine)/[N] (Normal).	—
<b>Movie Effect</b>	Choose [On] to enable movie effects in  mode.	40
<b>Movie+Photo Mode</b>	Choose the way in which photographs are taken during movie recording. [mode1]: Take photographs during movie recording without stopping recording. [mode2]: Stop recording to take photographs. Recording will resume after the photograph is taken. In mode2 and certain shooting modes, it is only possible to capture a single-frame as a picture during recording. Other shooting functions may also be limited. If the record mode for the movie is Motion JPEG ( or ), the camera is set to mode2.	41
<b>Shutter Function</b>	In movie mode, the following shutter button options are available. [mode1]: Use the shutter button to shoot still images. [mode2]: Press the shutter button all the way down to start and stop movie recording. In mode2, you cannot control recording using the  button.	—





## Built-In EVF

MENU →  → 

Option	Description	
<b>Built-in EVF Style</b>	Choose the viewfinder display style.	116
 <b>Info Settings</b>	Like the monitor, the viewfinder can be used to display histograms and highlights and shadows. Available when [Style 1] or [Style 2] is selected for [Built-in EVF Style].	—
 <b>Displayed Grid</b>	Display a framing grid in the viewfinder. Choose from  ,  ,  , and  . Available when [Style 1] or [Style 2] is selected for [Built-in EVF Style].	—
<b>EVF Auto Switch</b>	If [Off] is selected, the viewfinder will not turn on when you put your eye to the viewfinder. Use the  button to choose the display.	—
<b>EVF Adjust</b>	Adjust viewfinder brightness and hue. Brightness is automatically adjusted when [EVF Auto Luminance] is set to [On].	—
 <b>Half Way Level</b>	If set to [Off], the level gauge will not be displayed when the shutter button is pressed halfway down. This is effective when [Built-in EVF Style] is set to [Style 1] or [Style 2].	—

## Utility

MENU →  → 

Option	Description	
<b>Pixel Mapping</b>	The pixel mapping feature allows the camera to check and adjust the image pickup device and image processing functions.	151
<b>Exposure Shift</b>	Adjust correct exposure separately for each metering mode. <ul style="list-style-type: none"> <li>• This reduces the number of exposure compensation options available in the selected direction.</li> <li>• The effects are not visible in the monitor. To make normal adjustments to the exposure, perform exposure compensation (P. 47).</li> </ul>	—
 <b>Warning Level</b>	Choose the battery level at which the  warning is displayed.	17
 <b>Battery Priority</b>	Choose the primary power source when using a power battery holder.	139
<b>Level Adjust</b>	You can calibrate the angle of the level gauge. [Reset]: Resets adjusted values to the default settings. [Adjust]: Sets the current camera orientation as the 0 position.	—
<b>Touch Screen Settings</b>	Activate the touch screen. Choose [Off] to disable the touch screen.	—
<b>Eye-Fi*</b>	Enable or disable upload when using an Eye-Fi card. Displayed when an Eye-Fi card is inserted.	—

\* Use in accordance with local regulations. Onboard airplanes and in other locations in which the use of wireless devices is prohibited, remove the Eye-Fi card from the camera, or select [Off] for [Eye-Fi]. The camera does not support the “endless” Eye-Fi mode.

Option	Description	
<b>Electronic Zoom Speed</b>	You can change the zoom speed used when operating the power zoom lens with the zoom ring.	136
<b>Selfie Assist</b>	Set to [On] to display the self-portrait menu on the monitor when the monitor is deployed in the self-portrait position.	116
<b>Quick Sleep Mode</b>	When set to [On], the camera will go into energy-saving mode during shooting without using live view, allowing the camera to take pictures while using less power. Press the shutter button to return from energy-saving mode. This setting is not available when [Release Lag-Time] is set to [Short].	—

## AEL/AFL

## MENU → ⚙️ → 📷 → [AEL/AFL]

Autofocus and metering can be performed by pressing the button to which AEL/AFL has been assigned. Choose a mode for each focus mode.





## AEL/AFL

Mode		Shutter button function				AEL/AFL Button function	
		Half-press		Full press		When holding down AEL/AFL	
		Focus	Exposure	Focus	Exposure	Focus	Exposure
S-AF	mode1	S-AF	Locked	—	—	—	Locked
	mode2	S-AF	—	—	Locked	—	Locked
	mode3	—	Locked	—	—	S-AF	—
C-AF	mode1	C-AF start	Locked	Locked	—	—	Locked
	mode2	C-AF start	—	Locked	Locked	—	Locked
	mode3	—	Locked	Locked	—	C-AF start	—
	mode4	—	—	Locked	Locked	C-AF start	—
MF	mode1	—	Locked	—	—	—	Locked
	mode2	—	—	—	Locked	—	Locked
	mode3	—	Locked	—	—	S-AF	—

## MF Assist

### MENU → → → [MF Assist]

This is a focus assist function for MF. When the focus ring is rotated, the edge of the subject is enhanced or a portion of the screen display is magnified. When you stop operating the focus ring, the screen returns to the original display.

<b>Magnify</b>	Magnifies a portion of the screen. The portion to be magnified can be set in advance using AF target.  [AF Area] (P.48)
<b>Peaking</b>	Displays clearly defined outlines with edge enhancement. You can select the enhancement color and intensity.  [Peaking Settings] (P.103)

### Notes

- [Peaking] can be displayed using button operations. The display is switched every time the button is pressed. Assign the switching function to one of the buttons in advance using [Button Function] (P. 66).
- Press the **INFO** button to change the color and intensity when Peaking is displayed.

### Cautions







- When Peaking is in use, the edges of small subjects tend to be enhanced more strongly. This is no guarantee of accurate focusing.

## Lever Function

### MENU → → → [ Lever Function]

You can use the positioning of the lever to change the function of the dials and buttons.

#### Table of lever position and functions assigned to dial/buttons

Mode	When the lever position is set to 1	When the lever position is set to 2
<b>Off</b>	The lever function is not used.	The lever function is not used.
<b>mode1</b>	Dial functions are based on [Dial Function] settings.	Front dial: ISO Rear dial: White balance
<b>mode2</b>	Dial functions are based on [Dial Function] settings.	Front dial: White balance Rear dial: ISO
<b>mode3</b>	The  button and <b>Fn2</b> button functions are based on [  Function] and [ <b>Fn2</b> Function] settings.	 button: ISO <b>Fn2</b> button: White balance
<b>mode4</b>	The  button and <b>Fn2</b> button functions are based on [  Function] and [ <b>Fn2</b> Function] settings.	 button: White balance <b>Fn2</b> button: ISO
<b>mode5</b>	The AF modes assigned to the lever positions apply. When the lever position is set to 2, the default setting is [MF].	
<b>mode6</b>	The shooting modes are based on [Dial Function] settings.	Switch the shooting mode to movie mode (  ).

## Viewing camera images on TV

### MENU → → → [HDMI], [Video Out]

Use the separately sold cable with the camera to playback recorded images on your TV. This function is available during shooting. Connect the camera to an HD TV using an HDMI cable to view high-quality images on a TV screen. When connecting TVs using an AV cable, first set the camera's [Video Out] settings (P. 102).

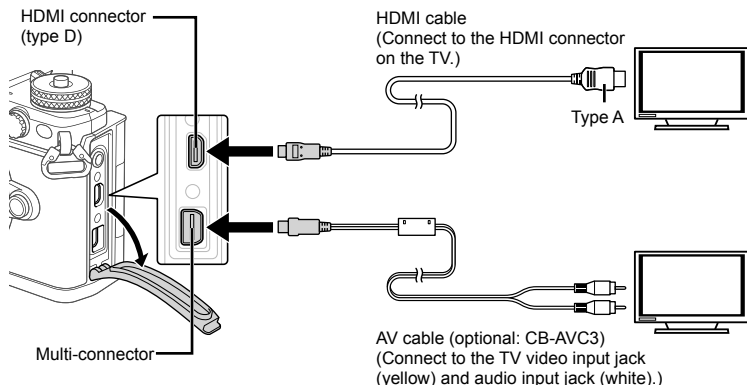

### 1 Connect the TV and camera and switch the input source of the TV.

- When an HDMI cable is connected, images are displayed on both the television and the camera monitor. Information display is showed on the television screen alone. To hide the information in the shooting display, press and hold the **INFO** button.
- The camera monitor turns off when an AV cable is connected.
- Press the button when connecting via an AV cable.

### Cautions

- For details on changing the input source of the TV, refer to the TV's instruction manual.
- Depending on the TV's settings, the displayed images and information may become cropped.
- If the camera is connected using both an AV and HDMI cables, it will assign priority to HDMI.
- If the camera is connected via an HDMI cable, you will be able to choose the digital video signal type. Choose a format that matches the input format selected with the TV.

<b>1080p</b>	Priority is given to 1080p HDMI output.
<b>720p</b>	Priority is given to 720p HDMI output.
<b>480p/576p</b>	480p/576p HDMI output. 576p is used when [PAL] is selected for [Video Out] (P. 102).

- Do not connect the camera to other HDMI output devices. Doing so may damage the camera.
- HDMI output is not performed while connected via USB to a computer or printer.
- When displayed information in mode is hidden, the camera screen cannot be displayed on the TV if the frame rate is not compatible with that TV.



## Using the TV remote control

The camera can be operated by a TV remote control when connected to a TV that supports HDMI control.  [HDMI] (P. 102)

The camera monitor turns off.

### Notes

- You can operate the camera by following the operation guide displayed on the TV.
- During single-frame playback, you can display or hide the information display by pressing the “Red” button, and display or hide the index display by pressing the “Green” button.
- Some televisions may not support all features.

## Choosing the control panel displays ( Control Settings)

**MENU** →  →  → [ Control Settings]

Sets whether or not to display control panels for option selection in each shooting mode.

In each shooting mode, press **OK** to insert a check in the control panel you want to display.

### How to display control panels

- Press the **OK** button while the control panel is displayed, then press the **INFO** button to switch the display.

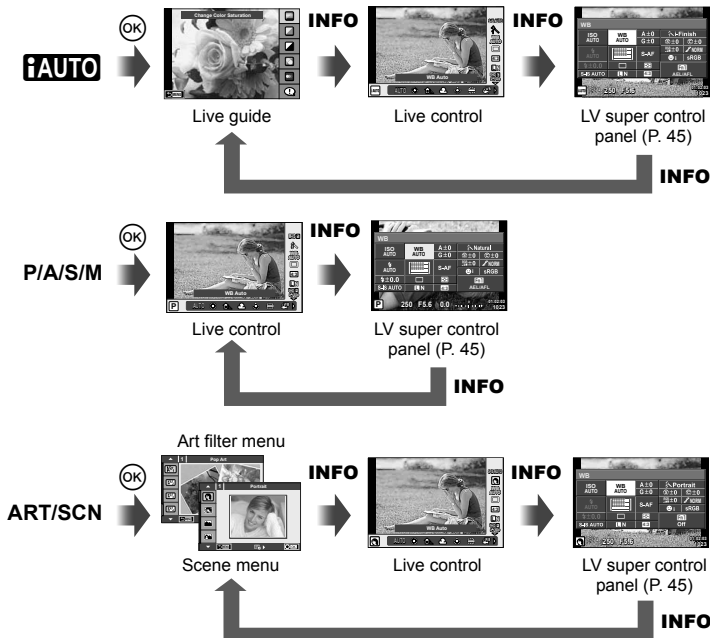

## Adding information displays

MENU → → → [Info Settings]

### LV-Info (Shooting information displays)

Use [LV-Info] to add the following shooting information displays. The added displays are displayed by repeatedly pressing the **INFO** button during shooting. You can also choose to not show displays that appear at the default setting.



Highlight & Shadow display

### Highlight & Shadow display

Areas above the upper limit of brightness for the image are shown in red, those below the lower limit in blue. [Histogram Settings] (P. 102)

### Info (Playback information displays)

Use [ Info] to add the following playback information displays. The added displays are displayed by repeatedly pressing the **INFO** button during playback. You can also choose to not show displays that appear at the default setting.



Histogram display



Highlight & Shadow display



Light box display

### Light box display

Compare two images side-by-side. Press to select the image on the opposite side of the display.

- The base image is displayed on the right. Use to select an image and press to move the image to the left. The image to be compared to the image on the left can be selected on the right. To choose a different base image, highlight the right frame and press .
- Press **Fn1** to zoom in on the current image. To change the zoom ratio, turn the rear dial. When zooming in, you can use to scroll to other areas of the image, and the front dial to select between images.



## Settings (Index/calendar display)

You can add an index display with a different number of frames and calendar display using [Settings]. The additional screens are displayed by turning the rear dial.

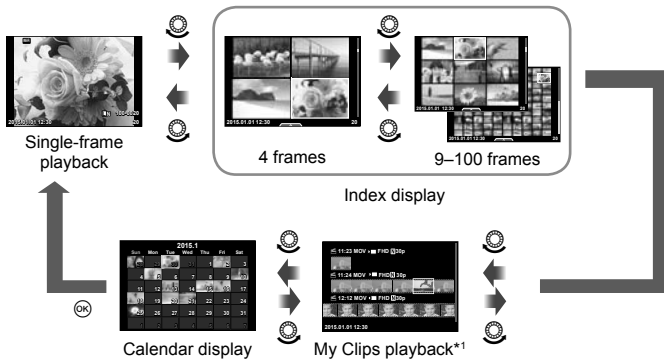

\*1 If one or more My Clips have been created, it will be displayed here (P. 42).

## Shutter speeds when the flash fires automatically

MENU → → → [ X-Sync.] [ Slow Limit]

You can set shutter speed conditions for when the flash fires.

Shooting mode	Flash timing (synchronous)	Upper limit	Lower limit
P	The slower of 1/(lens focal length×2) and the [ X-Sync.] settings	[ X-Sync.] setting*	[ Slow Limit] setting
A			No lower limit
S	The set shutter speed		No lower limit
M			

\* 1/250 seconds when using a separately sold external flash.

## Combinations of movie image sizes and compression rates

MENU → → → [ Set]

You can set the JPEG image quality by combining image size and compression rate.

Image size		Compression rate				Application
Name	Pixel count	SF (Super Fine)	F (Fine)	N (Normal)	B (Basic)	
<b>L</b> (Large)	4608×3456*	<b>L</b> SF	<b>L</b> F*	<b>L</b> N*	<b>L</b> B	Select for the print size
<b>M</b> (Middle)	3200×2400*	<b>M</b> SF	<b>M</b> F	<b>M</b> N*	<b>M</b> B	
	2560×1920					
	1920×1440					
	1600×1200					
<b>S</b> (Small)	1280×960*	<b>S</b> SF	<b>S</b> F	<b>S</b> N*	<b>S</b> B	For small prints and use on a website
	1024×768					
	640×480					

\* Default

## Shooting self-portraits using the selfie assist menu

MENU → → → [Selfie Assist]

When the monitor is in the selfie position, you can display a convenient touch menu.

- 1 Select [On] for [Selfie Assist] in Custom Menu tab .
- 2 Turn the monitor towards you.

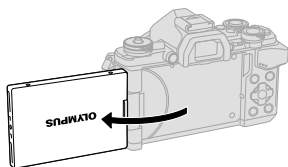

Self portrait menu

- The self portrait menu is displayed in the monitor.

Off	<b>One Touch e-Portrait</b>	Turning this on makes skin look smooth and translucent. Valid only during iAUTO mode ( <b>iAUTO</b> ).
	<b>Shutter Touch</b>	When the icon is touched, the shutter is released about 1 second later.
Off	<b>One Touch Custom Self Timer</b>	Shoot 3 frames using the self timer. You can set the number of times the shutter is released and the interval between each release using Custom Self Timer (P.58).

### 3 Frame the shot.

- Be careful that your fingers or the camera strap do not obstruct the lens.

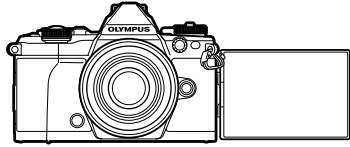

### 4 Touch and shoot.

- The shot image will be displayed on the monitor.
- You can also shoot by touching the subject displayed in the monitor, or by pressing the shutter button.

## Selecting the display style of the viewfinder

### MENU → → → [Built-in EVF Style]

Style 1/2: Displays only main items such as shutter speed and aperture value

Style 3: Displays same as the monitor



Style 1/ Style 2



Style 3

By connecting to a smartphone through this camera's wireless LAN function and using the specified app, you can enjoy even more features during and after shooting.

## Things you can do with the specified app, OLYMPUS Image Share (OI.Share)

- Camera image transfer to a smartphone  
You can load images in the camera to a smartphone.
- Remote shooting from a smartphone  
You can remotely operate the camera and shoot using a smartphone.
- Beautiful image processing  
You can apply art filters and add stamps on images loaded to a smartphone.
- Addition of GPS tags to camera images  
You can add GPS tags to images simply by transferring the GPS log saved on the smartphone to the camera.



For details, visit the address below:  
<http://oishare.olympus-imaging.com/>

## Cautions

- Before using the wireless LAN function, read "Using the wireless LAN function" (P. 163).
- If using the wireless LAN function in a country outside the region where the camera was purchased, there is a risk that the camera will not conform to the wireless communication regulations of that country. Olympus will not be held responsible for any failure to meet such regulations.
- As with any wireless communication, there is always a risk of interception by a third party.
- The wireless LAN function on the camera cannot be used to connect to a home or public access point.
- The wireless LAN antenna is contained in the camera grip. Keep the antenna away from metal objects whenever possible.
- During wireless LAN connection, the battery will run down faster. If the battery is running low, the connection may be lost during a transfer.
- Connection may be difficult or slow in proximity to devices that generate magnetic fields, static electricity or radio waves, such as near microwaves, cordless telephone.

## Connecting to a smartphone

Connect to a smartphone. Start the OI.Share App installed on your smartphone.

- 1 Select [Connection to Smartphone] in the  Playback Menu and press .
  - You can also connect by touching **Wi-Fi** in the monitor.
- 2 Following the guide displayed on the monitor, proceed with the Wi-Fi settings.
  - The SSID, password and QR code are displayed on the monitor.



- 3 Start OI.Share on your smartphone, and read the QR code displayed on the camera monitor.
  - Connection will be performed automatically.
  - If you are unable to read the QR code, enter the SSID and password in the Wi-Fi settings of your smartphone to connect. For how to access the Wi-Fi settings on your smartphone, please see your smartphone operating instructions.
- 4 To end the connection, press **MENU** on the camera or touch [End Wi-Fi] on the monitor screen.
  - You can also end the connection with OI.Share or by turning off your camera.
  - The connection ends.

## Transferring images to a smartphone

You can select images in the camera and load them to a smartphone. You can also use the camera to select images you want to share in advance.  “Setting a transfer order on images ([Share Order])” (P. 82)

### 1 Connect the camera to a smartphone (P. 118).

- You can also connect by touching  in the monitor.

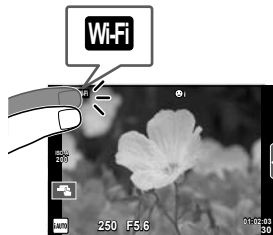

### 2 Launch OI.Share and tap the Image Transfer button.

- The images in the camera are displayed in a list.

### 3 Select the pictures you want to transfer and tap the Save button.

- When saving is completed, you can turn off the camera from the smartphone.

## Shooting remotely with a smartphone

You can shoot remotely by operating the camera with a smartphone. This is available only in [Private].

### 1 Start [Connection to Smartphone] on the camera.

- You can also connect by touching  in the monitor.

### 2 Launch OI.Share and tap the Remote button.

### 3 Tap the shutter button to shoot.

- The image taken is saved on the memory card in the camera.

#### Cautions

- Available shooting options are partially limited.



## Adding position information to images

You can add GPS tags to images that were taken while the GPS log was saving by transferring the GPS log saved on the smartphone to the camera.

This is available only in [Private].

- 1** Before beginning to shoot, launch OI.Share and turn on the switch on the Add Location button to begin saving the GPS log.
  - Before beginning to save the GPS log, the camera must be connected to OI.Share once to synchronize the time.
  - You can use the phone or other apps while the GPS log is saving. Do not terminate OI.Share.
- 2** When shooting is complete, turn off the switch on the Add Location button. Saving the GPS log is complete.
- 3** Start [Connection to Smartphone] on the camera.
  - You can also connect by touching **WiFi** in the monitor.
- 4** Transfer the saved GPS log to the camera using OI.Share.
  - GPS tags are added to the images in the memory card based on the transferred GPS log.
  -  is displayed on images to which position information has been added.

### Cautions

- Addition of location information can only be used with smartphones that have a GPS function.
- Position information cannot be added to movies.

## Changing the connection method

There are two ways to connect to a smartphone. With [Private] the same settings are used to connect every time. With [One-Time] different settings are used each time. You may find it convenient to use [Private] when connecting to your own smartphone and [One-Time] when transferring images to a friend's smartphone etc. The default setting is [Private].

- 1 Select [Wi-Fi Settings] in the **f** Setup Menu and press **OK**.
- 2 Select [Wi-Fi Connect Settings] and press **▷**.
- 3 Select the wireless LAN connection method and press **OK**.
  - [Private]: Connect to one smartphone (connects automatically using the settings after the initial connection). All OI.Share functions are available.
  - [One-Time]: Connect to multiple smartphones (connects using different connection settings each time). Only OI.Share's image transfer function is available. You can view only images that are set for share order using the camera.
  - [Select]: Select which method to use each time.
  - [Off]: The Wi-Fi function is turned off.

## Changing the password

Change the password used for [Private].

- 1 Select [Wi-Fi Settings] in the **f** Setup Menu and press **OK**.
- 2 Select [Private Password] and press **▷**.
- 3 Follow the operation guide and press the **◎** button.
  - A new password will be set.

## Cancelling a share order

Cancel share orders that are set on images.

- 1** Select [Wi-Fi Settings] in the **f** Setup Menu and press **OK**.
- 2** Select [Reset share Order] and press **▷**.
- 3** Select [Yes] and press **OK**.

## Initializing wireless LAN settings

Initializes content of [Wi-Fi Settings].

- 1** Select [Wi-Fi Settings] in the **f** Setup Menu and press **OK**.
- 2** Select [Reset Wi-Fi Settings] and press **▷**.
- 3** Select [Yes] and press **OK**.

## Connecting the camera to a computer

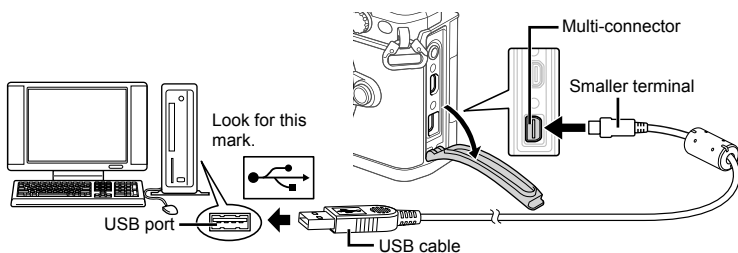

### Cautions

- If nothing is displayed on the camera screen even after connecting the camera to the computer, the battery may be exhausted. Use a full-charged battery.
- When the camera is turned on, a dialog should be displayed in the monitor prompting you to choose a host. If it is not, select [Auto] for [USB Mode] (P. 103) in the camera custom menus.

## Copying pictures to a computer

The following operating systems are compatible with the USB connection:

**Windows:** Windows XP SP3/Windows Vista SP2/Windows 7 SP1/  
Windows 8/Windows 8.1

**Macintosh:** Mac OS X v10.5 - v10.9

- 1 Turn the camera off and connect it to the computer.
  - The location of the USB port varies with the computer. For details, refer to your computer's manual.
- 2 Turn on the camera.
  - The selection screen for the USB connection is displayed.
- 3 Press  $\Delta$   $\nabla$  to select [Storage]. Press  $\text{OK}$ .
- 4 The computer recognizes the camera as a new device.

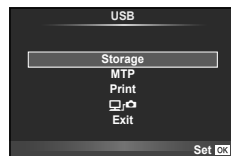

## Cautions

- If you are using Windows Photo Gallery for Windows Vista, Windows 7, Windows 8 or Windows 8.1, choose [MTP] in Step 3.
- Data transfer is not guaranteed in the following environments, even if your computer is equipped with a USB port.
  - Computers with a USB port added by means of an extension card, etc.
  - Computers without a factory-installed OS
  - Home-built computers
- Camera controls cannot be used while the camera is connected to a computer.
- If the dialog shown in Step 2 is not displayed when the camera is connected to a computer, select [Auto] for [USB Mode] (P. 103) in the camera custom menus.

## Installing the PC software

OLYMPUS Viewer 3 is software for importing to your computer, and then viewing, editing and managing the photographs and movies you have shot on your camera.

- You can also download OLYMPUS Viewer 3 from "<http://support.olympus-imaging.com/ov3download/>". You must enter the product's serial number to download OLYMPUS Viewer 3.

### ■ Windows

#### 1 Insert the supplied CD in a CD-ROM drive.

##### Windows XP

- A "Setup" dialog will be displayed.
- Microsoft has ended support for Windows XP. Use at your own risk, as security problems may occur.

##### Windows Vista/Windows 7/Windows 8/Windows 8.1

- An Autorun dialog will be displayed. Click "OLYMPUS Setup" to display the "Setup" dialog.



##### **Cautions**

- If the "Setup" dialog is not displayed, open CD-ROM (OLYMPUS Setup) in Windows Explorer and double-click "LAUNCHER.EXE".
- If a "User Account Control" dialog is displayed, click "Yes" or "Continue".

#### 2 Connect the camera to your computer.

##### **Cautions**

- When the camera is connected to another device via USB, a message will be displayed prompting you to choose a connection type. Select [Storage].

#### 3 Register your Olympus product.

- Click the "Registration" button and follow the on-screen instructions.

## 4 Install OLYMPUS Viewer 3.

- Check the system requirements before beginning installation.

### Operating Environment

<b>Operating System</b>	Windows XP SP3/Windows Vista SP2/ Windows 7 SP1/Windows 8/Windows 8.1
<b>Processor</b>	Pentium 4 1.3 GHz or better (Core2Duo 2.13 GHz or better required for movies)
<b>RAM</b>	1 GB or more (2 GB or more recommended)
<b>Free Hard Drive Space</b>	3 GB or more
<b>Monitor Settings</b>	1024 × 768 pixels or more Minimum 65,536 colors (16,770,000 colors recommended)

- Click the “OLYMPUS Viewer 3” button and follow the on-screen instructions to install the software.
- For details on how to use the software, please see the help function in the software.

## ■ Macintosh

### 1 Insert the supplied CD in a CD-ROM drive.

- The disk contents should automatically be displayed in the Finder. If they are not, double-click the CD icon on the desktop.
- Double-click the “Setup” icon to display the “Setup” dialog.

### 2 Install OLYMPUS Viewer 3.

- Check the system requirements before beginning installation.
- Click the “OLYMPUS Viewer 3” button and follow the on-screen instructions to install the software.

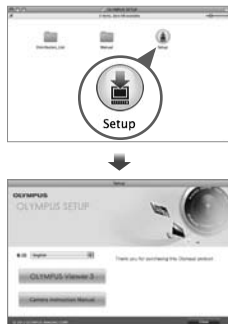

### Operating Environment

<b>Operating System</b>	Mac OS X v10.5–v10.9
<b>Processor</b>	Intel Core Solo/Duo 1.5 GHz or better (Core2Duo 2 GHz or better required for movies)
<b>RAM</b>	1 GB or more (2 GB or more recommended)
<b>Free Hard Drive Space</b>	3 GB or more
<b>Monitor Settings</b>	1024 × 768 pixels or more Minimum 32,000 colors (16,770,000 colors recommended)

- To change language, select the language you wish to use from the language combo box. For details on how to use the software, please see the help function in the software.

## Direct printing (PictBridge)

By connecting the camera to a PictBridge-compatible printer with the USB cable, you can print out recorded pictures directly.

- 1 Connect the camera to the printer using the supplied USB cable and turn the camera on.

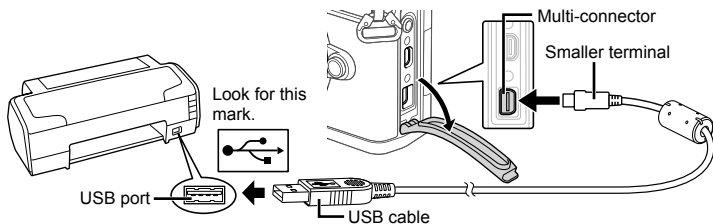

- Use a fully charged battery for printing.
- When the camera is turned on, a dialog should be displayed in the monitor prompting you to choose a host. If it is not, select [Auto] for [USB Mode] (P. 103) in the camera custom menus.

- 2 Use  $\Delta$   $\nabla$  to select [Print].

- [One Moment] will be displayed, followed by a print-mode selection dialog.
- If the screen is not displayed after a few minutes, disconnect the USB cable and start again from Step 1.

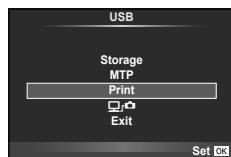

Proceed to “Custom printing” (P. 128).

### Cautions

- 3D photos, RAW images, and movies cannot be printed.

### Easy printing

Use the camera to display the picture you wish to print before connecting the printer via the USB cable.

- 1 Use  $\triangleleft$   $\triangleright$  to display the pictures you want to print on the camera.

- 2 Press  $\triangleright$ .

- The picture selection screen appears when printing is completed. To print another picture, use  $\triangleleft$   $\triangleright$  to select the image and press  $\text{OK}$ .
- To exit, unplug the USB cable from the camera while the picture selection screen is displayed.

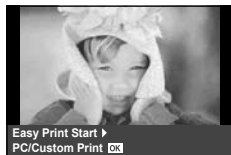

## Custom printing

- 1 Connect the camera to the printer using the supplied USB cable and turn the camera on.
  - When the camera is turned on, a dialog should be displayed in the monitor prompting you to choose a host. If it is not, select [Auto] for [USB Mode] (P. 103) in the camera custom menus.
- 2 Follow the operation guide to set a print option.

### Selecting the print mode

Select the type of printing (print mode). The available print modes are as shown below.

<b>Print</b>	Prints selected pictures.
<b>All Print</b>	Prints all the pictures stored in the card and makes one print for each picture.
<b>Multi Print</b>	Prints multiple copies of one image in separate frames on a single sheet.
<b>All Index</b>	Prints an index of all the pictures stored in the card.
<b>Print Order</b>	Prints according to the print reservation you made. If there is no picture with print reservation, this is not available.

### Setting the print paper items

This setting varies with the type of printer. If only the printer's STANDARD setting is available, you cannot change the setting.

<b>Size</b>	Sets the paper size that the printer supports.
<b>Borderless</b>	Selects whether the picture is printed on the entire page or inside a blank frame.
<b>Pics/Sheet</b>	Selects the number of pictures per sheet. Displayed when you have selected [Multi Print].

### Selecting pictures you want to print

Select pictures you want to print. The selected pictures can be printed later (single-frame reservation) or the picture you are displaying can be printed right away.





<b>Print (OK)</b>	Prints the currently displayed picture. If there is a picture that [Single Print] reservation has already been applied to, only that reserved picture will be printed.
<b>Single Print (△)</b>	Applies print reservation to the currently displayed picture. If you want to apply reservation to other pictures after applying [Single Print], use < > to select them.
<b>More (▽)</b>	Sets the number of prints and other items for the currently displayed picture, and whether or not to print it. For operation, refer to "Setting printing data" in the next section.



### Setting printing data

Select whether to print printing data such as the date and time or file name on the picture when printing. When the print mode is set to [All Print] and [Option Set] is selected, the following options appears.

	Sets the number of prints.
<b>Date</b>	Prints the date and time recorded on the picture.
<b>File Name</b>	Prints the file name recorded on the picture.
	Trims the picture for printing. Use the front dial (⊙) to choose the crop size and $\Delta \nabla \triangleleft \triangleright$ to specify the crop position.

- Once you have set the pictures for printing and printing data, select [Print], then press  $\odot$ .

- To stop and cancel printing, press  $\odot$ . To resume printing, select [Continue].

### ■ Cancelling printing

To cancel printing, highlight [Cancel] and press  $\odot$ . Note that any changes to the print order will be lost; to cancel printing and return to the previous step, where you can make changes to the current print order, press **MENU**.

## Print reservation (DPOF)

You can save digital “print orders” to the memory card listing the pictures to be printed and the number of copies of each print. You can then have the pictures printed at a print shop that supports DPOF or print the pictures yourself by connecting the camera directly to a DPOF printer. A memory card is required when creating a print order.

### Creating a print order

- Press  $\odot$  during playback and select  $\left[ \begin{array}{c} \square \\ \square \end{array} \right]$ .

- Select  $\left[ \begin{array}{c} \square \\ \square \end{array} \right]$  or  $\left[ \begin{array}{c} \square \\ \square \\ \square \end{array} \right]$  and press  $\odot$ .

#### Individual picture

Press  $\triangleleft \triangleright$  to select the frame that you want to set as print reservation, then press  $\Delta \nabla$  to set the number of prints.

- To set print reservation for several pictures, repeat this step. Press  $\odot$  when all the desired pictures have been selected.

#### All pictures

Select  $\left[ \begin{array}{c} \square \\ \square \\ \square \end{array} \right]$  and press  $\odot$ .

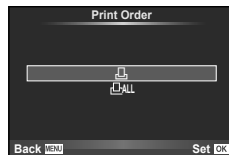

**3** Select the date and time format and press **OK**.

<b>No</b>	The pictures are printed without the date and time.
<b>Date</b>	The pictures are printed with the shooting date.
<b>Time</b>	The pictures are printed with the shooting time.



- When printing images, the setting cannot be changed between the images.

**4** Select **[Set]** and press **OK**.

**Cautions**

- The camera cannot be used to modify print orders created with other devices. Creating a new print order deletes any existing print orders created with other devices.
- Print orders cannot include 3D photos, RAW images, or movies.

**Removing all or selected pictures from the print order**

You can reset all print reservation data or just the data for selected pictures.

**1** Press **OK** during playback and select **[ ]**.

**2** Select **[ ]** and press **OK**.

- To remove all pictures from the print order, select **[Reset]** and press **OK**. To exit without removing all pictures, select **[Keep]** and press **OK**.

**3** Press **<>** to select images you wish to remove from the print order.

- Use **▽** to set the number of prints to 0. Press **OK** once you have removed all the desired pictures from the print order.

**4** Select the date and time format and press **OK**.

- This setting is applied to all frames with print reservation data.

**5** Select **[Set]** and press **OK**.

## Battery and charger

- The camera uses a single Olympus lithium-ion battery. Never use any battery other than genuine OLYMPUS batteries.
- The camera's power consumption varies widely with usage and other conditions.
- As the following consume a lot of power even without shooting, the battery will be drained quickly.
  - Performing auto focus repeatedly by pressing the shutter button halfway in shooting mode.
  - Displaying images on the monitor for a prolonged period.
  - When [Release Lag-Time] (P. 101) is set to [Short].
  - When connected to a computer or printer.
- When using a drained battery, the camera may turn off without the low battery warning being displayed.
- The battery will not be fully charged at the time of purchase. Charge the battery using the provided charger before use.
- The normal charging time using the provided charger is approximately 4 hours (estimated).
- Do not attempt to use chargers not specifically designated for use with the supplied battery, or to use batteries not specifically designated for use with the supplied charger.

### Cautions

- There is a risk of explosion if the battery is replaced with the incorrect battery type.
- Dispose of the used battery following the instructions "Handling the Battery" (P. 164).

## Using your charger abroad

- The charger can be used in most home electrical sources within the range of 100V to 240V AC (50/60 Hz) around the world. However, depending on the country or area you are in, the AC wall outlet may be shaped differently and the charger may require a plug adapter to match the wall outlet. For details, ask at your local electrical shop or travel agent.
- Do not use commercially available travel adapters as the charger may malfunction.

## Usable cards

In this manual, all storage devices are referred to as “cards.” The following types of SD memory card (commercially available) can be used with this camera: SD, SDHC, SDXC, and Eye-Fi. For the latest information, please visit the Olympus website.



### SD card write protect switch

The SD card body has a write protect switch. If you set the switch to the “LOCK” side, you will not be able to write to the card, delete data or format. Return the switch to the unlock position enable writing.



### Cautions

- The data in the card will not be erased completely even after formatting the card or deleting the data. When discarding, destroy the card to prevent leakage of personal information.
- Use the Eye-Fi card in compliance with the laws and regulations of the country where the camera is used. Remove the Eye-Fi card from the camera or disable the card functions in airplanes and other locations where use is prohibited.  [Eye-Fi] (P. 109)
- The Eye-Fi card may become hot during use.
- When using an Eye-Fi card, the battery may run out faster.
- When using an Eye-Fi card, the camera may function more slowly.
- Failure may occur during My Clips shooting. Please turn off the card function in this case.
- Setting the SD card's write protect switch to the “LOCK” position will restrict some functions such as clips shooting and playback.

## Record mode and file size/number of storable still pictures

The file size in the table is approximate for files with a 4:3 aspect ratio.

Record mode	Number of pixels (Pixel Count)	Compression	File format	File size (MB)	Number of storable still pictures*
RAW+SIF	7296×5472	uncompressed, 1/4	ORF, JPEG	Approx. 135.1	7
SIF		1/4	JPEG	Approx. 17.8	48
RAW	4608×3456	Loss-less compression	ORF	Approx. 14	41
LFSF		1/2.7	JPEG	Approx. 8.4	79
LF		1/4		Approx. 5.9	114
LN		1/8		Approx. 2.7	248
LB		1/12		Approx. 1.8	369
MSF	1/2.7	Approx. 5.6		155	
MF	3200×2400	1/4	JPEG	Approx. 3.4	257
MN		1/8		Approx. 1.7	508
MB		1/12		Approx. 1.2	753
MSF	2560×1920	1/2.7	JPEG	Approx. 3.2	271
MF		1/4		Approx. 2.2	398
MN		1/8		Approx. 1.1	782
MB		1/12		Approx. 0.8	1151
MSF	1920×1440	1/2.7	JPEG	Approx. 1.8	476
MF		1/4		Approx. 1.2	701
MN		1/8		Approx. 0.6	1356
MB		1/12		Approx. 0.4	1968
MSF	1600×1200	1/2.7	JPEG	Approx. 1.3	678
MF		1/4		Approx. 0.9	984
MN		1/8		Approx. 0.5	1907
MB		1/12		Approx. 0.4	2653
SSF	1280×960	1/2.7	JPEG	Approx. 0.9	1034
SF		1/4		Approx. 0.6	1488
SN		1/8		Approx. 0.3	2774
SB		1/12		Approx. 0.3	3814
SSF	1024×768	1/2.7	JPEG	Approx. 0.6	1564
SF		1/4		Approx. 0.4	2260
SN		1/8		Approx. 0.3	4068
SB		1/12		Approx. 0.2	5548
SSF	640×480	1/2.7	JPEG	Approx. 0.3	3589
SF		1/4		Approx. 0.2	5085
SN		1/8		Approx. 0.2	7628
SB		1/12		Approx. 0.1	10171

\*Assumes a 1GB SD card.

### Cautions

- The number of storable still pictures may change according to the subject, whether or not print reservations have been made, and other factors. In certain instances, the number of storable still pictures displayed on the monitor will not change even when you take pictures or erase stored images.
- The actual file size varies according to the subject.
- The maximum number of storable still pictures displayed on the monitor is 9999.
- For the available recording time for movies, see the Olympus website.

Choose a lens according to the scene and your creative intent. Use lenses designed exclusively for the Micro Four Thirds system and bearing the M.ZUIKO DIGITAL label or the symbol shown at right. With an adapter, you can also use Four Thirds System and OM System lenses.



### Cautions

- When you attach or remove the body cap and lens from the camera, keep the lens mount on the camera pointed downward. This helps prevent dust and other foreign matter from getting inside the camera.
- Do not remove the body cap or attach the lens in dusty places.
- Do not point the lens attached to the camera toward the sun. This may cause the camera to malfunction or even ignite due to the magnifying effect of sunlight focusing through the lens.
- Be careful not to lose the body cap and rear cap.
- Attach the body cap to the camera to prevent dust from getting inside when no lens is attached.

### ■ Lens and camera combinations

Lens	Camera	Attachment	AF	Metering
Micro Four Thirds system lens	Micro Four Thirds system camera	Yes	Yes	Yes
Four Thirds system lens		Attachment possible with mount adapter	Yes* <sup>1</sup>	Yes
OM System lenses			No	Yes* <sup>2</sup>
Micro Four Thirds system lens	Four Thirds System Camera	No	No	No

\*<sup>1</sup> AF is not operational when recording movies.

\*<sup>2</sup> Accurate metering is not possible.

## M.ZUIKO DIGITAL lens specifications

### ■ Names of parts

- ① Front cap
- ② Filter mount thread
- ③ Focus ring
- ④ Zoom ring (zoom lenses only)
- ⑤ Mount index
- ⑥ Rear cap
- ⑦ Electrical contacts
- ⑧ UNLOCK switch (only retractable lenses)
- ⑨ Decoration ring (only some lenses, remove when attaching a lens hood)

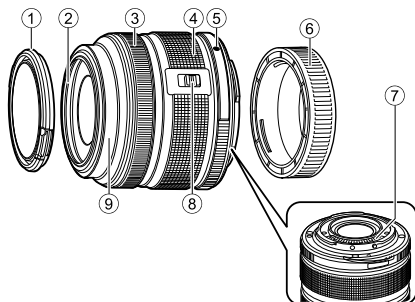

When storing, rotate the zoom ring while pressing the UNLOCK switch (⑧).

### ■ Using the power zoom lens (ED14-42mm f3.5-5.6EZ)

- The power zoom lens is automatically extended when you turn on the camera.

When the camera is turned off

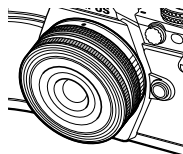

When the camera is turned on

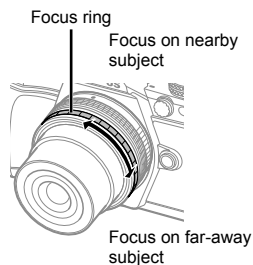
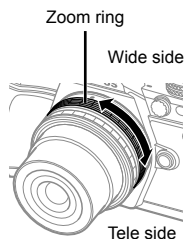

- You can use the camera custom menu to increase or decrease the zoom speed of zoom ring operations.  [Electronic Zoom Speed] (P. 110)
- The automatic lens cap (optional: LC-37C) can be attached to the lens. When you attach to the lens, the cap opens or closes automatically according whether the camera is on/off. There is no need to remove the cap every time you take a photograph. Cannot be used with a filter.

### Cautions

- Turn off the camera before attaching or removing the lens.
- Do not apply any pressure to the lens during lens operations, such as extending the lens.

## ■ Using power zoom lenses with macro functions (ED12-50mm f3.5-6.3EZ)

Lens operation is determined by the position of the zoom ring.

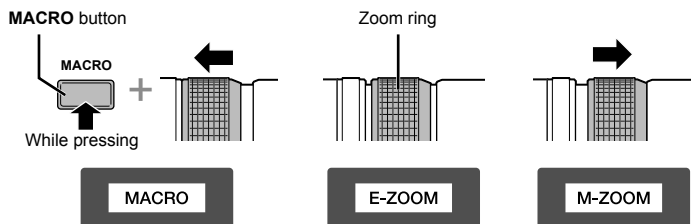

<b>E-ZOOM (Power Zoom)</b>	Rotate the zoom ring for power zoom. Zoom speed is determined by the amount of rotation.
<b>M-ZOOM (Manual Zoom)</b>	Rotate the zoom ring to zoom in and out.
<b>MACRO (Macro Photography)</b>	To photograph subjects at a range of 0.2 to 0.5 m, press the <b>MACRO</b> button and slide the zoom ring forward. Zoom is not available.

- The role of the **MF** button can be selected in the camera custom menu.

## ■ MF (manual focus) control (17mm f1.8, ED12mm f2.0 (Snapshot focus), ED12-40mm f2.8PRO (MF clutch focus))

Slide the focus ring in the direction of the arrow to change the focus method.

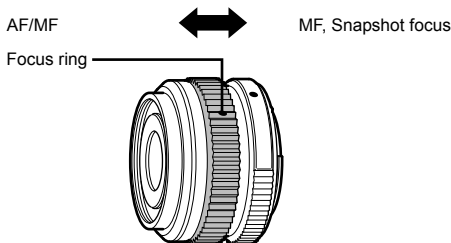

With snapshot focus, a distance is set using the focus ring based on the shooting distance. The camera focuses over a depth of field corresponding to the set aperture value.

- We recommend setting the aperture to F5.6 or above with a 17mm f1.8 or an ED12mm f2.0.
- You can shoot at the selected distance irrespective of the AF mode on the camera.
- When the lens is set to MF, the camera is set to manual focus regardless of the camera's settings.
- Use the distance scale only as a guide.



## ■ Cap lens control (BCL-0980 Fisheye, BCL-1580)

Use the MF lever to open and close the lens barrier, and adjust the focus between infinity and close-up.

- There is no data communication between camera and lens.
- Some functions of the camera cannot be used.
- Set the focal distance for the image stabilization function (P. 57) to 9 mm for the BCL-0980 Fisheye and 15 mm for the BCL-1580.

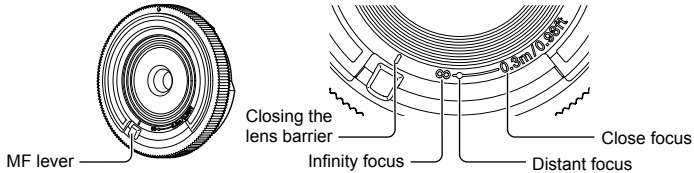

## ■ Main lens specifications

Items	ED14-42mm f3.5-5.6 EZ	ED12-40mm f2.8PRO	ED14-150mm f4.0-5.6 II
Mount	Micro Four Thirds mount		
Focal length	14 – 42 mm	12–40 mm	14 – 150 mm
Max. aperture	f/3.5 – 5.6	f/2.8	f/4.0–5.6
Image angle	75° – 29°	84.1°–30.3°	75°–8.2°
Lens configuration	7 groups, 8 lenses	9 groups, 14 lenses	11 groups, 15 lenses
Iris control	f/3.5 – 22	f/2.8–22	f/4.0–22
Shooting range (Focal length)	0.2 m – ∞ (14 mm) 0.25 m – ∞ (42 mm)	0.2m–∞	0.5m–∞
Focus adjustment	AF/MF switching	AF/MF, snapshot focus	AF/MF switching
Weight (excluding hood and cap)	93 g	382 g	260 g
Dimensions (Max. diameter × length)	ø60.8×22.5 mm	ø69.9×84 mm	ø63.5×83 mm
Filter mount thread diameter	37 mm	62 mm	58 mm
Lens hood	–	Supplied*	LH-61C

\* To remove the ED12-40mm lens hood, turn the lens hood while pressing in the buttons on both sides.

Items	25mm f1.8	ED12-50mm f3.5-6.3EZ	BCL-0980 Fisheye
Mount	Micro Four Thirds mount		
Focal length	25 mm	12–50 mm	9 mm
Max. aperture	f/1.8	f/3.5–6.3	f/8
Image angle	49.5°	84°–24°	140°
Lens configuration	7 groups, 9 lenses	9 groups, 10 lenses	4 groups, 5 lenses
Iris control	f/1.8 – 22	f/3.5–22	Fixed to f/8
Shooting range (Focal length)	0.25 m – ∞	0.35 m – ∞ 0.2–0.5 m (macro mode)	0.2 m – ∞
Focus adjustment	AF/MF switching		MF
Weight (excluding hood and cap)	137 g	212 g	28 g
Dimensions (Max. diameter × length)	ø57.8×42 mm	ø57×83 mm	ø56×12.8 mm
Filter mount thread diameter	46 mm	52 mm	–
Lens hood	LH-49B	LH-55B	–

### Cautions

- Edges of pictures may be cut off if more than one filter is used or if a thick filter is used.

## Power Battery Holder (HLD-8)

You can extend camera usage time by using the power battery holder with the camera's battery. You can assign functions to the camera's custom menu using the dial and Fn button. You can use an AC adaptor (sold separately) via the HLD-8. You can remove the battery portion from the HLD-8 and attach only the grip portion to the camera body.

Be sure to turn off the camera's power when attaching or removing the power battery holder.

### Names of parts

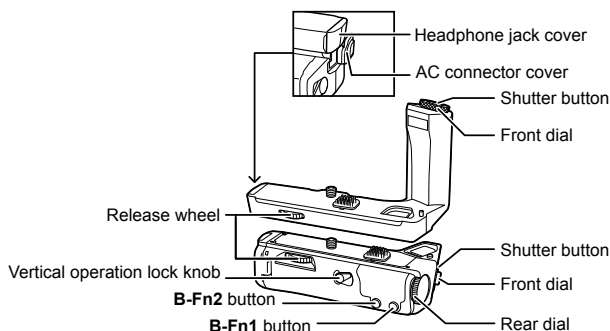

### Attaching the HLD-8

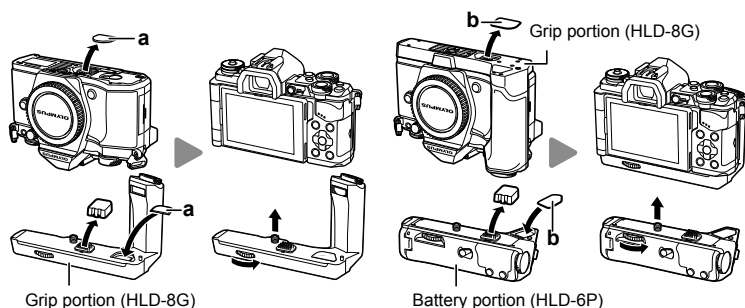

Remove the PBH cover (a) on the bottom of the camera and attach the HLD-8G. Once the HLD-8G is attached, turn the release wheel firmly. Be sure to put the PBH cover on the camera when the HLD-8G is not attached.

Next, remove the PBH cover (b) on the bottom of the grip and attach the battery part. Installation is similar to that for the grip.

### ■ Inserting the battery

Use a BLN-1 battery. After inserting the battery, be sure to lock the battery cover.

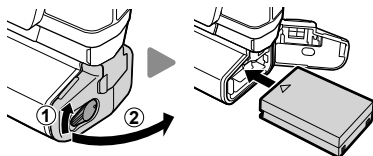

### ■ Using the AC adaptor

When using the AC adaptor, open the AC connector cover and plug in the AC connector.

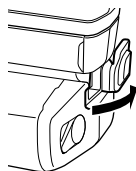

### ■ Using the dial and button

Set the functions for the HLD-8 dial and **B-Fn** button using [Button Function] (P. 66), [Dial Function], [Opt. Grip Dial Func.] (P. 101) on the camera's  custom menu.

### ■ Using the headphones

Open the headphone jack cover and plug in the headphones.

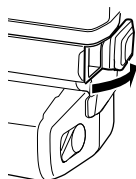

### ■ Main Specifications (HLD-8)

Power supply	Battery: Li-ion Battery BLN-1 ×1 AC power supply: AC adapter AC-3
Dimensions (W × H × D)	HLD-8G: Approx. 126.3 × 73.6 × 59.5 mm (5.0" × 2.9" × 2.3") HLD-6P: Approx. 117.8 × 31.3 × 56.4 mm (4.6" × 1.2" × 2.2")
Weight (excluding the battery and connector cap)	HLD-8G: Approx. 108 g (0.24 lb.) HLD-6P: Approx. 126.2 g (0.28 lb.)
Splash resistance (when attached to a camera)	Type Equivalent to IEC Standard publication 529 IPX1 (under OLYMPUS test conditions)

### Cautions

- Do not use batteries or AC adaptors other than those specified. Doing so may cause an injury or may cause the device to fail or explode.
- Do not use your fingernails to turn the release knob. Doing so may cause an injury.
- Use the camera only within the guaranteed operation temperature range.
- Do not use or store this device in locations with a lot of dust or high humidity.
- Do not touch the contact points of this device.
- If the main body or contacts become dirty, wipe them with a soft, dry cloth. Do not use a damp cloth or organic solvents such as paint thinner or benzene.

## External flash units designated for use with this camera

With this camera, you can use one of the separately sold external flash units to achieve a flash suited to your needs. The external flashes communicate with the camera, allowing you to control the camera's flash modes with various available flash control modes, such as TTL-AUTO and Super FP flash. An external flash unit specified for use with this camera can be mounted on the camera by attaching it to the camera's hot shoe. You can also attach the flash to the flash bracket on the camera using the bracket cable (optional). Refer to the documentation provided with the external flash units as well.

The upper limit of the shutter speed is 1/200 sec. when using a flash\*.

\* FL-50R only: 1/180 sec.

### Functions available with external flash units

Optional flash	Flash control mode	GN (Guide number) (ISO100)	RC mode
FL-600R	TTL-AUTO, AUTO, MANUAL, FP TTL AUTO, FP MANUAL	GN36 (85mm*) GN20 (24mm*)	✓
FL-300R	TTL-AUTO, MANUAL	GN20 (28mm*)	✓
FL-14	TTL-AUTO, AUTO, MANUAL	GN14 (28mm*)	—
RF-11	TTL-AUTO, MANUAL	GN11	—
TF-22		GN22	—

\*1 The focal length of the lens that can be used (Calculated based on 35 mm film camera).

## Wireless remote control flash photography

External flash units that are designated for use with this camera and have a remote control mode can be used for wireless flash photography. The camera can control the supplied flash unit and remote flash units in up to three separate groups. See the instruction manuals provided with the external flash units for details.

- 1 Set the remote flash units to RC mode and place them as desired.
  - Turn the external flash units on, press the MODE button, and select RC mode.
  - Select a channel and group for each external flash unit.
- 2 Select [On] for [⚡ RC Mode] in Shooting Menu 2 (P. 85).
  - The LV super control panel switches to RC mode.
  - You can choose an LV super control panel display by repeatedly pressing the **INFO** button.
  - Select a flash mode (note that red-eye reduction is not available in RC mode).

### 3 Adjust the settings for each group in the LV super control panel.

#### Group

- Select the flash control mode and adjust the flash intensity separately for each group. For MANUAL, select the flash intensity.

Adjust settings for the camera flash unit.

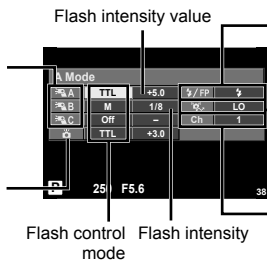

Normal flash/Super FP flash

- Switch between normal flash and Super FP flash.

Communication light level

- Set the communication light level to [H], [MID], or [LO].

Channel

- Set the communication channel to the same channel used on the flash.

### 4 Attach the supplied flash unit and turn on the camera.

- After confirming that the built-in and remote flash units have charged, take a test shot.

#### ■ Wireless flash control range

Position the wireless flash units with their remote sensors facing the camera. The following illustration shows the approximate ranges at which the flash units can be positioned. The actual control range varies with local conditions.

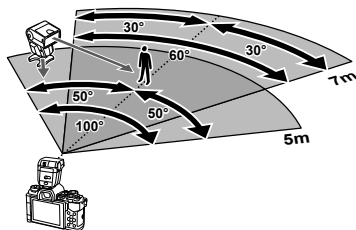

#### Cautions

- We recommend using a single group of up to three remote flash units.
- Remote flash units cannot be used for second curtain slow synchronization or anti-shock exposures longer than 4 seconds.
- If the subject is too close to the camera, the control flashes emitted by the camera flash may affect exposure (this effect can be reduced by reducing the output of the camera flash by, for example, using a diffuser).
- The upper limit of flash synchronization timing is 1/160 sec. when using the flash in RC mode.

## Other external flash units

Use after connecting the synchro cord to the hot shoe or external flash jack. When not using an external flash terminal, be sure to attach the cap.

When attaching a third-party flash to the camera's hot shoe or external flash jack, be careful of the following points.

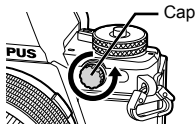

- Using obsolete flash units that apply currents of more than about 250 V to the X-contact will damage the camera.
- Connecting flash units with signal contacts that do not conform to Olympus specifications may damage the camera.
- Set the Shooting mode to **M**, set the shutter speed to a value no higher than flash synchronous speed, and set ISO sensitivity to a setting other than [AUTO].
- Flash control can only be performed by manually setting the flash to the ISO sensitivity and aperture values selected with the camera. Flash brightness can be adjusted by adjusting either ISO sensitivity or aperture.
- Use a flash with an angle of illumination suited to the lens. Angle of illumination is usually expressed using 35-mm format equivalent focal lengths.

## Principal Accessories

### Four Thirds lens adapter (MMF-2/MMF-3)

The camera requires a Four Thirds lens adapter to attach Four Thirds lenses. Some features, such as autofocus, may not be available.

### Remote cable (RM-UC1)

Use when the slightest camera movement can result in blurred pictures, for example for macro or bulb photography. The remote cable attaches via the camera multi-connector. (P. 10)

### Converter lenses

Converter lenses attach to the camera lens for quick and easy fish-eye or macro photography. See the OLYMPUS website for information on the lenses that can be used.

- Use the appropriate lens attachment for **SCN** mode (📷, 📷, or 📷).

### Eyecup (EP-16)

You can exchange this for a larger eyecup.

#### Removing

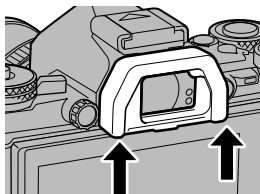

## System chart

### Power Supply



**BLN-1**  
Li-ion Battery



**BCN-1**  
Li-ion Battery Charger



**HLD-8**  
Power Battery Holder



**AC-3**  
AC Adapter

### Remote Operation

**RM-UC1**  
Remote Cable



### Connection Cable

USB Cable/  
AV Cable/  
HDMI Cable

### Case / Strap

Shoulder Strap  
Camera Case

### Underwater System

Underwater case

### Memory Card<sup>\*3</sup>

SD/SDHC/  
SDXC/Eye-Fi

### Software

**OLYMPUS Viewer 3**  
Digital Photo Managing Software

### Grip

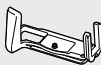

**ECG-2**  
Grip

### Viewfinder



**EP-16**  
Eyecup

## *E-M5* Mark II

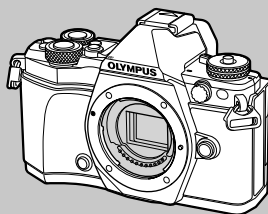

### Flash

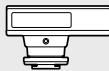

**FL-14**  
Electronic Flash



**FL-600R**  
Electronic Flash



**FL-300R**  
Electronic Flash

<sup>\*1</sup> Not all lenses can be used with adapter. For details, refer to the Olympus Official Web Site. Also, please note that manufacture of OM System Lenses has been discontinued.

<sup>\*2</sup> For compatible lens, refer to the Olympus Official Web Site.



 : E-M5II compatible products

 : Commercially available products

For the latest information, please visit the Olympus website.

## Lens



M.ZUIKO DIGITAL ED 12mm f2.0  
M.ZUIKO DIGITAL 17mm f1.8  
M.ZUIKO DIGITAL 17mm f2.8  
M.ZUIKO DIGITAL 25mm f1.8  
M.ZUIKO DIGITAL 45mm f1.8  
M.ZUIKO DIGITAL ED 60mm f2.8 Macro  
M.ZUIKO DIGITAL ED 75mm f1.8  
M.ZUIKO DIGITAL ED 9-18mm f4.0-5.6  
M.ZUIKO DIGITAL ED 12-40mm f2.8 PRO  
M.ZUIKO DIGITAL ED 12-50mm f3.5-6.3 EZ  
M.ZUIKO DIGITAL ED 14-42mm f3.5-6.3 EZ  
M.ZUIKO DIGITAL 14-42mm f3.5-5.6 II R  
M.ZUIKO DIGITAL ED14-150mmf4.0-5.6 II  
M.ZUIKO DIGITAL ED 40-150mm f4.0-5.6 R  
M.ZUIKO DIGITAL ED40-150mmf2.8 PRO  
M.ZUIKO DIGITAL 75-300mm f4.8-6.7 II  
Teleconverter MC-14\*\*4

## Converter Lens\*2

**FCON-P01**  
Fisheye

**WCON-P01**  
Wide

**MCON-P01**  
Macro

**MCON-P02**  
Macro



**MMF-2/MMF-3\*1**  
Four Thirds Adapter

  
Four Thirds System Lenses



**MF-2\*1**  
OM Adapter 2

OM System Lenses

## Flash

**SRF-11** Ring Flash Set



**RF-11\*2**  
Ring Flash

**STF-22** Twin Flash Set



**TF-22\*2**  
Twin Flash

**FC-1** Macro Flash Controller

\*3 Use the Eye-Fi card in compliance with the laws and regulations of the country where the camera is used.

\*4 Only available for ED40-150mmf2.8 PRO

## Shooting tips and information

### The camera does not turn on even when a battery is loaded

#### The battery is not fully charged

- Charge the battery with the charger.

#### The battery is temporarily unable to function because of the cold

- Battery performance drops at low temperatures. Remove the battery and warm it by putting it in your pocket for a while.

### No picture is taken when the shutter button is pressed

#### The camera has turned off automatically

- The camera automatically enters sleep mode to reduce the drain on the battery if no operations are performed for a set period of time.  [Sleep] (P. 103)  
If no operations are performed for a set time (4 hours) after the camera has entered sleep mode, the camera will turn off automatically.

#### The flash is charging

- On the monitor, the  mark blinks when charging is in progress. Wait for the blinking to stop, then press the shutter button.

#### Unable to focus

- The camera cannot focus on subjects that are too close to the camera or that are not suited to autofocus (the AF confirmation mark will blink in the monitor). Increase the distance to the subject or focus on a high contrast object at the same distance from the camera as your main subject, compose the shot, and shoot.

#### Subjects that are difficult to focus on

It may be difficult to focus with auto focus in the following situations.

AF confirmation mark is blinking. These subjects are not focused.

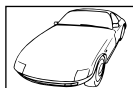

Subject with low contrast

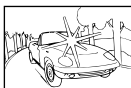

Excessively bright light in center of frame

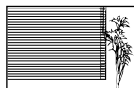

Subject containing no vertical lines

AF confirmation mark lights up but the subject is not focused.



Subjects at different distances

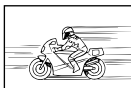

Fast-moving subject



Subject not inside AF area

### Noise reduction is activated

- When shooting night scenes, shutter speeds are slower and noise tends to appear in images. The camera activates the noise-reduction process after shooting at slow shutter speeds. During which, shooting is not allowed. You can set [Noise Reduct.] to [Off].  
 [Noise Reduct.] (P. 104)

### The number of AF targets is reduced

The number and size of AF targets varies with group target settings and the option selected for [Digital Tele-converter] and [Image Aspect].

### The date and time has not been set

#### The camera is used with the settings at the time of purchase

- The date and time of the camera is not set when purchased. Set the date and time before using the camera.  "Setting the date/time" (P. 18)

#### The battery has been removed from the camera

- The date and time settings will be returned to the factory default settings if the camera is left without the battery for approximately 1 day. The settings will be cancelled more quickly if the battery was only loaded in the camera for a short time before being removed. Before taking important pictures, check that the date and time settings are correct.

### Set functions are restored to their factory default settings

When you rotate the mode dial or turn off the power in a shooting mode other than **P**, **A**, **S**, or **M**, functions with changes made to their settings are restored to the factory default settings.

### Image taken appears whitish

This may occur when the picture is taken in backlight or semi-backlight conditions. This is due to a phenomenon called flare or ghosting. As far as possible, consider a composition where strong light source is not taken in the picture. Flare may occur even when a light source is not present in the picture. Use a lens hood to shade the lens from the light source. If a lens hood does not have effect, use your hand to shade the lens from the light.

 "Interchangeable lenses" (P. 134)

### Unknown bright dot(s) appear on the subject in the picture taken

This may be due to stuck pixel(s) on the image pickup device. Perform [Pixel Mapping].











If the problem persists, repeat pixel mapping a few times.  "Pixel Mapping - Checking the image processing functions" (P. 151)









### Functions that cannot be selected from menus

Some items may not be selectable from the menus when using the arrow pad.

- Items that cannot be set with the current shooting mode.
- Items that cannot be set because of an item that has already been set:  
Combination of  and [Noise Reduct.], etc.

## Error codes

Monitor indication	Possible cause	Corrective action
 No Card	The card is not inserted, or it cannot be recognized.	Insert a card or insert a different card.
 Card Error	There is a problem with the card.	Insert the card again. If the problem persists, format the card. If the card cannot be formatted, it cannot be used.
 Write Protect	Writing to the card is prohibited.	The card write-protect switch is set to the "LOCK" side. Release the switch. (P. 132)
 Card Full	<ul style="list-style-type: none"> <li>The card is full. No more pictures can be taken or no more information such as print reservation can be recorded.</li> <li>There is no space in the card and print reservation or new images cannot be recorded.</li> </ul>	Replace the card or erase unwanted pictures. Before erasing, download important images to a PC.
	Card cannot be read. Card may not have been formatted.	<ul style="list-style-type: none"> <li>Select [Clean Card], press  and turn off the camera. Remove the card and wipe the metallic surface with a soft, dry cloth.</li> <li>Select [Format] ▶ [Yes], and then press  to format the card. Formatting the card erases all data on the card.</li> </ul>
 No Picture	There are no pictures on the card.	The card contains no pictures. Record pictures and play back.
 Picture Error	The selected picture cannot be displayed for playback due to a problem with this picture. Or the picture cannot be used for playback on this camera.	Use image processing software to view the picture on a PC. If that cannot be done, the image file is damaged.
 The Image Cannot Be Edited	Pictures taken with another camera cannot be edited on this camera.	Use image processing software to edit the picture.

Monitor indication	Possible cause	Corrective action
		Turn off the camera and wait for the internal temperature to cool.
 Internal camera temperature is too high. Please wait for cooling before camera use.	The internal temperature of the camera has risen due to sequential shooting.	Wait a moment for the camera to turn off automatically. Allow the internal temperature of the camera to cool before resuming operations.
 Battery Empty	The battery is drained.	Charge the battery.
 No Connection	The camera is not correctly connected to a computer, printer, HDMI display, or other device.	Reconnect the camera.
 No Paper	There is no paper in the printer.	Load some paper in the printer.
 No Ink	The printer has run out of ink.	Replace the ink cartridge in the printer.
 Jammed	The paper is jammed.	Remove the jammed paper.
Settings Changed	The printer's paper cassette has been removed or the printer has been manipulated while making settings on the camera.	Do not manipulate the printer while making settings on the camera.
 Print Error	There is a problem with the printer and/or camera.	Turn off camera and printer. Check the printer and remedy any problems before turning the power on again.
 Cannot Print	Pictures recorded on other cameras may not be printed on this camera.	Use a personal computer to print.
The lens is locked. Please extend the lens.	The lens of the retractable lens stays retracted.	Extend the lens. (P. 15)
Please check the status of a lens.	An abnormality has occurred between the camera and the lens.	Turn off the camera, check the connection with the lens, and turn the power on again.

## Cleaning and storing the camera

### Cleaning the camera

Turn off the camera and remove the battery before cleaning the camera.

#### Exterior:

- Wipe gently with a soft cloth. If the camera is very dirty, soak the cloth in mild soapy water and wring well. Wipe the camera with the damp cloth and then dry it with a dry cloth. If you have used the camera at the beach, use a cloth soaked in clean water and well wrung.

#### Monitor:

- Wipe gently with a soft cloth.

#### Lens:

- Blow dust off the lens with a commercially available blower. For the lens, wipe gently with a lens cleaning paper.

### Storage

- When not using the camera for a prolonged period, remove the battery and card. Store the camera in a cool, dry place that is well ventilated.
- Insert the battery periodically and test the camera's functions.
- Remove dust and other foreign matter from the body and rear caps before attaching them.
- Attach the body cap to the camera to prevent dust from getting inside when no lens is attached. Be sure to replace the front and rear lens caps before putting the lens away.
- Clean the camera after use.
- Do not store with insect repellent.

### Cleaning and checking the image pickup device

This camera incorporates a dust reduction function to keep dust from getting on the image pickup device and to remove any dust or dirt from the image pickup device surface with ultrasonic vibrations. The dust reduction function operates when the camera is turned on.





The dust reduction function operates at the same time as the pixel mapping, which checks the image pickup device and image processing circuitry. Since dust reduction is activated every time the camera's power is turned on, the camera should be held upright for the dust reduction function to be effective.

#### Cautions

- Do not use strong solvents such as benzene or alcohol, or a chemically treated cloth.
- Avoid storing the camera in places where chemicals are treated, in order to protect the camera from corrosion.
- Mold may form on the lens surface if the lens is left dirty.
- Check each part of the camera before use if it has not been used for a long time. Before taking important pictures, be sure to take a test shot and check that the camera works properly.

## Pixel Mapping - Checking the image processing functions

The pixel mapping feature allows the camera to check and adjust the image pickup device and image processing functions. After using the monitor or taking continuous shots, wait for at least one minute before using the pixel mapping function to ensure that it operates correctly.

- 1 Select [Pixel Mapping] in  Custom Menu (P. 109) tab .
  - 2 Press , then press .
- The [Busy] bar is displayed when pixel mapping is in progress. When pixel mapping is finished, the menu is restored.

### Cautions

- If you accidentally turn the camera off during pixel mapping, start again from Step 1.

















## Menu directory

\*1: Can be added to [Myset].

\*2: Default can be restored by selecting [Full] for [Reset].

\*3: Default can be restored by selecting [Basic] for [Reset].

### Shooting Menu

Tab	Function	Default	*1	*2	*3				
	Card Setup	—				85			
	Reset/Myset	—		✓		86			
	Picture Mode	 Natural		✓		✓	70		
		Still Picture	 N		✓	✓	✓	61	
		Movie	MOV  FHD  60p		✓	✓	✓	62	
	Image Aspect	4:3		✓	✓	✓	60		
	Digital Tele-converter	Off		✓	✓	✓	88		
			<input type="checkbox"/>		✓	✓	✓	88	
		Time Lapse Settings	Off				89		
		Frame	99						
		Start Waiting Time	00:00:01			✓			✓
		Interval Time	00:00:01						
		Time Lapse Movie	Off						
		Bracketing	Off				90		
AE BKT		3f 1.0EV				91			
WB BKT		A-B G-M	—	✓	✓		✓		
FL BKT		—				91			
ISO BKT		—				92			
ART BKT		—				92			
HDR		Off		✓	✓	✓	53		
Multiple Exposure		Frame	Off				93		
		Auto Gain	Off			✓		✓	
		Overlay	Off						
Keystone Comp.		Off		✓	✓	✓	94		
Anti-Shock  /Silent 		Anti-Shock 	On (0 sec.)				59		
		Silent 	On (0 sec.)	✓	✓				
	Noise Reduction 	Off							
High Res Shot	High Res Shot	On (0 sec.)				60			
	 Charge Time	0 sec.	✓	✓					
 RC Mode	Off		✓	✓	✓	141			



## ▶ Playback Menu

Tab	Function		Default	*1	*2	*3	☞	
▶	▶	Start	—				80	
		BGM	Joy		✓	✓		
		Slide	All		✓	✓		
		Slide Interval	3sec		✓			
		Movie Interval	Short		✓			
	☑		On		✓	✓	96	
	Edit	Sel. Image	RAW Data Edit	—				96
			JPEG Edit	—				97
			🎤	—				98
		Image Overlay	—				98	
Print Order		—				129		
Reset Protect		—				98		
Connection to Smartphone		—				119		

## ⏏ Setup Menu

Tab	Function		Default	*1	*2	*3	☞	
⏏			—				18	
	🔒*		—				99	
	📷		±0, 🌞 ±0, Natural		✓		99	
	Rec View		0.5sec	✓	✓		99	
	Wi-Fi Settings	Wi-Fi Connect Settings		Private		✓		122
		Private Password		—				
		Reset share Order		—				
		Reset Wi-Fi Settings		—				
	⚙️ Menu Display		Off		✓		99	
	Firmware		—				99	

\* Settings differ depending on the region where the camera is purchased.

## ⚙️ Custom Menu

Tab	Function		Default	*1	*2	*3	☞	
⚙️	📷	AF/MF					100	
		AF Mode	Still Picture Movie	S-AF C-AF	✓	✓		✓
	Full-time AF		Off	✓	✓	✓		
	AEL/AFL		S-AF	mode1	✓	✓		✓
			C-AF	mode2				
			MF	mode1				
	Reset Lens		On		✓	✓		
	Bulb/Time Focusing		On		✓	✓		
	Focus Ring		🕒		✓	✓		

Tab	Function	Default	*1	*2	*3		
	AF/MF	Magnify	Off	✓	✓	100	
		MF Assist	Peaking	Off	✓		✓
			Set Home				✓
		AF Illuminat.	On	✓	✓		✓
		Face Priority		✓	✓		✓
		AF Area Pointer	On	✓	✓		✓
		Button Function	Function	AEL/AFL	✓	✓	66
			Function	Multi Function			
			Function	O			
			Function	HDR			
			Function	REC			
			Function				
			Function	*			
			Function	/*			
			Function				
			Function	AEL/AFL			
			Function				
		Function	AF Stop				
		Dial Function	P		✓	✓	101
A	FNo./						
S	Shutter/						
M	Shutter/FNo.						
Menu							
		Prev/Next/					
Dial Direction	Exposure	Dial1	✓	✓			
	Ps	Dial1					
Mode Dial Function	Off			✓			
Lever Function	mode 1			✓			
Opt. Grip Dial Func.	VOL			✓			
	Release/					101	
	RIs Priority S	Off	✓	✓	✓		
	RIs Priority C	On	✓	✓	✓		
	L fps	5 fps	✓	✓	✓		
	H fps	10 fps	✓	✓	✓		
	L fps	5 fps	✓	✓	✓		
	H fps	11 fps	✓	✓	✓		
	Image Stabilizer	Still Picture	S-I.S. Auto	✓	✓		✓
		Movie	M-IS1				
	Image Stabilization	Off			✓		
	Half Way RIs With IS	On			✓		
	Lens I.S. Priority	Off		✓	✓		✓
	Release Lag-Time	Normal			✓		

\* When Function] is set to [Direct Function].

Tab	Function	Default	*1	*2	*3		
	Disp/	HDMI Out	1080p		✓		
		HDMI Control	Off		✓		
	Video Out		—				
	Control Settings	iAUTO	Live Guide		✓	✓	
		P/A/S/M	Live SCP		✓	✓	
		ART	Art Menu		✓	✓	
		SCN	Scene Menu		✓	✓	
	/Info Settings	Info	Image Only, Overall		✓	✓	✓
		LV-Info	Image Only, Custom1 () Custom2 (Level Gauge Display)		✓	✓	
		Settings	25, Calendar, "My Clips" playback		✓	✓	
	Displayed Grid		Off		✓	✓	
	Picture Mode Settings		All On		✓	✓	
	Histogram Settings	Highlight	255				
		Shadow	0			✓	
	Mode Guide		On			✓	
	Live View Boost	M	On1				
		BULB/TIME	On2				
		COMP	Off		✓	✓	✓
		Others	Off				
	Frame Rate		Normal		✓	✓	✓
	Art LV Mode		mode1			✓	
	Expand LV Dyn. Range		On			✓	
	Flicker reduction		Auto			✓	
	LV Close Up Mode		mode2			✓	
	Lock		Off		✓	✓	
	Peaking Settings	Peaking Color	White				
		Highlight Intensity	Normal		✓	✓	
		Image Brightness Adj.	On				
	Backlit LCD		Hold		✓	✓	✓
	Sleep		1min		✓	✓	✓
	Auto Power Off		4h			✓	✓
			On		✓	✓	✓
USB Mode		Auto			✓	✓	
Multi Function Settings		Color Creator, Magnify, Aspect		✓	✓		
Menu Recall		mode1			✓		

102

103

10

Information

Tab	Function	Default	*1	*2	*3		
	Exp//ISO						
	EV Step	1/3EV	✓	✓	✓	104	
	Noise Reduct.	Auto	✓	✓	✓		
	Noise Filter	Standard	✓	✓	✓		
	ISO	Auto	✓	✓	✓		
	ISO Step	1/3EV	✓	✓	✓		
	ISO-Auto Set	High Limit: 1600 Default: 200	✓	✓	✓		
	ISO-Auto	P/A/S	✓	✓			
	Metering		✓	✓	✓		
	AEL Metering	Auto	✓	✓	✓		
	Bulb/Time Timer	8min	✓	✓	✓		
	Bulb/Time Monitor	-7	✓	✓			
	Live Bulb	Off	✓	✓			
	Live Time	0.5 sec	✓	✓			
	Composite Settings	1 sec	✓	✓			
	Custom						
	X-Sync.	1/250	✓	✓	✓	105	
	Slow Limit	1/60	✓	✓	✓		
	+	Off	✓	✓	✓		
	/Color/WB						
	Set	-1 F, -2 N, -3 N, -4 S	✓	✓	✓	105	
	Pixel	iddle	3200×2400	✓	✓		✓
	Count	mall	1280×960	✓	✓		✓
	Shading Comp.		Off	✓	✓		✓
	WB		Auto   A:0, G:0	✓	✓		✓
	All	All Set All Reset	— —	✓	✓		✓
	Keep Warm Color		On	✓	✓	✓	
	+WB		WB AUTO	✓	✓		
	Color Space		sRGB	✓	✓	✓	
							106

Tab	Function	Default	*1	*2	*3		
	Record/Erase						
	Quick Erase	Off	✓	✓	✓	106	
	RAW+JPEG Erase	RAW+JPEG	✓	✓	✓		
	File Name	Reset		✓			
	Edit Filename	Off		✓			
	Priority Set	No		✓	✓		
	dpi Settings	350dpi		✓			
	Copyright Settings	Copyright Info.	Off		✓		107
		Artist Name	—				
		Copyright Name	—				
	Movie						
	Mode	P		✓		107	
	Movie	On	✓	✓	✓		
	Recording Volume	Built-In	±0		✓		
		MIC	±0		✓		
	Volume Limiter	On		✓			
	Wind Noise Reduction	Off		✓			
	Plug-in Power	On		✓			
	PCM Recorder  Link	Off		✓			
	Headphone Volume	8		✓			
	Time Code Settings	Time Code Mode	DF (Drop Frame)		✓		
Count Up		RR (Rec Run)		✓			
Starting Time		—					
Info Settings		All On		✓			
Movie Specification Settings	1 FHD <b>F</b> ,  2 FHD <b>SF</b> , 3 FHD <b>F</b> ,  4 FHD <b>N</b>			✓			
Movie Effect	On		✓				
Movie+Photo Mode	mode1		✓				
Shutter Function	mode1		✓				
	Built-In EVF						
	Built-in EVF Style	Style 3		✓		109	
	Info Settings	Basic Information, Custom1 () , Custom2 (Level Gauge Display)	✓	✓			
	Displayed Grid	Off	✓	✓	✓		
	EVF Auto Switch	On		✓			
	EVF Adjust	EVF Auto Luminance	On		✓		
		Half Way Level	On		✓		

Tab	Function	Default	*1	*2	*3		
	Utility						
	Pixel Mapping		—				109
	Exposure Shift		±0	✓	✓		
		Warning Level	±0		✓		
		Battery Priority	PBH Battery	✓	✓		
	Level Adjust		—		✓		
	Touch Screen Settings		On		✓		
	Eye-Fi		On		✓		
	Electronic Zoom Speed	Still Picture	Normal		✓		110
		Movie	Normal				
	Selfie Assist		On		✓		
	Quick Sleep Mode				✓	✓	
		Backlit LCD	3 sec				
Sleep		3 sec					

## Specifications

### ■ Camera

<b>Product type</b>	
Product type	Digital camera with interchangeable Micro Four Thirds Standard lens system
Lens	M.Zuiko Digital, Micro Four Thirds System Lens
Lens mount	Micro Four Thirds mount
Equivalent focal length on a 35 mm film camera	Approx. twice the focal length of the lens
<b>Image pickup device</b>	
Product type	4/3" Live MOS sensor
Total no. of pixels	Approx. 17,200,000 pixels
No. of effective pixels	Approx. 16,050,000 pixels
Screen size	17.3 mm (H) × 13.0 mm (V)
Aspect ratio	1.33 (4:3)
<b>Viewfinder</b>	
Type	Electronic viewfinder with eye sensor
No. of pixels	Approx. 2,360,000 dots
Magnification	100%
Eye point	Approx. 21 mm (−1 m <sup>-1</sup> )
<b>Live view</b>	
Sensor	Uses Live MOS sensor
Field of view	100%
<b>Monitor</b>	
Product type	3.0" TFT color LCD, Vari-angle, touch screen
Total no. of pixels	Approx. 1,040,000 dots (aspect ratio 3:2)
<b>Shutter</b>	
Product type	Computerized focal-plane shutter
Shutter speed	1/8000 - 60 sec., bulb photography, time photography
<b>Auto focus</b>	
Product type	Hi-Speed Imager AF
Focusing points	81 points
Selection of focusing point	Auto, Optional
<b>Exposure control</b>	
Metering system	TTL metering system (imager metering) Digital ESP metering/Center weighted averaging metering/Spot metering
Metered range	EV -2 - 20 (Equivalent to M.ZUIKO DIGITAL 17mm f2.8, ISO100)
Shooting modes	<b>i</b> AUTO: iAUTO/ <b>P</b> : Program AE (Program shift can be performed)/ <b>A</b> : Aperture priority AE/ <b>S</b> : Shutter priority AE/ <b>M</b> : Manual/ <b>ii</b> : PHOTO STORY/ <b>ART</b> : Art filter/ <b>SCN</b> : Scene/ <b>Q</b> : Movie
ISO sensitivity	LOW, 200 - 25600 (1/3, 1 EV step)
Exposure compensation	±5EV (1/3, 1/2, 1 EV step)
<b>White balance</b>	
Product type	Image pickup device
Mode setting	Auto/Preset WB (7 settings)/Customized WB/One-touch WB

<b>Recording</b>	
Memory	SD, SDHC, SDXC and Eye-Fi UHS-II compatible
Recording system	Digital recording, JPEG (in accordance with Design rule for Camera File system (DCF)), RAW Data, MP format
Applicable standards	Exif 2.3, Digital Print Order Format (DPOF), PRINT Image Matching III, PictBridge
Sound with still pictures	Wave format
Movie	MPEG-4 AVC/H.264 / Motion JPEG
Audio	Stereo, PCM 48kHz
<b>Playback</b>	
Display format	Single-frame playback/Close-up playback/Index display/Calendar display
<b>Drive</b>	
Drive mode	Single-frame shooting/Sequential shooting/Self-timer
Sequential shooting	Up to 10 fps (📷)
Self-timer	Operation time: 12 sec./2 sec./Customized
Energy saving function	Switch to sleep mode: 1 minute, Power OFF: 4 hours (This function can be customized.)
<b>Flash</b>	
Flash control mode	TTL-AUTO (TTL pre-flash mode)/MANUAL
Sync speed	1/250 s or slower
<b>Wireless LAN</b>	
Compatible standard	IEEE 802.11b/g/n
<b>External connector</b>	
Multi-connector (USB connector, AV connector)/HDMI micro-connector (type D)	
<b>Power supply</b>	
Battery	Li-ion Battery ×1
<b>Dimensions/weight</b>	
Dimensions	123.7 mm (W) × 85 mm (H) × 38 mm (D) (4.9" × 3.3" × 1.5") (excluding protrusions)
Weight	Approx. 469 g (1.0 lb.) (including battery and memory card)
<b>Operating environment</b>	
Temperature	-10 °C - 40 °C (14 °F - 104 °F) (operation)/ -20 °C - 60 °C (-4 °F - 140 °F) (storage)
Humidity	30% - 90% (operation)/10% - 90% (storage)
<b>Splash resistance</b>	
Type	Equivalent to IEC Standard publication 529 IPX1 (under OLYMPUS test conditions)

HDMI, the HDMI logo and High-Definition Multimedia Interface are trademarks or registered trademarks of HDMI Licensing LLC.

**HDMI**™  
HIGH-DEFINITION MULTIMEDIA INTERFACE



### ■ FL-LM3 Flash

Guide number	9.1 (ISO100•m) 12.7 (ISO200•m)
Firing angle	Covers the picture angle of a 12 mm lens (equivalent to 24 mm in 35 mm format)
Dimensions	Approx. 43.6 mm (W) × 49.4 mm (H) × 39 mm (D) (1.7" × 1.9" × 1.5")
Weight	Approx. 51 g (0.1 lb.)
Splash resistance	Type Equivalent to IEC Standard publication 529 IPX1 (under OLYMPUS test conditions)

### ■ Lithium ion battery

MODEL NO.	BLN-1
Product type	Rechargeable Lithium ion battery
Nominal voltage	DC 7.6 V
Nominal capacity	1220 mAh
No. of charge and discharge times	Approx. 500 times (varies with usage conditions)
Ambient temperature	0 °C - 40 °C (32 °F - 104 °F) (charging)
Dimensions	Approx. 36.0 mm (W) × 15.4 mm (H) × 50.2 mm (D) (1.4" × 0.6" × 2.0")
Weight	Approx. 52 g (0.1 lb.)

### ■ Lithium ion charger

MODEL NO.	BCN-1
Rated input	AC 100V - 240V (50/60 Hz)
Rated output	DC 8.7 V, 600 mA
Charging time	Approx. 4 hours (room temperature)
Ambient temperature	0 °C - 40 °C (32 °F - 104 °F) (operation)/ -20 °C - 60 °C (-4 °F - 140 °F) (storage)
Dimensions	Approx. 67 mm (W) × 26 mm (H) × 95.5 mm (D) (2.6" × 1.0" × 3.8")
Weight (without AC cable)	Approx. 77 g (0.2 lb.)

- The AC cable supplied with this device is for use only with this device and should not be used with other devices. Do not use cables for other devices with this device.

SPECIFICATIONS ARE SUBJECT TO CHANGE WITHOUT ANY NOTICE OR OBLIGATION ON THE PART OF THE MANUFACTURER.

## SAFETY PRECAUTIONS



## CAUTION

RISK OF ELECTRIC SHOCK  
DO NOT OPEN

CAUTION: TO REDUCE THE RISK OF ELECTRICAL SHOCK, DO NOT REMOVE COVER (OR BACK). NO USER-SERVICEABLE PARTS INSIDE. REFER SERVICING TO QUALIFIED OLYMPUS SERVICE PERSONNEL.



An exclamation mark enclosed in a triangle alerts you to important operating and maintenance instructions in the documentation provided with the product.



## DANGER

If the product is used without observing the information given under this symbol, serious injury or death may result.



## WARNING

If the product is used without observing the information given under this symbol, injury or death may result.



## CAUTION

If the product is used without observing the information given under this symbol, minor personal injury, damage to the equipment, or loss of valuable data may result.

## WARNING!

TO AVOID THE RISK OF FIRE OR ELECTRICAL SHOCK, NEVER DISASSEMBLE, EXPOSE THIS PRODUCT TO WATER OR OPERATE IN A HIGH HUMIDITY ENVIRONMENT.

## General Precautions

**Read All Instructions** — Before you use the product, read all operating instructions. Save all manuals and documentation for future reference.**Cleaning** — Always unplug this product from the wall outlet before cleaning. Use only a damp cloth for cleaning. Never use any type of liquid or aerosol cleaner, or any type of organic solvent to clean this product.**Attachments** — For your safety, and to avoid damaging the product, use only accessories recommended by Olympus.**Water and Moisture** — For precautions on products with weatherproof designs, read the weatherproofing sections.**Location** — To avoid damage to the product, mount the product securely on a stable tripod, stand, or bracket.**Power Source** — Connect this product only to the power source described on the product label.**Foreign Objects** — To avoid personal injury, never insert a metal object into the product.**Heat** — Never use or store this product near any heat source such as a radiator, heat register, stove, or any type of equipment or appliance that generates heat, including stereo amplifiers. DANGER

## Handling the Battery

Follow these important guidelines to prevent batteries from leaking, overheating, burning, exploding, or causing electrical shocks or burns.

- The camera uses a lithium ion battery specified by Olympus. Charge the battery with the specified charger. Do not use any other chargers.
- Never incinerate or heat batteries in microwaves, on hot plates, or in pressure vessels, etc.
- Never leave the camera on or near electromagnetic devices. This may cause overheating, burning, or exploding.
- Do not connect terminals with any metallic objects.

- Take precautions when carrying or storing batteries to prevent them from coming into contact with any metal objects such as jewelry, pins, fasteners, keys, etc. The short circuit may cause overheating, exploding, or burning, which burn or damage you.
- Never store batteries where they will be exposed to direct sunlight, or subjected to high temperatures in a hot vehicle, near a heat source, etc.
- To prevent causing battery leaks or damaging their terminals, carefully follow all instructions regarding the use of batteries. Never attempt to disassemble a battery or modify it in any way, solder, etc.
- If battery fluid gets into your eyes, flush your eyes immediately with clear, cold running water and seek medical attention immediately.
- If you cannot remove the battery from the camera, contact an authorized distributor or service center. Do not try to remove the battery by force. Damage to the battery exterior (scratches, etc.) may produce heat or an explosion.
- Always store batteries out of the reach of small children and pets. If they accidentally swallow a battery, seek medical attention immediately.

## WARNING

### Handling the Camera

- **Do not use the camera near flammable or explosive gases.**
- **Do not use or store the camera in dusty or humid places.**
- **Do not use the flash and LED (including AF illuminator) on people (infants, small children, etc.) at close range.**
  - You must be at least 1 m (3 ft.) away from the faces of your subjects. Firing the flash too close to the subject's eyes could cause a momentary loss of vision.
- **Do not look at the sun or strong lights with the camera.**
- **Keep young children, infants away from the camera.**
  - Always use and store the camera out of the reach of young children and infants to prevent the following dangerous situations which could cause serious injury:
    - Becoming entangled in the camera strap, causing strangulation.
    - Accidentally swallowing the battery, cards or other small parts.
    - Accidentally firing the flash into their own eyes or those of another child.

- Accidentally being injured by the moving parts of the camera.

- **Use SD/SDHC/SDXC memory cards or Eye-Fi cards only. Never use other types of cards.**

If you accidentally insert another type of card into the camera, contact an authorized distributor or service center. Do not try to remove the card by force.

- **Should you notice that the charger is emitting smoke, heat, or an unusual noise or smell, immediately cease use and unplug the charger from the power outlet, and then contact an authorized distributor or service center.**
- **Do not cover the flash with a hand while firing.**

### Handling the Battery

- Keep batteries dry at all times.
- To prevent batteries from leaking, overheating, or causing a fire or explosion, use only batteries recommended for use with this product.
- Insert the battery carefully as described in the operating instructions.
- If rechargeable batteries have not been recharged within the specified time, stop charging them and do not use them.
- Do not use batteries with scratches or damage to the casing, and do not scratch the battery.
- Never subject batteries to strong shocks or continuous vibration by dropping or hitting. This may cause exploding, overheating, or burning.
- If a battery leaks, has unusual odor, becomes discolored or deformed, or becomes abnormal in any other way during operation, stop using the camera, and keep away from fire immediately.
- If a battery leaks fluid onto your clothing or skin, remove the clothing and flush the affected area with clean, running cold water immediately. If the fluid burns your skin, seek medical attention immediately.

### Using the wireless LAN function

- **Turn off the camera in hospitals and other locations where medical equipment is present.** The radio waves from the camera may adversely affect medical equipment, causing a malfunction that results in an accident.
- **Turn off the camera when onboard aircraft.** Using wireless devices onboard may hinder safe operation of the aircraft.

## CAUTION

### Handling the Camera

- **Stop using the camera immediately if you notice any unusual odors, noise, or smoke around it.**
  - Never remove the batteries with bare hands, which may cause a fire or burn your hands.
- Never hold or operate the camera with wet hands.

This may cause overheating, exploding, burning, electrical shocks, or malfunctions.
- Be careful with the strap when you carry the camera. It could easily catch on stray objects and cause serious damage.
- **Do not leave the camera in places where it may be subject to extremely high temperatures.**
  - Doing so may cause parts to deteriorate and, in some circumstances, cause the camera to catch fire. Do not use the charger if it is covered (such as a blanket). This could cause overheating, resulting in fire.
- **Handle the camera with care to avoid getting a low temperature burn.**
  - When the camera contains metal parts, overheating can result in a low-temperature burn. Pay attention to the following:
    - When used for a long period, the camera will get hot. If you hold on to the camera in this state, a low-temperature burn may be caused.
    - In places subject to extremely cold temperatures, the temperature of the camera's body may be lower than the environmental temperature. If possible, wear gloves when handling the camera in cold temperatures.
- To protect the high-precision technology contained in this product, never leave the camera in the places listed below, no matter if in use or storage:
  - Places where temperatures and/or humidity are high or go through extreme changes. Direct sunlight, beaches, locked cars, or near other heat sources (stove, radiator, etc.) or humidifiers.
  - In sandy or dusty environments.
  - Near flammable items or explosives.
  - In wet places, such as bathrooms or in the rain. When using products with weatherproof designs, read their manuals as well.
  - In places prone to strong vibrations.

- Never drop the camera or subject it to severe shocks or vibrations.
- When attaching the camera to or removing it from a tripod, rotate the tripod screw, not the camera.
- Before transporting the camera, remove a tripod and all other non-OLYMPUS accessories.
- Do not touch electric contacts on cameras.
- Do not leave the camera pointed directly at the sun. This may cause lens or shutter curtain damage, color failure, ghosting on the image pickup device, or may possibly cause fires.
- Do not leave the viewfinder exposed to a strong light source or direct sunlight. The heat may damage the viewfinder.
- Do not push or pull severely on the lens.
- Before storing the camera for a long period, remove the batteries. Select a cool, dry location for storage to prevent condensation or mold from forming inside the camera. After storage, test the camera by turning it on and pressing the shutter button to make sure that it is operating normally.
- The camera may malfunction if it is used in a location where it is subject to a magnetic/ electromagnetic field, radio waves, or high voltage, such as near a TV set, microwave, video game, loud speakers, large monitor unit, TV/radio tower, or transmission towers. In such cases, turn the camera off and on again before further operation.
- Always observe the operating environment restrictions described in the camera's manual.

### Handling the Battery

- Before loading, always inspect the battery carefully for leaks, discoloration, warping, or any other abnormality.
- The battery may become hot during prolonged use. To avoid minor burns, do not remove it immediately after using the camera.
- Always unload the battery from the camera before storing the camera for a long period.
- When storing the battery for a long period, select a cool location for storage.
- This camera uses one Olympus lithium ion battery. Use the specified genuine battery. There is a risk of explosion if the battery is replaced with the incorrect battery type.
- Power consumption by the camera varies depending on which functions are used. During the conditions described below, power is consumed continuously and the battery becomes exhausted quickly.
  - The zoom is used repeatedly.

- The shutter button is pressed halfway repeatedly in shooting mode, activating the auto focus.
  - A picture is displayed on the monitor for an extended period of time.
  - The camera is connected to a printer.
  - Using an exhausted battery may cause the camera to turn off without displaying the battery level warning.
  - The Olympus lithium ion battery is designed to be used only for the Olympus digital camera. Do not use the battery to other devices.
  - If the battery's terminals get wet or greasy, camera contact failure may result. Wipe the battery well with a dry cloth before use.
  - Always charge a battery when using it for the first time, or if it has not been used for a long period.
  - When operating the camera with battery power at low temperatures, try to keep the camera and spare battery as warm as possible. A battery that has run down at low temperatures may be restored after it is warmed at room temperature.
  - Before going on a long trip, and especially before traveling abroad, purchase extra batteries. A recommended battery may be difficult to obtain while traveling.
  - Please recycle batteries to help save our planet's resources. When you throw away dead batteries, be sure to cover their terminals and always observe local laws and regulations.
  - **Do not allow children or animals/pets to handle or transport batteries (prevent dangerous behaviour such as licking, putting in mouth or chewing).**
- A strip of light may appear on the top/bottom of the monitor, but this is not a malfunction.
  - When a subject is viewed diagonally in the camera, the edges may appear zigzagged on the monitor. This is not a malfunction; it will be less noticeable in playback mode.
  - In places subject to low temperatures, the monitor may take a long time to turn on or its color may change temporarily. When using the camera in extremely cold places, it is a good idea to occasionally place it in a warm place. The monitor exhibiting poor performance due to low temperatures will recover in normal temperatures.
  - The monitor of this product is manufactured with high-quality accuracy, however, there may be a stuck or dead pixel on the monitor. These pixels do not have any influence on the image to be saved. Because of the characteristics, the unevenness of the color or brightness may also be found depending on the angle, but this is due to the structure of the monitor. This is not a malfunction.

## Legal and Other Notices

- Olympus makes no representations or warranties regarding any damages, or benefit expected by using this unit lawfully, or any request from a third person, which are caused by the inappropriate use of this product.
- Olympus makes no representations or warranties regarding any damages or any benefit expected by using this unit lawfully which are caused by erasing picture data.

## Disclaimer of Warranty

- Olympus makes no representations or warranties, either expressed or implied, by or concerning any content of these written materials or software, and in no event shall be liable for any implied warranty of merchantability or fitness for any particular purpose or for any consequential, incidental or indirect damages (including but not limited to damages for loss of business profits, business interruption and loss of business information) arising from the use or inability to use these written materials or software or equipment. Some countries do not allow the exclusion or limitation of liability for consequential or incidental damages or of the implied warranty, so the above limitations may not apply to you.
- Olympus reserves all rights to this manual.

## Use Only Dedicated Rechargeable Battery and Battery Charger

We strongly recommend that you use only the genuine Olympus dedicated rechargeable battery and battery charger with this camera.

Using a non-genuine rechargeable battery and/or battery charger may result in fire or personal injury due to leakage, heating, ignition or damage to the battery. Olympus does not assume any liability for accidents or damage that may result from the use of a battery and/or battery charger that are not genuine Olympus accessories.

## Monitor

- Do not push the monitor forcibly; otherwise the image may become vague, resulting in a playback mode failure or damage to the monitor.

## Warning

Unauthorized photographing or use of copyrighted material may violate applicable copyright laws. Olympus assumes no responsibility for unauthorized photographing, use or other acts that infringe upon the rights of copyright owners.

## Copyright Notice

All rights reserved. No part of these written materials or this software may be reproduced or used in any form or by any means, electronic or mechanical, including photocopying and recording or the use of any type of information storage and retrieval system, without the prior written permission of Olympus. No liability is assumed with respect to the use of the information contained in these written materials or software, or for damages resulting from the use of the information contained therein. Olympus reserves the right to alter the features and contents of this publication or software without obligation or advance notice.

## FCC Notice

This equipment has been tested and found to comply with the limits for a Class B digital device, pursuant to part 15 of the FCC Rules. These limits are designed to provide reasonable protection against harmful interference in a residential installation. This equipment generates, uses and can radiate radio frequency energy and, if not installed and used in accordance with the instructions, may cause harmful interference to radio communications. However, there is no guarantee that interference will not occur in a particular installation. If this equipment does cause harmful interference to radio or television reception, which can be determined by turning the equipment off and on, the user is encouraged to try to correct the interference by one or more of the following measures:

- Reorient or relocate the receiving antenna.
- Increase the separation between the equipment and receiver.
- Connect the equipment into an outlet on a circuit different from that to which the receiver is connected.
- Consult the dealer or an experienced radio/TV technician for help.
- Only the OLYMPUS-supplied USB cable should be used to connect the camera to USB enabled personal computers.

## FCC Caution

Changes or modifications not expressly approved by the party responsible for compliance could void the user's authority to operate the equipment.

This transmitter must not be co-located or operated in conjunction with any other antenna or transmitter.

This equipment complies with FCC/IC radiation exposure limits set forth for an uncontrolled environment and meets the FCC radio frequency (RF) Exposure Guidelines in Supplement C to OET65 and RSS-102 of the IC radio frequency (RF) Exposure rules. This equipment has very low levels of RF energy that are deemed to comply without testing of specific absorption ratio (SAR).

## For customers in North America, Central America, South America and the Caribbean

### Declaration of Conformity

Model Number : E-M5II  
Trade Name : OLYMPUS  
Responsible Party : **OLYMPUS IMAGING AMERICA INC.**  
Address : 3500 Corporate Parkway, P. O. Box 610, Center Valley, PA 18034-0610, USA  
Telephone Number : 484-896-5000  
Tested To Comply With FCC Standards  
FOR HOME OR OFFICE USE

This device complies with Part 15 of FCC Rules and Industry Canada licence-exempt RSS standard(s). Operation is subject to the following two conditions:

- (1) This device may not cause harmful interference.
- (2) This device must accept any interference received, including interference that may cause undesired operation.

This Class B digital apparatus complies with Canadian ICES-003. CAN ICES-3(B)/NMB-3(B)

### OLYMPUS AMERICAS LIMITED WARRANTY - OLYMPUS IMAGING AMERICA INC. PRODUCTS

Olympus warrants that the enclosed Olympus® imaging product(s) and related Olympus® accessories (individually a "Product" and collectively the "Products") will be free from defects in materials and workmanship under normal use and service for a period of one (1) year from the date of purchase.

If any Product proves to be defective within the one-year warranty period, the customer must return the defective Product to the authorized Olympus Repair Service Center designated by Olympus, following the procedure set forth below (See "WHAT TO DO WHEN SERVICE IS NEEDED").

Olympus, at its sole discretion, will repair, replace, or adjust the defective Product at Olympus's cost, provided that an Olympus investigation and factory inspection disclose that (a) such defect developed under normal and proper use and (b) the Product is covered under this limited warranty.

Repair, replacement, or adjustment of defective Products shall be Olympus's sole obligation and the customer's sole remedy hereunder. Repair or replacement of a Product shall not extend the warranty period provided herein, unless required by law.

Except where prohibited by law, the customer is liable and shall pay for shipment of the Products to the designated Olympus Repair Service Center. Olympus shall not be obligated to perform preventive maintenance, installation, deinstallation, or maintenance.

Olympus reserves the right to (i) use reconditioned, refurbished, and/or serviceable used parts (that meet Olympus's quality assurance standards) for warranty or any other

repairs and (ii) make any internal or external design and/or feature changes on or to its products without any liability to incorporate such changes on or to the Products.

### WHAT IS NOT COVERED BY THIS LIMITED WARRANTY

Excluded from this limited warranty and not warranted by Olympus in any fashion, either express, implied, or by statute, are:

- (a) products and accessories not manufactured by Olympus and/or not bearing the "OLYMPUS" brand label (the warranty coverage for products and accessories of other manufacturers, which may be distributed by Olympus, is the responsibility of the respective manufacturer of such products and accessories in accordance with the terms and duration of such manufacturers' warranties);
- (b) any Product which has been disassembled, repaired, tampered with, altered, changed, or modified by persons other than Olympus's own authorized service personnel unless repair by others is made with the written consent of Olympus;
- (c) defects or damage to the Products resulting from wear, tear, misuse, abuse, negligence, sand, liquids, impact, improper storage, nonperformance of scheduled operator and maintenance items, battery leakage, use of non-"OLYMPUS" brand accessories, consumables, or supplies, or use of the Products in combination with non-compatible devices;
- (d) software programs;
- (e) supplies and consumables (including but not limited to lamps, ink, paper, film, prints, negatives, cables and batteries); and/or

- (f) Products which do not contain a validly placed and recorded Olympus serial number, unless they are a model on which Olympus does not place and record serial numbers.
- (g) Products shipped, delivered, purchased, or sold from dealers located outside of North America, Central America, South America and the Caribbean; and/or
- (h) Products that are not intended or authorized to be sold in North America, South America, Central America, or the Caribbean (ie. Gray Market Goods).

WARRANTY DISCLAIMER; LIMITATION OF DAMAGES; AFFIRMATION OF ENTIRE WARRANTY AGREEMENT; INTENDED BENEFICIALLY

EXCEPT FOR THE LIMITED WARRANTY SET FORTH ABOVE, OLYMPUS MAKES NO AND DISCLAIMS ALL OTHER REPRESENTATIONS, GUARANTIES, CONDITIONS, AND WARRANTIES CONCERNING THE PRODUCTS, WHETHER DIRECT OR INDIRECT, EXPRESS OR IMPLIED, OR ARISING UNDER ANY STATUTE, ORDINANCE, COMMERCIAL USAGE OR OTHERWISE, INCLUDING BUT NOT LIMITED TO ANY WARRANTY OR REPRESENTATION AS TO THE SUITABILITY, DURABILITY, DESIGN, OPERATION, OR CONDITION OF THE PRODUCTS (OR ANY PART THEREOF) OR THE MERCHANTABILITY OF THE PRODUCTS OR THEIR FITNESS FOR A PARTICULAR PURPOSE, OR RELATING TO THE INFRINGEMENT OF ANY PATENT, COPYRIGHT, OR OTHER PROPRIETARY RIGHT USED OR INCLUDED THEREIN.

IF ANY IMPLIED WARRANTIES APPLY AS A MATTER OF LAW, THEY ARE LIMITED IN DURATION TO THE LENGTH OF THIS LIMITED WARRANTY.

SOME STATES MAY NOT RECOGNIZE A DISCLAIMER OR LIMITATION OF WARRANTIES AND/OR LIMITATION OF LIABILITY SO THE ABOVE DISCLAIMERS AND EXCLUSIONS MAY NOT APPLY.

THE CUSTOMER MAY ALSO HAVE DIFFERENT AND/OR ADDITIONAL RIGHTS AND REMEDIES THAT VARY FROM STATE TO STATE.

THE CUSTOMER ACKNOWLEDGES AND AGREES THAT OLYMPUS SHALL NOT BE RESPONSIBLE FOR ANY DAMAGES THAT THE CUSTOMER MAY INCUR FROM DELAYED SHIPMENT, PRODUCT FAILURE, PRODUCT DESIGN, SELECTION, OR PRODUCTION, IMAGE OR DATA LOSS OR IMPAIRMENT OR FROM ANY OTHER CAUSE, WHETHER LIABILITY IS ASSERTED IN CONTRACT, TORT (INCLUDING NEGLIGENCE AND STRICT

PRODUCT LIABILITY) OR OTHERWISE. IN NO EVENT SHALL OLYMPUS BE LIABLE FOR ANY INDIRECT, INCIDENTAL, CONSEQUENTIAL OR SPECIAL DAMAGES OF ANY KIND (INCLUDING WITHOUT LIMITATION LOSS OF PROFITS OR LOSS OF USE), WHETHER OR NOT OLYMPUS SHALL BE OR SHOULD BE AWARE OF THE POSSIBILITY OF SUCH POTENTIAL LOSS OR DAMAGE.

Representations and warranties made by any person, including but not limited to dealers, representatives, salespersons, or agents of Olympus, which are inconsistent or in conflict with or in addition to the terms of this limited warranty, shall not be binding upon Olympus unless reduced to writing and approved by an expressly authorized officer of Olympus.

This limited warranty is the complete and exclusive statement of warranty which Olympus agrees to provide with respect to the Products and it shall supersede all prior and contemporaneous oral or written agreements, understandings, proposals, and communications pertaining to the subject matter hereof.

This limited warranty is exclusively for the benefit of the original customer and cannot be transferred or assigned.

#### WHAT TO DO WHEN SERVICE IS NEEDED

The customer must contact the designated Olympus Consumer Support Team for your region to coordinate the submission of your Product for repair service. To contact your Olympus Consumer Support Team in your region please visit or call the following:

Canada:

[www.olympuscanada.com/repair](http://www.olympuscanada.com/repair) /  
1-800-622-6372

United States:

[www.olympusamerica.com/repair](http://www.olympusamerica.com/repair) /  
1-800-622-6372

Latin America:

[www.olympusamericalatina.com](http://www.olympusamericalatina.com)

The customer must copy or transfer any image or other data saved on a Product to another image or data storage medium prior to sending the Product to Olympus for repair service.

IN NO EVENT SHALL OLYMPUS BE RESPONSIBLE FOR SAVING, KEEPING OR MAINTAINING ANY IMAGE OR DATA SAVED ON A PRODUCT RECEIVED BY IT FOR SERVICE, OR ON ANY FILM CONTAINED WITHIN A PRODUCT RECEIVED BY IT FOR SERVICE, NOR SHALL OLYMPUS BE RESPONSIBLE FOR ANY DAMAGES IN THE EVENT ANY IMAGE OR DATA IS LOST OR IMPAIRED WHILE SERVICE IS BEING PERFORMED (INCLUDING, WITHOUT



LIMITATION, DIRECT, INDIRECT, INCIDENTAL, CONSEQUENTIAL OR SPECIAL DAMAGES, LOSS OF PROFITS OR LOSS OF USE), WHETHER OR NOT OLYMPUS SHALL BE OR SHOULD BE AWARE OF THE POSSIBILITY OF SUCH POTENTIAL LOSS OR IMPAIRMENT.

The customer should package the Product carefully using ample padding material to prevent damage in transit. Once the Product is properly packaged, ship the package to Olympus or the Olympus Authorized Repair Service Center location as instructed by the respective Olympus Consumer Support Team.

When sending Products for repair service, your package should include the following:

- 1) Sales receipt showing date and place of purchase. Handwritten receipts will not be accepted;
- 2) Copy of this limited warranty **bearing the Product serial number corresponding to the serial number on the Product** (unless it is a model on which Olympus does not place and record serial numbers);
- 3) A detailed description of the problem; and
- 4) Sample prints, negatives, digital prints (or files on disk) if available and related to the problem.

**KEEP COPIES OF ALL DOCUMENTS.** Neither Olympus nor an Olympus Authorized Repair Service Center will be responsible for documents that are lost or destroyed in transit.

When service is completed, the Product will be returned to you postage prepaid.

#### PRIVACY

Any information provided by you to process your warranty claim shall be kept confidential and will only be used and disclosed for the purposes of processing and performing warranty repair services.

## For customers in Europe



"CE" mark indicates that this product complies with the European requirements for safety, health, environment and customer protection. "CE" mark cameras are intended for sales in Europe.

Hereby, Olympus Imaging Corp. and Olympus Europa SE & Co. KG declare that this E-M5II is in compliance with the essential requirements and other relevant provisions of Directive 1999/5/EC.

For details visit: <http://www.olympus-europa.com/>

This symbol [crossed-out wheeled bin WEEE Annex IV] indicates separate collection of waste electrical and electronic equipment in the EU countries.

Please do not throw the equipment into the domestic refuse.

Please use the return and collection systems available in your country for the disposal of this product.

This symbol [crossed-out wheeled bin Directive 2006/66/EC Annex II] indicates separate collection of waste batteries in the EU countries.

Please do not throw the batteries into the domestic refuse.

Please use the return and collection systems available in your country for the disposal of the waste batteries.



## Provisions of warranty

In the unlikely event that your product proves to be defective, although it has been used properly (in accordance with the written Instruction Manual supplied with it), during the applicable national warranty period and has been purchased from an authorized Olympus distributor within the business area of OLYMPUS EUROPA SE & Co. KG as stipulated on the website: <http://www.olympus-europa.com>, it will be repaired, or at Olympus's option replaced, free of charge. In order to enable Olympus to provide you with the requested warranty services to your full satisfaction and as fast as possible, please note the information and instructions listed below:

1. To claim under this warranty please follow the instructions on <http://consumer-service.olympus-europa.com> for registration and tracking (this service is not available in all countries) or take the product, the corresponding original invoice or purchase receipt and the completed Warranty Certificate to the dealer where it was purchased or any other Olympus service station within the business area of OLYMPUS EUROPA SE & Co. KG as stipulated on the website: <http://www.olympus-europa.com>, before the end of the applicable national warranty period.
2. Please make sure your Warranty Certificate is duly completed by Olympus or an authorized dealer or Service center. Therefore, please make sure that your name, the name of the dealer, the serial number and the year, month and date of purchase are all completed or the original invoice or the sales receipt (indicating the dealer's name, the date of purchase and product type) is attached to your Warranty Certificate.
3. Since this Warranty Certificate will not be re-issued, keep it in a safe place.
4. Please note that Olympus will not assume any risks or bear any costs incurred in transporting the product to the dealer or Olympus authorized service station.
5. This Warranty does not cover the following and you will be required to pay a repair charge, even for defects occurring within the warranty period referred to above.
  - a. Any defect that occurs due to mishandling (such as an operation performed that is not mentioned in the Instruction Manual, etc.)
  - b. Any defect that occurs due to repair, modification, cleaning, etc. performed by anyone other than Olympus or an Olympus authorized service station.

- c. Any defect or damage that occurs due to transport, a fall, shock, etc. after purchase of the product.
  - d. Any defect or damage that occurs due to fire, earthquake, flood damage, thunderbolt, other natural disasters, environmental pollution and irregular voltage sources.
  - e. Any defect that occurs due to careless or improper storage (such as keeping the product under conditions of high temperature and humidity, near insect repellents such as naphthalene or harmful drugs, etc.), improper maintenance, etc.
  - f. Any defect that occurs due to exhausted batteries, etc.
  - g. Any defect that occurs due to sand, mud, water etc. entering the inside of the product casing.
6. Olympus's sole liability under this Warranty shall be limited to repairing or replacing the product. Any liability under the Warranty for indirect or consequential loss or damage of any kind incurred or suffered by the customer due to a defect of the product, and in particular any loss or damage caused to any lenses, films, other equipment or accessories used with the product or for any loss resulting from a delay in repair or loss of data, is excluded. Compelling regulations by law remain unaffected by this.

## For customers in Thailand

This telecommunication equipment conforms to NTC technical requirement.

## For customers in Mexico

The operation of this equipment is subject to the following two conditions:

- (1) it is possible that this equipment or device may not cause harmful interference, and (2) this equipment or device must accept any interference, including interference that may cause undesired operation.

## For customer in Singapore

Complies with IDA Standards DB104634
--

## Trademarks

- Microsoft and Windows are registered trademarks of Microsoft Corporation.
- Macintosh is a trademark of Apple Inc.
- SDXC Logo is a trademark of SD-3C, LLC.
- Eye-Fi is a trademark of Eye-Fi, Inc.
- "Shadow Adjustment Technology" function contains patented technologies from Apical Limited.
- Micro Four Thirds, Four Thirds, and the Micro Four Thirds and Four Thirds logos are trademarks or registered trademarks of the OLYMPUS IMAGING Corporation in Japan, the United States, the countries of the European Union, and other countries.
- Wi-Fi is a registered trademark of the Wi-Fi Alliance.
- The Wi-Fi CERTIFIED logo is a certification mark of the Wi-Fi Alliance.
- The standards for camera file systems referred to in this manual are the "Design Rule for Camera File System/DCF" standards stipulated by the Japan Electronics and Information Technology Industries Association (JEITA).
- All other company and product names are registered trademarks and/or trademarks of their respective owners.



THIS PRODUCT IS LICENSED UNDER THE AVC PATENT PORTFOLIO LICENSE FOR THE PERSONAL AND NONCOMMERCIAL USE OF A CONSUMER TO (i) ENCODE VIDEO IN COMPLIANCE WITH THE AVC STANDARD ("AVC VIDEO") AND/OR (ii) DECODE AVC VIDEO THAT WAS ENCODED BY A CONSUMER ENGAGED IN A PERSONAL AND NON-COMMERCIAL ACTIVITY AND/OR WAS OBTAINED FROM A VIDEO PROVIDER LICENSED TO PROVIDE AVC VIDEO. NO LICENSE IS GRANTED OR SHALL BE IMPLIED FOR ANY OTHER USE. ADDITIONAL INFORMATION MAY BE OBTAINED FROM MPEG LA, L.L.C. SEE [HTTP://WWW.MPEGLA.COM](http://www.MPEGLA.COM)

The software in this camera may include third party software. Any third party software is subject to the terms and conditions, imposed by the owners or licensors of that software, under which software is provided to you.

Those terms and other third party software notices, if any, may be found in the software notice PDF file stored within the accompanying CD-ROM or at

<http://www.olympus.co.jp/en/support/imsig/digicamera/download/notice/notice.cfm>

## Symbols

RC Mode.....	141
.....	99
Menu Display .....	99
Set Home .....	100
(Face Priority AF).....	49, 100
H fps.....	101
L fps .....	101
/Info Settings .....	102
Control Settings.....	102
Preview lock.....	103
Slow Limit.....	105
X-Sync. ....	105, 115
+ .....	105, 115
+WB .....	106
Warning Level .....	109
/.....	67
(Index display).....	79
(Close-up playback) .....	79
Mode.....	107
(Single-frame erase).....	81
(Picture selection).....	82
(Protecting).....	81
Keep Warm Color .....	106
(Image rotation).....	96
Set .....	105
(Beep sound) .....	103
(Audio recording).....	82
(Monitor brightness adjustment).....	99
(Slideshow).....	80
Image Stabilization.....	101
.....	103

## A

<b>A</b> (Aperture-priority mode).....	35
AdobeRGB .....	106
AEL/AFL .....	110
AEL Metering .....	104
AE Lock .....	19, 67, 110
AF Area ().....	48
AF Illuminat.(AF illuminator) .....	100

AF Mode .....	51, 100
AF Tracking .....	51
All  .....	105
Anti-Shock .....	95
ART (Art filter).....	23, 30
Art Effects .....	31
Art Fade.....	40
Art Filter .....	30
Art LV Mode.....	102
Aspect ratio.....	60
Audio Recording.....	82, 98
Auto Focus Sound (Beep sound) .....	103

## B

Backlit LCD.....	103
Battery level.....	17
BKT (Bracketing) .....	90
Black and White (Monotone) .....	70
Grainy Film .....	30
Bracketing.....	90
BULB .....	37
Bulb Photography .....	37
Bulb/Time Focusing.....	100
Bulb/Time Monitor .....	104
Bulb/Time Timer .....	104
Button Function .....	101

## C

C-AF .....	51
C-AF+TR .....	51
Calendar display.....	115
Calendar Display .....	79, 83, 115
Card.....	14, 132
Card Setup .....	85
Charging .....	13
Close-up playback.....	79
Color Creator .....	52
Color Space.....	106
Composite Photography.....	38
Composite Settings .....	104
Compression .....	133

Connection to Smartphone.....	119
Continuous AF.....	51
Copyright Settings.....	107
Custom Menu (⌘).....	100

## D

Date/time setting (🕒).....	18
Dial Direction.....	101
Dial Function.....	101
Digital Tele-converter.....	67, 88
Displayed Grid.....	102
Display Interval.....	19
During Playback.....	76
While Shooting.....	19
dpi Settings.....	106

## E

Edit Filename.....	106
Editing Still Images.....	96
Electronic Zoom Speed.....	110
Erase.....	81
All Erase.....	85
Erase.....	81
Erase Selected.....	82
EV Step.....	104
Exposure Compensation.....	47
Exposure Shift.....	109
Eye-Fi.....	109

## F

Face Priority AF.....	49, 100
File Name.....	106
Firmware.....	99
Flash Compensation.....	66
Flash intensity control (🔆).....	66
Flicker reduction.....	103
Focus Mode (AF mode).....	51
Focus Ring.....	100
Format (Card setup).....	85
Full-time AF.....	100

## H

Half Way RIs With IS.....	101
HDMI.....	102
HDR.....	53

High Dynamic Range (HDR).....	53
Highlight&Shadow Control.....	52
High Res Shot.....	60
Histogram Display.....	22
Histogram Settings.....	102

## I

iAUTO (iAUTO).....	23, 26, 39
Image Aspect.....	60
Image Overlay.....	98
Image Size.....	133
Movie.....	62
Still image.....	61
Image Stabilizer.....	57
Index Display.....	79, 83, 115
INFO button.....	22, 48, 52, 77
Info Settings (📄/Info Settings).....	102
ISO.....	54, 104
ISO-Auto.....	104
ISO-Auto Set.....	104
ISO sensitivity.....	54
ISO Step.....	104

## J

JPEG Edit.....	97
----------------	----

## K

Keystone Comp.....	94
--------------------	----

## L

Lens I.S. Priority.....	101
Level Adjust.....	109
Level Gauge.....	22
Light Box.....	114
Live Bulb.....	104
Live Composite Photography.....	38
Live Control.....	40
Live Guide.....	26, 67
Live Time.....	104
LIVE TIME.....	37
Live View Boost.....	102
Location Information.....	121
Long Time Exposure (BULB/TIME).....	37
LV super control panel.....	45, 113

<b>M</b>	
<b>M</b> (Manual mode).....	37
Manual Focus (MF) .....	51, 136
Menu Display (☰ Menu Display).....	99
Metering.....	54
MF .....	67
MF Assist.....	100, 111
MF (Manual focus).....	51, 136
Mode Dial Function.....	101
Mode Guide .....	102
Movie  .....	74, 107
Movie Effect .....	40
Movie+Photo Mode .....	41
Movie Tele-converter .....	41
Multi Echo.....	40
Multi Function .....	68
Multiple Exposure.....	93
My Clips.....	42
Myset.....	86
<b>N</b>	
Noise Filter .....	104
Noise Reduct .....	104
<b>O</b>	
One Shot Echo .....	40
<b>P</b>	
<b>P</b> (Program mode) .....	34
Panning .....	28
Panorama.....	29
Peaking Settings.....	103
PHOTO STORY.....	32
Picture Mode .....	70, 87
Picture Mode Settings .....	102
Pixel Count .....	105
Pixel Mapping .....	151
Playback.....	78
Movie Playback.....	78, 81
Still Image Playback .....	78, 79
Playback Menu .....	96
Preview.....	67
Preview Lock .....	103
Print .....	127

Print reservation  .....	129
Priority Set.....	106
Program shift ( <b>Ps</b> ).....	34
Pupil Detection AF.....	49

## Q

Quick Erase .....	106
Quick motion movies .....	44

## R

RAW .....	61
RAW Data Edit .....	96
RAW+JPEG Erase .....	106
RC Mode (  RC Mode).....	141
Recording Volume .....	107
Rec View .....	99
Registration .....	125
Release Lag-Time .....	101
Reset .....	86
Reset Lens .....	100
Reset Protect.....	98
RIs Priority C/S .....	101
Rotate.....	79

## S

<b>S</b> (shutter-priority mode) .....	36
S-AF .....	51
S-AF+MF .....	51
Scene Mode .....	28
SCN (Scene mode) .....	23, 28
SD card.....	132
Format SD card .....	85
Self Timer .....	58
Sequential shooting.....	58
Set Home (  Set Home).....	100
Setup Menu .....	99
Shading Comp.....	105
Share Order.....	82
Shooting .....	23
Movie Recording.....	40
Shooting Photography .....	23
Shooting Menu .....	85
Single AF .....	51
Sleep .....	17, 103

Slideshow .....	80
Slow motion movies.....	44
Slow Synchronization .....	64
Small Target (Small AF target).....	48
sRGB .....	106
Storage .....	124
Super Spot AF (Zoom frame AF).....	50

## **T**

---

Test Picture.....	67
Time Lapse Movie .....	89
Time Lapse Shooting.....	89
Time Photography .....	37
Touch AF.....	25
Touch Screen Settings.....	109
TV .....	112

## **U**

---

USB Mode .....	103
----------------	-----

## **V**

---

Video Out.....	102
Volume Adjustment.....	80

## **W**

---

WB.....	55, 105
Wi-Fi settings.....	122
Wind Noise Reduction .....	107
Wireless LAN.....	122
Wireless Remote Control Flash.....	141

## **Z**

---

Zoom frame AF.....	50
--------------------	----

## **OLYMPUS KOREA CO., LTD.**

10F, Olympus Tower A, 114-9, Samsung-dong, Gangnam-gu, Seoul, Korea. 135-090  
<http://www.olympus.co.kr> Tel. 1544-3200

## **OLYMPUS (MALAYSIA) Sdn Bhd**

10-8, Menara 1 MK, Kompleks '1 Mont Kiara', No.1, Jalan Kiara, Mont Kiara, 50480  
Kuala Lumpur, Malaysia.

Tel:+603-6411 0000/Fax:+603-6411 0003

E-mail: [service.oml@olympus-ap.com](mailto:service.oml@olympus-ap.com)

### **BRANCHES:**

#### **PENANG OFFICE**

Suite 3A-6, Level 3A, Wisma Great Eastern

No.25, Lebuh Light, 10200 Penang

Tel:+604 262 2832/ Fax:+604 262 5832

<http://www.olympus.com.my>

## **OLYMPUS (Thailand) CO., LTD.**

23/112 Sorachai Building ,27th Floor,Soi Sukhumvit 63 (Ekamai)

Sukhumvit road Klongton Nua,Wattana , Bangkok 10110 Thailand

Tel: 662 787 8200



## OLYMPUS IMAGING AMERICA INC.

3500 Corporate Parkway, P.O. Box 610, Center Valley, PA 18034-0610, U.S.A. Tel. 484-896-5000

### Technical Support (U.S.A. / Canada)

24/7 online automated help:  
<http://www.olympusamerica.com/support>  
Phone customer support:  
Tel. 1-800-260-1625 (Toll-free)

Our phone customer support is available from  
9 am to 9 pm (Monday to Friday) ET  
<http://olympusamerica.com/contactus>  
Olympus software updates can be obtained at:  
<http://www.olympusamerica.com/digital>

## OLYMPUS EUROPA SE & CO. KG

Premises: Consumer Product Division  
Wendenstrasse 14-18, 20097  
Hamburg, Germany

Tel: +49 40-23 77 3-0 / Fax: +49 40-23 07 61

Goods delivery: Modul H, Willi-Bleicher Str. 36,  
52353 Düren, Germany

Letters: Postfach 10 49 08, 20034 Hamburg,  
Germany

### European Technical Customer Support:

Please visit our homepage <http://www.olympus-europa.com> or call our TOLL FREE NUMBER\* :  
**00800 - 67 10 83 00**

for Austria, Belgium, Czech Republic, Denmark, Finland, France, Germany, Luxembourg,  
Netherlands, Norway, Poland, Portugal, Russia, Spain, Sweden, Switzerland, United Kingdom.  
\* Please note some (mobile) phone services / provider do not permit access or request an  
additional prefix to +800 numbers.

For all not listed European Countries and in case that you can't get connected to the above mentioned number,  
please make use of the following CHARGED NUMBERS **+49 40 - 237 73 899**

## OLYMPUS (CHINA) CO., LTD.

Customer Support: 400-650-0303 Homepage: <http://www.olympus-imaging.cn>

### Customer Service Center:

A8F, Ping An International Financial Center, No. 1-3,  
Xinyuan South Road, Chaoyang District, Beijing  
Zip: 100027

Rm.1605-1608, Guangzhou International Electronic tower,  
No403, Huan Shi East Road, Guang Zhou  
Zip: 510095

Unit A301, Mingyuan Business Center,  
No.1199 Middle Fuxing Road, Shanghai  
Zip: 200031

## OLYMPUS HONG KONG AND CHINA LIMITED

Digital Camera Repair Centre

L4207, Office Tower, Langham Place, 8 Argyle Street, Mongkok, Kowloon, Hong Kong

Customer Hotline: +852-2376-2150 Fax: +852-2375-0630

E-mail: [cs@olympus-ap.com](mailto:cs@olympus-ap.com)  
<http://www.olympus.com.hk>