

Dell UltraSharp 32 6K Monitor -U3224KB

User's Guide

Model: U3224KB
Regulatory model: U3224KBt





NOTE: A NOTE indicates important information that helps you make better use of your computer.



CAUTION: A CAUTION indicates potential damage to hardware or loss of data if instructions are not followed.



WARNING: A WARNING indicates a potential for property damage, personal injury, or death.

Copyright © 2023 Dell Inc. or its subsidiaries. All rights reserved. Dell, EMC, and other trademarks are trademarks of Dell Inc. or its subsidiaries. Other trademarks may be trademarks of their respective owners.

2023 – 05

Rev. A00

Contents

Safety instructions	6
About your monitor	7
Package contents	7
Product features	8
Identifying parts and controls	10
Front view	10
Back view	12
Bottom view	13
Monitor specifications	15
Resolution specifications	17
Preset display modes	18
Thunderbolt™ 4 out for daisy chain	19
Unified Communications (UC) Platform Compatibility List	20
Electrical specifications	21
Webcam – microphone specifications	22
Speaker Specifications	22
Physical characteristics	22
Environmental characteristics	24
Video Bandwidth	25
Pin assignments	27
Plug-and-Play capability	34
LCD monitor quality and pixel policy	34
Ergonomics	35
Handling and moving your display	36
Maintenance guidelines	38
Cleaning your monitor	38



Setting up the monitor	39
Attaching the stand	39
Using the tilt, swivel, and vertical extension	42
Tilt, swivel, and vertical extension.	42
Rotating the Display	43
Organizing your cables	44
Connecting your monitor	45
Dell Power Button Sync (DPBS)	51
Connecting the monitor for DPBS for the first time	54
Using DPBS function.	55
Connecting the monitor for Thunderbolt™ daisy chain function.	57
Connecting the monitor for Thunderbolt™ 4	58
Operating the monitor webcam	60
Dell Peripheral Manager	61
Securing your monitor using Kensington lock (optional)	62
Removing the monitor stand	63
Wall mounting (Optional)	64
Operating the monitor	65
Power on the monitor	65
Using the joystick control	65
Using the rear-panel controls	67
Front-panel button	68
Using the Main Menu	69
Using the OSD lock function	86
Initial Setup.	89
OSD warning messages	90
Setting the maximum resolution.	93
Setting up Windows Hello	94
Setting up the monitor webcam as default setting.	98
Setting up the monitor speaker as default setting	103



Troubleshooting 106
 Self-test 106
 Built-in diagnostics 107
 Common Problems. 108
 Product specific problems 113
 Microsoft® Teams® / Skype for Business® specific problems . 121
 Universal Serial Bus (USB) specific problems 122

Appendix. 123
 FCC notices (U.S. only) and other regulatory information. . . 123
 Contacting Dell 123



Safety instructions

Use the following safety guidelines to protect you monitor from potential damage and to ensure your personal safety. Unless otherwise noted, each procedure included in this document assumes that you have read the safety information that shipped with your monitor.

 **NOTE: Before using the monitor, read the safety information that is shipped with your monitor and printed on the product. Keep the documentation at a secure location for future reference.**

 **WARNING: Use of controls, adjustments, or procedures other than those specified in this documentation may result in exposure to shock, electrical hazards, and/or mechanical hazards.**

 **WARNING: The possible long-term effect of listening to audio at high volume through the headphones (on monitor that support it) may cause damage to your hearing ability.**

- Place the monitor on a solid surface and handle it carefully. The screen is fragile and can be damaged if dropped or hit with a sharp object.
- Ensure that your monitor is electrically rated to operate with the AC power available in your location.
- Keep the monitor in room temperature. Excessive cold or hot conditions can have an adverse effect on the liquid crystals of the display.
- Connect the power cable from the monitor to a wall outlet that is near and accessible. See [Connecting your monitor](#).
- Do not place and use the monitor on a wet surface or near water.
- Do not subject the monitor to severe vibration or high impact conditions. For example, do not place the monitor inside a car trunk.
- Unplug the monitor when it is going to be left unused for an extended period.
- To avoid electric shock, do not attempt to remove any cover or touch the inside of the monitor.
- Read these instructions carefully. Keep this document for future reference. Follow all warnings and instructions marked on the product.
- Certain monitors can be wall mounted using the VESA mount that is sold separately. Ensure to use the correct VESA specifications as mentioned in the wall mounting section of the User's Guide.

For information on safety instructions, see the Safety, Environmental, and Regulatory Information (SERI) document that is shipped with your monitor.







About your monitor



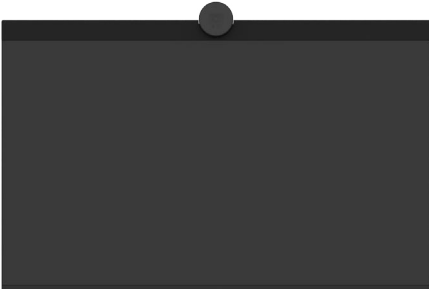

Package contents

The following table provides the list of components that are shipped with your monitor. If any component is missing, contact Dell. For more information, see [Contact Dell](#).

 **NOTE: Some items may be optional and may not ship with your monitor. Some features may not be available in certain countries.**

Component image	Component description
	Display
	Stand riser
	Stand base
	Power cable (varies by country)



	DisplayPort cable (mDP to mDP)
	USB 3.2 Gen2 Type-A to Type-C upstream cable
	Thunderbolt™ 4 cable
	<ul style="list-style-type: none"> • Quick Setup Guide • Safety, Environmental, and Regulatory Information • Factory Calibration Report

Product features

The **Dell UltraSharp U3224KB** monitor has an active matrix, Thin-Film Transistor (TFT), Liquid Crystal Display (LCD), and LED backlight. The monitor features include:

- 79.94 cm (31.5 in.) active area display (Measured diagonally) 6144 x 3456 (16:9) resolution, plus full-screen support for lower resolutions.
- Wide viewing angles with 100% sRGB color, 99% DCI-P3, 100% Rec.709 & 99% Display P3.
- Tilt, swivel, pivot, and vertical extension adjustment capabilities.
- Built-in speakers (2 x 14 W).
- Removable pedestal stand and Video Electronics Standards Association (VESA™) 100 mm mounting holes for flexible mounting solutions.
- Ultra-thin bezel minimizes the bezel gap during multi-monitor usage, enabling easier set up with an elegant viewing experience.
- Extensive digital connectivity with DP helps future-proof your monitor.
- Thunderbolt™ 4 to supply power to compatible notebook while receiving video signal.
- Thunderbolt™ 4 and RJ45 ports enable a single-cable, network-connected experience.
- Plug and play capability if supported by your computer.
- On-Screen Display (OSD) adjustments for ease of set-up and screen optimization.



- Power and OSD buttons lock.
- Security lock slot.
- Stand lock.
- Power consumption $\leq 0.26W$ in Standby Mode.
- Supports Picture by Picture (PBP) and Picture in Picture (PIP) Select mode.
- Allow user to switch USB KVM function in PBP/PIP mode.
- The monitor is designed with Dell Power Button Sync (DPBS) feature to control PC system power state from monitor power button.
- Premium Panel Exchange for peace of mind.
- Optimize eye comfort with a flicker-free screen and ComfortView Plus feature.
- This monitor uses low blue light panel. When the monitor is reset to factory settings or default setting (**Preset mode: Standard**), it works in compliance with TUV Rheinland (hardware solutions provider).
- Decreases the level of hazard blue light emitted from the screen to make viewing more comfortable for your eyes.
- The monitor adopts Flicker-Free technology, which clears the eye visible flicker, brings comfort viewing experience and preventing users suffer from eye strain and fatigue.
- Certified for Windows Hello® (Face Authentication) and supports Microsoft Cortana®.
- Additional customization using Dell Peripheral Manager.

⚠ WARNING: The possible long-term effects of blue light emission from the monitor may cause damage to the eyes, which includes but is not limited to eye fatigue and digital eyestrain. ComfortView Plus feature is designed to reduce the amount of blue light emitted from the monitor to optimize eye comfort.



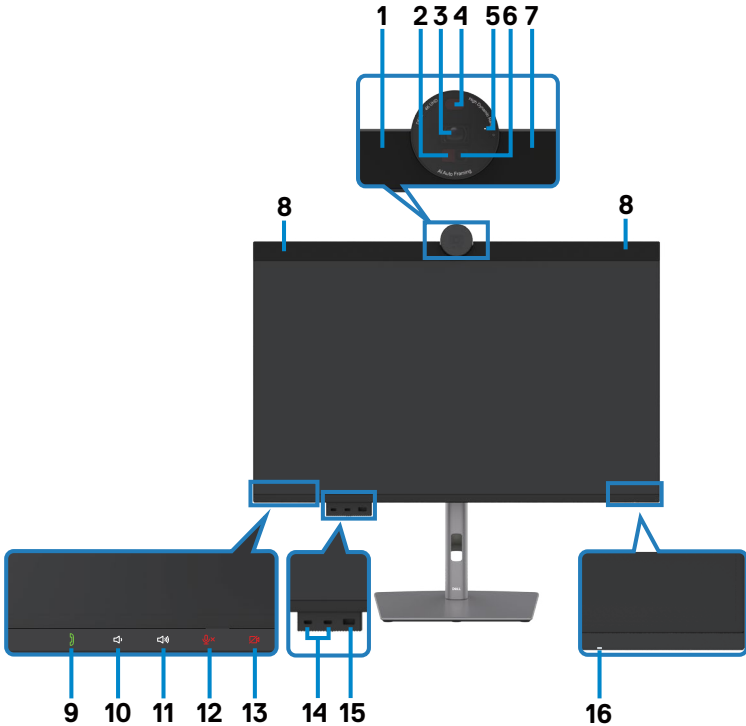

Identifying parts and controls

Front view



Label	Description	Use
1,7	Microphones	Monitor microphones (Mic).
2	IR LED	Indicator of infrared (IR).
3	RGB Camera	Transmits your image in a video conference.
4	Proximity Sensor	The human presence wake & lock feature.
5	Webcam LED indicator	Indicator of Webcam. It will light up in white when webcam is in use.
6	IR Camera	The face recognition feature.
8	Built-in speakers	To output the sound from audio input.



9	Hookswitch & LED	LED will blink in green when there is an incoming Teams/Skype for Business (SfB) call. LED will light up in static green during Teams/Skype for Business (SfB) call. Short press to answer / end call. Long press to reject incoming call.
10	Volume down & LED	Short press for 2 unit volume decrement. Long press for continuous volume decrement.
11	Volume up & LED	Short press for 2 unit volume increment. Long press for continuous volume increment.
12	Microphone mute & LED	Press to mute and unmute microphone. LED will light up in static red when mic is muted. LED will go dark when mic is enabled/unmuted.
13	Camera Mute & LED	Press to lock and unlock camera shutter. If locked, icon will light up in red, no software can override and open camera shutter to use the camera. If unlocked, icon will not light up, software can open camera shutter to use the camera when it's needed. NOTE: This camera disable button must not be confused with "Webcam and presence sensor: enable / disable" in OSD. Disabling "webcam & presence sensor" will turn off the whole webcam module, webcam and sensor will not appear in the system.
14	USB Type-C downstream port (USB 3.2 Gen2)	Port with  icon supports 5 V/3 A. Connect your USB device. You can use these ports only after you have connected the USB cable (Type-A to Type-C or Thunderbolt™ 4) from the computer to the monitor. NOTE: This port is downstream only and unable to broadcast video or sound to the display or speakers.
15	Super speed USB 10 Gbps (USB 3.2 Gen2)	Connect your USB device. You can use these ports only after you have connected the USB cable from the computer to the monitor.  Port 15 with  battery icon supports Battery Charging Rev. 1.2.
16	Power LED indicator	Solid white light indicates the monitor is turned on and functioning normally. Breathing white light indicates the monitor is in Standby Mode.



Back view



Label	Description	Use
1	VESA mounting holes (100 mm x 100 mm-behind attached VESA cover)	Wall mount monitor using VESA-compatible wall mount kit (100 mm x 100 mm).
2	Regulatory label	Lists the regulatory approvals.
3	Stand release button	Releases stand from the monitor.
4	Power On/Off button	To turn the monitor on or off.
5	Joystick	Use it to control the OSD menu. For more information, see Operating the Monitor .
6	Mac address, Barcode, serial number, and Service Tag label	Refer to this label if you need to contact Dell for technical support. The Service Tag is a unique alphanumeric identifier that enables Dell service technicians to identify the hardware components in your computer and access warranty information.
7	Cable-management slot	Use to organize cables by inserting them through the slot.



Bottom view

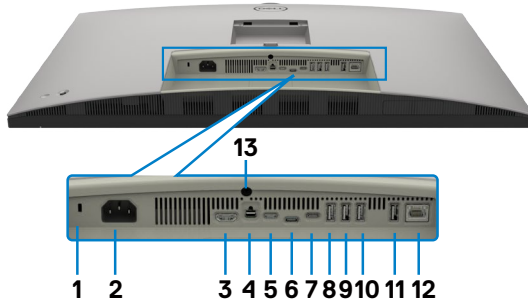

Label	Description	Use
1	Security lock slot (based on Kensington Security Slot™)	Secures monitor with security cable lock (sold separately)
2	Power connector	Connect the power cable.
3	HDMI port	Connect your computer with the HDMI cable.
4	mDP	Connect your computer with the mDP to mDP cable.
5	Thunderbolt™ 4 downstream	Thunderbolt™ 4 downstream port only suitable for video output under Daisy chain, Connecting the monitor for TBT daisy chain. NOTE: 1) Thunderbolt™ 4 up to 40Gbs bandwidth; 2) Supports up to two 6K monitors through the Daisy chain; 3) The highest power output up to 15W; 4) USB-C downstream port supports 5V/3A.
6	USB-C upstream port	Connect the USB cable that comes with your monitor to the computer. Once this cable is connected, you can use the USB downstream connectors on the monitor.



7	Thunderbolt™ 4 upstream	<p>Connect to your computer using the Thunderbolt™ cable. The Thunderbolt™ 4 upstream offer the fastest transfer rate (USB 4 40Gbps), TBT mode and the alternate mode with DP 1.4 support the following, and PD 28 V/5 A, 20V/4.5A, 15 V/3 A, 9 V/3 A, 5 V/3 A.</p> <p>Maximum resolution of 6144 x 3456 at 60 Hz (DSC)</p> <p>The Thunderbolt™ 4 upstream power is more than 100W, the connected equipment and accessory cables should have fire enclosure of V1 level or higher and VW-1 rating wire.</p> <p>This model will feature Thunderbolt™ 4.0 technology and will have a 140W power delivery, it is recommended for use the following Dell's products that meet the fire enclosures.</p> <p>NOTE: Thunderbolt™ 4 upstream is not supported on Windows versions that are prior to Windows 10.</p>
8,9, 10,11	Super speed USB 10 Gbps (USB 3.2 Gen2)	Connect your USB device. You can use these ports only after you have connected the USB cable from the computer to the monitor.
12	RJ-45 connector (2.5G)	Connect Internet. You can surf Internet via RJ45 only after you have connected the USB cable (Type-A to Type-C or Thunderbolt™ 4) from the computer to the monitor.
13	Stand lock	Lock the stand to the monitor using a M3 x 8 mm screw (screw not included).



Monitor specifications

Screen type	Active matrix - TFT LCD
Panel Type	In-plane switching Technology
Aspect ratio	16:9
Viewable image dimensions	
Diagonal	79.94 cm (31.5 in.)
Active Area	
Horizontal	696.73 mm (27.43 in.)
Vertical	391.91 mm (15.43 in.)
Area	273,055.45 mm ² (423.24 in. ²)
Pixel pitch	0.1134(H) mm x 0.1134(V) mm
Pixel per inch (PPI)	223
Viewing angle	
Horizontal	178° (typical)
Vertical	178° (typical)
Brightness	450 cm/m ² (typical)
Contrast ratio	2000 to 1 (typical)
Display screen coating	Anti-glare treatment of the front polarizer (3H) hard coating
Backlight	LED
Response Time (Gray to Gray)	5 ms (Fast mode) 8 ms (Normal mode)
Color depth ¹	1.07 billion colors
Color gamut ²	sRGB 100% Rec. 709 100% DCI-P3 99% Display-P3 99%



Connectivity	<ul style="list-style-type: none"> · 1 x Mini DP 2.0 (HDCP 2.2)(Supports up to 6K 6144 x 3456 60Hz 10bit, HDR) · 1 x HDMI (HDCP 2.2)(Supports up to 6K 6144 x 3456 60Hz 10bit FRL, HDR as per specified in HDMI 2.1) · 1 x Thunderbolt™ 4 upstream (EPR PD 140W) with DSC (Alternate mode with DisplayPort 1.4/1.2, USB 3.2 Gen 2 upstream port, Power Delivery up to 140 W) · 1 x Thunderbolt™ 4 downstream (15W) for video output under Daisy chain · 1 x USB Type-C (USB 3.2 Gen 2 upstream port) · 4 x super speed USB 10 Gbps (USB 3.2 Gen 2) · 1 x RJ45 (2.5G) <p>Quick Access:</p> <ul style="list-style-type: none"> · 1 x USB-A (USB3.2 Gen 2 10 Gbps) with BC1.2 · 2 x USB Type-C downstream (15 W), USB 3.2 Gen 2 (10 Gbps)
Border width (edge of monitor to active area)	
Top	42.93 mm
Left/Right	10.35 mm
Bottom	23.05 mm
Adjustability	
Stand	
Height	160 mm
Tilt	-5° to 21°
Swivel	-30° to 30°
Pivot	-90° to 90°
Slant	NA
Camera	
Tilt	-20° to 0°
Cable management	Yes
Dell Display Manager (DDM) Compatibility	Easy Arrange and other key features
Security	Security lock slot (cable lock sold separately)



¹ Video output from mDP/HDMI port at maximum resolution 6144 x 3456 at 60Hz is 1.07 billion colors. Video output from Thunderbolt™ 4 upstream at maximum resolution 6144 x 3456 at 60Hz is 1.07 billion colors with DSC.

² At panel native only, under Color Space preset.

Resolution specifications

Horizontal scan range	30 kHz to 220 kHz
Vertical scan range	56 Hz to 76 Hz
Maximum preset resolution	6144 x 3456 at 60 Hz
Video display capabilities (HDMI & mDP & Thunderbolt™ 4 alternate mode)	480p, 576p, 720p, 1080i (HDMI only), 1080p, 2160p



Preset display modes

Display mode	Horizontal frequency (kHz)	Vertical frequency (Hz)	Pixel clock (MHz)	Sync polarity (Horizontal/Vertical)
VESA, 720 x 400	31.47	70	28.32	-/+
VESA, 640 x 480	31.47	60	25.17	-/-
VESA, 640 x 480	37.50	75	31.5	-/-
VESA, 800 x 600	37.88	60	40	+/+
VESA, 800 x 600	46.88	75	49.5	+/+
VESA, 1024 x 768	48.36	60	65	-/-
VESA, 1024 x 768	60.02	75	78.75	+/+
VESA, 1152 x 864	67.50	75	108	+/+
VESA, 1280 x 1024	64.0	60	108	+/+
VESA, 1280 x 1024	80.0	75	135	+/+
VESA, 1600 x 900	55.99	60	118.25	+/+
VESA, 1920 x 1080	67.50	60	148.50	+/+
CVR, 2560 x 1440	88.79	60	241.50	+/+
VESA, 3840 x 2160	133.31	60	533.25	+/-
VESA, 3840 x 2160	135.00	60	594	+/-
VESA, 1280 x 800	49.306	59.91	71	+/+
VESA, 1680 x 1050	64.674	59.883	119	+/+
VESA, 1920 x 1200	74.038	59.95	154	+/+
VESA, 1600 x 1200	75	60	162	+/+
VESA, 3840 x 2160	54	24	297	+/-
VESA, 3840 x 2160	56.25	25	297	+/-
VESA, 3840 x 2160	65.68	30	297	+/-
CVT, 5120 x 2880	177.71	60	952.5	+/-
CVT, 6016 x 3384	208.85	60	1323.25	+/-
CVT, 6144 x 3456	105.14	30	662.75	+/-
CVT, 6144 x 3456	213	60	1378.75	+/-



Thunderbolt™ 4 out for daisy chain

OSD Display Info:	Maximum external monitor resolution that can be supported
Link rate(current)	6144 x 3456 at 60 Hz

 **NOTE: Maximum external monitor resolution with the maximum number of external monitors supported is 6144 x 3456 at 60Hz only when DSC is enabled on graphic cards or with graphic cards that support DSC.**



Unified Communications (UC) Platform Compatibility List

The table below highlights the call functions that work on the Dell Video Conferencing Monitor – U3224KB when using the following UC platforms#.

Call Functions	Answer call	End call	Reject call	Adjust Speaker volume down	Adjust Speaker volume up	Mute/Unmute Microphone
Button	Hookswitch	Hookswitch	Hookswitch	Volume Down	Volume Up	Mute
Microsoft Teams	√	√	√	√	√	√
Skype for Business	√	√	√	√	√	√
Zoom	x	x	x	√	√	√*
Google Hangouts	x	x	x	√	√	√*
BlueJeans	x	x	x	√	√	√*
Cisco Webex	x	x	x	√	√	√*
FaceTime	x	x	x	√	√	√*
Slack	x	x	x	√	√	√*
GoTo Meeting	x	x	x	√	√	√*
Google Meet	x	x	x	√	√	√*
Lifesize	x	x	x	√	√	√*
Discord	x	x	x	√	√	√*
Ring Central	x	x	x	√	√	√*

√ Call function on the Dell U3224KB works with the UC platform

x Call function on the Dell U3224KB does not work with the UC platform

* Mute function on the Dell U3224KB works by pressing the Mute button, but the Mute Icon on the UC platform is not sync (Icon shows unmute).

On Windows 10 64 Bit OS



Electrical specifications

Video input signals	<ul style="list-style-type: none"> • Digital video signal for each differential line Per differential line at 100 ohm impedance • mDP/HDMI/Thunderbolt™ 4 signal input support
Input voltage/ frequency/ current	100-240 VAC / 50 or 60 Hz ± 3 Hz / 4.6 A (maximum)
Inrush current	120 V: 42 A (Max.) 240 V: 80 A (Max.) Inrush current is measured at an ambient temperature of 0°C
Power Consumption	0.25 W (Off Mode) ¹ 0.26 W (Standby Mode) ¹ 3.1 W (Networked standby Mode) ¹ 56.73 W (On Mode) ¹ 420 W (Max) ² 54.86 W (P _{on}) ³ 185.85 kWh (TEC) ³

¹As defined in EU 2019/2021 and EU 2019/2013.

²Max brightness and contrast setting with maximum power loading on all USB ports.

³P_{on}: Power consumption of On Mode as defined in Energy Star 8.0 version.

TEC: Total energy consumption in kWh as defined in Energy star 8.0 version.

This document is informational only and reflects laboratory performance. Your product may perform differently, depending on the software, components, and peripherals you ordered and shall have no obligation to update such information. Accordingly, the customer should not rely upon this information in making decisions about electrical tolerances or otherwise. No warranty as to accuracy or completeness is expressed or implied.

 **NOTE:** This monitor is ENERGY STAR certified.



This product qualifies for ENERGY STAR in the factory default settings which can be restored by “Factory Reset” function in the OSD menu. Changing the factory default settings or enabling other features may increase power consumption that could exceed the ENERGY STAR specified limit.



Webcam – microphone specifications

Lens	Field of view (horizontal)	65 / 78 / 90 degree
	Focus mode	5x digital zoom
	Focus area	25 cm ~ ∞
	Focusing distance	500 cm
Image Sensor	Active array size	8 mega-pixel
Video Specification	Video frame rate	3840 x 2160 (4K UHD)- up to 30 frames per second
		1920 x 1080 (Full HD)- up to 60 frames per second
Audio Specification	Microphone type	Digital microphone x 2

Speaker Specifications

Speaker rated power	2 x 14 W
Frequency Response	100 Hz - 20 kHz
Impedance	4 ohm

Physical characteristics

Connector type	<ul style="list-style-type: none"> · mDP connector · HDMI connector · RJ45 connector · Thunderbolt™ 4 upstream connector · Thunderbolt™ 4 downstream connector · USB Type-C upstream connector · USB 3.2 Gen 2 downstream connector x 5 · USB Type-C downstream connector x 2
Signal cable type	mDP to mDP 1M cable USB 3.2 Gen 2 Type-A to C 1M cable Thunderbolt™ 4 1.5M cable
Dimensions (with stand)	
Height (extended)	682.63 mm (26.88 in.)
Height (compressed)	522.63 mm (20.58 in.)



Width	717.42 mm (28.24 in.)
Depth	237 mm (9.33 in.)
Dimensions (without stand)	
Height	486.64 mm (19.16 in.)
Width	717.42 mm (28.24 in.)
Depth	66.29 mm (2.61 in.)
Stand dimensions	
Height (extended)	483.30 mm (19.03 in.)
Height (compressed)	436.50 mm (17.19 in.)
Width	316.00 mm (12.44 in.)
Depth	237.00 mm (9.33 in.)
Weight	
Weight with packaging	17.70 kg (39.02 lb)
Weight with stand assembly and cables	13.30 kg (29.32 lb)
Weight without stand assembly (For wall mount or VESA mount considerations - no cables)	8.61 kg (18.98 lb)
Weight of stand assembly	4.38 kg (9.66 lb)



Environmental characteristics

Compliant Standards	
<ul style="list-style-type: none">• ENERGY STAR certified Monitor.• EPEAT registered where applicable. EPEAT registration varies by country. See https://www.epeat.net for registration status by country.• TCO Certified & TCO Certified Edge.• RoHS Compliant.• BFR/PVC Free monitor (excluding external cables).• Meets NFPA 99 leakage current requirements.• Arsenic-Free glass and Mercury-Free for the panel only.	
Temperature	
Operating	0°C to 40°C (32°F to 104°F)
Non-operating	-20°C to 60°C (-4°F to 140°F)
Humidity	
Operating	10% to 80% (non-condensing)
Non-operating	5% to 90% (non-condensing)
Altitude	
Operating	5,000 m (16,404 ft) (maximum)
Non-operating	12,192 m (40,000 ft) (maximum)
Thermal dissipation	1433.10 BTU/hour (maximum) 193.57 BTU/hour (on mode)



Video Bandwidth

Host	Video Cable	Monitor 1 Resolution	Monitor 2 Resolution	USB Speed
USB-C (Alt Mode DP1.2)	Thunderbolt™ 4 Active Cable (40G)	3840 x 2160 @ 60Hz	Not supported	Support USB 2.0
USB-C (Alt Mode DP1.4)	Thunderbolt™ 4 Active Cable (40G)	6144 x 3456 @ 30Hz	Not supported	Support USB 2.0
USB-C (Alt Mode DP1.4, DSC Enabled)	Thunderbolt™ 4 Active Cable (40G)	6144 x 3456 @ 60Hz	Not supported	Support USB 2.0
TBT3 (Alt Mode DP1.2)	Thunderbolt™ 4 Active Cable (40G)	3840 x 2160 @ 60Hz	Not connected	Support USB 2.0/USB 3.0 Gen2
		3840 x 2160 @ 60Hz	3840 x 2160 @ 60Hz	Support USB 2.0/USB 3.0 Gen2
TBT4 (Alt Mode DP1.4 DSC Enabled)	Thunderbolt™ 4 Active Cable (40G)	6144 x 3456 @ 60 Hz	Not connected	Support USB 2.0/USB 3.0 Gen2
		6144 x 3456 @ 60 Hz	6144 x 3456 @ 60 Hz	Support USB 2.0/USB 3.0 Gen2



Host	Video Cable	Monitor 1 Resolution	Monitor 2 Resolution	USB Speed
mDP 2.0 (DSC Enable)	mDP to mDP (UHBR 13.5G)	6144 x 3456 @ 60 Hz	Not supported	Support USB 2.0/USB 3.0 Gen2 (USB A - C cable connected)
	mDP to DP (HBR3, 8.1G)	6144 x 3456 @ 60 Hz	Not supported	
mDP 2.0 (DSC Disable)	mDP to mDP (UHBR 13.5G)	6144 x 3456 @ 60 Hz	Not supported	
	mDP to DP (HBR3, 8.1G)	6144 x 3456 @ 30 Hz	Not supported	
DP 2.0	DP to mDP	6144 x 3456 @ 60 Hz	Not supported	
HDMI 2.1	HDMI 2.1 cable	6144 x 3456 @ 60 Hz	Not supported	
	HDMI 2.0 cable	3840 x 2160 @ 60Hz	Not supported	
HDMI 2.0	HDMI 2.1 cable	3840 x 2160 @ 60Hz	Not supported	
	HDMI 2.0 cable	3840 x 2160 @ 60Hz	Not supported	

 **NOTE: Require to set Display setting to Second Screen only.**

 **NOTE: This table show that the max resolution which can reach.**



Pin assignments

Mini DP port

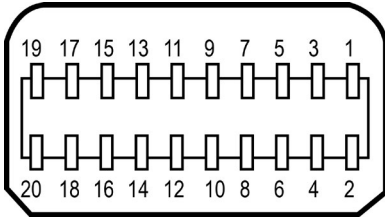

Pin number	20-pin side of the connected signal cable
1	GND
2	Hot Plug Detect
3	ML3 (n)
4	CONFIG1
5	ML3 (p)
6	CONFIG2
7	GND
8	GND
9	ML2 (n)
10	ML0 (p)
11	ML2 (p)
12	ML0 (p)
13	GND
14	GND
15	ML1 (n)
16	AUX (p)
17	ML1 (p)
18	AUX (n)
19	GND
20	DP_PWR



HDMI port

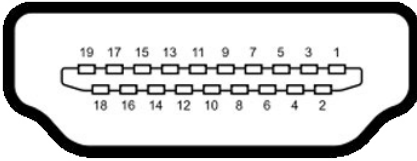

Pin number	19-pin side of the connected signal cable
1	TMDS DATA 2+
2	TMDS DATA 2 SHIELD
3	TMDS DATA 2-
4	TMDS DATA 1+
5	TMDS DATA 1 SHIELD
6	TMDS DATA 1-
7	TMDS DATA 0+
8	TMDS DATA 0 SHIELD
9	TMDS DATA 0-
10	TMDS CLOCK+
11	TMDS CLOCK SHIELD
12	TMDS CLOCK-
13	CEC
14	Reserved (N.C. on device)
15	DDC CLOCK (SCL)
16	DDC DATA (SDA)
17	DDC/CEC Ground
18	+5 V POWER
19	HOT PLUG DETECT



Thunderbolt™ 4/USB Type-C port

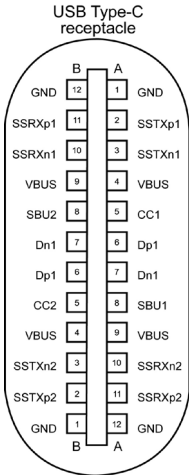



typically connected to a charger through a Type-C cable

Pin	Signal	Pin	Signal
A1	GND	B12	GND
A2	SSTXp1	B11	SSRXp1
A3	SSTXn1	B10	SSRXn1
A4	VBUS	B9	VBUS
A5	CC1	B8	SBU2
A6	Dp1	B7	Dn1
A7	Dn1	B6	Dp1
A8	SBU1	B5	CC2
A9	VBUS	B4	VBUS
A10	SSRXn2	B3	SSTXn2
A11	SSRXp2	B2	SSTXp2
A12	GND	B1	GND





Universal Serial Bus (USB)

This section gives you information about the USB ports available on your monitor.

 **NOTE: Up to 2 A on USB downstream port (port with  battery icon) with BC 1.2 compliance devices; up to 0.9 A on the other 4 USB downstream ports; Up to 3 A on USB-C downstream port (port with  icon) with 5 V/3 A compliance devices.**

Your computer has the following USB ports:

- 2 upstream - 1*TBT + 1*USB-C at rear.
- 8 downstream - 2*USB-C + 1*USB-A at bottom, 1*TBT + 4*USB-A at rear.

Power Charging Port - the ports with  battery icon supports fast current charging capability if the device is BC 1.2 compatible. The USB Type-C downstream port with  icon supports fast current charging capability if the device is 5V/3A compatible.

 **NOTE: The monitor's USB ports work only when the monitor is on or in Standby Mode. On in Standby Mode, if the USB cable (A to C or C to C) is plugged in, the USB ports can work normally. Otherwise, follow the OSD setting of Other USB Charging, if the setting is "On in Standby Mode" then USB work normally, otherwise USB is disabled. If you turn off the monitor and then turn it on, the attached peripherals may take a few seconds to resume normal functionality.**

Super speed USB 10 Gbps (USB 3.2 Gen2) device

Transfer speed	Data rate	Maximum power consumption (each port)
Super speed+	10 Gbps	4.5 W
Super speed	5 Gbps	4.5 W
Hi-speed	480 Mbps	2.5 W
Full speed	12 Mbps	2.5 W



USB 3.2 Gen2 (10Gbps)
downstream port (Bottom)

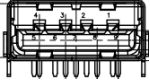

Pin number	Signal name
1	VBUS
2	D-
3	D+
4	GND
5	StdA_SSRX-
6	StdA_SSRX+
7	GND_DRAIN
8	StdA_SSTX-
9	StdA_SSTX+
Shell	Shield

USB 3.2 Gen2 (10Gbps)
downstream port (Rear)

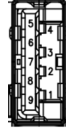

Pin number	Signal name
1	VBUS
2	D-
3	D+
4	GND
5	StdA_SSRX-
6	StdA_SSRX+
7	GND_DRAIN
8	StdA_SSTX-
9	StdA_SSTX+
Shell	Shield



RJ45 Port (Connector Side)

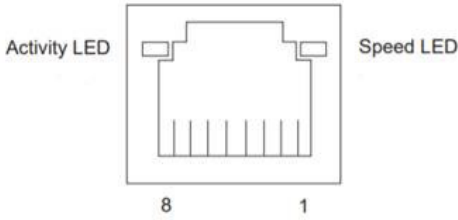

Pin No.	10BASE-T 100BASE-T	1000BASE-T
1	Transmit+	BI_DA+
2	Transmit-	BI_DA-
3	Receive+	BI_DB+
4	Unused	BI_DC+
5	Unused	BI_DC-
6	Receive-	BI_DB-
7	Unused	BI_DD+
8	Unused	BI_DD-

Driver installation

Install the Realtek USB GBE Ethernet Controller Driver available for your system. This is available for download at <https://www.dell.com/support> under the “Driver and download” section.

Network (RJ45) data rate via USB-C max speed is 2.5Gbps.

NOTE: This LAN port is 2.5GBase-T IEEE 802.3az compliant, supporting Mac Address (Printed on model label) Pass-thru (MAPT), Wake-on-LAN (WOL) from standby mode and UEFI PXE Boot function [UEFI PXE Boot is not supported on Dell Desktop PC’s (except for OptiPlex 7090/3090 Ultra Desktop)], these 3 features depend on BIOS settings and version of the OS. Functionality may vary with Non Dell PC’s.



RJ45 Connector LED status:

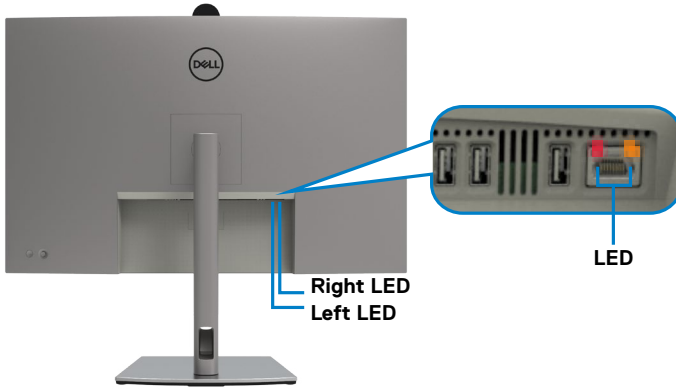

LED	Color	Description
Right LED	Amber or Green	Speed indicator: <ul style="list-style-type: none">• Amber On - 1000 Mbps/2.5 Gbps• Green On - 100 Mbps• Off - 10 Mbps
Left LED	Green	Link / Activity indicator: <ul style="list-style-type: none">• Blinking - Activity on the port.• Green On - Link is being established.• Off - Link is not established.

 **NOTE: RJ45 cable is not a standard in-box accessory.**



Plug-and-Play capability

You can connect the monitor to any Plug and Play-compatible system. The monitor automatically provides the computer with its Extended Display Identification Data (EDID) using Display Data Channel (DDC) protocols so that the computer can configure itself and optimize the monitor settings. Most monitor installations are automatic; you can select different settings as required. For more information about changing the monitor settings, see [Operating the Monitor](#).

LCD monitor quality and pixel policy

During the LCD Monitor manufacturing process, it is not uncommon for one or more pixels to become fixed in an unchanging state which are hard to see and do not affect the display quality or usability. For more information on Dell Monitor Quality and Pixel Policy, see <https://www.dell.com/pixelguidelines>.



Ergonomics

△ CAUTION: Improper or prolonged usage of keyboard may result in injury.

△ CAUTION: Viewing the monitor screen for extended periods of time may result in eye strain.

For comfort and efficiency, observe the following guidelines when setting up and using your computer workstation:

- Position your computer so that the monitor and keyboard are directly in front of you as you work. Special shelves are commercially available to help you correctly position your keyboard.
- To reduce the risk of eye strain and neck/arm/back/shoulder pain from using the monitor for long periods of time, we suggest you to:
 1. Set the distance of the screen between 20 to 28 in. (50 - 70 cm) from your eyes.
 2. Blink frequently to moisten your eyes or wet your eyes with water after prolonged usage of the monitor.
 3. Take regular and frequent breaks for 20 minutes every two hours.
 4. Look away from your monitor and gaze at a distant object at 20 feet away for at least 20 seconds during the breaks.
 5. Perform stretches to relieve tension in the neck, arm, back, and shoulders during the breaks.
- Make sure that the monitor screen is at eye level or slightly lower when you are sitting in front of the monitor.
- Adjust the tilt of the monitor, its contrast, and brightness settings.
- Adjust the ambient lighting around you (such as overhead lights, desk lamps, and the curtains or blinds on nearby windows) to minimize reflections and glare on the monitor screen.
- Use a chair that provides good lower-back support.
- Keep your forearms horizontal with your wrists in a neutral, comfortable position while using the keyboard or mouse.
- Always leave space to rest your hands while using the keyboard or mouse.
- Let your upper arms rest naturally on both sides.
- Ensure that your feet are resting flat on the floor.
- When sitting, make sure that the weight of your legs is on your feet and not on the front portion of your seat. Adjust your chair's height or use a footrest if necessary to maintain a proper posture.
- Vary your work activities. Try to organize your work so that you do not have to sit and work for extended periods of time. Try to stand or get up and walk around at regular intervals.
-



- Keep the area under your desk clear of obstructions and cables or power cords that may interfere with comfortable seating or present a potential trip hazard.

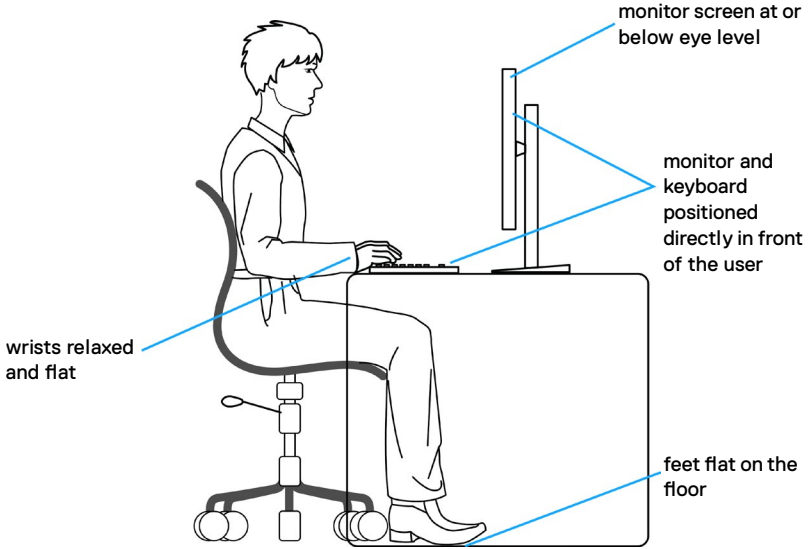

Handling and moving your display

To ensure the monitor is handled safely when lifting or moving it, follow the guidelines mentioned below:

- Before moving or lifting the monitor, turn off your computer and the monitor.
- Disconnect all cables from the monitor.
- Place the monitor in the original box with the original packing materials.
- Hold the bottom edge and the side of the monitor firmly without applying excessive pressure when lifting or moving the monitor.

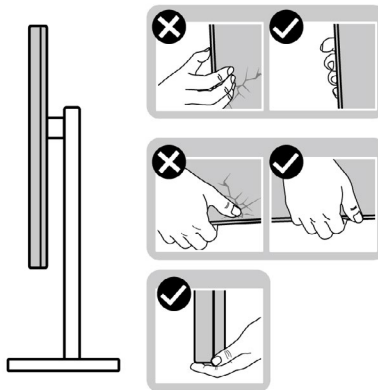

- When lifting or moving the monitor, ensure the screen is facing away from you and do not press on the display area to avoid any scratches or damage.

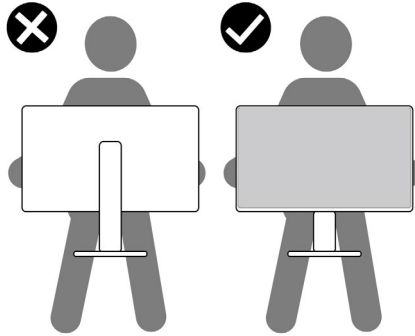

- When transporting the monitor, avoid any sudden shock or vibration to it.
- When lifting or moving the monitor, do not turn the monitor upside down while holding the stand base or stand riser. This may result in accidental damage to the monitor or cause personal injury.

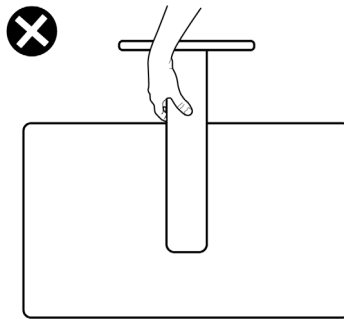

Maintenance guidelines

Cleaning your monitor

 **CAUTION:** Read and follow the [Safety instructions](#) before cleaning the monitor.

 **WARNING:** Before cleaning the monitor, unplug the monitor power cable from the electrical outlet.

For best practices, follow the instructions in the list below when unpacking, cleaning, or handling your monitor:

- Use a clean cloth that is slightly dampened with water to clean the stand assembly, the screen, and the chassis of your Dell monitor. If available, use a screen-cleaning tissue or solution suitable for cleaning Dell monitors.
- After cleaning the surface of the table, ensure that it is thoroughly dry and free from any moisture or cleaning agent before placing your Dell monitor on it.

 **CAUTION:** Do not use detergents or other chemicals such as benzene, thinner, ammonia, abrasive cleaners, alcohol, or compressed air.

 **CAUTION:** Using chemicals for cleaning may cause changes in the appearance of the monitor, such as color fading, milky film on the monitor, deformation, uneven dark shade, and peeling of screen area.

 **WARNING:** Do not spray the cleaning solution or even water directly on the surface of the monitor. Doing so will allow liquids to accumulate at the bottom of the display panel and corrode the electronics resulting in permanent damage. Instead, apply the cleaning solution or water to a soft cloth and then clean the monitor.



 **NOTE:** Monitor damages due to improper cleaning methods and the use of benzene, thinner, ammonia, abrasive cleaners, alcohol, compressed air, detergent of any kind will lead to a Customer Induced Damage (CID). CID is not covered under the standard Dell warranty.

- If you notice white residual powder when you unpack your monitor, wipe it off with a cloth.
- Handle your monitor with care as a darker-colored monitor may get scratched and show white scuff marks more than a lighter-colored monitor.
- To help maintain the best image quality on your monitor, use a dynamically changing screen saver and turn off your monitor when not in use.



Setting up the monitor

Attaching the stand

-  **NOTE:** The stand is not installed at the factory when shipped.
-  **NOTE:** The following instructions are applicable only for the stand that was shipped with your monitor. If you are attaching a stand that you purchased from any other source, follow the setup instructions that were included with the stand.

To attach the monitor stand:

1. Open the front flap of the box to get the stand riser and stand base.

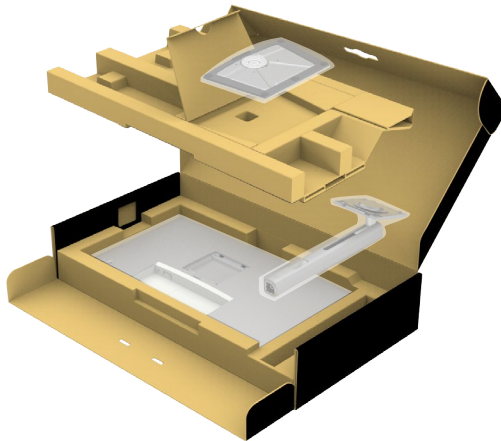

2. Align and place the stand riser on the stand base.
3. Open the screw handle at the bottom of the stand base and turn it clockwise to secure the stand assembly.



4. Close the screw handle.

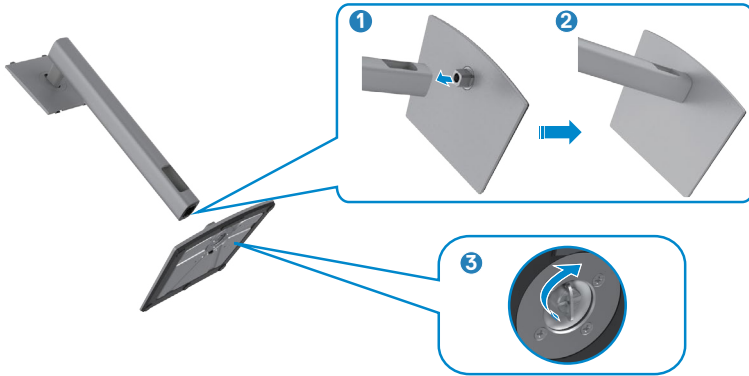

5. Open the protective cover on the monitor to access the VESA slot on the monitor.

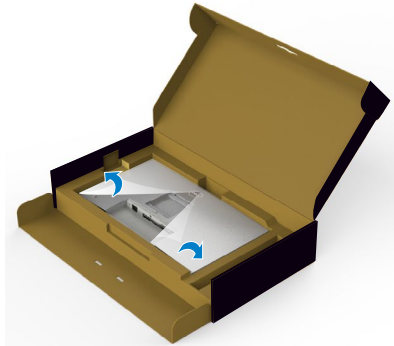

6. Slide the tabs on the stand riser into the slots on the display back cover and lower the stand assembly to snap it into place.

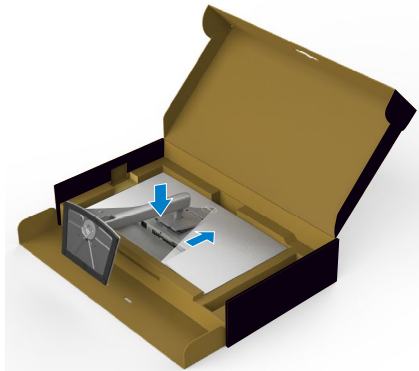

7. Hold the stand riser and lift the monitor carefully, then place it on a flat surface.

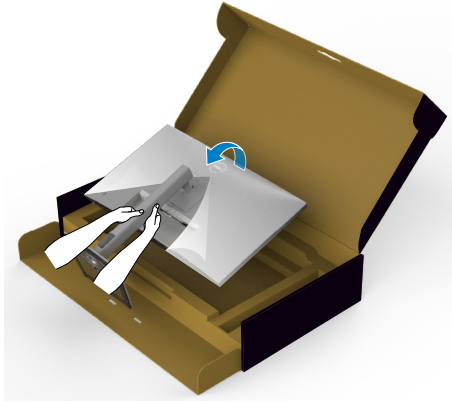

NOTE: Hold the stand riser firmly when lifting the monitor to avoid any accidental damage.

8. Lift the protective cover from the monitor.

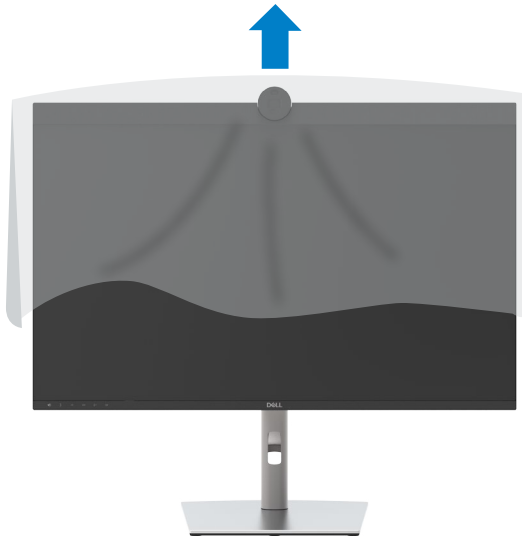

Using the tilt, swivel, and vertical extension

NOTE: The following instructions are applicable only for the stand that was shipped with your monitor. If you are connecting a stand that you purchased from any other source, follow the set up instructions that were included with the stand.

Tilt, swivel, and vertical extension

With the stand attached to the monitor, you can tilt the monitor for the most comfortable viewing angle.

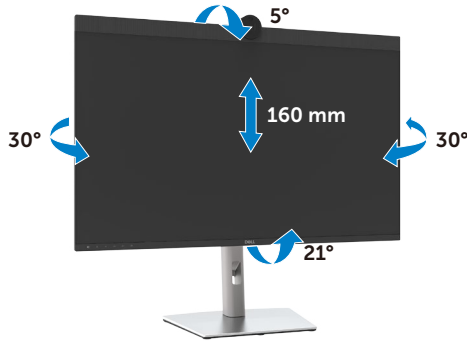

NOTE: The stand is detached when the monitor is shipped from the factory.



Rotating the Display

Before you rotate the display, extend the display vertically until the top of the stand riser and then tilt the display backwards until the maximum to avoid hitting the bottom edge of the display.



- NOTE:** To toggle the display setting on your Dell computer between landscape and portrait when rotating the display, download and install the latest graphics driver. To download, go to <https://www.dell.com/support/drivers> and search for the appropriate driver.
- NOTE:** When the display is in portrait mode, you may experience performance degradation when using graphic-intensive applications such as 3D gaming.



Organizing your cables



After attaching all necessary cables to your monitor and computer, (see [Connecting Your Monitor](#) for cable attachment) organize all cables as shown above.

If your cable is not able to reach your PC, you may connect directly to the PC without routing through the slot on the monitor stand.



Connecting your monitor

⚠ WARNING: Before you begin any of the procedures in this section, follow the [Safety Instructions](#).

🔧 NOTE: Dell monitors are designed to work optimally with the Dell supplied cables inside the box. Dell does not guarantee the video quality and performance if non-Dell cables are used.

🔧 NOTE: Route the cables through the cable-management slot before connecting them.

🔧 NOTE: Do not connect all the cables to the computer at the same time.

🔧 NOTE: The images are for the purpose of illustration only. The appearance of the computer may vary.

To connect your monitor to the computer:

1. Turn off your computer.
2. Connect the Mini DisplayPort or USB cable, and the Thunderbolt™ 4 cable from your monitor to the computer.
3. Turn on your monitor.
4. Select the correct input source from the OSD Menu on your monitor and then turn on your computer.

🔧 NOTE: U3224KB default setting is DisplayPort 2.0. A DisplayPort 1.4 Graphic card may not display normally. Please refer to [product specific problems – No image when using DP connection to the PC to change default setting](#).

Connecting the HDMI cable (Optional)



Switch to lower / higher primary resolution

1. Press the joystick button to launch the OSD main menu.
2. Move the joystick to select **input source**.

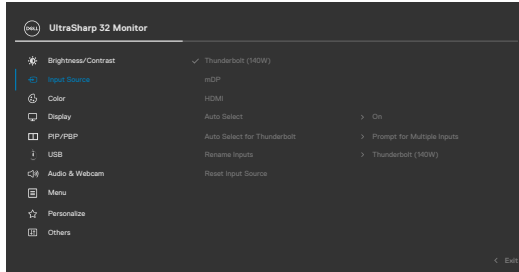

3. Move the joystick up or down to select **HDMI**, press and hold the joystick 8 Sec, the following message will appear:

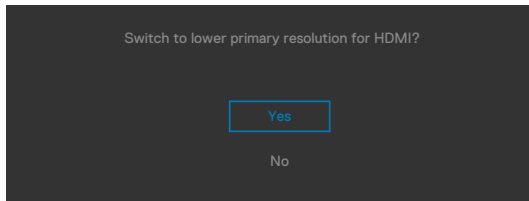

4. Select **Yes** to switch from HDMI 2.1 4 block EDID and max resolution is 6k to HDMI 2.1 2 block and max resolution is 4k (or select No to cancel this operation).
5. Repeat steps 3 and 4 again to switch from HDMI 2.1 2 block and max resolution is 4k to HDMI 2.1 4 block EDID and max resolution is 6k.

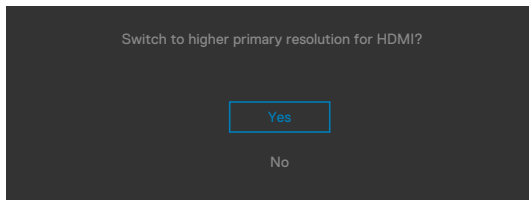

Connecting the mDP cable



Connecting the Thunderbolt™ 4 cable

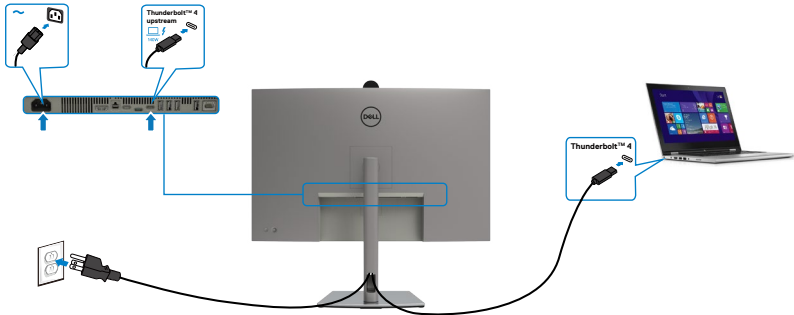

Connecting the USB-C Cable (A to C)



Connecting the USB Type-C cable (C to C) (Optional)

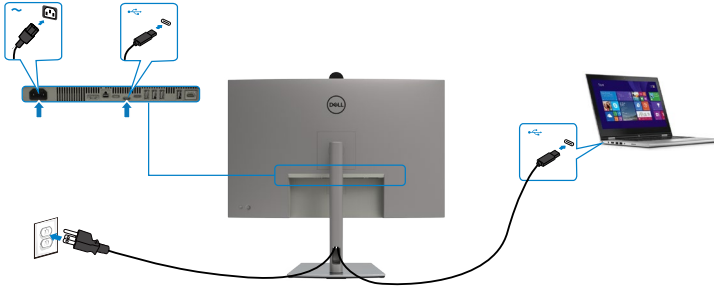

NOTE: This connection only data is available and no video. Need another video connection for display.





NOTE: Regardless of the power requirement/actual power consumption of your laptop, or the remaining power runtime in your battery, the Dell monitor is designed to supply power delivery of up to 140 W to your laptop.

Rated power (on laptops that have USB Type-C with Power Delivery)	Maximum charging power
45 W	45 W
90 W	90 W
140 W	*140 W

*Need laptops support EPR 140W charging.



WARNING: The Dell UltraSharp 32 6K Monitor-U3224KB supports USB Type-C Power Delivery 3.1 (Thunderbolt™ 4) specification and can provide a maximum output of up to 140 W. For safety consideration, this USB Type-C port must be connected to the Dell-approved products with the inbox USB Type-C cable. For the list of Dell-approved products, refer Dell products compatible with USB Type-C Power Delivery 3.1 (Extended Power Range 140W) Tech sheet at Dell.com/support/U3224KB.



Connecting the monitor for Thunderbolt™ 4 daisy chain function

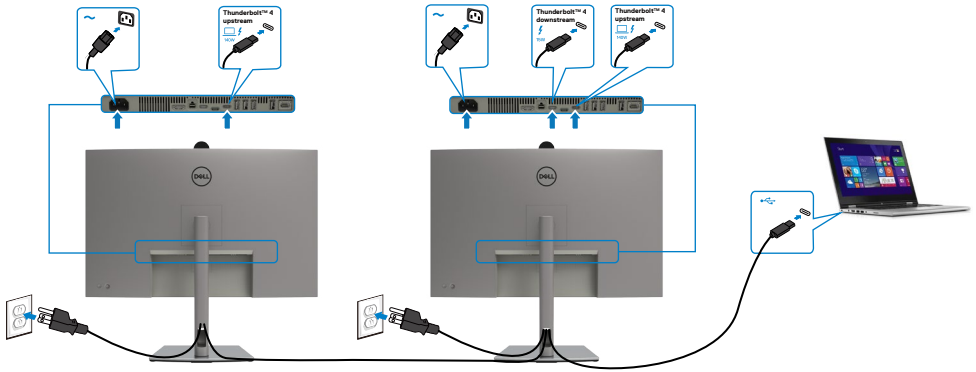

NOTE: The maximum number of supported via daisy chain is subjected to the bandwidth of the Thunderbolt™ 4. Please refer to “[product specific problems –No image when using Thunderbolt™ 4 daisy chain](#)”.

Connecting the monitor for RJ45 Cable (Optional)

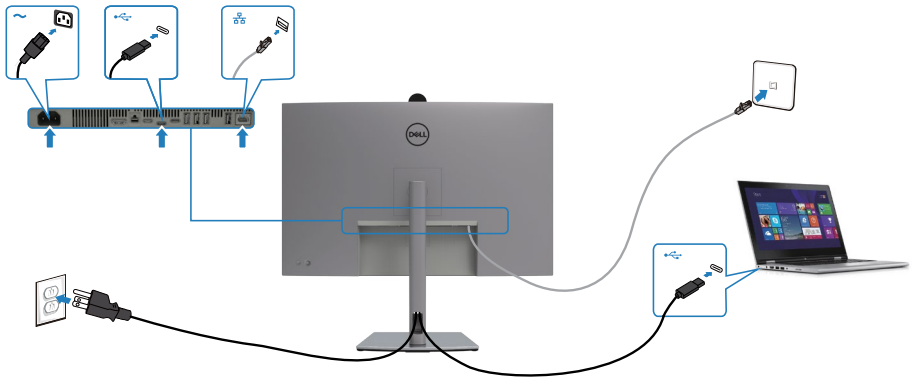

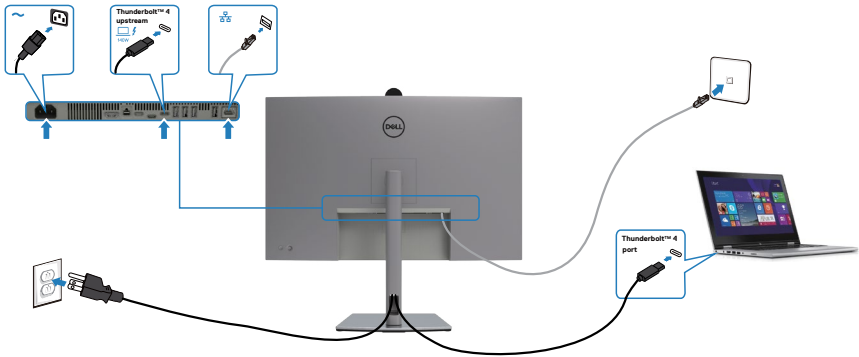

Dell Power Button Sync (DPBS)

Your monitor is designed with Dell Power Button Sync (DPBS) feature to allow you to control PC system power state from the monitor power button. This feature is only supported with Dell platform which has built-in DPBS function, and is only supported over Thunderbolt™ 4 interface.

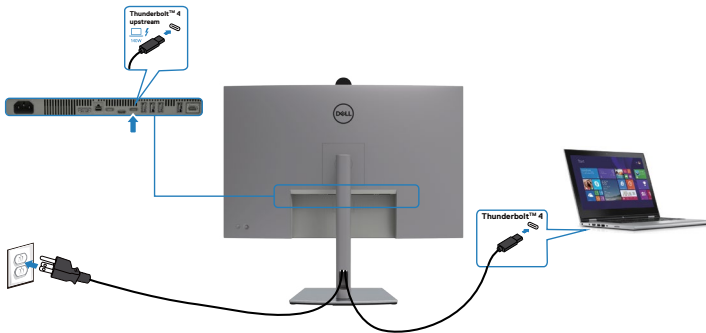

To make sure the DPBS function works for the first time, perform the following steps on the DPBS supported platform in the **Control Panel** first.

NOTE: DPBS only supports the Thunderbolt™ 4 port.

1. Go to **Control Panel**.



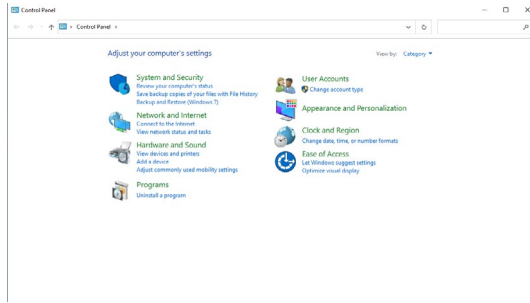

2. Select **Hardware and Sound**, followed by **Power Options**.

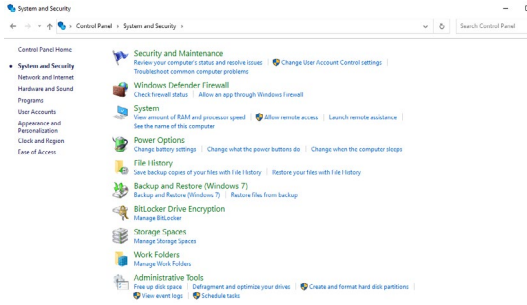

3. Go to **System Settings**

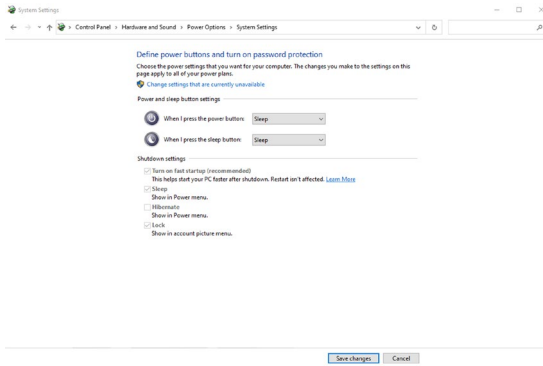

4. In the drop-down menu of **When I press the power button**, there are a few options for selection namely **Do nothing/Sleep/Hibernate/Shut down**, and you can select **Sleep/Hibernate/Shut down**.

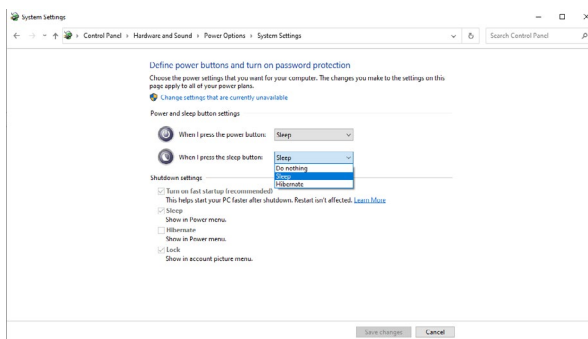
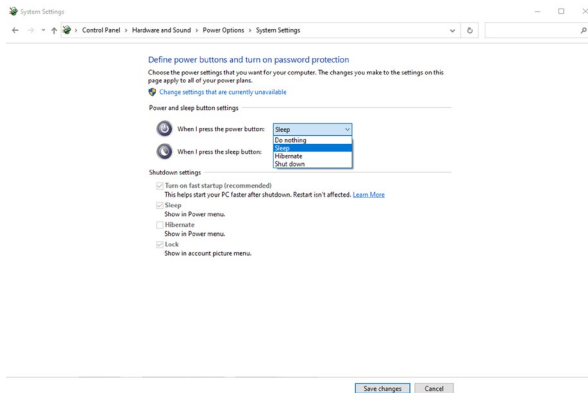

NOTE: Do not select Do nothing, otherwise monitor power button cannot sync with PC system power state.



5. Go to Monitor OSD Display, turn **On** from off in Dell Power Button Sync.

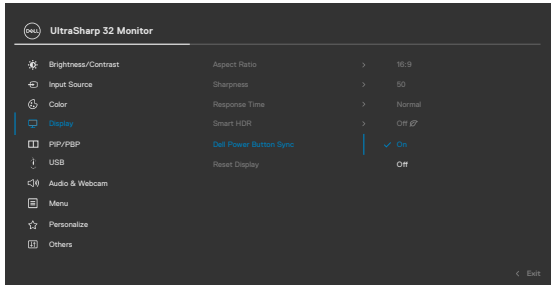

Connecting the monitor for DPBS for the first time

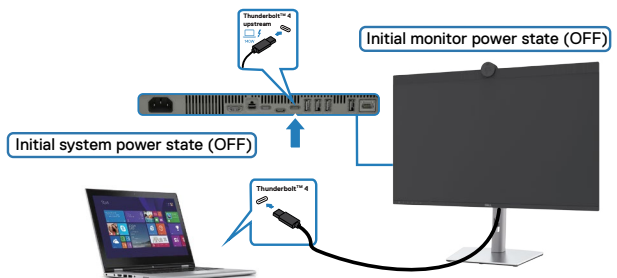

For the first time setting up the DPBS function, please follow below steps:

1. Make sure both the PC and monitor is OFF.
2. Connect the Thunderbolt™ 4 cable from the PC to the monitor.
3. Press the monitor power button to turn ON the monitor.
4. Both the monitor and PC will turn ON normally. If not, press either the monitor power button or PC power button to boot up the system.
5. When you connect the Dell OptiPlex 7090/3090 Ultra platform, you may see both the monitor and PC will turn ON momentarily. Wait for a while (approximately 6 seconds) and both the PC and monitor will turn OFF. When you press either the monitor power button or PC power button, both the PC and monitor will turn ON.

The PC system power state is in sync with the monitor power button.

NOTE: When the monitor and PC are both at power OFF state at first time, it is recommended that you turn ON the monitor first, then connect the Thunderbolt™ 4 cable from the PC to the monitor.

NOTE: You can power the Dell PC* Ultra platform using its DC adaptor jack. Alternatively, you can power the Dell PC* Ultra platform using the



monitor's Thunderbolt™ 4 cable via Power Delivery (PD); please set Thunderbolt™ 4 Charging to On in Off Mode.

* Ensure to check the Dell PC for DBPS supportability.

Using DPBS function

When you press the monitor power button or PC power button, the Monitor / PC state is as follows:

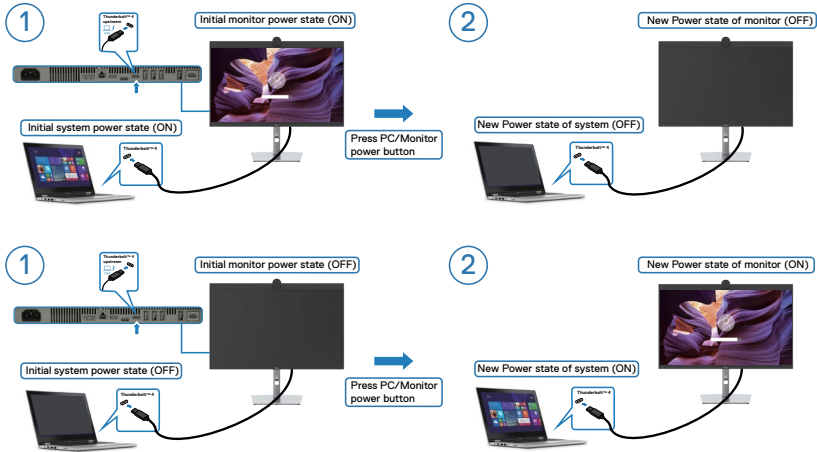

When the monitor and PC power state are both ON, while you **press and hold 4 seconds on monitor power button**, the screen prompt will ask if you would like to shut down the PC.

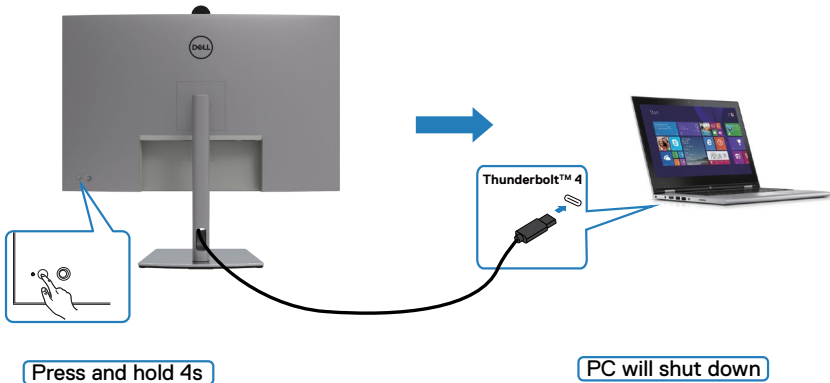

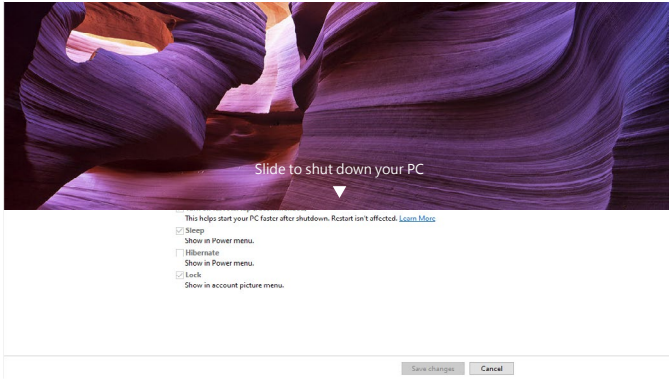

When the monitor and PC power state are both ON, while **you press and hold 10 seconds on monitor power button**, the PC will shut down.

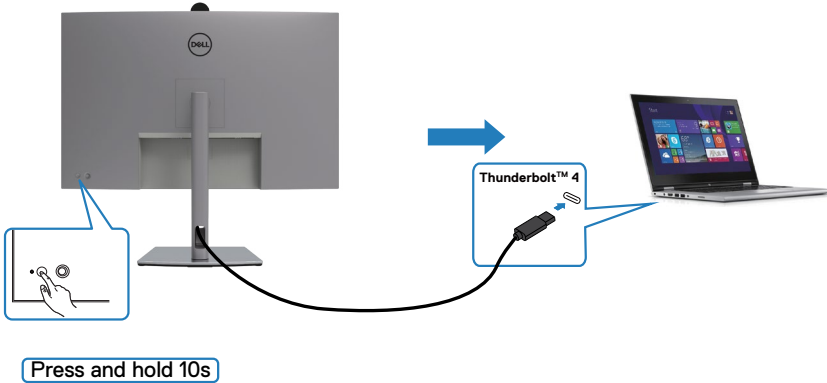

Connecting the monitor for Thunderbolt™ daisy chain function

A PC is connected to two monitors in an initially OFF power state, and the PC system power state is in sync with Monitor 1 power button. When you press the Monitor 1 or PC power button, both the Monitor 1 and PC turns ON. Meanwhile the Monitor 2 will remain OFF. You need to manually press the power button on Monitor 2 to turn it ON.

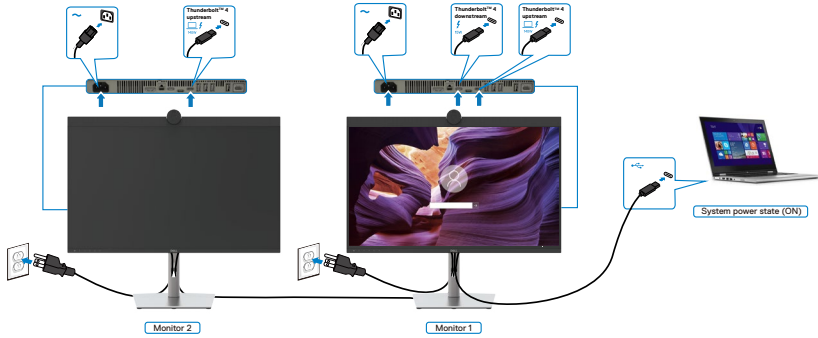

Similarly, a PC is connected to two monitors in an initially ON power state, and the PC system power state is in sync with Monitor 1 power button. When you press the Monitor 1 or PC power button, both the Monitor 1 and PC turns OFF. Meanwhile the Monitor 2 will be in Standby mode. You need to manually press the power button on Monitor 2 to turn it OFF.

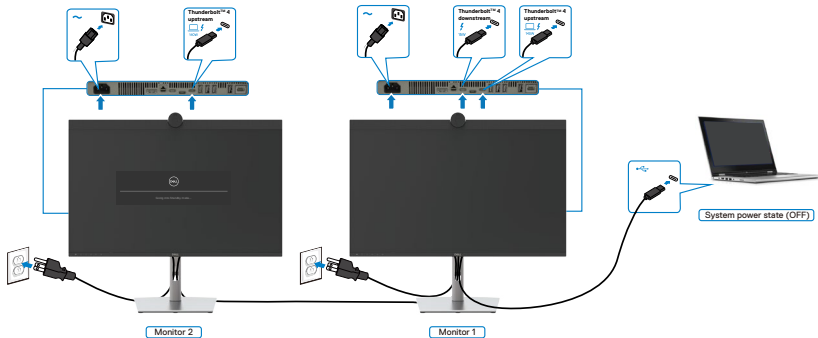

Connecting the monitor for Thunderbolt™ 4

The Dell PC* Ultra platform has two Thunderbolt™ 4 ports, so both Monitor 1 and Monitor 2 power state can sync with the PC.

While the PC and two monitors are in an initially ON power state, by pressing the power button on Monitor 1 or Monitor 2 will turn OFF the PC, Monitor 1, and Monitor 2.

* Ensure to check the Dell PC for DBPS supportability.

NOTE: DPBS only supports the Thunderbolt™ 4 port.

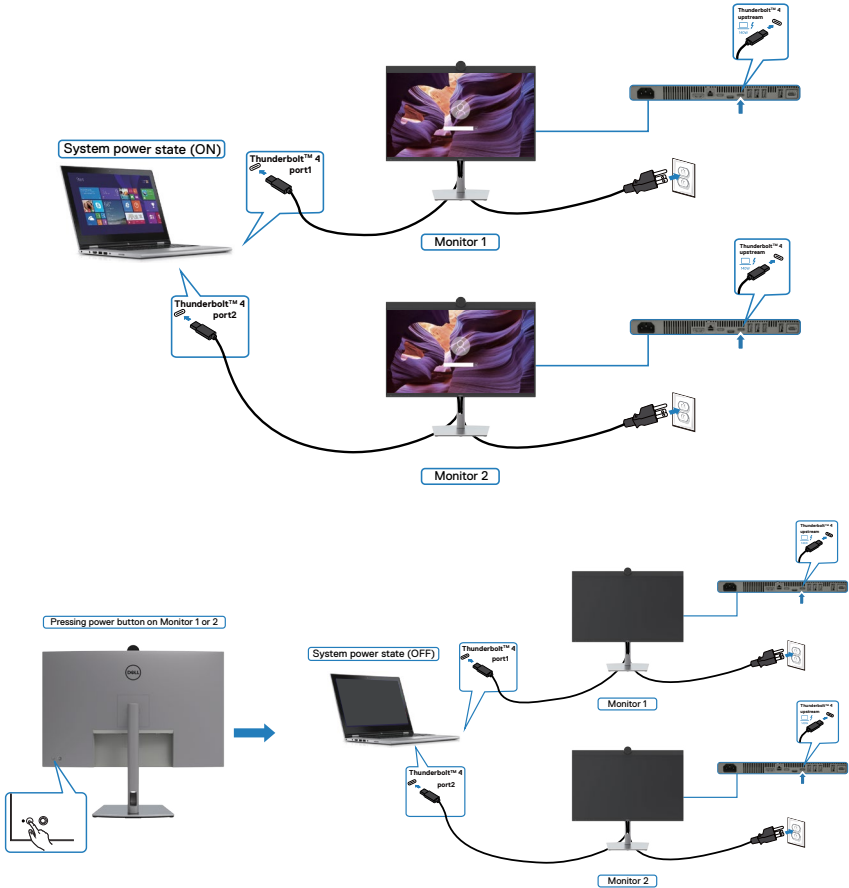

Make sure to set **Thunderbolt™ 4** to On in Off Mode. While the PC and two monitors are in an initially OFF power state, by pressing the power button on Monitor 1 or Monitor 2 will turn ON the PC, Monitor1, and Monitor 2.

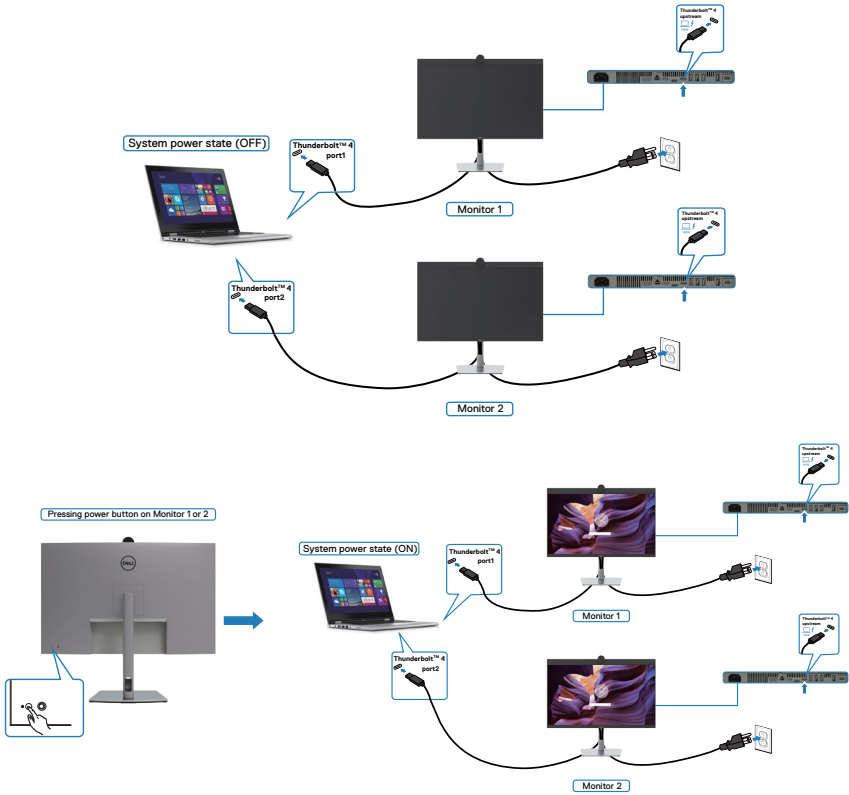

Operating the monitor webcam

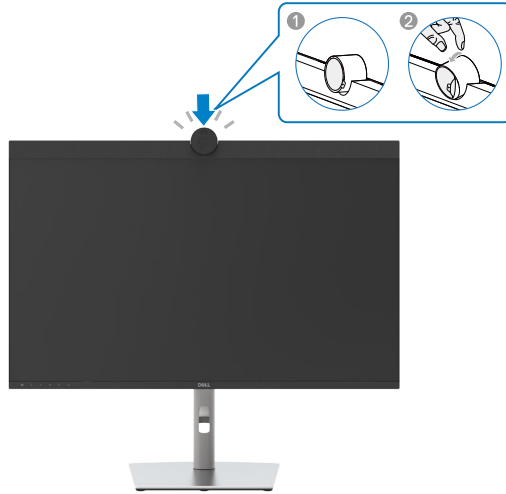

The webcam offers the following:

- 0-20 degree tilt adjustability
- 4K video at 30 fps and Full HD video at 60 fps
- AI Auto-framing
- 5x digital zoom
- Adjustable field-of-view with autofocus
- High Dynamic Range (HDR) and video noise reduction support
- Walk Away Lock and Wake on Approach support
- Windows Hello support
- Additional customization using Dell Peripheral Manager

Auto-framing (Single user framing):

- If the user is within 2 meters of the webcam, the webcam will enable the Auto-framing.
- Feature and adjust the frame to focus on the user. You can enable Auto-framing to ensure the camera always keeps you in the center of the frame.

HDR and Video Noise Reduction:

- The webcam's Digital Overlap HDR guarantees superior picture quality in extreme lighting environments, while video noise reduction automatically eliminates grainy images in low light.



Dell Peripheral Manager

What is Dell Peripheral Manager?

The Dell Peripheral Manager application helps you manage and set up various Dell Peripherals connected to your computer. It allows the user to make changes to webcam settings of the device and provides additional customization.

For more details on the application and the customizations available for the Dell U3224KB, find the User's Guide for Dell Peripheral Manager at

www.dell.com/support.



Securing your monitor using Kensington lock (optional)

The security lock slot is located at the bottom of the monitor. (See [Security lock slot](#)). Secure your monitor to a table using the Kensington security lock.

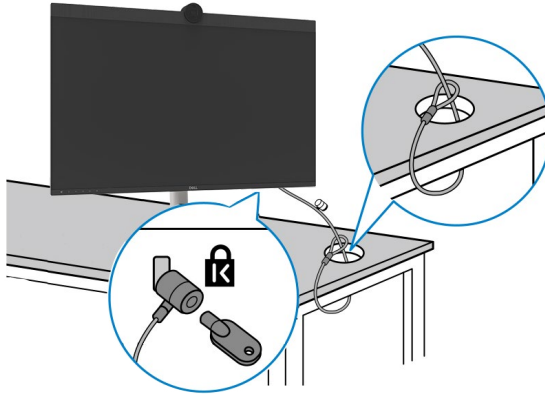

For more information on using the Kensington lock (purchased separately), see the documentation that is shipped with the lock.



NOTE: The image is for the purpose of illustration only. Appearance of the lock may vary.



Removing the monitor stand

-  **NOTE:** To prevent scratches on the LCD screen when removing the stand, ensure that the monitor is placed on a soft surface and handle it carefully.
-  **NOTE:** The following steps are specifically for removing the stand that is shipped with your monitor. If you are removing a stand that you purchased from any other source, follow the setup instructions that are included with the stand.

To remove the stand:

 **CAUTION:** Place the monitor screen on the desktop. Take note that the webcam is slightly protruded out of the monitor screen, please protect the webcam surface to prevent wear by the desktop.

1. Place the monitor on a soft cloth or cushion.
2. Press and hold the stand-release button.
3. Lift the stand up and away from the monitor.

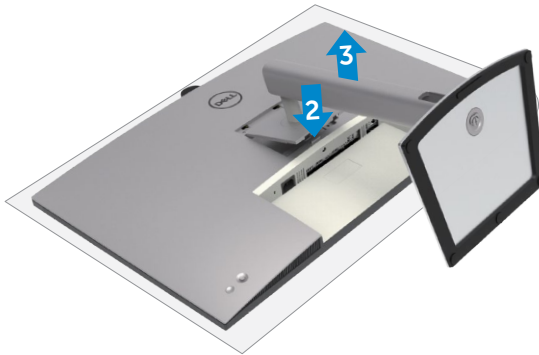

Wall mounting (Optional)



NOTE: Use M4 x 10 mm screws to connect the monitor to the wall-mounting kit.

Refer to the instructions that come with the VESA-compatible wall mounting kit.

1. Place the monitor on a soft cloth or cushion on a stable flat table.
2. Remove the stand.
3. Use a Phillips crosshead screwdriver to remove the four screws securing the plastic cover.
4. Attach the mounting bracket from the wall mounting kit to the monitor.
5. Mount the monitor on the wall as instructed in the documentation that shipped with the wall-mounting kit.

NOTE: For use only with UL or CSA or GS-listed wall mount bracket with minimum weight/load bearing capacity of 34.4 kg (75.92 lb).



Operating the monitor

Power on the monitor

Press the  button to turn on the monitor.



Using the joystick control



To modify the OSD adjustments using the joystick control on the rear end of the monitor, do the following:

1. Press the joystick to open the OSD Menu Launcher.
2. Move the joystick up/down/left/right to toggle between the OSD menu options.



Joystick Functions

Joystick	Description
----------	-------------



Press joystick to open the OSD Menu Launcher.



For right and left navigation.



For up and down navigation.



Using the rear-panel controls

Press the Joystick to open the OSD Menu Launcher.

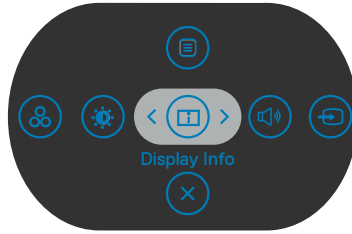





Menu Launcher

- Toggle the Joystick **Up** to open the **Main Menu**.
- Toggle the Joystick **Left** or **Right** to select the desired **Shortcut Keys**.
- Toggle the Joystick **Down** to **Exit**.

Menu Launcher Details

The following table describes the Menu Launcher icons:

Options	Description
 Shortcut key: Menu	Use this Menu button to launch the on-screen display (OSD) and select the OSD menu.
 Shortcut key: Preset Modes	Use this button to choose from a list of preset color modes .
 Shortcut key: Brightness/Contrast	To directly access the Brightness/Contrast adjustment sliders.
 Shortcut key: Display Info	Use this button to choose from a list of Display Info .
 Shortcut key: Volume	Use this button to adjust the volume of the built-in speakers.



Options



Shortcut key: **Input Source**

Description

Use this button to choose from a list of **Input Source**.



Shortcut key: **Aspect Ratio**

Use this button to choose from a list of **Aspect Ratio**.



Exit

Use this button to go back to the main menu or **exit** the OSD main menu.



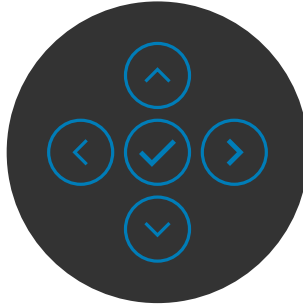

Front-panel button

Use the buttons on the front of the monitor to adjust the image settings.



Front Panel

Description

-  
Up **Down**
Use the **Up** (increase) and **Down** (decrease) buttons to adjust items in the OSD menu.
- 
Previous
Use the **Previous** button to go back to the previous menu.
- 
Next
Use the **Next** button to confirm your selection.
- 
Tick
Use the **Tick** button to confirm your selection.

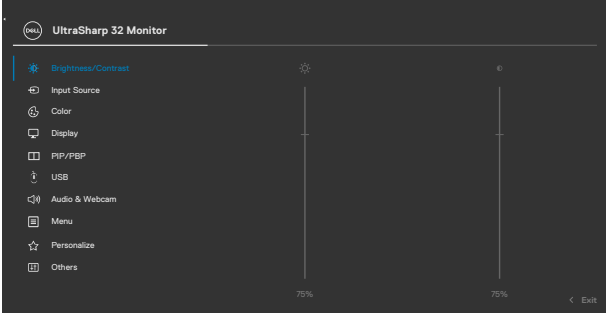

Using the Main Menu

Icon	Menu and Submenus	Description
	Brightness/Contrast	Use this menu to activate Brightness/Contrast adjustment. 
	Brightness	Adjusts the luminance of the backlight (Range: 0 - 100). Move the Joystick Up to increase brightness. Move the Joystick Down to decrease brightness.
	Contrast	Adjust the Brightness first, and then adjust Contrast only if further adjustment is necessary. Move the Joystick Up to increase contrast and Move the Joystick Down to decrease contrast (Range: 0 - 100). The Contrast function adjusts the degree of difference between darkness and lightness on the monitor screen.



Icon	Menu and Submenus	Description
------	-------------------	-------------



Input Source

Use the **Input Source** menu to select between different video inputs that are connected to your monitor.

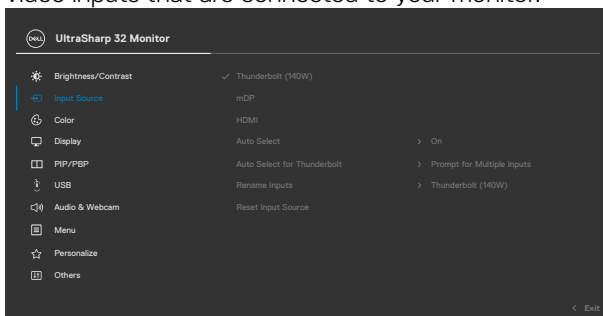

Thunderbolt (140W)	Select Thunderbolt (140W) input when you are using the Thunderbolt (140W) connector. Press the joystick button to confirm the selection.
mDP	Select mDP input when you are using the mDP (Mini DisplayPort) connector. Press the joystick button to confirm the selection.
HDMI	Select the HDMI input when you are using the HDMI connector. Press the joystick button to confirm the selection.
Auto Select	Allows you to scan for available input sources. Press <input checked="" type="checkbox"/> to select this function.
Auto Select for Thunderbolt	Press <input checked="" type="checkbox"/> to select these functions: <ul style="list-style-type: none"> ◆ Prompt for Multiple Inputs: always show Switch to Thunderbolt Video Input message for user to choose whether to switch or not. ◆ Yes: The monitor always switches to Thunderbolt video by default while Thunderbolt is connected. ◆ No: The monitor will NOT auto switch to Thunderbolt video from another available input.
Rename Inputs	Allows you to Rename Inputs .
Reset Input Source	Resets all settings under the Input Source menu to the factory defaults. Press <input checked="" type="checkbox"/> to select this function.



Icon **Menu and Submenus**

Description



Color

Adjusts the color setting mode.

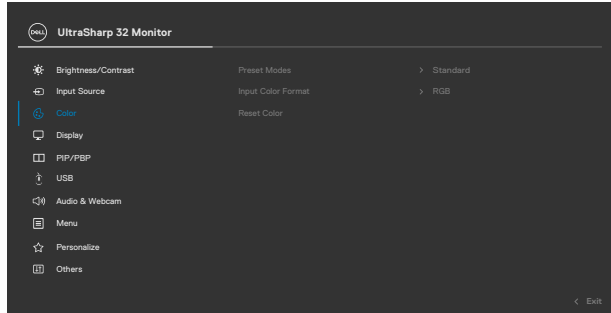

Preset Modes

When you select Preset Modes, you can choose **Standard**, **Movie**, **Game**, **Color Temp**, **Color Space** or **Custom Color** from the list.

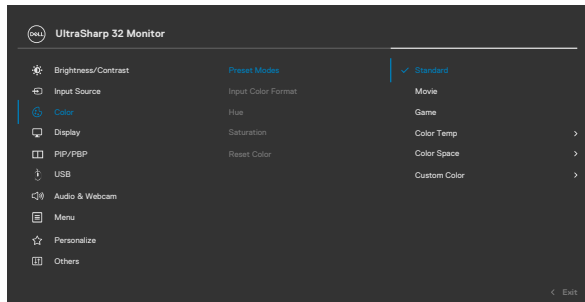

Icon	Menu and Submenus	Description
		<ul style="list-style-type: none"> ◆ Standard: Default Color setting. This monitor uses a low blue light panel, and is certified by TUV to reduce blue light output and create a more relaxing and less stimulating image while reading content on the screen. ◆ Movie: Ideal for movies. ◆ Game: Ideal for most gaming applications. ◆ Color Temp: The screen appears warmer with a red/yellow tint with slider set at 5,000K or cooler with blue tint with slider set at 10,000K. ◆ Color Space: Allows users to select the color space: sRGB, Rec. 709, DCI-P3, Display P3. ◆ Custom Color: Allows you to manually adjust the color settings. Press the joystick left and right buttons to adjust the Red, Green, and Blue values and create your own preset color mode.

Input Color Format

Allows you to set the video input mode to:

- ◆ **RGB:** Select this option if your monitor is connected to a computer or a media player that supports RGB output.
- ◆ **YCbCr:** Select this option if your media player supports only YCbCr output.

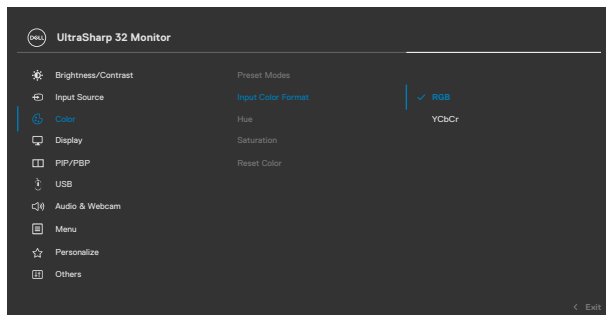

Hue

Use Joystick **Up** or **Down** to adjust the **Hue** from 0 to 100.

NOTE: Hue adjustment is available only for **Movie** and **Game** mode.



Icon	Menu and Submenus	Description
	Saturation	Use Joystick Up or Down to adjust the Saturation from 0 to 100. NOTE: Saturation adjustment is available only for Movie and Game mode.
	Reset Color	Resets your monitor's color settings to the factory defaults. Press  to select this function.



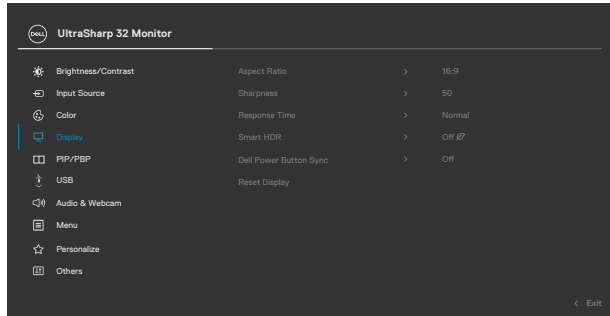

Display

Use the **Display** menu to adjust image.



Aspect Ratio	Adjust the image ratio to 16:9 , Auto Resize , 4:3 , 1:1 .
Sharpness	Makes the image look sharper or softer. Move the joystick up and down to adjust the sharpness from '0' to '100'.
Response Time	Allows you to set the Response Time to Normal or Fast .



Icon	Menu and Submenus	Description
	Smart HDR	<p>Press  to select these functions.</p> <p>Smart HDR (High Dynamic Range) automatically enhances the display output by adjusting the settings optimally to resemble life-like visuals.</p> <p>Desktop: This is the default mode. This mode is more suitable for general usage of the monitor with a desktop computer.</p> <p>Movie HDR: Use this mode during playback of HDR video content to expand the contrast ratio, brightness, and color palette. It matches the video quality with real life visuals.</p> <p>Game HDR: Use this mode when playing games that support HDR to expand the contrast ratio, brightness, and color palette. It makes gaming experience more realistic as intended by game developers.</p> <p>DisplayHDR: Best used with content that complies with DisplayHDR standards.</p> <p>Off: Disables Smart HDR function.</p> <p>NOTE: The possible peak luminance during HDR mode is 600-nits (typical). The actual value and duration during HDR playback might vary accordingly to the video content.</p>
	Dell Power Button Sync	<p>To allow you to control PC system power state from the monitor power button.</p> <p>Allows you to On or Off Dell Power Button Sync function.</p> <p>NOTE: This feature is only supported with Dell platform which has built-in DPBS function, and is only supported over Thunderbolt interface.</p>
	Reset Display	<p>Resets all settings under the Display menu to the factory defaults.</p> <p>Press  to select this function.</p>



Icon	Menu and Submenus	Description
------	-------------------	-------------



PIP/PBP

This function brings up a window displaying image from another input source.

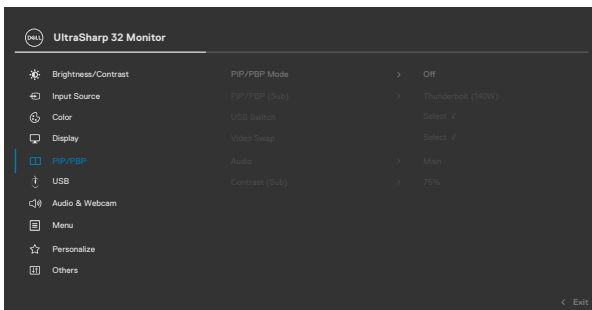

Main Window	Sub-Window		
	Thunderbolt (140W)	mDP	HDMI
Thunderbolt (140W)		✓	✓
mDP	✓		✓
HDMI	✓	✓	



NOTE: The images under PBP will be displayed at the center of the screen, not full screen.

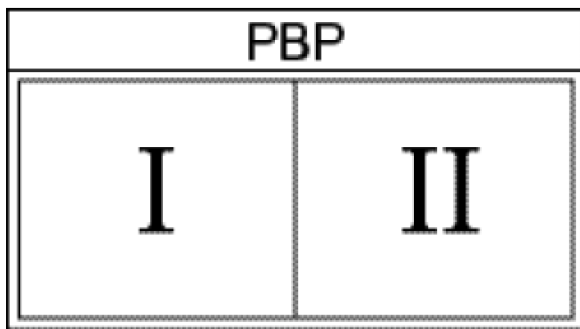
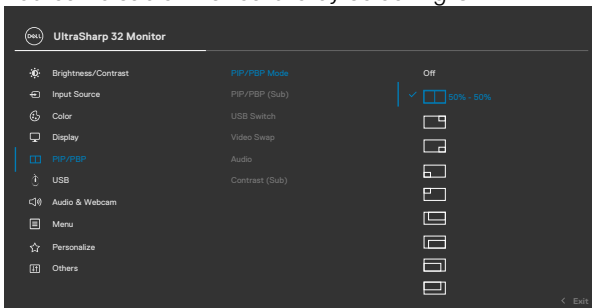

Icon	Menu and Submenus	Description
------	-------------------	-------------

PIP/PBP Mode Adjusts the PIP or PBP (Picture by Picture) mode. You can disable this feature by selecting Off.

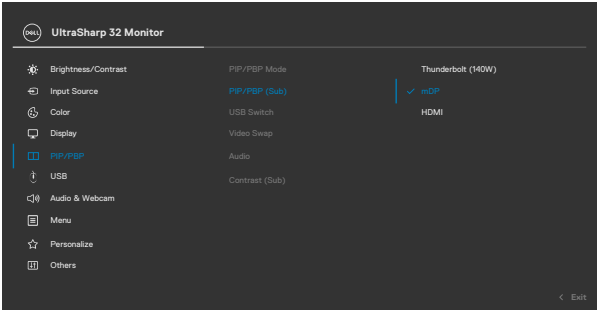

Icon	Menu and Submenus	Description
	PIP/PBP (Sub)	Select between the different video signals that may be connected to your monitor for the PBP sub-window. Press the  button to select the PBP sub-window source signal.
		 
	USB Switch	Select to switch between the USB upstream sources in PBP mode. Move the joystick to switch among USB upstream sources in PBP mode.
	Video Swap	Select to swap videos between main window and sub-window in PBP mode. Move the joystick to swap main window and sub-window.
	Audio	Allows you to set the audio source from the main window or the sub-window.
	Contrast (Sub)	Adjust the Contrast level of the picture in PBP Mode. Move the Joystick to increase or decrease the contrast.



Icon	Menu and Submenus	Description
------	-------------------	-------------



USB

Allows you to set the USB upstream port for the mDP input signals, thus the monitor's USB downstream port (For example, keyboard and mouse) can be used by the current input signals when you connect a computer to either one of the upstream ports. When you use only one upstream port, the connected upstream port is active.

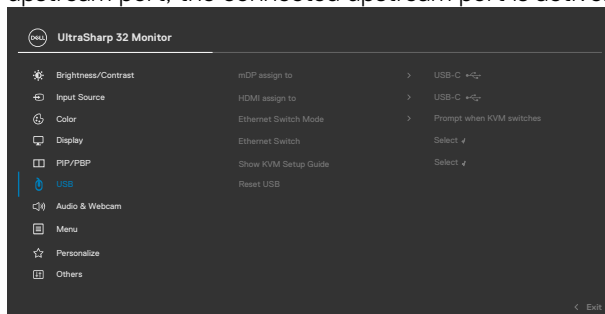

NOTE: To prevent data damage or loss, before changing USB upstream ports, make sure that NO USB storage devices are in use by the computer connected to the monitor's USB upstream port.

Ethernet Switch Mode

Allows you to set the Ethernet switch mode:

- **Tie to KVM:** When KVM USB switches, Ethernet switches together.
- **Prompt when KVM switches:** When KVM USB switches, a message prompts user to decide whether to switch Ethernet together.
- **Switch Manually:** When KVM USB switches, Ethernet does not switch.

Ethernet Switch

Manually switch Ethernet.

Show KVM Setup Guide

Select this option and follow steps if you want to connect multiple computers to the monitor and use one setup of keyboard and mouse.

Reset USB

Resets all settings under the **USB** menu to the factory defaults.



Icon	Menu and Submenus	Description
------	-------------------	-------------



Audio & Webcam

Use the Audio Settings menu to adjust the audio settings.

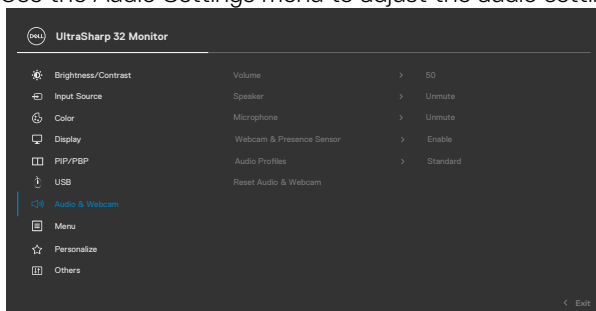

Volume	Allows you to increase the speaker volume. Move the joystick up and down to adjust the volume from '0' to '100'.
Speaker	Select On or Off the Speaker function.
Microphone	Select Mute or Unmute the Microphone function.
Webcam & Presence Sensor	Select Enable or Disable the Webcam and Presence Sensor function. NOTE: Disabling “webcam & presence sensor” will turn off the whole webcam module, webcam and sensor will not appear in the system. “Camera disable” button will not work as well. Camera disable button at the front is used to lock and unlock shutter.
Audio Profiles	Expand to show the various audio profiles. <ul style="list-style-type: none"> ◆ Standard: Default audio setting. ◆ Voice: Emphasize on speech, ideal for voice and video calls. ◆ Movie: Emphasizes voice and low frequency sound, for more immersive video viewing experience. ◆ Gaming: Boosting low and high frequencies, for an improved sense of space and orientation in gaming. ◆ Music: Provides a flat EQ profile, for faithful music reproduction.
Reset Audio & Webcam	Resets all settings under the Audio and Webcam menu to the factory preset values.



Icon	Menu and Submenus	Description
	Menu	Select this option to adjust the settings of the OSD, such as the languages of the OSD, the amount of time the menu remains on screen, and so on.

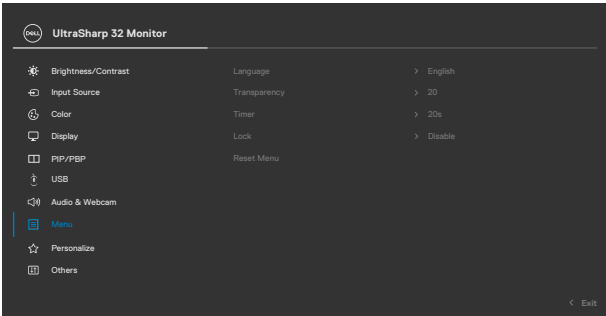

Language	Set the OSD display to one of eight languages. (English, Spanish, French, German, Brazilian Portuguese, Russian, Simplified Chinese, or Japanese).
Transparency	Select this option to change the menu transparency by moving the Joystick up or down (Range: 0 - 100).
Timer	OSD Hold Time: Sets the length of time the OSD remains active after you press a button. Move the joystick to adjust the slider in 1-second increments, from 5 to 60 seconds.



Icon	Menu and Submenus	Description
------	-------------------	-------------

Lock

With the control buttons on the monitor locked, you can prevent people from accessing the controls. It also prevents accidental activation in multiple monitors side-by-side setup.

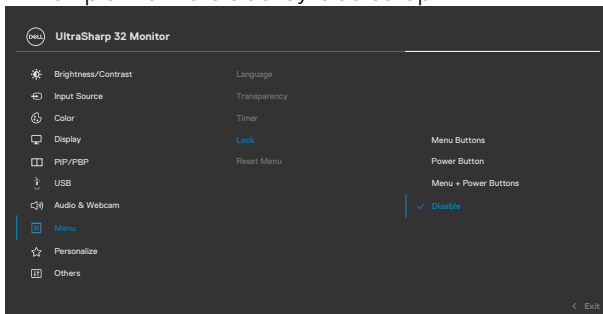

- **Menu Buttons:** Through OSD to lock the Menu buttons.
- **Power Button:** Through OSD to lock the Power button.
- **Menu + Power Buttons:** Through OSD to lock all Menu and Power buttons.
- **Disable:** Move the Joystick left and hold for 4 seconds.

Reset Menu

Resets all settings under the **Reset Menu** to the factory defaults.

Press  to select this function.

Personalize

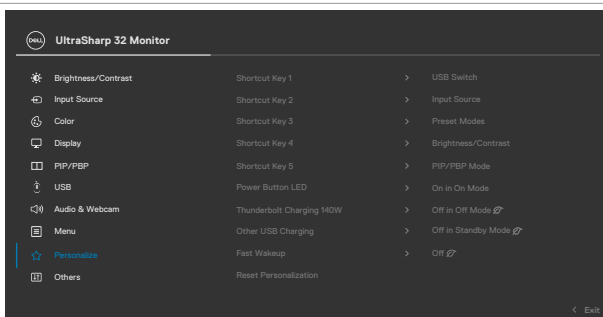

Icon	Menu and Submenus	Description
	Shortcut key 1	Select from Preset Modes, Brightness/Contrast, Input Source, Aspect Ratio, PIP/PBP Mode, USB Switch, Ethernet Switch, Video Swap, Volume, Smart HDR, Display Info, Webcam & Presence Sensor, Speaker, Microphone, Audio Profiles set as shortcut key.
	Shortcut key 2	
	Shortcut key 3	
	Shortcut key 4	
	Shortcut key 5	
	Power Button LED	Allows you to set the state of the power light to save energy.
	Thunderbolt Charging (140W)	Allows you to enable or disable Thunderbolt Charging (140W) charging function during monitor power off mode. NOTE: When this function is enabled, you will be able to charge your notebook or mobile devices through the USB-C cable even when the monitor is powered Off.
	Other USB Charging	Allows you to enable or disable Other USB Charging function during monitor Standby mode. NOTE: When this function is enabled, you will be able to charge your mobile phone through the USB-A cable even when the monitor is in standby mode.
	Fast Wakeup	Speed up recovery time from sleep mode.
	Reset Personalization	Resets all settings under the Personalize to the factory defaults. Press  to select this function.



Icon	Menu and Submenus	Description
------	-------------------	-------------



Others

Select this option to adjust the OSD settings such as the **DDC/CI, LCD** conditioning, and so on.

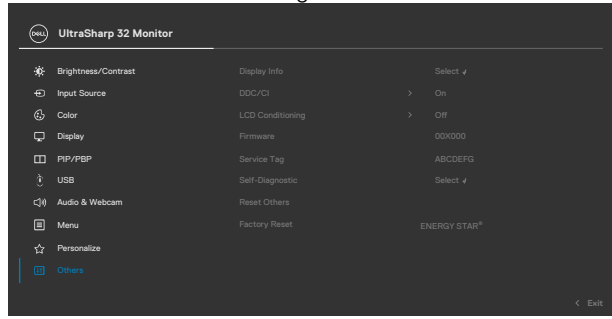

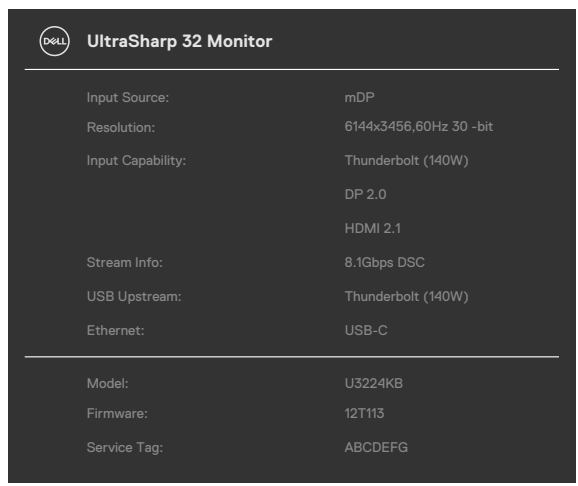

Display Info

Displays the monitor's current settings. Press to select this function.

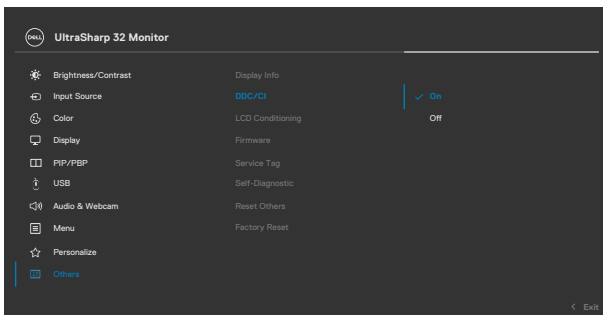

Icon	Menu and Submenus	Description
	DDC/CI	<p>DDC/CI (Display Data Channel/Command Interface) allows your monitor parameters (brightness, color balance, etc.) to be adjustable via the software on your computer. You can disable this feature by selecting Off. Enable this feature for best user experience and optimum performance of your monitor.</p>

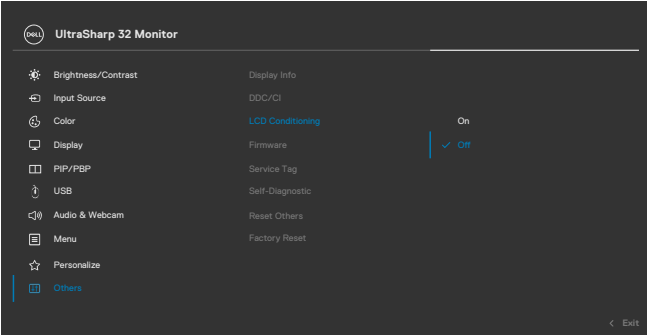

Icon	Menu and Submenus	Description
	LCD Conditioning	Helps reduce minor cases of image retention. Depending on the degree of image retention, the program may take some time to run. You can enable this feature by selecting On .
		
		
Firmware	Displays the Firmware version of your monitor.	
Service Tag	Displays the Service Tag . The Service Tag is a unique alphanumeric identifier that allows Dell to identify the product specifications and access warranty information. NOTE: The Service Tag is also printed on a label located at the back of the cover.	
Self-Diagnostic	Use this option to run the built-in diagnostics, see Built-in Diagnostics .	
Reset Others	Resets all settings under the Others menu to the factory defaults. Press  to select this function.	
Factory Reset	Restores all preset values to the factory default settings. These are also the settings for ENERGY STAR® tests.	



Using the OSD lock function

You can lock the front-panel control buttons to prevent access to the OSD menu and/or power button.

Use the Lock menu to lock the button(s).

1. Select one of the following options.

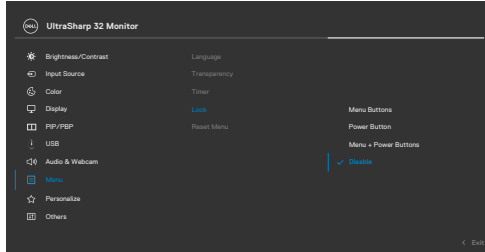

2. The following message appears.

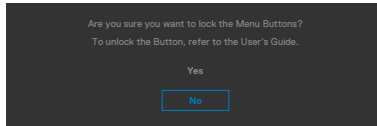

3. Select **Yes** to lock buttons. Once locked, pressing any control button will display the lock icon .



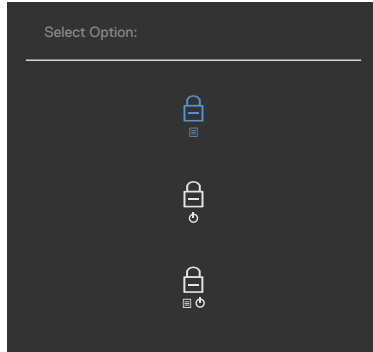

Use the Joystick to lock the button(s).

Press the left directional navigation of Joystick for four seconds, a menu appears on the screen.



Select one of the following options:



Options	Description
1  Menu Button lock	Select this option to lock OSD menu function.
2  Power Button lock	Use this option to lock power button. This will prevent the user to turn off the monitor using the power button.
3  Menu and Power Button lock	Use this option to lock OSD menu and power button to turn off the monitor.

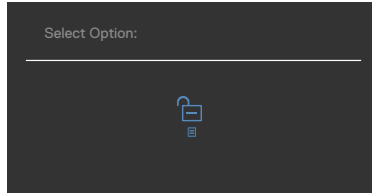

To unlock the button(s).

Press the left directional navigation of Joystick for four seconds until a menu appears on the screen. The following table describes the options to unlock the front-panel control buttons.



Options	Description
1  Menu Button unlock	Use this option to unlock OSD menu function.
2  Power Button unlock	Use this option to unlock power button to turn off the monitor.
3  Menu and Power Button unlock	Use this option to unlock OSD menu and power button to turn off the monitor.



Initial Setup

When you select OSD items of **Factory Reset** in Other feature, the following message will appear:

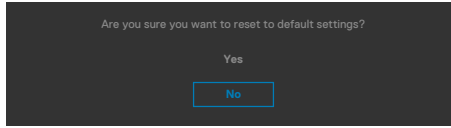

When you select **Yes** to reset to default settings, the following message will appear:

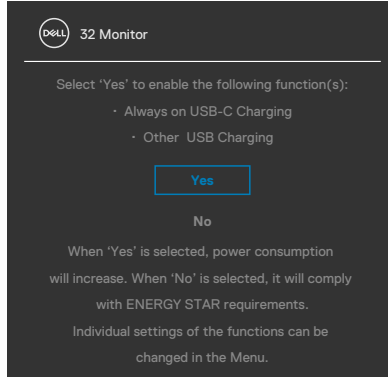

OSD warning messages

When the monitor does not support a particular resolution mode, you can see the following message:

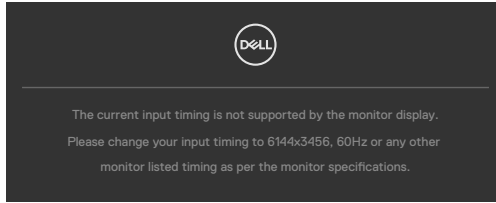

This means that the monitor cannot synchronize with the signal that it is receiving from the computer. See [Monitor Specifications](#) for the Horizontal and Vertical frequency ranges addressable by this monitor. Recommended mode is **6144 x 3456**. You can see the following message before the DDC/CI function is disabled:

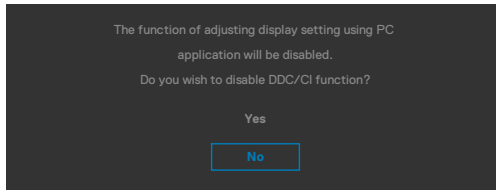

When the monitor enters the **Standby Mode**, the following message will appear:

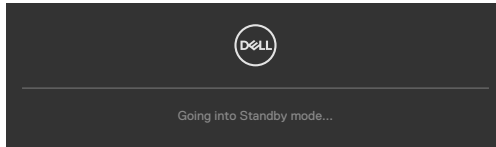

Activate the computer and wake up the monitor to gain access to the **OSD**.

If you press any button other than the power button, the following messages will appear depending on the selected input:

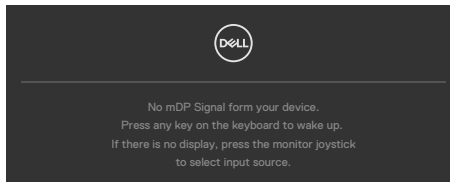

A message is displayed while the cable supporting DP alternate mode is connected to the monitor under the following conditions:

- When Auto Select for **Thunderbolt(140W)** is set to **Prompt for Multiple Inputs**.
- When the Thunderbolt™ cable is connected to the monitor.

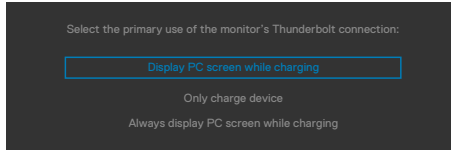

If two or more ports are connected, when the **Auto** of Input Source is selected, it will turn to the next port with signal.

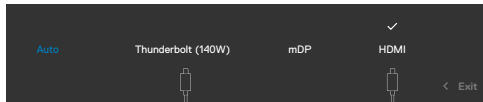

Select OSD items of **On in Standby Mode** in Personalize feature, the following message will appear:

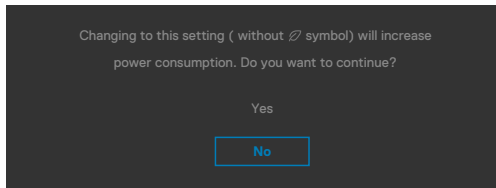

If adjust the Brightness level above the default level over 75%, the following message will appear:

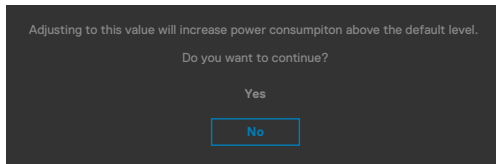

- When user selects “Yes”, the power message is displayed only once.
- When user select ‘No’, the power warning message will pop-up again.
- The power warning message will appear again only when the user does a Factory Reset from the OSD menu.



If either Thunderbolt (140W) / mDP / HDMI input is selected and the corresponding cable is not connected, a floating dialog box as shown below appears.

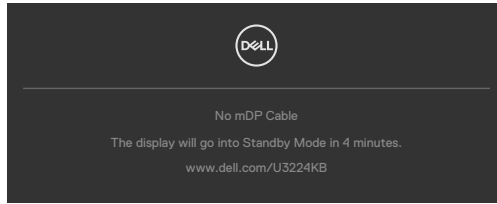

or

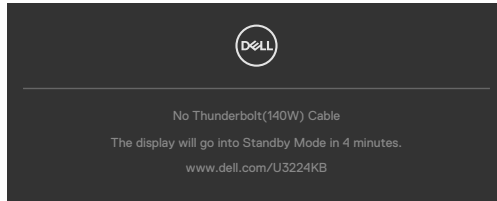

or

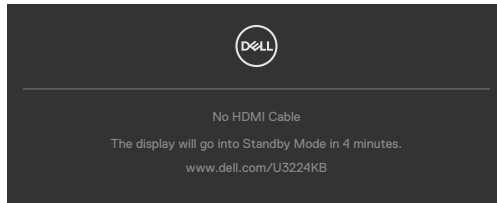

When the USB upstream cable is not connected, and you press the **Hookswitch/ Mute** button, the following message will appear:

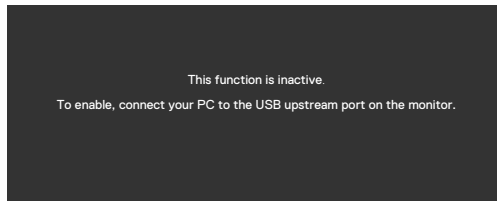

 **NOTE: For the Hookswitch/ Volume down/ Volume up/ Mute buttons to work, you need to connect the USB upstream cable (Type-A to Type-C or Thunderbolt™ 4) from the PC to the monitor.**

See [Troubleshooting](#) for more information.



Setting the maximum resolution



NOTE: The steps may vary slightly depending on the version of Windows you have.

To set the maximum resolution for the monitor:

In Windows 8.1:

1. For Windows 8.1, select the Desktop tile to switch to classic desktop.
2. Right-click on the desktop and click **Screen Resolution**.
3. If you have more than one monitor connected, ensure that you select **U3224KB**.
4. Click the **Screen Resolution** dropdown list and select **6144 x 3456**.
5. Click **OK**.

In Windows 10 and Windows 11:

1. Right-click on the desktop and click **Display Settings**.
2. If you have more than one monitor connected, ensure that you select **U3224KB**.
3. Click the **Display Resolution** dropdown list and select **6144 x 3456**.
4. Click **Keep changes**.

If you do not see **6144 x 3456** as an option, you must update your graphics driver to the latest version. Depending on your computer, complete one of the following procedures:

If you have a Dell desktop or laptop:

- Go to <https://www.dell.com/support>, enter your service tag, and download the latest driver for your graphics card.

If you are using a non-Dell computer (laptop or desktop):

- Go to the support site for your computer and download the latest graphic drivers.
- Go to your graphics card website and download the latest graphic drivers.



Setting up Windows Hello

In Windows® 10 / Windows® 11:

Click Windows start menu, click **Settings**.

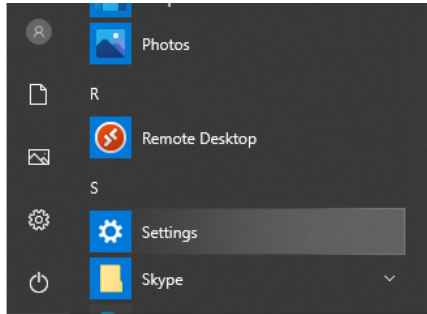

Click **Accounts**.

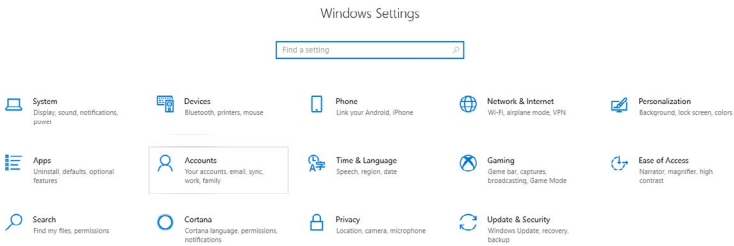

Click **Sign-in options**. You must set up a PIN before you can enroll in Windows Hello.

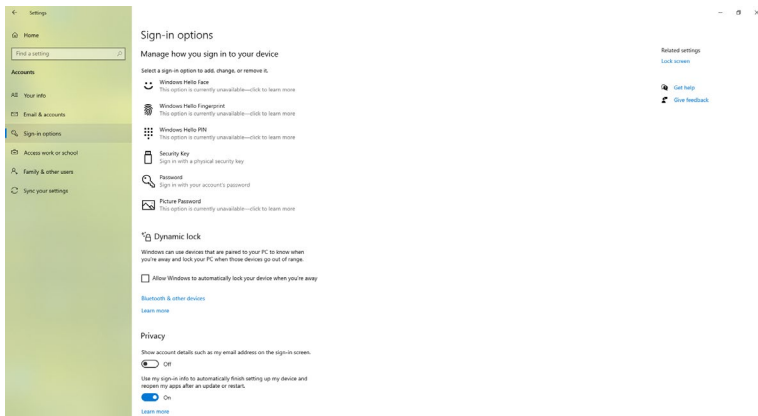

Click **Add** under **PIN** enter to **Set up a PIN**. Enter New PIN and Confirm PIN, and then click **OK**.

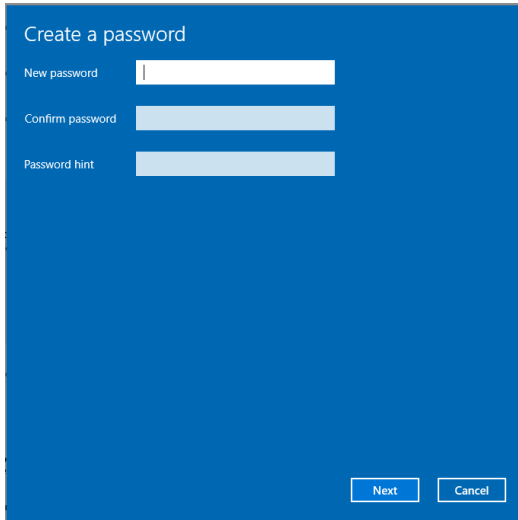

Once you've done that, the options to set up Windows Hello will unlock. Click **Set up** under **Windows Hello**, enter to **Windows Hello setup**.

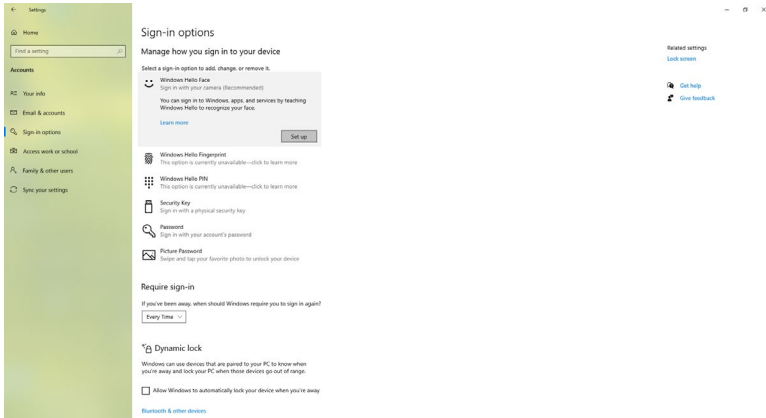

The following message is displayed, click **Get started**.

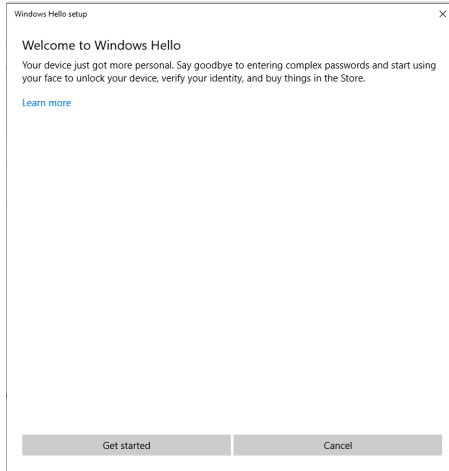

Keep looking directly at your screen and position yourself so that your face is in the center of the frame that appears on screen. The webcam will then register your face.

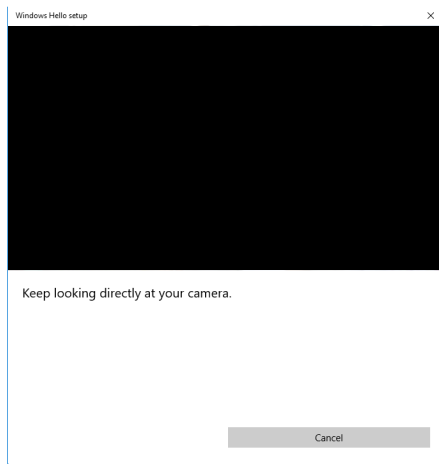

When the following message is displayed, click **Close** to exit **Windows Hello setup**.

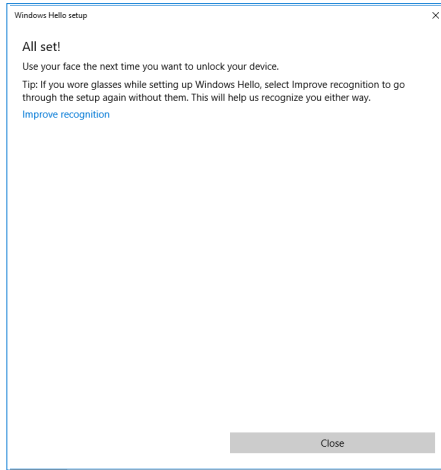

Once you have set up, you have another option to improve the recognition. Click **Improve recognition** if necessary.



Setting up the monitor webcam as default setting

When using a notebook with built-in webcam to connect this monitor, in the device manager interface, you can find the notebook built-in webcam and the monitor webcam. Normally, they are in enable status, and the default setting is using notebook built-in webcam.

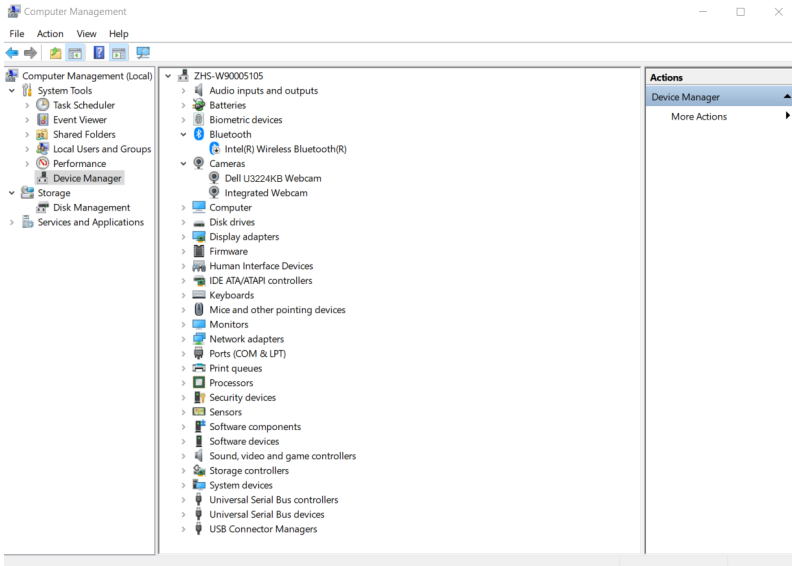

If you want to set up the monitor webcam as default setting, you need disable the notebook built-in webcam. To identify the notebook built-in webcam and disable it, please follow below instructions:

Right-click **Dell Monitor IR Webcam**, and click **Properties** to open the **Dell Monitor IR Webcam Properties**.

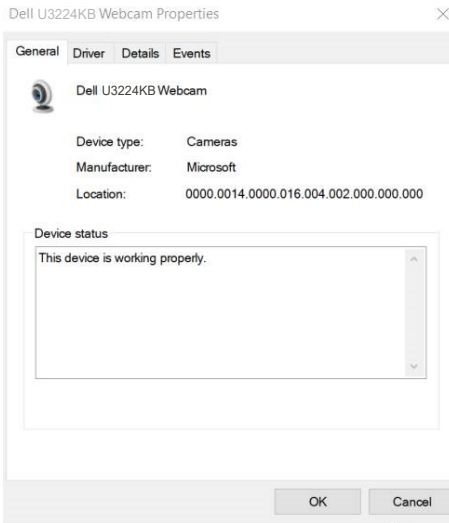
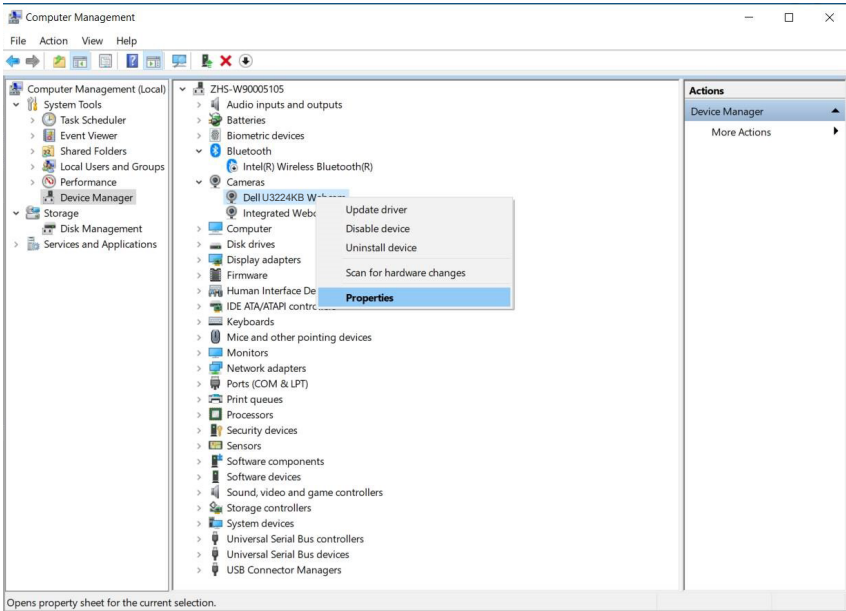

Click **Details > Property** and select **Hardware Ids**.

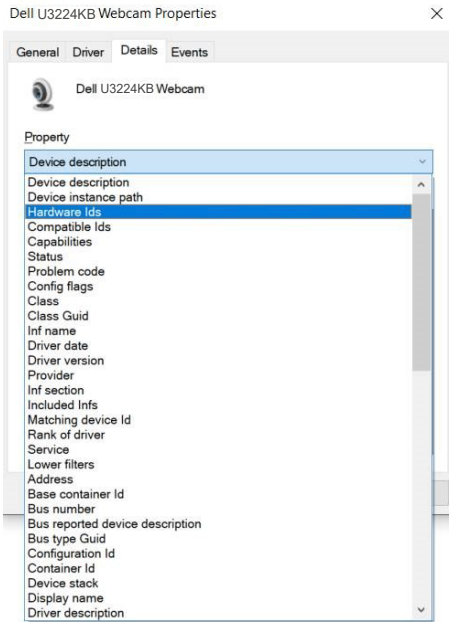

The **Value** will show the detail hardware ids of this Dell Monitor IR Webcam. The hardware ids of the notebook built-in webcam and the monitor webcam are different. For U3224KB, the monitor webcam hardware ids will show as below:

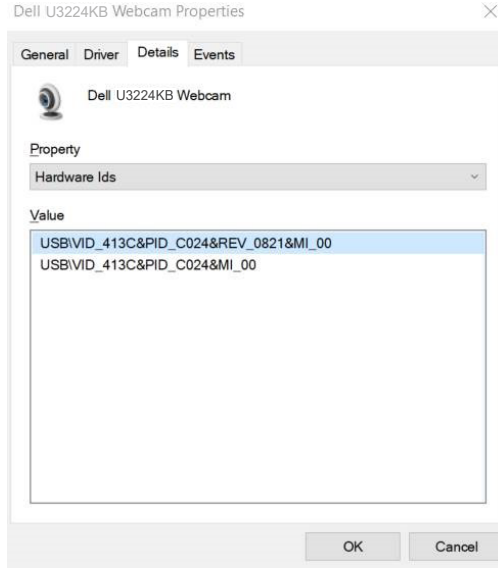

Right click the **PC/Notebook** webcam which has different hardware ids, and then click **Disable**.

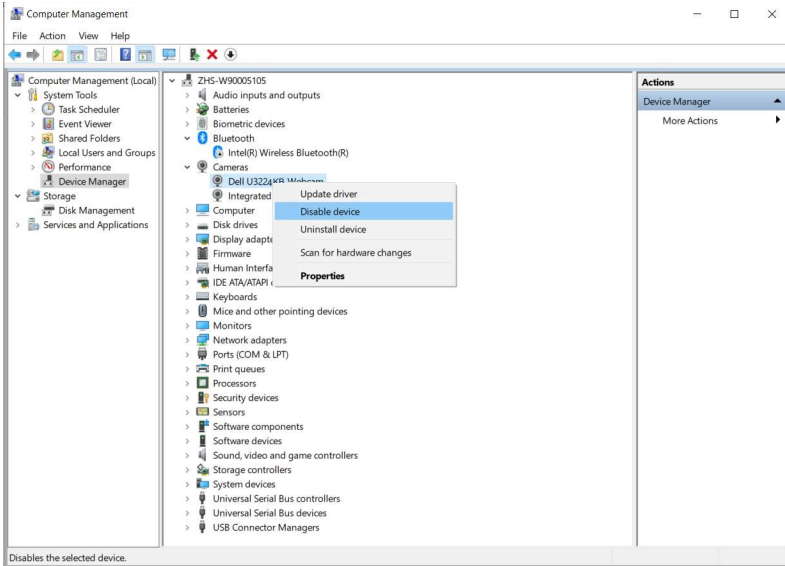

The following message is displayed:

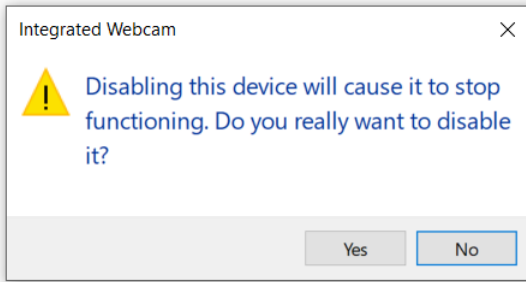

Click **Yes**. The notebook webcam is now disabled, and the monitor webcam will be used as the default setting. Restart the notebook.

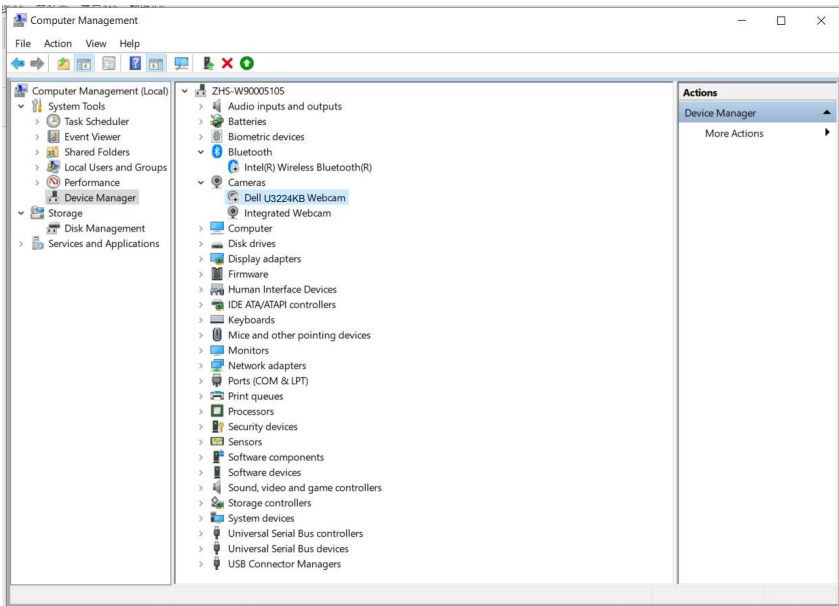

Setting up the monitor speaker as default setting

When your computer connects multiple speakers, if you want to set up the monitor speaker as default setting, please follow below instructions:

Right-click **Volume** in the Windows task bar notification area.



Click **Playback devices** enter to **Sound** setting interface.

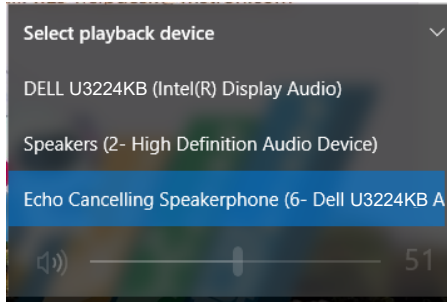

If only the HDMI or mDP cable is connected from your monitor to the computer, only one speaker named **DELL U3224KB** from the monitor will show in the **Sound** setting interface.

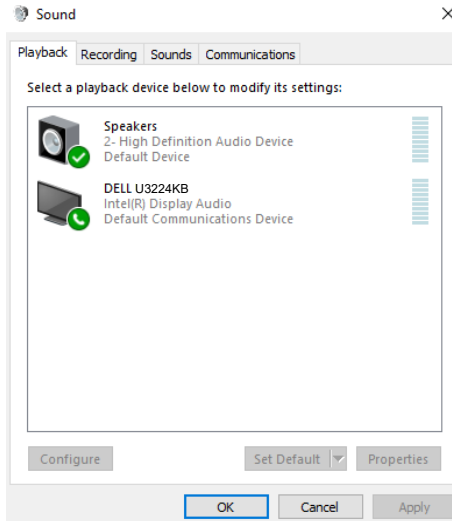

Click **DELL U3224KB**, and then click **Set Default**, the monitor speaker will be used as the default setting.

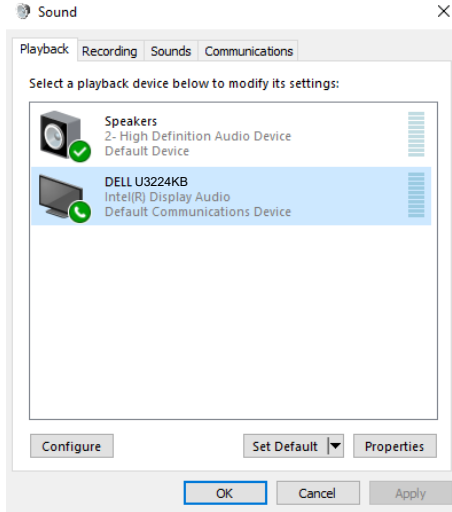

Click **OK** to exit the **Sound** setting.

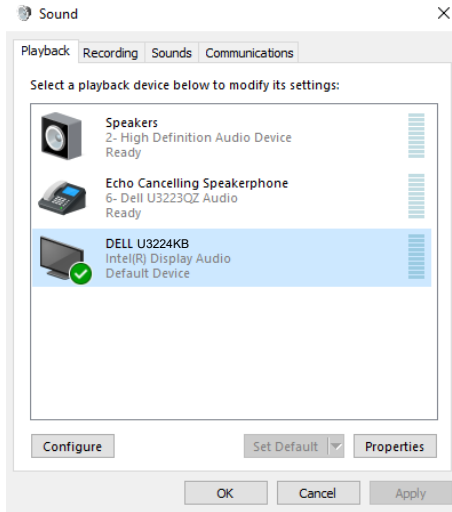

If the USB cable and the HDMI or mDP cable are connected from monitor to the computer, two audio paths named **DELL U3224KB** and **Echo Cancelling Speakerphone U3224KB** from the monitor will show in the **Sound** setting interface. The **U3224KB** monitor would show options for two audio paths supported in the monitor.



- **Echo Cancelling Speakerphone** audio path is where audio streams through USB. This is either through USB-C to USB-C cable or USB-A to USB-C cable. As the microphone path streams from monitor back to PC through USB, this selection is required for VoIP/UC conference applications. Audio Recording and Playback will work under this selection.
- **DELL U3224KB** audio path is where audio streams through HDMI/mDP alternate mode. Under this selection, there will not be microphone support. This selection is suitable for Audio Playback only.

Audio Playback performance would be the same for either audio path selection. Under normal Playback with USB-C to USB-C/USB-A to USB-C and/or for UC conference applications, default selecting the **Echo Cancelling Speakerphone** audio path is recommended.

NOTE: If you select **DELL U3224KB** audio path, please ensure that the **Echo Cancelling Speakerphone** volume is set to medium or high. Else, the **DELL U3224KB** maximum volume may sound soft because it is limited by the **Echo Cancelling Speakerphone** volume. For example, when the **Echo Cancelling Speakerphone** volume is at 50%, and the **DELL U3224KB** volume is set to 100% will have the same sound level as the former.

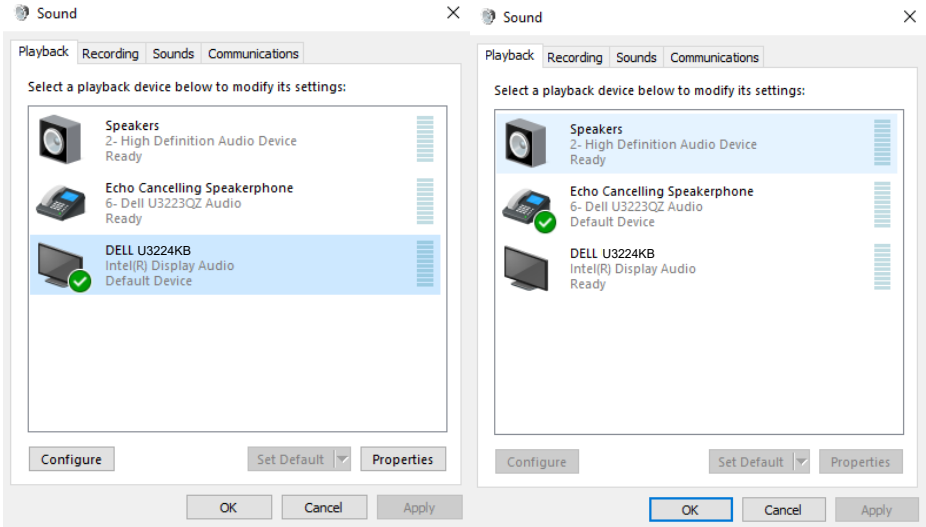

Troubleshooting

⚠ WARNING: Before you begin any of the procedures in this section, follow the **Safety Instructions**.

Self-test

Your monitor provides a self-test feature that allows you to check whether your monitor is functioning properly. If your monitor and computer are properly connected but the monitor screen remains dark, run the monitor self-test by performing the following steps:

1. Turn off both your computer and the monitor.
2. Unplug the video cable from the back of the computer. To ensure proper Self-Test operation, remove all digital and the analog cables from the back of computer.
3. Turn on the monitor.

The floating dialog box should appear on-screen (against a black background), if the monitor cannot sense a video signal and is working correctly. While in self-test mode, the power LED remains white. Also, depending upon the selected input, one of the dialogs shown below will continuously scroll through the screen.

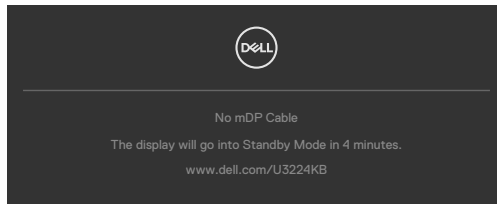

or

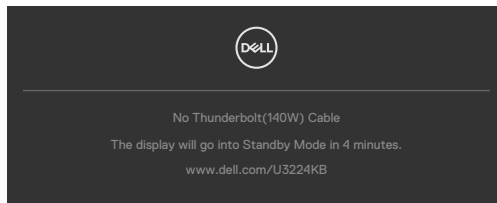

4. This message also appears during normal system operation if the video cable is disconnected or damaged.
5. Turn off your monitor and reconnect the video cable; then turn on both your computer and the monitor.

If your monitor screen remains blank after you use the previous procedure, check your video controller and computer, because your monitor is functioning properly.



Built-in diagnostics

Your monitor has a built-in diagnostic tool that helps you determine if the screen abnormality you are experiencing is an inherent problem with your monitor, or with your computer and video card.

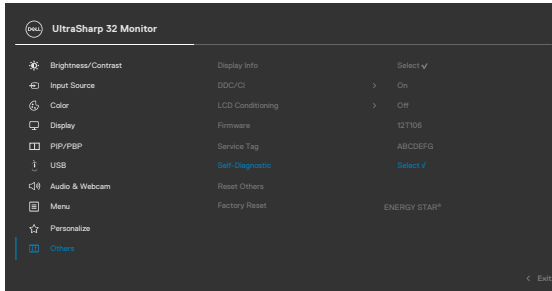

To run the built-in diagnostics:

1. Ensure that the screen is clean (no dust particles on the surface of the screen).
2. Press and hold Up or Down or Left or Right direction for four seconds until a menu appears on the screen.
3. Using the joystick control, highlight the Diagnostics  option and press the joystick button to start the diagnostics. A gray screen is displayed.
4. Observe if the screen has any defects or abnormalities.
5. Toggle the joystick once again until a red screen is displayed.
6. Observe if the screen has any defects or abnormalities.
7. Repeat steps 5 and 6 until the screen displays green, blue, black, and white colors. Note any abnormalities or defects.

The test is complete when a text screen is displayed. To exit, toggle the joystick control again.

If you do not detect any screen abnormalities upon using the built-in diagnostic tool, the monitor is functioning properly. Check the video card and computer.



Common Problems

The following table contains general information about common monitor problems you might encounter and the possible solutions:

Common Symptoms	What you experience	Possible solutions
No Video/ Power LED off	No picture	<ul style="list-style-type: none">• Ensure that the video cable connecting the monitor and the computer is properly connected and secure.• Verify that the power outlet is functioning properly using any other electrical equipment.• Ensure that the power button is depressed fully.• Ensure that the correct input source is selected in the Input Source menu.
No Video/ Power LED on	No picture or no brightness	<ul style="list-style-type: none">• Increase brightness and contrast controls via OSD.• Perform monitor self-test feature check.• Check for bent or broken pins in the video cable connector.• Run the built-in diagnostics.• Ensure that the correct input source is selected in the Input Source menu.
Missing Pixels	LCD screen has spots	<ul style="list-style-type: none">• Cycle power on-off.• Pixel that is permanently off is a natural defect that can occur in LCD technology.• For more information on Dell Monitor Quality and Pixel Policy, see Dell Support site at: https://www.dell.com/pixelguidelines.
Stuck-on Pixels	LCD screen has bright spots	<ul style="list-style-type: none">• Cycle power on-off.• Pixel that is permanently off is a natural defect that can occur in LCD technology.• For more information on Dell Monitor Quality and Pixel Policy, see Dell Support site at: https://www.dell.com/pixelguidelines.



Common Symptoms	What you experience	Possible solutions
Brightness Problems	Picture too dim or too bright	<ul style="list-style-type: none"> • Reset the monitor to factory settings. • Adjust brightness and contrast controls via OSD.
Safety Related Issues	Visible signs of smoke or sparks	<ul style="list-style-type: none"> • Do not perform any troubleshooting steps. • Contact Dell immediately.
Intermittent Problems	Monitor malfunctions on & off	<ul style="list-style-type: none"> • Ensure that the video cable connecting the monitor to the computer is connected properly and is secure. • Reset the monitor to factory settings. • Perform monitor self-test feature check to determine if the intermittent problem occurs in self-test mode.
Missing Color	Picture missing color	<ul style="list-style-type: none"> • Perform monitor self-test. • Ensure that the video cable connecting the monitor to the computer is connected properly and is secure. • Check for bent or broken pins in the video cable connector.
Wrong Color	Picture color not good	<ul style="list-style-type: none"> • Change the settings of the Preset Modes in the Color menu OSD depending on the application. • Adjust R/G/B value under Custom Color in Color menu OSD. • Change the Input Color Format to PC RGB or YPbPr in the Color menu OSD. • Run the built-in diagnostics.
Image retention from a static image left on the monitor for a long period of time	Faint shadow from the static image displayed appears on the screen	<ul style="list-style-type: none"> • Set the screen to turn off after a few minutes of screen idle time. These can be adjusted in Windows Power Options or Mac Energy Saver setting. • Alternatively, use a dynamically changing screensaver.



Common Symptoms	What you experience	Possible solutions
Mic/Webcam does not work	<ul style="list-style-type: none"> • USB cable not plugged in or correct USB source not selected • Monitor Mic/webcam is not set as the default device 	<ul style="list-style-type: none"> • Plug in the USB Cable (Type-A to Type-C or Thunderbolt™ 4), and if you connect both USB-C port, please switch the USB source in the OSD menu. • Select the monitor Mic/webcam as the default in the PC side. • Touch the Mic button and make sure the Mic mute LED is dark.
TBT cannot display	TBT out port connect the 2nd Monitor cannot display but the display setting can recognize 2 monitor	<ul style="list-style-type: none"> • Open the display setting in NB/PC,if you can see both monitor,then you can reduce the 2nd Monitor resolution. • Open OSD in Monitor,Go to OSD menu, under Input Source selection, press and hold TBT select joystick key for 8 seconds to change the monitor setting from HBR3 to HBR2.
Webcam Video flickering	Experience a visible webcam video flickering	<ul style="list-style-type: none"> • In some situations, you may experience a visible webcam video flickering that is caused by interference from some conventional fluorescent lamps. • If you experience this issue, please download Dell Peripheral Manager (for PC) / Dell Display & Peripheral Manager (for Mac) software. In Dell Display & Peripheral Manager / Dell Peripheral Manager, go to “Color and Image > Anti Flicker” and select the frequency option, 50Hz or 60Hz, that presents no flickering. • You can also adjust the tilt or placement of the webcam away from any fluorescent lamp.
Power DVD can't play normally when using mDP port	Connect mDP cable with source and monitor, play power DVD, and power DVD can't play and display error	<ul style="list-style-type: none"> • Go to OSD menu under input source selection, press and hold mDP joystick middle key for 8 seconds to switch DP1.4.



Common Symptoms	What you experience	Possible solutions
The monitor cannot detect signal connect with dock after AC/DC Off/On, cable unplug/ Plug	Connect the Dock USB-C cable to platform. Connect DUT with TBT4 cable to the Dock USB-C port. The monitor cannot detect the signal after AC Off/On TBT4 cable Unplug/ Plug	<ul style="list-style-type: none"> • Connect the monitor directly with platform. • Change the TBT4 cable to USB-C cable.
The two monitor maximum resolution can't reach 6144*3456 @60hz when TBT Daisy Chain	Connect 1st DUT with TBT4 cable to the platform. Connect 2nd DUT to the 1st DUT Thunderbolt™ out port with TBT4 cable. The 2nd monitor or 1st monitor can't reach 6144*3456@60hz	<ul style="list-style-type: none"> • Open OSD in Monitor.Go to OSD menu, under Input Source selection, press and hold TBT select joystick key for 8 seconds to change the monitor setting from HBR3 to HBR2. The two monitor need do this setting.
2nd monitor shows black screen when TBT daisy chain and enable SmartHDR on both OSD and Windows display setting	Connect 1st DUT with TBT4 cable to the platform. Connect 2nd DUT to the 1st DUT Thunderbolt™ out port with TBT4 cable. Set both DUT to the maximum resolution (6144x3456). Enable SmartHDR on both OSD and Windows display setting. 2nd monitor shows black screen	<ul style="list-style-type: none"> • Intel UHD graphic limitation, suggest use Intel Iris graphic. • Disable SmartHDR on both OSD and Windows display setting.



Common Symptoms	What you experience	Possible solutions
The monitor cannot detect signal on mDP after video cable unplug/plug, sleep/wake, hibernate/wake	Connect mDP cable with source and monitor, the monitor can't detect signal	<ul style="list-style-type: none"> • Go to OSD menu under input source selection, press and hold mDP joystick middle key for 8 seconds to switch DP1.4.
Platform hangs on mDP when wake up the platform from sleep	Connect DUT with mDP cable to the platform. Do a Platform Sleep/Wake. Platform will hang	<ul style="list-style-type: none"> • If your platform is DP1.4 graphic card and suggest to go to OSD menu under input source selection, press and hold mDP joystick middle key for 8 seconds to switch DP1.4.
Auto source can't automatically switch to mDP input source when you connect the mDP cable to platform	When you connect the HDMI cable and mDP cable to monitor, connect HDMI cable to platform and display normally, then connect mDP cable to platform. The signal can't automatically to mDP signal	<ul style="list-style-type: none"> • Unplug and plug the mDP cable from monitor side. • Go to OSD menu and enter input source select mDP manually.



Product specific problems

Problem	What you experience	Possible solutions
Screen image is too small	Image is centered on screen, but does not fill entire viewing area	<ul style="list-style-type: none">• Check the Aspect Ratio setting in the Display menu OSD.• Reset the monitor to factory settings.
Cannot adjust the monitor with the joystick control on the rear of the monitor	OSD does not appear on the screen	<ul style="list-style-type: none">• Turn off the monitor, unplug the monitor power cable, plug it back, and then turn on the monitor.
No Input Signal when user controls are pressed	No picture, the LED light is white	<ul style="list-style-type: none">• Check the signal source. Ensure the computer is not in the power saving mode by moving the mouse or pressing any key on the keyboard.• Check whether the signal cable is plugged in properly. Connect the signal cable again, if necessary.• Reset the computer or video player.
The picture does not fill the entire screen	The picture cannot fill the height or width of the screen	<ul style="list-style-type: none">• Due to different video formats (aspect ratio) of DVDs, the monitor may display in full screen.• Run the built-in diagnostics.
No image when using DP connection to the PC	Blank screen	<ul style="list-style-type: none">• Verify which DP standard is your Graphics Card certified to. Download and install the latest graphics card driver.• Some DP 1.4 graphics card cannot support DP 2.0 monitors. Go to OSD menu, under Input Source selection, press and hold mDP select joystick key for 8 seconds to change the monitor setting from DP 2.0 to DP 1.4.



Problem	What you experience	Possible solutions
No image when using Thunderbolt™ 4 connection to computer, laptop, and so on	Blank screen	<ul style="list-style-type: none"> • Verify if the Thunderbolt™ 4 interface of the device can support DP alternate mode. • Verify if the device required more than EPR 140W power charging. • Thunderbolt™ 4 interface of device cannot support DP alternate mode. • Set Windows to Projection mode. • Ensure that the Thunderbolt™ 4 cable is not damaged.
No charging when using Thunderbolt™ 4 connection to computer, laptop, and so on	No charging	<ul style="list-style-type: none"> • Verify if the device can support one of 5 V/9 V/15 V/20 V/28 V charging profiles. • Verify if the Notebook requires a >EPR 140W power adaptor. • If the Notebook requires a >EPR 140W power adaptor, it may not charge with the Thunderbolt™ 4 connection. • Ensure that you use only Dell approved adapter or the adapter that comes with the product. • Ensure that the Thunderbolt™ 4 cable is not damaged.
Intermittent charging when using Thunderbolt™ 4 connection to computer, laptop, and so on	Intermittent charging	<ul style="list-style-type: none"> • Check if the maximum power consumption of device is over EPR 140W. • Ensure that you use only Dell approved adapter or the adapter that comes with the product. • Ensure that the Thunderbolt™ 4 cable is not damaged.
No image when using TBT	Blank screen or 2nd DUT is not Prime mode	<ul style="list-style-type: none"> • Thunderbolt™ 4 input, Go to OSD menu, under Input Source selection, press and hold Thunderbolt(140W) select joystick key for 8 seconds to change the monitor setting from HBR3 to HBR2. The two monitor need do this setting.
No network connection	Network dropped or Intermittent	<ul style="list-style-type: none"> • Do not toggle Off/On the power button when network is connected, keeps the power button On.



Problem	What you experience	Possible solutions
The LAN port is not functioning	OS setting or cable connection issue	<ul style="list-style-type: none"> • Ensure that the latest BIOS and drivers for your computer are installed on your computer. • Ensure that the RealTek 2.5G Ethernet Controller is installed in the Windows Device Manager. • If your BIOS Setup has a LAN/GBE Enabled/ Disabled option, make sure it is set to Enabled. • Ensure that the Ethernet cable is connected securely on the monitor and the hub/router/ firewall. • Check the status LED of the Ethernet cable to confirm connectivity. Re-connect both ends of the Ethernet cable if the LED is not lit. • First power off the Computer and unplug the Thunderbolt™ 4 cable and power cord of the monitor. Then, power on the computer, plug in the monitor power cord and Thunderbolt™ 4 cable.
Monitor buttons (Mute / Volume down / Volume up / Hookswitch) not working with Microsoft Teams® App	Monitor buttons (Mute / Volume down / Volume up / Hookswitch) not working on Microsoft Teams® App with Chrome OS / Ubuntu	<p>Use Microsoft Teams® App to perform the below tasks:</p> <ul style="list-style-type: none"> • Call Icon to accept / hang up call • Volume down / Volume up adjustment • Mic mute / unmute • Video on / off
Video recording not working	Video recording App not working with Win 7	<ul style="list-style-type: none"> • Windows 7 not support • Switch to Windows 10 / Windows 11



Problem	What you experience	Possible solutions
When press either Volume down / Volume up or Mute button, LED does not blink	When press either Volume down / Volume up or Mute button, LED not blink when connected to HDMI or DP only	Connect USB-A to USB-C cable
Webcam or Mic not working	Webcam or Mic not working when connected to HDMI or DP only	Connect USB-A to USB-C cable
Ethernet port (RJ45) cannot connect to internet	Ethernet port (RJ45) cannot connect to internet on Win 10 / Win 11	Change the LAN Controller Power Saving from Enable to Disable
No sound coming from the speakers	No sound coming from the speakers when play audio/video on your system	<ul style="list-style-type: none"> • Ensure that you have set the default playback device as Echo Cancelling Speakerphone U3224KB or DELL U3224KB on your system. • Turn Off the monitor, unplug the monitor power cord, replug it, and then turn on the monitor. • Reset the monitor to Factory Settings.



Problem	What you experience	Possible solutions
Speaker volume is low / sounds soft	Speaker volume is low / sounds soft when speaker option is DELL U3224KB in Sound setting interface	<ul style="list-style-type: none"> · Increase the speaker volume of DELL U3224KB to maximum in the Sound setting interface · Press the Volume Up button to increase the speaker volume of DELL U3224KB · If you select DELL U3224KB audio path, please ensure that the Echo Cancelling Speakerphone volume is set to medium or high. Else, the DELL U3224KB maximum volume may sound soft because it is limited by the Echo Cancelling Speakerphone volume. For example, when the Echo Cancelling Speakerphone volume is at 50%, and the DELL U3224KB volume is set to 100% will have the same sound level as the former.
Webcam is not detected	Webcam is not detected in the Windows Device Manager	<ul style="list-style-type: none"> · Ensure that the USB upstream cable is connected between the monitor and the computer or notebook. · Ensure that the USB is assigned to the port to which the USB cable is plugged in to. · Reconnect the USB upstream cable to the computer or notebook.
Webcam cannot connect / Webcam disconnected	Could not detect Monitor camera / Could not switch back to the PC camera	<ul style="list-style-type: none"> · Reset the monitor to Factory Settings. · Turn Off the monitor, unplug the monitor power cord, replug it, and then turn On the monitor. · Select the Monitor camera again in the Camera / Video setting of your UC conference application.



Problem	What you experience	Possible solutions
Microphone is muted	Microphone is muted in the Windows Device Manager	<ul style="list-style-type: none"> • Ensure that the USB upstream cable is connected between the monitor and the computer or notebook. • Ensure that the USB is assigned to the port to which the USB cable is plugged in to. • Reconnect the USB upstream cable to the computer or notebook. • Ensure that the microphone is enabled/unmuted on the monitor. If the microphone mute LED is lighting up in static red (indicates microphone muted), press the microphone button to unmute the microphone. • Ensure that the monitor's microphone is selected and enabled/unmuted on the setting in the UC application.
Microphone volume is low / sounds soft	Microphone volume is low / sounds soft to the other participant when in audio/video call	<ul style="list-style-type: none"> • Ensure the Mute button's LED will go dark (indicates microphone unmuted). • Adjust the distance between the user and the microphone. The user should avoid sitting too far away from the microphone. The most optimum distance between the user and the microphone is 70 cm. • Ensure that the monitor's microphone is selected and enabled/unmuted on the setting in the UC application. • Increase the microphone volume in the Sound setting interface at the PC side / in the UC application.
Front buttons don't work	No response on the UC application when press on the buttons located on the speaker	<ul style="list-style-type: none"> • Ensure that the USB upstream cable (Type-A to Type-C or Thunderbolt™ 4) is connected from the PC to the monitor. • Ensure that the USB is assigned to the port to which the USB cable is plugged in to. • For some UC platforms / applications, the Mute function works by pressing the Mute button, but the Mute Icon on the UC platform is not sync (Icon shows unmute).



Problem	What you experience	Possible solutions
Webcam image looks over-exposed	Webcam image shows over-exposed background	<ul style="list-style-type: none"> • Adjust the environment lighting condition. • Ensure the monitor is setup at a well-lighted environment, preferably under ceiling lights. The user should avoid a dim / dark background. The user should avoid direct facing a window with bright sunlight. • Alternatively, you may use Dell Peripheral Manager to adjust the webcam setting of color.
Webcam image looks grainy / dark	Webcam image appears grainy / dark	<ul style="list-style-type: none"> • Adjust the environment lighting condition. Ensure the monitor is setup at a well lighted environment, preferably under ceiling lights. The user should avoid a dim environment.
Webcam image looks blurry	Webcam image appears blurry / not clear.	<ul style="list-style-type: none"> • Use a clean and slightly damp cloth to wipe the surface of the front webcam. • Adjust the distance between the user and the camera. The user should avoid sitting too far away from the camera. The most optimum distance between the user and the camera is 70 cm.
Teams Microphone volume	Teams Microphone volume is smaller than Zoom	<ul style="list-style-type: none"> • This is normal behavior as the volume specifications are different between Teams and Zoom.
Teams/Zoom small window distorted	Teams/Zoom small window image distorted	<ul style="list-style-type: none"> • This is normal behavior. The resolution of the small images are compressed when the main image is in high resolution (4K). If a lower resolution (720P & 1080P) is selected, there will not be any difference between the images.
Image quality poor	The image quality of the monitor was poor	<p>Always poor:</p> <ul style="list-style-type: none"> • Check that your computer is USB 3.0-capable. • Some computers have USB 3.0, USB 2.0, and USB 1.1 ports. Ensure that the correct USB port is used. <p>Sometime poor:</p> <ul style="list-style-type: none"> • Network will affect the image quality, ensure your network is fine.



Problem	What you experience	Possible solutions
Tof no function	Presence detection/wake-up not working	<ul style="list-style-type: none">· When using Teams/Zoom call, the wake up function not working is normal.· It works when a user is not using Teams/Zoom.



Microsoft® Teams® / Skype for Business® specific problems

Problem	What you experience	Possible solutions
The Hookswitch button is not working	Short press on the Hookswitch button does not answer call	<ul style="list-style-type: none"> • Ensure that the USB upstream cable (Type-A to Type-C or Thunderbolt™ 4) is connected from the PC to the monitor. • Ensure that the Teams account is provisioned / setup as 'Teams Only' mode. The tenant administrator should enable the account to 'Teams Only' mode.
The Mute button is not working	Press on the Mute button does not mute and unmute microphone	<ul style="list-style-type: none"> • Ensure that the USB upstream cable (Type-A to Type-C or Thunderbolt™ 4) is connected from the PC to the monitor. • Ensure that the Mute button's LED will go dark (indicates microphone unmuted). • Ensure that the Teams account is provisioned / setup as 'Teams Only' mode. The tenant administrator should enable the account to 'Teams Only' mode.
Webcam no image	Webcam no image when using Skype for Business (SfB)	<ul style="list-style-type: none"> • Ensure that the USB upstream cable (Type-A to Type-C or Thunderbolt™ 4) is connected from the PC to the monitor. • Select 'DELL Monitor RGB Webcam' as the camera in Skype Video Device setting.
Webcam being occupied	Webcam being occupied and can't be used	<ul style="list-style-type: none"> • Avoid running multiple conference applications at the same time. While you are using 'conference software A', close the other 'conference software B'.



Universal Serial Bus (USB) specific problems

Specific Symptoms	What you experience	Possible solutions
USB interface is not working	USB peripherals are not working	<ul style="list-style-type: none">• Check that your display is turned ON.• Reconnect the upstream cable to your computer.• Reconnect the USB peripherals (downstream connector).• Turn off the monitor and turn it on again.• Reboot the computer.• Certain USB devices such as portable hard drives require higher power source; connect the drive to the computer directly.
super speed USB 3.2 Gen 2 interface is slow.	super speed USB 3.2 Gen 2 peripherals working slowly or not working at all	<ul style="list-style-type: none">• Check that your computer is USB 3.0-capable.• Some computers have USB 3.0, USB 2.0, and USB 1.1 ports. Ensure that the correct USB port is used.• Reconnect the upstream cable to your computer.• Reconnect the USB peripherals (downstream connector).• Reboot the computer.
Wireless USB peripherals stop working when a USB 3.0 device is plugged in	Wireless USB peripherals responding slowly or only working as the distance between itself and its receiver decreases	<ul style="list-style-type: none">• Increase the distance between the USB 3.0 peripherals and the wireless USB receiver.• Position your wireless USB receiver as close as possible to the wireless USB peripherals.• Use a USB-extender cable to position the wireless USB receiver as far away as possible from the USB 3.0 port.



Appendix

FCC notices (U.S. only) and other regulatory information

For FCC notices and other regulatory information, see the regulatory compliance website located at https://www.dell.com/regulatory_compliance.

Contacting Dell

For customers in the United States, call 800-WWW-DELL (800-999-3355).

 **NOTE: If you do not have an active Internet connection, you can find contact information on your purchase invoice, packing slip, bill, or Dell product catalog.**

Dell provides several online and telephone-based support and service options. Availability varies by country and product, and some services may not be available in your area.

To get online Monitor support content:

See <https://www.dell.com/support/monitors>.

To contact Dell for sales, technical support, or customer service issues:

1. Go to <https://www.dell.com/support>.
2. Verify your country or region in the Choose A Country/Region drop-down menu at the bottom-right corner of the page.
3. Click Contact Us next to the country dropdown.
4. Select the appropriate service or support link based on your need.
5. Choose the method of contacting Dell that is convenient for you.

