



PE200S Series

Desktop PC

User Manual



E16671

Revised Edition V2

June 2020

COPYRIGHT INFORMATION

No part of this manual, including the products and software described in it, may be reproduced, transmitted, transcribed, stored in a retrieval system, or translated into any language in any form or by any means, except documentation kept by the purchaser for backup purposes, without the express written permission of ASUSTeK COMPUTER INC. ("ASUS").

ASUS PROVIDES THIS MANUAL "AS IS" WITHOUT WARRANTY OF ANY KIND, EITHER EXPRESS OR IMPLIED, INCLUDING BUT NOT LIMITED TO THE IMPLIED WARRANTIES OR CONDITIONS OF MERCHANTABILITY OR FITNESS FOR A PARTICULAR PURPOSE. IN NO EVENT SHALL ASUS, ITS DIRECTORS, OFFICERS, EMPLOYEES OR AGENTS BE LIABLE FOR ANY INDIRECT, SPECIAL, INCIDENTAL, OR CONSEQUENTIAL DAMAGES (INCLUDING DAMAGES FOR LOSS OF PROFITS, LOSS OF BUSINESS, LOSS OF USE OR DATA, INTERRUPTION OF BUSINESS AND THE LIKE), EVEN IF ASUS HAS BEEN ADVISED OF THE POSSIBILITY OF SUCH DAMAGES ARISING FROM ANY DEFECT OR ERROR IN THIS MANUAL OR PRODUCT.

Products and corporate names appearing in this manual may or may not be registered trademarks or copyrights of their respective companies, and are used only for identification or explanation and to the owners' benefit, without intent to infringe.

SPECIFICATIONS AND INFORMATION CONTAINED IN THIS MANUAL ARE FURNISHED FOR INFORMATIONAL USE ONLY, AND ARE SUBJECT TO CHANGE AT ANY TIME WITHOUT NOTICE, AND SHOULD NOT BE CONSTRUED AS A COMMITMENT BY ASUS. ASUS ASSUMES NO RESPONSIBILITY OR LIABILITY FOR ANY ERRORS OR INACCURACIES THAT MAY APPEAR IN THIS MANUAL, INCLUDING THE PRODUCTS AND SOFTWARE DESCRIBED IN IT.

Copyright © 2020 ASUSTeK COMPUTER INC. All Rights Reserved.

LIMITATION OF LIABILITY

Circumstances may arise where because of a default on ASUS' part or other liability, you are entitled to recover damages from ASUS. In each such instance, regardless of the basis on which you are entitled to claim damages from ASUS, ASUS is liable for no more than damages for bodily injury (including death) and damage to real property and tangible personal property; or any other actual and direct damages resulted from omission or failure of performing legal duties under this Warranty Statement, up to the listed contract price of each product.

ASUS will only be responsible for or indemnify you for loss, damages or claims based in contract, tort or infringement under this Warranty Statement.

This limit also applies to ASUS' suppliers and its reseller. It is the maximum for which ASUS, its suppliers, and your reseller are collectively responsible.

UNDER NO CIRCUMSTANCES IS ASUS LIABLE FOR ANY OF THE FOLLOWING: (1) THIRD-PARTY CLAIMS AGAINST YOU FOR DAMAGES; (2) LOSS OF, OR DAMAGE TO, YOUR RECORDS OR DATA; OR (3) SPECIAL, INCIDENTAL, OR INDIRECT DAMAGES OR FOR ANY ECONOMIC CONSEQUENTIAL DAMAGES (INCLUDING LOST PROFITS OR SAVINGS), EVEN IF ASUS, ITS SUPPLIERS OR YOUR RESELLER IS INFORMED OF THEIR POSSIBILITY.

SERVICE AND SUPPORT

Visit our multi-language web site at <https://www.asus.com/support/>

Contents

About this manual.....	6
Conventions used in this manual.....	7
Typography.....	7
Package contents	8

Chapter 1: Getting to know your Edge Computer

1.1 Features	12
1.1.1 Front view	12
1.1.2 Rear view.....	15
1.2 Motherboard Overview	17
1.2.1 Motherboard layout.....	17
1.2.2 System memory.....	19
1.2.3 Onboard jumpers.....	20
1.2.4 Internal connectors	22

Chapter 2: Using your Edge Computer

2.1 Getting started.....	36
2.1.1 Connect the AC power adapter to your Edge Computer	36
2.1.2 Connect a display panel to your Edge Computer	38
2.1.3 Connect the USB cable from keyboard or mouse.....	40
2.1.4 Turn on your Edge Computer	41
2.2 Turning your Edge Computer off.....	42
2.3 Putting your Edge Computer to sleep.....	42

Chapter 3: Upgrading your Edge Computer

3.1	Removing the bottom cover	44
3.2	Replacing the bottom cover	45
3.3	Installing memory modules	46
3.4	Installing 2.5" storage device	47
3.5	Installing the Mini PCIe card.....	49
3.6	Installing a nano SIM card	50
3.7	Installing an SD card.....	51
3.8	Installing the wireless card	53
3.9	Installing an M.2 SSD.....	54
3.10	Installing the antennas (optional).....	55
3.11	Installing the USB 2.0 module (on selected models).....	56
3.12	Installing the Serial port module (on selected models).....	57
3.13	Installing the PoE LAN module (on selected models).....	58
3.14	Installing the VESA mount (optional).....	60
3.15	Installing the wall mount.....	62

Chapter 4: BIOS Setup

4.1	Getting to know your BIOS	64
4.2	BIOS setup program	65
4.3	Main Menu.....	67
4.3.1	System Date [Day xx/xx/xxxx].....	67
4.3.2	System Time [xx:xx:xx].....	67
4.4	Advanced menu	68
4.4.1	Trusted Computing	69
4.4.2	PCH Storage Configuration	71
4.4.3	Onboard Devices Configuration.....	73
4.4.4	ACPI Settings	75
4.4.5	APM Configuration	76

4.4.6	SMART Settings.....	77
4.4.7	NCT6116D Super IO Configuration.....	77
4.4.8	NCT6116D HW Monitor	79
4.4.9	Serial Port Console Redirection.....	79
4.4.10	CPU Configuration.....	83
4.4.11	AMI Graphic Output Protocol Policy	87
4.4.12	PCI Subsystem Settings	87
4.4.13	USB Configuration	88
4.4.14	Network Stack Configuration	90
4.4.15	SDIO Configuration	91
4.4.16	Platform Trust Technology	91
4.4.17	Security Configuration	92
4.4.18	Thermal.....	92
4.5	Security	94
4.6	Boot menu	97
4.7	Save & Exit menu	101
4.8	Updating your BIOS.....	102
4.8.1	ASUS CrashFree BIOS 3 utility.....	102
4.8.2	ASUS EzFlash Utility.....	103
4.8.3	BUPDATER utility	105

Appendix

Safety information.....	108
Setting up your system.....	108
Care during use.....	109
Regulatory notices	110
ASUS contact information.....	117

About this manual

This manual provides information about the hardware and software features of your Edge Computer, organized through the following chapters:

Chapter 1: Getting to know your Edge Computer

This chapter details the hardware components of your Edge Computer.

Chapter 2: Using your Edge Computer

This chapter provides you with information on using your Edge Computer.

Chapter 3: Upgrading your Edge Computer

This chapter provides you with information on how to upgrade the memory modules, wireless modules, and hard disk drive / solid state drive of your Edge Computer.

Chapter 4: BIOS Setup

This chapter tells how to change system settings through the BIOS Setup menus. Detailed descriptions of the BIOS parameters are also provided.

Appendix

This section includes notices and safety statements your Edge Computer.

Conventions used in this manual

To highlight key information in this manual, some text are presented as follows:

IMPORTANT! This message contains vital information that must be followed to complete a task.

NOTE: This message contains additional information and tips that can help complete tasks.

WARNING! This message contains important information that must be followed to keep you safe while performing certain tasks and prevent damage to your Edge Computer's data and components.

Typography

Bold text

Indicates a menu or an item to select.

Italic

This indicates sections that you can refer to in this manual.

Package contents

Your Edge Computer package contains the following items:

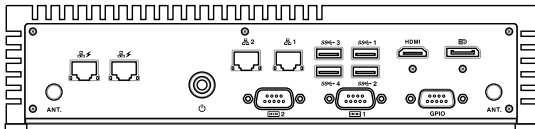

PE2005 Series



AC power adapter*



Power cord*

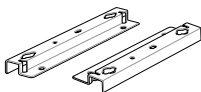

Wall mount kit

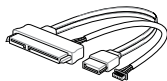

SATA and power cable

NOTE:

- *The bundled power adapter may vary by model and territories.
 - Some bundled accessories may vary with different models. For details on these accessories, refer to their respective user manuals.
 - The device illustration is for reference only. Actual product specifications may vary with models.
 - If the device or its components fail or malfunction during normal and proper use within the warranty period, bring the warranty card to the ASUS Service Center for replacement of the defective components.
-

1

***Getting to know your Edge
Computer***

1.1 Features

1.1.1 Front view

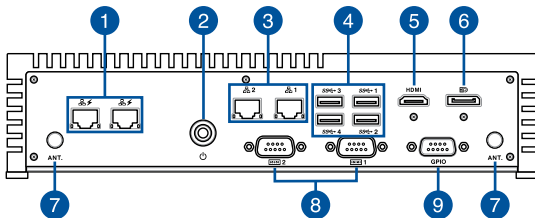

1 LAN port with PoE (on selected models)

The 8-pin RJ-45 LAN port supports a standard Ethernet cable for 10/100/1000 Mbps connection to a local network, and supports Power over Ethernet (PoE). The PoE LAN module supports up to 15W per port for powering and complies with IEEE802.3af and CSMA/CD standards

2 Power button

The power button allows you to turn the Edge Computer on or off. You can use the power button to put your Edge Computer to sleep mode or press it for four (4) seconds to force shutdown your Edge Computer.

3 LAN port

The Intel I210-AT Gigabit Ethernet controllers with 8-pin RJ-45 LAN port supports a standard Ethernet cable for connection to a local network.

4 USB 3.2 Gen 1 port

The USB 3.2 Gen 1 (Universal Serial Bus) port provides a transfer rate up to 5 Gbit/s.

5 HDMI **HDMI port**

The integrated 19-pin HDMI (High Definition Multimedia Interface) 1.4b port with a receptacle connector can support resolutions up to 3840 x 2160 @ 30 Hz on external display devices.

6 **Dual-mode DisplayPort**

The 20-pin DisplayPort 1.2 port can support resolutions up to 4096 x 2160 @ 60 Hz on external display devices, and supports DVI or HDMI adapters.

7 **ANT.** **Antenna hole**

The antenna hole allows you to connect a wireless antenna to enhance wireless signal reception.

8 **Serial (COM) connector**

The 9-pin RS232/422/485 serial (COM) connector allows you to connect devices that have serial ports such as bar code scanner, modem, or printers. Please refer to the table below for the pin definitions of the different COM connectors.

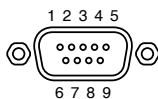

Pin	RS-232	RS-422	RS485
1	DCD#	TX-	D-
2	RXD	TX+	D
3	TXD	RX+	NA
4	DTR	RX-	NA
5	GND	GND	GND
6	DSR	NA	NA
7	RTS	NA	NA
8	CTS	NA	NA
9	RI	NA	NA

9

GPIO **GPIO connector**

The 9-pin GPIO (General-purpose Input/Output) connector allows you to program it for input or output use, such as lighting control, door control or alarm control. Please refer to the table below for the pin definition of the GPIO connector.

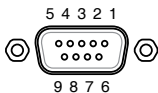

Pin	GPIO
1	DIO_0
2	DIO_4
3	DIO_1
4	DIO_5
5	DIO_2
6	DIO_6
7	DIO_3
8	DIO_7
9	GND

1.1.2 Rear view

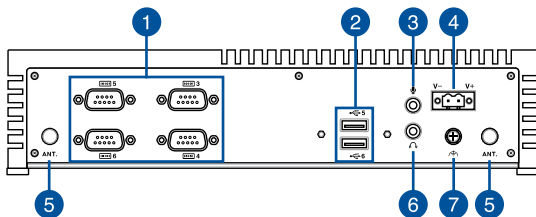

1 Serial (COM) connector (on selected models)

The 9-pin RS-232 serial (COM) connector allows you to connect devices that have serial ports such as bar code scanner, modem, or printers. Please refer to the table below for the pin definition of the COM connector.

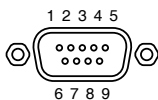

Pin	RS-232
1	DCD#
2	RXD
3	TXD
4	DTR
5	GND
6	DSR
7	RTS
8	CTS
9	RI

2 USB 2.0 port (on selected models)

The USB (Universal Serial Bus) port is compatible with USB 2.0 or USB 1.1 devices such as keyboards, pointing devices, flash disk drives, external HDDs, speakers, cameras and printers.

3



Microphone

The built-in microphone can be used for video conferencing, voice narrations, or simple audio recording.

4



Power input

The supplied terminal block power adapter converts AC power to DC power for use with this jack. Power supplied through this jack supplies power to the Edge Computer.

WARNING! The power adapter may become warm to hot when in use. Do not cover the adapter and keep it away from your body.

5

ANT.

Antenna hole

The antenna hole allows you to connect a wireless antenna to enhance wireless signal reception.

6



Headphone jack

This port allows you to connect amplified speakers or headphones.

7



Functional Earth Ground

The Functional Earth Ground provides you with a grounding point.

1.2 Motherboard Overview

1.2.1 Motherboard layout

The PE200S Series features a motherboard with a 3.5" dimension (146mm x 105mm). Please refer to the table on the next page for the page numbers of the numbered items.

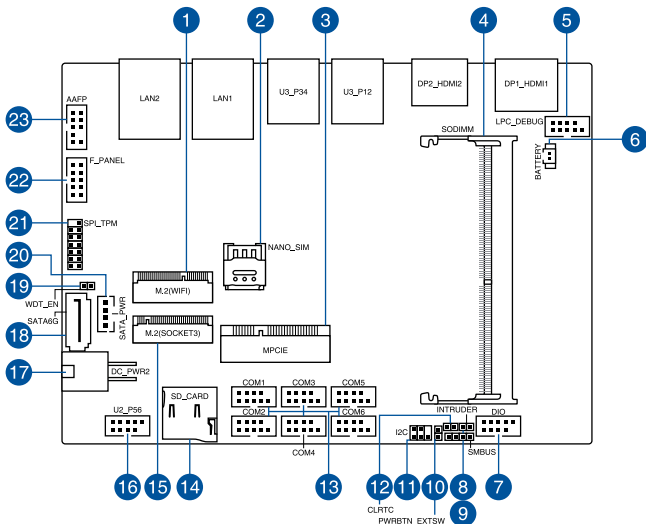

Layout contents		Page
1.	M.2 Wi-Fi slot	24
2.	Nano SIM Card slot	24
3.	Mini PCIe slot	23
4.	DIMM slot	19
5.	Low Pin Count connector	26
6.	Battery connector	26
7.	GPIO connector	27
8.	Chassis Intrusion connector	31
9.	System Management Bus connector	27
10.	Power button connector	25
11.	I2C connector	28
12.	Clear RTC RAM jumper	20
13.	Serial Port connector	29
14.	Micro SD card slot	23
15.	M.2 slot	25
16.	USB 2.0 connector	30
17.	DC-in 4-Pin Power connector	37
18.	SATA 6Gb/s & SATA Power connector	22
19.	DC-in 4-Pin Power connector	34
20.	HW WDT Enable jumper	21
21.	SPI TPM connector	28
22.	System Panel connector	32
23.	Line Out / Mic connector	33

1.2.2 System memory

The motherboard comes with a Small Outline Dual Inline Memory Module (SODIMM) slot designed for DDR3L memory modules.

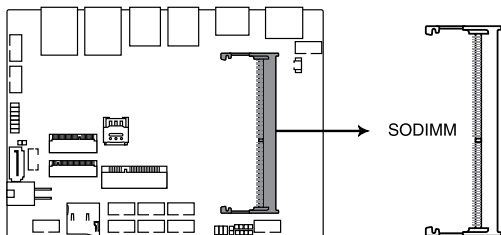

1.2.3 Onboard jumpers

1. Clear RTC RAM jumper

The Clear RTC RAM jumper allows you to clear the Real Time Clock (RTC) RAM in the CMOS, which contains the date, time, system passwords, and system setup parameters.

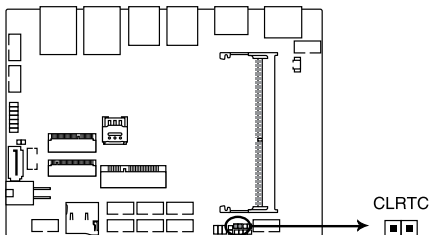

To erase the RTC RAM:

1. Turn OFF the computer and unplug the power cord.
2. Short-circuit pin 1-2 with a metal object or jumper cap for about 5-10 seconds.
3. Plug the power cord and turn ON the computer.
4. Hold down the key during the boot process and enter BIOS setup to re-enter data.

WARNING! DO NOT remove the jumper cap from its default position except when clearing the RTC RAM. Removing the jumper cap will cause system boot failure!

NOTE: If the steps above do not help, remove the onboard button cell battery and move the jumper again to clear the CMOS RTC RAM data. After clearing the CMOS, reinstall the button cell battery.

2. HW WDT Enable jumper

A watchdog timer is an electronic timer that is used to detect and recover from computer malfunctions. The HW WDT (watchdog timer) Enable jumper allows the HW watchdog resets the system automatically even when the system crashes.

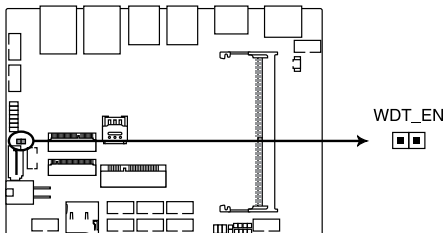

NOTE: The default setting for this jumper is set to HW WDT enabled with a jumper cap attached.

1.2.4 Internal connectors

1. SATA 6Gb/s & SATA Power connector

The SATA 6Gb/s and SATA Power connectors allow you to connect SATA devices such as optical disc drives and hard disk drives via a SATA cable and power cable.

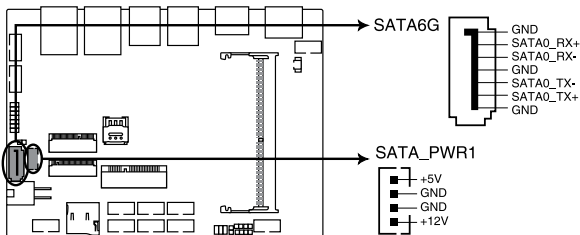

Connector type
Wafer HD 4P, 2.0mm pitch

NOTE: Ensure to use the bundled cable when connecting a storage device to this connector.

2. Mini PCIe slot

The Mini PCIe slot allows you to install a Mini PCIe peripheral device.

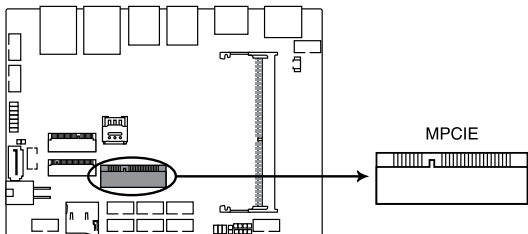

NOTE: The Mini PCIe peripheral device is purchased separately.

3. Micro SD Card slot

The Micro SD Card slot allows you to install a Micro SD card.

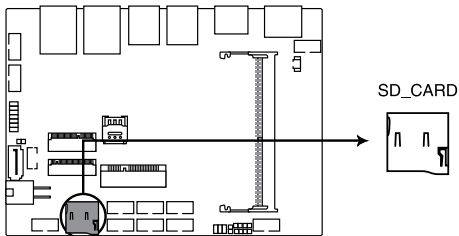

NOTE: The Micro SD card is purchased separately.

4. Nano SIM Card slot

The Nano SIM Card slot allows you to install a Nano SIM card.

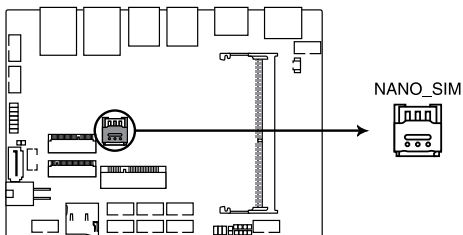

NOTE: The Nano SIM card is purchased separately.

5. M.2 Wi-Fi slot

The M.2 Wi-Fi slot allows you to install an M.2 Wi-Fi module (E-key, type 2230).

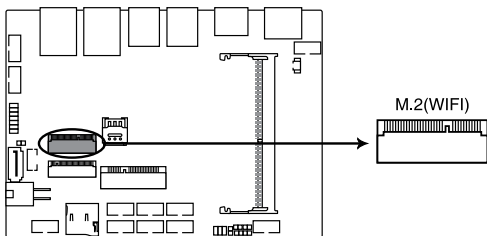

NOTE: The M.2 Wi-Fi module is purchased separately.

6. M.2 slot

The M.2 slot allows you to install 2242 M.2 devices such as 2242 M.2 SSD modules.

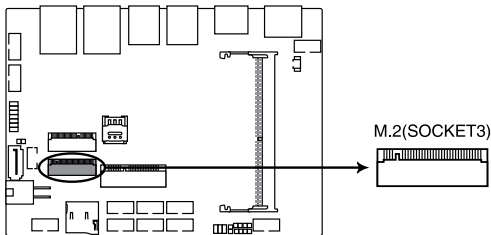

NOTE:

- The M.2 SSD module is purchased separately.
 - This motherboard supports 2242 SATA SSD devices only.
-

7. Power button connector

The Power Button connector allows you to connect an external power button.

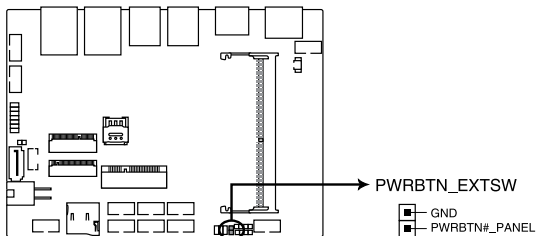

8. Battery connector

The Battery connector allows you to connect the lithium CMOS battery.

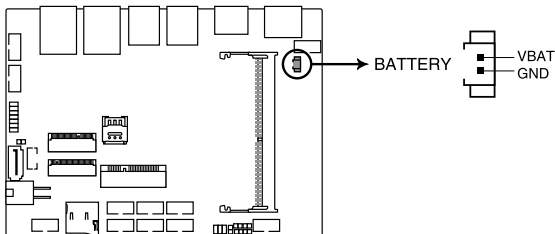

9. Low Pin Count connector

The Low Pin Count connector allows you to connect a low pin count (LPC) debug card that offers a faster, more efficient motherboard troubleshooting solution. When connected to a debug card, users can view error and debugging codes on the card and get a better idea of initialization and recovery processes.

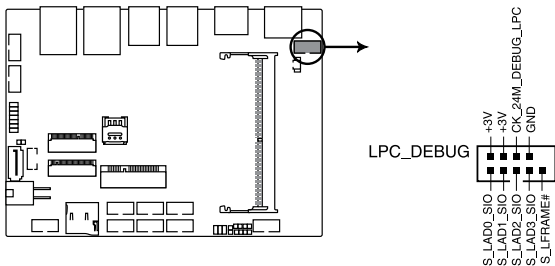

Connector type

BOX header 2x5p, K10, 2.0mm pitch

10. System Management Bus connector

The System Management Bus (SMBus) connector allows you to connect SMBus devices. This connector is generally used for communication with the system and power management-related tasks.

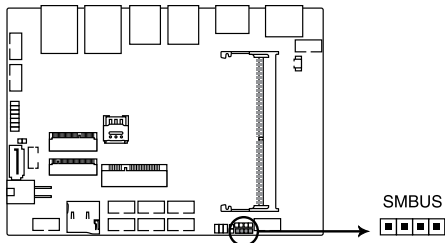

Connector type

Header 1x4p, 2.0mm pitch

11. GPIO connector

The GPIO connector allows you to connect a general purpose input/output module which allows you to customize the digital signal input/output.

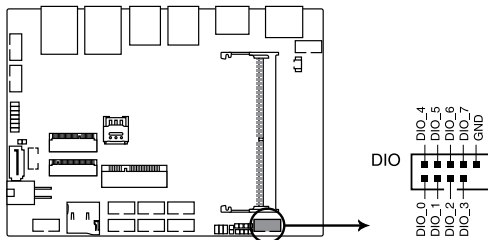

Connector type

BOX header 2x5p, K9, 2.0mm pitch

12. I2C connector

The I2C (Inter-Integrated Circuit) connector allows you to connect an I2C compatible IoT security module.

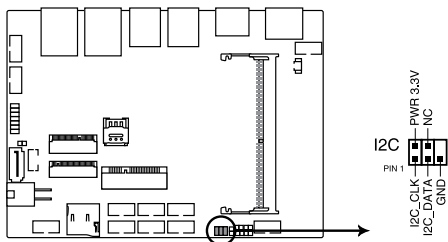

Connector type

Header 2x3p, K6, 2.0mm pitch

13. SPI TPM connector

The SPI TPM connector supports a Trusted Platform Module (TPM) system, which can securely store keys, digital certificates, passwords, and data. A TPM system also helps enhance network security, protects digital identities, and ensures platform integrity.

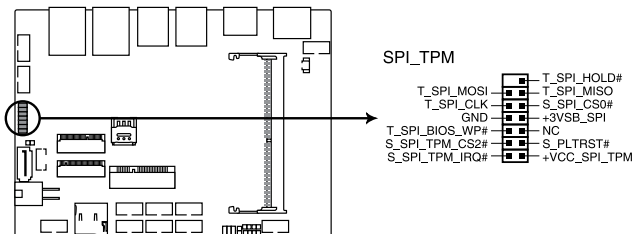

Connector type

Header 2x7p, K14, 2.0mm pitch

14. Serial Port connector

The Serial (COM) Port connector allows you to connect a serial port module. Connect the serial port module cable to this connector, then install the module to a slot opening on the system chassis.

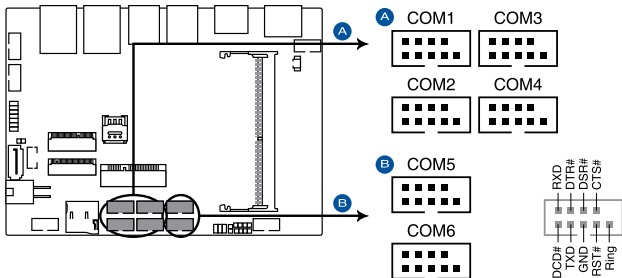

Connector type

BOX header 2x5p, K10, 2.0mm pitch

NOTE:

- The serial port module is purchased separately.
- **COM1** and **COM2** support RS-232/422/485.
- **COM3**, **COM4**, **COM5**, and **COM6** support RS-232.

15. USB 2.0 connector

The USB 2.0 connector allows you to connect a USB module for additional USB 2.0 ports. The USB 2.0 connector provides data transfer speeds of up to 480 MB/s connection speed.

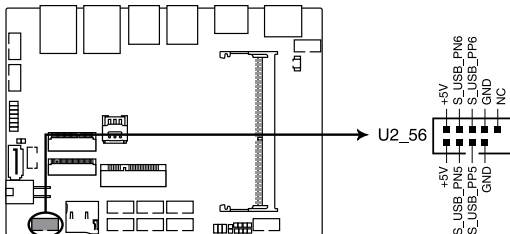

Connector type

BOX header 2x5p, K9, 2.0mm pitch

WARNING! DO NOT connect a 1394 cable to the USB connectors. Doing so will damage the motherboard!

NOTE: The USB 2.0 module is purchased separately.

16. Chassis Intrusion connector

The Chassis Intrusion connector allows you to connect an intrusion sensor or microswitch for the chassis intrusion detection feature. When you remove any chassis component, the sensor or microswitch triggers and sends a high level signal and records a chassis intrusion event.

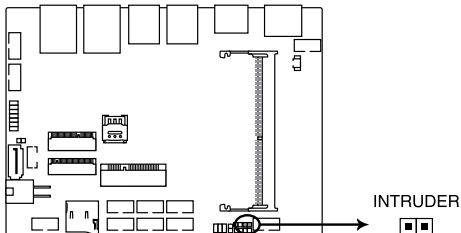

NOTE: By default, a jumper cap that disables the intrusion detection feature is installed on the connector to prevent accidental triggers.

17. System Panel connector

The System Panel connector supports several chassis-mounted functions.

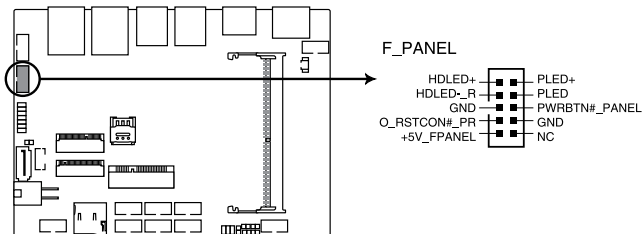

Connector type

BOX header 2x5p 2.0mm pitch

- **System Power LED connector (PLED)**

The 2-pin connector allow you to connect the System Power LED. The System Power LED lights up when the system is connected to a power source, or when you turn on the system power, and blinks when the system is in sleep mode.

- **Storage Device Activity LED connector (HD_LED)**

The 2-pin connector allows you to connect the Storage Device Activity LED. The Storage Device Activity LED lights up or blinks when data is read from or written to the storage device or storage device add-on card.

- **Power Button/Soft-off Button connector (PWRSW)**

The 3-1 pin connector allows you to connect the system power button. Press the power button to power up the system, or put the system into sleep or soft-off mode (depending on the operating system settings).

- **Reset button connector (RESET)**

The 2-pin connector allows you to connect the chassis-mounted reset button. Press the reset button to reboot the system.

18. Line Out / Mic connector

The Line Out / Mic connector is for a line out / microphone module that supports HD Audio. Connect one end of the line Out / mic module cable to this connector.

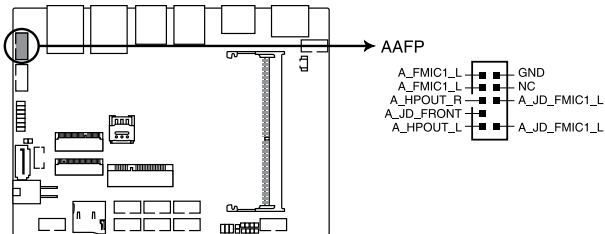

Connector type

BOX header 2x5p, K8, 2.0mm pitch

NOTE: We recommend that you connect a high-definition line out / mic module to this connector to avail of the motherboard's high-definition audio capability.

19. DC-in 4-Pin Power connector

The DC-in 4-pin Power connector is for DC power input. Using a compatible power cable and power board, you may connect a suitable power supply with DC -in jacks.

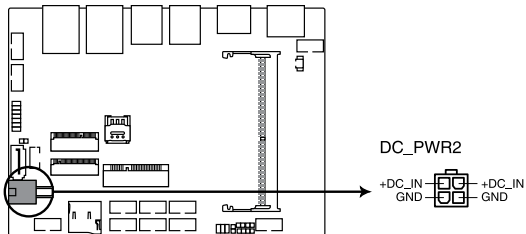

Connector type

POWER CON 4P R/A

2

Using your Edge Computer

2.1 Getting started

2.1.1 Connect the AC power adapter to your Edge Computer

To connect the AC power adapter to your Edge Computer:

- A. Connect the power cord to the AC power adapter.
- B. Connect the DC power connector into your Edge Computer's power (DC) input.
- C. Plug the AC power adapter into a 100V~240V power source.

NOTE: The power adapter may vary in appearance, depending on models and your region.

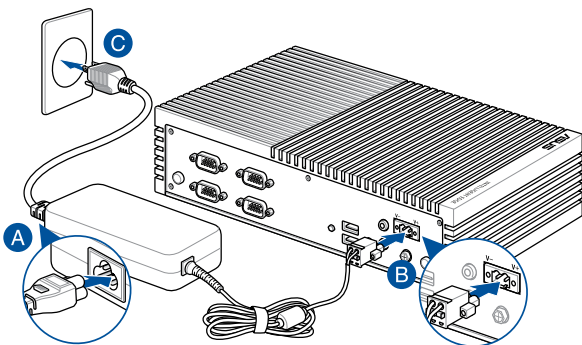

IMPORTANT!

- We strongly recommend that you use only the AC power adapter and cable that came with your Edge Computer.
 - We strongly recommend that you use a grounded wall socket while using your Edge Computer.
 - The socket outlet must be easily accessible and near your Edge Computer.
 - To disconnect your Edge Computer from its main power supply, unplug your Edge Computer from the power socket.
-

NOTE:

The power adapter may vary between models and territories, please refer to the following for more information on the different adapters:

65W Power adapter

- Input voltage: 100-240 Vac
- Input frequency: 50-60 Hz
- Rating output current: 3.42A / 3.33A (65.0 W)
- Rating output voltage: 19.0V / 19.5V

120W Power adapter

- Input voltage: 100-240 Vac
 - Input frequency: 50-60 Hz
 - Rating output current: 6.32A max. (120.0 W)
 - Rating output voltage: 19.0V
-

2.1.2 Connect a display panel to your Edge Computer

You can connect a display panel or projector to your Edge Computer that has the following connectors:

- HDMI connector
- DisplayPort

To connect a display panel to your Edge Computer:

Connect one end of an HDMI, or a DisplayPort cable to an external display, and the other end of the cable to your Edge Computer's HDMI port, or DisplayPort.

Connect display via HDMI port

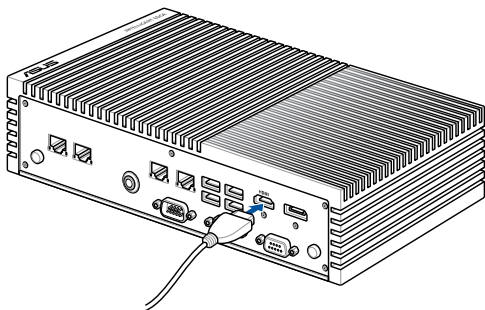

Connect display via DisplayPort

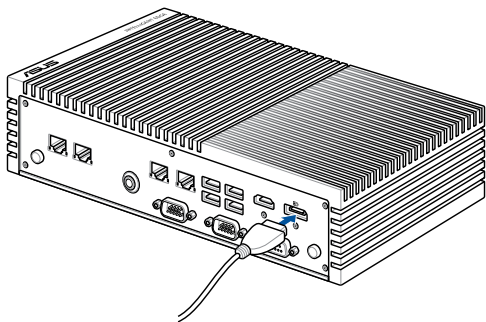

2.1.3 Connect the USB cable from keyboard or mouse

You can connect generally any USB keyboard and mouse to your Edge Computer. You can also connect a USB dongle for a wireless keyboard and mouse set.

To connect a keyboard and mouse to your Edge Computer:

Connect the USB cable from your keyboard and mouse to any of the USB ports of your Edge Computer.

NOTE:

- The keyboard varies with country or region.
 - The keyboard and mouse are purchased separately.
-

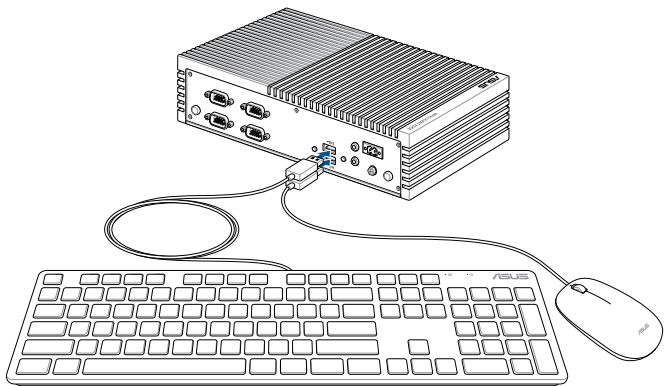

2.1.4 Turn on your Edge Computer

Press the power button to turn on your Edge Computer.

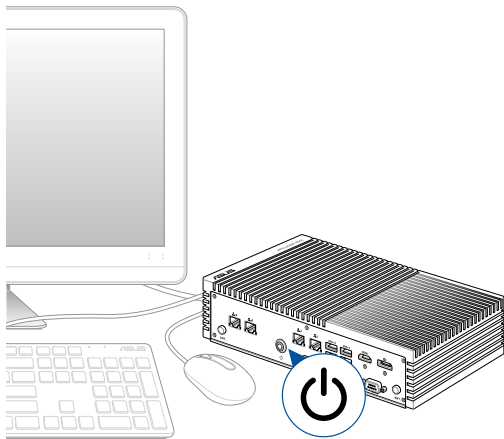

2.2 Turning your Edge Computer off

If your Edge Computer is unresponsive, press and hold the power button for at least four (4) seconds until your Edge Computer turns off.

2.3 Putting your Edge Computer to sleep

To put your Edge Computer on Sleep mode, press the Power button once.

3

***Upgrading your Edge
Computer***

IMPORTANT!

- Ensure that your hands are dry before proceeding with the rest of the installation process. Before installing any of the features in this guide, use a grounded wrist strap or touch a safely grounded object or metal object to avoid damaging them due to static electricity.
 - Turn off the power of your Edge Computer, and allow it to cool for at least 10 minutes before performing any installation/uninstallation process.
-

NOTE: The illustrations in this section are for reference only. The slots may vary depending on model.

3.1 Removing the bottom cover

1. Turn off your Edge Computer then disconnect all cables and peripherals.
2. Place the Edge Computer on a flat stable surface, with its top side facing down.
3. Remove the four (4) rubber feet screws from the bottom cover.
4. Remove the four (4) screws securing the bottom cover.
5. After removing the screws, remove the bottom cover and place it aside.

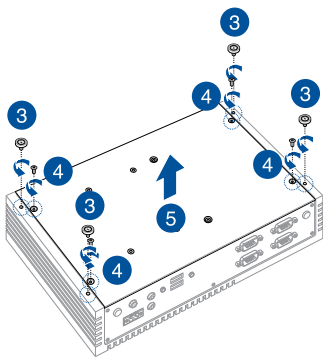

3.2 Replacing the bottom cover

1. Align the bottom cover with the screw holes, then replace the bottom cover onto the Edge Computer.
2. Secure the bottom cover using the four (4) screws removed previously.
3. Replace the four (4) rubber feet screws removed previously.

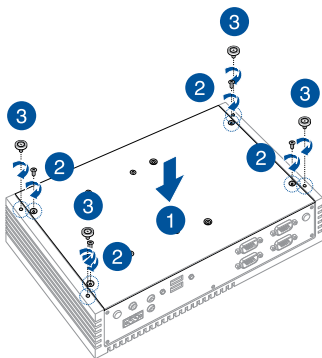

3.3 Installing memory modules

Your Edge Computer comes with a SO-DIMM memory slot that allow you to install a DDR3L SO-DIMM.

Align and insert the memory module into the slot (A) and press it down (B) until it is securely seated in place.

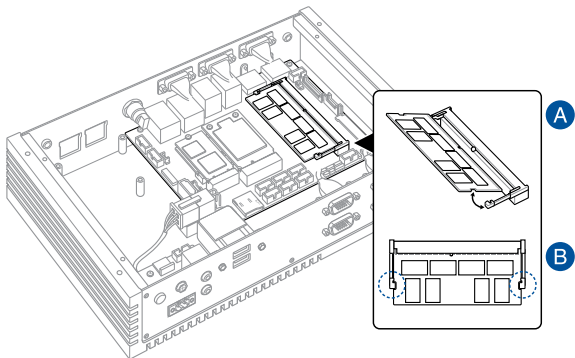

3.4 Installing 2.5" storage device

1. Prepare your 2.5" storage device, then align it with the storage bay on the bottom cover of your Edge Computer.
2. Connect the storage device cable to the storage device.
3. Insert your storage device into the storage bay.
4. Secure the storage device to the storage bay using four (4) screws.

IMPORTANT! This device only supports 7mm 2.5" HDD or SSD.

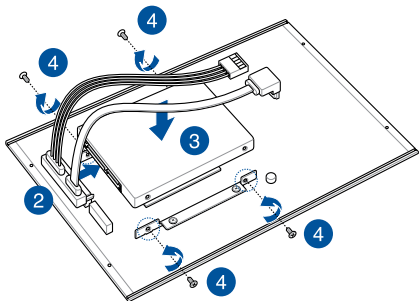

5. Connect the storage device cable to the **SATA6G** and **SATA_PWR** connectors on the motherboard.
6. Replace the bottom cover, then secure the bottom cover using the four (4) screws removed previously.
7. Replace the four (4) rubber feet screws removed previously.

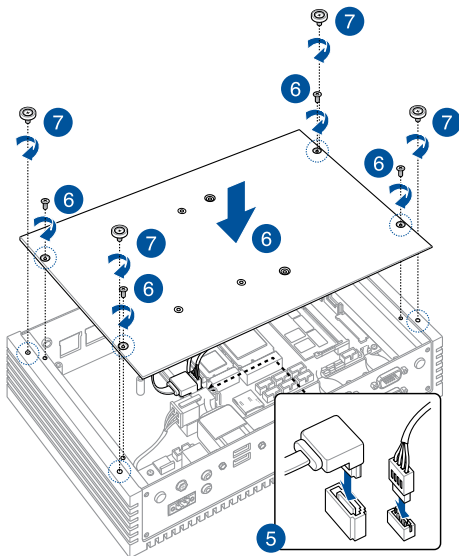

3.5 Installing the Mini PCIe card

Your Edge Computer comes with a Mini PCIe slot that allow you to install a Mini PCIe peripheral card.

Align and insert the Mini PCIe card into the slot (A) and press it down and secure it in place using two (2) screws.

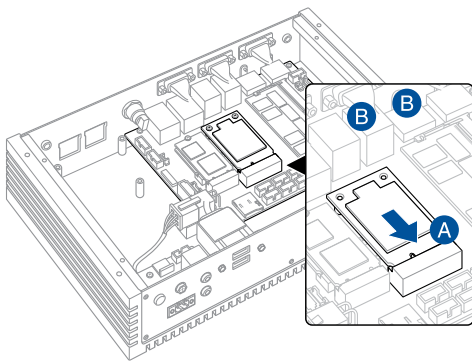

3.6 Installing a nano SIM card

1. (optional) Remove the Mini PCIe card if there is a Mini PCIe card installed by removing the two (2) screws securing the Mini PCIe card first, then removing the Mini PCIe card.
2. Push the nano SIM cover towards the front of your Edge Computer.
3. Lift the nano SIM cover.
4. Place the nano SIM into the nano SIM slot.
5. Replace the nano SIM cover.
6. Push the nano SIM cover towards the rear of your Edge Computer to secure the nano SIM card.

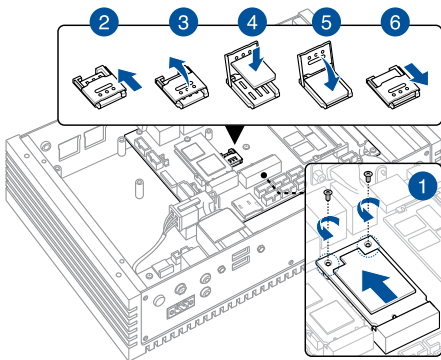

3.7 Installing an SD card

1. Remove the five (5) screws on the rear cover, then slightly pull the rear cover outwards, but do not remove it completely.
2. Insert your SD card into the SD card slot. Ensure that the SD card is pushed all the way into the SD card slot.

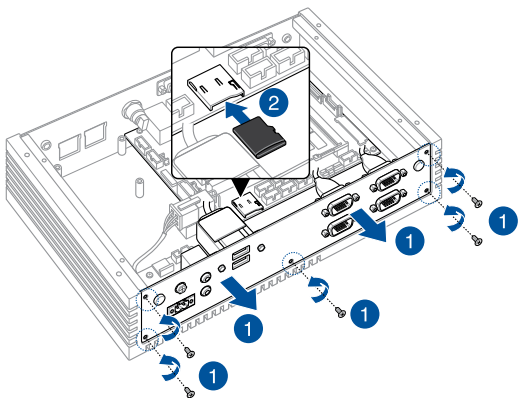

3. Once your SD card is properly installed into the SD card slot, replace the rear cover and secure it using the five (5) screws removed previously.

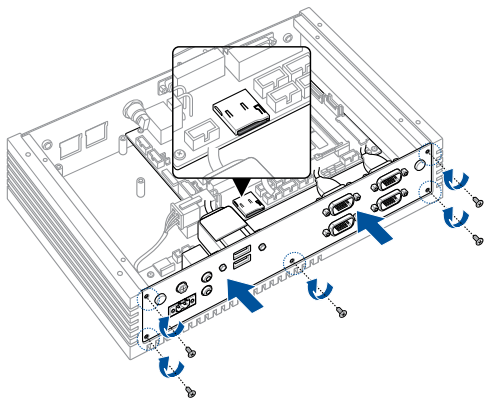

3.8 Installing the wireless card

1. Remove the M.2 stand screw.
2. Align and insert the wireless card into its slot inside the Edge Computer, then gently push down the wireless card on top of the screw hole and fasten it using the previously removed stand screw.

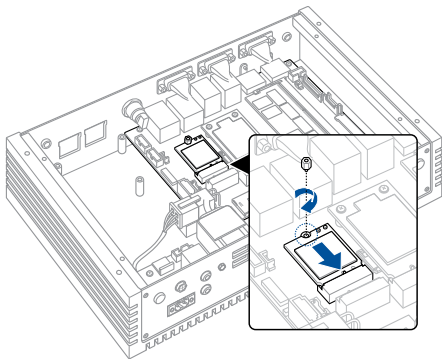

3. (optional) Connect the antennas to your wireless card.

NOTE:

- Please refer to the *Installing the antennas* section for more information on installing the antennas.
 - Connecting antennas to your wireless card may strengthen the wireless signal.
 - A soft clicking sound indicates that the antenna has been securely attached on the wireless card.
-

3.9 Installing an M.2 SSD

1. (optional) Replace the stand screw if it has been removed.
2. Align and insert the M.2 SSD into its slot inside the Edge Computer, then gently push down the M.2 SSD on top of the stand screw hole and fasten it using a screw.

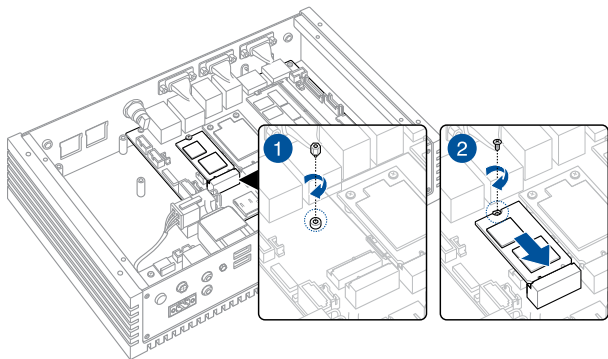

3.10 Installing the antennas (optional)

You may install antennas to the four (4) antenna holes located on the front and rear panels. The installed antennas can be connected to a WWAN card installed in the Mini PCIe slot, or to a wireless card installed in the M.2 Wi-Fi slot.

1. Remove the rubber caps from the antenna hole.
2. Prepare the RF connector and cable.
3. Insert the antenna jack end of the RF connector and cable into the antenna hole from within the chassis outwards.
4. Insert the bundled O-ring to the antenna jack, then secure the antenna jack using bundled hex screw.
5. Connect the other end of the RF connector and cable to your wireless card or WWAN card.
6. Repeat steps 1 to 5 to install additional antennas.

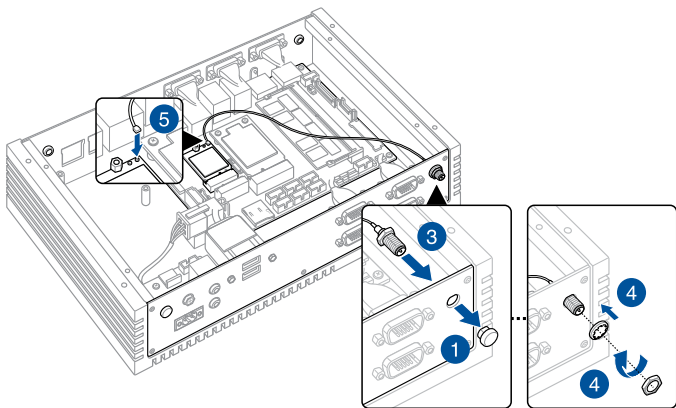

3.11 Installing the USB 2.0 module (on selected models)

1. Align the bundled USB 2.0 module with the USB 2.0 port holes and screw holes on the rear panel.
2. Secure the USB 2.0 module to the rear panel using two (2) bundled hex bolts and hex nuts.
3. Connect the USB 2.0 module connector to the **USB 2.0 connector** on the motherboard.

NOTE: Please refer to the *Motherboard layout* section for the location of the USB 2.0 connectors.

4. To install another USB 2.0 module, please repeat steps 1-3.

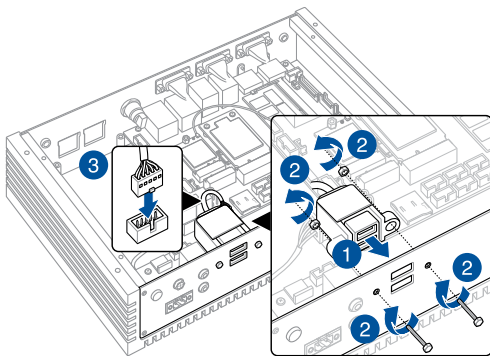

3.12 Installing the Serial port module (on selected models)

1. Align the bundled Serial port module with the Serial port holes and screw holes on the rear panel.
2. Secure the Serial port module to the rear panel using two (2) bundled hex screws.
3. Connect the Serial port module connector to the **Serial port connector** on the motherboard.

NOTE: Please refer to the *Motherboard layout* section for the location of the Serial port connectors.

4. To install another Serial port module, please repeat steps 1-3.

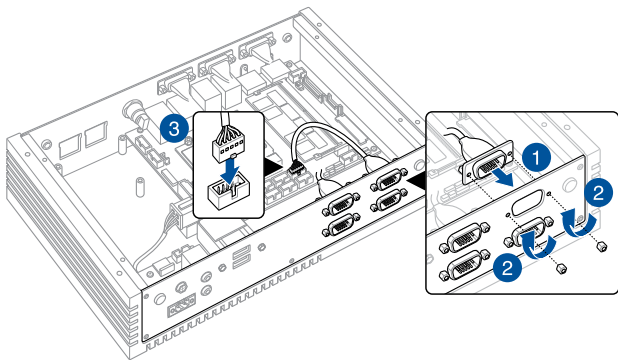

3.13 Installing the PoE LAN module (on selected models)

NOTE:

- The PoE LAN module supports up to 15W per port for powering IEEE802.3af.
 - Operating temperature when using PoE with your device: -20°C~50°C.
-

1. Connect the **CN1** and **CN2** connectors on the PoE LAN module's daughter board to the **CN1** and **CN2** connectors on the PoE LAN module's motherboard using the two (2) bundled LAN signal cables.
-

NOTE: Ensure to connect the **CN1** connector on the daughter board to the **CN1** connector on the motherboard, and the **CN2** connector on the daughter board to the **CN2** connector on the motherboard.

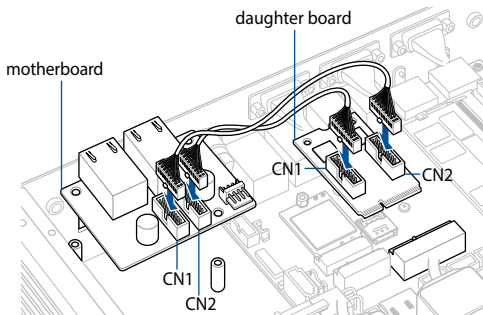

2. Connect the power connector on the daughter board to the power connector on the power board.

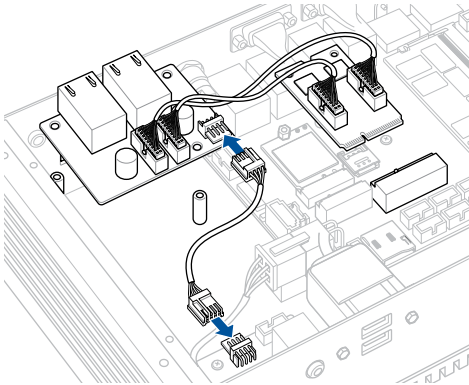

3. Secure the motherboard and daughter board using the bundled screws.

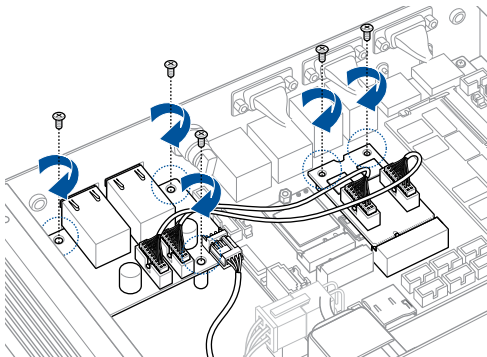

3.14 Installing the VESA mount (optional)

You may install a VESA mount to your Edge Computer which allows you to install your Edge Computer to a VESA mount-compatible device.

1. Place your Edge Computer upside down on a flat and stable surface.
2. Attach the bundled two (2) 12mm screws into the screw holes at the bottom of your Edge Computer.

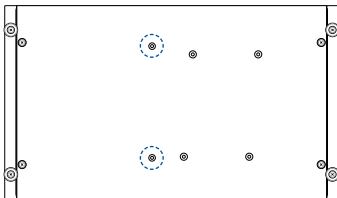

3. Remove the screw hole covers at the back of your VESA mount-compatible device, if any.

4. With the arrow on the VESA mounting plate pointing upward, align its screw holes to the screw holes of the VESA mount-compatible device.
5. Secure the VESA mounting plate to the VESA mount-compatible device using the bundled screws.

WARNING! Do not overtighten the screws as it may cause damage to your VESA mount-compatible device.

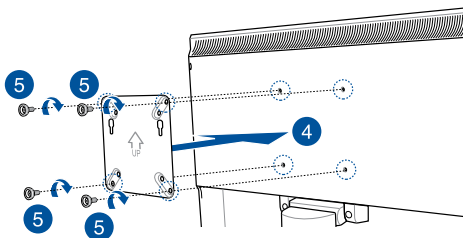

6. Position the Edge Computer and insert the screws attached on the Edge Computer to the mounting holes of the VESA mounting plate (A), then gently push the Edge Computer down in the angle shown in the illustration to secure it in place (B).

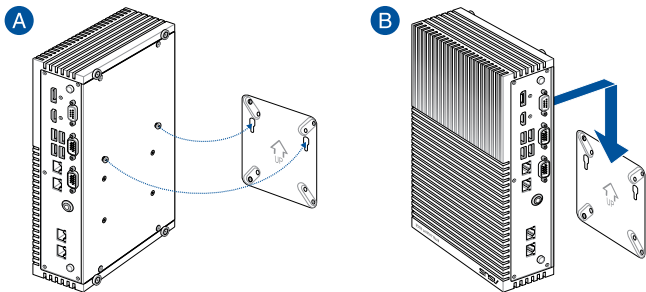

3.15 Installing the wall mount

1. Remove the four (4) rubber feet screws.

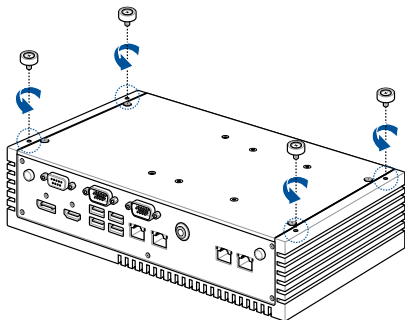

2. Align the wall mount with the rubber feet screw holes (A), then remove the rubber feet from the rubber feet screws (B) and secure the wall mount to your Edge Computer using the rubber feet screws (C).

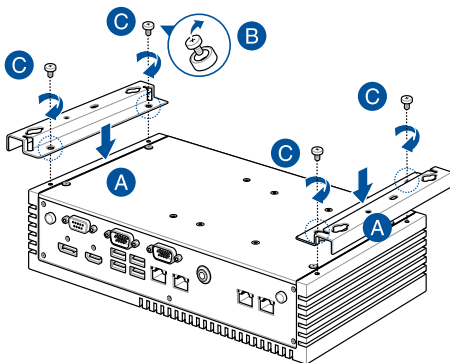

4

BIOS Setup

4.1 Getting to know your BIOS

The BIOS (Basic Input and Output System) stores system hardware settings such as Storage Device Configuration, Advanced Power Management, and Boot Device Configuration that are needed for system startup. Under normal circumstances, the default BIOS settings apply to most conditions to ensure optimal performance. DO NOT change the default BIOS settings except in the following circumstances:

- An error message appears on the screen during the system bootup and requests you to run the BIOS setup.
- You have installed a new system component that requires further BIOS settings or update.

WARNING! Inappropriate BIOS settings may result to instability or boot failure. We strongly recommend that you change the BIOS settings only with the help of a trained service personnel.

4.2 BIOS setup program

Use the BIOS Setup program to update the BIOS or configure its parameters. The BIOS screens include navigation keys and brief online help to guide you in using the BIOS Setup program.

Entering BIOS Setup at startup

To enter BIOS Setup at startup:

- Press <Delete> or <F2> during the Power-On Self Test (POST). If you do not press <Delete> or <F2>, POST continues with its routines.

Entering BIOS Setup after POST

To enter BIOS Setup after POST:

- Press <Ctrl>+<Alt>+<Delete> simultaneously.
- Press the power button to turn the system off then back on. Do this option only if you failed to enter BIOS Setup using the first option.

BIOS menu screen

This section provides a brief introduction of the BIOS Interface of your Edge Computer motherboard.

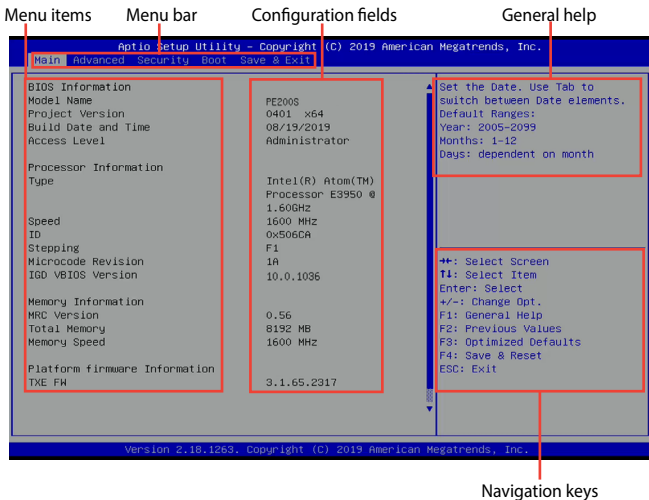

Menu bar

The menu bar on top of the screen has the following main items:

Main	For changing the basic system configuration
Advanced	For changing the advanced system settings
Security	For changing the security settings
Boot	For changing the system boot configuration
Exit	For selecting the save and exit options or loading default settings

4.3 Main Menu

When you enter the BIOS Setup program, the Main menu screen appears. The Main menu provides you an overview of the basic system information, and allows you to set the system date and time. Scroll down to display the other BIOS items.

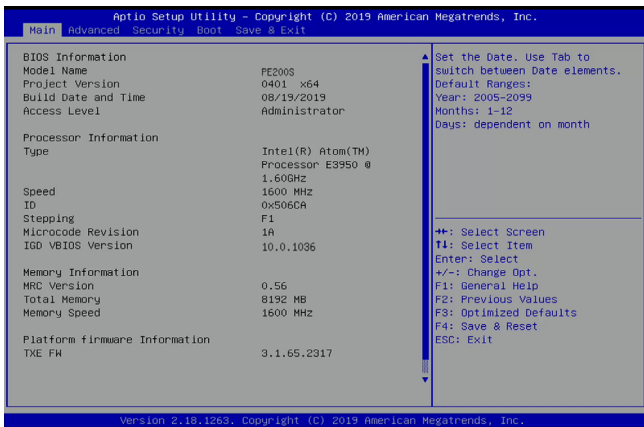

4.3.1 System Date [Day xx/xx/xxxx]

Allows you to set the system date.

4.3.2 System Time [xx:xx:xx]

Allows you to set the system time.

4.4 Advanced menu

The Advanced menu items allow you to change the settings for the CPU and other system devices.

WARNING! Be cautious when changing the settings of the Advanced menu items. Incorrect field values can cause the system to malfunction.

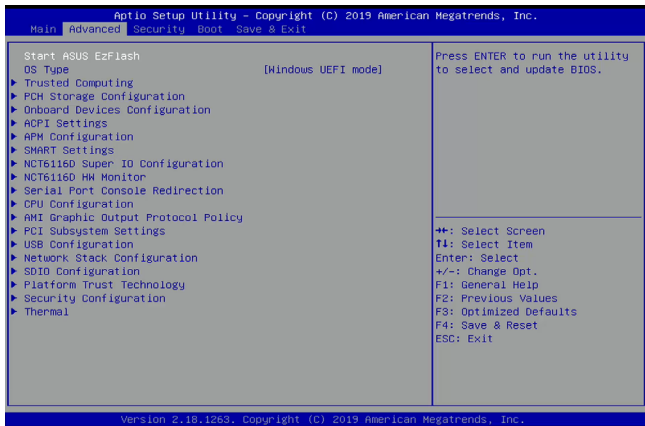

Start ASUS EzFlash

Allows you to run ASUS EzFlash BIOS ROM Utility when you press <Enter>. Refer to the **ASUS EzFlash Utility** section for details.

WARNING! Ensure to back up your Bitlocker recovery key and suspend Bitlocker encryption in the operating system before updating your BIOS.

NOTE: For more details, refer to section 4.8.2 *ASUS EzFlash Utility*.

OS Type

[Windows UEFI Mode] Allows you to select your installed operating system. Execute the Microsoft® Secure Boot check. Only select this option when booting on Windows® UEFI mode or other Microsoft® Secure Boot compliant OS.

[Other OS] Get the optimized function when booting on Windows® non-UEFI mode. Microsoft® Secure Boot only supports Windows® UEFI mode.

4.4.1 Trusted Computing

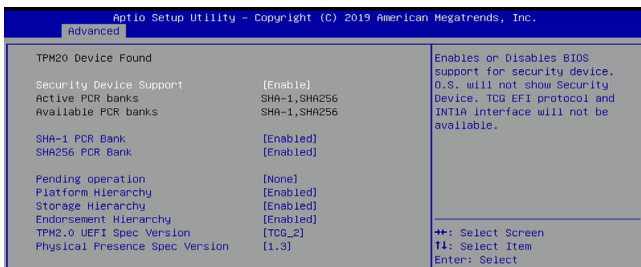

NOTE: All values changed here do not take effect until computer is restarted.

Security Device Support

Allows you to enable or disable the BIOS support for security device. Configuration options: [Disable] [Enable]

NOTE: The following items appear only when **Security Device Support** is set to [Enabled].

SHA-1 PCR Bank

Allows you to enable or disable SHA-1 PCR Bank.

Configuration options: [Disable] [Enable]

SHA256 PCR Bank

Allows you to enable or disable SHA256 PCR Bank.

Configuration options: [Disable] [Enable]

Pending operation

Allows you to schedule an operation for the Security Device.

Configuration options: [None] [TPM Clear]

NOTE: Your computer will reboot during restart in order to change the state of Security Device.

Platform Hierarchy

Allows you enable or disable the Platform Hierarchy.

Configuration options: [Disabled] [Enabled]

Storage Hierarchy

Allows you enable or disable the Storage Hierarchy.

Configuration options: [Disabled] [Enabled]

Endorsement Hierarchy

Allows you enable or disable the Endorsement Hierarchy.

Configuration options: [Disabled] [Enabled]

TPM2.0 UEFI Spec Version

Allows you to select the TCG2 spec version support.

[TCG_1_2] Compatible mode for Windows 8® / Windows® 10.

[TCG_2] Supports new TCG2 protocol and event format for Windows® 10 or later.

Physical Presence Spec Version

Select to tell the OS to support PPI Spec Version 1.2 or 1.3.

Configuration options: [1.2] [1.3]

NOTE: Some HCK tests might not support version 1.3.

4.4.2 PCH Storage Configuration

While entering Setup, the BIOS automatically detects the presence of SATA devices. The SATA Port items show **[Empty]** if no SATA device is installed to the corresponding SATA port.

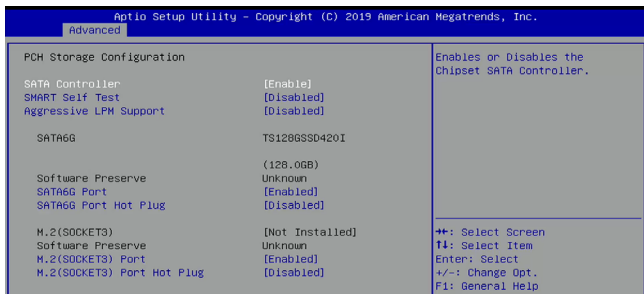

SATA Controller

Allows you to enable or disable the Chipset SATA Controller.

Configuration options: [Disabled] [Enabled]

SMART Self Test

SMART (Self-Monitoring, Analysis and Reporting Technology) is a monitoring system that shows a warning message during POST (Power-On Self Test) when an error occurs in the hard disks.

Configuration options: [Disabled] [Enabled]

NOTE: The following items appear only when **SATA Port Enable** is set to **[Enabled]**.

Aggressive LPM Support

This item is designed for LPM (link power management) support with a better energy saving conditions.

Configuration options: [Disabled] [Enabled]

SATA6G

SATA6G Port

Allows you to enable or disable the SATA port.

Configuration options: [Disabled] [Enabled]

SATA6G Port Hot Plug

Allows you to enable or disable SATA Hot Plug Support.

Configuration options: [Disabled] [Enabled]

M.2(SOCKET3)

M.2(SOCKET3) Port

Allows you to enable or disable the M.2(SOCKET3) port.

Configuration options: [Disabled] [Enabled]

M.2(SOCKET3) Port Hot Plug

Allows you to enable or disable M.2(SOCKET3) Hot Plug Support.

Configuration options: [Disabled] [Enabled]

4.4.3 Onboard Devices Configuration

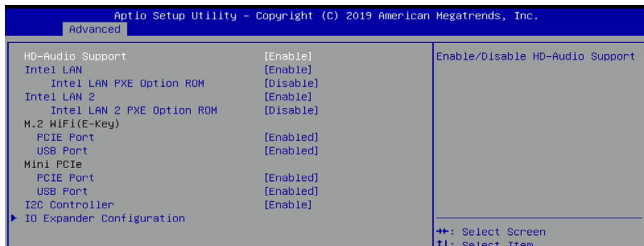

HD Audio Support

Allows you to enable or disable HD-Audio support.

Configuration options: [Disabled] [Enabled]

Intel LAN

Allows you to enable or disable Intel LAN.

Configuration options: [Disabled] [Enabled]

NOTE: The following item appears only when **Intel LAN** is set to **[Enabled]**.

Intel LAN PXE Option ROM

Allows you to enable or disable Intel LAN PXE OPROM launch.

Configuration options: [Disabled] [Enabled]

Intel LAN 2

Allows you to enable or disable Intel LAN 2.

Configuration options: [Disabled] [Enabled]

Intel LAN 2 PXE Option ROM

Allows you to enable or disable Intel LAN 2 PXE OPROM launch.

Configuration options: [Disabled] [Enabled]

M.2 WiFi(E-Key)

PCIE Port

Allows you to enable or disable Wi-Fi Controller.
Configuration options: [Disabled] [Enabled]

USB Port

Allows you to enable or disable Bluetooth Controller.
Configuration options: [Disabled] [Enabled]

Mini PCIe

PCIE Port

Allows you to enable or disable PCIe Controller.
Configuration options: [Disabled] [Enabled]

USB Port

Allows you to enable or disable USB Controller.
Configuration options: [Disabled] [Enabled]

I2C Controller

Allows you to enable or disable I2C Controller Support.
Configuration options: [Disabled] [Enabled]

IO Expander Configuration

IO Expander GPIO 0-7

Direction

Allows you to select the direction of the GPIO.
Configuration options: [Output] [Input]

4.4.4 ACPI Settings

The items in this menu allow you to configure the system ACPI parameters.

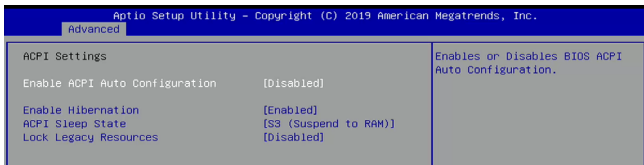

Enable ACPI Auto Configuration

Allows you to enable or disable the BIOS ACPI Auto Configuration.

Configuration options: [Disabled] [Enabled]

NOTE: The following item appears only when **Enable ACPI Auto Configuration** is set to **[Disabled]**.

Enable Hibernation

Allows you to enable or disable the ability of the system to hibernate (OS/S4 Sleep State).

Configuration options: [Disabled] [Enabled]

IMPORTANT! This option may be not be effective with some OS.

ACPI Sleep State

Allows you to select the highest ACPI sleep state the system will enter when the SUSPEND button is pressed.

Configuration options: [Suspend Disabled] [S3 (Suspend to RAM)]

Lock Legacy Resources

Allows you to enable or disable the Lock of Legacy Resources.

Configuration options: [Disabled] [Enabled]

4.4.5 APM Configuration

Allows you to configure the Advance Power Management (APM) settings.



ErP Ready

Allows you to switch off some power at S4+S5 or S5 to get the system ready for ErP requirement. When set to **[Enabled]**, all other PME options will be switched off.

Configuration options: [Disabled] [Enabled(S4+S5)] [Enabled(S5)]

Restore AC Power Loss

[S0] The system goes into ON state after an AC power loss.

[S5] The system goes into OFF state after an AC power loss.

[Last State] The system goes into either OFF or ON state, whatever the system state was before the AC power loss.

Power On By PCI-E

Allows you to enable or disable the wake-on-LAN function for the onboard LAN controller or other installed PCI-E LAN cards.

Configuration options: [Disabled] [Enabled]

Power On By Ring

[Disabled] Disables the Ring devices to generate a wake event.

[Enabled] Enables the Ring devices to generate a wake event.

Power On By RTC

[Disabled] Disables RTC to generate a wake event.

[Enabled] When set to [Enabled], the items **RTC Alarm Date (Days)** and **Hour/Minute/Second** will become user-configurable with set values.

4.4.6 SMART Settings

The items in this menu allow you to configure the SMART Self Test settings.

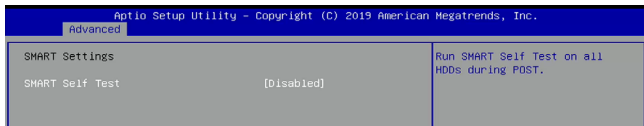

SMART Self Test

Allows you to run SMART Self Test on all HDDs during POST.

Configuration options: [Disabled] [Enabled]

4.4.7 NCT6116D Super IO Configuration

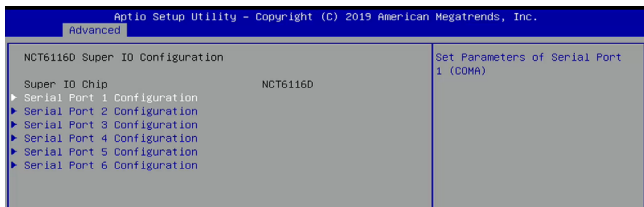

Serial Port 1-2 Configuration

Allows you to set the parameters of Serial Port 1-2.

Serial Port

Allows you to enable or disable Serial Port.

Configuration options: [Disabled] [Enabled]

NOTE: The following items appear only when **Serial Port** is set to **[Enabled]**.

Mode Select

Configuration options: [RS232] [RS485] [RS422]

Change Settings

Allows you to choose the setting for Super IO device.

Configuration options: [Auto] [IO=3F8h; IRQ=4;] [IO=3F8h; IRQ=3, 4, 5, 6, 7, 9, 10, 11, 12;] [IO=2F8h; IRQ=3, 4, 5, 6, 7, 9, 10, 11, 12;] [IO=3E8h; IRQ=3, 4, 5, 6, 7, 9, 10, 11, 12;] [IO=2E8h; IRQ=3, 4, 5, 6, 7, 9, 10, 11, 12;]

Serial Port 3-6 Configuration

Allows you to set the parameters of Serial Port 3-6.

Serial Port

Allows you to enable or disable Serial Port.

Configuration options: [Disabled] [Enabled]

NOTE: The following items appear only when **Serial Port** is set to **[Enabled]**.

Change Settings

Allows you to choose the setting for Super IO device.

Configuration options: [Auto] [IO=3F8h; IRQ=4;] [IO=3F8h; IRQ=3, 4, 5, 6, 7, 9, 10, 11, 12;] [IO=2F8h; IRQ=3, 4, 5, 6, 7, 9, 10, 11, 12;] [IO=3E8h; IRQ=3, 4, 5, 6, 7, 9, 10, 11, 12;] [IO=2E8h; IRQ=3, 4, 5, 6, 7, 9, 10, 11, 12;]

4.4.8 NCT6116D HW Monitor

Aptio Setup Utility - Copyright (C) 2019 American Megatrends, Inc.	
Advanced	
PC Health Status	
MotherBoard Temperature	: +35.5°C
CPU Temperature	: +34.0°C
CHA_FAN_IN	: N/A
VCCORE	: +0.896 V
+5VSB_IN	: +5.093 V
System Current	: +0.300 A
DC_IN	: +19.488 V
VTT	: +1.056 V

4.4.9 Serial Port Console Redirection

Aptio Setup Utility - Copyright (C) 2019 American Megatrends, Inc.	
Advanced	
COM1	Console Redirection [Disabled]
▶ Console Redirection Settings	
COM2	Console Redirection [Disabled]
▶ Console Redirection Settings	
COM3	Console Redirection [Disabled]
▶ Console Redirection Settings	
COM4	Console Redirection [Disabled]
▶ Console Redirection Settings	
COM5	Console Redirection [Disabled]
▶ Console Redirection Settings	
COM6	Console Redirection [Disabled]
▶ Console Redirection Settings	

▲ Console Redirection Enable or Disable.

▶▶: Select Screen
T1: Select Item
Enter: Select
+/-: Change Opt.
F1: General Help
F2: Previous Values
F3: Optimized Defaults
F4: Save & Reset
ESC: Exit

COM1-6

Console Redirection

Allows you to enable or disable the console redirection feature.

Configuration options: [Disabled] [Enabled]

NOTE: The following item appears only when **Console Redirection** is set to **[Enabled]**.

Console Redirection Settings

This item becomes configurable only when you enable the **Console Redirection** item. The settings specify how the host computer and the remote computer (which the user is using) will exchange data. Both computers should have the same or compatible settings.

Terminal Type

Allows you to set the terminal type.

[VT100] ASCII char set.

[VT100+] Extends VT100 to support color, function keys, etc.

[VT-UTF8] Uses UTF8 encoding to map Unicode chars onto 1 or more bytes.

[ANSI] Extended ASCII char set.

Bits per second

Selects serial port transmission speed. The speed must be matched on the other side. Long or noisy lines may require lower speeds.

Configuration options: [9600] [19200] [38400] [57600] [115200]

Data Bits

Configuration options: [7] [8]

Parity

A parity bit can be sent with the data bits to detect some transmission errors. **[Mark]** and **[Space]** parity do not allow for error detection.

[None] None.

[Even] parity bit is 0 if the num of 1's in the data bits is even.

[Odd] parity bit is 0 if num of 1's in the data bits is odd.

[Mark] parity bit is always 1.

[Space] parity bit is always 0.

Stop Bits

Stop bits indicate the end of a serial data packet. (A start bit indicates the beginning.) The standard setting is 1 stop bit. Communication with slow devices may require more than 1 stop bit.

Configuration options: [1] [2]

Flow Control

Flow control can prevent data loss from buffer overflow. When sending data, if the receiving buffers are full, a “stop” signal can be sent to stop the data flow. Once the buffers are empty, a “start” signal can be sent to re-start the flow. Hardware flow control uses two wires to send start/stop signals.

Configuration options: [None] [Hardware RTS/CTS]

VT-UTF8 Combo Key Support

Allows you to enable the VT-UTF8 Combo Key Support for ANSI/VT100 terminals.

Configuration options: [Disabled] [Enabled]

Recorder Mode

With this mode enabled only text will be sent. This is to capture Terminal data.

Configuration options: [Disabled] [Enabled]

Resolution 100x31

Allows you to enable or disable extended terminal resolution.

Configuration options: [Disabled] [Enabled]

Putty Keypad

This allows you to select the FunctionKey and Keypad on Putty.

Configuration options: [VT100] [Intel Linux] [XTERMR6] [SCO] [ESCN] [VT400]

Legacy Console Redirection Settings

Redirection COM Port

Allows you to select a COM port to display redirection of Legacy OS and Legacy OPROM Messages.

Configuration options: [COM1] [COM2] [COM3] [COM4] [COM5] [COM6]

Resolution

This allows you to set the number of rows and columns supported on the Legacy OS.

Configuration options: [80x24] [80x25]

Redirection After POST

This setting allows you to specify if Bootloader is selected than Legacy console redirection.

[Always Enable] Legacy Console Redirection is enabled for Legacy OS.

[Bootloader] Legacy Console Redirection is disabled before booting to Legacy OS.

Serial Port for Out-of-Band Management/ Windows Emergency Management Services (EMS)

Console Redirection

Allows you to enable or disable the console redirection feature.

Configuration options: [Disabled] [Enabled]

NOTE: The following item appears only when **Console Redirection** is set to **[Enabled]**.

Console Redirection Settings

Out-of-Band Mgmt Port

Microsoft Windows Emergency Management Services (EMS) allows for remote management of a Windows Server OS through a serial port.

Configuration options: [COM1] [COM2] [COM3] [COM4] [COM5] [COM6]

Terminal Type

Allows you to set the terminal type for out-of-band management.

Configuration options: [VT100] [VT100+] [VT-UTF8] [ANSI]

Bits per second

Allows you to set the serial port transmission speed.

Configuration options: [9600] [19200] [57600] [115200]

Flow Control

Allows you to set the flow control to prevent data loss from buffer overflow.

Configuration options: [None] [Hardware RTS/CTS] [Software Xon/Xoff]

4.4.10 CPU Configuration

The items in this menu show the CPU-related information that the BIOS automatically detects.

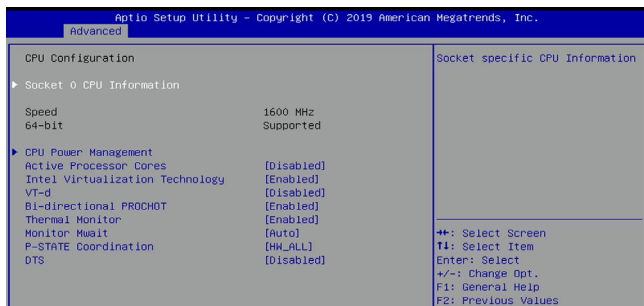

Socket 0 CPU Information

Allows you to view Socket specific CPU information.

CPU Power Management

EIST

Allows you to enable or disable Intel SpeedStep.

Configuration: [Disabled] [Enabled]

NOTE: The following item appears only when **EIST** is set to **[Enabled]**.

Turbo Mode

Allows you to enable or disable Turbo Mode.

Configuration options: [Disabled] [Enabled]

Boot performance mode

Allows you to select the performance state that the BIOS will set before OS handoff.

Configuration options: [Max Performance] [Max Battery]

C-States

Allows you to enable or disable C-States.

Configuration options: [Disabled] [Enabled]

NOTE: The following items appear only when **C-States** is set to **[Enabled]**.

Enhanced C-States

Allows you to enable or disable C1E. When set to **[Enabled]**, CPU will switch to minimum speed when all cores enter C-State.

Configuration options: [Disabled] [Enabled]

Max Package C State

Allows you to control the Max Package C State that the processor will support.

Configuration options: [PC2] [PC1] [C0]

Max Core C State

Allows you to control the Max Core C State that cores will support.

Configuration options: [Fused Value] [Core C10] [Core C9] [Core C8] [Core C7] [Core C6] [Core C1] [Unlimited]

C-State Auto Demotion

Allows you to configure the demotion of the C-State.

Configuration options: [Disabled] [C1]

C-State Un-demotion

Allows you to configure the un-demotion of the C-State.

Configuration options: [Disabled] [C1]

Power Limit 1 Enable

Allows you to enable or disable Power Limit 1.

Configuration options: [Disabled] [Enabled]

NOTE: The following items appear only when **Power Limit 1 Enable** is set to **[Enabled]**.

Power Limit 1

Power Limit 1 Clamp Mode

Allows you to enable or disable Power Limit 1 Clamp Mode.

Configuration options: [Disabled] [Enabled]

Power Limit 1 Power

Allows you to set the Power Limit 1 in Watts. Selecting **[Auto]** will program Power Limit 1 Power based on the silicon default support value.

Configuration options: [Auto] [6] [7] [8] [9] [10] [11] [12] [13] [14] [15] [16] [17] [18] [19] [20] [21] [22] [23] [24] [25]

Power Limit 1 Time Window

Allows you to set the Power Limit 1 Time Window value in Seconds. Selecting **[Auto]** will program Power Limit 1 Time Window based on the silicon default support value.

Configuration options: [Auto] [1] [2] [3] [4] [5] [6] [7] [8] [10] [12] [14] [16] [20] [24] [28] [32] [40] [48] [56] [64] [80] [96] [112]

Active Processor Cores

Allows you to enable or disable selecting the number of CPU cores to activate in each processor package.

Configuration options: [Disabled] [Enabled]

NOTE: The following items appear only when **Active Processor Cores** is set to **[Enabled]**.

Core 1-3

Allows you to enable or Core 1-3.

Configuration options: [Disabled] [Enabled]

Intel Virtualization Technology

When set to **[Enabled]**, a VMM can utilize the additional hardware capabilities provided by Vanderpool Technology.

Configuration options: [Disabled] [Enabled]

VT-d

Allows you to enable or disable CPU VT-d.

Configuration options: [Disabled] [Enabled]

Bi-directional PROCHOT

When a processor thermal sensor trips (either core), the PROCHOT# will be driven. If Bi-directional is set to **[Enabled]**, external agents can drive PROCHOT# to throttle the processor.

Configuration options: [Disabled] [Enabled]

Thermal Monitor

Allows you to enable or disable Thermal Monitor.

Configuration options: [Disabled] [Enabled]

Monitor Mwait

Allows you to enable or disable Monitor Mwait.

Configuration options: [Disabled] [Enabled]

P-STATE Coordination

Allows you to change the P-STATE Coordination type.

Configuration options: [HW_ALL] [SW_ALL] [SW_ANY]

DTS

Allows you to enable or disable the Digital Thermal Sensor.

Configuration options: [Disabled] [Enabled]

4.4.11 AMI Graphic Output Protocol Policy

NOTE: This option only appears if **OS type** in **Advanced** menu is set to **[Windows UEFI Mode]**.

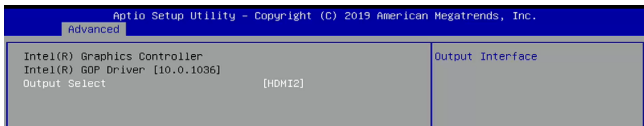

Output Select

Allows you to select the output interface.

Configuration options: [DVI2] [HDMI2]

4.4.12 PCI Subsystem Settings

Allows you to configure PCI, PCI-X, and PCI Express Settings.

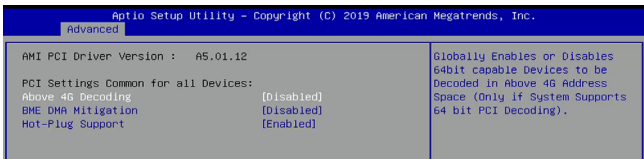

Above 4G Decoding

Allows you to enable or disable 64-bit capable devices to be decoded in above 4G address space. It only works if the system supports 64-bit PCI decoding.

Configuration options: [Disabled] [Enabled]

BME DMA Mitigation

Allows you to re-enable Bus Master Attribute disabled during Pci enumeration for PCI Bridges after SMM Locked.

Configuration options: [Disabled] [Enabled]

Hot-Plug Support

Globally enables or disables Hot-Plug support for the entire system. If system has Hot-Plug capable Slots and this option set to **[Enabled]**, it provides a Setup screen for selecting PCI resource padding for Hot-Plug. Configuration options: [Disabled] [Enabled]

4.4.13 USB Configuration

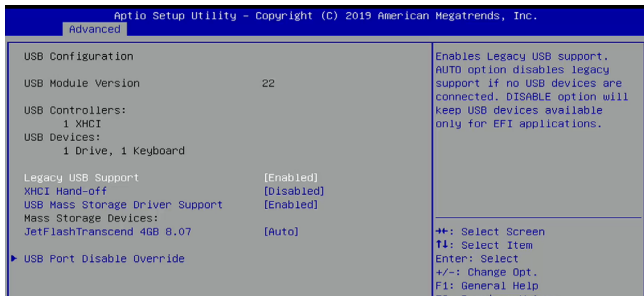

NOTE: The **USB Devices** item shows the auto-detected values. If no USB device is detected, the item shows **None**.

Legacy USB Support

- [Disabled] The USB devices can be used only for the BIOS setup program. It cannot be recognized in boot devices list.
- [Enabled] Enables the support for USB devices on legacy operating systems (OS).
- [Auto] Allows the system to detect the presence of USB devices at startup. If detected, the USB controller legacy mode is enabled. If no USB device is detected, the legacy USB support is disabled.

XHCI Hand-off

NOTE: This item is set to **[Disabled]** by default for the EHCI (enhanced host controller interface) support by XHCI drivers in operating systems.

[Disabled] Support XHCI by XHCI drivers for operating systems with XHCI support.

[Enabled] Support XHCI by BIOS for operating systems without XHCI support.

USB Mass Storage Driver Support

Allows you to enable or disable the USB Mass Storage driver support.

Configuration options: [Disabled] [Enabled]

USB Port Disable Override

Allows you to selectively enable or disable the corresponding USB port from reporting a Device connection to the controller.

U3_P1-4

Allows you to enable or disable USB port. Once set to **[Disabled]**, any USB devices plugged into the connector will not be detected by BIOS or OS.

Configuration options: [Disabled] [Enabled]

U2_P5-6

Allows you to enable or disable USB port. Once set to **[Disabled]**, any USB devices plugged into the connector will not be detected by BIOS or OS.

Configuration options: [Disabled] [Enabled]

4.4.14 Network Stack Configuration

Allows you to configure the network stack configuration.

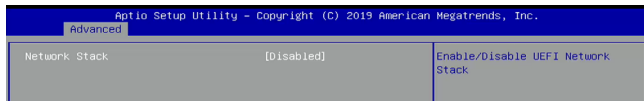

Network Stack

Allows you to enable or disable UEFI Network Stack.

Configuration options: [Disabled] [Enabled]

NOTE: The following items appear only when **Network Stack** is set to **[Enabled]**.

Ipv4 PXE Support

Enables or disables the Ipv4 PXE Boot Support. If disabled, Ipv4 PXE boot option will not be created.

Configuration options: [Disabled] [Enabled]

Ipv6 PXE Support

Enables or disables the Ipv6 PXE Boot Support. If disabled, Ipv6 PXE boot option will not be created.

Configuration options: [Disabled] [Enabled]

4.4.15 SDIO Configuration

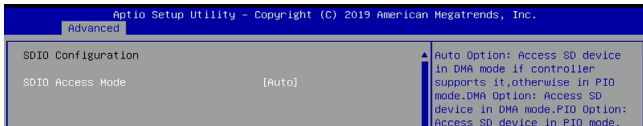

SDIO Access Mode

- [Auto] Access SD device in DMA mode if controller supports it, otherwise access SD device in PIO mode.
- [ADMA] Access SD device in ADMA mode.
- [SDMA] Access SD device in SDMA mode.
- [PIO] Access SD device in PIO mode.

4.4.16 Platform Trust Technology

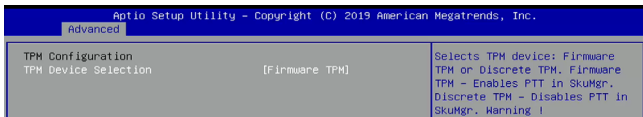

TPM Device Selection

Allows you to select the TPM device.

- [Firmware TPM] Enables PTT in SkuMgr.
- [Discrete TPM] Disables PTT in SkuMgr.

WARNING! Selecting **[Discrete TPM]** will disable PTT and Discrete TPM, and all data saved on it will be lost.

4.4.17 Security Configuration

Aptio Setup Utility - Copyright (C) 2019 American Megatrends, Inc.		
Advanced		
TXE HMRFP0	[Disabled]	Enable/Disable TXE HMRFP0
TXE EOP Message	[Enabled]	

TXE HMRFP0

Allows you to enable or disable TXE HMRFP0.

Configuration options: [Disabled] [Enabled]

TXE EOP Message

Allows you to enable or disable sending EOP Message before entering OS.

Configuration options: [Disabled] [Enabled]

4.4.18 Thermal

Aptio Setup Utility - Copyright (C) 2019 American Megatrends, Inc.		
Advanced		
Thermal Configuration Parameters		
Automatic Thermal Reporting	[Disabled]	Configure _CRT, _PSV and _ACO automatically based on values recommended in BWG's Thermal Reporting for Thermal Management settings. Set to Disabled for manual configuration.
Critical Trip Point	[125 C]	
Passive Trip Point	[111 C]	
Active Trip Point	[60 C]	

Automatic Thermal Reporting

Allows you to configure _CRT, _PSV, and _ACO automatically based on values recommended in BWG's Thermal Reporting for Thermal Management settings. Set to **[Disabled]** for manual configuration.

Configuration options: [Disabled] [Enabled]

NOTE: The following items appear only when **Automatic Thermal Reporting** is set to **[Disabled]**.

Critical Trip Point

This value controls the temperature of the ACPI Critical Trip Point - the point in which the OS will shut the system off.

Configuration options: [15 C] [23 C] [31 C] [39 C] [47 C] [55 C] [63 C] [71 C] [79 C] [87 C] [95 C] [100 C] [103 C] [110 C] [119 C] [125 C]

Passive Trip Point

This value controls the temperature of the ACPI Passive Trip Point - the point in which the OS will begin throttling the processor.

Configuration options: [95 C] [Disabled] [15 C] [23 C] [31 C] [39 C] [47 C] [55 C] [63 C] [71 C] [79 C] [87 C] [103 C] [111 C]

Active Trip Point

This value controls the temperature of the ACPI Active Trip Point - the point in which the OS will turn the fan on.

Configuration options: [15 C] [23 C] [31 C] [39 C] [47 C] [55 C] [60 C] [63 C] [71 C] [79 C] [87 C] [95 C] [103 C] [110 C]

NOTE: Please ignore this item for a Fanless system.

4.5 Security

This menu allows a new password to be created or a current password to be changed. The menu also enables or disables the Secure Boot state and lets the user configure the System Mode state.

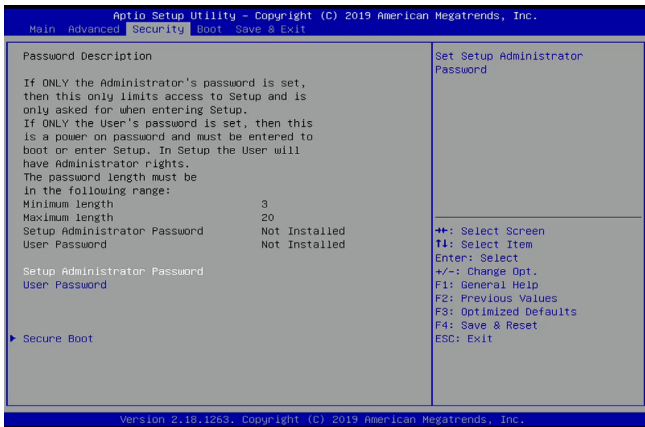

Administrator Password

To set an administrator password:

1. Select the Administrator Password item and press <Enter>.
2. From the Create New Password box, key in a password, then press <Enter>.
3. Confirm the password when prompted.

To change an administrator password:

1. Select the Administrator Password item and press <Enter>.
2. From the Enter Current Password box, key in the current password, then press <Enter>.
3. From the Create New Password box, key in a new password, then press <Enter>.
4. Confirm the password when prompted.

NOTE: To clear the administrator password, follow the same steps as in changing an administrator password, but press <Enter> when prompted to create/confirm the password.

User Password

To set a user password:

1. Select the User Password item and press <Enter>.
2. From the Create New Password box, key in a password, then press <Enter>.
3. Confirm the password when prompted.

To change a user password:

1. Select the User Password item and press <Enter>.
2. From the Enter Current Password box, key in the current password, then press <Enter>.
3. From the Create New Password box, key in a new password, then press <Enter>.
4. Confirm the password when prompted.

To clear a user password:

1. Select the Clear User Password item and press <Enter>.
2. Select Yes from the Warning message window then press <Enter>.

Secure Boot

Secure Boot can be enabled if the system is running in User mode with enrolled platform Key (EPK) or if the CSM function is disabled.

Configuration options: [\[Disabled\]](#) [\[Enabled\]](#)

Key Management

The Key Management item allows you to modify Secure Boot variables and set Key Management page.

Restore Factory Keys

Force System to User Mode. Configure NVRAM to contain OEM-defined factory default Secure Boot keys.

Reset to Setup Mode

Delete NVRAM content of all UEFI Secure Boot key databases.

Export Secure Boot Variables

Copy NVRAM content of source Boot variables to files in a root folder on a file system device.

Platform Key (PK)

Configuration options: [\[Details\]](#) [\[Export\]](#) [\[Update\]](#) [\[Delete\]](#)

Key Exchange Keys / Authorized Signatures / Forbidden Signatures

Configuration options: [\[Details\]](#) [\[Export\]](#) [\[Update\]](#) [\[Append\]](#) [\[Delete\]](#)

4.6 Boot menu

The Boot menu items allow you to change the system boot options.

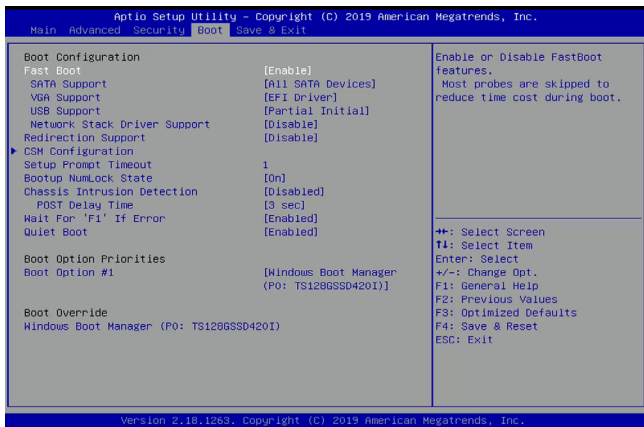

Fast Boot

[Disabled] Allows your system to go back to its normal boot speed.

[Enabled] Allows your system to accelerate the boot speed.

NOTE: The following items appear only when **Fast Boot** is set to **[Enabled]**.

SATA Support

[Last Boot SATA Devices Only] Only last boot SATA device will be available in POST.

[All SATA Devices] All SATA devices will be available in OS and POST.

VGA Support

[Auto] Only install the Legacy OpRom with Legacy OS and logo will not be shown during POST.

[EFI Driver] EFI driver will still be installed with the EFI OS.

USB Support

[Disabled] All USB devices will NOT be available until after OS boot.

[Full Initial] All USB devices will be available in OS and POST.

[Partial Initial] USB Mass Storage and specific USB port/device will NOT be available before OS boot.

Network Stack Driver Support

[Disabled] Network Stack Driver will be skipped.

[Enabled] Network Stack Driver will not be skipped.

Redirection Support

Allows you to enable or disable the Redirection function.

Configuration options: [Disabled] [Enabled]

CSM Configuration

NOTE: The options in this menu are only available if **Secure Boot** is set to **[Disabled]**.

CSM Support

This option allows you to enable or disable CSM Support.

Configuration options: [Disabled] [Enabled]

NOTE: The following items appear only when **CSM Support** is set to **[Enabled]**.

Boot Option filter

This option allows you to control the Legacy/UEFI ROMs priority.

Configuration options: [UEFI and Legacy] [Legacy only] [UEFI only]

Network / Storage / Video

This option allows you to control the execution of UEFI and Legacy PXE/ Storage/ Video OpROM.

Configuration options: [Do not launch] [UEFI] [Legacy]

Other PCI devices

This item determines the OpROM execution policy for devices other than Network, Storage, or Video.

Configuration options: [Do not launch] [UEFI] [Legacy]

Setup Prompt Timeout

Allows you to set the number of seconds to wait for setup activation key. 65535(0xFFFF) means indefinite waiting.

Configuration options: [1] - [65535]

Setup Prompt Timeout

Allows you to set the number of seconds to wait for setup activation key. 65535(0xFFFF) means indefinite waiting.

Configuration options: [1] - [65535]

Boot up NumLock State

[On] Set the power-on state of the NumLock to [On].

[Off] Set the power-on state of the NumLock to [Off].

Chassis Intrusion Detection

Allows you to enable or disable the chassis intrusion detection function.

Configuration options: [Disabled] [Enabled]

Post Delay Time

Allows you to select a desired additional POST waiting time to easily enter the BIOS Setup. You can only execute the POST delay time during normal boot. The values range from 0 to 10 seconds.

NOTE: This feature only works when set under normal boot.

Wait For 'F1' If Error

Enable this item for the system to pause until the F1 key is pressed when any error occurs.

Configuration options: [Disabled] [Enabled]

Quiet Boot

Allows you to enable or disable the Quiet Boot option.

Configuration options: [Disabled] [Enabled]

Boot Option Priorities

These items specify the boot device priority sequence from the available devices. The number of device items that appears on the screen depends on the number of devices installed in the system.

NOTE:

- To access Windows® OS in Safe Mode, press <F8> after POST (Windows® 8 not supported).
 - To select the boot device during system startup, press <F8> when the ASUS Logo appears.
-

Boot Override

These items displays the available devices. The number of device items that appears on the screen depends on the number of devices installed in the system. Click an item to start booting from the selected device.

4.7 Save & Exit menu

The Save & Exit menu items allow you to save or discard your changes to the BIOS items.

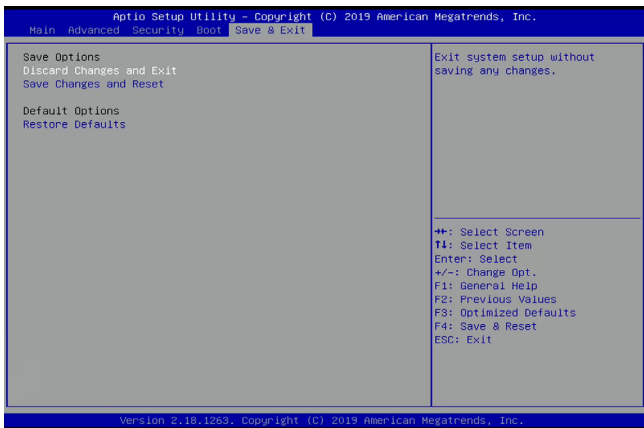

NOTE: Pressing <Esc> does not immediately exit this menu. Select one of the options from this menu or <F10> from the legend bar to exit.

Discard Changes and Exit

Exit System setup without saving any changes.

Save Changes and Reset

Exit System setup after saving the changes.

Restore Defaults

Restore/load default values for all the setup options.

4.8 Updating your BIOS

The following utilities allow you to manage and update the motherboard Basic Input/Output System (BIOS) setup:

1. **ASUS CrashFree BIOS 3**

To recover the BIOS using a bootable USB flash disk drive when the BIOS file fails or gets corrupted.

2. **ASUS EzFlash**

Updates the BIOS using a USB flash disk.

3. **BUPDATER**

Updates the BIOS in DOS mode using a bootable USB flash disk drive.

Refer to the corresponding sections for details on these utilities.

IMPORTANT! Save a copy of the original motherboard BIOS file to a bootable USB flash disk drive in case you need to restore the BIOS in the future. Copy the original motherboard BIOS using the BUPDATER utility.

4.8.1 **ASUS CrashFree BIOS 3 utility**

The ASUS CrashFree BIOS 3 is an auto recovery tool that allows you to restore the BIOS file when it fails or gets corrupted during the updating process. You can update a corrupted BIOS file using a USB flash drive that contains the updated BIOS file.

IMPORTANT! Prepare a USB flash drive containing the updated motherboard BIOS before using this utility.

Recovering the BIOS from a USB flash drive

To recover the BIOS from a USB flash drive:

1. Insert the USB flash drive with the original or updated BIOS file to one USB port on the system.
2. The utility will automatically recover the BIOS. It resets the system when the BIOS recovery finished.

WARNING! DO NOT shut down or reset the system while recovering the BIOS! Doing so would cause system boot failure!

NOTE: The recovered BIOS may not be the latest BIOS version for this motherboard. Visit the ASUS website at www.asus.com to download the latest BIOS file.

4.8.2 ASUS EzFlash Utility

The ASUS EzFlash Utility feature allows you to update the BIOS using a USB flash disk without having to use a DOS-based utility.

IMPORTANT! Download the latest BIOS from the ASUS website at www.asus.com before using this utility.

NOTE: The succeeding BIOS screens are for reference only. The actual BIOS screen displays may not be the same as shown.

To update the BIOS using EzFlash Utility:

1. Insert the USB flash disk that contains the latest BIOS file to the USB port.
2. Enter the BIOS setup program. Go to the **Advanced** menu to select **Start ASUS EzFlash** and press <Enter> to enable it.

WARNING! Ensure to back up your Bitlocker recovery key and suspend Bitlocker encryption in the operating system before updating your BIOS.

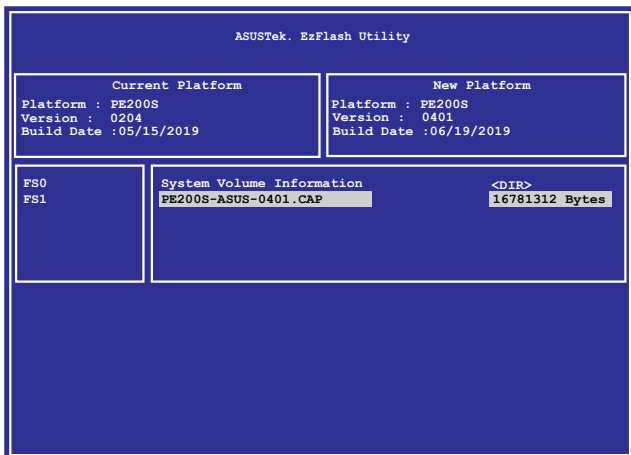

3. Press <Tab> to switch to the **Drive** field.
4. Press the Up/Down arrow keys to find the USB flash disk that contains the latest BIOS then press <Enter>.
5. Press <Tab> to switch to the **Folder** Info field.
6. Press the Up/Down arrow keys to find the BIOS file then press <Enter>.
7. Reboot the system when the update process is done.

WARNING

- This function can support devices such as a USB flash disk with FAT 32/16 format and single partition only.
 - DO NOT shut down or reset the system while updating the BIOS to prevent system boot failure!
-

IMPORTANT! Ensure to load the BIOS default settings to ensure system compatibility and stability. Press <F5> and select Yes to load the BIOS default settings.

4.8.3 BUPDATER utility

NOTE: The succeeding BIOS screens are for reference only. The actual BIOS screen displays may not be the same as shown.

The BUPDATER utility allows you to update the BIOS file in DOS environment using a bootable USB flash disk drive with the updated BIOS file.

Updating the BIOS file

To update the BIOS file using the BUPDATER utility:

1. Visit the ASUS website at www.asus.com and download the latest BIOS file for the motherboard. Save the BIOS file to a bootable USB flash disk drive.
2. Download the BUPDATER utility (BUPDATER.exe) from the ASUS support website at support.asus.com to the bootable USB flash disk drive you created earlier.
3. Boot the system in DOS mode, then at the prompt, type:

```
BUPDATER /i[filename].CAP
```

where [filename] is the latest or the original BIOS file on the bootable USB flash disk drive, then press <Enter>.

```
A:\>BUPDATER /i[file name]CAP
```

- The utility verifies the file, then starts updating the BIOS file.

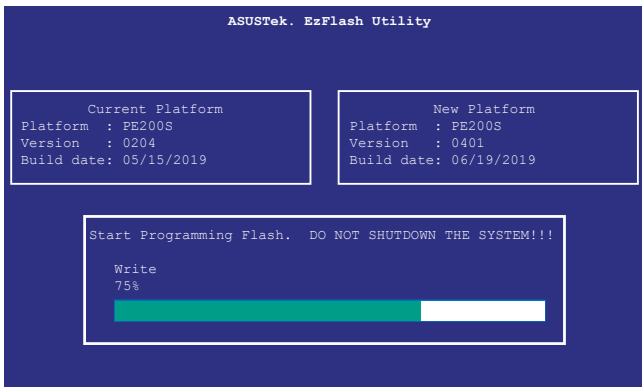

WARNING! DO NOT shut down or reset the system while updating the BIOS to prevent system boot failure!

- The utility returns to the DOS prompt after the BIOS update process is completed. Reboot the system from the hard disk drive.

```
The BIOS update is finished! Please restart your system.  
C:\>
```

Appendix

Safety information

Your Edge Computer is designed and tested to meet the latest standards of safety for information technology equipment. However, to ensure your safety, it is important that you read the following safety instructions.

Setting up your system

- Read and follow all instructions in the documentation before you operate your system.
- Do not use this product near water or a heated source.
- Set up the system on a stable surface.
- Peripherals with extended temperature tolerance (such as industrial grade DRAM, SSD, etc.) will allow this product to be used in environments with ambient temperatures between -20°C and 60°C, with a 0.1m/s air flow. If you plan to use a 2.5" HDD with this product, please use this product in environments with ambient temperatures between 0°C~45°C, with a 0.1m/s air flow.
- The product should be used in environments with an ambient temperature of 45°C when using the 65W adapter, whilst using HDD or SSD only and without the PoE module installed.
- If you use an extension cord, make sure that the total ampere rating of the devices plugged into the extension cord does not exceed its ampere rating.
- This equipment should be installed and operated with a minimum distance of 20cm between the radiator and your body.
- Restricted Access Location:
The equipment should only be installed in a Restricted Access Area where both these conditions apply:
 - access can only be gained by USERS who have been instructed about the reasons for the restrictions applied to the location and about any precautions that shall be taken; and
 - access is through the use of a TOOL or lock and key, or other means of security, and is controlled by the authority responsible for the location.
- This device shall not be connected to an Ethernet network with outside plant routing.

Care during use

- Do not walk on the power cord or allow anything to rest on it.
- Do not spill water or any other liquids on your system.
- When the system is turned off, a small amount of electrical current still flows. Always unplug the power cord from the power outlets before cleaning the system.
- If you encounter the following technical problems with the product, unplug the power cord and contact a qualified service technician or your retailer.
 - The power cord or plug is damaged.
 - Liquid has been spilled into the system.
 - The system does not function properly even if you follow the operating instructions.
 - The system was dropped or the cabinet is damaged.
 - The system performance changes.

Lithium-Ion Battery Warning

CAUTION: Danger of explosion if battery is incorrectly replaced. Replace only with the same or equivalent type recommended by the manufacturer. Dispose of used batteries according to the manufacturer's instructions.

NO DISASSEMBLY

The warranty does not apply to the products that have been disassembled by users



DO NOT throw the Edge Computer in municipal waste. This product has been designed to enable proper reuse of parts and recycling. This symbol of the crossed out wheeled bin indicates that the product (electrical, electronic equipment, and mercury-containing button cell battery) should not be placed in municipal waste. Check local technical support services for product recycling.

Regulatory notices

COATING NOTICE

IMPORTANT! To provide electrical insulation and maintain electrical safety, a coating is applied to insulate the device except on the areas where the I/O ports are located.

Federal Communications Commission Statement

This device complies with Part 15 of the FCC Rules. Operation is subject to the following two conditions:

- This device may not cause harmful interference, and
- This device must accept any interference received including interference that may cause undesired operation.

This equipment has been tested and found to comply with the limits for a Class A digital device, pursuant to part 15 of the FCC Rules. These limits are designed to provide reasonable protection against harmful interference when the equipment is operated in a commercial environment.

This equipment generates, uses, and can radiate radio frequency energy and, if not installed and used in accordance with the instruction manual, may cause harmful interference to radio communications. Operation of this equipment in a residential area is likely to cause harmful interference in which case the user will be required to correct the interference at his own expense.

IMPORTANT! Outdoor operations in the 5.15~5.25 GHz band is prohibited. This device has no Ad-hoc capability for 5250~5350 and 5470~5725 MHz.

CAUTION! Any changes or modifications not expressly approved by the grantee of this device could void the user's authority to operate the equipment.

RF exposure warning

This equipment must be installed and operated in accordance with provided instructions and the antenna(s) used for this transmitter must be installed to provide a separation distance of at least 20 cm from all persons and must not be co-located or operating in conjunction with any other antenna or transmitter. End-users and installers must be provide with antenna installation instructions and transmitter operating conditions for satisfying RF exposure compliance.

End Product Labeling

This transmitter module is authorized only for use in device where the antenna may be installed such that 20cm may be maintained between the antenna and users. The final end product must be labeled in a visible area with the following:

Contains FCC ID: TX2-RTL8822CE and Contains IC:6317A-RTL8822CE

ISED Radiation Exposure Statement for Canada

This equipment complies with ISED radiation exposure limits set forth for an uncontrolled environment. To maintain compliance with ISED RF exposure compliance requirements, please avoid direct contact to the transmitting antenna during transmitting. End users must follow the specific operating instructions for satisfying RF exposure compliance.

Operation is subject to the following two conditions:

- This device may not cause interference and
- This device must accept any interference, including interference that may cause undesired operation of the device.

Compliance Statement of Innovation, Science and Economic Development Canada (ISED)

This device complies with Innovation, Science and Economic Development Canada licence exempt RSS standard(s). Operation is subject to the following two conditions: (1) this device may not cause interference, and (2) this device must accept any interference, including interference that may cause undesired operation of the device.

CAN ICES-3(A)/NMB-3(A)

Déclaration de conformité de Innovation, Sciences et Développement économique Canada (ISED)

Le présent appareil est conforme aux CNR d'Innovation, Sciences et Développement économique Canada applicables aux appareils radio exempts de licence. L'exploitation est autorisée aux deux conditions suivantes : (1) l'appareil ne doit pas produire de brouillage, et (2) l'utilisateur de l'appareil doit accepter tout brouillage radioélectrique subi, même si le brouillage est susceptible d'en compromettre le fonctionnement.

CAN ICES-3(A)/NMB-3(A)

Wireless Operation Channel for Different Domains

N. America	2.412-2.462 GHz	Ch01 through CH11
Japan	2.412-2.484 GHz	Ch01 through Ch14
Europe ETSI	2.412-2.472 GHz	Ch01 through Ch13

KC: Korea Warning Statement

Class A:

사용자 안내문

이 기기는 업무용 환경에서 사용할 목적으로 적합성평가를 받은 기기로서 가정용 환경에서 사용하는 경우 전파간섭의 우려가 있습니다.

VCCI: Japan Compliance Statement

Class A ITE

この装置は、クラスA機器です。この装置を住宅環境で使用すると電波妨害を引き起こすことがあります。この場合には使用者が適切な対策を講ずるよう要求されることがあります。

VCCI - A

Japan RF Equipment Statement

屋外での使用について

本製品は、5GHz帯域での通信に対応しています。電波法の定めにより5.2GHz、5.3GHz帯域の電波は屋外で使
用が禁じられています。

法律および規制遵守

本製品は電波法及びこれに基づく命令の定めるところに従い使用してください。日本国外では、その国の法律ま

たは規制により、本製品の使用ができないことがあります。このような国では、本製品を運用した結果、罰せられ

ることがありますが、当社は一切責任を負いかねますのでご了承ください。

Declaration of compliance for product environmental regulation

ASUS follows the green design concept to design and manufacture our products, and makes sure that each stage of the product life cycle of ASUS product is in line with global environmental regulations. In addition, ASUS disclose the relevant information based on regulation requirements.

Please refer to <http://csr.asus.com/Compliance.htm> for information disclosure based on regulation requirements ASUS is complied with:

EU REACH and Article 33

Complying with the REACH (Registration, Evaluation, Authorization, and Restriction of Chemicals) regulatory framework, we publish the chemical substances in our products at ASUS REACH website at

<http://csr.asus.com/english/REACH.htm>

EU RoHS

This product complies with the EU RoHS Directive. For more details, see

<http://csr.asus.com/english/article.aspx?id=35>

Japan JIS-C-0950 Material Declarations

Information on Japan RoHS (JIS-C-0950) chemical disclosures is available on

<http://csr.asus.com/english/article.aspx?id=19>

India RoHS

This product complies with the “India E-Waste (Management) Rules, 2016” and prohibits use of lead, mercury, hexavalent chromium, polybrominated biphenyls (PBBs) and polybrominated diphenyl ethers (PBDEs) in concentrations exceeding 0.1% by weight in homogenous materials and 0.01% by weight in homogenous materials for cadmium, except for the exemptions listed in Schedule II of the Rule.

Vietnam RoHS

ASUS products sold in Vietnam, on or after September 23, 2011, meet the requirements of the Vietnam Circular 30/2011/TT-BCT.

Các sản phẩm ASUS bán tại Việt Nam, vào ngày 23 tháng 9 năm 2011 trở về sau, đều phải đáp ứng các yêu cầu của Thông tư 30/2011/TT-BCT của Việt Nam.

Turkey RoHS

AEEE Yönetmeliğine Uygundur

ASUS Recycling/Takeback Services

ASUS recycling and takeback programs come from our commitment to the highest standards for protecting our environment. We believe in providing solutions for you to be able to responsibly recycle our products, batteries, other components as well as the packaging materials. Please go to <http://csr.asus.com/english/Takeback.htm> for detailed recycling information in different regions.

Ecodesign Directive

European Union announced a framework for the setting of ecodesign requirements for energy-related products (2009/125/EC). Specific Implementing Measures are aimed at improving environmental performance of specific products or across multiple product types. ASUS provides product information on the CSR website. The further information could be found at <https://csr.asus.com/english/article.aspx?id=1555>.

ENERGY STAR complied product



ENERGY STAR is a joint program of the U.S. Environmental Protection Agency and the U.S. Department of Energy helping us all save money and protect the environment through energy efficient products and practices.

All ASUS products with the ENERGY STAR logo comply with the ENERGY STAR standard, and the power management feature is enabled by default. The monitor is automatically set to sleep within 10 minutes of user inactivity; the computer is automatically set to sleep within 30 minutes of user inactivity. To wake your computer, click the mouse, press any key on the keyboard, or press the power button.

Please visit <http://www.energystar.gov/powermanagement> for detail information on power management and its benefits to the environment. In addition, please visit <http://www.energystar.gov> for detail information on the ENERGY STAR joint program.

NOTE: Energy Star is NOT supported on FreeDOS and Linux-based products.

Manufacturer	ASUSTeK Computer Inc.	
	Tel:	+886-2-2894-3447
	Address:	1F, No. 15, Lide Rd., Beitou Dist., Taipei City 112, Taiwan
Authorised representative in Europe	ASUSTeK Computer GmbH	
	Address:	Harkortstrasse 21-23, 40880 Ratingen, Germany

ASUS contact information

ASUSTeK COMPUTER INC.

Address	1F., No. 15, Lide Rd., Beitou Dist., Taipei City 112, Taiwan
Telephone	+886-2-2894-3447
Fax	+886-2-2890-7798
Web site	www.asus.com

Technical Support

Telephone	+86-21-38429911
Fax	+86-21-5866-8722, ext. 9101#
Online support	https://www.asus.com/support/Product/ContactUs/Services/questionform/?lang=en

ASUS COMPUTER INTERNATIONAL (America)

Address	48720 Kato Rd., Fremont, CA 94538, USA
Telephone	+1-510-739-3777
Fax	+1-510-608-4555
Web site	http://www.asus.com/us/

Technical Support

Support fax	+1-812-284-0883
Telephone	+1-812-282-2787
Online support	https://www.asus.com/support/Product/ContactUs/Services/questionform/?lang=en-us

ASUS COMPUTER GmbH (Germany and Austria)

Address	Harkortstrasse 21-23, 40880 Ratingen, Germany
Web site	https://www.asus.com/de
Online contact	https://www.asus.com/support/Product/ContactUs/Services/questionform/?lang=de-de

Technical Support

Telephone (DE)	+49-2102-5789557
Telephone (AT)	+43-1360-2775461
Online support	https://www.asus.com/de/support

Call center:	https://www.asus.com/support/CallUs
---------------------	---

