



# User's Manual

**TECRA A40-K**

**TECRA A50-K**

**PORTEGE X40-K**

---

# Table of Contents

<i>Chapter 1</i>	<b>Legal, Regulatory, and Safety</b>	
	Copyright, Disclaimer and Trademarks .....	1-1
	Regulatory Information .....	1-2
	Video Standard Notice .....	1-10
	OpenSSL Toolkit License Issues .....	1-10
	FreeType License Issues .....	1-12
	ENERGY STAR® Program .....	1-16
	Disposing of the computer and the computer's battery .....	1-16
	General Precautions .....	1-17
	Safety Icons .....	1-19
<i>Chapter 2</i>	<b>Getting Started</b>	
	Equipment checklist .....	2-1
	Conventions .....	2-1
	Short model name .....	2-2
	Using your computer for the first time .....	2-2
	Getting to know Windows .....	2-8
	Turning off the power .....	2-10
	System Recovery .....	2-13
<i>Chapter 3</i>	<b>The Grand Tour</b>	
	The Grand Tour for PORTEGE Series .....	3-1
	The Grand Tour for TECRA/SATELLITE PRO/dynabook Series .....	3-8
	Internal Hardware Components .....	3-18
	Power Condition Descriptions .....	3-18
<i>Chapter 4</i>	<b>Operating Basics</b>	
	Using the Touch Screen .....	4-1
	Using the Touch Pad .....	4-2
	The Keyboard .....	4-3
	Using the Fingerprint Sensor .....	4-6
	Battery .....	4-8
	Memory media .....	4-12
	Smart Card .....	4-15
	Additional memory module .....	4-16
	Wireless WAN device .....	4-19
	GPS Function .....	4-20
	HDMI™ out port .....	4-21

---

	<b>LAN .....</b>	<b>4-22</b>
	<b>USB Type-C™ Adapters .....</b>	<b>4-24</b>
	<b>Wireless display .....</b>	<b>4-26</b>
	<b>Security lock .....</b>	<b>4-27</b>
	<b>Optional Accessories .....</b>	<b>4-27</b>
	<b>Sound System and Video mode .....</b>	<b>4-28</b>
<i>Chapter 5</i>	<b>Utilities and Advanced Usage</b>	
	<b>Utilities and Applications .....</b>	<b>5-1</b>
	<b>Special features .....</b>	<b>5-10</b>
<i>Chapter 6</i>	<b>Troubleshooting</b>	
	<b>Problem-solving process .....</b>	<b>6-1</b>
	<b>Hardware and system checklist .....</b>	<b>6-4</b>
	<b>Technical support .....</b>	<b>6-16</b>
<i>Chapter 7</i>	<b>Appendix</b>	
	<b>Specifications .....</b>	<b>7-1</b>
	<b>AC Power Cord and Connectors .....</b>	<b>7-2</b>
	<b>Information for Wireless Devices .....</b>	<b>7-4</b>
	<b>Information about Intel® AMT .....</b>	<b>7-15</b>
	<b>Accessibility .....</b>	<b>7-18</b>
	<b>Accessibility for Dynabook notebook .....</b>	<b>7-18</b>
	<b>Legal Footnotes .....</b>	<b>7-21</b>
	<b>Index</b>	

---

# Chapter 1

## Legal, Regulatory, and Safety

This chapter states the legal, regulatory, and safety information applicable to your computer.

### Copyright, Disclaimer and Trademarks

#### Copyright

© 2022 Dynabook Inc. All Rights Reserved. Under the copyright laws, this manual cannot be reproduced in any form without the prior written permission of Dynabook Inc. No patent liability is assumed, with respect to the use of the information contained herein.

First edition January 2022

Copyright authority for music, movies, computer programs, databases and other intellectual property covered by copyright laws belongs to the author or to the copyright owner. Copyrighted material can be reproduced only for personal use or use within the home. Any other use beyond that stipulated above (including conversion to digital format, alteration, transfer of copied material and distribution on a network) without the permission of the copyright owner is a violation of copyright or author's rights and is subject to civil damages or criminal action. Comply with copyright laws in making any reproduction from this manual.

#### Disclaimer

This manual has been validated and reviewed for accuracy. The instructions and descriptions it contains are accurate for your computer at the time of this manual's production. However, succeeding computers and manuals are subject to change without notice. Dynabook Inc. assumes no liability for damages incurred directly or indirectly from errors, omissions or discrepancies between the computer and the manual.

Any references in this Guide to "Dynabook" shall mean Dynabook Inc. and/or its affiliates.

#### Trademarks

Intel, Intel logo, Thunderbolt, Thunderbolt logo are trademarks of Intel Corporation or its subsidiaries in the United States and/or other countries.

Microsoft, Windows are either registered trademarks or trademarks of Microsoft Corporation in the United States and/or other countries.

---

The Bluetooth® word mark is a registered trademark owned by Bluetooth SIG, Inc.

The terms HDMI and HDMI High-Definition Multimedia Interface, and the HDMI Logo are trademarks or registered trademarks of HDMI Licensing Administrator, Inc. in the United States and other countries.

DTS, the Symbol, & DTS and the Symbol together are registered trademarks and DTS Audio Processing is a trademark of DTS, Inc.

Wi-Fi is a registered trademark of Wi-Fi Alliance.

USB Type-C™ and USB-C™ are trademarks of USB Implementers Forum.

All other company names, product names, and service names mentioned herein may be trademarks of their respective companies.

## Regulatory Information



*The regulatory information herein might vary. Check the ID information on the bottom of the device or box for specific information applicable to the model you purchased.*

### FCC information

#### ***This device complies with FCC RF exposure requirements***

This equipment has been tested and found to comply with the limits for a Class B digital device, pursuant to part 15 of the FCC rules. These limits are designed to provide reasonable protection against harmful interference in a residential installation. This equipment generates, uses and can radiate radio frequency energy and, if not installed and used in accordance with the instructions, may cause harmful interference to radio communications. However, there is no guarantee that interference will not occur in a particular installation. If this equipment does cause harmful interference to radio or television reception, which can be determined by turning the equipment off and on, the user is encouraged to try to correct the interference by one or more of the following measures:

- Reorient or relocate the receiving antenna.
- Increase the separation between the equipment and receiver.
- Connect the equipment into an outlet on a circuit different from that to which the receiver is connected.
- Consult the dealer or an experienced radio/TV technician for help.



*Only peripherals complying with the FCC class B limits can be attached to this equipment. Operation with non-compliant peripherals or peripherals not recommended by Dynabook is likely to result in interference to radio and TV reception. Shielded cables must be used between the external devices and the computer's Universal Serial Bus (USB 3.2 Gen1) port,*

---

*Thunderbolt™ 4/USB Type-C™ port and HDMI™ out port. Changes or modifications made to this equipment, not expressly approved by Dynabook or parties authorized by Dynabook could void the user's authority to operate the equipment.*

### **FCC conditions**

This device complies with part 15 of the FCC Rules. Operation is subject to the following two conditions:

1. This device may not cause harmful interference.
2. This device must accept any interference received, including interference that may cause undesired operation.

### **Contact**

**Address:** Dynabook Americas, Inc.  
5241 California Avenue, Suite 100  
Irvine, California, USA, 92617

**Telephone:** (949) 583-3000



*This information is only applicable for the countries/regions where it is required.*

## **California Prop 65 Warning**



*This product contains chemicals, including lead, known to the State of California to cause cancer and birth defects or other reproductive harm.  
**Wash hands after handling.***



For the state of California only.

## **Export Administration Regulation**

This document contains technical data that may be controlled under the U.S. Export Administration Regulations, and may be subject to the approval of the U.S. Department of Commerce prior to export. Any export, directly or indirectly, in contravention of the U.S. Export Administration Regulations is prohibited.

---

## EU Declaration of Conformity



This product is carrying the CE mark in accordance with the related European Directives. Responsible for CE marking is Dynabook Europe GmbH, Stresemannallee 4b, 41460 Neuss, Germany. The complete and official EU Declaration of Conformity can be found on the website

<https://emea.dynabook.com/product-conformity>.

### ***CE compliance***

Hereby, Dynabook Europe GmbH declares that the model(s) described in this manual is/are in compliance with Directive 2014/53/EU.

The full text of the EU declaration of conformity is available at the following internet address: <https://emea.dynabook.com/product-conformity>.

This product is labeled with the CE mark in accordance with the essential requirements and other relevant provisions of the applicable European Directives, notably Radio Equipment Directive (2014/53/EU), RoHS Directive 2011/65/EU, Ecodesign Directive 2009/125/EC (ErP) and the related implementing measures.

This product and the original accessories are designed to observe the applicable EMC (Electromagnetic Compatibility) standards. However, Dynabook cannot guarantee that this product still observes these EMC standards if accessories or cables not produced by Dynabook are connected or implemented. In this case the persons who have connected/implemented those accessories/cables have to provide assurance that the system (PC plus accessories/cables) still fulfils the required standards. To avoid in general EMC problems, the following guidance should be noted:

- Only CE marked accessories should be connected/implemented.
- Only best shielded cables should be connected.

### ***Working environment***

This product was designed to fulfil the EMC (Electromagnetic Compatibility) requirements to be observed for so-called "residential, commercial and light industry environments". Dynabook does not recommend the use of this product in working environments other than the above listed working environment.

For example, the following environments are not verified:

- Industrial environments (e.g. environments where a mains voltage of 380 V three-phase is used)
- Medical environments (according to Medical Device Directive)
- Automotive environments
- Aircraft environments

---

Any consequences resulting from the use of this product in working environments that are not verified/recommended are not the responsibility of Dynabook.

The consequences of the use of this product in non-verified working environments may be:

- Interference with other devices or machines in the near surrounding area
- Malfunction of, or data loss from, this product caused by disturbances generated by other devices or machines in the near surrounding area

Therefore Dynabook strongly recommends that the electromagnetic compatibility of this product should be suitably tested in all non-verified working environments before use. In the case of vehicles or aircraft, the manufacturer or airline operator respectively should be asked for permission before use of this product.

Furthermore, for general safety reasons, the use of this product in environments with explosive atmospheres is not permitted.

## VCCI Class B Information (Japan Only)

この装置は、クラスB情報技術装置です。この装置は、家庭環境で使用することを目的としていますが、この装置がラジオやテレビジョン受信機に近接して使用されると、受信障害を引き起こすことがあります。取扱説明書に従って正しい取り扱いをしてください。

VCCI-B

## Canadian regulatory information (Canada only)

This digital apparatus does not exceed the Class B limits for radio noise emissions from digital apparatus as set out in the Radio Interference Regulation of the Canadian Department of Communications.

Note that Canadian Department of Communications (DOC) regulations provide, that changes or modifications not expressly approved by Dynabook could void your authority to operate this equipment.

This Class B digital apparatus meets all requirements of the Canadian Interference-Causing Equipment Regulations.

Cet appareil numérique de la classe B respecte toutes les exigences du Règlement sur le matériel brouilleur du Canada.

## Canadian Notice

This device complies with ISED (formerly Industry Canada) license-exempt RSS standard(s).

Operation is subject to the following two conditions: (1) this device may not cause interference, and (2) this device must accept any interference, including interference that may cause undesired operation of the device.



---

*Le présent appareil est conforme aux CNR d'Industrie Canada applicables aux appareils radio exempts de licence. L'exploitation est autorisée aux deux conditions suivantes : (1) l'appareil ne doit pas produire de brouillage, et (2) l'appareil doit accepter tout brouillage radioélectrique subi, même si le brouillage est susceptible d'en compromettre le fonctionnement.*



- *To comply with the Canadian RF exposure compliance requirements, this device and its antenna must not be co-located or operating in conjunction with any other antenna or transmitter.*

*Pour être conforme aux exigences canadiennes en matière d'exposition aux fréquences radio, l'appareil et son antenne ne doivent pas être situés au même endroit qu'une autre antenne ou un autre émetteur ni fonctionner en même temps.*

- *This device is restricted to indoor use due to its operation in the 5.15 GHz to 5.25 GHz frequency range. FCC requires this product to be used indoors for frequency range 5.15 GHz to 5.25 GHz to reduce the potential for harmful interference to co-channel Mobile Satellite systems.*

*High power radars are allocated as primary users of the 5.25 GHz to 5.35 GHz and 5.65 GHz to 5.85 GHz bands. These radar stations can cause interference with and/or damage this device.*

*Les dispositifs fonctionnant dans la bande 5150-5250 MHz sont réservés uniquement pour une utilisation à l'intérieur afin de réduire les risques de brouillage préjudiciable aux systèmes de satellites mobiles utilisant les mêmes canaux.*

*Veillez noter que les utilisateurs de radars de haute puissance sont désignés utilisateurs principaux (c.-à-d., qu'ils ont la priorité) pour les bandes 5250-5350 MHz et 5650-5850 MHz et que ces radars pourraient causer du brouillage et/ou des dommages aux dispositifs LAN-EL.*



*The above caution applies to products that operate with an 802.11a/n/ac/ax radio device.*

*La mise en garde ci-dessus ne s'applique qu'aux appareils ayant un transmetteur opérant en mode 802.11a/n/ac/ax.*

---

## Following information is only valid for EU member states:

### **Information requirements Regulation EC 1275/2008**

Additional information as required by Regulation (EC) 1275/2008 amended by Regulation (EU) 801/2013 implementing European Ecodesign Directive with regard to requirements for standby, off mode and networked standby electric power consumption of electrical and electronic household and office equipment can be found here: <http://emea.dynabook.com/environment>.

### **Disposal of products**



The crossed-out wheeled bin symbol indicates that products must be collected and disposed of separately from household waste. Integrated batteries and accumulators can be disposed of with the product. They will be separated at the recycling centres.

The black bar indicates that the product was placed on the market after August 13, 2005.

By participating in the separate collection of products and batteries, you will help to assure the proper disposal of products and batteries and thus help to prevent potential negative consequences for the environment and human health.

For more detailed information about the collection and recycling programmes available in your country, please visit our website <http://emea.dynabook.com/environment> or contact your local council office or the retail outlet where you purchased the product.

## ***Disposal of batteries and/or accumulators***



Pb, Hg, Cd

The crossed out wheeled dust bin symbol indicates that batteries and/or accumulators must be collected and disposed of separately from household waste.

If the battery or accumulator contains more than the specified values of lead (Pb), mercury (Hg), and/or cadmium (Cd) defined in the European Battery Directive, then the chemical symbols for lead (Pb), mercury (Hg) and/or cadmium (Cd) will appear below the crossed out wheeled dust bin symbol.

By participating in the separate collection of batteries, you will help to assure the proper disposal of products and batteries and thus help to prevent potential negative consequences for the environment and human health. To achieve this you should take any battery and/or accumulator to your local recycling site, or to a retail outlet or facility that offers to collect these devices for environmentally friendly disposal, ensuring that the terminal contacts are covered by non-conductive tape.

For more detailed information about the collection and recycling programmes available in your country, please visit our website <http://emea.dynabook.com/environment> or contact your local council office or the retail outlet where you purchased the product.



*These symbols might not stick depending on the country and region where you purchased.*

## **REACH - Compliance Statement**

The European Union (EU) chemical regulation, REACH (Registration, Evaluation, Authorization and Restriction of Chemicals), entered into force on 1 June 2007, with phased deadlines to 2018.

Dynabook will meet all REACH requirements and is committed to provide our customers with information about the presence in our articles of substances included on the candidate list according to REACH regulation.

Please consult the following website

<http://emea.dynabook.com/environment> for information about the presence in our articles of substances included on the candidate list according to REACH in a concentration above 0.1 % weight by weight.

## Following information is only for Turkey:

- Disposal of products:



The crossed-out wheelee bin symbol means that this product should not be collected and disposed of with other household waste. When the product becomes waste at its end of life, to protect environment and human health, it should be given to the nearest collection, recycling or disposal center. For more information about collection and recycling programs in your country please contact your local authority or the retailer where the product was purchased.

- Dynabook meets all requirements of Turkish regulation 28300 "Restriction of the use of certain hazardous substances in electrical and electronic equipment".

### **AEEE Yönetmeliğine Uygundur**

Dynabook 28300 sayılı Türkiye "Elektrikle çalışan ve elektronik ekipmanda belirli tehlikeli maddelerin kullanımıyla ilgili kısıtlama" yönetmeliği gereklerini tamamen yerine getirmektedir.

- The number of possible pixel failures of your display is defined according to ISO 9241-307 standards. If the number of pixel failures is less than this standard, they will not be counted as defect or failure.
- Battery is a consumption product, since the battery time depends on the usage of your computer. If the battery can not be charged at all, then it is a defect or failure. The changes in battery time is not a defect or failure.

## Following information is only for India:



The use of this symbol indicates that this product may not be treated as household waste.

By ensuring this product is disposed of correctly, you will help prevent potential negative consequences for the environment and human health, which could otherwise be caused by inappropriate waste handling of this product.

For more detailed information about recycling of this product, please visit our website

<https://asia.dynabook.com> or contact call center (1800 200 6768).



*These symbols might not stick depending on the country and region where you purchased.*

---

## Video Standard Notice

THIS PRODUCT IS LICENSED UNDER THE AVC, THE VC-1 AND MPEG-4 VISUAL PATENT PORTFOLIO LICENSE FOR THE PERSONAL AND NON-COMMERCIAL USE OF A CONSUMER FOR (I) ENCODING VIDEO IN COMPLIANCE WITH THE ABOVE STANDARDS ("VIDEO") AND/OR (II) DECODING AVC, VC-1 AND MPEG-4 VIDEO THAT WAS ENCODED BY A CONSUMER ENGAGED IN A PERSONAL AND NONCOMMERCIAL ACTIVITY AND/OR WAS OBTAINED FROM A VIDEO PROVIDER LICENSED BY MPEG LA TO PROVIDE SUCH VIDEO. NO LICENSE IS GRANTED OR SHALL BE IMPLIED FOR ANY OTHER USE. ADDITIONAL INFORMATION INCLUDING THAT RELATING TO PROMOTIONAL, INTERNAL AND COMMERCIAL USES AND LICENSING MAY BE OBTAINED FROM MPEG LA, L.L.C. SEE <http://www.mpegla.com>.

## OpenSSL Toolkit License Issues

### LICENSE ISSUES

=====

The OpenSSL toolkit stays under a dual license, i.e. both the conditions of the OpenSSL License and the original SSLeay license apply to the toolkit. See below for the actual license texts. Actually both licenses are BSD-style Open Source licenses. In case of any license issues related to OpenSSL please contact [openssl-core@openssl.org](mailto:openssl-core@openssl.org)

### OpenSSL License

-----

/\*=====

Copyright (c) 1998-2019 The OpenSSL Project. All rights reserved.

Redistribution and use in source and binary forms, with or without modification, are permitted provided that the following conditions are met:

1. Redistributions of source code must retain the above copyright notice, this list of conditions and the following disclaimer.
2. Redistributions in binary form must reproduce the above copyright notice, this list of conditions and the following disclaimer in the documentation and/or other materials provided with the distribution.
3. All advertising materials mentioning features or use of this software must display the following acknowledgment:

"This product includes software developed by the OpenSSL Project for use in the OpenSSL Toolkit."

<http://www.openssl.org>.

4. The names "OpenSSL Toolkit" and "OpenSSL Project" must not be used to endorse or promote products derived from this software without prior written permission. For written permission, please contact [openssl-core@openssl.org](mailto:openssl-core@openssl.org).

- 
5. Products derived from this software may not be called "OpenSSL" nor may "OpenSSL" appear in their names without prior written permission of the OpenSSL Project.
  6. Redistributions of any form whatsoever must retain the following acknowledgment:

"This product includes software developed by the OpenSSL Project for use in the OpenSSL Toolkit"

[\[http://www.openssl.org\]](http://www.openssl.org).

THIS SOFTWARE IS PROVIDED BY THE OpenSSL PROJECT ``AS IS'' AND ANY EXPRESSED OR IMPLIED WARRANTIES, INCLUDING, BUT NOT LIMITED TO, THE IMPLIED WARRANTIES OF MERCHANTABILITY AND FITNESS FOR A PARTICULAR PURPOSE ARE DISCLAIMED. IN NO EVENT SHALL THE OpenSSL PROJECT OR ITS CONTRIBUTORS BE LIABLE FOR ANY DIRECT, INDIRECT, INCIDENTAL, SPECIAL, EXEMPLARY, OR CONSEQUENTIAL DAMAGES (INCLUDING, BUT NOT LIMITED TO, PROCUREMENT OF SUBSTITUTE GOODS OR SERVICES; LOSS OF USE, DATA, OR PROFITS; OR BUSINESS INTERRUPTION) HOWEVER CAUSED AND ON ANY THEORY OF LIABILITY, WHETHER IN CONTRACT, STRICT LIABILITY, OR TORT (INCLUDING NEGLIGENCE OR OTHERWISE) ARISING IN ANY WAY OUT OF THE USE OF THIS SOFTWARE, EVEN IF ADVISED OF THE POSSIBILITY OF SUCH DAMAGE.

=====  
This product includes cryptographic software written by Eric Young ([eyay@cryptsoft.com](mailto:eyay@cryptsoft.com)). This product includes software written by Tim Hudson ([tjh@cryptsoft.com](mailto:tjh@cryptsoft.com)).

\*/

Original SSLeay License

-----  
/\* Copyright (C) 1995-1998 Eric Young ([eyay@cryptsoft.com](mailto:eyay@cryptsoft.com))

All rights reserved.

This package is an SSL implementation written by Eric Young ([eyay@cryptsoft.com](mailto:eyay@cryptsoft.com)).

The implementation was written so as to conform with Netscapes SSL.

This library is free for commercial and non-commercial use as long as the following conditions are adhered to. The following conditions apply to all code found in this distribution, be it the RC4, RSA, lhash, DES, etc., code; not just the SSL code. The SSL documentation included with this distribution is covered by the same copyright terms except that the holder is Tim Hudson ([tjh@cryptsoft.com](mailto:tjh@cryptsoft.com)).

Copyright remains Eric Young's, and as such any Copyright notices in the code are not to be removed.

If this package is used in a product, Eric Young should be given attribution as the author of the parts of the library used.

---

This can be in the form of a textual message at program startup or in documentation (online or textual) provided with the package.

Redistribution and use in source and binary forms, with or without modification, are permitted provided that the following conditions are met:

1. Redistributions of source code must retain the copyright notice, this list of conditions and the following disclaimer.
2. Redistributions in binary form must reproduce the above copyright notice, this list of conditions and the following disclaimer in the documentation and/or other materials provided with the distribution.
3. All advertising materials mentioning features or use of this software must display the following acknowledgement:

"This product includes cryptographic software written by Eric Young ([eay@cryptsoft.com](mailto:eay@cryptsoft.com))"

The word 'cryptographic' can be left out if the routines from the library being used are not cryptographic related :-).

4. If you include any Windows specific code (or a derivative thereof) from the apps directory (application code) you must include an acknowledgement:

"This product includes software written by Tim Hudson ([tjh@cryptsoft.com](mailto:tjh@cryptsoft.com))"

THIS SOFTWARE IS PROVIDED BY ERIC YOUNG ``AS IS" AND ANY EXPRESS OR IMPLIED WARRANTIES, INCLUDING, BUT NOT LIMITED TO, THE IMPLIED WARRANTIES OF MERCHANTABILITY AND FITNESS FOR A PARTICULAR PURPOSE ARE DISCLAIMED. IN NO EVENT SHALL THE AUTHOR OR CONTRIBUTORS BE LIABLE FOR ANY DIRECT, INDIRECT, INCIDENTAL, SPECIAL, EXEMPLARY, OR CONSEQUENTIAL DAMAGES (INCLUDING, BUT NOT LIMITED TO, PROCUREMENT OF SUBSTITUTE GOODS OR SERVICES; LOSS OF USE, DATA, OR PROFITS; OR BUSINESS INTERRUPTION) HOWEVER CAUSED AND ON ANY THEORY OF LIABILITY, WHETHER IN CONTRACT, STRICT LIABILITY, OR TORT (INCLUDING NEGLIGENCE OR OTHERWISE) ARISING IN ANY WAY OUT OF THE USE OF THIS SOFTWARE, EVEN IF ADVISED OF THE POSSIBILITY OF SUCH DAMAGE.

The licence and distribution terms for any publically available version or derivative of this code cannot be changed. i.e. this code cannot simply be copied and put under another distribution licence [including the GNU Public Licence.]

\*/

## FreeType License Issues

The FreeType Project LICENSE

-----  
2006-Jan-27

---

Copyright 1996-2002, 2006 by

David Turner, Robert Wilhelm, and Werner Lemberg

## Introduction

=====

The FreeType Project is distributed in several archive packages; some of them may contain, in addition to the FreeType font engine, various tools and contributions which rely on, or relate to, the FreeType Project.

This license applies to all files found in such packages, and which do not fall under their own explicit license. The license affects thus the FreeType font engine, the test programs, documentation and makefiles, at the very least.

This license was inspired by the BSD, Artistic, and IJG (Independent JPEG Group) licenses, which all encourage inclusion and use of free software in commercial and freeware products alike. As a consequence, its main points are that:

- We don't promise that this software works. However, we will be interested in any kind of bug reports. ('as is' distribution)
- You can use this software for whatever you want, in parts or full form, without having to pay us. ('royalty-free' usage)
- You may not pretend that you wrote this software. If you use it, or only parts of it, in a program, you must acknowledge somewhere in your documentation that you have used the FreeType code. ('credits')

We specifically permit and encourage the inclusion of this software, with or without modifications, in commercial products.

We disclaim all warranties covering The FreeType Project and assume no liability related to The FreeType Project.

Finally, many people asked us for a preferred form for a credit/disclaimer to use in compliance with this license. We thus encourage you to use the following text:

""""

Portions of this software are copyright (C) <year> The FreeType Project

[www.freetype.org](http://www.freetype.org).

All rights reserved.

""""

Please replace <year> with the value from the FreeType version you actually use.

## Legal Terms

=====

### 0. Definitions

-----

Throughout this license, the terms 'package', 'FreeType Project', and 'FreeType archive' refer to the set of files originally distributed by the



---

authors (David Turner, Robert Wilhelm, and Werner Lemberg) as the 'FreeType Project', be they named as alpha, beta or final release.

'You' refers to the licensee, or person using the project, where 'using' is a generic term including compiling the project's source code as well as linking it to form a 'program' or 'executable'. This program is referred to as 'a program using the FreeType engine'.

This license applies to all files distributed in the original FreeType Project, including all source code, binaries and documentation, unless otherwise stated in the file in its original, unmodified form as distributed in the original archive. If you are unsure whether or not a particular file is covered by this license, you must contact us to verify this.

The FreeType Project is copyright (C) 1996-2000 by David Turner, Robert Wilhelm, and Werner Lemberg. All rights reserved except as specified below.

### 1. No Warranty

-----

THE FREETYPE PROJECT IS PROVIDED 'AS IS' WITHOUT WARRANTY OF ANY KIND, EITHER EXPRESS OR IMPLIED, INCLUDING, BUT NOT LIMITED TO, WARRANTIES OF MERCHANTABILITY AND FITNESS FOR A PARTICULAR PURPOSE. IN NO EVENT WILL ANY OF THE AUTHORS OR COPYRIGHT HOLDERS BE LIABLE FOR ANY DAMAGES CAUSED BY THE USE OR THE INABILITY TO USE, OF THE FREETYPE PROJECT.

### 2. Redistribution

-----

This license grants a worldwide, royalty-free, perpetual and irrevocable right and license to use, execute, perform, compile, display, copy, create derivative works of, distribute and sublicense the FreeType Project (in both source and object code forms) and derivative works thereof for any purpose; and to authorize others to exercise some or all of the rights granted herein, subject to the following conditions:

- Redistribution of source code must retain this license file ('FTL.TXT') unaltered; any additions, deletions or changes to the original files must be clearly indicated in accompanying documentation. The copyright notices of the unaltered, original files must be preserved in all copies of source files.
- Redistribution in binary form must provide a disclaimer that states that the software is based in part of the work of the FreeType Team, in the distribution documentation. We also encourage you to put an URL to the FreeType web page in your documentation, though this isn't mandatory.

These conditions apply to any software derived from or based on the FreeType Project, not just the unmodified files. If you use our work, you must acknowledge us. However, no fee need be paid to us.

### 3. Advertising

---

-----

Neither the FreeType authors and contributors nor you shall use the name of the other for commercial, advertising, or promotional purposes without specific prior written permission.

We suggest, but do not require, that you use one or more of the following phrases to refer to this software in your documentation or advertising materials: `FreeType Project`, `FreeType Engine`, `FreeType library`, or `FreeType Distribution`.

As you have not signed this license, you are not required to accept it. However, as the FreeType Project is copyrighted material, only this license, or another one contracted with the authors, grants you the right to use, distribute, and modify it. Therefore, by using, distributing, or modifying the FreeType Project, you indicate that you understand and accept all the terms of this license.

#### 4. Contacts

-----

There are two mailing lists related to FreeType:

- [freetype@nongnu.org](mailto:freetype@nongnu.org)  
Discusses general use and applications of FreeType, as well as future and wanted additions to the library and distribution. If you are looking for support, start in this list if you haven't found anything to help you in the documentation.
- [freetype-devel@nongnu.org](mailto:freetype-devel@nongnu.org)  
Discusses bugs, as well as engine internals, design issues, specific licenses, porting, etc.

Our home page can be found at <http://www.freetype.org>

---

## ENERGY STAR® Program



Your computer model may be ENERGY STAR® compliant. If the model you purchased is compliant, it will be listed on the following website: <https://www.energystar.gov/productfinder/product/certified-computers> .

Dynabook is a partner in the ENERGY STAR program and has designed this computer to meet the latest ENERGY STAR guidelines for energy efficiency. Your computer ships with the power management options preset to a configuration that will provide the most stable operating environment and optimum system performance for both AC power and battery modes.

To conserve energy, your computer is set to enter the low-power Sleep Mode which shuts down the system and display within 15 minutes of inactivity in AC power mode.

Dynabook recommends that you leave this and other energy saving features active, so that your computer will operate at its maximum energy efficiency. You can wake the computer from Sleep Mode by pressing the power button.

Your ENERGY STAR certified computer should be set by default to enter a low-power "sleep mode" after a period of inactivity. Simply touching the mouse or keyboard "wakes" the computer in seconds. These sleep features can save you up to \$23 per year (200 kWh per year in electricity) and prevent up to 300 pounds of greenhouse gas emissions annually. To learn how to adjust or activate these sleep settings on your computer, please go to: [www.energystar.gov/sleepinstructions](http://www.energystar.gov/sleepinstructions)

To activate sleep settings organization-wide quickly and easily through network tools, please go to: [www.energystar.gov/powermanagement](http://www.energystar.gov/powermanagement)

## Disposing of the computer and the computer's battery

The computer's battery pack is not user-accessible. Contact an authorized service provider for details regarding how to dispose of the computer and the battery pack.

Dynabook is strongly committed to reducing electronic waste. For the efficient use of resources and appropriate treatment of hazardous substances, local, state and federal regulations must be adhered to when recycling your electronic device. To learn about Dynabook's sustainability commitment, visit: <http://emea.dynabook.com/environment>

---

## General Precautions

Your computer is designed to optimize safety, minimize strain and withstand the rigors of portability. However, certain precautions should be observed to further reduce the risk of personal injury or damage to the computer.

Be certain to read the following general precautions and to note the cautions included in the text of the manual.

### Provide adequate ventilation

Always make sure that your computer and AC adaptor have adequate ventilation and are protected from overheating when the power is turned on or when an AC adaptor is connected to a power outlet (even if your computer is in Sleep Mode). In this condition, observe the following:

- Never cover your computer or AC adaptor with any object.
- Never place your computer or AC adaptor near a heat source, such as an electric blanket or heater.
- Never cover or block the air vents including those at the base of the computer.
- Always operate your computer on a hard flat surface. Using your computer on a carpet or other soft material can block the vents.
- Always provide sufficient space around the computer.

Overheating your computer or AC adaptor could cause system failure, computer or AC adaptor damage or a fire, possibly resulting in serious injury.

### Creating a computer-friendly environment

Place the computer on a flat surface that is large enough for the computer and any other items you are using, such as a printer.

Leave enough space around the computer and other equipment to provide adequate ventilation. Otherwise, they might overheat.

To keep your computer in prime operating condition, protect your work area from:

- Dust, moisture, and direct sunlight
- Equipment that generates a strong electromagnetic field, such as stereo speakers (other than speakers that are connected to the computer) or speakerphones
- Rapid changes in temperature or humidity and sources of temperature change such as air conditioner vents or heaters
- Extreme heat, cold, or humidity
- Liquids and corrosive chemicals

---

## Stress injury

Carefully read the **Instruction Manual for Safety and Comfort**. It contains information on the prevention of stress injuries to your hands and wrists that can be caused by extensive keyboard use. It also includes information on work space design, posture, and lighting that can help reduce physical stress.

## Heat injury

- Avoid prolonged physical contact with the computer. If the computer is used for long periods, its surface can become very warm. While the temperature will not feel hot to the touch, if you maintain physical contact with the computer for a long time, for example if you rest the computer on your lap or if you keep your hands on the palm rest, your skin might suffer a low-heat injury.
- If the computer has been used for a long time, avoid direct contact with the metal plate supporting the various interface ports as this can become hot.
- The surface of the AC adaptor can become hot when in use, but this condition does not indicate a malfunction. If you need to transport the AC adaptor, disconnect it and let it cool before moving it.
- Do not lay the AC adaptor on a material that is sensitive to heat as the material could become damaged.

## Pressure or impact damage

Do not apply heavy pressure to the computer or subject it to any form of strong impact as this can damage the computer's components or otherwise cause it to malfunction.

## Cleaning the computer

To help ensure long, trouble-free operation, keep the computer free of dust and dirt, and use care with all liquids around it.

- Be careful not to spill liquids into the computer. If the computer does get wet, turn the power off immediately and let the computer dry completely. In these circumstances, you should get the computer inspected by an authorized service provider in order to assess the scope of any damage.
- Clean the plastics of the computer using a cloth slightly dampened with water.
- You can clean the display screen by spraying a small amount of glass cleaner onto a soft, clean cloth and then wiping the screen gently with the cloth.



*Never spray cleaner directly onto the computer or let liquid run into any part of it. Never use harsh or caustic chemical products to clean the computer.*

---

## Moving the computer

While the computer is designed for flexible day-to-day usage, you should exercise a few simple precautions when moving it in order to help ensure trouble-free operation.

- Make sure all disk/disc activity has ended before moving the computer.
- Turn off (shut down) the computer.
- Disconnect the AC adaptor and all peripherals before moving the computer.
- Close the display panel.
- Do not pick up the computer by its display panel.
- Before carrying your computer, shut it down, disconnect the AC adaptor and allow it to cool down. A failure to follow this instruction might result in minor heat injury.
- Do not expose the computer to rapid temperature changes (for example, in a situation where you carry the computer from a cold environment to a warm room). Do not turn on the power until condensation disappears.
- Be careful not to subject the computer to impact or shock. A failure to follow this instruction could result in damage to computer, computer failure, or loss of data.
- Never transport your computer with any cards inserted. This might damage either the computer and/or the card resulting in computer failure.
- Always use a suitable carry case when transporting the computer.
- When carrying your computer, be sure to hold it securely so that it does not fall or hit anything.
- Do not carry your computer by holding any of its protruding elements.

## Mobile phones

Be aware that the use of mobile phones can interfere with the audio system. The operation of the computer will not be impaired in any way, but it is recommended that a minimum distance of 30 cm is maintained between the computer and a mobile phone that is in use.

## Instruction Manual for Safety and Comfort

All important information on the safe and proper use of this computer is described in the enclosed Instruction Manual for Safety and Comfort. Be sure to read it before using the computer.

## Safety Icons

Safety icons are used in this manual to bring important information to your attention. Each type of message is identified as follows.



*Indicates a potentially hazardous situation, which could result in death or serious injury, if you do not follow instructions.*



*A caution informs you that improper use of equipment or failure to follow instructions might cause data loss, equipment damage, or might result in minor or moderate injury.*



*Please read. A note is a hint or advice that helps you make best use of your equipment.*

---

# Chapter 2

## Getting Started

This chapter provides an equipment checklist, and basic information to start using your computer.



*If you use an operating system that was not pre-installed by Dynabook, some of the features described in this manual might not function properly.*



*You might not have all the software mentioned in this manual depending on the model you purchased.*

## Equipment checklist

Carefully unpack your computer, taking care to save the box and packaging materials for future use.

### Hardware

Check to make sure that you have all the following items:

- Portable personal computer
- USB-C™ to HDMI™/VGA Travel Adapter  
Type-C to RGB Adapter  
(provided with some models and varies depending on the model you purchased)
- AC adaptor and power cord (2-pin plug or 3-pin plug)

### Documentation

- Quickstart
- Instruction Manual for Safety and Comfort
- Warranty Information

If any of the items are missing or damaged, contact your dealer immediately.

## Conventions

This manual uses the following formats to describe, identify, and highlight terms and operating procedures.



<b>Click</b>	<ul style="list-style-type: none"> <li>■ Tap the Touch Pad or click the left Touch Pad control button once.</li> <li>■ Left-click the mouse once.</li> <li>■ Tap the touch screen once (only for touch screen models).</li> </ul>
<b>Right-click</b>	<ul style="list-style-type: none"> <li>■ Click the right Touch Pad control button once.</li> <li>■ Right-click the mouse once.</li> <li>■ Press and hold on the touch screen (only for touch screen models).</li> </ul>
<b>Double-click</b>	<ul style="list-style-type: none"> <li>■ Tap the Touch Pad or click the left Touch Pad control button twice.</li> <li>■ Left-click the mouse twice.</li> <li>■ Tap the touch screen twice (only for touch screen models).</li> </ul>
<b>Start</b>	The word "Start" refers to the "  " button on the center of the Windows taskbar.

## Short model name

Model name of your computer is shortened and referred to as the following in this manual.

LCD	Full Model Name	Short Model Name
35.6 cm (14.0")	PORTEGE X40-K	PORTEGE Series
35.6 cm (14.0")	TECRA A40-K, SATELLITE PRO A40-K/R40-K, dynabook EX40L-K/GX40L-K, TECRA A45-KW, TECRA A4*-K	TECRA/ SATELLITE PRO/ dynabook Series
39.6 cm (15.6")	TECRA A50-K, SATELLITE PRO A50-K/R50-K, TECRA A55-KW, TECRA A5*-K	

## Using your computer for the first time



*Be sure to read the enclosed Instruction Manual for Safety and Comfort for information on the safe and proper use of this computer. It is intended to help you be more comfortable and productive while using a notebook computer. By following the recommendations in it, you can reduce your chance of developing a painful or disabling injury to your hand, arms, shoulders, or neck.*

This section provides basic information to start using your computer. It covers the following topics:

- Connecting the AC adaptor
- Opening the display
- Turning on the power
- Initial setup
- Getting to know Windows



- *Use a virus-check program and make sure that it is updated regularly.*
- *Never format storage media without checking its content - formatting destroys all stored data.*
- *It is a good idea to back up the internal Solid-State Drive or other main storage device to external media periodically. Generally, storage media is not durable or stable over long periods of time and under certain conditions might cause data loss.*
- *Before you install a device or application, save any data in memory to the internal Solid-State Drive or other storage media. Failure to do so might result in data loss.*

## Connecting the AC adaptor

Attach the AC adaptor when you want to charge the battery or operate from AC power. The battery pack must be charged before you can operate from battery power.

The AC adaptor can automatically adjust to any voltage ranging from 100 volts to 240 volts and to a frequency of either 50 hertz or 60 hertz, enabling you to use this computer in almost any country/region. The adaptor converts AC power to DC power and reduces the voltage supplied to this computer.



- *Always use the AC adaptor that was included with your computer, or use AC adaptors specified by Dynabook to avoid any risk of fire or other damage to the computer. Use of an incompatible AC adaptor might cause fire or damage to the computer, possibly resulting in serious injury. Dynabook assumes no liability for any damage caused by use of an incompatible adaptor.*
- *Never plug the AC adaptor into a power source that does not correspond to both the voltage range and the frequency specified on the regulatory label of the unit. Failure to do so might result in a fire or electric shock, possibly resulting in serious injury.*
- *Always use or purchase power cables that comply with the legal voltage and frequency specifications and requirements in the country of use. Failure to do so might result in a fire or electric shock, possibly resulting in serious injury.*

- *The supplied power cord conforms to safety rules and regulations in the region the computer is bought and should not be used outside this region. For use in other regions, buy power cords that conform to safety rules and regulations in the particular region.*
- *Do not use a 3-pin to 2-pin conversion plug.*
- *When you connect the AC adaptor to the computer, always follow the steps in the exact order as described in this User's Manual. As a general safety precaution, avoid touching any metal parts.*
- *Never place your computer or AC adaptor on a wooden surface, furniture, or any other surface that might be marred by exposure to heat since the computer base and the surface of the AC adaptor increase in temperature during normal use.*
- *Always place your computer or AC adaptor on a flat and hard surface that is resistant to heat damage.*

*Refer to the enclosed Instruction Manual for Safety and Comfort for detailed precautions and handling instructions.*

Depending on the model you purchased, the following AC adaptor might be provided.

- DC IN 19V jack connection type
- USB Type-C™ port connection type

### ***DC IN 19V jack connection type***

1. Connect the power cord to the AC adaptor.

*Figure 2-1 Connecting the power cord to the AC adaptor (2-pin plug)*

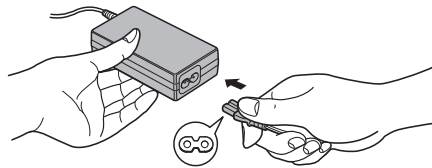

*Figure 2-2 Connecting the power cord to the AC adaptor (3-pin plug)*

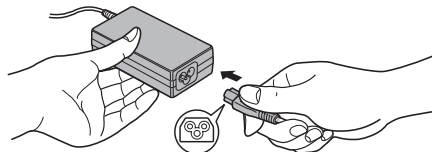

*Either a 2-pin or 3-pin adaptor/cord is included with the computer depending on the model.*

2. Connect the DC output plug of the AC adaptor to the DC IN 19V jack on your computer.

*Figure 2-3 Connecting the DC output plug to the computer*

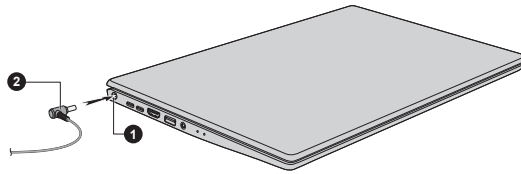

1. DC IN 19V jack

2. DC output plug

Product appearance depends on the model you purchased.

3. Plug the power cord into a live wall outlet. The **DC IN/Battery** indicator glows.

### **USB Type-C™ port connection type**

1. Connect the power cord to the AC adaptor.

*Figure 2-4 Connecting the power cord to the AC adaptor (2-pin plug)*

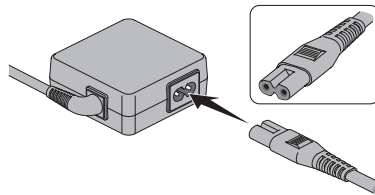

*Figure 2-5 Connecting the power cord to the AC adaptor (3-pin plug)*

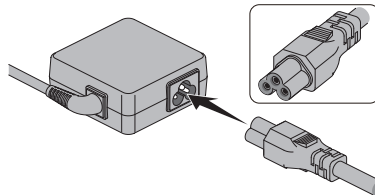

Product appearance depends on the model you purchased.



*Either a 2-pin or 3-pin adaptor/cord is included with the computer depending on the model.*

2. Plug the power cord into a live wall outlet.

3. Connect the DC output plug of the AC adaptor to one of the Thunderbolt™ 4/USB Type-C™ ports on your computer. The **DC IN/ Battery** indicator glows.

Figure 2-6 Connecting the DC output plug to the computer

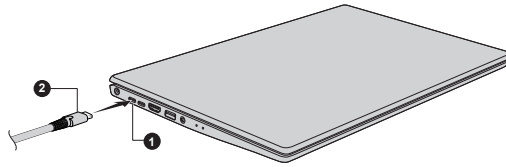

1. Thunderbolt™ 4/USB Type-C™ port
2. DC output plug

## Opening the display

The display panel can be opened to a wide range of angles (up to 180 degrees) for optimal viewing.

To open the display panel, slowly lift it with one hand holding the center of the display panel (as shown in the following figure) and the other hand holding the palm rest down so that the main body of the computer is not raised. This will allow the angle of the display panel to be adjusted to provide optimum clarity.

Figure 2-7 Opening the display panel

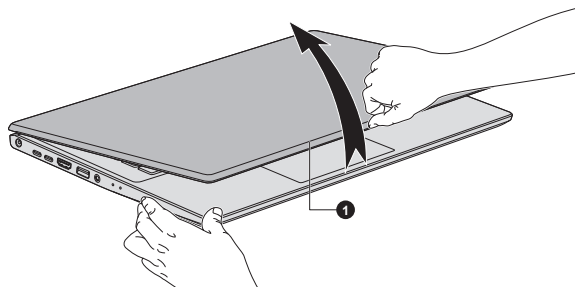

1. Display panel

Product appearance depends on the model you purchased.



*Open and close the display panel with reasonable care. Opening it vigorously or slamming it shut might damage the computer.*



- *Be careful not to open the display panel too far as this might put stress on the display panel's hinges and cause damage.*
- *Do not lift the computer by the display panel.*

- Do not close the computer with pens or any other objects left in between the display panel and the keyboard.
- When opening or closing the display panel, place one hand on the palm rest to hold the computer in place and use the other hand to slowly open or close the display panel. Do not use excessive force when opening or closing the display panel.
- Do not press or push with excessive force on the display screen, otherwise the computer might become unsteady and possibly fall over.

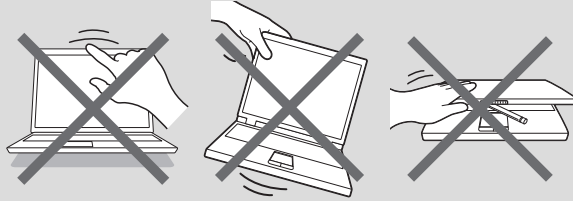

## Turning on the power

This section describes how to turn on the power. The power indicator indicates the status. Refer to the [Power Condition Descriptions](#) section for more information.



- After you turn on the power for the first time, do not turn it off until you have set up the operating system.
- Volume cannot be adjusted during Windows Setup.
- Do not touch the display screen while turning on the computer.

1. Open the display panel.
2. Press the power button.

Figure 2-8 Turning on the power

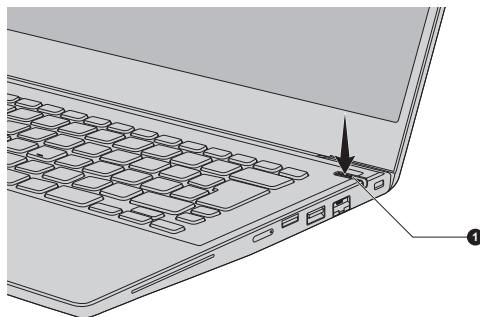

1. Power button

Product appearance depends on the model you purchased.

---

## Initial setup

The Windows Startup Screen is the first screen displayed when you turn on the power. To install the operating system properly, follow the on-screen instructions on each screen.



*When it is displayed, be sure to read the license terms and license agreement carefully.*



## Getting to know Windows

For detailed information on what is new and how to operate Windows, refer to **Tips** in the Start menu.

### Start menu

The Start menu is the launching pad for everything you can do in the Windows operating system, providing easy ways to get to your favorite apps, recent files, and a powerful search box for finding anything.

You can access the Start menu from an app or the desktop in the following ways:

- Click the **Start** button (  ) on the center of the Windows taskbar.
- Press the Windows® logo key (  ) on your keyboard.

### Windows taskbar

By default, the bottom of the desktop is Windows taskbar. You can see all of your currently running apps on the Windows taskbar.

### Task view

Task view (  ) is launched from the Windows taskbar at the bottom of the screen. Task view allows you to view the apps that are currently running. Also, you can create custom desktops so that running apps can be grouped for entertainment, productivity, or what you just want.

To do this, click the **Task view** icon  , and then click **New desktop**. Open the apps you want to use on that desktop. To switch between desktops, click **Task view** again.

### Search

**Search** on the Windows taskbar allows you to find apps, files, settings, and more on the computer. When internet connection is available, it also shows you the best search result from the internet.

The personal assistant called **Cortana** may be available, depending on your country/region. You can ask questions or talk to Cortana in your natural voice, and Cortana answers your questions using information from

---

the internet. To talk with Cortana, an internal or external microphone is required.

## Settings

**Settings** provides system settings including advanced settings in the Control Panel. They are divided in categories so that you can configure, optimize, or personalize Windows.

You can also type in the keyword, and use **Search** to find any setting.

To open Settings, click **Start -> Settings** (⚙️).

## Microsoft Store

Although many apps are pre-installed in your computer, you can also download many others from the Microsoft Store.

You can search for and browse thousands of apps, all grouped into easy-to-find categories there.

## Windows Hello

Windows Hello is a more personal and secure way to sign in to your Windows system, apps, and services using fingerprint, face recognition or a PIN.

To set up Windows Hello, click **Start -> Settings -> Accounts -> Sign-in options**.

Under **Sign-in options**, you will see options for Face Recognition and Fingerprint if your computer has fingerprint sensor and if your computer has face recognition sensor that supports it. Once you have set up, you will be able to sign in with a quick touch or glance.

You might need to add a PIN under **PIN (Windows Hello)** before you can set up **Facial recognition (Windows Hello)** and **Fingerprint recognition (Windows Hello)**.

## Sign-in options

Windows offers a number of sign-in options including **Password** (🔑), **PIN** (1234), **Fingerprint** (👉), **Face** (😊) and **Picture password** (🖼️) authentication to prevent from unauthorized access. If you have multiple sign-in methods set for a user account, you can select an option on the Windows login screen by clicking sign-in options.



*It is highly recommended to use Windows Hello Face indoors. Operating outdoors might cause enrollment/sign-in failure due to the possible sunlight affection.*



---

## Turning off the power

The power can be turned off in one of the following modes, either Shut Down Mode, Sleep Mode or Hibernation Mode.

### Shut Down Mode

When you turn off the power in Shut Down Mode, no data will be saved and the computer will boot to the main screen of the operating system the next time it is turned on.

1. If you have entered data, either save it to the internal storage drive or to other storage media.
2. Make sure all disk/disc activity has stopped before removing the disk/disc.



- *If you turn off the power while a disk (disc) is being accessed, you might lose data or damage the disk.*
- *Never turn off the power while an application is running. Failure to do so can cause data loss.*
- *Never turn off the power, disconnect an external storage device, or remove storage media during data read/write. Failure to do so can cause data loss.*

3. Click **Start** ->  (**Power**) and then select **Shut down**.
4. Turn off any peripheral devices connected to your computer.





*Do not turn the computer or peripheral devices back on immediately. Wait a short period to avoid any potential damage.*

### Restarting the computer

Certain conditions require that you restart the computer, for example if you change certain computer settings.

To restart the computer, there are several ways this can be achieved:

- Click **Start** ->  (**Power**) and then select **Restart**.
- Press **CTRL**, **ALT**, and **DEL** simultaneously (once) to display the menu window, and then select **Restart** by clicking the power icon () in the lower-right corner.



*Before restarting the computer, be sure to save your data.*

### Sleep Mode

If you have to interrupt your work, you are able to turn off the power without exiting from your software by placing the computer into Sleep Mode. In this

---

mode, data is maintained in the main memory of the computer. When you turn on the power again, you can continue working right where you left off.



*When you have to turn off your computer aboard an aircraft or in places where electronic devices are regulated or controlled, always shut down the computer. This includes turning off any wireless communication functionalities, and canceling settings that reactivate the computer automatically, such as a timer recording function. Failure to shut down the computer in this way might allow the operating system to reactivate and run pre-programmed tasks or preserve unsaved data, which might interfere with aviation or other systems, possibly causing serious injury.*



- *Before entering Sleep Mode, be sure to save your data.*
- *To avoid possible battery life decrease, it is recommended to remove any peripheral device connected to the computer before entering Sleep Mode.*
- *To prevent data loss, do not switch to Sleep Mode while transferring data to external media, such as USB devices, memory media, or other external memory devices.*



- *When the AC adaptor is connected, the computer will go into Sleep Mode according to the settings in the Power Options (to access it, click **Start -> All apps -> Windows Tools** and double-click **Control Panel**. In the Control Panel window, click **System and Security -> Power Options**.)*
- *If the computer enters Sleep Mode while a network application is active, the application might not be restored when the computer is next turned on and the system returns from Sleep Mode.*
- *To prevent the computer from automatically entering Sleep Mode, disable Sleep Mode within the Power Options.*

### ***Benefits of Sleep Mode***

The Sleep Mode feature provides the following benefits:

- Restores the previous working environment more rapidly than the Hibernation Mode feature.
- Saves power by shutting down the system when the computer receives no input or hardware access for the time period set by the System Sleep Mode feature.
- Allows the use of the panel power off feature.

### ***Executing Sleep Mode***

You can enter Sleep Mode in one of following ways:

- Click **Start ->  (Power)** and then select **Sleep**.

- 
- Close the display panel. Note that this feature must be enabled within the Power Options.
  - Press the power button. Note that this feature must be enabled within the Power Options.

When you turn the power back on, you can continue where you left off when you shut down the computer.



*If you are operating the computer on battery power, you can lengthen the overall operating time by turning it off into Hibernation Mode. Sleep Mode consumes more power while the computer is off.*

### ***Sleep Mode limitations***

Sleep Mode will not function under the following condition:

- Memory circuits are exposed to static electricity or electrical noise.

## **Hibernation Mode**

The Hibernation Mode feature saves the contents of memory to the internal storage drive when the computer is turned off so that, the next time it is turned on, the previous state is restored. Note that the Hibernation Mode feature does not save the status of any peripheral devices connected to the computer.



- *Save your data. While entering Hibernation Mode, the computer saves the contents of memory to the internal storage drive. However, for safety sake, it is best to save your data manually.*
- *Data will be lost if you disconnect the AC adaptor before saving is completed.*
- *To prevent data loss, do not switch to Hibernation Mode while transferring data to external media, such as USB devices, memory media, or other external memory devices.*

### ***Benefits of Hibernation Mode***

The Hibernation Mode feature provides the following benefits:

- Saves data to the internal storage drive when the computer automatically shuts down because of a low battery condition.
- You can return to your previous working environment immediately when you turn on the computer.
- Saves power by shutting down the system when the computer receives no input or hardware access for the time period set by the System Hibernate feature.
- Allows the use of the panel power off feature.

---

## **Starting Hibernation Mode**

To enter Hibernation Mode, click **Start** ->  (**Power**) and then select **Hibernate**.



To show **Hibernate** in Power menu, set up according to the following steps:

1. Click **Start** -> **All apps** -> **Windows Tools** and double-click **Control Panel**.
2. In the Control Panel window, click **System and Security** -> **Power Options**.
3. Click **Choose what the power button does** or **Choose what closing the lid does**.
4. Click **Change settings that are currently unavailable**.
5. Select the **Hibernate** check box from Shutdown settings.
6. Click the **Save changes** button.

## **Automatic Hibernation Mode**

The computer can be configured to enter Hibernation Mode automatically when you press the power button or close the display panel. To define these settings, do the following:

1. Click **Power Options** and then click **Choose what the power button does** or **Choose what closing the lid does**.
2. Enable the desired Hibernation Mode settings for **When I press the power button** and **When I close the lid**.
3. Click the **Save changes** button.

## **Data saving in Hibernation Mode**

When you turn off the power in Hibernation Mode, the computer takes a moment to save the current data in memory to the internal storage drive.

After you turn off the computer, and the content of memory has been saved to the internal storage drive, turn off the power to any peripheral devices.



*Do not turn the computer or devices back on immediately. Wait a moment to let all capacitors fully discharge.*

## **System Recovery**

There is a hidden partition allocated on the internal storage drive for the System Recovery Options in the event of a problem.

You can also create recovery media and restore the system.

The following items are described in this section:

- Creating Recovery Media

- Restoring the pre-installed software from your created Recovery Media
- Restoring the pre-installed software from the Recovery Partition



*If you choose dynabook Maintenance Utility to erase the internal storage drive, all data including the operating system and recovery partition will be deleted. In that case, you cannot create recovery media or restore the pre-installed software from the recovery partition. Make sure that you have already created recovery media before you start dynabook Maintenance Utility. This recovery media can be used to restore your system after you have erased your internal storage drive.*

## Creating Recovery Media

This section describes how to create Recovery Media.



- *Be sure to connect the AC adaptor when you create Recovery Media.*
- *Be sure to close all other software programs.*
- *Do not run software such as screen savers which can put a heavy load on the CPU.*
- *Operate the computer at full power.*
- *Do not use power-saving features.*
- *Do not write to the media when the virus check software is running. Wait for it to finish, then disable virus detection programs including any software that checks files automatically in the background.*
- *Do not use utilities, including those intended to enhance internal storage drive access speed. They might cause unstable operation and damage data.*
- *Do not shut down/log off or Sleep/Hibernate while writing or rewriting the media.*
- *Set the computer on a level surface and avoid places subjected to vibrations such as airplanes, trains, or cars.*
- *Do not use on an unstable surface such as a stand.*

A recovery image of the software on your computer is stored on the internal storage drive, and can be copied to either disc media or USB Flash Memory by using the following steps:

1. Select either blank disc or USB Flash Memory.  
The application allows you to choose from a variety of different media onto which the recovery image can be copied including disc media and USB Flash Memory.



- *Some of the disc media might not be compatible with the optical disc drive connected to your computer. You should therefore verify that the optical disc drive supports the blank media you have chosen before proceeding.*
- *USB Flash Memory will be formatted and all the data in the USB Flash Memory will be lost when proceeding.*

2. Turn on your computer and allow it to load the Windows operating system from the internal storage drive as normal.
3. Insert the first blank disc into the external optical disc drive tray, or insert the USB Flash Memory into one available USB port.
4. Click **Start -> All apps -> Windows Tools** and double-click **Control Panel**. In the Control Panel window, click **System and Security -> Security and Maintenance -> Recovery -> Create a recovery drive**.
5. Follow the on-screen instructions to finish creating the Recovery Media.



***dynabook Recovery Wizard** option in **dynabook Maintenance Utility** will not exist if you restore the computer from the recovery media you created by recovery drive creating option in Windows system.*

## Restoring the pre-installed software from your created Recovery Media

If the pre-installed files are damaged, you are able to use the Recovery Media you have created to restore the computer to the state it was in when you originally received it. To perform this restoration, do the following:



- *Make sure that the AC adaptor is connected during the restoring process.*
- *Do not close the display panel during the restoring process.*



- *When you reinstall the Windows operating system, the internal storage drive will be reformatted and all data will be lost.*
- *If your model has fingerprint function, before you reinstall the Windows operating system, delete the registered fingerprints. Otherwise, the same fingerprints cannot be registered after the reinstallation.*

1. Load the Recovery Media into the external optical disc drive or insert the recovery USB Flash Memory into one available USB port.
2. Click **Start -> (Power)** and then select **Restart**.
3. Hold down the **F12** key and then release this key just after the computer is powered on.
4. Use the up and down cursor key to select the appropriate option from the menu according to your actual recovery media.

5. A menu is displayed from which you should follow the on-screen instructions.



*If you have previously chosen to remove the recovery partition without creating Recovery Media, the Recovery Media cannot be created.*

*However, if you have already created a Recovery Media, you can use it to restore the recovery partition.*

*If you have not created Recovery Media, contact Technical Support for assistance.*

## Restoring the pre-installed software from the Recovery Partition

A portion of the total internal storage drive space is configured as a hidden recovery partition. This partition stores files which can be used to restore pre-installed software in the event of a problem.

If you set up your internal storage drive again later, do not change, delete, or add partitions in a manner other than specified in the manual, otherwise you might find that space for the required software is not available.

In addition, if you use a third-party partitioning program to reconfigure the partitions on your internal storage drive, you might find that it becomes impossible to set up your computer.



- *Make sure that the AC adaptor is connected during the restoring process.*

- *Do not close the display panel during the restoring process.*



- *When you reinstall the Windows operating system, the internal storage drive will be reformatted and all data will be lost.*

- *If your model has fingerprint function, before you reinstall the Windows operating system, delete the registered fingerprints. Otherwise, the same fingerprints cannot be registered after the reinstallation.*

1. Click **Start** ->  (**Power**) and then select **Restart**.
2. Hold down **0** (zero) key and then release this key just after the computer is powered on.
3. Select **Troubleshoot** -> **dynabook Maintenance Utility** -> **dynabook Recovery Wizard**.
4. Follow the on-screen instructions to finish the recovery.

---

# Chapter 3

## The Grand Tour

This chapter identifies the various components of the computer. It is recommended that you become familiar with each before you operate the computer.

Legal Footnote (Non-applicable Icons)

For more information regarding Non-applicable Icons, refer to the [Legal Footnotes](#) section.



*Handle your computer carefully to avoid scratching or damaging the surface.*

## The Grand Tour for PORTEGE Series

### Front with the display closed (PORTEGE Series)

The following figure shows the front of the computer with the display panel in the closed position.

*Figure 3-1 Front of the computer with display panel closed (PORTEGE Series)*



#### 1. Stereo speakers

---

#### **Stereo speakers**

The speakers emit sound generated by your software as well as audio alarms, such as low battery condition, generated by the system.

---

### Left side (PORTEGE Series)

The following figure shows the left side of the computer.



Figure 3-2 The left side of the computer (PORTEGE Series)

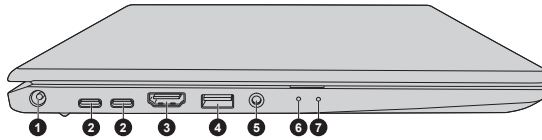

1. DC IN 19V jack
2. Thunderbolt™ 4/USB Type-C™ port
3. HDMI™ out port
4. Universal Serial Bus (USB 3.2 Gen1) port
5. Headphone/Microphone jack
6. DC IN/Battery indicator
7. Power indicator

Product appearance depends on the model you purchased.



### DC IN 19V jack

The AC adaptor connects to this jack in order to power the computer and charge its internal battery. Note that you must use the AC adaptor that was included with your computer, or use AC adaptors specified by Dynabook. Use of an incompatible AC adaptor might cause fire or damage to the computer, possibly resulting in serious injury.



### Thunderbolt™ 4/USB Type-C™ port

Two Thunderbolt™ 4/USB Type-C™ ports, which support Thunderbolt™ 4 and USB4, are provided on the left side of the computer.

This port supports USB data transmission, video output (audio stream can be included) and USB Power Delivery.



- *Note that it is not possible to confirm the operation of all functions of all Thunderbolt™ devices/USB devices that are available. Some functions associated with a specific device might not operate properly.*
- *Before removing a USB device from the Thunderbolt™ 4/USB Type-C™ port of your computer, click the **Safely Remove Hardware and Eject Media** icon on the Windows Taskbar, and then select the USB device that you want to remove.*



*Keep foreign metal objects, such as screws, staples, and paper clips, out of the Thunderbolt™ 4/USB Type-C™ port. Foreign metal objects can create a short circuit, which can cause damage and fire, possibly resulting in serious injury.*



### HDMI™ out port

HDMI™ out port can connect with Type A connector HDMI™ cable.



### Universal Serial Bus (USB 3.2 Gen1) port

One Type-A Universal Serial Bus port, which complies to the USB 3.2 standard, is provided on the left side of the computer.

The USB 3.2 port is compliant with USB 3.2 Gen1 standard and backward compatible with USB 2.0 devices.

The port with the icon (⚡) has Power Off and Charge function.



- *Note that it is not possible to confirm the operation of all functions of all USB devices that are available. Some functions associated with a specific device might not operate properly.*
- *Before removing a USB device from the USB port of your computer, click the **Safely Remove Hardware and Eject Media** icon on the Windows taskbar, and then select the USB device that you want to remove.*



*Keep foreign metal objects, such as screws, staples, and paper clips, out of the USB port. Foreign metal objects can create a short circuit, which can cause damage and fire, possibly resulting in serious injury.*



### Headphone/ Microphone jack

A 3.5 mm mini headphone/microphone jack enables connection of a monaural microphone, stereo headphones, or a headset.



### DC IN/Battery indicator

The DC IN/Battery indicator shows the condition of the DC IN and the battery charge status. White indicates that the battery is fully charged while the power is being correctly supplied from the AC power adaptor.

Refer to the [Power Condition Descriptions](#) section for more information on this feature.



### Power indicator

The power indicator normally glows white when the computer is turned on.

## Right side (PORTEGE Series)

The following figure shows the right side of the computer.

Figure 3-3 The right side of the computer (PORTEGE Series)

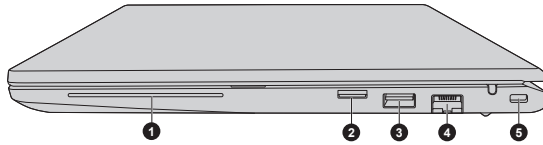

- 1. Smart Card slot\*
- 2. Memory media slot
- 3. Universal Serial Bus (USB 3.2 Gen1) port
- 4. LAN jack
- 5. Security lock slot

\* Provided with some models.

Product appearance depends on the model you purchased.



### Smart Card slot

This slot allows you to install a Smart Card device. Some models are equipped with a Smart Card slot.



### Memory media slot

This slot lets you insert a micro SD™/SDHC™/SDXC™ memory card. Refer to the [Memory media](#) section for more information.



*Keep foreign metal objects, such as screws, staples, and paper clips, out of the memory media slot. Foreign metal objects can create a short circuit, which can cause damage and fire, possibly resulting in serious injury.*



### Universal Serial Bus (USB 3.2 Gen1) port

One Type-A Universal Serial Bus port, which complies to the USB 3.2 standard, is provided on the right side of the computer.

The USB 3.2 port is compliant with USB 3.2 Gen1 standard and backward compatible with USB 2.0 devices.



### LAN jack

This jack lets you connect to a LAN. The adapter has built-in support for Ethernet LAN (10 megabits per second, 10BASE-T), Fast Ethernet LAN (100 megabits per second, 100BASE-TX) or Gigabit Ethernet LAN (1000 megabits per second, 1000BASE-T). Refer to [Operating Basics](#), for details.



*Do not connect any cable other than a LAN cable to the LAN jack. It might cause damage or malfunction.*



### Security lock slot

A security cable can be attached to this slot and then connected to a desk or other large object in order to deter theft of the computer.

## Back (PORTEGE Series)

The following figure shows the back of the computer.

Figure 3-4 The back of the computer (PORTEGE Series)

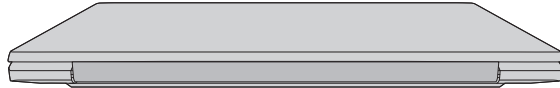

## Underside (PORTEGE Series)

The following figures show the underside of the computer. Ensure that the display is closed before the computer is turned over to avoid causing any damage.

Figure 3-5 The underside of the computer (PORTEGE Series)

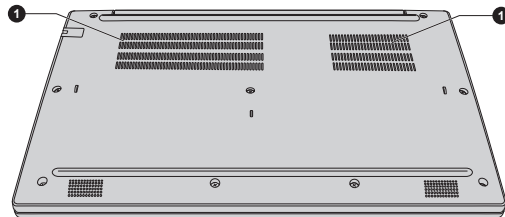

### 1. Cooling vents

Product appearance depends on the model you purchased.

### Cooling vents

The cooling vents help the processor to avoid overheating.



*Do not block the cooling vents. Keep foreign metal objects, such as screws, staples, and paper clips, out of the cooling vents. Foreign metal objects can create a short circuit, which can cause damage and fire, possibly resulting in serious injury.*

*Carefully clean the dust on the surface of the cooling vents using a soft cloth.*

## Front with the display open (PORTEGE Series)

This section shows the computer with the display panel open. In order to open the display, lift up the display panel and position it at a comfortable viewing angle for you.

Figure 3-6 The front of the computer with the display panel open (PORTEGE Series)

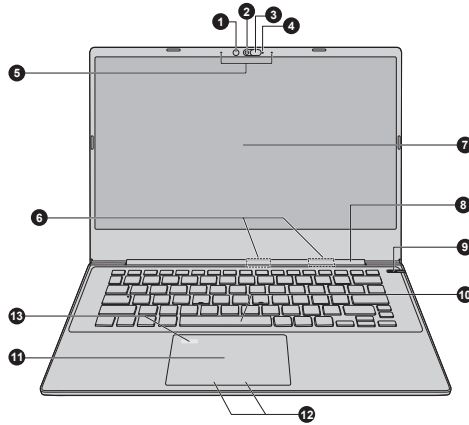

- |   |                               |
|---|-------------------------------|
| 1. Infrared LED*                                  | 8. Display hinge              |
| 2. Web Camera                                     | 9. Power button               |
| 3. Web Camera Shutter                             | 10. Keyboard                  |
| 4. Web Camera LED                                 | 11. Touch Pad                 |
| 5. Microphones                                    | 12. Touch Pad control buttons |
| 6. Wireless communication antennas<br>(not shown) | 13. Fingerprint sensor*       |
| 7. Display screen                                 |                               |

\* Provided with some models.

Product appearance depends on the model you purchased.

---

### Infrared LED

The infrared LED blinks when Windows Hello Face is operating.

Only models which support face recognition feature are equipped with the infrared LED.

---

### Web Camera

Web Camera is a device that allows you to record video or take photographs with your computer. You can use it for video chatting or video conferences using a communication tool.

The Web Camera available on some models can support face recognition feature for Windows Hello. For more information, refer to the onscreen instructions in Windows Hello.



- Do not point the web camera directly at the sun.
- Do not touch or press strongly on the web camera lens and infrared LED. Failure to do so might reduce image quality, possibly resulting in recognizing faces incorrectly. Use an eyeglass cleaner (cleaner cloth) or other soft cloth to clean the lens and the LED if it becomes dirty.

- *It is highly recommended to use Windows Hello Face indoors. Operating outdoors might cause enrollment/sign-in failure due to the possible sunlight affection.*
- *When enrolling your face to Windows Hello, please make sure that there is no other face in preview of Windows Hello setup dialog.*
- *While the web camera is capturing your face, make sure that your face is in front of the web camera and you look directly at it.*

**Web Camera Shutter** The Web Camera Shutter can be used to protect your privacy, by sliding towards left to cover the Web Camera lens.

**Web Camera LED** The Web Camera LED glows when the Web Camera is operating.

**Microphones** The built-in microphones allow you to record sounds for your application. Refer to the [Sound System and Video mode](#) section for more information.

**Wireless communication antennas** Depending on the configuration of your computer, the following antennas are built in:

- Wireless LAN/Bluetooth®



*Do not cover the wireless communication antennas area with any metal objects, otherwise the wireless function might not work.*

#### Legal Footnote (Wireless LAN)

For more information regarding Wireless LAN, refer to the [Legal Footnotes](#) section.

**Display screen** 35.6 cm (14.0") LCD screen, is configured with one of the following resolutions depending on the model you purchased:

- HD, 1366 horizontal x 768 vertical pixels
- FHD, 1920 horizontal x 1080 vertical pixels

Be aware that, when the computer is operating on the AC adaptor, the image displayed on the internal screen is somewhat brighter than when it operates on battery power. This difference in brightness levels is intended to save power when operating on battery.

#### Legal Footnote (LCD)

For more information regarding LCD, refer to the [Legal Footnotes](#) section.

<b>Display hinge</b>	The display hinge allows the display panel to be positioned at a variety of easy-to-view angles.
<b>Power button</b>	Press this button to turn the computer's power on or off.
<b>Keyboard</b>	The keyboard contains character keys, control keys, function keys, and special Windows keys, providing all the functionality of a full-size keyboard. Refer to the <a href="#">The Keyboard</a> section for details.
<b>Touch Pad</b>	The Touch Pad located in the palm rest is used to control the movement of the mouse pointer. To use the Touch Pad, simply touch and move your fingertip across it in the direction you want the mouse pointer to go.
<b>Touch Pad control buttons</b>	The two buttons located on the bottom of the Touch Pad are used like the buttons on a standard mouse. Press the left button to select a menu item or to manipulate text or graphics designated by the mouse pointer, and press the right button to display a menu or other function depending on the software you are using.
<b>Fingerprint sensor</b>	This sensor enables you to enroll and sign in with a fingerprint in Windows Hello. For more information, refer to the on-screen instructions in Windows Hello.  Some models are equipped with a fingerprint sensor.

## The Grand Tour for **TECRA/SATELLITE PRO/** dynabook Series

### Front with the display closed (**TECRA/SATELLITE PRO/** dynabook Series)

The following figure shows the front of the computer with the display panel in the closed position.

*Figure 3-7 Front of the computer with display panel closed (TECRA/SATELLITE PRO/dynabook Series)*

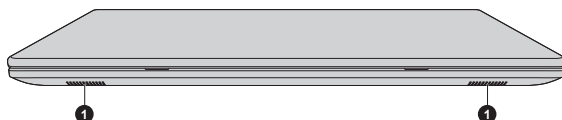

1. Stereo speakers

## Stereo speakers

The speakers emit sound generated by your software as well as audio alarms, such as low battery condition, generated by the system.

## Left side (TECRA/SATELLITE PRO/dynabook Series)

The following figure shows the left side of the computer.

Figure 3-8 The left side of the computer (TECRA/SATELLITE PRO/dynabook Series)

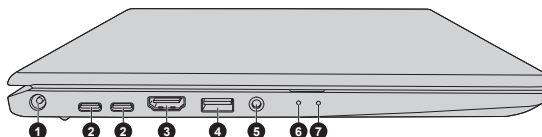

1. DC IN 19V jack
2. Thunderbolt™ 4/USB Type-C™ port
3. HDMI™ out port
4. Universal Serial Bus (USB 3.2 Gen1) port
5. Headphone/Microphone jack
6. DC IN/Battery indicator
7. Power indicator

Product appearance depends on the model you purchased.



### DC IN 19V jack

The AC adaptor connects to this jack in order to power the computer and charge its internal battery. Note that you must use the AC adaptor that was included with your computer, or use AC adaptors specified by Dynabook. Use of an incompatible AC adaptor might cause fire or damage to the computer, possibly resulting in serious injury.



### Thunderbolt™ 4/USB Type-C™ port

Two Thunderbolt™ 4/USB Type-C™ ports, which support Thunderbolt™ 4 and USB4, are provided on the left side of the computer.

This port supports USB data transmission, video output (audio stream can be included) and USB Power Delivery.



- Note that it is not possible to confirm the operation of all functions of all Thunderbolt™ devices/USB devices that are available. Some functions associated with a specific device might not operate properly.
- Before removing a USB device from the Thunderbolt™ 4/USB Type-C™ port of your computer, click the **Safely Remove Hardware and Eject Media** icon on the Windows Taskbar, and then select the USB device that you want to remove.





Keep foreign metal objects, such as screws, staples, and paper clips, out of the Thunderbolt™ 4/USB Type-C™ port. Foreign metal objects can create a short circuit, which can cause damage and fire, possibly resulting in serious injury.



### HDMI™ out port

HDMI™ out port can connect with Type A connector HDMI™ cable.



### Universal Serial Bus (USB 3.2 Gen1) port

One Type-A Universal Serial Bus port, which complies to the USB 3.2 standard, is provided on the left side of the computer.

The USB 3.2 port is compliant with USB 3.2 Gen1 standard and backward compatible with USB 2.0 devices.

The port with the icon ( ⚡ ) has Power Off and Charge function.



- Note that it is not possible to confirm the operation of all functions of all USB devices that are available. Some functions associated with a specific device might not operate properly.
- Before removing a USB device from the USB port of your computer, click the **Safely Remove Hardware and Eject Media** icon on the Windows taskbar, and then select the USB device that you want to remove.



Keep foreign metal objects, such as screws, staples, and paper clips, out of the USB port. Foreign metal objects can create a short circuit, which can cause damage and fire, possibly resulting in serious injury.



### Headphone/ Microphone jack

A 3.5 mm mini headphone/microphone jack enables connection of a monaural microphone, stereo headphones, or a headset.



### DC IN/Battery indicator

The DC IN/Battery indicator shows the condition of the DC IN and the battery charge status. White indicates that the battery is fully charged while the power is being correctly supplied from the AC power adaptor.

Refer to the [Power Condition Descriptions](#) section for more information on this feature.



### Power indicator

The power indicator normally glows white when the computer is turned on.

## Right side (TECRA/SATELLITE PRO/dynabook Series)

The following figure shows the right side of the computer.

Figure 3-9 The right side of the computer (TECRA/SATELLITE PRO/dynabook Series)

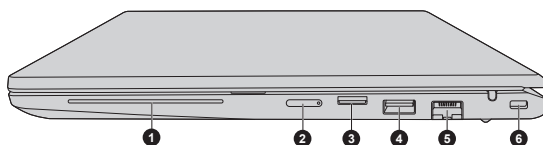

- |                      |   |
|----------------------|---|
| 1. Smart Card slot*  | 4. Universal Serial Bus (USB 3.2 Gen1) port |
| 2. SIM card slot*    | 5. LAN jack                                 |
| 3. Memory media slot | 6. Security lock slot                       |

\* Provided with some models.

Product appearance depends on the model you purchased.



### Smart Card slot

This slot allows you to install a Smart Card device. Some models are equipped with a Smart Card slot.



### SIM card slot

This slot allows you to insert a SIM card which enables a high-speed access to the internet, corporate intranet and your email while you are away from office. Refer to the [Wireless WAN device](#) section for more information. Some models are equipped with the SIM card slot.



### Memory media slot

This slot lets you insert a micro SD™/SDHC™/SDXC™ memory card. Refer to the [Memory media](#) section for more information.



*Keep foreign metal objects, such as screws, staples, and paper clips, out of the memory media slot. Foreign metal objects can create a short circuit, which can cause damage and fire, possibly resulting in serious injury.*



### Universal Serial Bus (USB 3.2 Gen1) port

One Type-A Universal Serial Bus port, which complies to the USB 3.2 standard, is provided on the right side of the computer.

The USB 3.2 port is compliant with USB 3.2 Gen1 standard and backward compatible with USB 2.0 devices.



### LAN jack

This jack lets you connect to a LAN. The adapter has built-in support for Ethernet LAN (10 megabits per second, 10BASE-T), Fast Ethernet LAN (100 megabits per second, 100BASE-TX) or Gigabit Ethernet LAN (1000 megabits per second, 1000BASE-T). Refer to [Operating Basics](#), for details.



*Do not connect any cable other than a LAN cable to the LAN jack. It might cause damage or malfunction.*



### Security lock slot

A security cable can be attached to this slot and then connected to a desk or other large object in order to deter theft of the computer.

## Back (TECRA/SATELLITE PRO/dynabook Series)

The following figure shows the back of the computer.

*Figure 3-10 The back of the computer (TECRA/SATELLITE PRO/dynabook Series)*

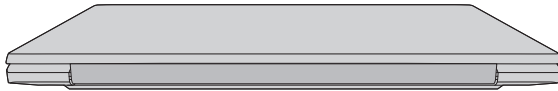

## Underside (TECRA/SATELLITE PRO/dynabook Series)

The following figures show the underside of the computer. Ensure that the display is closed before the computer is turned over to avoid causing any damage.

Figure 3-11 The underside of the computer (TECRA/SATELLITE PRO/dynabook Series)

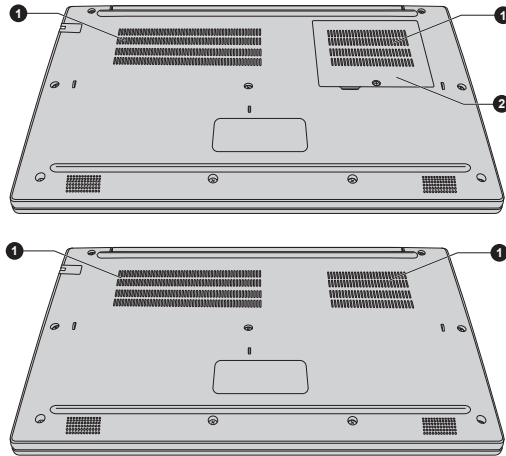

1. Cooling vents

2. Memory module cover\*

\* Provided with some models.

Product appearance depends on the model you purchased.

### Cooling vents

The cooling vents help the processor to avoid overheating.



*Do not block the cooling vents. Keep foreign metal objects, such as screws, staples, and paper clips, out of the cooling vents. Foreign metal objects can create a short circuit, which can cause damage and fire, possibly resulting in serious injury.*

*Carefully clean the dust on the surface of the cooling vents using a soft cloth.*

### Memory module cover

Some models are equipped with the memory module cover. The memory module slot under this cover allows for the installation, replacement and removal of additional memory module.

4 GB, 8 GB or 16 GB memory modules can be installed in the computer's two memory slots for a maximum of 32 GB system memory. The actual amount of useable system memory is less than the installed memory modules.

Refer to the [Additional memory module](#) section.

---

## **Front with the display open (TECRA/SATELLITE PRO/ dynabook Series)**

This section shows the computer with the display panel open. In order to open the display, lift up the display panel and position it at a comfortable viewing angle for you.

Figure 3-12 The front of the computer with the display panel open (TECRA/  
SATELLITE PRO/dynabook Series)

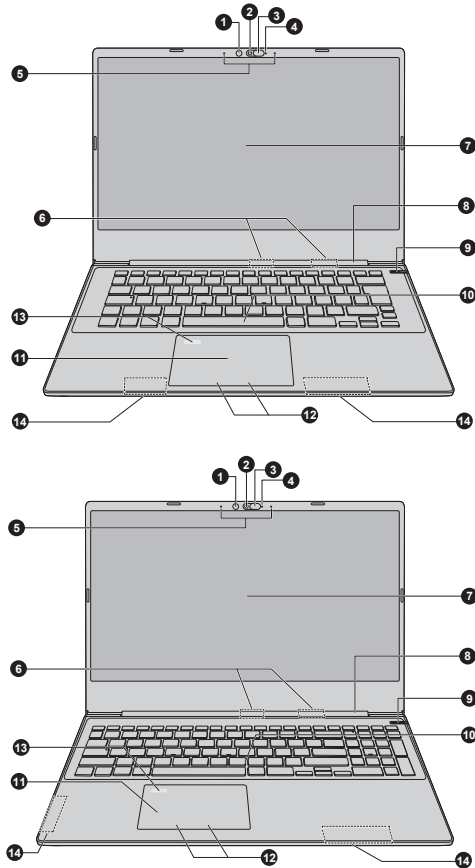

- |  |  |
|--|--|
| 1. Infrared LED*   | 8. Display hinge   |
| 2. Web Camera  | 9. Power button  |
| 3. Web Camera Shutter  | 10. Keyboard   |
| 4. Web Camera LED  | 11. Touch Pad  |
| 5. Microphones   | 12. Touch Pad control buttons                                      |
| 6. Wireless communication antennas<br>(Wireless LAN) (not shown) | 13. Fingerprint sensor*  |
| 7. Display screen  | 14. Wireless communication antennas<br>(Wireless WAN) (not shown)* |

\* Provided with some models.  
Product appearance depends on the model you purchased.

<b>Infrared LED</b>	<p>The infrared LED blinks when Windows Hello Face is operating.</p> <p>Only models which support face recognition feature are equipped with the infrared LED.</p>
<b>Web Camera</b>	<p>Web Camera is a device that allows you to record video or take photographs with your computer. You can use it for video chatting or video conferences using a communication tool.</p> <p>The Web Camera available on some models can support face recognition feature for Windows Hello. For more information, refer to the onscreen instructions in Windows Hello.</p>



- *Do not point the web camera directly at the sun.*
- *Do not touch or press strongly on the web camera lens and infrared LED. Failure to do so might reduce image quality, possibly resulting in recognizing faces incorrectly. Use an eyeglass cleaner (cleaner cloth) or other soft cloth to clean the lens and the LED if it becomes dirty.*
- *It is highly recommended to use Windows Hello Face indoors. Operating outdoors might cause enrollment/sign-in failure due to the possible sunlight affection.*
- *When enrolling your face to Windows Hello, please make sure that there is no other face in preview of Windows Hello setup dialog.*
- *While the web camera is capturing your face, make sure that your face is in front of the web camera and you look directly at it.*

<b>Web Camera Shutter</b>	The Web Camera Shutter can be used to protect your privacy, by sliding towards left to cover the Web Camera lens.
---------------------------	---

<b>Web Camera LED</b>	The Web Camera LED glows when the Web Camera is operating.
-----------------------	--

<b>Microphones</b>	The built-in microphones allow you to record sounds for your application. Refer to the <a href="#">Sound System and Video mode</a> section for more information.
--------------------	--

<b>Wireless communication antennas</b>	<p>Depending on the configuration of your computer, one of the following antennas are built in:</p> <ul style="list-style-type: none"> <li>■ Wireless LAN/Bluetooth®</li> <li>■ Wireless WAN/Wireless LAN/Bluetooth®</li> </ul>
--	---



*Do not cover the wireless communication antennas area with any metal objects, otherwise the wireless function might not work.*

---

#### Legal Footnote (Wireless LAN)

For more information regarding Wireless LAN, refer to the [Legal Footnotes](#) section.

<b>Display screen</b>	<p>39.6 cm (15.6") or 35.6 cm (14.0") LCD screen, is configured with one of the following resolutions depending on the model you purchased:</p> <ul style="list-style-type: none"><li>■ HD, 1366 horizontal x 768 vertical pixels</li><li>■ FHD, 1920 horizontal x 1080 vertical pixels</li></ul> <p>Be aware that, when the computer is operating on the AC adaptor, the image displayed on the internal screen is somewhat brighter than when it operates on battery power. This difference in brightness levels is intended to save power when operating on battery.</p>
-----------------------	---

---

#### Legal Footnote (LCD)

For more information regarding LCD, refer to the [Legal Footnotes](#) section.

<b>Display hinge</b>	<p>The display hinge allows the display panel to be positioned at a variety of easy-to-view angles.</p>
<b>Power button</b>	<p>Press this button to turn the computer's power on or off.</p>
<b>Keyboard</b>	<p>The keyboard contains character keys, control keys, function keys, and special Windows keys, providing all the functionality of a full-size keyboard.</p> <p>Refer to the <a href="#">The Keyboard</a> section for details.</p>
<b>Touch Pad</b>	<p>The Touch Pad located in the palm rest is used to control the movement of the mouse pointer.</p> <p>To use the Touch Pad, simply touch and move your fingertip across it in the direction you want the mouse pointer to go.</p>
<b>Touch Pad control buttons</b>	<p>The two buttons located on the bottom of the Touch Pad are used like the buttons on a standard mouse. Press the left button to select a menu item or to manipulate text or graphics designated by the mouse pointer, and press the right button to display a menu or other function depending on the software you are using.</p>



---

### Fingerprint sensor

This sensor enables you to enroll and sign in with a fingerprint in Windows Hello. For more information, refer to the on-screen instructions in Windows Hello.

Some models are equipped with a fingerprint sensor.

---

## Internal Hardware Components

This section describes the internal hardware components of your computer. The actual specifications might vary depending on the model you purchased.

---

### CPU

The processor type varies depending on model.

To check which type of processor is included in your model, click **Start -> All apps -> dynabook PC Information**.

---

#### Legal Footnote (CPU)

For more information regarding CPU, refer to the [Legal Footnotes](#) section.

---

---

### Internal Storage Drive

The capacity of the internal storage drive varies depending on the model.

Note that part of the internal storage drive overall capacity is reserved as administration space.

---



■ *Your computer is equipped with a "Solid-State Drive (SSD)". In this manual, the word "internal storage drive" refers to SSD unless otherwise stated.*

■ *SSD is a large-capacity storage device which uses Solid-State Memory in place of a magnetic disk of the hard disk.*



*Under certain unusual conditions of prolonged non-use and/or exposure to high temperatures, the SSD might be vulnerable to data retention errors.*

---

#### Legal Footnote (Internal Storage Drive Capacity)

For more information regarding Internal Storage Drive Capacity, refer to the [Legal Footnotes](#) section.

---

## Power Condition Descriptions

The computer operating capability and battery charge status are affected by different power conditions, including whether an AC adaptor is connected and what the battery charge level is.

---

## DC IN/Battery indicator

Check the **DC IN/Battery** indicator to determine the status of the battery pack and the power status with the AC adaptor connected. The following indicator conditions should be noted:

<b>Flashing Amber</b>	The battery charge is low. The AC adaptor must be connected to recharge the battery.
<b>Amber</b>	Indicates that the AC adaptor is connected and the battery is charging.
<b>White</b>	Indicates that the AC adaptor is connected and the battery is fully charged.
<b>Flashing White</b>	Indicates a problem with the computer. Disconnect the AC adaptor for several seconds, and then reconnect the AC adaptor. After that, press the power button. If it still does not operate properly, you should contact your reseller or dealer.
<b>No light</b>	Under any other conditions, the indicator does not light.



*If the battery pack becomes too hot while it is being charged, the charge stops and the **DC IN/Battery** indicator goes out. When the temperature of the battery pack falls to a normal range, charging will resume. This process occurs regardless of whether the computer's power is on or off.*

## Power indicator

Check the **Power** indicator to determine the power status of the computer. The following indicator conditions should be noted:

<b>White</b>	Indicates that power is being supplied to the computer, and the computer is turned on.
<b>No light</b>	Under any other conditions, the indicator does not light.

# Chapter 4

## Operating Basics

This chapter describes the basic operations of your computer, and highlights the precautions that must be taken when using it.

### Using the Touch Screen

Some models are equipped with a touch screen.

You can use your finger to manipulate icons, buttons, menu items, the on-screen keyboard, and other items on the touch screen.



#### Tap

Simply tap your finger once on the touch screen to activate an item, such as an app.



#### Press and hold

Press your finger down and leave it there for a few seconds. This shows information to help you learn more about an item or opens a menu specific to what you are doing.



#### Pinch or stretch

Touch the screen or an item with two fingers, and then move the fingers toward each other (pinch) or away from each other (stretch). This shows different levels of information or visually zooms in or out.



#### Rotate

Put two fingers on an item and then turn your hand to rotate things in the direction you turn your hand. Only some items can be rotated.



#### Slide

Drag your finger on the touch screen to move through what is on the screen.



#### Swipe

Quickly move your finger in from the edge of the screen, without pausing when you first touch it.  
Swipe from the left edge: shows your widgets.  
Swipe from the right edge: opens the Notification center.

For details and more advanced touch screen gestures to interact with Windows operating system, refer to **Tips** in the Start menu.



- *Do not press or push with excessive force on the touch screen.*
- *Do not apply excessive force when cleaning the touch screen.*
- *Never touch the screen with a sharp object such as a ball-point pen which might scratch or damage the surface.*
- *Do not use a protecting sheet for the touch screen as it might decrease its sensitivity to gestures.*
- *Do not touch the screen with gloves, wet hands, or the tip of your fingernails as it might decrease the sensitivity.*
- *The touch screen might not work correctly if part of the surface is slightly wet, or covered with an object.*

## Using the Touch Pad

The Touch Pad on the palm rest might support the following gestures:



### Tap

Tap once on the Touch Pad to activate an item, such as an app.



### Two-Finger Tap

Tap once on the Touch Pad with two fingers together to display a menu or other function depending on the software you are using. (Similar to right-click)



### Pinch or stretch

Place two fingers down on the Touch Pad and move them toward each other (pinch) or away from each other (stretch). This shows different levels of information or visually zooms in or out.



### Two-Finger Scroll

Place two fingers down and slide them vertically or horizontally from anywhere on the Touch Pad. This allows you to operate the scroll bars of a window.



### Three-Finger Tap

Tap once on the Touch Pad with three fingers together to open Windows Search.



### Three-Finger Scroll

Place three fingers down and slide them vertically or horizontally from anywhere on the Touch Pad.

Slide towards left/right: switches between your open apps. Slide your fingers slowly across the Touch Pad to flip through them all.

Slide up: views all your open apps in task view.

Slide down: shows the desktop.



### Four-Finger Tap

Tap once on the Touch Pad with four fingers together to open the Notification center.



### Four-Finger Scroll

Place four fingers down and slide them vertically or horizontally from anywhere on the Touch Pad.

Slide towards left/right: switches between virtual desktops.

Slide up: views all your open apps in task view.

Slide down: shows the desktop.



*Do not put items on the Touch Pad surface to prevent abnormal action.*



*Some of the Touch Pad operations described in this section are only supported in certain applications.*

## The Keyboard

The number of keys available on your keyboard depends on which country/region your computer is configured for, with keyboards being available for numerous languages.

There are different types of keys, specifically typewriter keys, function keys, Windows special keys, and the keypad overlay.



*Never remove the key caps on your keyboard. Failure to do so might damage the parts under the key caps.*

### Keyboard indicators

The following figure shows the position of the **CAPS LOCK** indicator and the **NUM LOCK** indicator.

- When the **CAPS LOCK** indicator glows, the keyboard produces capitals when any letter is typed.
- When the **NUM LOCK** indicator glows, the ten key allows you to enter numbers.

Figure 4-1 Keyboard indicators

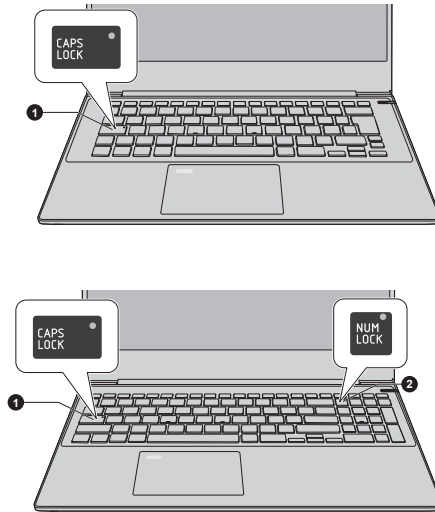

1. CAPS LOCK indicator

2. NUM LOCK indicator

Product appearance depends on the model you purchased.

<b>CAPS LOCK</b>	This indicator glows green when letter keys are locked into their uppercase format.
<b>NUM LOCK</b>	When the NUM LOCK indicator glows, you can use the number keys on the keyboard for number entry.



## Function Keys

The function keys (F1 ~ F12) are the 12 keys at the top of your keyboard.



Function keys let you enable or disable certain features of the computer. The functions can be performed by pressing the associated function keys.

Key Combination	Function
FN + F1	Enters "Lock computer mode". To restore your desktop, you need to log on again.
FN + F2	Switches between the power plans.

<b>Key Combination</b>	<b>Function</b>
FN + F3	Switches the system to Sleep Mode.
FN + F4	Turns the Microphone mute on or off.
FN + F5	Changes the active display device. To use a simultaneous mode, you must set the resolution of the internal display panel to match the resolution of the external display device.
FN + F6	Decreases the brightness of the display panel in individual steps.
FN + F7	Increases the brightness of the display panel in individual steps.
FN + F8	Turns the Airplane Mode on or off.
FN + F9	Enables or disables the Touch Pad.
FN + F10	Turns on Arrow Mode.
FN + F11	Turns on Numeric Mode.
FN + F12	Locks the cursor on a specific line.
FN + ESC	Turns the playback sound on or off.
FN + 1	Reduces the icon size on the desktop or the font sizes within one of the supported application windows.
FN + 2	Enlarges the icon size on the desktop or the font sizes within one of the supported application windows.
FN + 3	Decreases the playback volume of the computer.
FN + 4	Increases the playback volume of the computer.
FN + Space	Changes the display resolution.
FN + S (  )	Allows you to search your computer, the web, or within an app.
FN + A (  )	Enables the same function as the secondary (right) mouse button.

Key Combination	Function
FN + Z (  )	<p>Toggles the mode of the keyboard backlight between <b>Timer</b>, <b>On</b>, and <b>Off</b>.</p> <p>To set up the brightness, click <b>Start -&gt; All apps -&gt; dynabook Settings</b>. Click <b>Keyboard</b> tab, and select a level under <b>Keyboard Backlight Brightness Control</b>.</p> <p>To set up the timer, launch the dynabook Setup Utility, select <b>Power Management -&gt; Keyboard Backlight Control Mode</b>, and select <b>TIMER</b>. Adjust the timer under <b>Backlight Lighting Time</b>.</p> <p>This function is supported with some models.</p>



*Some functions show the toast notification at the edges of the screen. Those toast notifications are enabled by default. You can disable them in dynabook Settings.*

*To access it, click **Start -> All apps -> dynabook Settings -> Keyboard**.*

## Windows special keys

The keyboard provides two keys that have special functions in Windows, the Windows® logo key activates the **Start menu** while the application key has the same function as the secondary (right) mouse button.



This key activates the Windows **Start menu**.



This key has the same function as the secondary (right) mouse button.

Please note that this key is only provided with some models.

## Using the Fingerprint Sensor

Some models are equipped with the fingerprint sensor for the purpose of enrolling and recognizing fingerprints. Lightly touch and rest your finger on the fingerprint sensor to recognize fingerprints. During enrollment, you might need to touch and lift your finger on the sensor repeatedly until setup is complete. Follow the on-screen instructions to finish the setup.

By enrolling the ID and password onto the fingerprint authentication feature, it is no longer necessary to input the password from the keyboard. Fingerprint feature enables you to:

- Sign-in to Windows
- Authentication of the User Password (and, if applicable, the HDD/SSD Password) when booting up the computer (Pre-Boot authentication)



- Single Sign-On feature

Figure 4-2 Using the fingerprint sensor

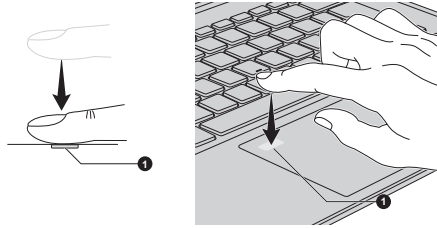

#### 1. Fingerprint sensor

Product appearance depends on the model you purchased.



- *Fingerprint cannot be used in models that do not have a fingerprint function.*
- *Total fingerprints which can be registered are 10 pcs per account.*

## Points to note about the Fingerprint Sensor

Be aware of the following considerations when using the fingerprint sensor. A failure to follow these guidelines might result in damage to the sensor, sensor failure, fingerprint recognition problems or a lower fingerprint recognition success rate.

- Do not scratch or poke the sensor with your nails or any hard or sharp objects.
- Do not press the sensor strongly.
- Do not touch the sensor with a wet finger or any wet objects. Keep the sensor surface dry and free from water vapor.
- Do not touch the sensor with a soiled or dirty finger as minute foreign particles of dust and dirt might scratch it.
- Do not paste stickers or write on the sensor.
- Do not touch the sensor with a finger or any other object which might have a build-up of static electricity on it.

Observe the following before you place your finger on the sensor whether for fingerprint enrollment/registration or recognition:

- Wash and dry your hands thoroughly.
- Remove static electricity from your fingers by touching any metal surface. Static electricity is a common cause of sensor failures, especially when the weather is dry.
- Clean the sensor with a lint-free cloth. Do not use detergent or any other chemicals to clean the sensor.

---

Avoid the following finger conditions for enrollment or recognition as they might result in fingerprint enrollment errors or a drop in the fingerprint recognition success rate:

- Soaked or swollen finger, for example as might occur after taking a bath
- Injured finger
- Wet finger
- Soiled or oily finger
- Extremely dry skin condition on finger

Observe the following to improve the fingerprint recognition success rate:

- Enroll two or more fingers.
- Enroll additional fingers if a recognition failure often occurs when using already enrolled fingers.
- Check the condition of your finger. Any conditions which have changed since enrollment, such as injury, rough skin, and extremely dry, wet, soiled, dirty, oily, soaked or swollen fingers, might lower the recognition success rate. Also if the fingerprint is worn down or the finger becomes thinner or fatter, the recognition success rate might be lowered.
- As the fingerprint for each finger is different and unique, you should ensure that only the registered or enrolled fingerprint or fingerprints are used for identification.
- The fingerprint sensor compares and analyzes the unique characteristics in a fingerprint. However, there might be instances where certain users are unable to register their fingerprints due to insufficient unique characteristics in their fingerprints.
- The recognition success rate might differ from user to user.

## Battery

This section explains battery types, use, recharging methods and handling.

### Battery pack

When the AC adaptor is not connected, the main power source of the computer is a lithium ion battery pack, also referred to in this manual as the main battery.

### Real-Time Clock (RTC) function

The Real-Time Clock (RTC) function is supported. The main battery provides power for the internal real-time clock and calendar function and also maintains the system configuration while the computer is turned off. If the RTC lasting time completely runs out, the system will lose this information and the real-time clock and calendar will stop working.

You can change the Real-Time Clock settings in the dynabook Setup Utility. Refer to [Real-Time Clock](#) for further information.

---

## Care and use of the battery pack

This section provides the important safety precautions in order to handle your battery pack properly.

Refer to the enclosed **Instruction Manual for Safety and Comfort** for detailed precautions and handling instructions.



*Charge the battery pack only in an ambient temperature from 5 through 35 degrees Celsius. Otherwise, the electrolyte solution might leak, battery pack performance might deteriorate, and the battery life might be shortened.*

## Charging the battery

When the power in the battery pack becomes low, the **DC IN/Battery** indicator flashes amber to indicate that only a few minutes of battery power remain. If you continue to use the computer while the **DC IN/Battery** indicator flashes, the computer enters Hibernation Mode so that you do not lose any data, and automatically turns itself off.

You must recharge the battery pack when it becomes discharged.

### **Procedures**

To recharge a battery pack, connect the AC adaptor to the DC IN 19V jack or Thunderbolt™ 4/USB Type-C™ port and plug the other end into a working outlet. The **DC IN/Battery** indicator glows amber while the battery is being charged.

### **Charging Time**

The following table shows the approximate time required to charge an exhausted battery fully.

Battery type	Power off	Power on
Battery pack (53 Wh, 4 cell)	about 3 hours	about 3 ~ 10 hours



- *Be aware that the charging time when the computer is on is affected by ambient temperature, the temperature of the computer and how you are using the computer. If you make heavy use of external devices for example, the battery might scarcely charge at all during operation.*

- *Note that charging time will vary depending on the ambient temperature, the computer's internal temperature, and how the computer is being used. For example, whether the display is set to shut off automatically when idle, whether you make heavy use of external devices powered by the computer, or if the computer's internal storage drive is being accessed frequently by an application.*
- *The battery might not be charged depending on how the computer is being used, and the charge of battery decreases and battery might not be fully charged sometimes.*

### **Charging notice**

The battery might not begin charging immediately under the following conditions:

- The battery is extremely hot or cold (if the battery is extremely hot, it might not charge at all). To ensure the battery charges to its full capacity, charge it at room temperature of between 5°C to 35°C (41°F to 95°F).
- The battery is nearly completely discharged. In this instance, leave the AC adaptor connected for a few minutes and the battery should begin charging.

The **DC IN/Battery** indicator might show a rapid decrease in battery operating time when you try to charge a battery under the following conditions:

- The battery has not been used for a long time.
- The battery has completely discharged and been left in the computer for a long time.

In such cases, do the following:

1. Fully discharge the battery by leaving it in the computer with the power on until the system automatically turns itself off.
2. Connect the AC adaptor to the DC IN 19V jack or Thunderbolt™ 4/ USB Type-C™ port on the computer and to a wall outlet that is supplying power.
3. Charge the battery until the **DC IN/Battery** indicator glows white.

Repeat these steps two or three times until the battery recovers normal capacity.

## **Monitoring battery capacity**

Remaining battery power can be monitored using the following methods:

- Clicking the battery icon on the Windows Taskbar
- Via the Battery Status in the Windows Mobility Center window



- *Wait several seconds to monitor the remaining operating time because the computer needs time to check the remaining capacity of the battery pack and then calculate the remaining operating time, based on this together with the current power consumption.*
- *Be aware that the actual remaining operating time might differ slightly from the calculated time.*
- *With repeated discharges and recharges, the battery capacity will gradually decrease. In view of this, it is noted that an often used, older battery will not operate for as long as a new battery even when both are fully charged.*

## Maximizing battery operating time

The usefulness of a battery depends on how long it can supply power on a single charge, while how long the charge lasts in a battery depends on:

- Processor speed
- Screen brightness
- Internal storage drive power off period
- How often and for how long you use the internal storage drive and external disk drives, for example, optical disc
- How much charge the battery contained to begin with
- How you use optional devices, such as a USB device, to which the battery supplies power
- Where you store your programs and data
- Whether you close the display panel when you are not using the keyboard - closing the display saves power.
- The environmental temperature - operating time decreases at low temperatures.
- System Sleep Mode
- System Hibernation Mode
- Display power off period
- Whether you enable Sleep Mode, which can conserve battery power if you are frequently turning the computer off and on.

## Battery pack exhausted time

When you turn off the power of your computer with the battery pack fully charged, the battery pack will exhaust within the following approximate period:

Battery type	Sleep Mode	Shut Down Mode
Battery pack (53 Wh, 4 cell)	about 6 days	about 20 days



*Be aware that the battery pack exhausted time is affected if there are any external devices connected.*

## Extending battery life

To maximize the life of your battery pack, do the following at least once a month:

1. Turn off the computer's power.
2. Disconnect the AC adaptor and turn on the computer's power. If it does not turn on, then go to Step 4.
3. Operate the computer on battery power for five minutes. If you find that the battery pack has at least five minutes of operating time, continue operating until the battery pack is fully discharged. However, if the **DC IN/Battery** indicator flashes or there is some other warning to indicate a low battery condition, go to Step 4.
4. Connect the AC adaptor to the DC IN 19V jack or Thunderbolt™ 4/ USB Type-C™ port on the computer and to a wall outlet that is supplying power. The **DC IN/Battery** indicator glows amber to indicate that the battery pack is being charged. However, if **DC IN/Battery** indicator does not glow, this indicates that power is not being supplied. Check the connections for the AC adaptor and the power cord.
5. Charge the battery pack until the **DC IN/Battery** indicator glows white.

## Memory media

The computer is equipped with a memory media slot that can accommodate some kinds of memory media with various memory capacities so that you can easily transfer data from devices, such as digital cameras and Personal Digital Assistants.



*Keep foreign objects out of the memory media slot. Never allow metal objects, such as screws, staples and paper clips, to enter the computer or keyboard. Foreign metal objects can create a short circuit, which can cause computer damage and fire, possibly resulting in serious injury.*



- *This memory media slot supports the following memory media: microSD/SDHC/SDXC card.*
- *Not all memory media have been tested and verified to work correctly. Therefore, it is not possible to guarantee that all memory media can operate properly.*

Figure 4-3 Example of memory media (microSD card)



---

## Points to note about the memory media card

microSD/SDHC/SDXC memory cards comply with SDMI (Secure Digital Music Initiative), which is a technology adopted to prevent unlawful copy or playback of digital music. For this reason, you cannot copy or play back protected material on another computer or other device, and you cannot reproduce any copyrighted material except for your personal enjoyment.

The supported maximum capacity of memory card is 512 GB.

## Memory media format

New media cards are formatted according to specific standards. If you wish to reformat a media card, be sure to do so with a device that uses media cards.

### ***Formatting a memory media card***

Memory media cards are sold already formatted in conformity to specific standards. If you reformat a memory card, be sure to reformat it with a device such as digital camera or digital audio player that uses the memory cards, not with the format command provided within Windows.



*To format all areas of the memory card, including the protected area, you must obtain an appropriate application that applies the copy protection system.*

## Media care

Observe the following precautions when handling the card:

- Do not twist or bend cards.
- Do not expose cards to liquids or store in humid areas or lay media close to containers of liquid.
- Do not touch the metal part of a card or expose it to liquids or let it get dirty.
- After using the card, return it to its case.
- The card is designed so that it can be inserted only one way. Do not try to force the card into the slot.
- Memory cards have a limited lifespan, so it is important to back up important data.
- Do not write to a card if the battery power is low. Low power might affect writing accuracy.
- Do not remove a card while read/write is in progress.



*For more details on using memory cards, see manuals accompanying the cards.*

## Inserting memory media

The following instructions apply to all types of supported media devices. To insert memory media, do the following:

1. Turn the memory media so that the contacts (metal areas) face down.
2. Insert the memory media into the memory media slot on your computer.
3. Press the memory media gently until it clicks into place.

Figure 4-4 Inserting memory media

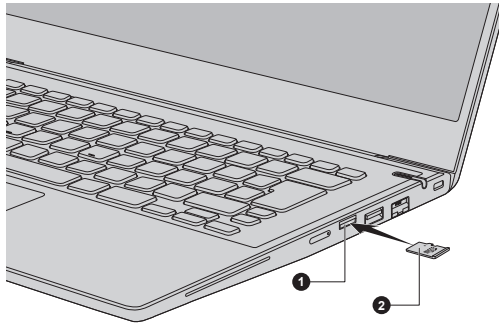

1. Memory media slot

2. Memory media

Product appearance depends on the model you purchased.



- *Make sure that the memory media is oriented properly before you insert it. If you insert the media in wrong direction, you might not be able to remove it.*
- *When inserting the memory media, do not touch the metal contacts. You might expose the storage area to static electricity, which can destroy data.*
- *Do not turn off the computer or switch to Sleep Mode or Hibernation Mode while files are being copied. Failure to do so might cause data loss.*

## Removing memory media

The following instructions apply to all types of supported media devices. To remove memory media, do the following:

1. Click the **Safely Remove Hardware and Eject Media** icon on the Windows taskbar.
2. Select the memory media that you want to remove.
3. Push the memory media until you hear a click to partially release it.
4. Grasp the media and remove it.





- *If you remove the memory media or turn off the power while the computer is accessing the memory media, you might lose data or damage the media.*
- *Do not remove the memory media while the computer is in Sleep or Hibernation Mode. The computer might become unstable or data in the memory media might be lost.*

## Smart Card

A Smart Card is a credit card sized plastic card. An extremely thin integrated circuit (IC chip) is embedded into the card on which information can be recorded. These cards can be used for a wide variety of applications including telephone related and electronic monetary payments.

This section contains information on the proper use of the Smart Card slot, and it is strongly recommended that you read it before operating the computer.



*Your computer supports ISO 7816-3 asynchronous cards (support protocols are T=0 and T=1) with a working voltage of 5 V.*

Some models are equipped with a Smart Card slot on the right side of the computer. The Windows hot-install feature allows you to insert a Smart Card while the computer is turned on.

To insert a Smart Card, do the following:

1. Insert the Smart Card into the Smart Card slot with the metal connectors facing up.
2. Press the Smart Card gently to ensure a firm connection is made.



- *When inserting a Smart Card into the Smart Card slot, make sure to confirm that the card is oriented correctly before inserting.*
- *Insert the Smart Card until it reaches the end of the Smart Card slot. The Smart Card is partially extended beyond the chassis edge. Do not attempt to insert it further.*
- *Always remove the Smart Card from the Smart Card slot before moving the computer.*
- *Before removing the Smart Card, confirm that the Smart Card is not working with any program or system.*
- *Remove the Smart Card after use.*
- *Be careful not to bend the Smart Card while removing it from the computer.*

*Failure to follow these instructions might result in damage to the computer and/or damage to the Smart Card.*

3. After inserting the Smart Card, you should refer to its documentation and also check the configuration in Windows to ensure that it is correct.

## Additional memory module

This section is only applicable for models equipped with the memory module cover.

You can install additional memory into the computer in order to increase the amount of system memory that is available. This section describes how to install and remove optional memory modules.



- *You should place a mat beneath the computer in order to prevent the computer's lid from scratches or damages when you are installing/replacing the memory module. In this instance, you should avoid mats that are made of materials that hold or generate static electricity.*
- *When installing or removing a memory module, you must ensure that you do not touch any other internal areas of the computer.*



- *Use only memory modules approved by Dynabook.*
- *Do not try to install or remove a memory module under the following conditions:*
  - a. The computer is turned on.*
  - b. The computer was shut down in either Sleep or Hibernation Mode.*
  - c. The wireless communication function is on.*
  - d. Power Off and Charge function is enabled.*
- *Be careful not to let screws or other foreign matter fall into the computer. It might cause malfunction or electric shock.*
- *Additional memory module is a precision electronic component that might be fatally damaged by static electricity. Since the human body can carry static electricity, it is important that you discharge yourself before touching or installing any additional memory modules. To discharge your body's static electricity, simply touch any metal close to you with bare hands.*

## Installing a memory module

To install a memory module, do the following:

1. Click **Start** ->  (**Power**) and then click **Shut down** while holding down the **SHIFT** key. Ensure that the **Power** indicator is off.
2. Remove the AC adaptor and all cables and peripherals connected to the computer.
3. Close the display panel and turn the computer upside down.

4. Loosen the screw securing the memory module cover in place. Note that the screw is attached to the cover in order to prevent it from being lost.
5. Slide your fingernail or a thin object under the cover and lift it off.

Figure 4-5 Removing the memory module cover

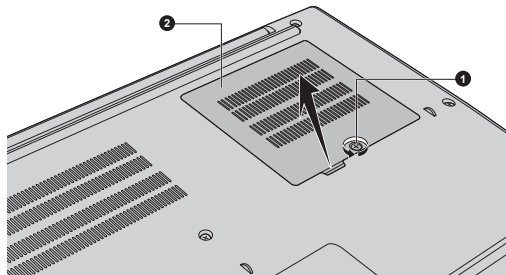

1. Screw

2. Memory module cover

6. Align the notch of the memory module with that of the memory slot and gently insert the module into the slot at about a 30 degree angle before holding it down until the latches on either side snap into place.

Figure 4-6 Seating the memory module

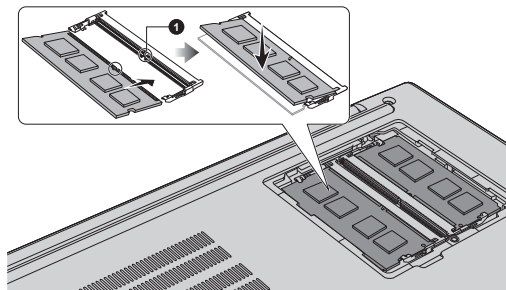

1. Notch



- *Never allow metal objects, such as screws, staples and paper clips, to enter the computer. Foreign metal objects can create a short circuit, which can cause computer damage and fire, possibly resulting in serious injury.*
- *Do not touch the connectors on the memory module or on the computer. Debris on the connectors might cause memory access problems.*



- *Align the grooves along the edges of the memory module with the locking tabs on the connector and insert the module into the connector firmly. If you find it difficult to install the memory module, gently prise the locking tabs outwards using the tip of your finger.*

- Also ensure that you hold the memory module along its left and right hand edges - the edges with the grooves in.

7. Seat the memory module cover in place and secure it with the screw.



Ensure that the memory module cover is firmly closed.

Figure 4-7 Seating the memory module cover

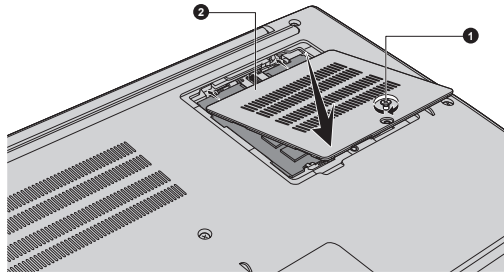

1. Screw

2. Memory module cover

8. Turn your computer over.
9. Connect the AC adaptor and turn on the computer. Make sure that the added memory is recognized. To confirm it, click **Start -> All apps -> dynabook PC Information**.

## Removing a memory module

To remove the memory module, do the following:

1. Click **Start -> ⏻ (Power)** and then click **Shut down** while holding down the **SHIFT** key. Ensure that the **Power** indicator is off.
2. Remove the AC adaptor and all cables and peripherals connected to the computer.
3. Close the display panel and turn the computer upside down.
4. Loosen the screw securing the memory module cover in place. Note that the screw is attached to the cover in order to prevent it from being lost.
5. Slide your fingernail or a thin object under the cover and lift it off.
6. Push the latches away from the module in order to release it. A spring forces one end of the module up at an angle.
7. Grasp the module by its edges and remove it from the computer.



- If you use the computer for a long time, the memory modules and the circuits locating close to the memory modules will become hot. In this case, let them cool to room temperature before you replace them. Or you will get burnt if you touch any of them.

- *Do not touch the connectors on the memory module or on the computer. Debris on the connectors might cause memory access problems.*

Figure 4-8 Removing the memory module

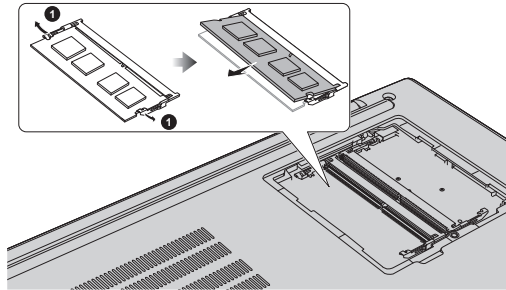

1. Latches

8. Seat the memory module cover in place and secure it with the screw.



*Ensure that the memory module cover is firmly closed.*

9. Turn your computer over.
10. Connect the AC adaptor and turn the computer on.

## Wireless WAN device

Some models are equipped with the Wireless WAN device. This device enables a high-speed connection to the internet, corporate intranet, and your email while you are away from the office.

### Installing a SIM card

To install a SIM card, do the following:

1. Click **Start** ->  (**Power**), and then select **Shut down** and ensure that the **Power** indicator is off.
2. Remove the AC adaptor and all cables and peripherals connected to the computer.
3. Locate the SIM card slot.
4. To pop the SIM card tray partially open, insert a slender object (about 10 mm, diameter 0.8 mm), such as a straightened paper clip, into the eject hole. Gently pull to open the SIM card tray.
5. Place the SIM card into the SIM card tray with the metal connectors facing down.

6. Insert the SIM card tray into the SIM card slot, and push the center of the tray to close it. Press gently until it locks into place.

Figure 4-9 Installing the SIM card

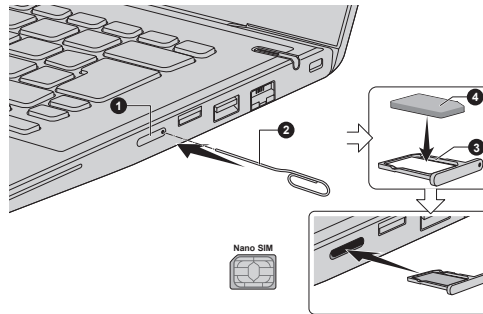

1. SIM card slot
2. Slender object (diameter 0.8 mm)
3. SIM card tray
4. SIM card

Product appearance depends on the model you purchased.



- *Never allow metal objects, such as screws, staples and paper clips, to enter the computer. Foreign metal objects can create a short circuit, which can cause damage and fire, possibly resulting in serious injury.*
- *Do not touch the connectors on the SIM card or on the computer. Debris on the connectors might cause access problems.*



*If you can see **Internet and attach** at APN type when creating APN information, please make sure to select **Internet and attach** as the APN type.*

## Removing a SIM card

To remove the SIM card, do the following:

1. Shut down the computer. Make sure the **Power** indicator is off.
2. To pop the SIM card tray partially open, insert a slender object (about 10 mm, diameter 0.8 mm), such as a straightened paper clip, into the eject hole. Gently pull to open the SIM card tray.
3. Remove the SIM card from the SIM card tray.
4. Insert the SIM card tray back into the SIM card slot.

## GPS Function

If your computer includes Wireless WAN device, it may include GPS (Global Positioning System).

The performance of GPS varies depending on the environment. Failure to pinpoint a location might happen.

---

Your current location might not be shown depending on the status of GPS or the location. If you are obtaining your current location information from the computer, your current location might not be detected due to the information accuracy. Specifically, your current location might not be detected in the following places or situations:

- Inside or directly under a building
- Inside a bag or box
- Among dense trees
- When there is an obstacle (person or object) in front of the antenna
- Underground tunnel, underground, or underwater
- Buildings, streets or residential areas
- Near to high voltage cables
- Bad weather, such as heavy rain or snow

## HDMI™ out port

HDMI™ (High-Definition Multimedia Interface™) out port digitally transfers both video and audio data without reducing the quality. HDMI™-compatible external display devices including televisions can be connected via the HDMI™ out port.



*As the port operation of all external monitors have not been confirmed, some display devices might not function properly.*

To connect an HDMI™-compatible display device, do the following:



*To connect a device to the HDMI™ out port, you must purchase a suitable HDMI™ cable.*

1. Plug one end of the HDMI™ cable into the HDMI™ in port of the HDMI™ display device.
2. Turn the HDMI™ display device's power on.
3. Plug the other end of the HDMI™ cable into the HDMI™ out port on your computer.

Figure 4-10 Connecting the HDMI™ out port

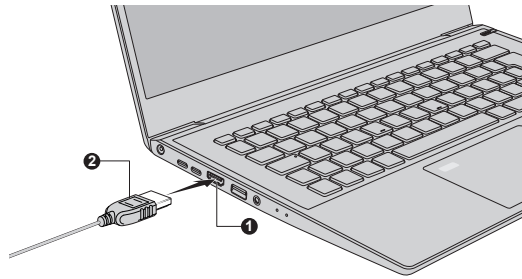

1. HDMI™ out port

2. HDMI™ cable

Product appearance depends on the model you purchased.



*Do not plug/unplug an HDMI™ device under the following conditions:*

- *The system is starting up.*
- *The system is shutting down.*

*When you unplug the HDMI™ cable and replug it, wait at least 5 seconds before you replug the HDMI™ cable again.*

## Settings for display video on HDMI™

To view video on the HDMI™ display device, be sure to configure the settings, otherwise you might find that nothing is displayed.



*Be sure to select the display device or audio device before starting to play video. Do not change the display device or audio device while playing video.*

*Do not change the display device under the following conditions:*

- *While data is being read or written*
- *While communication is being carried out*

## LAN

The computer has built-in support for Ethernet LAN (10 megabits per second, 10BASE-T), Fast Ethernet LAN (100 megabits per second, 100BASE-TX) or Gigabit Ethernet LAN (1000 megabits per second, 1000BASE-T).

This section describes how to connect/disconnect to a LAN.



- *The Wake-up on LAN function consumes power even when the system is off. Leave the AC adaptor connected while using this feature.*



- 
- *The link speed (10/100/1000 megabits per second) changes automatically depending on the network conditions (connected device, cable or noise and so on).*

## LAN cable types



*The computer must be configured properly before connecting to a LAN. Logging onto a LAN using the computer's default settings might cause a malfunction in LAN operation. Check with your LAN administrator regarding set-up procedures.*

If you are using Gigabit Ethernet LAN (1000 megabits per second, 1000BASE-T), be sure to connect with a CAT5e cable or higher. You cannot use a CAT3 or CAT5 cable.

If you are using Fast Ethernet LAN (100 megabits per second, 100BASE-TX), be sure to connect with a CAT5 cable or higher. You cannot use a CAT3 cable.

If you are using Ethernet LAN (10 megabits per second, 10BASE-T), you can connect with a CAT3 or higher cable.

## Connecting the LAN cable



To connect the LAN cable, do the following:

- *Connect the AC adaptor before connecting the LAN cable. The AC adaptor must remain connected during LAN use. If you disconnect the AC adaptor while the computer is accessing a LAN, the system might hang up.*
- *Do not connect any other cable to the LAN jack except the LAN cable. Otherwise, malfunctions or damage might occur.*
- *Do not connect any power supplying device to the LAN cable that is connected to the LAN jack. Otherwise, malfunctions or damage might occur.*

1. Turn off the power to all external devices connected to the computer.

2. Plug one end of the cable into the LAN jack. Press gently until you hear the latch click into place.

Figure 4-11 Connecting the LAN cable

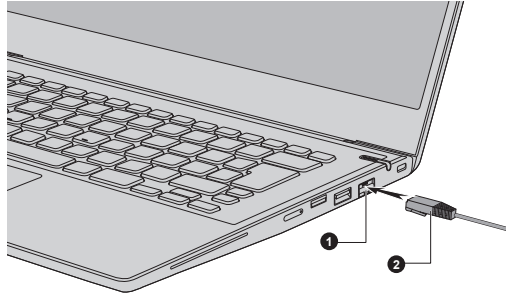

1. LAN jack

2. LAN cable

Product appearance depends on the model you purchased.

3. Plug the other end of the cable into a LAN hub connector or router. Check with your LAN administrator and hardware or software vendor before using or configuring a network connection.



*To disconnect the LAN cable, gently grasp the LAN cable while pressing the latch, and then slowly lift it up to remove it.*

## USB Type-C™ Adapters

Your computer capabilities can be enhanced by connecting external devices such as RGB monitor to the Thunderbolt™ 4/USB Type-C™ port via USB Type-C™ adapters.

Depending on the model you purchased, one of the following USB Type-C™ adapters might be provided.



- *Always use the USB Type-C™ adapter that is included with your computer or Dynabook accessories.*
- *When connecting the USB Type-C™ adapter, Thunderbolt function is not supported.*
- *Do not connect other USB Type-C™ adapter to USB Type-C™ port of USB Type-C™ adapter.*

- Type-C to RGB Adapter

This adapter provides: RGB monitor port.

Figure 4-12 Type-C to RGB Adapter

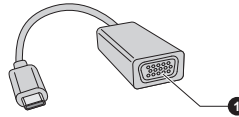

1. RGB monitor port



The output resolution of RGB monitor port on this adapter is up to 2048 x 1280 @60Hz.

- USB-C™ to HDMI™/VGA Travel Adapter

This adapter provides: USB Type-C™ port (Power Delivery Charging), USB 3.0 port, HDMI™ out port, RGB monitor port, and LAN jack.

Figure 4-13 USB-C™ to HDMI™/VGA Travel Adapter

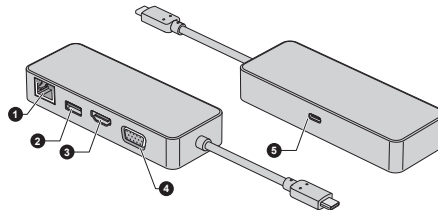

1. LAN jack  
2. USB 3.0 port

3. HDMI™ out port

4. RGB monitor port  
5. USB Type-C™ port (Power Delivery Charging)



- The output resolution of HDMI™ out port on this adapter is up to 3840 x 2160 @30Hz, and output resolution of RGB monitor port on this adapter is up to 1920 x 1200 @60Hz.

- Do not use the HDMI™ out port and RGB monitor port simultaneously.
- The USB Type-C™ port (Power Delivery Charging) on this adapter is used for connecting an AC adaptor only. USB data transmission is not supported by this port.

## RGB monitor port

An external analog monitor can be connected to the RGB monitor port on the USB Type-C™ adapter. To connect an external analog monitor, do the following:

1. Connect the USB Type-C™ adapter to one of the Thunderbolt™ 4/ USB Type-C™ ports on your computer.

2. Plug one end of the RGB cable into the RGB port of the external RGB monitor.
3. Turn the external monitor's power on.
4. Plug the other end of the RGB cable to the RGB monitor port on the USB Type-C™ adapter.



*There are no fastening screws for an external monitor cable on the RGB monitor port. However, external monitor cables which have connectors with fastening screws can still be used.*

Figure 4-14 Connecting the RGB cable to the RGB monitor port

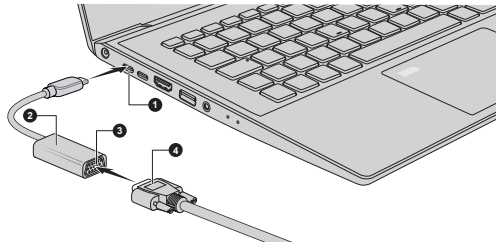

1. Thunderbolt™ 4/USB Type-C™ port
2. USB Type-C™ adapter
3. RGB monitor port
4. RGB cable

USB Type-C™ adapter appearance varies depending on the model you purchased.

When displaying desktop on an external RGB monitor, desktop is sometimes displayed on the center of the monitor with black bars around desktop (with small size).

In this case, read the manual of the monitor and set the suitable supporting display mode at the monitor. Then it will be displayed in suitable size with correct aspect ratio.

## Wireless display

Your computer might support wireless display, a wireless technology which utilizes Wi-Fi® to allow the computer to be wirelessly connected to external displays including TVs as extended screens. With wireless display, documents, streamed/local media contents or other online contents can be shared wirelessly with others.

To use wireless display, either one of the following devices is required:

- A compatible external display with built-in support for wireless display.
- An external display with HDMI™ port and a wireless display adapter.

The wireless display adapter is a device that connects to the external display via HDMI™ port and can receive Wi-Fi® signals from your computer.

To wirelessly connect to an external display, you can follow the steps as described below:

1. Click **Start -> Settings -> Bluetooth & devices -> Add device**.
2. Click **Wireless display or dock**. Your computer starts searching for the wireless display device.
3. After the wireless display device is searched, follow the on-screen instructions to finish connection.

After the connection is established, the name of the wireless display device appears under **Devices**.

To disconnect the Wireless display device, click the wireless display device name and then click **Remove device**.

## Security lock

A security lock enables you to anchor your computer to a desk or other heavy object in order to help prevent unauthorized removal or theft. The computer has a security lock slot into which you can attach one end of the security cable, while the other end attaches to a desk or similar object. The methods used for attaching security cables differ from product to product. Refer to the instructions for the product you are using for more information.

### Connecting the security lock

To connect a security cable to the computer, do the following:

1. Turn the computer so the security lock slot faces you.
2. Align the security cable with the lock slot and secure it in place.

*Figure 4-15 Security lock*

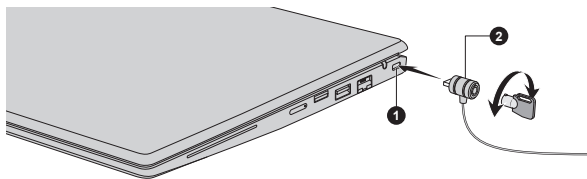

1. Security lock slot

2. Security lock

Product appearance depends on the model you purchased.

## Optional Accessories

To make your computer even more powerful and convenient to use, you can add a number of accessories. For reference, the following list details some of the items that are available from your reseller or Dynabook dealer:

### **AC Adaptor**

If you frequently use your computer at more than one site, it might be convenient to purchase an additional AC adaptor to be kept at each site in order to remove the need to carry the adaptor with you always.

---

### USB Type-C™ Adapters

You can purchase different types of USB Type-C™ adapters as accessories from Dynabook. Please contact your reseller or Dynabook dealer regarding which type is available in your region.

---

### Thunderbolt™ 3/Thunderbolt™ 4 Dock

Thunderbolt™ 3/Thunderbolt™ 4 Dock is the docking station that enables you to connect your computer peripherals through one Thunderbolt™ 3/Thunderbolt™ 4 cable to selected Dynabook computers. Refer to Thunderbolt™ 3/Thunderbolt™ 4 Dock's User's Manual for more details.

---

### dynabook USB-C™ Dock

dynabook USB-C™ Dock is the docking station that enables you to connect your computer peripherals through one USB Type-C™ cable to selected Dynabook computers. Refer to dynabook USB-C™ Dock's User's Manual for more details.



*Not all the accessories are available in your region. Contact your reseller or Dynabook dealer for more information.*

## Sound System and Video mode

This section describes some of the audio control functions.

### Volume Mixer

The Volume Mixer lets you control the audio volume for playback of devices and applications under Windows.

- To launch the Volume Mixer settings, right-click on the speaker icon on the Windows Taskbar, and then select **Open volume mixer** from the sub menu.
- To adjust the volume level of speakers or headphones, move the **Volume** slider.
- To adjust the volume level of an application that you are using, move the slider for the corresponding application.

### Microphone Level

To change the microphone recording level, do the following:



*If the microphones are not built in, you can connect an external microphone instead.*

1. Click **Start -> All apps -> Windows Tools** and double-click **Control Panel**.
2. Click **Hardware and Sound -> Sound -> Recording**.

3. Select **Microphone Array** or **External Microphone**, and click **Properties**.
4. On the **Levels** tab, move the **Microphone Array** or **External Microphone** slider to increase or decrease the microphone volume level.

If you feel the microphone volume level is inadequate while using an external microphone, move the **Microphone Boost** slider to a higher level.

## DTS Audio Processing

DTS Audio Processing is a premium audio enhancement suite that utilizes revolutionary audio technology to provide the most immersive and realistic listening experience ever offered for a two speaker playback environment.

DTS Audio Processing is provided with some models.

To access the utility, click **Start -> All apps -> DTS Audio Processing**.



*When the eco Mode is activated or the CPU is in high usage, noise may occur during video or music playback. If noise occurs, we recommend that you disable the eco Mode or exit applications that affect computer operation.*

## Realtek Audio Console

You can confirm and change the audio configuration using the **Realtek Audio Console**. To launch the **Realtek Audio Console**:

- Click **Start -> All apps -> Realtek Audio Console**.

### **Main**

When you launch the Realtek Audio Console, the **Main** tab shows all available Playback and Recording devices. You can adjust the volume and switch to related setting pages by clicking the  icon in this tab.

### **Speakers/Headphones**

This tab allows you to set Main Volume, AI Noise Reduction, Default Format and Speaker configuration.

Click the **Auto Test** button  at the bottom of this tab to confirm the internal speakers or the headphone sound is coming from the right direction.

### **Microphone Array/External Microphone**

This tab allows you to set Main Volume, Microphone Effects and Default Format.



*If the microphones are not built in, you can connect an external microphone instead.*

### **Device advanced settings**

This tab allows you to choose the type of headphone or microphone and select devices when an external device is plugged in.

To choose the type of headphone or microphone, do the following:

1. Plug a headphone or microphone into the headphone/microphone jack.
2. Click the **Device advanced settings** tab.
3. Select one from the device list under **ANALOG** for the device you plugged into.

When an external headphone is plugged in, you can turn on/off the multi-stream function under **Playback Device** in this tab.

To use multi-stream function, do the following:

1. Select **Make internal and external output devices playback two different audio streams simultaneously**.
2. Click **Start -> Settings -> System -> Sound -> Volume mixer**.
3. Choose different devices from the drop-down list.

### **Information**

This tab shows the driver version and UI version as well.

## **Video mode**

Video mode settings are configured via the **Display** dialog.

To open the **Display** dialog, click **Start -> Settings -> System -> Display**.



*If you are running some applications (for example a 3D application or video playback), you might see some disturbance, flickering, or frame dropping on your screen.*

*If that occurs, adjust the resolution of display, lowering it until the screen is displayed properly.*



---

# Chapter 5

## Utilities and Advanced Usage

This chapter describes the utilities and special features of this computer, and the advanced usage of some utilities.

### Utilities and Applications

This section describes the pre-installed utilities that come with the computer and details how to start them. For further information on their operation, refer to online manual, help files, or README.TXT file (if applicable) of each utility.



*You might not have all the software listed in this section depending on the model you purchased.*

### dynabook Settings

dynabook Settings is the configuration management tool available through the Windows operating system.

To run dynabook Settings, click **Start -> All apps -> dynabook Settings**.

This utility allows you to configure your computer settings by the following tabs:

- Home—Allows you to view the current BIOS/EC version or change certain settings back to their default values
- eco Utility—Allows you to manage the power consumption of your computer
- USB Charge—Allows you to manage USB Charge features
- Keyboard—Allows you to set options for the keyboard and set the brightness level of the keyboard backlight
- Boot Options—Allows you to manage boot settings
- System Password—Allows you to manage the User Password, Supervisor Password, Owner String and set the User policy
- Advanced Options—Allows you to set conditions for each device or function



*The settings or options explained here might vary depending on the model you purchased.*

---

## ***eco Utility***

This computer is equipped with "eco Mode". This mode slightly lowers performance of some devices to reduce electric power consumption. You can realize measurable power savings by using it continuously.

eco Utility helps control the power consumption of your computer. It also provides information that can help you understand your degree of contribution to the preservation of the environment.

The utility also supports "Battery Charge Mode". You can choose the charge mode that suits your computer usage.

In addition, this utility provides the Peak shift function that can help reduce power usage during periods of peak demand by shifting some power consumption to periods when demand is lower.

To access this utility, click **Start -> All apps -> dynabook Settings -> eco Utility**.

For details on eco Utility, click **Please click here for more information before you use eco Utility** in this tab to see the help file.

## ***USB Charging***

Your computer can supply USB bus power (DC 5V) to the USB port.

The port with the icon (  ) supports the following feature:

- Power Off and Charge
- System ON CDP Charge

### ***Power Off and Charge***

You can use the Power Off and Charge function to charge certain USB-compatible external devices such as mobile phones or portable digital music players. Your computer can supply USB bus power (DC 5V) to the compatible port even when the computer is powered off. "Power Off" includes Hibernation Mode or Shutdown state.

To set the Power Off and Charge feature, click **Start -> All apps -> dynabook Settings -> USB Charge**.

Move the slider to enable or disable the Power Off and Charge function.



- *The Power Off and Charge function might not work with certain external devices even if they are compliant with the USB specification. In those cases, turn the power of the computer ON to charge the device.*

- *When the Power Off and Charge function is enabled, USB bus power (DC 5V) is supplied to compatible ports even when the computer is powered OFF. USB bus power (DC 5V) is similarly supplied to the external devices which are connected to the compatible ports. However, some external devices cannot be charged solely by supplying USB bus power (DC 5V). As for the specifications of the external devices, contact the device manufacturer or check the specifications of the external devices thoroughly before use.*
- *Using the Power Off and Charge function to charge external devices takes longer than charging the devices with their own chargers.*
- *If the Power Off and Charge function is enabled, the computer's battery discharges during hibernation or when the computer is turned off. It is recommended that you connect the AC adaptor to the computer while using Power Off and Charge function.*
- *External devices connected to the USB bus power (DC 5V) function that interfaces with the power ON/OFF of the computer might always be in an operational state.*
- *When there is a current overflow of the external devices connected to the compatible ports, USB bus power (DC 5V) supply might be stopped for safety reasons.*
- *When the Power Off and Charge function is enabled, the USB Wake-up function might not work for compatible ports. In that case, if there is a USB port that does not have the Power Off and Charge function, attach the mouse or keyboard to it. If all USB ports have the Power Off and Charge function, change to disable Power Off and Charge function. The USB Wake-up function now works, but the Power Off and Charge function is disabled.*



*Metal paper clips or hair pins/clips can generate heat if they come into contact with USB ports. Do not allow USB ports to come into contact with metal products, for example when carrying the computer in your bag.*

Your PC has multiple charging modes so that many different USB devices can be supported for Power Off and Charge function.

**Auto Mode** (Default) is suitable for a wide range of digital audio players. While using **Auto Mode**, your computer can supply USB bus power at maximum 2.0A to the compatible ports while the computer is powered off. When USB device cannot be charged by **Auto Mode**, change to **Alternate Mode**.

This function might not be able to be used with some connected external devices even if the appropriate mode is selected. In this situation, disable and stop using this function.

Some external devices cannot use **Auto Mode**. As for the specifications of the external devices, contact the device's manufacturer or check the specifications of the external device thoroughly before use.

---

Always use the USB cable that was included with your USB device.

### Function under Battery Mode

This option can be used to enable/disable Power Off and Charge under battery mode. It also displays the remaining battery capacity.

Move the slider to enable or disable this function.

---

<b>Enabled</b>	Enables Power Off and Charge function under battery mode.
<b>Disabled</b>	Enables Power Off and Charge function only when the AC adaptor is connected.
<b>Disable features when the battery level reaches</b>	Specifies the lower limit of remaining battery life by moving the slider bar. If the remaining battery life falls below the setting, the Power Off and Charge function is stopped.  This setting is only available when the <b>Function under Battery Mode</b> is enabled.

---

### System ON CDP Charge

This function enables/disables CDP (Charging Downstream Port) to use rapid USB charge while the computer is powered on. When "System ON CDP Charge Mode" is enabled, your computer can supply USB bus power (DC 5V, 1.5A) to the compatible ports while the computer is turned on.

To set System ON CDP Charge Mode, click **Start -> All apps -> dynabook Settings -> USB Charge**.

---

<b>Enabled</b>	Rapid USB battery charge at maximum 1.5A while PC is powered On.
<b>Disabled</b>	Conventional USB battery charge while PC is powered On.

---



*The "System ON CDP Charge Mode" might not work with certain external devices even if they are compliant with the USB specifications. In those cases, use a USB port without "Power Off and Charge function" or disable "System ON CDP Charge Mode".*

*It is recommended that the AC adaptor be connected to the computer while supplying USB bus power (DC 5V, 1.5A).*

*When your computer battery capacity is too low to continue, "System ON CDP Charge Mode" might not work. In those cases, connect the AC adaptor and reboot the computer.*

*Always use the USB cable that was included with your USB device.*

*When "System ON CDP Charge Mode" or "Power Off and Charge function" is enabled, the "USB Wake-up" function might not work. In that case, use a*

---

*USB port without "Power Off and Charge function" or disable both "System ON CDP Charge Mode" and "Power Off and Charge function".*

## **System Password**

The System Password tab allows you to set a password in order to restrict access to the computer. Two levels of password security are provided: User and Supervisor.



*Passwords set by the System Password function are different from the Windows password.*

## **User Password**

To set a user password, click **Start -> All apps -> dynabook Settings -> System Password**.

User authentication may be required to validate user rights when using System Password to delete or change passwords.

### ■ **Set** (button)

Click this button to register a password. After a password is set, you are prompted to enter it when you start the computer.



- *After you set the password, a dialog box appears asking whether you want to save it to other media. If you forget the password, you can open the password file on another computer. Be sure to keep the media in a safe place.*
- *When entering the character string to register the password, enter from the keyboard character by character and do not enter as ASCII code or copy-and-paste the character string. In addition, ensure that the registered password is correct by outputting the character string to the password file.*
- *When entering a password, do not enter any non-alphanumeric characters (for example "!" or "#").*

### ■ **Delete** (button)

Click this button to delete a registered password. Before you can delete a password, you must first enter the current password correctly.

### ■ **Change** (button)

Click this button to change a registered password. Before you can change a password, you must first enter the current password correctly.

- **Owner String** (text box)

You can use this box to associate text with the password. After you enter text, click **Apply**. When the computer is started, this text is displayed together with the prompt asking you to enter a password.



*If you forget your HDD User Password, Dynabook will NOT be able to assist you, and your HDD will be rendered COMPLETELY and PERMANENTLY INOPERABLE. Dynabook will NOT be held responsible for any loss of any data, any loss of use or access to your HDD, or for any other losses to you or any other person or organization that result from the loss of access to your HDD. If you cannot accept this risk, do not register the HDD User Password.*

### ***Supervisor Password***

If you set a Supervisor Password, some functions might be restricted when a user logs on with the User Password. To set a Supervisor Password:

Click **Start -> All apps -> dynabook Settings -> System Password**. Then click the down arrow next to **Advanced options** to show the **Supervisor Password** settings.

This function lets you do the following:

- Register, change or delete the Supervisor Password
- Specify restrictions for general users

### ***Starting the computer using a password***

If you have already registered a user password, there is one way to start the computer:

- Enter the password manually.



*The password is necessary if the computer was shut down in Hibernation Mode or Boot Mode. It is not needed in Sleep Mode or Restart.*

To enter a password manually, do the following:

1. Turn on the power as described in the [Getting Started](#) section. The following dialog appears on the screen:

#### **Enter Password**



*At this point, the function keys do not work. They will function after you enter the password.*

2. Enter the Password.
3. Press **ENTER**.



*If you enter the password incorrectly three times in a row, or if you do not enter the password within 1 minute, the computer shuts down. In this case,*

---

*some features that can power on the computer automatically (Wake-up on LAN, Task Scheduler, etc.) might not work. You must turn the computer back on to retry password entry.*

### **Pre-Boot Authentication**

You can also enable/disable Pre-Boot Authentication function that allows you to authenticate by scanning fingerprints instead of inputting a password before Windows boots up, and Single Sign-On function that allows you to sign on using a fingerprint for both Pre-Boot Authentication and Windows operating system under **Pre-Boot Authentication** in **System Password**.

Please note that Pre-Boot Authentication and Single Sign-On function will be disabled if dynabook Settings is uninstalled.

## **dynabook Service Station**

dynabook Service Station allows your computer to automatically search for Dynabook software updates or other alerts from Dynabook that are specific to your computer system and its programs.

This utility also provides hardware diagnostic and troubleshooting function and service. The diagnostic or troubleshooting activity log is stored in your computer. When "Send diagnostic and troubleshooting data log" is enabled, the log will be sent to Dynabook periodically. The transmission is completely anonymous since no personal identifiable information is collected.

To access this utility, click **Start -> All apps -> dynabook Service Station**.

The following tabs might be provided:

- Home—Allows you to view current system power consumption and temperature of your computer.
- Software Updates—Allows you to check available software updates and perform necessary operations.
- Alerts—Allows you to check available alerts.
- Diagnostic Tools—Allows you to perform tests which will help check the performance of your computer.
- Troubleshooting—Allows you to solve many hardware issues of your computer by clicking listed items.
- Report—Allows you to check and print reports.
- System Information—Allows you to view basic information of your computer.
- Options—Allows you to set options for sending data logs.

## **dynabook Screen Rotation Utility**

dynabook Screen Rotation Utility rotates the screen orientation between landscape (normal) and landscape (flipped) by using the Ctrl + Alt + Up arrow/Down arrow keys.

---

To access this utility, click **Start -> All apps -> dynabook Screen Rotation Utility**.

The following options might be provided:

- Screen Rotation—Rotate the screen orientation by using the Ctrl + Alt + Up arrow/Down arrow keys.
- Confirmation message—Show a confirmation message when the screen is rotated.
- External display message—Show a message when the screen did not rotate because an external display is connected.

## **dynabook Online Meeting Assist**

dynabook Online Meeting Assist is a utility to control camera and audio effects during video conference sessions launched by online meeting applications.

Once started, this utility will use the front camera device. It is recommended to launch your online meeting application before starting this utility to avoid conflicts.

To access this utility, click **Start -> All apps -> dynabook Online Meeting Assist**.

The following tabs might be provided:

- Home—Allows you to view the utility version.
- Meeting Effects—Allows you to manage Meeting Camera Effect, Meeting Audio Effect and Hotkey configuration.



*Be aware of the following considerations when enabling the Meeting Camera Effect during video conferences:*

- *Camera effects require the attendee's face to be in focus. Camera effects may not work properly if the attendee is moving significantly, the camera is in a dark environment or the attendee's face cannot be clearly detected (e.g. wearing a face covering).*
- *Camera effects may not work properly if the attendee is at the edge of the camera preview window, too close to the camera lens or too far from of the camera lens.*
- *The Lighting Correction effect may not work properly if the attendee is in a non-HDR (High Dynamic Range) environment, where there is no obvious lighting difference between the ambient backlight and attendee face, or the face is already relatively bright enough.*
- *The Face Framing effect may not work properly until the Lighting Correction effect is enabled if the attendee is under a strong backlight environment and the face is relatively dim.*
- *Camera effects may not work properly if the camera is rotated. It is recommended to use Camera effects in landscape mode (non-flipped).*



- *To maintain a stable experience of the camera effects during video conferences, it is recommended you connect to a stable network, plug in the AC adaptor, close any other applications that are not in use and do not enable all camera effects at the same time to save CPU resource.*
- *Camera effects are intended for online meeting use. Please turn off the camera effects if they do not work as expected in other applications.*
- *Please turn off all camera effects before you uninstall the utility. The camera effects cannot be turned off without this utility.*

## dynabook Setup Utility

dynabook Setup Utility is a BIOS setup utility that provides you a menu-based user interface so that you can easily view and change BIOS settings.

To enter the dynabook Setup Utility, do the following:

1. Save your work.
2. Click **Start** ->  (**Power**) and then select **Restart**.
3. Hold down the **F2** key and then release this key just after the computer is powered on.
4. Follow the on-screen instructions to proceed.

To save the changes and exit the utility, press the **F10** key and proceed by selecting **Yes** or select **Exit** -> **Exit Saving Changes** -> **Yes**. The computer restarts immediately.



*When you choose **LCD + External Display** under **Power On Display** option in dynabook Setup Utility while two or more external display devices are connected to your computer, the operating system will select the internal LCD and one of the external display devices to be used when the computer is started.*

## dynabook Maintenance Utility

dynabook Maintenance Utility is provided to erase the internal storage drive. This utility allows you to delete all data and partitions and also overwrite all sectors on the internal storage drive.

If there is an external hard disk drive connected to your computer, it can also be erased. However, if you do not want to delete the data from the external hard disk drive, disconnect it from your computer.

To access this utility:

1. Click **Start** -> **Settings** -> **System** -> **Recovery**.
2. Click **Restart now** in **Advanced startup**.
3. Click **Troubleshoot** -> **dynabook Maintenance Utility**.

---

If you select the deletion method and continue with the operation, you will lose all data (including the operating system and recovery partition) on the internal storage drives. Make sure that you have already created recovery media if you want to use the computer after erasing your hard disk drive(s).

## Special features

The following features are either unique to Dynabook computers or are advanced features which make the computer more convenient to use.

Access each function using the following procedures.

\*1 To access the Power Options, click **Start -> All apps -> Windows Tools** and double-click **Control Panel**. In the Control Panel window, click **System and Security -> Power Options**.

---

<b>Display automatic power off</b> *1	This feature automatically cuts off power to the computer's display panel when there is no keyboard input for a specified time, with power being restored the next time a key is pressed. This can be specified in the Power Options.
<b>Internal storage drive automatic power off</b> *1	This feature automatically cuts off power to the internal storage drive when it is not accessed for a specified time, with power being restored when the internal storage drive is next accessed. This can be specified in the Power Options.
<b>System automatic Sleep/Hibernation Mode</b> *1	This feature automatically shuts down the system into either Sleep Mode or Hibernation Mode when there is no input or hardware access for a specified time. This can be specified in the Power Options.
<b>Power on password</b>	Two levels of password security, supervisor and user, are available to prevent unauthorized access to your computer.
<b>Intelligent power supply</b> *1	A microprocessor in the computer's intelligent power supply detects the battery charge, automatically calculates the remaining battery capacity, and protects electronic components from abnormal conditions such as a voltage overload from the AC adaptor. This can be specified in the Power Options.
<b>Battery save mode</b> *1	This feature lets you configure the computer in order to save battery power. This can be specified in the Power Options.

---

---

<b>Panel power on/off</b> *1	This feature automatically turns power to the computer off when the display panel is closed, and turns it back on when the display panel is opened. This can be specified in the Power Options.
<b>Low battery automatic Hibernation Mode</b> *1	When battery power is exhausted to the point that computer operation cannot be continued, the system automatically enters Hibernation Mode and shuts itself down. This can be specified in the Power Options.
<b>Hibernation Mode</b>	This feature lets you turn off the power to the computer without exiting from your software. The contents of main memory are automatically saved to the internal storage drive so that when you next turn on the power again, you can continue working right where you left off. You must enable the Hibernation Mode before using this feature. Refer to the <a href="#">Starting Hibernation Mode</a> section for more details.
<b>USB Wake-up function</b>	<p>This function restores the computer from Sleep Mode depending on the external devices connected to the USB ports.</p> <p>For example, if a mouse or USB keyboard is connected to a USB port, clicking the mouse button or pressing the keyboard will wake up the computer.</p>
<b>Heat dispersal</b> *1	<p>To protect against overheating, the processor is equipped with an internal temperature sensor which activates a cooling fan or lowers the processing speed if the computer's internal temperature rises to a certain level. You are able to select whether to control this temperature by either turning on the fan first, then if necessary lowering the processor speed, or by lowering the processor speed first, then if necessary turning on the fan. Both of these functions are controlled through the Power Options.</p> <p>When the processor's temperature falls within normal range, the fan and the processor operation return to their standard speed.</p> <p>If the processor's temperature reaches an unacceptably high level with either setting, the computer automatically shuts down to prevent any damage. In this instance, all unsaved data in memory will be lost.</p>

---

---

# Chapter 6

## Troubleshooting

Dynabook has designed this computer for durability, however, should problems occur, you are able to use the procedures detailed in this chapter to help determine the cause.

You should become familiar with this chapter as knowing what might go wrong can help prevent problems from occurring in the first place.

### Problem-solving process

If you observe the following guidelines, resolving problems will be much easier.

- Stop immediately when you recognize a problem exists as taking further action might result in data loss or damage, or you might destroy valuable problem-related information that can help solve the problem.
- Observe what is happening. Write down what the system is doing and what actions you performed immediately before the problem occurred. Make a screenshot of the current display.

Also be aware that the questions and procedures described in this chapter are meant only as a guide, they are not definitive problem-solving techniques. In reality many problems can be solved simply, but a few might require help from Technical Support. If you find you need to consult others, be prepared to describe the problem in as much detail as possible.

### Preliminary checklist

You should always consider the simplest solution first. The items detailed in this checklist are easy to fix and yet can cause what appears to be a serious problem:

- Make sure that you turn on all peripheral devices before you turn on the computer - this includes your printer and any other external device you are using.
- Before you attach an external device, you should first turn off the computer, then when you turn the computer back on, it recognizes the new device.
- Make sure that all optional accessories are configured properly in the computer's setup program and that all required driver software has been loaded (refer to the documentation included with the optional accessories for further information on its installation and configuration).

- 
- Check all cables to ensure that they are correctly and firmly attached to the computer - loose cables can cause signal errors.
  - Inspect all connecting cables for loose wires and all connectors for loose pins.
  - Check that your disc media is correctly loaded.

Always try to make detailed notes of your observations and keep them in a permanent error log - this helps you to describe your problems to Technical Support. In addition, if a problem recurs, the log you have made helps to identify the problem faster.

## Analyzing the problem

Sometimes the computer gives you clues that can help you identify why it is malfunctioning. In view of this, keep the following questions in mind:

- Which part of the computer is not operating properly - keyboard, HDD/SSD, display panel, Touch Pad, Touch Pad control buttons - as each device produces different symptoms.
- Check the options within the operating system to ensure that its configuration is set properly.
- What appears on the display? Does it display any messages or random characters? Make a screenshot of the current display and, if possible, look up the messages in the documentation included with the computer, software, or operating system.
- Check that all connecting cables are correctly and firmly attached as loose cables can cause erroneous or intermittent signals.
- Do any indicators light, if so, which ones, what color are they and do they stay on or blink? Write down what you see.
- Do you hear any beeps, if so, how many, are they long or short and are they high pitched or low pitched? In addition, is the computer making any unusual noises? Write down what you hear.

Record your observations so you can describe them in detail to Technical Support.

---

### Software

The problems might be caused by your software or disk. If you cannot load a software package, the media might be damaged or the program might be corrupted. In these instances, try loading another copy of the software if possible.

If an error message appears while you are using a software package, you should refer to the documentation supplied with it as this usually includes a problem-solving section or a summary of error messages.

Next, check any error messages against the operating system documentation.

---

---

## Hardware

If you cannot find a software problem, you should then check the setup and configuration of your hardware. First run through the items in the preliminary checklist as described previously, then, if you still cannot correct the problem, try to identify the source. The next section provides checklists for individual components and peripherals.



*Before using a peripheral device or application software that is not an authorized part or product, make sure that the device or software can be used with your computer. Use of incompatible devices might cause injury or might damage your computer.*

## If something goes wrong

### ***Your computer does not respond to the keyboard commands***

If an error occurs and the computer does not respond to your keyboard commands, do the following:

Press the power button and hold it down for five seconds. Once the computer has turned itself off, wait 10-15 seconds before turning on the power again by pressing the power button.

### ***Your program stops responding***

If you are working with a program that suddenly freezes all operations, chances are the program has stopped responding. You can exit the failed program without shutting down the operating system or closing other programs.

To close a program that has stopped responding:

1. Press **CTRL**, **ALT**, and **DEL** simultaneously (once), then click **Task Manager**. The Windows Task Manager window appears.
2. Select the program you want to close, then click **End Task**. Closing the failed program should allow you to continue working. If it does not, continue with the next step.
3. Close the remaining programs one by one by selecting the program name, then **End Task**. Closing all programs should allow you to continue working. If it does not, power off your computer and then restart it.

### ***The computer does not start***

Make sure that you attached the AC adaptor and power cord/cable properly.

If you are using the AC adaptor, check that the wall outlet is working by plugging in another device, such as a lamp.

---

Verify that the computer is on by looking at the **Power** indicator.

If the indicator is glowing, the computer is on. Also, try turning the computer off and then on.

If you are using an AC adaptor, verify that the computer is receiving power from the external power source by looking at the **DC IN/Battery** indicator. If the indicator is glowing, the computer is connected to a live external power source.

### ***The computer does not load advanced options during startup***

By holding down one of the following keys during startup, your computer can load the following advanced options:

<b>Key</b>	<b>Advanced option</b>
F2	dynabook Setup Utility
F12	Boot Menu
0 (zero)	Recovery options

If your computer starts to load the Operating System instead of desired advanced options, do the following:

1. Click **Start** ->  (**Power**) and then select **Restart**.
2. Hold down the corresponding key and then release this key just after the computer is powered on.
3. Follow the on-screen instructions to proceed.

## **Hardware and system checklist**

This section discusses problems caused by your computer's hardware or attached peripherals. Basic problems might occur in the following areas:

- Power
- Keyboard
- Internal display panel
- Internal storage
- Memory media card
- Pointing device
- Fingerprint sensor
- USB device
- Sound system
- External monitor
- LAN
- Wireless LAN
- Bluetooth®
- Face recognition sensor

### **Power**

When the computer is not plugged into an AC power outlet, the battery pack is the primary power source. Your computer also has Real-Time Clock (RTC) function. All of the power resources are interrelated with anyone having the ability to produce apparent power problems.

---

### **Overheating power down**

If the processor's temperature reaches an unacceptably high level with either setting, the computer automatically shuts down to prevent any damage. In this instance, all unsaved data in memory is lost.

<b>Problem</b>	<b>Procedure</b>
Computer shuts down automatically	Leave the computer off until it reaches room temperature. If the computer has reached room temperature and it still does not start, or if it starts but shuts down quickly, contact Technical Support.

### **AC power**

If you have trouble turning on the computer with the AC adaptor connected, check the status of the DC IN/Battery indicator. Refer to the [Power Condition Descriptions](#) section for further information.

<b>Problem</b>	<b>Procedure</b>
AC adaptor does not power the computer	<p>Check the connections to make sure that the power cord/adaptor is firmly connected to the computer and a working power outlet.</p> <p>Check the condition of the cord and terminals. If the cord is frayed or damaged, it should be replaced, while if the terminals are soiled, they should be cleaned with a clean cotton cloth.</p> <p>If the AC adaptor still does not power the computer, you should contact Technical Support.</p>

### **Battery**

If you suspect a problem with the battery, check the status of the **DC IN/Battery** indicator.

<b>Problem</b>	<b>Procedure</b>
Battery does not power the computer	The battery might be discharged. Connect the AC adaptor to recharge the battery.
Battery does not charge when the AC adaptor is attached	If the battery is completely discharged, it will not begin charging immediately. In these instances, wait a few minutes before trying again. If the battery still does not charge, check that the power outlet of the AC adaptor is connected to its supplying power. This can be tested by plugging another appliance into it.



---

<b>Problem</b>	<b>Procedure</b>
Battery does not power the computer as long as expected	If you frequently recharge a partially charged battery, the battery might not charge to its full potential. In these instances, you should fully discharge the battery and then attempt to charge it again.

---

### ***Real-Time Clock***

<b>Problem</b>	<b>Procedure</b>
BIOS setting and system date/time are lost	<p>The lasting time of the Real-Time Clock (RTC) has run out. You must set the date and time in the dynabook Setup Utility by using the following steps:</p> <ol style="list-style-type: none"><li>1. Launch the dynabook Setup Utility. Refer to the <a href="#">dynabook Setup Utility</a> section for further information.</li><li>2. Set the date in the <b>System Date</b> field.</li><li>3. Set the time in the <b>System Time</b> field.</li><li>4. Follow the on-screen instructions to proceed.</li></ol>

---

### ***BIOS***

<b>Problem</b>	<b>Procedure</b>
Computer cannot be powered on	<p>Disconnect the AC adaptor for several seconds and then reconnect the AC adaptor. After that, press the power button.</p> <p>If it does not work, press the power button twice again.</p> <p>If it still does not work, press and hold the power button for 18 seconds.</p> <p>Real-Time Clock (RTC) information might be cleared if the power is turned on by pressing the power button. You should set the system date/time manually in dynabook Setup Utility.</p> <p>If it still does not operate properly, you should contact your reseller or dealer.</p>

---

## **Keyboard**

Keyboard problems can be caused by the setup and configuration of the computer. Refer to the [The Keyboard](#) section for further information.

---

Problem	Procedure
Output to screen is garbled	Refer to your software documentation to ensure that it is not remapping the keyboard in any way (remapping involves changing or reassigning the function of each key).  If you are still unable to use the keyboard, you should contact Technical Support.

---

## Internal display panel

Apparent problems of the computer's display panel might be related to setup and configuration of the computer.

Problem	Procedure
No display	Press the function keys to adjust the display priority, and to make sure that it is not set for output to an external monitor.
Markings appear on the computer's display panel	These marks might have come from contact with the keyboard and Touch Pad while the display panel has been closed. Try to remove the marks by gently wiping the display panel with a clean dry cloth or, if this fails, with a good quality LCD screen cleaner. In this latter instance, you should always follow the instructions with the screen cleaner and always ensure that you let the display panel dry properly before closing it.

---

## Internal Storage Drive

Problem	Procedure
Computer does not boot from internal storage	Check to see whether there is a disc in the external optical disc drive - if so remove it and try to start the computer again.  If this has no effect, check the <b>Boot Priority Options</b> setting under <b>Boot</b> within the dynabook Setup Utility.

---

Problem	Procedure
Slow performance	<p>The files on the internal storage drive might be fragmented. In this instance you should run the disk defragmentation utility to check the condition of your files and the internal storage drive. Refer to the operating system's documentation or online help file for further information on operating and using the defragmentation utility.</p> <p>As a last resort, you should reformat the internal storage drive and then reload the operating system and all other files and data. If you are still unable to resolve the problem, contact Technical Support.</p>

## Memory Media Card

For further information, refer to [Operating Basics](#).

Problem	Procedure
Memory media card error occurs	<p>Remove the memory media card from the computer and then reinsert it to ensure that it is firmly connected.</p> <p>If the problem persists, then you should refer to the documentation supplied with your memory media card for further information.</p>
You cannot read a file	<p>Check to ensure that the required file is actually on the memory media card that is inserted into the computer.</p> <p>If you are still unable to resolve the problem, contact Technical Support.</p>

## Pointing device

If you are using a USB mouse, you should also refer to both the [USB mouse](#) section and the documentation supplied with your mouse.

### ***Touch Pad***

Problem	Procedure
Touch Pad does not work	<p>Check the device settings.</p> <p>Click <b>Start -&gt; Settings -&gt; Bluetooth &amp; devices -&gt; Touchpad</b>.</p>

<b>Problem</b>	<b>Procedure</b>
Mouse pointer does not respond to pointing device operation	In this instance, the system might be busy. Try moving the mouse again after waiting a short while.
Double-tapping (Touch Pad) does not work	<p>In this instance, you should initially try changing the double-click speed setting within the Mouse Control utility.</p> <ol style="list-style-type: none"> <li>1. To access this utility, click <b>Start -&gt; Settings -&gt; Bluetooth &amp; devices -&gt; Touchpad -&gt; More touchpad settings</b>.</li> <li>2. Within the Mouse Properties window, click the <b>Buttons</b> tab.</li> <li>3. Set the double-click speed as required and click <b>OK</b>.</li> </ol>
Mouse pointer moves too fast or too slow	<p>In this instance, you should initially try changing the cursor speed within the Touch Pad settings.</p> <p>To access it, click <b>Start -&gt; Settings -&gt; Bluetooth &amp; devices -&gt; Touchpad</b>.</p>
Reaction of Touch Pad is either too sensitive or not sensitive enough	<p>Adjust the touch sensitivity.</p> <p>To access it, click <b>Start -&gt; Settings -&gt; Bluetooth &amp; devices -&gt; Touchpad</b>.</p> <p>If you are still unable to resolve the problem, contact Technical Support.</p>

### ***USB mouse***

<b>Problem</b>	<b>Procedure</b>
Mouse pointer does not respond to mouse operation	<p>In this instance, the system might be busy. Try moving the mouse again after waiting a short while.</p> <p>Remove the mouse from the computer and then reconnect it to a free USB port in order to ensure that it is firmly attached.</p>

---

Problem	Procedure
Double-clicking does not work	<p data-bbox="496 124 1044 212">In this instance, you should initially try changing the double-click speed setting within the Mouse Control utility.</p> <ol data-bbox="496 220 1044 432" style="list-style-type: none"><li data-bbox="496 220 1044 308">1. To access this utility, click <b>Start -&gt; Settings -&gt; Bluetooth &amp; devices -&gt; Touchpad -&gt; More touchpad settings.</b></li><li data-bbox="496 316 1044 371">2. Within the Mouse Properties window, click the <b>Buttons</b> tab.</li><li data-bbox="496 379 1044 432">3. Set the double-click speed as required and click <b>OK.</b></li></ol>
Mouse pointer moves too fast or too slow	<p data-bbox="496 448 1044 504">In this instance, you should initially try changing the speed setting within the Mouse Control utility.</p> <ol data-bbox="496 512 1044 727" style="list-style-type: none"><li data-bbox="496 512 1044 600">1. To access this utility, click <b>Start -&gt; Settings -&gt; Bluetooth &amp; devices -&gt; Touchpad -&gt; More touchpad settings.</b></li><li data-bbox="496 608 1044 663">2. Within the Mouse Properties window, click the <b>Pointer Options</b> tab.</li><li data-bbox="496 671 1044 727">3. Set the mouse pointer speed as required and click <b>OK.</b></li></ol>
Mouse pointer moves erratically	<p data-bbox="496 743 1044 855">The elements of the mouse responsible for detecting movement might be dirty. Refer to the documentation supplied with the mouse for instructions on how to clean it.</p> <p data-bbox="496 863 1044 932">If you are still unable to resolve the problem, contact Technical Support.</p>

---

---

## Fingerprint sensor

Problem	Procedure
Fingerprints cannot be registered or deleted	<ol style="list-style-type: none"><li>1. Save your work.</li><li>2. Click <b>Start</b> -&gt;  (<b>Power</b>) and then select <b>Restart</b>.</li><li>3. Hold down the <b>F2</b> key and then release this key just after the computer is powered on to show the dynabook Setup Utility.</li><li>4. Select <b>Security</b> -&gt; <b>BIOS Password</b> -&gt; <b>Supervisor</b>, and then register the Supervisor Password. (If the User Password has been registered, clear it first.)</li><li>5. Select <b>Clear Fingerprint data</b>, and then press <b>Yes</b>.</li><li>6. Clear Supervisor Password. (If necessary, register the User Password again after that.)</li><li>7. To save the changes and exit the utility, press the <b>F10</b> key and proceed by selecting <b>Yes</b> or select <b>Exit</b> -&gt; <b>Exit Saving Changes</b> -&gt; <b>Yes</b>.</li></ol> <p>The computer restarts immediately.</p>

---

## USB device

In addition to the information in this section, also refer to the documentation supplied with your USB device.

Problem	Procedure
USB device does not work	<p>Remove the USB device from the computer and then reconnect it to a free port in order to ensure that it is firmly attached.</p> <p>Ensure that any required USB device drivers are properly installed. To achieve this, you should refer to both the device documentation and the operating system documentation.</p>

---

### ***Power Off and Charge function***

For more information and settings, refer to the [USB Charging](#) section.

Problem	Procedure
<p>Power Off and Charge function cannot be used</p>	<p>Power Off and Charge function might be disabled. Enable the <b>Power Off and Charge</b> function under <b>USB Charge</b> within the dynabook Settings.</p> <p>When there is a current overflow of the external device connected to the compatible port, USB power (DC 5V) supply might be stopped for safety reasons. When this happens, disconnect an external device if some external devices are connected. After that, turn the power of the computer ON/OFF to restore the function. If this function can still not be used even if only one external device is connected, stop using the external device because its current is over the acceptable value of this computer.</p> <p>Some external devices might not be able to use the Power Off and Charge function. In this case, please try one or more of the following methods:</p> <ul style="list-style-type: none"> <li>■ Turn OFF the computer while external devices are connected.</li> <li>■ Connect external devices after turning OFF of the computer.</li> </ul> <p>If this function can still not be used, change the setting to disable the function and stop using this function.</p>
<p>Battery depletes quickly even when power of the computer is turned off</p>	<p>If Power Off and Charge function is enabled, the computer's battery discharges during hibernation or when the computer is turned off.</p> <p>Connect the AC adaptor to the computer or disable the Power Off and Charge function.</p>
<p>External devices connected to the compatible ports do not work when connected to a compatible port</p>	<p>Some external devices might not work when connected to a compatible port if the Power Off and Charge function is enabled.</p> <p>Reconnect the external device after turning the computer ON.</p> <p>If the external device still does not work, connect the device to a USB port that does not have the Power Off and Charge function or change to disable the Power Off and Charge function.</p>

---

Problem	Procedure
"USB Wake-up function" does not work	<p>When "System ON CDP Charge Mode" or "Power Off and Charge function" is enabled, the "USB Wake-up" function does not work for ports that support the Power Off and Charge function.</p> <p>In that case, use a USB port that does not have the Power Off and Charge function or change to disable both "System ON CDP Charge Mode" and "Power Off and Charge function".</p>

---

## Sound system

In addition to the information in this section, also refer to the documentation supplied with your audio device.

Problem	Procedure
No sound is heard	<p>Press the function keys to increase or decrease volume.</p> <p>Check the software volume settings.</p> <p>Check to see if Mute is turned to Off.</p> <p>Check to make sure that the headphone connection is secure.</p> <p>Check within the Windows Device Manager application to ensure that the sound device is enabled and that the device is properly working.</p>
Annoying sound is heard	<p>In this instance, you might be experiencing feedback from either the internal microphone or an external microphone connected to the computer. Refer to <a href="#">Sound System and Video mode</a> for further information.</p> <p>Volume cannot be adjusted during Windows start up or shut down.</p> <p>If you are still unable to resolve the problem, contact Technical Support.</p>

---

## External monitor

Also refer to [Operating Basics](#), and to the documentation supplied with your monitor for further information.



Problem	Procedure
Monitor does not turn on	After confirming that the monitor's power switch is on, check the connections to make sure that the power cord/adaptor is firmly connected to the monitor and to a working power outlet.
No display	<p>Try adjusting the contrast and brightness controls on the external monitor.</p> <p>Press the function key in order to change the display priority and ensure that it is not set for the internal display only.</p> <p>Check to see if the external monitor is connected.</p> <p>When the external monitor is set as the primary display device in extended desktop mode, it does not display when the computer wakes up from Sleep Mode if the external monitor has been disconnected while in Sleep Mode.</p> <p>To keep this from happening, do not disconnect the external monitor while the computer is in Sleep or Hibernation Mode.</p> <p>Remember to turn off the computer before disconnecting the external monitor.</p> <p>When the display panel and an external monitor are set to Clone Mode and they are turned off by the timer, the display panel or the external monitor might not display when turned on again.</p> <p>If this occurs, press the function key to reset the display panel and external monitor to Clone Mode.</p> <p>When booting up the computer, screen of BIOS setting etc. might not be indicated correctly if the power saving function of the external monitor is enabled. In this case, turn the power of the external monitor OFF and ON once (to disable power saving function) and then restart your computer.</p>
Display error occurs	<p>Check that the cable connecting the external monitor to the computer is firmly attached.</p> <p>If you are still unable to resolve the problem, contact Technical Support.</p>

---

## LAN

Problem	Procedure
Cannot access LAN	Check for a firm cable connection between the LAN jack and the LAN hub.
Wake-up on LAN does not work	Make sure the AC adaptor is connected. The Wake-up on LAN function consumes power even when the system is off.  If problems persist, consult your LAN administrator.

## Wireless LAN

Problem	Procedure
Cannot access Wireless LAN	Make sure that the wireless communication function of the computer is on.  If problems persist, contact your LAN administrator.

## Bluetooth®

Problem	Procedure
Cannot access Bluetooth® device	Check to ensure that the wireless communication function of the computer is on.  Check to ensure that power to the external Bluetooth® device is turned on.  Check to ensure that no optional Bluetooth® Adaptor is installed in the computer. The built-in Bluetooth® hardware cannot operate simultaneously with another Bluetooth® controller.  If you are still unable to resolve the problem, contact Technical Support.

## Face recognition sensor

Problem	Procedure
Cannot sign in to Windows by Face recognition	Sign in to Windows by PIN, etc.

---

## Technical support

If you require any additional help using your computer or if you are having problems operating the computer, you might need to contact us for additional technical assistance.

### Before you call

Some problems you experience might be related to software or the operating system, so it is important that you investigate other sources of assistance first. Before contacting, try the following:

- Review troubleshooting sections in the documentation supplied with your software and/or peripheral devices.
- If a problem occurs when you are running software applications, consult the software documentation for troubleshooting suggestions and consider calling the software company's technical support department for assistance.
- Consult the reseller or dealer from where you purchased your computer and/or software - they are your best resource for current information and support.

### Technical support

If you are still unable to solve the problem and suspect that it is hardware related, read the enclosed warranty booklet or visit the technical support website <http://emea.dynabook.com/support-country-selector> .

---

# Chapter 7

## Appendix

### Specifications

This section summarizes the technical specifications of the computer.

#### Physical Dimensions

The physical dimensions vary depending on the model you purchased.

<b>Size</b>	<ul style="list-style-type: none"><li>■ Approximately 323.6 (w) x 220.6 (d) x 17.9 (h) millimeters</li><li>■ Approximately 323.6 (w) x 220.6 (d) x 18.9 (h) millimeters</li><li>■ Approximately 323.6 (w) x 220.6 (d) x 19.9 (h) millimeters</li><li>■ Approximately 358.2 (w) x 236.9 (d) x 19.9 (h) millimeters</li></ul>
-------------	---

(not including parts that extend beyond the main body)

#### Environmental Requirements

Conditions	Ambient temperature	Relative humidity
<b>Operating</b>	5°C (41°F) to 35°C (95°F)	20% to 80% (noncondensing)
<b>Non-operating</b>	-20°C (-4°F) to 60°C (140°F)	10% to 90% (noncondensing)
<b>Wet-bulb temperature</b>	29°C maximum	

Conditions	Altitude (from sea level)
<b>Operating</b>	-60 to 3,000 meters
<b>Non-operating</b>	-60 to 10,000 meters maximum

---

## Power Requirements

<b>AC adaptor</b>	100-240V AC 50 Hz or 60 Hz (cycles per second)
<b>Computer</b>	5-20V DC

## AC Power Cord and Connectors

The AC input plug of the power cord must be compatible with the various international AC power outlets and the cord must meet the standards for the country/region in which it is used. All cords must meet the following specifications:

<b>Wire size:</b>	Minimum 0.75 mm <sup>2</sup>
<b>Current rating:</b>	Minimum 2.5 amperes

## Certification agencies

<b>China:</b>	CQC		
<b>U.S. and Canada:</b>	UL listed and CSA certified No. 18 AWG, Type SVT or SPT-2		
<b>Australia:</b>	AS		
<b>Japan:</b>	DENANHO		
<b>Europe:</b>			
<b>Austria:</b>	OVE	<b>Italy:</b>	IMQ
<b>Belgium:</b>	CEBEC	<b>The Netherlands:</b>	KEMA
<b>Denmark:</b>	DEMKO	<b>Norway:</b>	NEMKO
<b>Finland:</b>	FIMKO	<b>Sweden:</b>	SEMKO
<b>France:</b>	LCIE	<b>Switzerland:</b>	SEV
<b>Germany:</b>	VDE	<b>United Kingdom:</b>	BSI

In Europe, two conductors power cord must be VDE type, H05VVH2-F or H03VVH2-F and for three conductors power cord must be VDE type, H05VV-F.

For the United States and Canada, two-pin plug configuration must be 2-15P (250 V) or 1-15P (125 V) and three-pin plug configuration must be 6-15P (250 V) or 5-15P (125 V) as designated in the U.S. National Electrical Code Handbook and the Canadian Electrical Code Part II.

The following illustrations show the plug shapes for the U.S.A. and Canada, the United Kingdom, Australia, Europe, Middle-East, Africa, South Africa, Switzerland, Italy and China.

**USA**

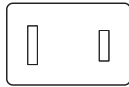

UL approved

**Australia**

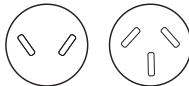

AS approved

**Canada**

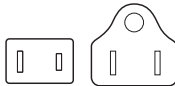

CSA approved

**State of Israel**



SII approved

**Switzerland**



Approved by the appropriate agency

**United Kingdom, South Africa, Middle-East**

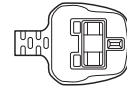

BS approved

**Europe, Africa, South Africa, Middle-East**

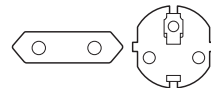

Approved by the appropriate agency

**China**



CCC approved

**Africa**



Approved by the appropriate agency

**Italy**



Approved by the appropriate agency

---

# Information for Wireless Devices

## Wireless Technology Interoperability

The Wireless LAN is compatible with other LAN systems with Direct Sequence Spread Spectrum (DSSS) /Orthogonal Frequency Division Multiplexing (OFDM) radio technology, and is compliant to:

- The IEEE 802.11 Standard on Wireless LANs (Revision a/b/g/n/ac/ax), as defined and approved by the Institute of Electrical and Electronics Engineers.

Bluetooth® Modules are designed to be interoperable with any product with Bluetooth® wireless technology that is based on Frequency Hopping Spread Spectrum (FHSS) radio technology, and is compliant to:

- Bluetooth® Specification (depending on the model you purchased), as defined and approved by the Bluetooth® Special Interest Group.
- Logo certification with Bluetooth® wireless technology as defined by the Bluetooth® Special Interest Group.

This Bluetooth® product is not compatible with devices using Bluetooth® Version 1.0B specifications.



*The wireless devices have not completed verification of connection and operation with all devices which are using the Wireless LAN or Bluetooth® radio technology.*

*Bluetooth® and Wireless LAN devices operate within the same radio frequency range and might interfere with one another. If you use Bluetooth® and Wireless LAN devices simultaneously, you might occasionally experience a less than optimal network performance or even lose your network connection.*

*If you experience any such problem, immediately turn off either one of your Bluetooth® or Wireless LAN.*

## Wireless devices and your health

Wireless products, like other radio devices, emit radio frequency electromagnetic energy. The level of energy emitted by wireless products however is far much less than the electromagnetic energy emitted by wireless devices like for example mobile phones.

Because wireless products operate within the guidelines found in radio frequency safety standards and recommendations, Dynabook believes wireless products are safe for use by consumers. These standards and recommendations reflect the consensus of the scientific community and result from deliberations of panels and committees of scientists who continually review and interpret the extensive research literature.

---

In some situations or environments, the use of wireless products might be restricted by the proprietor of the building or responsible representatives of the organization. These situations might for example include:

- Using the wireless products equipment on board of airplanes, or
- In any other environment where the risk of interference to other devices or services is perceived or identified as harmful.

If you are uncertain of the policy that applies to the use of wireless devices in a specific organization or environment (for example, airports), you are encouraged to ask for authorization to use the wireless device prior to turning on the equipment.

## Wireless LAN Technology

The wireless communication function of the computer supports some wireless communication devices.

Only some models are equipped with both Wireless LAN and Bluetooth® functions.



- *Do not use the Wireless LAN (Wi-Fi®) or Bluetooth® functionalities near a microwave oven or in areas subject to radio interference or magnetic fields. Interference from a microwave oven or other source can disrupt Wi-Fi® or Bluetooth® operation.*
- *Turn off all wireless functionalities when near a person who might have a cardiac pacemaker implant or other medical electric device. Radio waves might affect pacemaker or medical device operation, possibly resulting in serious injury. Follow the instruction for your medical device when using any wireless functionality.*
- *Always turn off wireless functionality if the computer is near automatic control equipment or appliances such as automatic doors or fire detectors. Radio waves can cause malfunction of such equipment, possibly resulting in serious injury.*
- *It might not be possible to make a network connection to a specified network name using the ad hoc network function. If this occurs, the new network (\*) has to be configured for all computers connected to the same network in order to re-enable network connections.  
\* Make sure to use new network name.*

## Security

- Dynabook strongly recommends that you enable encryption functionality, otherwise your computer is open to illegal access by an outsider using a wireless connection. If this occurs, the outsider might illegally access your system, eavesdrop, or cause the loss or destruction of stored data.
- Dynabook is not liable for the loss of data due to eavesdropping or illegal access through the wireless LAN and the damage thereof.



---

## ***Card Specifications***

<b>Compatibility</b>	■	IEEE 802.11 Standard for Wireless LANs
<b>Network Operating System</b>	■	Microsoft Windows Networking
<b>Media Access Protocol</b>	■	CSMA/CA (Collision Avoidance) with Acknowledgment (ACK)

## ***Radio Characteristics***

Radio Characteristics of Wireless LAN module might vary according to:

- Country/region where the product was purchased
- Type of product

Wireless communication is often subject to local radio regulations. Although Wireless LAN networking products have been designed for operation in the license-free 2.4 GHz, 5 GHz and 6 GHz band, local radio regulations might impose a number of limitations to the use of wireless communication equipment.

<b>Radio Frequency</b>	■	Band 2.4 GHz (2400-2483.5 MHz) (Revision b/g, n and ax)
	■	Band 5 GHz (5150-5850 MHz) (Revision a, n, ac and ax)
	■	Band 6 GHz (may not be available in your country/region)

The range of the wireless signal is related to the transmit rate of the wireless communication. Communications at lower transmit range might travel larger distances.

- The range of your wireless devices can be affected when the antennas are placed near metal surfaces and solid high-density materials.
- Range is also impacted due to "obstacles" in the signal path of the radio that might either absorb or reflect the radio signal.

## ***Radio Frequency Interference Requirements***

This device is restricted to indoor use due to its operation in the 5.15 to 5.25 GHz frequency range.

High-power radars are allocated as primary users (i.e. priority users) of the bands 5.25 to 5.35 GHz and 5.65 to 5.85 GHz and these radars could cause interference and/or damage to LE-LAN devices.

## **Bluetooth® wireless technology**

Some computers in this series have Bluetooth® wireless communication function which eliminates the need for cables between electronic devices such as computers, printers, and mobile phones. When it is enabled,

---

Bluetooth® provides a safe and trustworthy wireless personal area network environment that is quick and easy.

You cannot use the built-in Bluetooth® functions of the computer and an external Bluetooth® adaptor simultaneously. For reference, Bluetooth® wireless technology has the following features:

### ***Security***

Two advanced security mechanisms ensure a high level of security:

- Authentication prevents access to critical data and makes it impossible to falsify the origin of a message.
- Encryption prevents eavesdropping and maintains link privacy.

### ***Worldwide operation***

The Bluetooth® radio transmitter and receiver operate in the 2.4 GHz band, which is license-free and compatible with radio systems in most countries in the world.

### ***Radio links***

You can easily establish links between two or more devices, with these links being maintained even if the devices are not within a line-of-sight of each other.

## **Radio Regulatory Information**

The Wireless device must be installed and used in strict accordance with the manufacturer's instructions as described in the user documentation that comes with the product. This product complies with the following radio frequency and safety standards.

The wireless modules listed here are applicable for your products at the time of this manual's production. However, succeeding products are subject to change without notice.

### ***Europe***

#### ***Restrictions for Use of 2400.0 - 2483.5 MHz Frequencies in Europe***

<b>Azerbaijan:</b>	Limited implementation	No license needed if used indoor and power not exceeding 30 mW (14.77 dBm).
<b>Italy:</b>	Implemented	The public use is subject to general authorisation by the respective service provider.

---

**Russian  
Federation:**

Limited  
implementation

Using SRD (Short Range Device) with  
FHSS (Frequency-Hopping Spread  
Spectrum) modulation.

1. Maximum 2.5 mW (4 dBm) EIRP (Equivalent Isotropically Radiated Power) is permitted to use.
2. Maximum 100 mW (20 dBm) EIRP is permitted to use with the following conditions:

Permitted to use SRD for outdoor applications without restriction on installation height only for purposes of gathering telemetry information for automated monitoring and resources accounting systems. Permitted to use SRD for other purposes for outdoor applications only when the installation height is not exceeding 10 m above the ground surface.

3. Maximum 100 mW (20 dBm) EIRP.

Indoor applications are permitted to use.

---

Using SRD with DSSS (Direct Sequence Spread Spectrum) and other than FHSS wideband modulation.

1. Maximum EIRP density is 2 mW/MHz. Maximum 100 mW (20 dBm) EIRP is permitted to use.
2. Maximum EIRP density is 20 mW/MHz. Maximum 100 mW (20 dBm) EIRP is permitted to use with the following condition:

It is permitted to use SRD for outdoor applications only for purposes of gathering telemetry information for automated monitoring and resources accounting systems or security systems.

3. Maximum EIRP density is 10 mW/MHz. Maximum 100 mW (20 dBm) EIRP.

Indoor applications are permitted to use.

---

<b>Ukraine:</b>	Limited implementation	EIRP =100 mW (20 dBm) with built-in antenna's maximum gain is 6 dBi.
-----------------	------------------------	--

---

---

**Restrictions for Use of 5150 - 5350 MHz Frequencies in Europe**

<b>Austria, Belgium, Bulgaria, Croatia, Cyprus, Czech Republic, Denmark, Estonia, Finland, France, Germany, Great Britain and Northern Ireland, Greece, Hungary, Ireland, Italy, Latvia, Lithuania, Luxembourg, Malta, Netherlands, Poland, Portugal, Romania, Slovakia, Slovenia, Spain, Sweden</b>	Limited implementation	This product is for indoor use only.
--	---------------------------	--------------------------------------

---

**Restrictions for Use of 5725 - 5875 MHz Frequencies in Europe**

<b>Russian Federation:</b>	Limited implementation	When duty cycle is 0.1% or using LBT (Listen Before Talk) technology. Antenna height should not exceed 5 m, with maximum EIRP 25 mW (13.98 dBm) is permitted to use.
--------------------------------	---------------------------	---

---

**Software Version and Maximum Power Output of the Wireless  
Module**

Europe: model AX211NGW

<b>Software Version</b>	Intel® PROSet/Wireless WiFi Software 22.x and following versions
-------------------------	--

<b>SAR Value</b>	0.83 W/kg (10 g) (TECRA A40-K) 0.27 W/kg (10 g) (TECRA A50-K)
<b>Maximum Power Output</b>	
(2400 - 2483.5 MHz) IEEE 802.11 b/g/n/ax mode / Bluetooth	Maximum 100 mW (20 dBm) EIRP
(2400 - 2483.5 MHz) BLE	Maximum 10 mW (10 dBm) EIRP
(5150 - 5725 MHz) IEEE 802.11 a/n/ac/ax mode	Maximum 200 mW (23 dBm) EIRP The low band 5.15 - 5.35 GHz is for indoor use only.
(5745 - 5875 MHz) IEEE 802.11 a/n/ac/ax mode	Maximum 25 mW (13.98 dBm) EIRP
(5945 - 6425 MHz) IEEE 802.11 ax mode	Maximum 200 mW (23 dBm) EIRP For indoor use only.

#### Europe: model RTL8852AE

<b>Software Version</b>	6001.0.10.xxx and following versions
<b>SAR Value</b>	0.45 W/kg (10 g) (TECRA A40-K) 0.30 W/kg (10 g) (TECRA A50-K)
<b>Maximum Power Output</b>	
(2400 - 2483.5 MHz) IEEE 802.11 b/g/n/ax mode / Bluetooth	Maximum 100 mW (20 dBm) EIRP
(2400 - 2483.5 MHz) BLE	Maximum 10 mW (10 dBm) EIRP
(5150 - 5725 MHz) IEEE 802.11 a/n/ac/ax mode	Maximum 200 mW (23 dBm) EIRP The low band 5.15 - 5.35 GHz is for indoor use only.
(5745 - 5875 MHz) IEEE 802.11 a/n/ac/ax mode	Maximum 25 mW (14 dBm) EIRP

#### Europe: model EM120R-GL

##### Software (Firmware) Version: EM120RGLAUR02AxxM4G\_0x

Band	Frequencies	Conducted Tx (Transmit) power tolerances
LTE frequency band support		

Band 1	2100 MHz	Tx: 1,920–1,980 MHz	+23 dBm $\pm$ 2 dB
		Rx: 2,110–2,170 MHz	
Band 3	1800 MHz	Tx: 1,710–1,785 MHz	+23 dBm $\pm$ 2 dB
		Rx: 1,805–1,880 MHz	
Band 7	2600 MHz	Tx: 2,500–2,570 MHz	+22 dBm $\pm$ 2 dB
		Rx: 2,620–2,690 MHz	
Band 28	700 MHz	Tx: 703–748 MHz	+23 dBm $\pm$ 2 dB
		Rx: 758–803 MHz	

#### WCDMA frequency band support

Band 1	WCDMA 2100	Tx: 1,920–1,980 MHz	+24 dBm +1/-3 dB
		Rx: 2,110–2,170 MHz	
Band 8	WCDMA 900	Tx: 880–915 MHz	+23 dBm $\pm$ 1 dB
		Rx: 925–960 MHz	

To remain in conformance with European spectrum usage laws for Wireless LAN operation, the above 2.4 GHz, 5 GHz and 6 GHz channel limitations apply for outdoor usage. The user should use the wireless LAN utility to check the current channel of operation. If operation is occurring outside of the allowable frequencies for outdoor use, as listed above, the user must contact the applicable national spectrum regulator to request a license for outdoor operation.

#### ***Canada - Innovation, Science and Economic Development Canada (ISED)***

This device complies with RSS-247 of the ISED Rules. Operation is subject to the following two conditions: (1) This device may not cause harmful interference, and (2) this device must accept any interference received, including interference that may cause undesired operation.

Ce dispositif est conforme à la norme CNR-247 d'Innovation, Sciences et Développement économique Canada (ISDE) applicable aux appareils radio exempts de licence. Son fonctionnement est sujet aux deux conditions suivantes: (1) le dispositif ne doit pas produire de brouillage préjudiciable, et (2) ce dispositif doit accepter tout brouillage reçu, y compris un brouillage susceptible de provoquer un fonctionnement indésirable.

Les dispositifs fonctionnant dans la bande 5.15-5.25 GHz sont réservés uniquement pour une utilisation à l'intérieur afin de réduire les risques de brouillage préjudiciable aux systèmes de satellites mobiles utilisant les mêmes canaux.

Les utilisateurs devraient aussi être avisés que les utilisateurs de radars de haute puissance sont désignés utilisateurs principaux (c.-à-d., qu'ils ont la

---

priorité) pour les bandes 5.25-5.35 GHz et 5.65-5.85 GHz et que ces radars pourraient causer du brouillage et/ou des dommages aux dispositifs LAN-EL.

The term “IC” before the equipment certification number only signifies that the ISED technical specifications were met.

### ***USA - Federal Communications Commission (FCC)***

This equipment has been tested and found to comply with the limits for a Class B digital device, pursuant to Part 15 of FCC Rules. These limits are designed to provide reasonable protection against harmful interference in a residential installation.

Refer to the FCC information section for the detailed information.

### ***Caution: Exposure to Radio Frequency Radiation***

The radiated output power of the Wireless device is far below the FCC radio frequency exposure limits. Nevertheless, the Wireless device shall be used in such a manner that the potential for human contact during normal operation is minimized.

In the usual operating configuration, the distance between the antenna and the user should not be less than 20 cm. Please refer to the computer user's manual for the details regarding antenna location.

The installer of this radio equipment must ensure that the antenna is located or pointed such that it does not emit RF field in excess of Health Canada limits for the general population; consult Safety Code 6, obtainable from Health Canada's website [www.hc-sc.gc.ca](http://www.hc-sc.gc.ca)

### ***Caution: Radio Frequency Interference Requirements***

This device is restricted to indoor use due to its operation in the 5.15 to 5.25 GHz frequency range.

High-power radars are allocated as primary users (i.e. priority users) of the bands 5.25 to 5.35 GHz and 5.65 to 5.85 GHz and these radars could cause interference and/or damage to LE-LAN devices.

### ***Australia and New Zealand regulatory compliance***

This equipment incorporates a radio transmitting device, in normal use a separation distance of 20 cm will ensure radio frequency exposure level complies with the Australian and New Zealand Standards.

### ***Using this equipment in Japan***

In Japan, the frequency bandwidth of 2,400 MHz to 2,483.5 MHz for second generation low-power data communication systems such as this equipment overlaps that of mobile object identification systems (premises radio station and specified low-power radio station).



### 1. Important notice

The frequency bandwidth of this equipment may operate within the same range as industrial devices, scientific devices, medical devices, microwave ovens, licensed radio stations and non-licensed specified low-power radio stations for mobile object identification systems (RFID) used in factory production lines (Other Radio Stations).

1. Before using this equipment, ensure that it does not interfere with any of the equipment listed above.
2. If this equipment causes RF interference to other radio stations, promptly change the frequency being used, change the location of use, or turn off the source of emissions.
3. Contact an authorized service provider if you have problems with interference caused by this product to Other Radio Stations.

### 2. Indication for Wireless LAN

The indication shown below appears on this equipment.

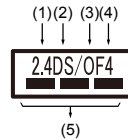

1. 2.4 : This equipment uses a frequency of 2.4 GHz.
2. DS : This equipment uses DS-SS modulation.
3. OF : This equipment uses OFDM modulation.
4. 4 : The interference range of this equipment is less than 40 m.
5. ■■■ : This equipment uses a frequency bandwidth from 2,400 MHz to 2,483.5 MHz. It is possible to avoid the band of mobile object identification systems.

### 3. Indication for Bluetooth®

The indication shown below appears on this equipment.

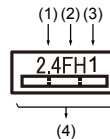

1. 2.4 : This equipment uses a frequency of 2.4 GHz.
2. FH : This equipment uses FH-SS modulation.
3. 1 : The interference range of this equipment is less than 10 m.
4. □□□ : This equipment uses a frequency bandwidth from 2,400 MHz to 2,483.5 MHz. It is impossible to avoid the band of mobile object identification systems.

---

#### 4. About the JEITA

5 GHz Wireless LAN supports W52/W53/W56 Channel.

IEEE802.11b/g/n/ax
IEEE802.11a/n/ac/ax
W52   W53   W56

### Device Authorization

This device obtains the Technical Regulation Conformity Certification and it belongs to the device class of radio equipment of low-power data communication system radio station stipulated in the Telecommunications Business Law of Japan.

- Intel® Wi-Fi® 6E AX211  
The Name of the radio equipment: AX211NGW  
DSP Research, Inc.  
Approval Number: D210019003
- Realtek WiFi 6 RTL8852AE  
The Name of the radio equipment: RTL8852AE  
Telefication BV  
Approval Number: D200169201

The following restrictions apply:

- Do not disassemble or modify the device.
- Do not install the embedded wireless module into other device.

### Information about Intel® AMT

Your computer may support Intel® Active Management Technology (AMT) depending on the model you purchased.

Using built-in platform capabilities and popular third-party management and security applications, Intel® AMT allows IT to better discover, repair and protect their networked computing assets.

Consult with your system administrator about configurations of the AMT function before connecting to a network.

### Disable the AMT function

Intel® AMT function is enabled by default, and in a situation where no system administrator is available, it is strongly recommended that you turn off the AMT function before connecting to a network.

**If the AMT function is NOT turned off, there is a danger that the management of AMT function will be abused by other parties which possibly lead to the leak of sensitive and/or proprietary information, data loss, HDD/SSD erasure, or file overwritten.**

To disable the AMT function, do the following:

1. Turn on the computer while pressing the **F2** key.
2. On the dynabook Setup Utility screen, select **MEBx -> Intel(R) ME Password**, and enter the default password "admin" in the password field.
3. Enter a new password. Password must comply with the following requirements concerning character types and length:  
Must be between 8 and 32 characters long.  
Must contain at least one number ("0", "1-9").  
Must contain a mix of lower-case ("a", "b", "z", etc.) and upper-case ("A", "B", "Z", etc.) letters.  
Must contain at least one special character of the following: ` ~ ! @ \$ % ^ & \* ( ) - = + [ ] ; ' < . > / ?  
Underscore ("\_") is considered the same as Roman alphabet characters and is not counted as a special character.



*Key input is based on the US keyboard layout. The following table shows examples of the special characters in US keyboard layout.*

Special character you want to input	Corresponding number key (SHIFT key + a number key)
!	1
@	2
#	3
\$	4
%	5
^	6
&	7
*	8
(	9
)	0

4. Select **Intel(R) AMT**, and press the **Enter** key.
5. Select **Disabled**, and press the **Enter** key.
6. Press the **F10** key to save the settings, and press the **Y** key.



- *When using the computer with the AC adaptor connected and the AMT function set to enabled, power might still be supplied to the system memory even when the computer power is turned off, or the computer is in Sleep Mode or Hibernation Mode.*
- *When connecting the AC adaptor, the computer is powered and can be turned on. If the power is automatically turned off after approximately 5 to 7 seconds, it is because the RTC lasting time runs out and the settings of AMT function have been cleared. This is normal and not an error. If it occurs, the settings of AMT function must be reconfigured.*
- *If there is a problem when you start the computer or initialize the Management Engine (ME) firmware after the RTC lasting time runs out, the system will automatically reset itself during setup. This is the function of AMT configurations and is not an error.*
- *Enabling the AMT function might cause the network LAN Enable/Disable items to be no longer changeable in dynabook Setup Utility. Consult with your system administrator about details.*
- *AMT function cannot be operated using a USB-LAN adapter.*



*The useable system memory for models equipped with the AMT function is 16 - 64 MB, less than that of models not equipped with the AMT function. The amount of the difference depends on the amount of memory installed.*

## Notes for system administrators

- Intel® AMT is enabled by default in the Management Engine (ME) firmware.
- Both the security of management console and the network management must be thoroughly implemented through management of AMT function. Otherwise administrator privileges might be abused by other parties which possibly lead to the leak of sensitive and/or proprietary information, data loss, HDD/SSD erasure, or file overwritten.
- When using the USB Provisioning function, you must turn on this function before using.
  1. Turn on the computer while pressing the **F2** key.
  2. On the dynabook Setup Utility screen, set the Supervisor Password on **Security** menu.
  3. Set **USB Provisioning of AMT** to **Enabled**.
  4. Press the **F10** key, and press **Y** key to save the setting.
- The following functions are not supported:
  - RPAT (Remote PC Assist Technology)
  - Remote BIOS update

---

## Accessibility

Accessibility options provided by Windows 11 operating system are accessible through Accessibility features of Windows settings. It allows you to customize your Dynabook notebook the way you want to use it. To see the available features in one of the following ways:

- Go to **Start** and select **Settings** (⚙️).
- Using a keyboard, press the **⊞ ( Windows key ) + I**, scroll up to the word **Settings**, then press Enter.

Then select **Accessibility** from the **Settings** screen.

## Accessibility for Dynabook notebook

Accessibility options provides those with learning, vision, hearing, mobility and other impairments with the following features categories.

### Vision

- **Text size:** To change the size that appear in Windows and in applications.
- **Visual effects:** Animations, transparency and automatically hide scroll bars in Windows can be enabled or disabled. **Notifications for** can be adjusted for 5 seconds, 7 seconds, 15 seconds, 30 seconds, 1 minute and 5 minutes.
- **Mouse pointer and touch:** Makes pointer, cursor and touch feedback easier to see. Change pointer size and colour, cursor thickness, touch feedback and make visual feedback for touch points darker and larger.
- **Text cursor:** Makes the text cursor easier to see by changing the colour, size, and thickness.
- **Magnifier:** Makes part or all of your screen bigger allowing words and images easier to see. For more information, refer to [Use Magnifier to make things on the screen easier to see](#).
- **Colour Filters:** Makes photos and colours easier to see by applying a colour filter to your screen. Toggle **Turn on colour filters** to enable or disable this feature. Then, select a colour filter from the menu and see which one best suits you.
- **Contrast Themes:** This can be used to change to different contrast themes. Choose a theme from the drop-down menu to customize colour for links and button text. To turn high contrast mode on or off from the sign-in screen, select the **Accessibility** button, then turn on the toggle under High Contrast. From the keyboard press **Left Alt + Left Shift + Print Screen**.
- **Narrator:** Screen-reading app built into Windows 11. For more information, refer to [How to use Narrator](#).

[Click here](#) for more information about making your device easier to see or use without a screen.

---

## Hearing

- **Audio:** For those with hearing difficulties, this option makes it easier to hear with features like **Hear all sounds in one channel**, and **Display audio alerts visually**.
- **Captions:** Lets you read the word spoken in the audio portion of a video, TV show or movie that supports Closed Caption technology. You can select the settings you want and see how they appear in preview.

[Click here](#) for more information about making your device easier to hear or use with these visual alternatives to sound.

## Interaction



- **Speech:** Talk instead of type. Press the  (**Windows key**) + **H** to start dictation or select the microphone button on the touch keyboard. Cortana, the Windows 11 built-in digital assistant, can help with setting reminders, opening apps, finding facts, and sending emails and text messages.

Cortana is only available in certain countries and some Cortana features might not be available everywhere.

- **Keyboard:** Among many other features, this option allows those with limited typing ability to type by pointing and clicking.
- **Mouse:** Allows you to change the size and color of the mouse pointer making it easier to view. Other mouse properties settings are customizable through the **Additional mouse options**.
- **Eye control:** Allows you to setup an eye tracking device. Refer to [Compatible Eye tracking device](#) for more information.

For more information about Accessibility and other features with Windows 11 operating system, [Click here](#).

## Others

- **Hardware:** All ports used for input or output device connections are industry standards and can be used to connect to any industry standard compatible third party devices.
- **Power On/Off:** User can choose to have their notebook go to sleep mode to avoid having to manually power off or click on **Start** and then select  (**Power**) > **Shutdown** when closing the lid. [Click here](#) for more information on this feature. The notebook can be configured to resume when the lid is open without having to push the power on button. This can be specified in the Power Options. Right click on the battery icon  in task bar and select **Power Options** to configure.
- **Sign-in options:** Windows offers a number of sign-in options including biometric and non-biometric, refer to [Sign-in options](#) in Chapter 2 of the user's manual.

- 
- **Touch Screen:** Some notebook configurations have touch screen capability, refer to [Using the Touch Screen](#) section for more information.
  - **Touch Pad:** The Touch Pad on the palm rest supports several features, refer to [Using the Touch Pad](#) section for more information.
  - **Keyboard:** The number of keys available on your keyboard depends on which region your computer is configured for, with keyboards being available for numerous languages. There are different types of keys, functions keys, Windows special keys, and the keypad overlay. Refer to [The Keyboard](#) section for more information.
  - **Fingerprint Sensor:** Some notebook configurations have fingerprint sensor for enrolling and recognizing fingerprints. Refer to [Using the Fingerprint Sensor](#) section for more information.
  - **Battery:** When the AC adaptor is not connected, the main power source of the computer is the main battery. Refer to the [Battery](#) section for information about charging and caring of the battery pack.
  - **Memory Media:** The computer is equipped with a Memory media slot that can accommodate some kinds of memory media with various memory capacities so that you can transfer data between devices. Refer to [Memory media](#) section for more information.
  - **Smart Card:** Some notebook configurations include Smart Card slot. Refer to [Smart Card](#) section for more information.
  - **Wireless WAN:** Some models are equipped with wireless WAN device. Refer to [Wireless WAN device](#) section for more information.
  - **GPS Function:** If your computer includes Wireless WAN device, it may include GPS. Refer to [GPS Function](#) section for more information.
  - **HDMI™ out port:** HDMI™ out port digitally transfers both video and audio data and can be connected to HDMI™ compatible external display. Refer to [HDMI™ out port](#) section for more information.
  - **LAN:** Your computer may have built-in Ethernet LAN (10BASE-T, 100BASE-TX or Gigabit Ethernet LAN 1000BASE-T). Refer to [LAN](#) section for more information on how to connect/disconnect to a LAN.
  - **USB Type-C™ Adapters:** Your computer capabilities can be enhanced by connecting external devices such as RGB monitor to the USB Type-C™ port via USB Type-C™ adapters. Refer to [USB Type-C™ Adapters](#) section for more information.
  - **Wireless Display:** Your computer might support wireless display, a wireless technology which utilizes Wi-Fi to allow the computer to be wirelessly connected to external displays including TVs as extended screens. Refer to [Wireless display](#) section for more information.
  - **Security Lock:** This feature enables you to anchor your computer to a desk or other object in order to prevent unauthorized removal or theft. Refer to [Security lock](#) section for more information.
  - **Sound System and Video mode:** This section describes some of the audio controls functions such as volume mixer, microphone level, Realtek Audio Console and video modes. Refer to [Sound Systems and Video mode](#) section for more information.

- 
- **Utilities and Advanced Usage:** Your computer comes with pre-installed utilities such as dynabook Settings, eco Utility USB Charging, Power Off and Charge, System ON CDP Charge, System Password, User Password, Supervisor Password, Pre-Boot Authentication, dynabook Service Station, dynabook Setup Utility, and dynabook Maintenance Utility. Refer to [Utilities and Advanced Usage](#) section for more information. You might have all the software listed depending on the model you purchased.
  - **Special features:** Your computer may come pre-installed with several special features such as Display automatic power off, Internal storage drive automatic power off, System automatic Sleep/Hibernation Mode, Power on password, Intelligent power supply, Battery save mode, Panel power on/off, Low battery automatic Hibernation Mode, Sleep Mode, Hibernation Mode, USB Wake-up function, and Heat dispersal. Refer to [Special features](#) section for more information.
  - **Troubleshooting:** Dynabook has designed this computer for durability, however, should problems occur, you are able to use the procedures detailed in the [Troubleshooting](#) section to help determine the cause. You should familiarize yourself with this section as knowing what might go wrong can help prevent problems from occurring in the first place.
  - **Support:** Please visit our support website <http://emea.dynabook.com/support-country-selector> if you need further assistance.

## Legal Footnotes

### Non-applicable Icons

Certain computer chassis are designed to accommodate all possible configurations for an entire product series. Therefore, be aware that your selected model might not have all the features and specifications corresponding to all of the icons or switches shown on the computer chassis.

### CPU

CPU performance in your computer product might vary from specifications under the following conditions:

- use of certain external peripheral products
- use of battery power instead of AC power
- use of certain multimedia, computer generated graphics or video applications
- use of standard telephone lines or low speed network connections
- use of complex modeling software, such as high end computer aided design applications
- use of several applications or functionalities simultaneously



- 
- use of computer in areas with low air pressure (high altitude >1,000 meters or >3,280 feet above sea level)
  - use of computer at temperatures outside the range of 5°C to 30°C (41 -86°F) or >25°C (77°F) at high altitude (all temperature references are approximate and might vary depending on the specific computer model - contact Technical Support for details).

CPU performance might also vary from specifications due to design configuration.

Under some conditions, your computer product might automatically shut down. This is a normal protective feature designed to reduce the risk of lost data or damage to the product when used outside recommended conditions. To avoid risk of lost data, always make back-up copies of data by periodically storing it on an external storage medium. For optimum performance, use your computer product only under recommended conditions. Read additional restrictions in your product documentation. Contact technical service and support, refer to [Technical support](#) section for more information.

### **64-Bit Computing**

Certain 32-bit device drivers and/or applications might not be compatible with a 64-bit CPU operating system and therefore might not function properly.

## **Memory (Main System)**

Part of the main system memory might be used by the graphics system for graphics performance and therefore reduce the amount of main system memory available for other computing activities. The amount of main system memory allocated to support graphics might vary depending on the graphics system, applications utilized, system memory size, and other factors.

## **Battery Life**

Battery life might vary considerably depending on product model, configuration, applications, power management settings, and features utilized, as well as the natural performance variations produced by the design of individual components. Published battery life numbers are achieved on select models and configurations tested by Dynabook at the time of publication. Recharge time varies depending on usage. Battery might not charge while computer is consuming full power.

After going through many charge and discharge cycles, the battery loses its ability to perform at maximum capacity and needs to be replaced. This is a normal phenomenon for all batteries. To purchase a new battery pack, see the accessories information that is shipped with your computer.

---

## Internal Storage Drive Capacity

1 Gigabyte (GB) means  $10^9 = 1,000,000,000$  bytes using powers of 10. The computer operating system, however, reports storage capacity using powers of 2 for the definition of  $1 \text{ GB} = 2^{30} = 1,073,741,824$  bytes, and therefore shows less storage capacity. Available storage capacity will also be less if the product includes one or more pre-installed operating systems, such as Microsoft Operating System and/or pre-installed software applications, or media content. Actual formatted capacity might vary.

## LCD

Over a period of time, and depending on the usage of the computer, the brightness of the LCD screen will deteriorate. This is an intrinsic characteristic of LCD technology.

Maximum brightness is only available when operating in AC power mode. Screen dims when the computer is operated on battery power and you might not be able to increase the brightness of the screen.

## Wireless LAN

The transmission speed over the wireless LAN and the distance over which wireless LAN can reach might vary depending on surrounding electromagnetic environment, obstacles, access point design and configuration, and client design and software/hardware configurations.

The actual transmission speed is lower than the theoretical maximum speed.

## Copy Protection

Applicable copy protection standards included in certain media may prevent or limit recording or viewing of the media.

---

# Index

## A

AC adaptor  
additional 4-27  
connecting 2-3

## B

Battery  
extending life 4-12  
monitoring capacity 4-10  
real time clock 4-8  
save mode 5-10

Bluetooth® 7-6

## C

Cleaning the computer 1-18  
Cooling vents 3-5, 3-13

## D

DC IN/Battery indicator 3-19  
Display  
automatic power off 5-10  
screen 3-7, 3-17

Documentation list 2-1

Dual Pointing Device  
Touch Pad 6-8

## E

Equipment checklist 2-1

External monitor  
problems 6-14

## H

Hard disk drive  
automatic power off 5-10

## K

Keyboard  
function keys 4-4  
function keys F1...F12 4-4  
problems 6-6  
Windows special keys 4-6

## L

LAN  
cable types 4-23  
connecting 4-23

LAN jack 4-22

## M

Media care  
card care 4-13

Memory  
installing 4-16  
removing 4-18

Memory media card  
inserting 4-14  
removing 4-14

	Memory media slot 4-12	
	microSD/SDHC/SDXC card note 4-13	
	Moving the computer 1-19	
<b>P</b>		<b>R</b>
	Password	Recovery hard disk drive 2-16
	power on 5-10	Recovery Media 2-15
	Starting the computer by password 5-6	
	Supervisor 5-6	
	User 5-5	
	Power	<b>S</b>
	Hibernation Mode 2-12	SD/SDHC/SDXC card formatting 4-13
	panel on/off 5-11	Security lock 4-27
	Shut Down mode 2-10	SIM card
	Sleep Mode 2-10	installing 4-19
	turning off 2-10	removing 4-20
	turning on 2-7	
	Problems	Sleep Mode
	AC power 6-5	setting 2-10
	Analyzing the problem 6-2	system automatic 5-10
	Battery 6-5	
	Dual Pointing device 6-8	
	External monitor 6-13	
	Hardware and system checklist 6-4	
	HDD 6-7, 6-8	
	Internal display panel 6-7	
	Keyboard 6-6	
	Memory Media Card 6-8	
	Overheating power down 6-5	
	Power 6-4	
	Real Time Clock 6-6	
	Sound system 6-13	
	Technical support 6-16	
	Touch Pad 6-8	
	USB device 6-11	
	USB mouse 6-9	
		Smart Card 4-15
		Sound system problems 6-13
		<b>T</b>
		Touch Screen 4-1
		<b>U</b>
		USB device problems 6-11
		<b>V</b>
		Video mode 4-30

---

# W

Web Camera 3-6, 3-16

Wireless communication 7-5