

# USER MANUAL

---

AVS-HDMI2-4X4-R2

# VIDEO MATRIX SWITCHER - HDMI 2.0, 4X4

---

24/7 TECHNICAL SUPPORT AT 1.877.877.2269 OR VISIT [BLACKBOX.COM](http://BLACKBOX.COM)



# TABLE OF CONTENTS

<b>SAFETY PRECAUTIONS.....</b>	<b>4</b>
<b>CHAPTER 1: SPECIFICATIONS.....</b>	<b>5</b>
1.1 Resolution Downscaling.....	6
<b>CHAPTER 2: OVERVIEW .....</b>	<b>7</b>
2.1 Introduction.....	7
2.2 Features .....	7
2.3 What's Included.....	7
2.4 Hardware Description.....	8
2.4.1 Front Panel.....	8
2.4.2 Rear Panel.....	9
<b>CHAPTER 3: SYSTEM CONNECTION.....</b>	<b>10</b>
3.1 Usage Precautions .....	10
3.2 System Diagram .....	10
<b>CHAPTER 4: PANEL BUTTON CONTROL .....</b>	<b>11</b>
4.1 I/O Connection Switching.....	11
4.2 I/O Connection Inquiry.....	11
4.3 Lock Function.....	11
4.4 Preset Recall Function.....	11
4.5 Clear Button.....	11
<b>CHAPTER 5: IR CONTROL.....</b>	<b>12</b>
<b>CHAPTER 6: GUI CONTROL.....</b>	<b>13</b>
6.1 Switching Tab.....	14
6.2 Audio Tab .....	15
6.2.1 Audio Settings.....	15
6.2.2 Audio Volume.....	16
6.3 Configuration Tab.....	16
6.3.1 EDID Copy .....	16
6.3.2 EDID Setting.....	17
6.4 CEC Tab.....	18
6.4.1 Input Source Device Control.....	18
6.4.2 Output Display Device Control.....	19
6.5 RS-232 Tab.....	19
6.6 Interface Tab.....	20
6.7 Network Tab.....	20
6.8 Access Tab.....	21
<b>CHAPTER 7: GUI UPGRADE.....</b>	<b>22</b>
7.1 GUI Upgrade Process .....	22
<b>CHAPTER 8: RS-232 CONTROL .....</b>	<b>23</b>
8.1 Installation/Uninstallation of RS-232 Control Software .....	23
8.2 Basic Settings.....	23
8.3 RS-232 Communication Commands.....	24
8.3.1 System Commands .....	24
8.3.2 Control Management .....	25
8.3.3 Query Commands.....	26



# TABLE OF CONTENTS

8.3.4 Lock/Unlock Commands.....	27
8.3.5 Audio Commands.....	28
8.3.6 HDCP COMPLIANCE.....	29
8.3.7 EDID Management.....	30
8.3.8 CEC Control.....	31
<b>CHAPTER 9: FIRMWARE UPGRADE.....</b>	<b>34</b>
<b>CHAPTER 10: TROUBLESHOOTING.....</b>	<b>35</b>
<b>APPENDIX A: REGULATORY INFORMATION .....</b>	<b>36</b>
A.1 FCC Statement .....	36
A.2 CE Statement .....	36
A.3 ROHS.....	36
A.4 NOM Statement .....	37
<b>APPENDIX A: REGULATORY INFORMATION .....</b>	<b>37</b>
<b>APPENDIX B: DISCLAIMER/TRADEMARKS .....</b>	<b>38</b>
B.1 Disclaimer .....	38
B.2 Trademarks Used in this Manual.....	38



## SAFETY PRECAUTIONS

To ensure the best performance from the product, please read all directions carefully before using the device. Save this manual for future reference.

- ◆ Unpack the equipment carefully and save the original box and packing material for possible future shipment.
- ◆ Follow basic safety precautions to reduce the risk of fire, electrical shock, and personal injury.
- ◆ Do not dismantle the housing or modify the module. It may result in electrical shock or burn.
- ◆ Using supplies or parts not meeting the product's specifications may cause damage, deterioration, or malfunction.
- ◆ Refer all servicing to qualified service personnel.
- ◆ To prevent fire or shock hazard, do not expose the unit to rain or moisture. Do not install this product near water.
- ◆ Do not put any heavy items on the extension cable in case of extrusion.
- ◆ Do not remove the housing of the device as opening or removing housing may expose you to dangerous voltage or other hazards.
- ◆ Install the device in a location with sufficient ventilation to avoid damage caused by overheating.
- ◆ Keep the module away from liquids.
- ◆ Spillage into the housing may result in fire, electrical shock, or equipment damage. If an object or liquid falls or spills on the housing, unplug the module immediately.
- ◆ Do not twist or pull the cable ends by force. Doing so can cause a malfunction.
- ◆ Do not use liquid or aerosol cleaners to clean this unit. Always unplug the power to the device before cleaning.
- ◆ Unplug the power cord when left unused for an extended period of time.
- ◆ Information on disposal for scrapped devices: do not burn or mix with general household waste. Treat as normal electrical waste.



**TABLE 1-1 MATRIX SWITCHER SPECIFICATIONS**

SPECIFICATION	DESCRIPTION
<b>Video</b>	
Video Input Signal	(4) HDMI
Video Input Connector	(4) HDMI Type A female
Video Input Video Resolution	Up to 4K @ 60 Hz 4:4:4
Video Output	(4) HDMI
Video Output Connector	(4) HDMI Type A female
Video Output Resolution	Up to 4K @ 60 Hz 4:4:4
HDMI Output	Supports up to 5V 500mA for AoC cable
HDMI Version	Up to 2.0
HDCP Version	Up to 2.3
HDMI Audio Signal	LPCM 7.1 audio, Dolby Atmos®, Dolby® TrueHD, Dolby Digital® Plus, DTS:X™, and DTS-HD® Master Audio™ pass-through
<b>Digital Audio Output</b>	
Output	(4) Digital SPDIF audio
Output Connector	(4) Toslink connector
Digital SPDIF Audio Format	Supports PCM, Dolby Digital, DTS, DTS-HD
Frequency Response	20 Hz to 20 kHz, ±1dB
Max Output Level	±0.05dBFS
THD+N	< 0.05%, 20 Hz to 20 kHz bandwidth, 1 kHz sine at 0dBFS level (or max level)
SNR	> 90 dB, 20Hz to 20 kHz bandwidth
Crosstalk Isolation	< -70 dB, 10 kHz sine at 0dBFS level (or max level before clipping)
Noise	-90 dB
<b>Analog Audio Output</b>	
Output	(4) Analog L/R Audio
Output Connector	(4) L&R (RCA)
Digital SPDIF Audio Format	PCM 2CH
Frequency Response	20 Hz to 20 kHz, ±1dB
Max Output Level	2.0Vrms ± 0.5dB. 2V = 16dB headroom above -10dBV (316 mV) nominal consumer line level signal
THD+N	< 0.05%, 20 Hz to 20 kHz bandwidth, 1 kHz sine at 0dBFS level (or max level)
SNR	> 80 dB, 20Hz to 20 kHz bandwidth
Crosstalk Isolation	< -80 dB, 10 kHz sine at 0dBFS level (or max level before clipping)
L-R Level Deviation	< 0.05 dB, 1 kHz sine at 0dBFS level (or max level before clipping)
Frequency Response Deviation	< ± 0.5dB 20Hz to 20KHz
Output Load Capability	1k ohm and higher (supports 10x paralleled 10k ohm loads)
Noise	-80 dB
<b>Control</b>	
Control Port	(1) IR EYE, (1) RS-232, (1) TCP/IP
Control Connector	(1) 3.5mm jack, (1) 3-pin terminal block, (1) USB-A, (1) RJ-45

# CHAPTER 1: SPECIFICATIONS

**TABLE 1-1 MATRIX SWITCHER SPECIFICATIONS CONTINUED**

SPECIFICATION	DESCRIPTION
<b>General</b>	
Transmission Distance	4K/60Hz/444 5m, 4K/60Hz/420 10m, 1080p 15m
Bandwidth	18 Gbps
Operation Temperature	23 to 131° F (-5 to +55° C)
Storage Temperature	-13 to 158° F (-25 to +70° C)
Relative Humidity	10 to 90%
External Power Supply	Input: 100 to 240 VAC, 50/60Hz; Output: 24 VDC, 1.25 A
Maximum Power Consumption	18.3 W
Dimensions (H x W x D)	1.7" x 17.2" x 9.3" (4.4 x 43.6 x 23.6 cm)
Net Weight	5.7 lb. (2.6 kg)

## 1.1 RESOLUTION DOWNSCALING

The product supports video resolution downscaling. The 4K input can be automatically degraded to 1080p output for compatibility with a 1080p display, as shown in the chart below.

**TABLE 1-2. VIDEO RESOLUTION DOWN SCALING**

NUMBER	INPUT			OUTPUT	
	RESOLUTION	REFRESH	COLOR SPACE	DOWN SCALE	1080P SPECS
1	3840x2160	60	4:4:4	Supported	1080p @ 60Hz 4:4:4
2	3840x2160	30	4:4:4	Supported	1080p @ 30Hz 4:4:4
3	3840x2160	24	4:4:4	Supported	1080p @ 24Hz 4:4:4
4	3840x2160	60	4:2:0	Supported	1080p @ 60Hz 4:2:0
5	3840x2160	30	4:2:0	Supported	1080p @ 30Hz 4:2:0
6	3840x2160	24	4:2:0	Supported	1080p @ 24Hz 4:2:0
7	3840x2160	60	4:2:2	Not Supported	N/A
8	3840x2160	30	4:2:2	Not Supported	N/A
9	3840x2160	24	4:2:2	Not Supported	N/A

**NOTE:** Only the last two outputs (output 3 and output 4) have downscaling function.



## CHAPTER 2: OVERVIEW

### 2.1 INTRODUCTION

The AVS-HDMI2-4x4-R2 is a professional 4x4 HDMI 2.0 Matrix Switcher with Audio Matrix. It includes 4 HDMI inputs and 4 HDMI outputs. The last two outputs have downscaling function, which is designed for switching two HDMI2.0 and HDCP2.3 compliant signals. It also features 4 SPDIF and 4 analog audio outputs for audio matrix.

The HDMI matrix switcher features comprehensive EDID management and advanced HDCP handling to ensure maximum functionality with a wide range of video sources.

The matrix switcher not only supports bi-directional IR, RS-232 extension but it also has IR, RS-232, and TCP/IP control options.

### 2.2 FEATURES

- ◆ 4x4 HDMI 2.0 Matrix Switcher
- ◆ Supports 4K/60 4:4:4; HDCP2.3 compliant
- ◆ Audio Matrix
- ◆ Audio out can de-embedded from arbitrary input or output.
- ◆ Individual volume adjustment on each left and right output
- ◆ Supports 4K to 1080p downscaling up to 2 outputs
- ◆ HDMI out provides 2.5 W to power Active Optical Cable (AoC).
- ◆ HDMI Output support up to 5V 500mA for AoC cable.
- ◆ Controllable by front panel, IR, RS-232, and TCP/IP.

### 2.3 WHAT'S INCLUDED

- ◆ (1) Video matrix switcher 4x4
- ◆ (1) IR Remote
- ◆ (1) IR Receiver
- ◆ (1) Power Adaptor (24V DC, 1.25 A)
- ◆ (1) RS-232 Cable (3-pin to DB9)
- ◆ (2) Mounting Ears
- ◆ (6) Screws
- ◆ (4) Plastic Cushions

**NOTE:** Please contact your distributor immediately if any damage or defect in the components is found.

## CHAPTER 2: OVERVIEW

### 2.4 HARDWARE DESCRIPTION

Figures 2-1 and 2-2 show the front and back panels of the HDMI matrix switcher. Tables 2-1 and 2-2 describe their components.

#### 2.4.1 FRONT PANEL



FIGURE 2-1: FRONT PANEL

TABLE 2-1. FRONT PANEL COMPONENTS

NUMBER IN FIGURE 2-1	COMPONENT	DESCRIPTION
1	Power Indicator	<ul style="list-style-type: none"> <li>♦ Illuminates green when device powered on</li> <li>♦ Turns red in standby mode</li> </ul>
2	IR sensor	Built-in IR sensor that receives IR signal sent from IR remote
3	INPUT selector button OUTPUT selector button	<ul style="list-style-type: none"> <li>♦ Press one of the four input selector buttons to switch the input source.</li> <li>♦ Press one of the four output selector buttons to select the output channel.</li> </ul>
4	ENTER button LOCK button ALL button CLEAR button	<p>Confirm operation</p> <p>Press this button for three seconds to lock or unlock all front buttons.</p> <p>Select all outputs to convert an input to all outputs: Press <b>INPUTS 1 + ALL + ENTER</b></p> <p>Withdraw button</p>
5	PRESET RECALL HOLD TO STORE	<p>Press and hold a button labeled 1 to 4 to save the current switching status to the corresponding preset 1 to 4.</p> <p>Press a button labeled 1 to 4 to recall the saved corresponding preset 1 to 4.</p>



## 2.4.2 REAR PANEL



FIGURE 2-2: REAR PANEL

TABLE 2-2 REAR PANEL COMPONENTS

NUMBER IN FIGURE 2-2	COMPONENT	DESCRIPTION
1	Inputs	(4) HDMI input ports that connect with HDMI sources
2	Outputs	(4) ports that connect with HDMI displays The latter four HDMI ports have downscaling function.
3	Audio Matrix Outputs	SPDIF: (4) audio output ports for de-embedded HDMI audio L&R (RCA): (4) pairs of audio output ports for de-embedded HDMI audio
4	Controls	IR EYE: Connects with external IR receiver for using the IR remote to control the Matrix Switcher RS-232: 3-pin terminal block to connect the RS-232 control device, such as a PC, or a device to be controlled by RS-232 commands USB-A: USB Type A port for updating firmware. TCP/IP: RJ-45 port to connect the control device, such as a PC, to control the matrix by GUI
5	DC 24V	Connect with 24VDC, 1.25A power adaptor

## CHAPTER 3: SYSTEM CONNECTION

### 3.1 USAGE PRECAUTIONS

- ◆ Make sure all components and accessories are included before installation.
- ◆ System should be installed in a clean environment with proper temperature and humidity.
- ◆ All of the power switches, plugs, sockets, and power cords should be insulated and safe.
- ◆ All devices should be connected before you power on the device.

### 3.2 SYSTEM DIAGRAM

The following diagram illustrates typical input and output connections that can be used with the HDMI matrix switcher.

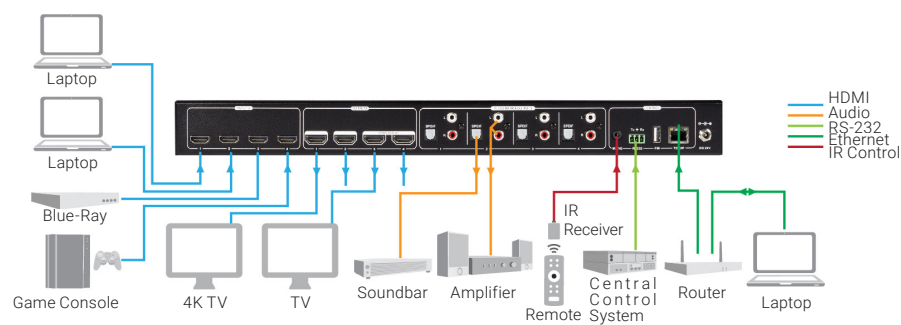

FIGURE 3-1: TYPICAL APPLICATION

## CHAPTER 4: PANEL BUTTON CONTROL

### 4.1 I/O CONNECTION SWITCHING

The front panel features four input selection buttons and four output selection buttons for switching the I/O connection.

1. To convert one input to an output:

Example: Input 1 to Output 3

→ Press **INPUTS 1 + OUTPUTS 3 + ENTER** button.

2. To convert an input to several outputs:

Example: Convert Input 1 to Output 2, Output 3, Output 4

→ Press **INPUTS 1 + OUTPUTS 2, OUTPUTS 3, OUTPUTS 4 + ENTER** button.

3. To convert an input to four outputs:

Example: Convert Input 2 to all outputs

→ Press **INPUTS 2 + ALL** button + **ENTER** button.

**NOTE:** Indicator lights for the pressed buttons will blink blue three times and then turn off if the conversion succeeds. If the conversion fails, they will turn off immediately.

### 4.2 I/O CONNECTION INQUIRY

Press **OUTPUTS** button 1, 2, 3 or 4 to inquiry its corresponding input. Then the input button indicator light will turn blue.

### 4.3 LOCK FUNCTION

To engage the lock function, long press the **LOCK** button for three seconds. All buttons on the front panel will become disabled. Long press the **LOCK** button for three seconds again or unlock on the GUI control to unlock the front panel.

### 4.4 PRESET RECALL FUNCTION

Press and hold a **PRESET** labeled 1 to 4 for at least three seconds to save the current switching status to the corresponding preset labeled 1 to 4.

Press a **PRESET** labeled 1 to 4 to recall the saved corresponding preset 1 to 4.

**NOTE:** The matrix switcher supports 6 presets, but only presets labeled 1 to 4 can be saved and recalled by button control. Please manage other preset buttons by GUI control or RS-232 control.

### 4.5 Clear Button

Press the **CLEAR** button if you want to withdraw an operation before the **ENTER** button takes effect. The matrix will return to the previous status.

## CHAPTER 5: IR CONTROL

The HDMI Matrix Switcher features one built-in IR receiver to receive an IR signal from an IR remote to enable IR control. If the external IR receiver or other IR control device needs to be used, the IR EYE port on rear panel can be connected.

1. Standby button: Press to enter/exit standby mode.
2. INPUTS: Input channel selection buttons (same as the corresponding front panel buttons)
3. OUTPUTS: Output channel selection buttons (same as the corresponding front panel buttons)
4. Menu buttons:

- ALL: Select all inputs/outputs.

To convert an input to all outputs:

Example: Input 1 to all Outputs:

→ Press **INPUTS 1 + ALL + ENTER**

- EDID management button:

1. One input port obtains the EDID data from one output port.

Example: Input 2 obtains EDID data from output 4:

→ Press **EDID + INPUTS 2 + OUTPUTS 4 + ENTER**

2. All input ports obtain EDID data from one output port.

Example: All input ports obtain EDID data from output 3:

→ Press **EDID + ALL + OUTPUTS 3 + ENTER**

- CLEAR: Withdraw button.

- ENTER: Confirm operation.

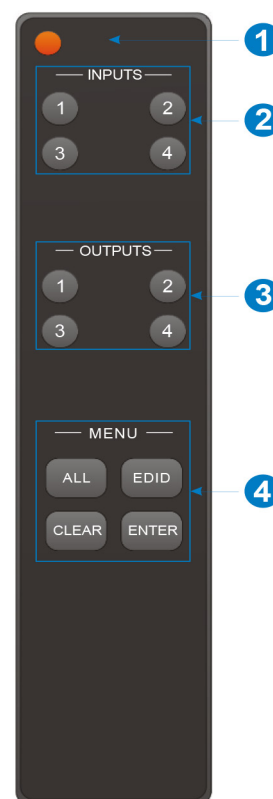

FIGURE 5-1: IR REMOTE CONTROL

## CHAPTER 6: GUI CONTROL

The matrix can be controlled via TCP/IP. The default IP settings are:

IP Address: 192.168.0.178  
Subnet Mask: 255.255.255.0  
Gateway: 192.168.0.1

Type 192.168.0.178 in your Internet browser. It will then display the below log-in screen:

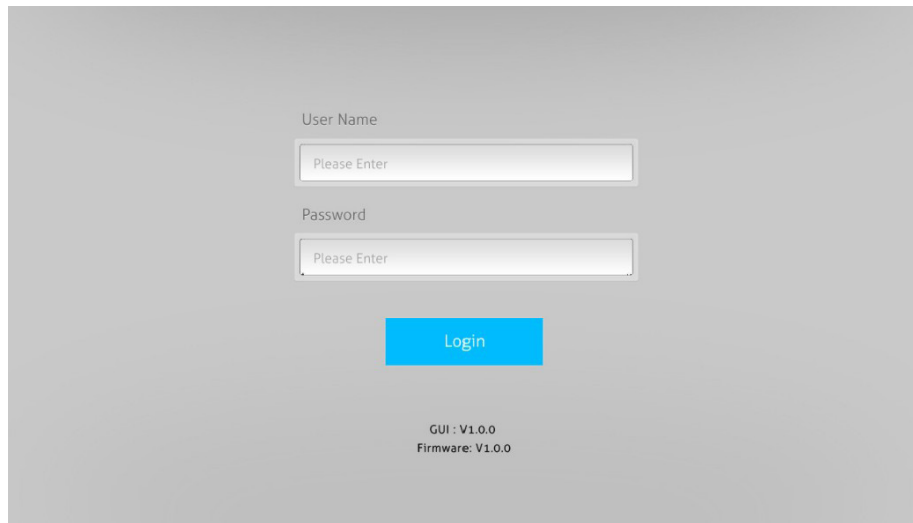

The screenshot shows a login interface on a grey background. At the top, it says "User Name" above a text input field containing "Please Enter". Below that is "Password" above another text input field containing "Please Enter". A blue "Login" button is centered below the fields. At the bottom, it displays "GUI : V1.0.0" and "Firmware: V1.0.0".

FIGURE 6-1: LOG IN SCREEN

**USERNAME:** admin

**PASSWORD:** admin

Type the user name and password. Then click **Login** to enter the section for video switching.

# CHAPTER 6: GUI CONTROL

## 6.1 SWITCHING TAB

You can use the 4x4 button grid on the Switching Tab to set which inputs are directed to which outputs. For example, clicking the button on the Input 1 row and Output 1 column directs input 1 to output 1.

You can also use the six numbered buttons to save and load layout presets.



FIGURE 6-2: LAYOUT PRESETS

To save a given layout, first click on one of the numbered buttons. Then click on the **Save** button.

To load a previously saved layout, first click on one of the numbered buttons. Then click on the **Recall** button.



FIGURE 6-3: SAVING AND LOADING PRESETS

## 6.2 AUDIO TAB

You can set and modify the matrix switcher’s audio settings and volume on the audio tab. Use the Setting and Volume buttons on this tab to view and modify these settings.

### 6.2.1 AUDIO SETTINGS

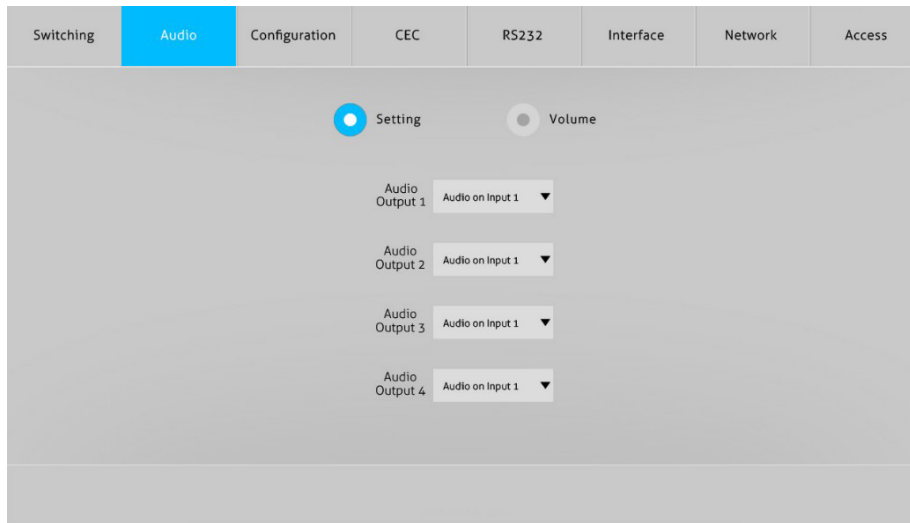

FIGURE 6-4: AUDIO SETTINGS

There are eight audio sources can be selected for four digital SPDIF output ports.

TABLE 6-1. AUDIO OUTPUT PORTS AND AUDIO SOURCES

AUDIO OUTPUT PORTS	AUDIO SOURCES	
	INPUT BREAKOUT	OUTPUT BREAKOUT
SPDIF 1 & ANALOG 1	Audio on Input 1	Audio on Output 1
SPDIF 2 & ANALOG 2	Audio on Input 2	Audio on Output 2
SPDIF 3 & ANALOG 3	Audio on Input 3	Audio on Output 3
SPDIF 4 & ANALOG 4	Audio on Input 4	Audio on Output 4

# CHAPTER 6: GUI CONTROL

## 6.2.2 AUDIO VOLUME

Use four pairs of analog Left/Right (L/R) audio to control their output's volume.

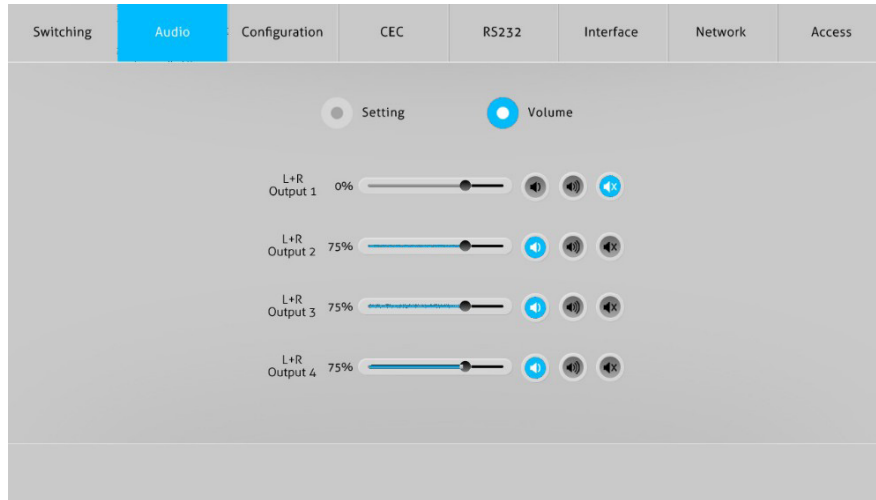

FIGURE 6-5: AUDIO VOLUME SETTINGS

## 6.3 CONFIGURATION TAB

You can set and modify EDID options on the Configuration tab. Use the EDID Copy and EDID Setting buttons on this tab to view and modify these settings.

### 6.3.1 EDID COPY

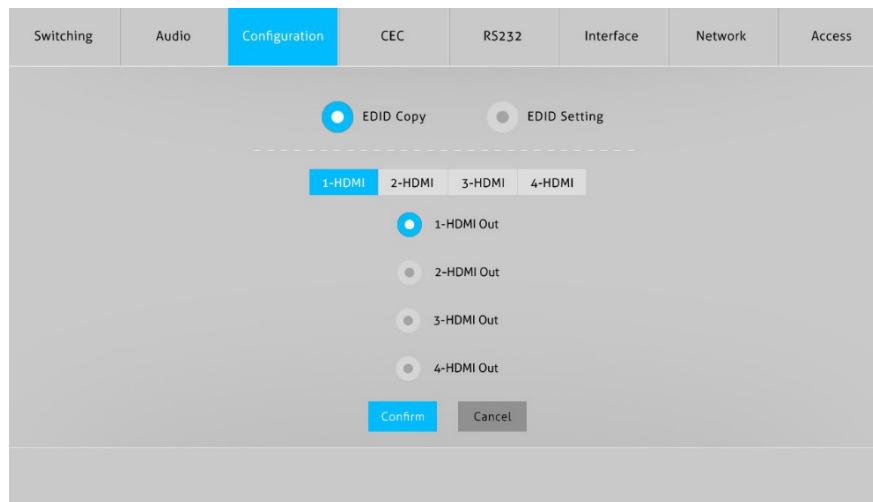

FIGURE 6-6: EDID COPY SETTINGS

Copy the EDID of the selected output device to input source device(s).





## 6.3.2 EDID SETTING

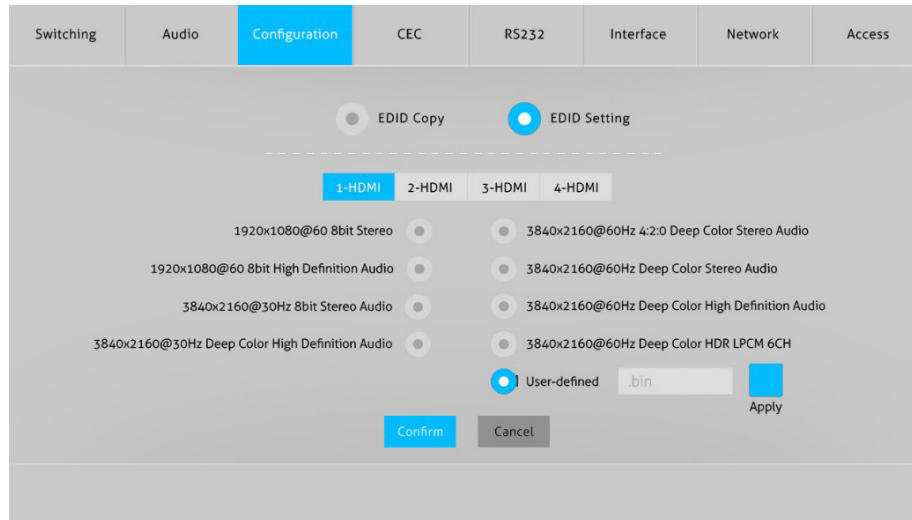

FIGURE 6-7: EDID CONFIGURATION SCREEN

1. Select the compatible built-in EDID for the selected input source.
2. Upload the user-defined EDID by following the steps below:
  - ◆ Prepare the EDID file (.bin) on the control computer.
  - ◆ Select the **User-defined** option.
  - ◆ Click the box `.bin`. Then select the EDID file (.bin) according to the tool tip.
  - ◆ Click **Apply** to upload the user-defined EDID. Then click **Confirm** to save the setting.

## CHAPTER 6: GUI CONTROL

### 6.4 CEC TAB

If the input source devices/output display devices support CEC, they can be controlled through the CEC interface. Use the Input and Output tabs on this tab to control supported devices.

#### 6.4.1 INPUT SOURCE DEVICE CONTROL

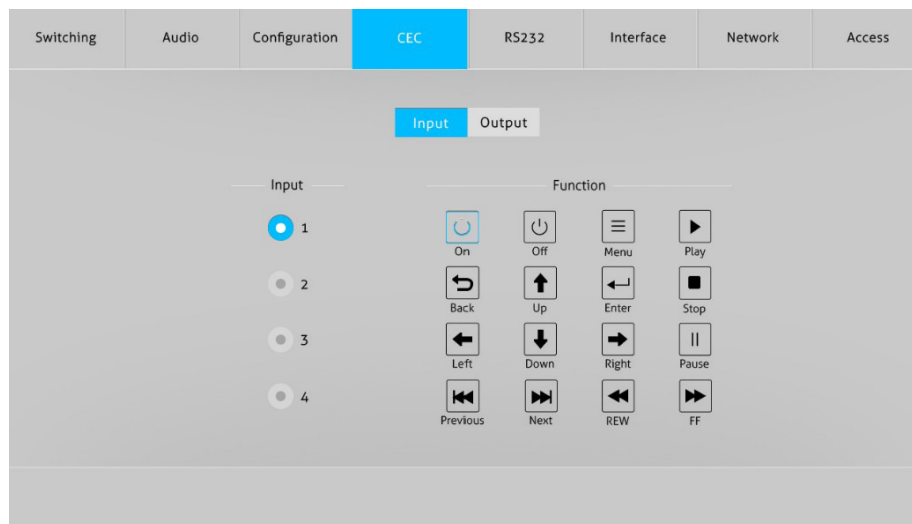

FIGURE 6-8: INPUT TAB SCREEN

To control an input device, select the Input tab if it is not already selected. After you select an input source device to be controlled, press the desired function button(s) to control it.

**NOTE:** Two or more input source devices cannot be controlled simultaneously.

## 6.4.2 OUTPUT DISPLAY DEVICE CONTROL

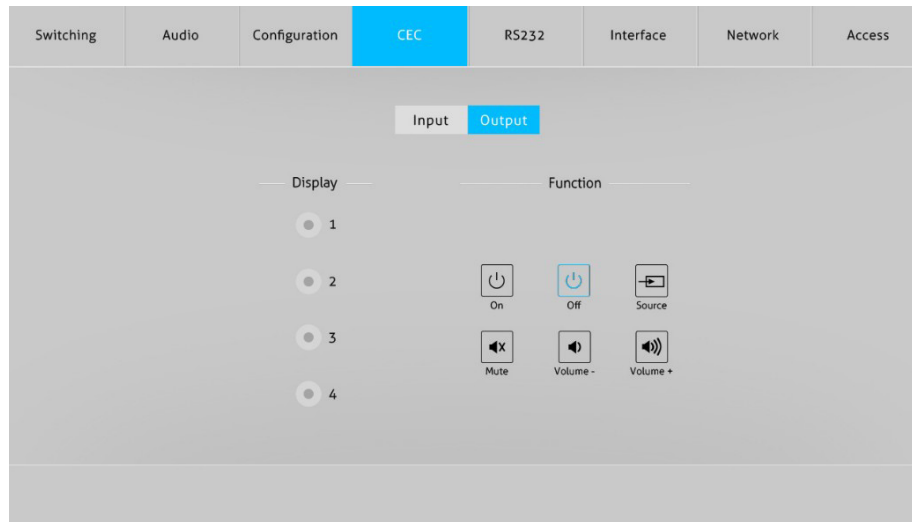

FIGURE 6-9: OUTPUT TAB SCREEN

To control an output device, select the Output tab if it is not already selected. After you select an output source device to be controlled, press the desired function button(s) to control it.

**NOTE:** Two or more output devices cannot be controlled simultaneously.

## 6.5 RS-232 TAB

You can set and modify ASCII and HEX values on the RS-232 tab. Use the ASCII and HEX buttons on this tab to view and modify these settings.

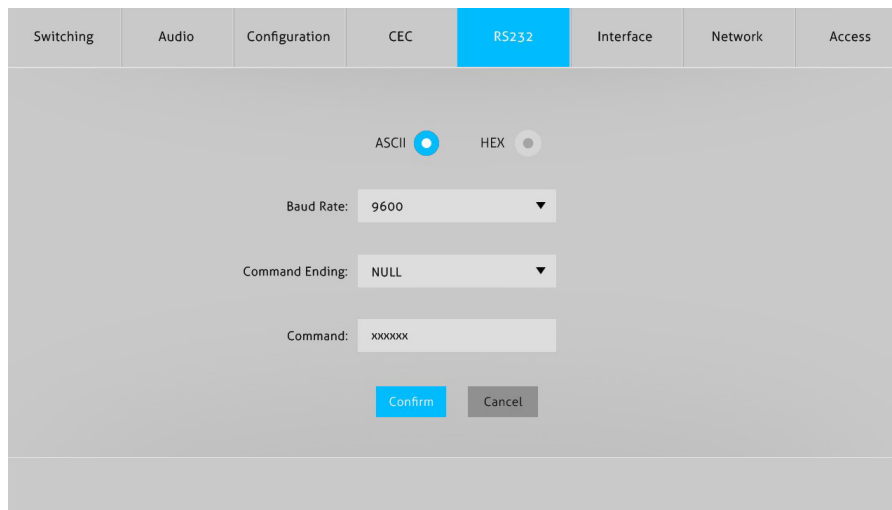

FIGURE 6-10: RS-232 TAB

- Baud Rate: Supports 2400, 4800, 9600, 19200, 38400, 57600, or 115200.
- Command Ending: NULL, CR, LF, or CR+LF can be chosen.
- Command: To control the third-party device that is connected to the switcher's RS-232 port, type the command in this box.

## CHAPTER 6: GUI CONTROL

### 6.6 INTERFACE TAB

You can set and modify the title bar label and the button labels on the Interface tab.

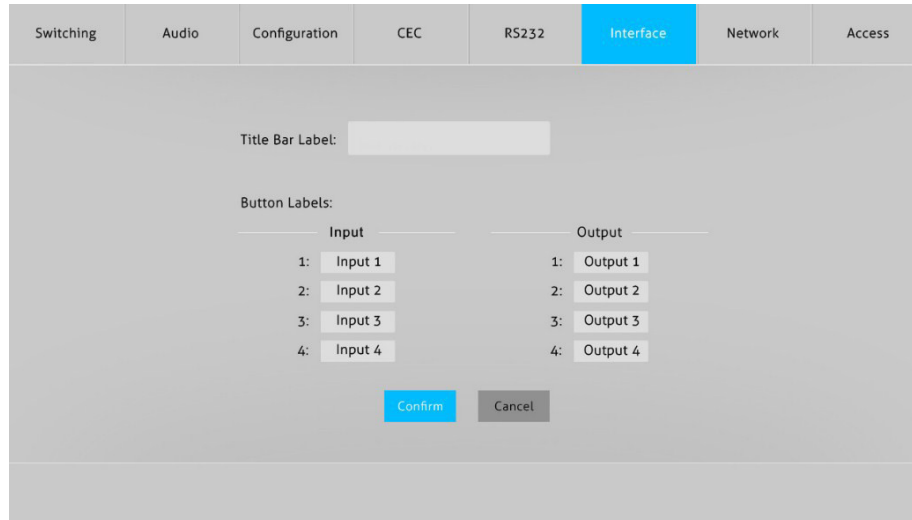

The screenshot shows the 'Interface' tab selected in a configuration menu. The menu items are: Switching, Audio, Configuration, CEC, RS232, Interface (highlighted), Network, and Access. The main content area has a 'Title Bar Label:' text box. Below it, 'Button Labels:' are organized into two columns: 'Input' and 'Output'. Each column has four numbered entries (1-4) with corresponding text boxes for 'Input 1-4' and 'Output 1-4'. At the bottom are 'Confirm' and 'Cancel' buttons.

FIGURE 6-11: INTERFACE TAB

To change label text, click in the corresponding box on this tab and edit the text.

### 6.7 NETWORK TAB

You can view and set Static IP or Dynamic Host Configuration Protocol (DHCP) settings on the Network tab.

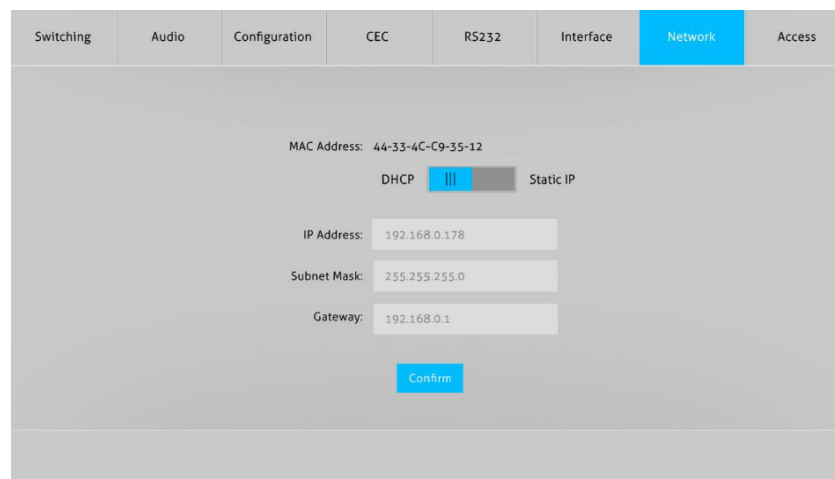

The screenshot shows the 'Network' tab selected in a configuration menu. The menu items are: Switching, Audio, Configuration, CEC, RS232, Interface, Network (highlighted), and Access. The main content area shows 'MAC Address: 44-33-4C-C9-35-12'. Below it, there are radio buttons for 'DHCP' (selected) and 'Static IP'. Underneath are text boxes for 'IP Address: 192.168.0.178', 'Subnet Mask: 255.255.255.0', and 'Gateway: 192.168.0.1'. A 'Confirm' button is at the bottom.

FIGURE 6-12: NETWORK TAB

To change a network setting, select either DHCP or Static IP. Then click in the IP Address, Submet Mask, or Gateway box on this tab and edit the text.

## 6.8 ACCESS TAB

You can set and modify the device's password and the front panel lock setting on the Access tab.

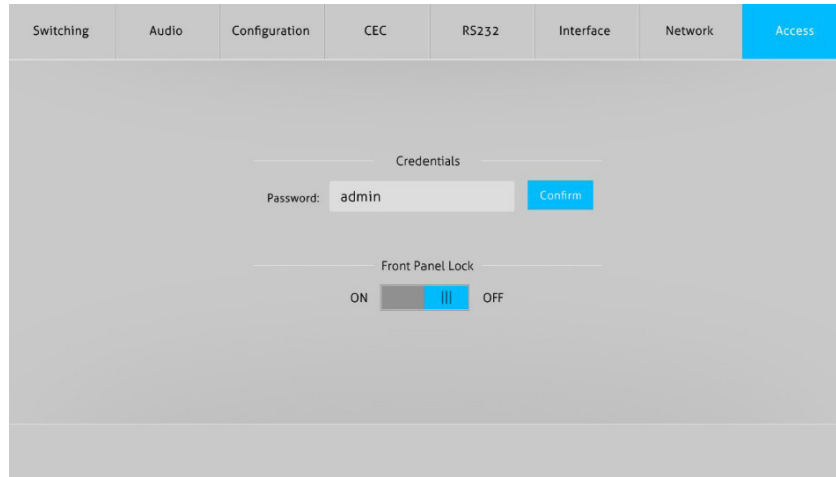

FIGURE 6-13: ACCESS TAB

- ◆ To change the switcher's password, click in the Password box and edit the text.
- ◆ To enable or disable the switcher's front panel lock, view the lock setting on this screen and change it, if necessary.

## CHAPTER 7: GUI UPGRADE

GUI updates are available online.

### 7.1 GUI UPGRADE PROCESS

Visit <http://192.168.0.178:100> to check for an available GUI online upgrade.

Type the username and password to log into the configuration interface.

**NOTE:** Use the same username and password that you used for the GUI log in. A modified password is available only after rebooting.

Then click on **Administration** in the source menu to get to Upgrade Firmware screen as shown below:

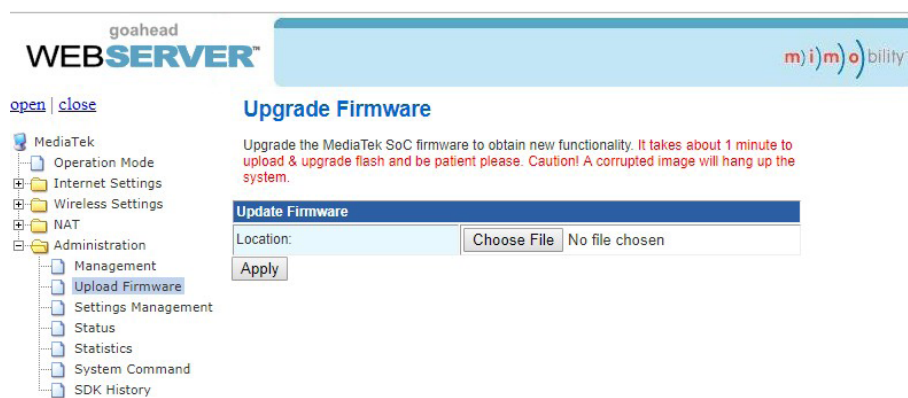

FIGURE 7-1: GUI UPDATE

Select the desired update file. Then click on **Apply**. The upgrade will then begin.

## CHAPTER 8: RS-232 CONTROL

You can use RS-232 control software with the HDMI matrix switcher.

### 8.1 INSTALLATION/UNINSTALLATION OF RS-232 CONTROL SOFTWARE

Installation: Copy the control software file to the control PC.

Uninstallation: Delete all the control software files in the corresponding file path.

### 8.2 BASIC SETTINGS

Connect the AVS-HDMI2-4X4-R2 with necessary input devices and output devices. Then, connect it to a PC with installed RS-232 control software. Double-click the software icon to run this software.

Here we show an example using the software **CommWatch.exe**.

The icon is shown next:



FIGURE 8-1: COMMWATCH ICON

The control software interface is shown next.

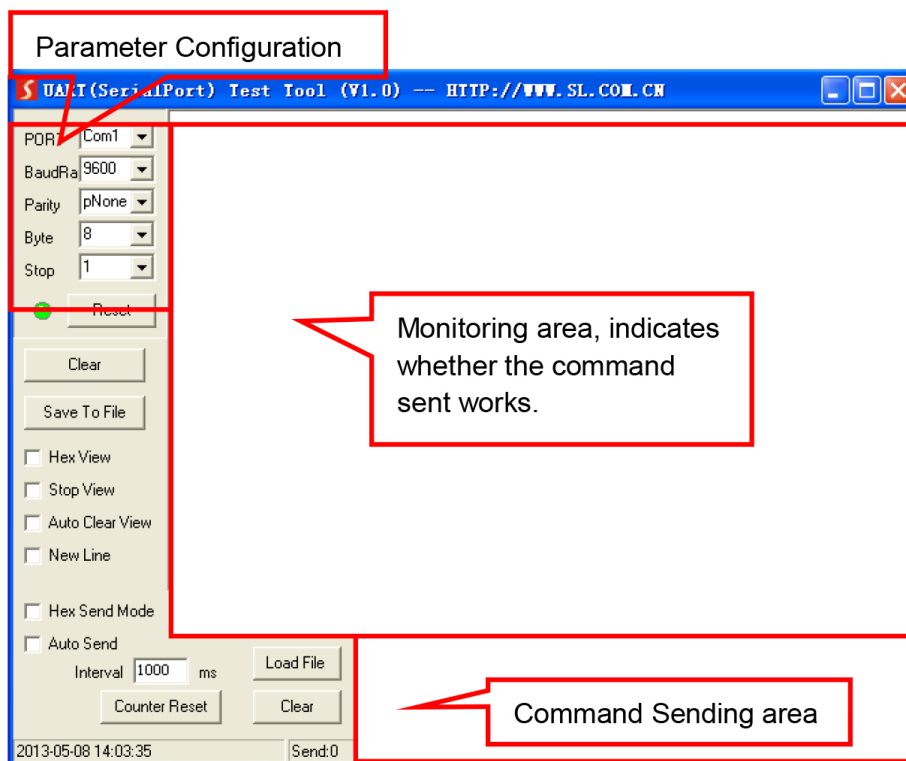

FIGURE 8-2 CONTROL INTERFACE

## CHAPTER 8: RS-232 CONTROL

Set the parameters (baud rate, data bit, stop bit, and parity bit) correctly to ensure reliable RS-232 control.

### 8.3 RS-232 COMMUNICATION COMMANDS

RS-232 commands are case-sensitive.

“[”, “]” in the commands are for easy recognition only and not necessary in real operations. Other symbols including “.”, “;”, “/”, “%”, “:”, “^” are parts of the commands

Feedback listed in the column “Feedback Example” are only for reference; feedback may vary according to different operations.

Baud rate: 9600

Data bit: 8

Stop bit: 1

Parity bit: None

#### 8.3.1 SYSTEM COMMANDS

TABLE 8-1. SYSTEM COMMANDS

COMMAND	FUNCTION	FEEDBACK EXAMPLE
POWERON.	Power on	Power ON!
POWEROFF.	Power off	Power OFF!
/*NAME.	Query the name of matrix	AVS-HDMI2-4X4-R2
/*TYPE.	Query the model of matrix	4X4
/^VERSION.	Query the firmware version	V1.0.0 CPLD:V1.0.0
RST.	Reset to factory default	Factory Default!





## 8.3.2 CONTROL MANAGEMENT

**TABLE 8-2. CONTROL MANAGEMENT**

COMMAND	FUNCTION	FEEDBACK EXAMPLE
<b>DS[XX]ON.</b>	Enable downscaling function for output device(s) [xx]=00 to 02 (xx=01 to 02 is the corresponding number of output 3 or 4 port. If xx=00, it means output on both output 3 and 4 ports.)	HDMI OUT xx Down Scale ON!
<b>DS[XX]OFF.</b>	Disable downscaling function for output device(s) [xx]=00 to 02 (xx=01 to 02 is the corresponding number of output 3 or 4 port. If xx=00, it means output on both output 3 and 4 ports.)	HDMI OUT xx Down Scale OFF!
<b>@OUT[XX].</b>	Enable HDMI 5V of output port [xx]=00 to 04 (xx=01 to 04 is the number of output port. If xx=00, it means all output ports.)	Turn ON Output 01! Turn ON Output 02! Turn ON Output 03! Turn ON Output 04!
<b>\$OUT[XX].</b>	Disable HDMI 5V of output port [xx]=00 to 04 (xx=01 to 04 is the number of output port. If xx=00, it means all output ports.)	Turn OFF Output 01! Turn OFF Output 02! Turn OFF Output 03! Turn OFF Output 04!
<b>OUT[XX]:[YY].</b>	Output port select input port [xx]=00 to 04 (xx=01 to 04 is the number of output port. If xx=00, it means all output ports.)  [YY]=01 to 04 (YY=01 to 04 is the number of input port.)	Output 01 Switch To In 04!

## 8.3.3 QUERY COMMANDS

**TABLE 8-3. QUERY COMMANDS**

COMMAND	FUNCTION	FEEDBACK EXAMPLE
GETGUIP.	Query GUI IP	GUI_IP:192.168.0.178!
SETGUIP:XXX.XXX .XXX.XXX.	Set GUI IP	SetGuiIP:192.168.0.178!
BAUDRATEXXXX.	Set the baud rate of local serial port xxxx=115200, 57600, 38400, 19200, or 9600	Baudrate9600. Set Local RS232 Baudrate Is 9600!
STA.	Query status	GUI Or RS232 Query Status: Black Box AVS-HDMI2-4X4-R2 V1.0.0 Power ON! Front Panel UnLock! Local RS232  Baudrate Is 9600! GUI_IP:192.168.0.178!
STA_POUT.	Query 5V status of output port	Turn ON Output 01! Turn ON Output 02! Turn ON Output 03! Turn ON Output 04!
STA_IN.	Query 5V status of input port	IN 1 2 3 4 LINK N N N N
STA_OUT.	Query HPD status of output	OUT 1 2 3 4 LINK N Y N N
STA_VIDEO.	Query the input source of output port	Output 01 Switch To In 01! Output 02 Switch To In 02! Output 03 Switch To In 03! Output 04 Switch To In 04!
STA_DS.	Query downscaling status	HDMI OUT 03 Down Scale ON! HDMI OUT 04 Down Scale ON!
STA_HDCP.	Query current using HDCP model of all output ports 01 to 04 represents corresponding output port 1 to 4.	OUT 01 HDCP BYPASS! OUT 02 HDCP BYPASS! OUT 03 HDCP BYPASS! OUT 04 HDCP BYPASS!
STA_AUDIO.	Query audio switch and volume status of analog audio	AUDIO Out 01 Switch To Video In 01! AUDIO Out 02 Switch To Video In 02! AUDIO Out 03 Switch To Video In 03! AUDIO Out 04 Switch To Video In 04!



**TABLE 8-3. QUERY COMMANDS CONTINUED**

COMMAND	FUNCTION	FEEDBACK EXAMPLE
PRESETSTA[XX].	Query the preset [xx]=01 to 09 (xx=01 to 09 is the number of preset.)	Preset 01 Sta: Out 01 In 01! Out 02 In 01! Out 03 In 01! Out 04 In 01!
PRESETSAVE[XX].	Save the preset	Preset 01 Sta: Out 01 In 01! Out 02 In 01! Out 03 In 01! Out 04 In 01!
PRESETRECALL[XX].	Preset recall	Preset 02 Recall: Output 01 Switch To In 02! Output 02 Switch To In 02! Output 03 Switch To In 02! Output 04 Switch To In 02!

### 8.3.4 LOCK/UNLOCK COMMANDS

**TABLE 8-4. LOCK/UNLOCK COMMANDS**

COMMAND	FUNCTION	FEEDBACK EXAMPLE
LOCK.	Lock the front panel buttons.	Front Panel Locked!
UNLOCK.	Unlock the front panel buttons.	Front Panel Unlock!

**CHAPTER 8: RS-232 CONTROL**

## 8.3.5 AUDIO COMMANDS

**TABLE 8-5. AUDIO COMMANDS**

COMMAND	FUNCTION	FEEDBACK EXAMPLE
<b>AUDIO[XX]:[YY].</b>	<p>SPDIF OUT and ANALOG OUT (They are same input audio source at one group.) Select the input audio source. [xx]=00 to 04 (xx=01 to 04 is the number of the output port. If xx=00, it means all output ports.)</p> <p>[yy]=01 to 08 (yy=01 to 04 means de-embedded audio from HDMI 1 to 4 input. If yy=05 to 08, it means de-embedded audio from HDMI 1 to 4 output.)</p>	AUDIO Out 01 Switch To Video In 04!
<b>AVOLUME[XX]:[YY].</b>	<p>[xx]=00 to 04 (xx=01 to 04 is the number of the Analog output port. If xx=00, it means all Analog output ports.)</p> <p>[YY]="V+" means volume up, YY]="V-" means volume down, [YY]="MU" means Mute, [YY]="UM" means UnMute, [YY]=00-100 means setting volume.</p>	Analog Out 01 Volume 61! Analog Out 02 Volume 61! Analog Out 03 Volume 61! Analog Out 04 Volume 61!



## 8.3.6 HDCP COMPLIANCE

**TABLE 8-6. HDCP COMPLIANCE**

COMMAND	FUNCTION	FEEDBACK EXAMPLE
<b>HDCP[XX]ON.</b>	Force enable the output HDCP 1.4 [xx]=00 to 04 (xx=01 to 04 is the number of output port. If xx=00, it means all output ports.)	OUT 01 HDCP ON! OUT 02 HDCP ON! OUT 03 HDCP ON! OUT 04 HDCP ON!
<b>HDCP[XX]OFF.</b>	Force disable the output HDCP [xx] =00 to 04 (xx=01 to 04 is the number of output port. If xx=00, it means all output ports.)	OUT 01 HDCP OFF! OUT 02 HDCP OFF! OUT 03 HDCP OFF! OUT 04 HDCP OFF!
<b>HDCP[XX]MAT.</b>	Output HDCP follows the display. [xx] =00 to 04 (xx=01 to 04 is the number of output port. If xx=00, it means all output ports.)	OUT 01 HDCP MAT Display! OUT 02 HDCP MAT Display! OUT 03 HDCP MAT Display! OUT 04 HDCP MAT Display!
<b>HDCP[XX]PAS.</b>	Output HDCP follows the value and status of input source device. [xx] =00 to 04 (xx=01 to 04 is the number of output port. If xx=00, it means all output ports.)	OUT 01 HDCP PASSIVE! OUT 02 HDCP PASSIVE! OUT 03 HDCP PASSIVE! OUT 04 HDCP PASSIVE!
<b>HDCP[XX]BYP.</b>	Output HDCP follows input HDCP. Input has HDCP, output is HDCP1.4. Input doesn't have HDCP; output is without HDCP.  [xx]=00 to 04 (xx=01 to 04 is the number of output port. If xx=00, it means all output ports.)	OUT 01 HDCP BYPASS! OUT 02 HDCP BYPASS! OUT 03 HDCP BYPASS! OUT 04 HDCP BYPASS!

## CHAPTER 8: RS-232 CONTROL

## 8.3.7 EDID MANAGEMENT

TABLE 8-7. EDID MANAGEMENT

COMMAND	FUNCTION	FEEDBACK EXAMPLE
EDIDMINIT.	Restore the factory default EDID data for each input	All Input EDID Set Default!
EDIDUPGRADE[XX].	<p>Upgrade EDID via Serial Port</p> <p>[XX]=00 to 04 (xx=01 to 04 is the number of input port (enable EDID user-defined for corresponding HDMI input). If the xx=00, it means all input ports (enable EDID user-defined for all HDMI inputs).</p> <p><b>NOTE: EDID user-defined can be used once. If you switch to another EDID or exit, it will not be saved.</b></p> <p>[XX]=U. (xx=U means user-defined for built-in EDID. It can be saved in machine for use at any time.)</p> <p><b>NOTE: It can user-defined. There is only one built-in EDID. After finishing it, machine still uses the previous built-in EDID.</b></p> <p>After it receives commands, the machine will remind EDID file (.bin) to send within 10 seconds.</p>	<p>Input XX/User Define EDID Upgrade OK By RS232 Or GUI!</p>
EDID/[XX]/[YY].	<p>Input ports xx use built-in EDID yy [xx]=00 to 04 (xx=01 to 04 is the number of the input port. If the xx=00, it means all input ports.)</p> <p>[yy]=01 to 09 (yy=01 to 08 means built-in EDID that cannot be user-defined. If the yy=09, it means user-defined EDID.)</p>	<p>Input 03 EDID Upgrade OK By 01 Internal EDID!</p>
EDIDGOUT[XX].	<p>Read and print EDID of HDMI output</p> <p>[XX]=01 to 04 is the number of the output port.</p>	<p>EDIDOUT04: .....</p>
EDIDM[XX]B[YY].	<p>Input port [yy] follows the EDID from output port [xx].</p> <p>[xx]=01 to 04 (xx=01 to 04 is the number of the output port.)</p> <p>[yy]=00 to 04 (yy=01 to 04 is the number of input port. If yy=00, it means all input ports.)</p>	<p>Input 01 EDID Upgrade OK By 04 EXT EDID!</p>
/+[X]/[YY]:XXX.	<p>Send serial data to local</p> <p>[X]= 1--2400; 2--4800; 3--9600; 4--19200; 5--38400; 6--57600; 7--115200.</p> <p>[yy] means the output port that sent serial data. yy=01 means local output.</p>	<p>xxx.</p>



**TABLE 8-7. EDID MANAGEMENT CONTINUED**

COMMAND	FUNCTION	FEEDBACK EXAMPLE
EDIDSTA[XX].	<p>Query EDID status of Input port</p> <p>[xx]=00 to 04 (xx=01 to 04 is the number of input port. If xx=00, it means all input ports.)</p> <p><b>NOTE:</b></p> <ul style="list-style-type: none"> <li>◆ If built-in EDID09 is not user-defined, when querying it, the input port will use EDID6 Internal EDID instead. For example, send "EDID/03/09.", "EDIDSTA03." produces "Input 03 EDID From 06 Internal EDID!".</li> <li>◆ If built-in EDID09 has been user-defined, when querying it, the input port will use the user-defined EDID. For example, send "EDID/03/09.", "EDIDSTA03." produces "Input 03 EDID From User Define EDID!".</li> <li>◆ If you directly user-define the port EDID, when querying it, the input port will use the user-defined EDID. For example, send "EDIDSTA03." produces "Input 3 EDID From User Define EDID!".</li> </ul>	<p>Input 01 EDID From 01 Internal EDID!</p> <p>Input 02 EDID From 01 Internal EDID!</p> <p>Input 03 EDID From 01 Internal EDID!</p> <p>Input 04 EDID From 01 Internal EDID!</p>

### 8.3.8 CEC CONTROL

If the input sources and output devices support CEC, they can be controlled by sending the following command instead of IR remote.

CEC[I/O][AA][BB][CC][DD].

The "[I]" represents the input port. The "[O]" represents the output port.

The "[AA]" represents the port number. The HDMI input ports are 01 to 04. The HDMI output ports are 01 to 04.

The "[AA]" is "FF" for sending command to all input or output ports.

The "[BB]" represents the device type, such as TV: 40/20/80; Blu-ray DVD: 04/08.

The "[CC]" represents the CEC function type, such as "44": Remote control.

The “[DD]” represents the specific command from the next table.

**TABLE 8-8. CONTROL FOR INPUT SOURCE**

COMMAND	DESCRIPTION	COMMAND EXAMPLE AND RESPONSE
CECI[AA][BB][CC]00.	Confirm operation (Enter)	CECI02044400 CEC Input 02 Send Success!
CECI[AA][BB][CC]01.	UP direction	CECI01044401. CEC Input 01 Send Success!
CECI[AA][BB][CC]02.	DOWN direction	CECI01044402. CEC Input 01 Send Success!
CECI[AA][BB][CC]03.	LEFT direction	CECI03044403. CEC Input 03 Send Success!
CECI[AA][BB][CC]04.	RIGHT direction	CECI03044404. CEC Input 03 Send Success!
CECI[AA][BB][CC]09.	Return to submenu	CECI03044409. CEC Input 03 Send Success!
CECI[AA][BB][CC]0A.	Enter main menu	CECI0304440A. CEC Input 03 Send Success!
CECI[AA][BB][CC]0D.	Exit menu	CECI0204440D. CEC Input 02 Send Success!
CECI[AA][BB][CC]6D.	Power on	CECI0204446D. CEC Input 02 Send Success!
CECI[AA][BB][CC]6C.	Power off	CECI0204446C. CEC Input 02 Send Success!



TABLE 8-9. CONTROL FOR OUTPUT DISPLAY DEVICE

COMMAND	DESCRIPTION	COMMAND EXAMPLE AND RESPONSE
CECO[AA][BB][CC]41.	Volume up	CECO04404441. CEC Output 05 Send Success!
CECO[AA][BB][CC]42.	Volume down	CECO04404442. CEC Output 05 Send Success!
CECO[AA][BB][CC]43.	Mute	CECO04404443. CEC Output 05 Send Success!
CECO[AA][BB]04.	Power on	CECO038004. CEC Output 03 Send Success!
CECO[AA][BB]36.	Power off	CECO038036. CEC Output 03 Send Success!

## CHAPTER 9: FIRMWARE UPGRADE

The matrix switcher has a FIRMWARE port on the switcher's rear panel for firmware upgrades.

Follow these steps to upgrade the firmware:

1. Prepare the latest upgrade file and rename it to "08010000.APP" on a computer.
2. Power off the switcher.
3. Connect the firmware port of switcher to the computer via USB cable.
4. Power on the switcher. The PC will automatically detect a U-disk named "BOOTDISK."
5. Double-click on the U-disk. A file named "READY.TXT" will appear.
6. Copy the latest upgrade file (08010000.APP (.bin)) to the "BOOTDISK" U-disk.
7. Reopen the U-disk to determine if the filename "READY.TXT" changed to "SUCCESS.TXT." If the filename changed, the firmware updated successfully. Otherwise, the firmware update failed. In that case, confirm the name of upgrade file (.bin) again, and then follow the above steps to perform update process again.
8. Remove the USB cable after upgrading the firmware.
9. Restore the switcher to factory default by sending the factory reset command. See Table 8-1 for the reset command.



**TABLE 10-1. PROBLEMS/CAUSES/SOLUTIONS**

PROBLEM	POTENTIAL CAUSE	SOLUTION
Losing color or no video signal output	<ol style="list-style-type: none"> <li>1. The cables may not be connected correctly or may be broken.</li> <li>2. Failed or loose connection</li> </ol>	<ol style="list-style-type: none"> <li>1. Check whether the cables are connected correctly and are in working condition.</li> <li>2. Make sure the connection is secure.</li> </ol>
No output image when switching	<ol style="list-style-type: none"> <li>1. No signal at the input/output end</li> <li>2. Failed or loose connection</li> <li>3. Input source is HDCP but the HDCP compliance is switched off.</li> <li>4. The display doesn't support the input resolution.</li> </ol>	<ol style="list-style-type: none"> <li>1. Check with an oscilloscope or multimeter if there is any signal at the input/output end.</li> <li>2. Make sure the connection is secure.</li> <li>3. Send command <code>/%[Y]/[X]:[1]</code>. or change the HDCP compliance status in GUI.</li> <li>4. Switch for another input source or enable the display to learn the EDID data of the input.</li> </ol>
Cannot control the device via front panel buttons	Front panel buttons are locked.	Send command <code>/%Unlock</code> or select unlock in GUI interface to unlock.
Cannot control the device via IR remote	<ol style="list-style-type: none"> <li>1. The battery is depleted.</li> <li>2. The IR remote is broken.</li> <li>3. Beyond the effective range of the IR signal or not pointing at the IR receiver</li> <li>4. The IR receiver connected to IR In port is not with a carrier.</li> </ol>	<ol style="list-style-type: none"> <li>1. Replace the battery.</li> <li>2. Contact Black Box Technical Support at 877-877-2269 or <a href="mailto:info@blackbox.com">info@blackbox.com</a>.</li> <li>3. Adjust the distance and angle and point right at the IR receiver.</li> <li>4. Replace with an IR receiver with carrier.</li> </ol>
Power Indicator remains off when powered on	Failed or loose power connection	Check whether the cables are connected correctly.
EDID management does not work normally	The HDMI cable is broken at the output end.	Replace with another HDMI cable that is in good working condition.
There is a blank screen on the display when switching.	The display does not support the resolution of the video source.	<ol style="list-style-type: none"> <li>1. Switch again.</li> <li>2. Manage the EDID data manually to make the resolution of the video source automatically compliant with the output resolution.</li> </ol>
Cannot control the device by control device, such as a PC, through RS-232 port	<ol style="list-style-type: none"> <li>1. Wrong connection</li> <li>2. Wrong RS-232 communication parameters</li> <li>3. Broken RS-232 port</li> </ol>	<ol style="list-style-type: none"> <li>1. Verify that there is a secure connection between the control device and the unit.</li> <li>2. Type in the correct RS-232 communication parameters: Baud rate: 9600; Data bit: 8; Stop bit: 1; Parity bit: none.</li> <li>3. Contact Black Box Technical Support at 877-877-2269 or <a href="mailto:info@blackbox.com">info@blackbox.com</a>.</li> </ol>

## APPENDIX A: REGULATORY INFORMATION

### A.1 FCC STATEMENT

This equipment has been tested and found to comply with the regulations for a Class B digital device, pursuant to Part 15 of the FCC Rules. These limits are designed to provide reasonable protection against harmful interference when the equipment is operated in a commercial environment. This equipment generates, uses, and can radiate radio frequency energy and, if not installed and used in accordance with this Quick Installation Guide, may cause harmful interference to radio communications. Operation of this equipment in a residential area is likely to cause harmful interference in which case, the user will be required to correct the interference at his/her own expense.

### A.2 CE STATEMENT

This is a Class B product in a domestic environment, this product may cause radio interference, in which case the user may be required to take adequate measures.

### A.3 ROHS

This product is RoHS compliant.



## APPENDIX A: REGULATORY INFORMATION

### A.4 NOM STATEMENT

1. Todas las instrucciones de seguridad y operación deberán ser leídas antes de que el aparato eléctrico sea operado.
2. Las instrucciones de seguridad y operación deberán ser guardadas para referencia futura.
3. Todas las advertencias en el aparato eléctrico y en sus instrucciones de operación deben ser respetadas.
4. Todas las instrucciones de operación y uso deben ser seguidas.
5. El aparato eléctrico no deberá ser usado cerca del agua—por ejemplo, cerca de la tina de baño, lavabo, sótano mojado o cerca de una alberca, etc.
6. El aparato eléctrico debe ser usado únicamente con carritos o pedestales que sean recomendados por el fabricante.
7. El aparato eléctrico debe ser montado a la pared o al techo sólo como sea recomendado por el fabricante.
8. Servicio—El usuario no debe intentar dar servicio al equipo eléctrico más allá a lo descrito en las instrucciones de operación. Todo otro servicio deberá ser referido a personal de servicio calificado.
9. El aparato eléctrico debe ser situado de tal manera que su posición no interfiera su uso. La colocación del aparato eléctrico sobre una cama, sofá, alfombra o superficie similar puede bloquea la ventilación, no se debe colocar en libreros o gabinetes que impidan el flujo de aire por los orificios de ventilación.
10. El equipo eléctrico deber ser situado fuera del alcance de fuentes de calor como radiadores, registros de calor, estufas u otros aparatos (incluyendo amplificadores) que producen calor.
11. El aparato eléctrico deberá ser conectado a una fuente de poder sólo del tipo descrito en el instructivo de operación, o como se indique en el aparato.
12. Precaución debe ser tomada de tal manera que la tierra física y la polarización del equipo no sea eliminada.
13. Los cables de la fuente de poder deben ser guiados de tal manera que no sean pisados ni pellizcados por objetos colocados sobre o contra ellos, poniendo particular atención a los contactos y receptáculos donde salen del aparato.
14. El equipo eléctrico debe ser limpiado únicamente de acuerdo a las recomendaciones del fabricante.
15. En caso de existir, una antena externa deberá ser localizada lejos de las líneas de energía.
16. El cable de corriente deberá ser desconectado del cuando el equipo no sea usado por un largo periodo de tiempo.
17. Cuidado debe ser tomado de tal manera que objetos líquidos no sean derramados sobre la cubierta u orificios de ventilación.
18. Servicio por personal calificado deberá ser provisto cuando:
  - A: El cable de poder o el contacto ha sido dañado; u
  - B: Objetos han caído o líquido ha sido derramado dentro del aparato; o
  - C: El aparato ha sido expuesto a la lluvia; o
  - D: El aparato parece no operar normalmente o muestra un cambio en su desempeño; o
  - E: El aparato ha sido tirado o su cubierta ha sido dañada.

## APPENDIX B: DISCLAIMER/TRADEMARKS

### B.1 DISCLAIMER

Black Box Corporation shall not be liable for damages of any kind, including, but not limited to, punitive, consequential or cost of cover damages, resulting from any errors in the product information or specifications set forth in this document and Black Box Corporation may revise this document at any time without notice.

### B.2 TRADEMARKS USED IN THIS MANUAL

Black Box and the Black Box logo type and mark are registered trademarks of Black Box Corporation.

Any other trademarks mentioned in this manual are acknowledged to be the property of the trademark owners.



**NEED HELP?  
LEAVE THE TECH TO US**

---

**LIVE 24/7  
TECHNICAL  
SUPPORT**

---

**1.877.877.2269**

