

**Panasonic**  
ideas for life

**PT-LB75NTU**  
**PT-LB75U**  
LCD Projectors



**Elegant Styling, All-Round Versatility**



# Style, Features and Convenience

Panasonic's new LCD projectors—PT-LB75NTU and PT-LB75U—are ideal for anyone who wants an easy-to-use projector but doesn't want to compromise on image quality and performance. The highly advanced dust-resistant design minimizes image degradation by reducing the entry of dust into the unit. The design includes “gapless” touch-sensor controls on the top panel and an airtight structure that

concentrates the air intake into a single location. Panasonic's original Daylight View 4 feature provides bright, crisp images even in brightly lit conditions. The PT-LB75NTU also include an easy-to-use wireless function. In short, the PT-LB75NTU and PT-LB75U incorporate the unique essence and versatility of Panasonic projector technologies while maintaining an elegant design.



# Dust-Resistant Design and Full-Featured Performance



## Dust-Resistant Structure Minimizes Image Degradation

After a projector has been used for some time, dust particles that have entered the interior accumulate on the optical components and lower performance. The PT-LB75NTU/LB75U prevents this with a unique dust-resistant design. This totally redesigned package has touch-sensor controls that eliminate the gaps around conventional buttons and a lens cover. The design also incorporates a cover that protects the zoom/focus ring when not in use. These features combine to help reduce dust entry. Inside the projector, the airflow is efficiently controlled by a structure that reduces contact between external air and the optical components. This all works together with the high-performance Micro Cut Filter to minimize image degradation.



Touch-sensor controls on the top



A zoom/focus ring cover and a lens cover

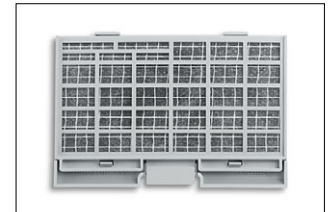

Micro Cut Filter

## Daylight View 4 Offers Clear, Crisp Images Even in Bright Surroundings\*2

The PT-LB75NTU/LB75U features Panasonic's Daylight View 4 technology. Sharp edges are achieved with the new "Edge Enhancer Control" and "Gamma Curve Control." Remarkable detail is provided and perceived brightness and contrast are enhanced, so images appear crisp, vivid, 3-dimensional and easy to see even in brightly lit rooms. Daylight View 4 also includes a built-in ambient light sensor that automatically detects room brightness and adjusts operation accordingly.

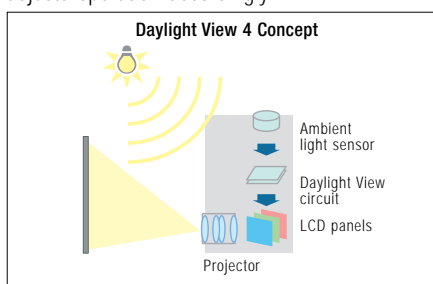

### Daylight View 4



Simulated image with Daylight View 4 turned off. Overall contrast appears lower, and images in dark areas cannot be seen.



Simulated image with Daylight View 4 turned on. Detail, depth, brightness and contrast over the entire image are enhanced.



<sup>2</sup> There is no actual change in the rated brightness or contrast ratio.



# Versatile Wireless Presentation

## Easy Wireless Projection

With the wireless capability of the PT-LB75NTU, you don't need cables to connect a PC, either Windows® or Mac®. That means it's easy to bring in a laptop (with a wireless LAN function) and deliver a smooth, hassle-free presentation. You can make the connection settings quickly and easily using the supplied Wireless Manager ME 5.0 software. When the presentation is finished, Wireless Manager restores the PC to its previous LAN settings, so the PC is ready to reconnect to your LAN.

## Easy Wireless Projection

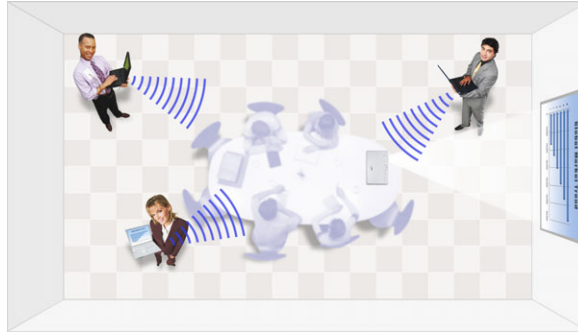

## Multi Live Mode: Wireless Projection from Multiple PCs

The PT-LB75NTU provides a host of convenient wireless functions, including Live mode and Multi-Live mode. In Live mode, the image projected is identical to the image seen on the PC screen. In Multi-Live mode, you can wirelessly connect with multiple PCs.

Other wireless functions include Wireless Prompter (Secondary Display Transmission), selective area transmission, and a 16-window index style that lets you project images from up to 16 PCs at the same time. Wireless transmission is possible from one PC to a maximum of eight projectors at a time.

## Wireless Manager Control Panel (Launcher)



To begin wireless projection, simply use the control panel (launcher) displayed in the PC window.

## Virtual Remote Control

The same graphics used on the projector's remote control can be displayed on the PC screen. This makes it easy to operate the projector right from the PC, without having to use the remote control.



## Multi Live Mode

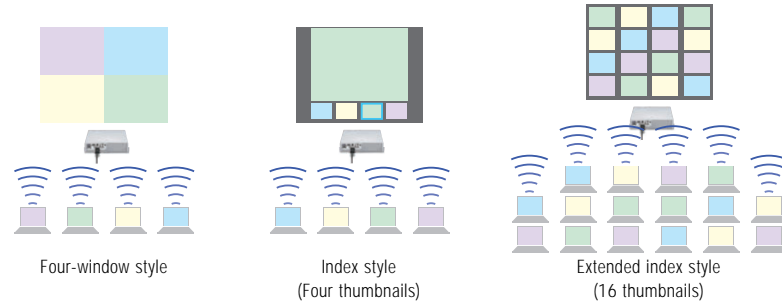

## Selective Area Transmission

By circling any area of the image, you can specify the necessary information to enlarge and display that area on the projection screen.

## Selective Area Transmission



## Projector Signal Map



## Projector Signal Map

The signal map graphically shows the strength of wireless connection signals. This is convenient, for example, when several projectors are being used in adjacent school classrooms because it lets the user know which projector is to be used.

## Extended Mac OS X Compatibility

In addition to its Windows Vista® compatibility, Wireless Manager ME 5.0 is fully compatible with Mac OS X 10.4/10.5.\*<sup>3</sup>

## Extended Mac OS X Compatibility

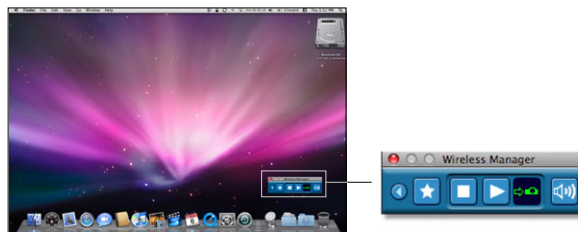

<sup>3</sup> Except for the Wireless Prompter (Secondary Display Transmission) function.

To use wireless functions, a PC is required that meets the conditions given below.

### Windows

OS: Microsoft® Windows® 2000 Professional, Windows® XP Professional, Windows® XP Home Edition, Windows® XP Tablet PC Edition, Windows Vista™ Ultimate 32-bit, Windows Vista™ Business 32-bit, Windows Vista™ Home Premium 32-bit, Home Basic 32-bit  
 CPU: Intel® Pentium® III 800 MHz or higher, or other compatible processor (1 GHz or higher is recommended when using Live mode)  
 Memory: 256 MB or more  
 Free hard disk space: 60 MB or more  
 Hardware conditions: CD-ROM drive or DVD drive (for software installation and viewing the user's manual)  
 Web browser: Internet Explorer 6.0 or later, or Netscape Communicator 7.0 or later.

### Mac

OS: Apple Mac OS X 10.4 and OS X 10.5  
 CPU: 1-GHz or higher PowerPC G4, or 1.8-GHz or higher Intel® Core™ processor.  
 Memory: 256 MB or more (512 MB or high is recommended)  
 Free hard disk space: 60 MB or more  
 Hardware conditions: CD-ROM drive or DVD drive (for software installation and viewing the user's manual). Built-in IEEE 802.11b/g wireless LAN adapter must be installed and running normally.  
 Web browser: Safari 2.0 or later

# Ease of Use

## Elegant, Compact Design

The PT-LB75NTU/LB75U has a sleek and elegant appearance that matches its high-performance capabilities. The projector blends well with virtually any room interior, whether it is placed on a desktop or mounted on the ceiling. At 2.96 kg, its light weight and compact design also make it easy to move around.



## Quiet Operation

The PT-LB75NTU/LB75U's operating noise is reduced to 29 dB,\*<sup>4</sup> which minimizes noise interruptions during meetings or lectures.

## Quick Operation

- **Three-Second Speed Start:** With Speed Start, the image appears in about three seconds after you press the power button.
- **Auto Search:** When a source is connected and you switch the unit on, it automatically detects what kind of source is connected and begins projection.
- **Real-Time Keystone Correction:** The projector automatically senses if you adjust its angle (vertical direction) during operation and instantly makes whatever keystone correction is necessary for optimum viewing.
- **Direct Power Off:** Because the cooling fan keeps operating until the lamp is cooled, you can disconnect the power cable and move the projector as soon as your presentation is finished, or turn off the room's main power when the unit is mounted on the ceiling.

## Ceiling-Installation Capability

The projector can be permanently installed on the ceiling by using the optional ET-PKB80 ceiling mount bracket.

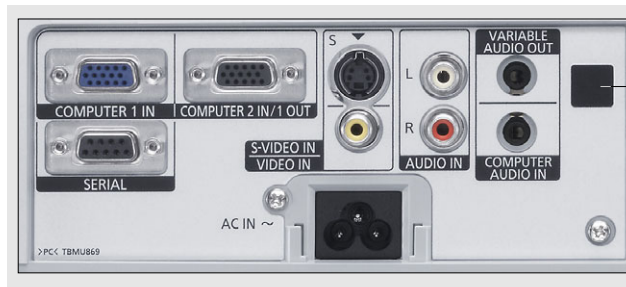

Two remote control receptors are located on both the front and back for a wider operation range.

Equipped with two computer (RGB) inputs. The computer (RGB) 2 IN can be switched to computer (RGB) 1 OUT for loop-through monitoring.

## Abundant Connection Terminals

Designed for versatility, each projector comes equipped with a host of connection terminals. The RS-232C specifications are the same as in previous Panasonic models, so replacement is quick and easy.

## Easy Lamp Replacement from the Rear

For easier maintenance, you can replace the lamp from the rear. The lamp is easily replaced even after the projector is installed on the ceiling.

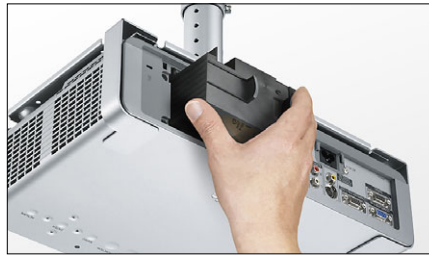

## Easy-to-Use Remote Control

The control range and distance have been extended compared to previous models, and the buttons are now larger and easier to use.



PT-LB75NTU



PT-LB75U

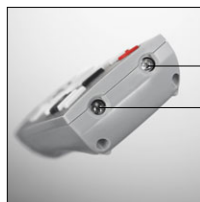

Equipped with two transmitters for an extended remote control range.

## Other Valuable Features

- Anti-theft features: Security anchor, user password, control panel lock and text superimposing
- Index Window
- Auto power off
- HDTV compatibility
- Picture mode selection (standard/dynamic/natural)
- Blackboard mode allows you to project images onto an ordinary classroom or conference room blackboard
- 3x digital zoom
- AV mute
- Selectable 17-language on-screen menu
- Closed caption decoder built-in



Security anchor



A soft carrying bag is supplied.

## Optional Accessories



Optional replacement lamp unit: ET-LAB80



Optional ceiling mount bracket: ET-PKB80



All PT-LB75 Series projectors are carefully manufactured at the Panasonic factory in Japan, under strict quality control. This is another, very important advantage of a Panasonic projector.

## Ecology-Conscious Design

Panasonic works from every angle to minimize environmental impact in the product design, production and delivery processes, and in the performance of the product itself over its life cycle. The PT-LB75 Series reflects the following ecological considerations.

- Lead-free solder is used to mount components to the printed circuit boards.
- No halogenated flame retardants are used in the cabinet.
- No styrofoam is used in the packing materials.
- Lead-free glass is used for the lens.

**Specifications** (The specifications and design are subject to change without notice as product development proceeds.)

Models		PT-LB75NTU		PT-LB75U	
Power supply		100–240 V AC, 50/60 Hz			
Power consumption		300 W (Approx. 4 W in standby mode with fan stopped)			
LCD panel	Panel size	0.63" (16 mm) diagonal, 4:3 aspect ratio			
	Display method	Transparent LCD panel (x 3, R/G/B)			
	Drive method	Active matrix			
	Pixels	1,024 x 768 (x 3)			
Lens		Manual zoom (1:1–1:1.2), manual focus, F 1.65–1.93, f 18.53–22.18 mm			
Throw ratio		1.4–1.7:1			
Lamp		220 W UHM™ lamp			
Projection size (diagonally)		33–300 inches (4:3 aspect ratio)			
Colors		Full color (16,777,216 colors)			
Brightness*1		2,600 lumens			
Center-to-corner uniformity*1		85 %			
Contrast ratio*1		500:1 (full on /full off)			
Resolution (RGB)		1,024 x 768*2			
Scanning frequency	RGB	Horizontal: 15–91 kHz, Vertical: 50–85 Hz			
	YPbPr	480i (525i): fr 15.75 kHz; fv 60 Hz 480p (525p): fr 31.5 kHz; fv 50 Hz	576i (625i): fr 15.63 kHz; fv 60 Hz 576p (625p): fr 31.25 kHz; fv 50 Hz	720p (750p): fr 45.00 kHz; fv 60 Hz 720p (750p): fr 37.50 kHz; fv 50 Hz	1080i (1125i): fr 33.75 kHz; fv 60 Hz 1080i (1125i): fr 28.13 kHz; fv 50 Hz
	S-Video/Video	NTSC, NTSC4.43, PAL-M, PAL60: fr 15.75 kHz; fv 60 Hz PAL, SECAM, PAL-N: fr 15.63 kHz; fv 50 Hz			
Optical axis shift		5:1 (fixed)			
Keystone correction range		Vertical: ±30°			
On-screen menu		17 languages: English, French, German, Spanish, Italian, Korean, Russian, Chinese, Japanese, Swedish, Norwegian, Danish, Portuguese, Polish, Hungarian, Czech, and Thai			
Installation		Front/rear ceiling/desk (menu selection)			
Built-in speakers		1.0 W (monaural) output power			
Terminals	COMPUTER 1 IN	D-sub HD 15-pin x 1			
	COMPUTER 2 IN/1 OUT	D-sub HD 15-pin x 1 (input/output selectable using on-screen menu)			
	VIDEO IN	RCA pin x 1			
	S-VIDEO IN	Mini DIN 4-pin x 1			
	AUDIO IN	RCA (L-R) x 1 (for VIDEO/S-VIDEO)			
	COMPUTER AUDIO IN	M3 (stereo) x 1			
	VARIABLE AUDIO OUT	M3 (stereo) x 1			
	SERIAL	D-sub 9-pin x 1 (RS-232C)			
Power cord length		2 m (6'7")			
Cabinet material		Molded plastic (PC+ABS)			
Dimensions*3 (W x H x D)		368 x 88 x 233 mm (14-1/2" x 3-15/32" x 9-3/16")			
Weight		2.96 kg (6.5 lbs.)			
Operation environment	Temperature	0°–40°C (32°–104°F)			
	Humidity	20%–80% (no condensation)			
Wireless LAN	Standard	IEEE802.11b/g			
	Operation range*4	Approx. 30 m (98'5")			
	Infrastructure mode	WPA-PSK (TKIP/AES), 128/64-bit WEP			
	Ad-hoc mode	128/64-bit WEP			
Wireless remote control unit	Power supply	3 V DC (AA battery x 2)			
	Operation range*4	Approx. 15 m (49'3" feet) when operated from directly in front of the signal receptor			
	Dimensions (W x H x D)	48 x 163 x 24.5 mm (1-7/8" x 6-13/32" x 31/32")			
	Weight	117 g (4.2 oz) (including batteries)			
Supplied accessories		Power cord, power cord secure lock, wireless remote control, batteries for remote control, VGA cable, carrying bag, Wireless Manager ME 5.0 (CD-ROM)		Power cord, power cord secure lock, wireless remote control, batteries for remote control, VGA cable, carrying bag	
Optional accessories		ET-LAB80 Replacement lamp unit, ET-PKB80 Ceiling mount bracket			

\*1: Measurement, measuring conditions, and method of notation all comply with ISO 21118 international standards.

\*2: Input signals that exceed this resolution will be converted to 1,024 x 768 pixels.

\*3: Protruding parts are not included. \*4: Operation range differs depending on the environment.

**PT-LB75NTU/LB75U Projection Distance (4:3)**

Project size (diagonal)	Projection distance (L)		Height from the edge of screen to center of lens (H)
	Min (wide)	Max (telephoto)	
0.84 m / 33"	- / -	1.1 m / 3.7'	0.08 m / 0.28'
1.02 m / 40"	1.1 m / 3.7'	1.4 m / 4.5'	0.10 m / 0.33'
1.52 m / 60"	1.7 m / 5.6'	2.1 m / 6.8'	0.15 m / 0.50'
2.03 m / 80"	2.3 m / 7.6'	2.8 m / 9.1'	0.20 m / 0.67'
2.54 m / 100"	2.9 m / 9.5'	3.5 m / 11.4'	0.25 m / 0.83'
3.81 m / 150"	4.3 m / 14.3'	5.2 m / 17.1'	0.38 m / 1.25'
5.08 m / 200"	5.8 m / 19.0'	7.0 m / 22.9'	0.51 m / 1.67'
7.62 m / 300"	8.7 m / 28.6'	10.5 m / 34.4'	0.76 m / 2.50'

**Dimensions**

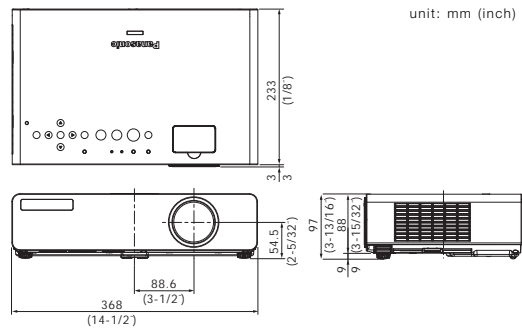

**NOTES ON USE**

- The projector uses a high-voltage mercury lamp that contains high internal pressure. This lamp may break, emitting a large sound, or fail to illuminate, due to impact or extended use. The length of time that it takes for the lamp to break or fail to illuminate varies greatly depending on individual lamp characteristics and usage conditions.
- The brightness of the lamp will gradually decrease with use.
- The projector includes consumable parts. The frequency of replacement for the lamp and other consumable parts will increase if the projector is subjected to extended, continuous use. For details, please consult a service representative.



Panasonic Projector Systems Company,  
Unit of Panasonic Corporation of North America  
www.panasonic.com/projectors

**Headquarters**  
3 Panasonic Way, 4B-9  
Secaucus, NJ 07094  
888-411-1996

**Panasonic Canada Inc.**  
5770 Ambler Drive  
Mississauga, Ontario  
Canada L4W 2T3  
905 624 5010

Projectors Global Web Site: <http://panasonic.net/pavc/projector>

Please contact Panasonic or your dealer for a demonstration.



Weights and dimensions shown are approximate. Specifications are subject to change without notice. Product availability differs depending on region and country. This product may be subject to export control regulations. UHM is a trademark of Matsushita Electric Industrial Co., Ltd. Intel and Pentium are registered trademarks of Intel Corporation. Windows is either a registered trademark or trademark of Microsoft Corporation in the United States and/or other countries. All other trademarks are the property of their respective trademark owners. Projection images simulated. (C) 2006 Panasonic Projector Systems Company is a Unit Company of Panasonic Corporation of North America. All rights reserved. (C) 2006 Matsushita Electric Industrial Co., Ltd. All rights reserved.

All information included here is valid as of March 2008.