

HP Photosmart M425/M525

Digital Camera



User Guide



Legal and notice information

© Copyright 2006 Hewlett-Packard
Development Company, L.P.

The information contained herein is
subject to change without notice. The
only warranties for HP products and
services are set forth in the express
warranty statements accompanying
such products and services. Nothing
herein should be construed as
constituting an additional warranty.
HP shall not be liable for technical or
editorial errors or omissions contained
herein.

Windows® is a U.S. registered
trademark of Microsoft Corporation.



SD Logo is a trademark of its
proprietor.

Contents

1	Getting started	5
	Camera top and back	5
	Camera front, side, and bottom.....	6
	Camera dock insert.....	6
	Before taking pictures.....	6
	Using your camera.....	9
2	Taking pictures and recording video clips	11
	Taking still pictures.....	11
	Recording video clips.....	12
	Instant Review.....	12
	Auto focus and exposure.....	12
	Using zoom.....	14
	Setting the flash.....	15
	Using the shooting modes.....	15
	Using the Capture Menu.....	17
3	Reviewing images and video clips	20
	Deleting images.....	21
	Viewing thumbnails.....	21
	Magnifying images.....	21
4	Using the Design Gallery Menu	22
	Removing red eyes.....	22
	Modifying colors.....	23
	Adding borders.....	23
	Recording audio.....	23
5	Transferring and printing images	25
	Transferring images with HP Photosmart Software.....	25
	Transferring images without HP Photosmart Software.....	25
	Printing images from the camera.....	26
6	Using HP Photosmart Express	28
	Using the Photosmart Express Menu.....	28
	Setting up online destinations in the camera.....	28
	Sending images to online destinations.....	29
	Selecting images for printing.....	29
	Buying prints online.....	30
7	Using the Setup Menu	31
8	Troubleshooting	32
	Resetting the camera.....	32
	Problems and solutions.....	32
9	Product support	36
	Helpful websites.....	36
	Getting assistance.....	36
A	Managing batteries	38
	Top points about batteries.....	38
	Extending battery life.....	38
	Safety precautions for using batteries.....	38







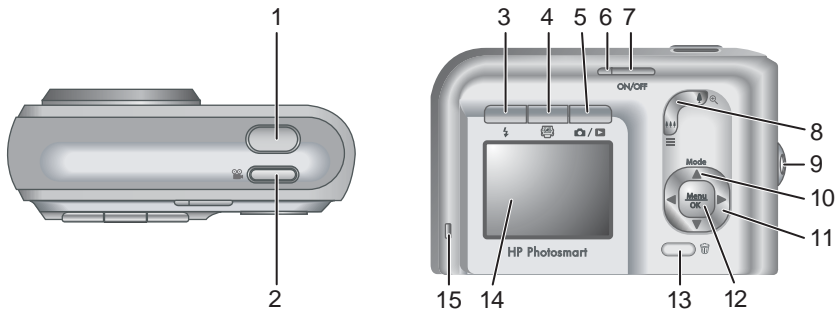

Power indicators.....	39
Number of shots per battery type.....	39
Battery performance.....	40
Recharging NiMH batteries.....	40
Safety precautions for recharging batteries.....	41
B Specifications	42
Memory capacity.....	43
Image quality.....	44
Index	45

1 Getting started

Use this section to get familiar with camera controls, set up your digital camera for use, and begin taking pictures.

Camera top and back



1	Shutter button.
2	 Video button.
3	 Flash button—See <i>Setting the flash</i> on page 15.
4	 Photosmart Express button—See <i>Using HP Photosmart Express</i> on page 28.
5	 Live View/Playback button—Switches between Live View and Playback (see <i>Taking pictures and recording video clips</i> on page 11 and <i>Reviewing images and video clips</i> on page 20).
6	Power light.
7	ON/OFF button.
8	Zoom lever—See <i>Using zoom</i> on page 14.
9	Wrist strap mount.
10	Mode button—Press  to access the Shooting Mode menu while in Live View (see <i>Using the shooting modes</i> on page 15).
11	 and  buttons—Scrolls through menus and images.
12	 button—Displays camera menus, selects options, and confirms actions.
13	 Delete button—Accesses the Delete function while in Playback (see <i>Deleting images</i> on page 21).

(continued)

14	Image Display.
15	Battery Charging light.

Camera front, side, and bottom

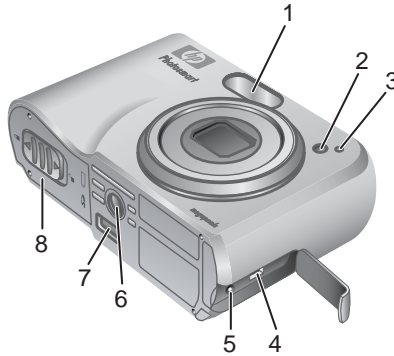

1	Flash.
2	Self-Timer light (see <i>Using the Self-Timer mode</i> on page 16).
3	Microphone.
4	USB connector.
5	Power adapter connector.
6	Tripod mount.
7	Dock connector.
8	Battery/Memory card door.

Camera dock insert

If you purchase a dock, it will come with multiple clear inserts. When setting up an optional dock for use with this camera, use the dock insert with the square green tag. See the dock User Guide for instructions.

Before taking pictures

Complete the following procedures before taking pictures or recording video clips.

Install the batteries

1. Open the Battery/Memory card door by sliding the latch as indicated on the Battery/Memory card door.
2. Insert the batteries.
3. Close the Battery/Memory card door.



Note Turn the camera off before removing the batteries. If using rechargeable NiMH batteries, fully charge the batteries before using them the first time (see [Charge the batteries on page 7](#)).



Charge the batteries

You can charge batteries in the camera using an optional AC power adapter, in the extra battery bay of an optional HP Photosmart camera dock or wireless dock base, or in an optional HP Photosmart quick recharger.

Connect the optional AC power adapter to the camera, then plug it in to an electrical outlet. If you are using a camera dock or wireless dock base, plug in the dock, then dock the camera.

The camera's blinking Battery Charging light indicates that the battery is charging (if you are charging in an optional HP Photosmart Premium dock or wireless dock base, the dock's Battery Charging light blinks). The battery is fully charged when the Battery Charging light turns on solid (approximately 12–15 hours).

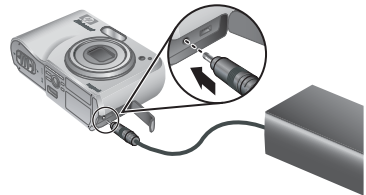

Turn on the camera

To turn on the camera, press the ON/OFF button.

Choose the language

Use ▲▼◀▶ to choose the language you want, then press $\frac{\text{Menu}}{\text{OK}}$.

To change the language later, use the **Setup** menu (see [Using the Setup Menu on page 31](#)).





Set the region

Along with the **Language** setting, the **Region** setting determines the default date format and the format of the video signal for displaying camera images on a television when connected through an optional HP Photosmart Premium dock or wireless dock base (see *Using the Setup Menu on page 31*).

Use ▲▼ to choose the region you want, then press .



Set the date and time

1. Use ▲▼ to adjust the highlighted value.
2. Use ◀▶ to move to the other selections and repeat Step 1 until the date and time are set correctly.
3. Press  when the date, time, and format settings are correct, then press  again to confirm.

To change the date and time later, use the **Setup Menu** (see *Using the Setup Menu on page 31*).

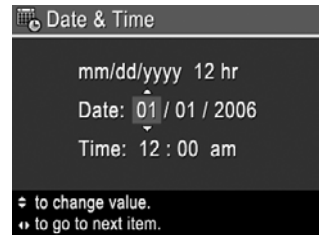





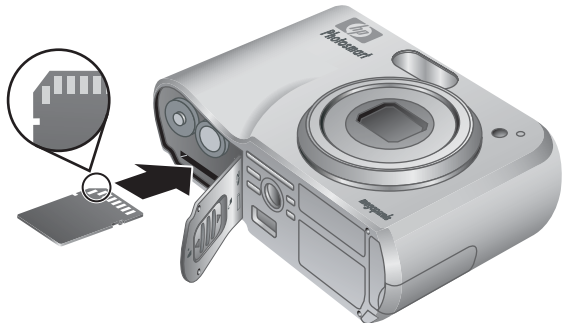

Install and format an optional memory card

1. Turn off the camera and open the Battery/Memory card door.
2. Insert the memory card in the smaller slot as shown. Make sure the memory card snaps into place.
3. Close the Battery/Memory card door and turn on the camera.



Always format memory cards before first use.

1. With the camera turned on, press  /  until  appears briefly in the upper right corner of the Image Display. This indicates you are in **Playback**.
2. Press .
3. Use ▲▼ to select **Format Card**, then press .
4. Use ▲▼ to select **Yes**, then press  to format the card.



Note Once you install a memory card, all new images and video clips are stored on the card, rather than in internal memory. To use internal memory and view images stored there, remove the memory card. To transfer images from internal memory to an optional memory card, see **Move Images to Card** under *Using the Design Gallery Menu on page 22*.

For information about supported memory cards, see *Storage on page 43*.

Install the software

The HP Photosmart Software provides features for transferring images and video clips to your computer, as well as features for modifying stored images (remove red eyes,

rotate, crop, resize, adjust image quality, add colors and special effects, and more). See [About the HP Photosmart Software on page 9](#).



Note If you have trouble installing or using the HP Photosmart Software, see the HP Customer Care website for more information: www.hp.com/support.

Windows

If your Windows computer does not meet the system requirements as stated on your camera packaging, HP Photosmart Essential is installed (see [About the HP Photosmart Software on page 9](#)).

1. Close all programs and temporarily disable any virus protection software.
2. Insert the HP Photosmart Software CD into the CD drive and follow the on-screen instructions. If the installation screen does not appear, click **Start**, click **Run**, type **D:\Setup.exe**, where **D** is the letter of your CD drive, then click **OK**.
3. When the software has finished installing, re-enable virus protection software.

Macintosh

1. Insert the HP Photosmart Software CD into the CD drive.
2. Double-click the CD icon on the computer desktop.
3. Double-click the installer icon, then follow the on-screen instructions.

About the HP Photosmart Software

The CD that came with your camera contains the following versions of HP Photosmart Software:

- HP Photosmart Premier Software (for Windows XP and XP x64 systems with at least 128 MB of RAM). This version of the software includes some extra features that let you use **Photosmart Express** to e-mail images to addresses you specify, create online albums, and automatically print selected images when you connect your camera to your computer. See [Using HP Photosmart Express on page 28](#).
- HP Photosmart Essential Software (for Windows 98, 98SE, Me, and 2000 systems, and for Windows XP systems with less than 128 MB of RAM). This version does not have the extra features specified in HP Photosmart Premier Software.
- HP Photosmart Mac Software (for Macintosh systems).

To learn more about the software features and how to use them, see the **Help** feature in the HP Photosmart Software.

Using your camera

Now that you've completed setup, you can take and review still images and video clips.

For information on taking still pictures and capturing video clips	See Taking still pictures on page 11 and Recording video clips on page 12
For information on reviewing images and video clips on the camera	See Reviewing images and video clips on page 20

(continued)

For information on enhancing your images	See <i>Using the Design Gallery Menu</i> on page 22
For information on transferring images from your camera to a computer	See <i>Transferring images with HP Photosmart Software</i> on page 25
For information on printing images	See <i>Printing images from the camera</i> on page 26



Tip To switch between **Live View** and **Playback**, press  / .

2 Taking pictures and recording video clips

Live View allows you to frame pictures and video clips in the Image Display. To activate **Live View**, press / until appears briefly in the upper right corner of the Image Display. The **Live View** display looks like this:

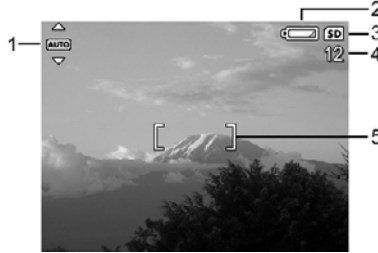

1		Shooting mode indicator.
2		Battery level indicator (see Power indicators on page 39).
3		Memory card indicator.
4	12	Pictures remaining count.
5		Focus brackets (see Auto focus and exposure on page 12).

Taking still pictures

You can take a picture almost any time the camera is on, regardless of what is shown on the Image Display.

1. Press / until appears briefly in the upper right corner of the Image Display. This indicates you are in **Live View**.
2. Frame the subject for your picture.
3. Press the **Shutter** button halfway down to measure and lock the focus and exposure. The focus brackets in the Image Display turn solid green when focus is locked (see [Auto focus and exposure](#) on page 12).
4. Press the **Shutter** button all the way down to take the picture.
5. To add an audio clip, continue holding the **Shutter** button down, then release it when done.

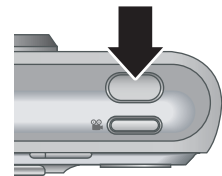

Recording video clips

1. Press / until appears briefly in the upper right corner of the Image Display. This indicates you are in **Live View**.
2. Frame the subject.
3. Press and release the **Video** button.
4. To stop recording video, press and release the **Video** button again.

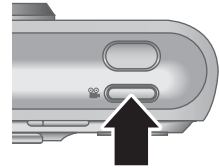

Instant Review

After you have taken a still image or recorded a video clip, the camera displays it briefly in **Instant Review**. If you want to delete the image or video clip, press , select **This Image** from the **Delete** sub-menu, then press .



Note To hear audio associated with still images or video clips, transfer them to your computer using the HP Photosmart Software or use an optional HP Photosmart dock to connect the camera to a TV.

Auto focus and exposure

When you press the **Shutter** button halfway down, the camera automatically measures and locks the focus and exposure. When you auto focus:

Indicator	Description
Green focus brackets	Focus found.
Red focus brackets	Focus not found (see Optimizing focus on page 13).
(shaking hand icon)	Long exposure required (see Optimizing exposure on page 13).



Tip If you follow the suggestions for focus and exposure and your image does not appear to be in proper focus or exposure when viewed in **Playback**, see the topics on blurry, dark, light, or grainy images in [Troubleshooting on page 32](#).

Focusing on the subject

When you press the **Shutter** button halfway down, the camera searches for focus within the focus brackets. When it finds focus, the focus brackets turn green.

If the focus brackets do not frame your subject, use **Focus Lock** (see [Using Focus Lock on page 13](#)).





Optimizing focus

When the camera cannot auto focus, the focus brackets turn red. This indicates the picture may be out of focus because the subject is out of the focus range or the scene has low contrast.

If the camera is set to a shooting mode (see [Using the shooting modes on page 15](#)) other than  **Macro** and cannot focus, it will still take the picture. Try releasing the **Shutter** button, reframing, and then pressing the **Shutter** button halfway down again. If the focus brackets are still red:

- Select a shooting mode more appropriate for the scene you are capturing (see [Using the shooting modes on page 15](#)).
- If the scene has low contrast, use **Focus Lock** (see [Using Focus Lock on page 13](#)) and aim at a point on the subject that has more colors or crisp edges.
- If the subject is too close (less than 500 mm or 20 in), move farther away from the subject or use  **Macro** (see **Macro** under [Using the shooting modes on page 15](#)).

If the camera is set to  **Macro** and cannot focus, the camera will not take the picture. Try one of the following:

- Move within the  **Macro** range or set the camera to  **Auto** (see **Auto** under [Using the shooting modes on page 15](#)).
- In low contrast scenes, use **Focus Lock** (see [Using Focus Lock on page 13](#)).

Using Focus Lock

Use **Focus Lock** to focus on a subject that is not in the center of the picture, to capture action shots more quickly by pre-focusing in the area where the action will occur, or to focus in low light or low contrast situations.

1. Frame the subject for your picture within the focus brackets. In low light or low contrast situations, frame a brighter or higher contrast object.
2. Press the **Shutter** button halfway down.
3. Hold the **Shutter** button halfway down and re-frame.
4. Press the **Shutter** button all the way down to take the picture.



Optimizing exposure

When you press the **Shutter** button halfway down, the camera also measures the light level to set the proper exposure.

If the camera is set to a shooting mode other than **Fast Shot** (see **Fast Shot** under [Using the shooting modes on page 15](#)) and determines the scene will require a very long

exposure, a shaking hand icon (👉) appears. The camera will take the picture, but it may be blurry because it is difficult to hold the camera still for the length of time required. Try one of the following:

- Set the flash to **Auto Flash** or **Flash On** (see *Setting the flash on page 15*).
- Set the camera on a tripod or stable surface.
- Turn on more light.

If the camera is set to **Fast Shot** and determines there is not enough light, the message **NOT ENOUGH LIGHT FOR FAST SHOT** appears in the Image Display and the camera will not take the picture. Try one of the following:

- Select a different shooting mode (see *Using the shooting modes on page 15*).
- Turn on more light.

Using zoom

Your camera has both optical and digital zoom. Optical zoom physically extends the lens to make the subject of your picture appear closer. After you have extended the lens fully using optical zoom, the camera employs digital zoom. Digital zoom uses no moving lens parts.



Tip The more you zoom in on the subject of your picture, the more small movements of the camera are magnified (this is called camera shake). If 👉 appears when you press the **Shutter** button halfway down, the picture may be blurry. Be sure to hold the camera still or add more light to the scene. Try holding the camera closer to your body or against a steady object, or set the camera on a tripod or stable surface.

Optical zoom

Optical zoom moves the lens between wide angle (1x) and telephoto (3x).

In **Live View**, use the buttons on the **Zoom lever** to control zoom. Press 📏 to zoom in and 📏📏📏 to zoom out.



Digital zoom

In digital zoom, the Image Display shows a yellow frame around the scene.





1. In **Live View**, press 📏 on the **Zoom lever** to optically zoom to the maximum level, then release the lever.
2. Press and hold 📏 until the image you want to capture fills the yellow frame. If you zoom in too far, press 📏📏📏.
3. To return to optical zoom, press 📏📏📏 until digital zooming stops. Release 📏📏📏, then press it again.







Note 1 Digital zoom is not available when recording video clips.

Note 2 Digital zoom reduces the resolution of an image, so your picture may be more grainy than the same picture taken with optical zoom. When you need higher quality, limit the use of digital zoom.

Setting the flash

To select a flash setting, press , use   to highlight the desired flash mode, then press .

	Auto Flash (Default)—The camera uses the flash if necessary.
	Red-Eye —The camera uses the flash with red-eye reduction, if necessary, to minimize the possibility of human eyes appearing red in the final image. For information about red-eye, see Red eye on page 15 .
	Flash On —The camera always uses flash. If the light is behind your subject, use this setting to increase the light on the front of your subject.
	Flash Off —The camera does not use flash. Use this setting to capture poorly lit subjects beyond the flash range or to capture scenes with the existing light.

The **Flash** setting remains in effect until it is changed again, or you turn off the camera.







Note The flash is not available in **Burst**, **Fast Shot**, **Landscape**, or **Sunset** shooting modes, nor while recording video clips. In **Night Portrait** shooting mode, the flash is set to  **Red-Eye**.



Red eye

The red-eye phenomenon is caused when light from the flash reflects off the subjects' eyes, which can make human eyes appear red in the captured image. Using  **Red-Eye** causes the camera to flash quickly up to three times to shrink the subject's pupils (reducing the effect of the red-eye phenomenon) before using the main flash and capturing the image. Since it takes longer to take a picture using this setting, make sure your subjects wait for the additional flashes.









Using the shooting modes

Shooting modes are predefined settings for everyday situations. They are optimized for particular types of scenes or shooting situations.

To select a shooting mode, press  while in **Live View**, use   to highlight a shooting mode, then press .

	Auto Mode (Default)—For taking good shots quickly, when you do not have time to select a special shooting mode.
	Self-Timer —For capturing images or recording video after a 10-second delay (see Using the Self-Timer mode on page 16).
	Fast Shot —For taking images more quickly than in Auto mode in bright light conditions when the subject is a moderate to long distance away.

(continued)

	Landscape —For scenes with deep perspective, such as mountain scenes.
	Portrait —For pictures that have one or more people as their primary subject.
	Action —For capturing sporting events, moving cars, or any scene where you want to stop the action.
	Night Portrait —For capturing images of people at night. This mode uses the flash and a long exposure. As a result, you must set the camera on a tripod or stable surface.
	Beach and Snow —For capturing scenes against bright backgrounds such as at the beach or in snow.
	Sunset —For capturing outdoor scenes at sunset.
	Burst —For taking two or more shots quickly in succession (see <i>Using the Burst mode on page 17</i>).
	Macro —For taking close-up pictures of subjects between 100 and 800 mm (3.9 to 31.5 in) away.









Note The shooting modes do not apply when you are recording video clips.

The shooting mode remains in effect until it is changed again, or until you turn off the camera.

Using the Self-Timer mode

The Self-Timer allows you to take an image or video clip 10 seconds after pressing the **Shutter** or  **Video** button.

1. Press  while in **Live View**, use  to highlight  **Self-Timer**, then press .
2. Set the camera on a tripod or stable surface.
3. Frame the subject in the Image Display.
4. The next steps depend on whether you are taking a still pictures or recording a video clip.
 - a. For still pictures, press the **Shutter** button halfway down to lock focus and exposure. When the focus brackets turn green, press the **Shutter** button all the way down.
 - b. For video clips, press the  **Video** button, then release it.
5. The camera begins the 10-second countdown, then takes the still image or begins recording the video clip.
6. If you are recording a video clip, press the  **Video** button to stop recording.



Tip If you want to include yourself in the picture, press the **Shutter** button all the way down, then place the camera on a tripod or stable surface. The camera locks focus and exposure just before the end of the countdown, allowing you time to place yourself in the scene.



Note To add audio to images taken with the **Self-Timer** setting, see [Recording audio on page 23](#).

The **Self-Timer** setting resets to the default **Auto** shooting mode after the picture or video clip is taken.

Using the Burst mode

Burst allows you to take two or more pictures as quickly as possible when you press and hold the **Shutter** button all the way down.

1. Press **▲** while in **Live View**, use **▲▼** to highlight  **Burst**, then press **Menu**/**OK**.
2. Frame the subject, then press the **Shutter** button halfway down to lock the focus and exposure. Then press the **Shutter** button all the way down and hold it. The camera takes pictures as quickly as possible until you release the **Shutter** button or the camera runs out of memory.

The Image Display remains off during the burst capture. After the burst images have been taken, each image appears one at a time in **Instant Review** (see [Instant Review on page 12](#)). You can delete the entire burst sequence in **Instant Review**. To delete individual images, see [Deleting images on page 21](#).



Note To add audio to images taken with the **Burst** setting, see [Recording audio on page 23](#).



The **Burst** setting remains in effect until it is changed again, or until it resets to the default **Auto** shooting mode when you turn off the camera.

Using the Capture Menu





The **Capture Menu** allows you to adjust camera settings that affect the characteristics of the images and video clips you capture.

1. While in **Live View** or **Playback**, press **Menu**/**OK**, then use **◀▶** to highlight .
2. Use **▲▼** to highlight a menu option, then press **Menu**/**OK** to display the menu option's sub-menu.
3. Use **▲▼** to highlight a setting, then press **Menu**/**OK**.
4. Press **Camera**/**Play** to exit the **Capture Menu**.

For on-camera information about an option, use **▲▼** to highlight **Help...** in the option's sub-menu, then press **Menu**/**OK**.

	<p>Shooting Modes—For selecting a shooting mode. For information about shooting modes and another way to select them, see Using the shooting modes on page 15.</p>
	<p>Image Quality—Sets resolution and compression for images. The greater the number, the higher the resolution.</p> <p>M525:</p> <ul style="list-style-type: none"> ● 6MP Best—For enlarging or printing images greater than 28 x 36 cm (11 by 14 in). ● Normal (6MP) (Default)—For printing images up to 28 x 36 cm (11 by 14 in).

(continued)

	<ul style="list-style-type: none"> • 4MP—For printing images up to 20 x 25 cm (8 by 10 in). • 2MP—For printing images up to 13 x 18 cm (5 by 7 in). • VGA—For sending images via e-mail or posting them to the Internet. <p>M425:</p> <ul style="list-style-type: none"> • 5MP Best—For enlarging or printing images greater than 28 x 36 cm (11 by 14 in). • Normal (5MP) (Default)—For printing images up to 28 x 36 cm (11 by 14 in). • 3MP—For printing images up to 20 x 25 cm (8 by 10 in). • 1MP—For printing images up to 10 x 15 cm (4 by 6 in). • VGA—For sending images via e-mail or posting them to the Internet.
	<p>Date & Time Imprint—Imprints date in lower left corner of image.</p> <ul style="list-style-type: none"> • Off (Default)—No date or time imprinted on the image. • Date Only—Date permanently imprinted. • Date & Time—Date and time permanently imprinted.
	<p>Exposure Compensation—Overrides the camera's automatic exposure setting. For more information, see Exposure Compensation on page 18.</p> <ul style="list-style-type: none"> • To make the images you are about to capture brighter, press ▶ to increase the value. • To make the images you are about to capture darker, press ◀ to decrease the value.
	<p>White Balance—Balances color based on lighting conditions. For more information, see White Balance on page 19.</p> <ul style="list-style-type: none"> • Auto (Default)—Corrects for scene illuminance. For general picture taking. • Sun—For outdoor scenes in sunny or cloudy conditions. • Shade—For outdoor scenes in shade or at dusk. • Tungsten—For indoor scenes with incandescent or halogen lighting. • Fluorescent—For indoor scenes with fluorescent lighting.
	<p>ISO Speed—Adjusts the camera's sensitivity to light. For more information, see ISO speed on page 19.</p> <ul style="list-style-type: none"> • Auto (Default)—Camera selects the best ISO speed for scene. • ISO 100—For best quality. • ISO 200—For lower light conditions. • ISO 400—For lower light conditions and/or action when short shutter speeds are desired.



Note Some **Capture Menu** options are not available in certain shooting modes. In addition, some do not apply when recording video clips.

Exposure Compensation

You can use **Exposure Compensation** to override the camera's automatic exposure setting. **Exposure Compensation** is useful in scenes that contain many light objects (like a white object against a light background) or many dark objects (like a black object against a dark background). Such scenes could turn out gray without the use of **Exposure Compensation**. For a scene with many light objects, increase the **Exposure**

Compensation to a positive number. For a scene with many dark objects, decrease the **Exposure Compensation**.

White Balance

Different lighting conditions cast different colors. This setting allows the camera to compensate for this, reproducing colors more accurately and ensuring that whites appear white in the final image. You can also adjust the white balance to produce creative effects. For example, the **Sun** setting produces a warmer look to the image.

ISO speed

This setting adjusts the sensitivity of the camera to light. When **ISO Speed** is set to the default **Auto** setting, the camera selects the best ISO speed for the scene.

Lower ISO speeds capture images with the least amount of grain (or noise), but result in slower shutter speeds. If taking a picture in low light conditions without a flash at **ISO 100**, use a tripod.

Higher ISO numbers allow faster shutter speeds, and can be used when taking pictures in dark areas without a flash, or when taking pictures of fast moving objects. Higher ISO speeds produce pictures with more grain (or noise) and, therefore, can be of lower quality.

3 Reviewing images and video clips

You can review and manipulate images and video clips in **Playback** as described here. For information about enhancing images, see [Using the Design Gallery Menu on page 22](#).

1. Press / until appears briefly in the upper right corner of the Image Display.
2. Use to scroll through your images and video clips (video clips play automatically).
When viewing video clips, press to pause the clip, then use to scroll through the individual frames.
3. To switch to **Live View**, press / .



During **Playback**, the Image Display also indicates additional information about each image or video clip.









1		Battery indicator (see Power indicators on page 39).
2		Memory card indicator.
3	1	Number of electronic Photosmart Share destinations (see Using HP Photosmart Express on page 28).
4	3	Number of images to print (see Transferring and printing images on page 25).
5	0:15 	<ul style="list-style-type: none"> • Recorded length of this audio or video clip. • Audio clip attached. • Video clip indicator.
6	1 of 30	Number of this image or video clip out of the total number of stored images and video clips.

Deleting images

To delete a displayed image during **Playback**:

1. Press .
2. Use   to select an option, then press $\frac{\text{Menu}}{\text{OK}}$.
 - **Cancel**—Returns to **Playback** without deleting the displayed image.
 - **This Image**—Deletes the image or video clip.
 - **All Images (in Memory/on Card)**—Deletes all stored images and video clips.
 - **Format (Memory/Card)**—Deletes all stored files, then formats the internal memory or memory card.









Viewing thumbnails

1. While in **Playback**, press  **Thumbnails** to view thumbnails.
2. Use   and   to scroll through the thumbnails.
3. Press  /  to exit **Thumbnails**.



Magnifying images

This feature is for viewing purposes only; it does not permanently alter the image.







1. While in **Playback**, press  (same as **Zoom In**  on the **Zoom** lever). The currently displayed image is magnified 2x.
2. Use   and   to pan around the magnified image.
3. Use  and  to change the magnification.
4. Press $\frac{\text{Menu}}{\text{OK}}$ to return to **Playback**.



4 Using the Design Gallery Menu

You can use the **Design Gallery** features to enhance your captured images.

1. While in **Playback**, use ◀▶ to scroll to an image, then press $\frac{\text{Menu}}{\text{OK}}$.
2. Use ◀▶ to highlight the  **Design Gallery Menu** tab.
3. Use ▲▼ to highlight an option, then press $\frac{\text{Menu}}{\text{OK}}$ and follow the on-screen instructions.

	Remove Red Eyes —See Removing red eyes on page 22 .
	Modify Color —See Modifying colors on page 23 .
	Add Borders —See Adding borders on page 23 .
	Rotate —Rotates images in 90-degree increments. Use ◀▶ to rotate the image clockwise or counter-clockwise in 90-degree increments. Press $\frac{\text{Menu}}{\text{OK}}$ to save the image in the new orientation.
	Record Audio —See Recording audio on page 23 .
	Move Images to Card —Moves images from internal memory to a memory card. Available only if there are images in internal memory and a memory card is inserted. To move images, select this option and follow the on-screen prompts.

Removing red eyes

When you select  **Remove Red Eyes**, the camera processes the current still image to remove red eyes from the subjects.

 **Note** To prevent red eyes in images, see **Red-Eye** under [Setting the flash on page 15](#).









The red-eye removal process takes a few seconds, after which the image displays with green boxes around corrected areas, along with the **Remove Red Eyes** sub-menu:

- **Save Changes** (Default)—Overwrites the original image and returns to the **Design Gallery Menu**.
- **View Changes**—Displays a magnified view of the image with green boxes around the corrected areas.
- **Cancel**—Returns to the **Design Gallery Menu** without saving the red eye changes.

 **Remove Red Eyes** is only available for still images taken with a flash.









Modifying colors

 **Modify Color** allows you to apply color schemes to the displayed image. To modify colors:

1. Use  to select  **Modify Color**, then press .
 - **Cancel**—Returns to the **Design Gallery Menu** without saving changes.
 - **Black & White**—Converts color images to black and white.
 - **Sepia**—Converts image to a brownish tone to look old-fashioned.
 - **B&W Tints**—Applies color tones to a black and white version of an image.
2. Use  to select a color scheme and preview the effect it has on the image.
 - **Cancel**—Returns to the **Design Gallery Menu** without saving changes.
 - **Black and White**—Converts color images to black and white.
 - **Sepia**—Converts image to a brownish tone to look old-fashioned.
 - **B&W Tints**—Applies color tones on a black and white version of an image.
3. Press  to select the color scheme and display the **Creative** sub-menu. Follow the on-camera instructions to adjust the color.
4. Press  to save a copy of the image with the specified color scheme and return to the **Design Gallery Menu**. Press  /  to exit without saving and return to the **Modify Color** sub-menu.



Adding borders

 **Add Borders** allows you to add a predefined border to the displayed image. To add a border:

1. Use  to select  **Add Borders**, then press .
2. Use  to select a border type and preview the effect it has on the image.
 - **Cancel**—Returns to the **Design Gallery Menu** without saving changes.
 - **Soft Edge**—Applies a soft, vignetted frame to the image.
 - **Inset Border**—Image extends beyond the inset frame.
 - **Oval**—Adds an oval matte border with beveled edges.
 - **Circle**—Adds a circular matte border with beveled edges.
 - **Rectangle**—Adds a rectangular matte border with sharp corners.
 - **Rounded Rectangle**—Uses a rectangle with soft corners for the matte border.
 - **Square**—Adds a square matte border with beveled edges.
3. Press  to select the border and display the **Creative** sub-menu. Follow the on-camera instructions to adjust the border.
4. Press  to save a copy of the image with the specified border and return to the **Design Gallery Menu**. Press  /  to exit without saving and return to the **Add Borders** sub-menu.

Recording audio

 **Record Audio** allows you to record an audio clip and attach it to an existing image.

1. Select  **Record Audio** to immediately start recording.
2. To stop recording and attach the audio clip to the displayed image, press .
3. To hear audio associated with still images or video clips, transfer them to your computer using the HP Photosmart Software or use an optional HP Photosmart dock to connect the camera to a TV.

If the currently displayed image already has an audio clip attached to it, the **Record Audio** sub-menu displays instead when you select  **Record Audio**.

- **Keep Current Clip**—Retains the current audio clip and returns to the **Design Gallery Menu**.
- **Record New Clip**—Records a new audio clip, replacing the previous audio clip.
- **Delete Clip**—Deletes the current audio clip and returns to the **Design Gallery Menu**.

5 Transferring and printing images

You can transfer images and video clips with or without the HP Photosmart Software that came with your camera. However, the HP Photosmart Software has several features for transferring and managing your images and also guides you through the transfer process.

Transferring images with HP Photosmart Software

If you have installed the HP Photosmart Software (see [Install the software on page 8](#)), use this method to transfer images and video clips to your computer.



Tip You can also perform this task using an optional HP Photosmart dock (see the dock User Guide).

1. If you have selected images for sharing or printing (see [Using HP Photosmart Express on page 28](#)), verify that the computer is connected to a printer and/or the Internet.
2. Connect the camera and computer using the USB cable that came with your camera.
3. Turn on the camera and follow the instructions on the computer screen to transfer the images. For more information, see the Help feature in the HP Photosmart Software.



Transferring images without HP Photosmart Software

If you do not install the HP Photosmart Software:

- You cannot use the **Share** features or **Buy Prints Online** on the camera's **Photosmart Express Menu** (see [Using HP Photosmart Express on page 28](#)).
- Images marked for printing do not automatically print when the camera is connected to the computer.

However, you can still transfer images and video clips to your computer by:

- Connecting your camera directly to the computer (see [Connecting to the computer on page 26](#))
- Using a memory card reader (see [Using a memory card reader on page 26](#))

Connecting to the computer

1. Turn off the camera, connect it to the computer using the USB cable that came with your camera, then turn on the camera.
 - On Windows computers, the camera appears as a device in Explorer, allowing you to copy images from the camera to the computer.
 - On Macintosh computers, either Image Capture or iPhoto starts automatically, allowing you to transfer images to the computer.
2. When you have finished transferring images, disconnect the camera from the computer. If your computer is running Windows 2000 or XP and you get an **Unsafe Removal** warning, disregard the warning.

If you encounter problems, set the camera's **USB Configuration to Disk Drive** (see **USB Configuration** under *Using the Setup Menu on page 31*) and reconnect to your computer.



Note On Macintosh computers, if you set the camera to **Disk Drive** and neither Image Capture nor iPhoto starts automatically, look on the desktop for a disk drive icon with the label **HP_M425** or **HP_M525** and copy the images manually. For more information about how to copy files, visit Mac help.

Using a memory card reader

You can put your camera's optional memory card into a (separately purchased) memory card reader. Some computers and HP Photosmart printers have built-in memory card slots which act as a memory card reader.

For Windows computers:

1. Insert your camera's memory card into the memory card reader (or into your computer's memory card slot).
2. Right-click **My Computer** on your desktop, then select **Explore**.
3. Expand the removable drive folder, expand the **DCIM** folder, then click on the folder for your camera.
4. Select and copy all the images to a folder on your computer.
5. After verifying that the images were successfully transferred, return the memory card to your camera.

For Macintosh computers:

1. Insert your camera's memory card into the memory card reader (or into your computer's memory card slot).
2. Either the HP Photosmart Software, Image Capture, or iPhoto starts automatically and guides you through the process of transferring images.

If no application starts automatically or if you want to copy the images manually, look on the desktop for the disk drive icon for the memory card, then copy the images to your local hard drive. For more information about how to copy files, visit Mac help.

Printing images from the camera

You can connect the camera to any PictBridge-certified printer to print still images.

1. Check that the printer is turned on, there is paper in the printer, and



there are no printer error messages.

2. Verify that the camera's **USB Configuration** is set to **Digital Camera** (see **USB Configuration** under *Using the Setup Menu* on page 31).
3. Connect the camera and printer using the USB cable that came with your camera, then turn on the camera.
4. When the camera is connected to the printer, the **Print Setup Menu** displays on the camera. To change the settings, use ▲▼ on the camera to select a menu option, then use ◀▶ on the camera to change the setting.
5. Press $\frac{\text{Menu}}{\text{OK}}$ to begin printing.

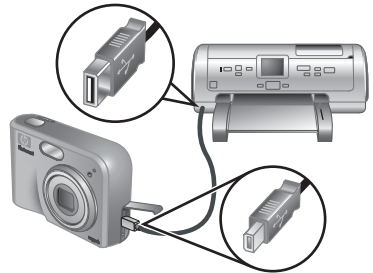

Note If you connect the camera to a non-HP printer and encounter problems with printing, contact your printer manufacturer. HP does not provide customer support for non-HP printers.

6 Using HP Photosmart Express

With **HP Photosmart Express**, you can select still images in your camera to print automatically (see *Selecting images for printing on page 29*) or to purchase prints online (see *Buying prints online on page 30*) the next time you connect the camera to your computer or printer. You can also customize the **Photosmart Express Menu** to include e-mail addresses, group distribution lists, online albums, or other online services that you specify. To customize the **Photosmart Express Menu**:

1. Set up your custom destinations on your camera (see *Setting up online destinations in the camera on page 28*).
2. Select images in your camera to send to online destinations (see *Sending images to online destinations on page 29*).

You must have the HP Photosmart Software, either HP Photosmart Premier (Windows) or HP Photosmart Mac (Macintosh), on your computer to use some features in the **Photosmart Express Menu**. For information about this software, see *About the HP Photosmart Software on page 9*.



Note Available online services vary by country or region. Visit www.hp.com/go/sharing.

Using the Photosmart Express Menu



To display the **Photosmart Express Menu**, press . To select a menu option, use to highlight a selection, then press .

	Print —Allows you to select images and specify number of copies to print. See <i>Selecting images for printing on page 29</i> .
	Buy Prints Online —Specifies images to request from an online printing service. See <i>Buying prints online on page 30</i> .
	Share Menu Setup —Adds share destinations. See <i>Setting up online destinations in the camera on page 28</i> .

Setting up online destinations in the camera



You can specify up to 34 destinations of your choice (such as individual e-mail addresses or group distribution lists) in the **Photosmart Express Menu**.

1. Verify that your computer is connected to the Internet.
2. Turn on the camera, then press .

- Highlight  **Share Menu Setup...**, then press $\frac{\text{Menu}}{\text{OK}}$. Connect the camera to your computer using the USB cable that came with your camera. Follow the instructions in the **Share** dialog box to set up destinations in your camera.
- Disconnect the camera from the computer, then press  to verify that the new destinations are now in the camera.







Sending images to online destinations

- Turn on the camera, then press .
- Use $\blacktriangle/\blacktriangledown$ to highlight the first destination.
- Use $\blacktriangleleft/\blacktriangleright$ to select a still image that you want to send, then press $\frac{\text{Menu}}{\text{OK}}$ to select it. A \checkmark appears over the destination in the **Photosmart Express Menu**. To deselect the destination, press $\frac{\text{Menu}}{\text{OK}}$ again.
- Use $\blacktriangle/\blacktriangledown$ to highlight the next destination, then press $\frac{\text{Menu}}{\text{OK}}$. Repeat Step 3 to continue selecting images to send.
- To exit the **Photosmart Express Menu**, press  / .
- Connect the camera to your computer using the USB cable that came with your camera. The images are automatically sent to their destinations.







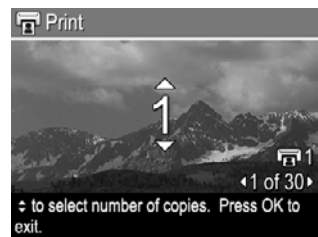



Selecting images for printing

- Turn on the camera, then press .
- Use $\blacktriangle/\blacktriangledown$ to highlight  **Print**.
- Use $\blacktriangleleft/\blacktriangleright$ to display an image you want to mark for printing, then press $\frac{\text{Menu}}{\text{OK}}$ to display the **Print** sub-menu.
- Use $\blacktriangle/\blacktriangledown$ to specify the number of copies to print (up to 99), then press $\frac{\text{Menu}}{\text{OK}}$. To deselect **Print**, select **Print** again, set the number of copies to **0**, then press $\frac{\text{Menu}}{\text{OK}}$.
- To select additional images to mark for printing, use $\blacktriangleleft/\blacktriangleright$ to display an image, press $\frac{\text{Menu}}{\text{OK}}$, and repeat Step 4.
- To exit the **Photosmart Express Menu**, press  / .
- Connect the camera to a PictBridge-certified printer using the USB cable that came with your camera. The images you selected are automatically printed.





Buying prints online

You can select images you want as prints and order them online.







1. Verify that your computer is connected to the Internet.
2. Turn on the camera, then press .
3. Use   to highlight  **Buy Prints Online**.
4. For each image you want to order as a print, use   to display the image, then press . A  appears over **Buy Prints Online** in the **Photosmart Express Menu**. To deselect the image, press  again.
5. Turn off the camera, connect it to your computer using the USB cable that came with your camera, then turn on the camera. Follow the instructions in the **Buy Prints Online** dialog box to purchase prints.
6. Disconnect the camera from the computer.

7 Using the Setup Menu

The **Setup Menu** allows you to set preferences for the camera's behavior.

1. While in **Live View** or **Playback**, press $\frac{\text{Menu}}{\text{OK}}$, then use $\blacktriangleleft \blacktriangleright$ to highlight .
2. Use $\blacktriangle \blacktriangledown$ to highlight a menu option, then press $\frac{\text{Menu}}{\text{OK}}$ to display the menu option's sub-menu.
3. Use $\blacktriangle \blacktriangledown$ to highlight a setting, then press $\frac{\text{Menu}}{\text{OK}}$.
4. To exit the **Setup Menu**, press  / .

Settings you specify remain until you change them.

	Display Brightness —Adjusts the brightness of the Image Display. <ul style="list-style-type: none">● Low—For extending battery life.● Medium (Default)—For normal viewing conditions.● High—For very bright lighting conditions.
	Camera Sounds —Turns the camera sounds (such as button presses and shutter clicks) off and on. On (Default), Off .
	Date & Time —Sets the date and time. See Set the date and time on page 8 .
	USB Configuration —Specifies how a computer recognizes the camera. See Connecting to the computer on page 26 . <ul style="list-style-type: none">● Digital Camera (Default)—Recognizes the camera as a digital camera using PTP (Picture Transfer Protocol).● Disk Drive—Recognizes the camera as a disk drive using MSDC (Mass Storage Device Class).
	TV Configuration —Sets the video signal format for displaying camera images on a TV. <ul style="list-style-type: none">● NTSC—Used primarily in North America, parts of South America, Japan, Korea, and Taiwan.● PAL—Used primarily in Europe, Uruguay, Paraguay, Argentina, and parts of Asia.
	 (Language)—Sets the language. See Choose the language on page 7 .

8 Troubleshooting

Use this section to find information on:

- Resetting the camera (see [Resetting the camera on page 32](#))
- Possible problems and solutions (see [Problems and solutions on page 32](#))

Resetting the camera

If your camera does not respond when you press buttons, reset the camera.

1. Turn off the camera.
2. Remove the memory card and batteries, and disconnect the camera from AC power for at least 5 seconds.
3. Reinsert the batteries and close the Battery/Memory card door.
4. After verifying that the camera works without an optional memory card, reinsert the memory card (if you were using one).

You can also reconnect AC power if you choose.

Resetting the camera returns all settings to their factory defaults. Any images or video clips stored in memory are retained.

Problems and solutions

Use this information to find solutions to common issues you may have using your camera.

The camera does not turn on.

- Install new or recharged batteries, ensuring that the batteries are inserted correctly (see [Install the batteries on page 7](#)). If you are using rechargeable batteries, ensure they are rechargeable Nickel Metal Hydride (NiMH) batteries.
- Ensure that the HP AC power adapter is connected to the camera (directly or through an optional dock) and is plugged into a working electrical outlet. Ensure that the HP AC power adapter is not damaged or defective.
- Reset the camera (see [Resetting the camera on page 32](#)).
- Ensure that the memory card is the proper type (see [Storage on page 43](#)). If so, remove the memory card and turn on the camera; if the camera turns on, format the memory card (see [Install and format an optional memory card on page 8](#)). If the camera still does not turn on, format the memory card using a memory card reader, or replace the memory card.

I have to recharge the NiMH batteries frequently.

- See [Extending battery life on page 38](#).
- New batteries or batteries that have not been charged recently must be recharged to reach full capacity.
- If you have not used the batteries for two months or longer, recharge them.

The NiMH batteries will not charge.

- Try charging the batteries again after they have drained awhile.
- Use only the approved HP AC power adapter.
- If charging the batteries in the HP quick recharger or the spare battery charging bay of an optional HP Photosmart dock does not work, replace the batteries.

The camera does not turn on when I connect to AC power, then disconnect, then reconnect.

- Insert batteries into the camera.
- Reset the camera (see [Resetting the camera on page 32](#)).
- The AC power adapter could be malfunctioning. Try connecting to a different compatible AC power adapter.
- Try plugging the AC power adapter into a different electrical outlet.

The camera does not respond when I press a button.

- Turn on the camera.
- Most of the camera buttons do not respond when the camera is connected to a computer (directly or through an optional dock).
- Replace or recharge the batteries.
- Reset the camera (see [Resetting the camera on page 32](#)).
- Check to see if the memory card is defective. If so, replace the memory card.
- Format the internal memory and/or the memory card (see [Install and format an optional memory card on page 8](#)).

The camera does not take a picture when I press the Shutter button.

- Press the **Shutter** button all the way down.
- The memory card or internal memory may be full. Transfer images from the camera to your computer, then format the internal memory or the memory card (see [Install and format an optional memory card on page 8](#)). Or replace the card with a new one.
- The camera may be processing. Wait a few seconds for the camera to finish processing the last image before taking another picture.

The Image Display is not working.

- The Image Display may have timed out. Press any camera button to wake up the camera.
- Replace or recharge the batteries. If the Image Display does not turn on, remove the batteries and connect to AC power (directly or through the optional dock). If the Image Display still does not turn on, reset the camera (see [Resetting the camera on page 32](#)).

My image is blurry.

- Use **Focus Lock** (see [Using Focus Lock on page 13](#)).
- Use a tripod to hold the camera steady, or improve lighting conditions.
- Set the flash to **A $\frac{1}{2}$ Auto Flash** or **$\frac{1}{2}$ Flash On** and set the shooting mode to  **Action**.

My image is too bright.

- Turn the flash off (see [Setting the flash on page 15](#)).
- Move back from the subject and use zoom.
- Adjust **Exposure Compensation** (see **Exposure Compensation** under [Using the Capture Menu on page 17](#)).

My image is too dark.

- Wait for natural lighting conditions to improve, use the flash (see [Setting the flash on page 15](#)), or add indirect lighting.
- Adjust **Exposure Compensation** (see **Exposure Compensation** under [Using the Capture Menu on page 17](#)).

My image is grainy.

- Use a lower **ISO Speed** setting (see **ISO Speed** under [Using the Capture Menu on page 17](#)).
- Add indirect lighting, use the flash (see [Setting the flash on page 15](#)), or wait for natural lighting conditions to improve.
- If the camera is warm, the effect will diminish as the camera cools. For best image quality, avoid storing the camera in very hot locations.

Images are missing on my camera.

Remove the memory card and see if the images are stored in internal memory.

The Power light is on but the Image Display is off.

- Reset the camera (see [Resetting the camera on page 32](#)).
- Press **Live View/Playback**  /  to reactivate the Image Display.

The camera responds sluggishly when trying to review images.

See [Storage on page 43](#) and [Memory capacity on page 43](#) for tips about memory cards.

Video recording terminates abruptly. The video is saved successfully, but it is shorter than expected.

Replace your memory card with a faster card. Look for cards marked High Performance, Pro, Ultra, or High Speed.

Video recording terminates abruptly and the video will not play back.

Reformat the card (see [Install and format an optional memory card on page 8](#)).

The camera gets warm (or even hot) to the touch.

This is normal. However, if anything seems out of the ordinary, turn off the camera, remove it from AC power, and allow the camera to cool. Then examine the camera and the batteries for signs of possible damage.

For best image quality, turn off the camera when not using. Always store the camera in a cool place.

My camera stalls when establishing a connection to the computer.

- Ensure that the USB cable is properly connected to the camera and computer.
- Try connecting the USB cable to another USB port on the computer.
- Turn the camera off, then on again. If that does not fix the problem, reset the camera (see *Resetting the camera on page 32*).
- If the problem persists, contact HP Support (see *Product support on page 36*).

I cannot transfer images from the camera to my computer.

- Either install the HP Photosmart Software (see *Install the software on page 8*), or see *Transferring images without HP Photosmart Software on page 25*.
- Set your camera to act as a **Disk Drive** (see *Connecting to the computer on page 26*).

I get an error message when transferring images to my computer.

Close the HP Photosmart Transfer Software, remove the camera from the optional dock or disconnect the camera from the USB cable and reset the camera (see *Resetting the camera on page 32*). Then, restart the image transfer process (see *Transferring images with HP Photosmart Software on page 25*).

I am having a problem installing or using the HP Photosmart Software.

- Make sure your computer meets the minimum system requirements as listed on your camera packaging.
- Refer to the HP Customer Care website: www.hp.com/support.

How can I get professional-quality prints if I don't have a photo printer?

Use the **Buy Prints Online** feature on the **Photosmart Express Menu** (see *Buying prints online on page 30*).

9 Product support

Use this section to find support information for your digital camera, including links to helpful websites and an overview of the support process.

Helpful websites

Camera tips, product registration, newsletter subscriptions, driver and software updates, purchase HP supplies and accessories	www.hp.com www.hp.com/photosmart (English only)
Customers with disabilities	www.hp.com/hpinfo/community/accessibility (English only)
HP Customer Care, driver and software updates, support information	www.hp.com/support

Getting assistance

To get the best from your HP product, consult the following standard HP support offerings:

1. Consult the product documentation.
 - Review *Troubleshooting on page 32* in this document.
 - Review the electronic Help section within the software.
 - Refer to the camera's Help screens.
2. Visit HP online support at www.hp.com/support, or contact the store where you purchased this camera. HP online support is available to all HP customers. HP online support is the fastest source of up-to-date product information and expert assistance, including:
 - Fast e-mail access to qualified online support specialists.
 - Software and driver updates for your camera.
 - Valuable product and troubleshooting information for technical issues.
 - Proactive product updates, support alerts, and HP newsletters (available when you register your camera).
3. HP support by phone. Support options and fees vary by product, country, and language. For a list of support conditions and phone numbers, visit www.hp.com/support.
4. Post-warranty period. After the limited warranty period, help is available online at www.hp.com/support.

5. Extending or upgrading your warranty. If you would like to extend or upgrade your camera's warranty, please contact the store where you bought the camera or check the HP Care Pack offers at www.hp.com/support.
6. If you already purchased an HP Care Pack Service, please check the support conditions on your contract.

A Managing batteries

Your camera uses two AA batteries, either Alkaline, Photo Lithium, or rechargeable Nickel Metal Hydride (NiMH). Alkaline batteries provide far less battery life than either Photo Lithium or NiMH batteries.



Top points about batteries

- Fully charge NiMH batteries before using them for the first time.
- Always insert the batteries in the camera correctly (see [Install the batteries on page 7](#)). If the batteries are inserted improperly, the compartment door may close but the camera will not operate.
- If you do not intend to use your camera for more than two months, remove the batteries unless you are using rechargeable batteries and are leaving the camera connected to an optional dock or HP AC power adapter.
- The performance of all batteries will decrease as the temperature drops. To improve battery performance, keep the camera or batteries stored in a warm inside pocket when in a cold environment.

Extending battery life

To conserve battery power, the Image Display turns off after a period of inactivity. Pressing any button wakes up the camera. After five minutes of inactivity, the camera turns off.

To further extend battery life:





- Set **Display Brightness** to **Low** (see **Display Brightness** under [Using the Setup Menu on page 31](#)).
- Set your camera to **Auto Flash** (see **Auto Flash** under [Setting the flash on page 15](#)).
- Use optical zoom sparingly.
- If you are turning on the camera only to view images, hold down  /  while turning on the camera to start in **Playback** without extending the lens.
- Connect the camera to the optional HP AC power adapter when you transfer or print.

Safety precautions for using batteries

- Always use two identical batteries of the same chemistry, brand, and age.
- Do not place batteries in fire or heat them. Always store charged batteries in a cool location.
- Do not connect the positive and negative terminals of the battery to each other with any metal object.
- Do not carry or store batteries with metal objects. Do not drop batteries into a change-filled pocket.
- Do not pierce batteries or subject them to strong impacts or shocks.
- Do not solder directly onto batteries.
- Do not allow batteries to get wet.
- Do not disassemble or modify batteries.
- Immediately discontinue use of a battery if, while using, charging, or storing the battery, the battery emits an unusual smell, feels excessively hot (note that it is normal for the battery to feel warm), changes color or shape, or appears abnormal in any other way.
- In the event batteries leak and the fluid gets into one's eye, do not rub the eye. Rinse well with water and immediately seek medical care. If left untreated, the battery fluid could cause damage to the eye.

Power indicators

When the batteries are low or the camera is connected to AC power, one of the following icons appears in the Image Display. If no battery icon appears in **Live View** or **Playback**, the batteries have sufficient power to function normally.

Icon	Description
	Battery level is low. Camera will soon power down.
 Blinking	Battery is depleted. Camera will power down.
	Camera is operating on AC power.
Animated battery filling up	Camera is operating on AC power and is charging the battery.
	Camera has successfully completed battery charging and is operating on AC power.



Note If the camera is without batteries for a prolonged period, the clock may be reset and you may be prompted to update it the next time you power on the camera.

Number of shots per battery type

The following table shows the minimum, maximum, and average number of shots that may be obtained using Alkaline, Photo Lithium, and rechargeable NiMH batteries.

Battery Type	Number of Shots			
	Minimum	Maximum	Average	CIPA
Alkaline	77	180	120	80
NiMH	215	380	290	205
Photo Lithium	365	600	485	423

For Minimum, Maximum, and Average numbers, four pictures are taken per session with at least a 5 minute break between sessions. In addition:

- The minimum number of shots is obtained with extensive use of **Live View** (30 seconds per picture), **Playback** (15 seconds per picture), and **Flash On**. Optical zoom (both directions) is used on 75% of the shots.
- The maximum number of shots is obtained with minimal use of **Live View** (10 seconds per picture) and **Playback** (4 seconds per picture). Flash and optical zoom (both directions) are used on 25% of the shots.
- The average number of shots is obtained with **Live View** used for 15 seconds per picture and **Playback** used for 8 seconds per picture. Flash and optical zoom (both directions) are used on 50% of the shots.
- The CIPA number is obtained using the standards established by the Camera and Imaging Products Association.

Battery performance

The following table shows how Alkaline, Photo Lithium, and rechargeable NiMH batteries perform in different types of use scenarios:

Type of Use	Alkaline	Photo Lithium	NiMH
Most economical if you take more than 30 pictures per month	Poor	Fair	Good
Most economical if you take fewer than 30 pictures per month	Fair	Good	Fair
Heavy use of flash, frequent pictures	Poor	Good	Good
Heavy use of video	Poor	Good	Good
Heavy use of Live View	Poor	Good	Good
Overall battery life	Poor	Good	Fair
Low temperature/winter use	Poor	Good	Fair
Infrequent use (without dock)	Fair	Good	Fair
Infrequent use (with dock)	Fair	Good	Good
Want to recharge battery	No	No	Good

Recharging NiMH batteries

You can recharge NiMH batteries in the camera when the camera is connected to an optional HP AC power adapter. You can also charge the batteries in an optional HP Photosmart dock that has a battery bay or with an optional quick recharger.

The following table shows the average recharge time for a fully discharged battery, based on recharge location.

Charge location	Average charge time	Signals
In camera with the HP AC power adapter connected	12–15 hours	<p>Charging: Camera's Battery Charging light blinks and the animated battery icon is displayed.</p> <p>Charging complete: Camera's Battery Charging light turns on solid and the battery gauge changes to  on the Image Display.</p>
In camera connected to the HP AC power adapter through an HP Photosmart dock	12–15 hours	<p>Charging: Dock's camera battery charging light blinks.</p> <p>Charging complete: Dock's camera battery charging light turns on solid.</p>

(continued)

Charge location	Average charge time	Signals
In battery bay of the HP Photosmart 6221 Premium Camera Dock	2–3 hours	Charging: Dock's battery bay light blinks. Charging complete: Dock's battery bay light turns on solid.
In HP Photosmart M-Series quick recharger	1 hour for 2 batteries. About 2 hours for 4 batteries.	Charging: Quick recharger light is yellow. Charging complete: Quick recharger light is green.

Safety precautions for recharging batteries

You can recharge the batteries in the camera or purchase an optional dock with battery bay or a quick recharger. These devices may be warm while charging NiMH batteries. This is normal. However, you should follow the safety precautions below.

- Do not charge any batteries other than NiMH batteries in the camera, dock, or quick recharger.
- Insert NiMH batteries in the correct orientation.
- Use the camera, dock, or quick recharger in a dry location only.
- Do not charge NiMH batteries in a hot location, such as in direct sunlight or near a fire.
- When recharging NiMH batteries, do not cover the camera, dock, or quick recharger.
- Do not operate the camera, dock, or quick recharger if NiMH batteries appear damaged.
- Do not disassemble the camera, dock, or quick recharger.
- Unplug the HP AC power adapter or quick recharger from the electrical outlet before cleaning the power adapter or quick recharger.

B Specifications

Resolution	<p>Still pictures, M425:</p> <ul style="list-style-type: none"> • 5.25MP (2654 by 1955) total pixel count • 5.0MP (2592 by 1936) effective pixel count <p>Still pictures, M525:</p> <ul style="list-style-type: none"> • 6.3MP (2934 by 2171) total pixel count • 6.0MP (2864 by 2152) effective pixel count <p>Video clips (VGA): 320 by 240 total pixel count, 20 frames/sec</p>
Sensor	Diagonal 7.19 mm (1/2.5-inch, 4:3 format) CCD
Color depth	36 bit (12 bits by 3 colors). 36 bit images are transformed into an optimized 24 bit image and stored in the JPEG format. This transformation results in no discernible change to color or detail in the stored image, and allows the image to be read by computers.
Lens	<p>Focal length:</p> <ul style="list-style-type: none"> • Wide—6.25 mm • Telephoto—17.25 mm • M425 35 mm equivalent—~38.3 mm to 105.7 mm • M525 35 mm equivalent—~37.5 mm to 103.6 mm <p>F-Number:</p> <ul style="list-style-type: none"> • Wide—f/2.8 to f/8 • Telephoto—f/4.7 to f/7.6
Viewfinder	None
Zoom	<ul style="list-style-type: none"> • 3x optical zoom with 8 positions between wide and telephoto • Digital zoom, M425—1x to 6x • Digital zoom, M525—1x to 7x
Focus	<p>Focus settings: Auto (default), Macro</p> <p>Auto:</p> <ul style="list-style-type: none"> • Wide—500 mm (20 in) to infinity • Telephoto—600 mm (23.6 in) to infinity <p>Macro:</p> <p>Wide—120 mm to 1 m (4.7 in to 39.4 in)</p>
Shutter speed	1/1000 to 2 seconds
Built-in flash	Yes, 6-second typical recharge time (8-second maximum recharge time at power-on)
Flash working range	<ul style="list-style-type: none"> • Zoom Position Wide—Maximum with ISO Speed set to Auto ISO: 3.8 m (12.5 ft) • Zoom Position Telephoto—Maximum with ISO Speed set to Auto ISO: 2.1 m (6.9 ft) • Uniformity—Corner intensity > 55% of Center intensity (Lux Seconds)

(continued)

Image Display	4.31 cm (1.7 in) color LTPS TFT LCD with backlight, 115,200 pixels (480 by 240) total pixel count
Storage	<ul style="list-style-type: none">• 32MB internal flash memory.• Slot for memory card.• This camera supports standard and high speed, HP-branded Secure Digital (SD) memory cards, 8MB to 2GB.• A large number of files (over 300) does affect the time it takes for the camera to turn on.• The number of images or video clips that can be saved in memory depends on the Image Quality settings (see Memory capacity on page 43).
Compression format	<ul style="list-style-type: none">• JPEG (EXIF) for still images• EXIF2.2 for still images with embedded audio• Motion JPEG for video clips
Interfaces	Dock connector—Molex 55768-2011, which connects to HP Photosmart docks with USB Mini AB connector, DC input connector, and AV connector.
Standards	<ul style="list-style-type: none">• PTP—MSDC and SIDC• USB• JPEG• Motion JPEG• DPOF• EXIF• DCF• DPS
External body dimensions	Measurements with camera off and lens retracted (width, depth, height): <ul style="list-style-type: none">• 95 mm (W) by 31 mm (D) by 62 mm (H)• 3.74 in (W) by 1.22 in (D) by 2.44 in (H)
Weight	166 grams (5.85 ounces) without battery
Power	Typical power usage: 2.5 Watts (with Image Display on). 5 Watts peak power usage. Power sources include: <ul style="list-style-type: none">• Two rechargeable NiMH batteries• HP AC power adapter (5 Vdc, 2000 mA, 10.00 W)
Temperature range	Operational 0° to 50° C (32° to 122° F) at 15% to 85% relative humidity Storage –30° to 65° C (–22° to 149° F) at 15% to 90% relative humidity

Memory capacity

Not all 32MB of internal memory is available for storing images, because some memory is used for internal camera operations. The actual file sizes and number of still images that can be stored in internal memory or on a memory card will vary depending on the content of each still image and the length of any associated audio clip.

Image quality

The following tables list the approximate number and average size of still images that can be stored in internal memory when the camera is set to different **Image Quality** settings (see **Image Quality** under *Using the Capture Menu* on page 17).

HP Photosmart M425

5MP Best	3 images (3MB each)
Normal (5MP)	8 images (1.25MB each)
3MP	13 images (750KB each)
1MP	40 images (250KB each)
VGA	130 images (76.8KB each)

HP Photosmart M525

6MP Best	2 images (3.6MB each)
Normal (6MP)	6 images (1.5MB each)
4MP	10 images (1MB each)
2MP	20 images (500KB each)
VGA	130 images (76.8KB each)



Note The values shown are for images without audio clips. Sixty seconds of audio adds 330KB to the file size.

Index

- A**
 - AC power adapter 6
 - Action mode 16
 - adding borders 23
 - arrow buttons 5
 - assistance 36
 - audio clips 11, 23
 - Auto mode 15
- B**
 - batteries
 - charge 7
 - conserving 38
 - install 7
 - performance 40
 - shots per 39
 - top points about use 38
 - battery door 6
 - Beach and Snow mode 16
 - blinking lights on camera 5, 6
 - borders 23
 - Burst mode 16, 17
- C**
 - camera
 - dimensions 43
 - parts 5, 6
 - specifications 42
 - turn on/off 7
 - weight 43
 - Camera Sounds 31
 - Capture Menu 17
 - color depth 42
 - colors 23
 - compression format 43
 - computer, connect to 25, 26
- D**
 - Date & Time 8, 31
 - Date & Time Imprint 18
 - Delete button 5
 - digital zoom 14
 - dimensions 43
 - direct print 26
 - Display Brightness 31
 - dock insert 6
- E**
 - e-mail images 28
 - exposure 13
 - Exposure Compensation 18
- F**
 - F-number 42
 - Fast Shot mode 15
 - flash
 - red-eye reduction 15
 - working range 42
 - Flash button 5
 - focal length 42
 - focus
 - auto focus 12
 - brackets 12
 - focus lock 13
 - optimizing 13
 - settings 42
 - format memory card 8
- G**
 - getting assistance 36
- H**
 - HP AC power adapter 6
 - HP Photosmart Express 28
 - HP Photosmart Software 8, 9
- I**
 - Image Display 6
 - Image Quality 17, 44
 - images
 - Date & Time Imprint 18
 - Image Quality 17
 - magnifying 21
 - number remaining 11
 - per battery 39
 - sending 29
 - shooting modes 15
 - transfer to computer 25
 - White Balance 18
 - install memory card 8
 - install software 8
 - Instant Review 12, 17
 - interfaces 43
 - internal memory 11, 43
- ISO Speed** 18, 19
- L**
 - Landscape mode 16
 - Language 7, 31
 - LEDs 5, 6
 - lights on camera 5, 6
 - Live View/Playback button 5
- M**
 - Macro shooting mode 16
 - Magnify control 5
 - magnifying images 21
 - memory
 - capacity 43
 - card 8, 11, 43
 - card door 6
 - Menu/OK button 5
 - menus
 - Capture 17
 - Photosmart Express 28
 - Setup 31
 - microphone 6
 - modifying colors 23
 - Move Images to Card 22
- N**
 - Night Portrait mode 16
 - NiMH battery 41
 - number of
 - pictures remaining 11
 - still images 44
- O**
 - on/off 7
 - ON/OFF button 5
 - online
 - destinations 28
 - print buying 30
 - optical zoom 14
- P**
 - parts of camera 5, 6
 - Photosmart Express button 5
 - Photosmart Express Menu 28, 28, 29

- pictures 11, 16
- Playback 20
- Portrait mode 16
- power
 - adapter 6
 - indicators 39
 - light 5
 - ON/OFF button 5
 - usage 43
- print images 26, 28
- prints, buy online 30
- problems and solutions 32

R

- record
 - audio clips 23
 - video clips 12
- red-eye removal 22
- Region 8
- remaining pictures count 11
- removing red eyes 22
- resolution 42
- reviewing images 20

S

- safety precautions for
 - batteries 38, 41
- selecting images for
 - destinations 29
- Self-Timer
 - light 6
- Self-Timer mode 15, 16
- sending individual images 29
- set date and time 8
- setting up destinations 28
- Setup Menu 31
- share pictures 28
- shooting mode 15
- Shutter button 5, 12
- shutter speed 42
- software install 8
- solving problems 32
- sounds of camera 31
- space remaining in memory 11
- specifications 42
- storage 43
- Sunset mode 16
- support process 36

T

- Thumbnails 21
- Thumbnails control 5
- Time & Date 8, 31

- transfer images 25
- troubleshooting 32
- turn on/off power 7
- TV Configuration 31

U

- USB configuration 26, 31
- USB connector 6

V

- Video button 5
- video clips 12
- viewing thumbnails 21

W

- weight 43
- White Balance 18, 19

Z

- zoom 14, 42
- Zoom lever 5