

**Jabra** GN

USER MANUAL



# PANACAST 40 VBS

Technology for life's new rhythm

© 2025 GN Audio A/S. All rights reserved. Jabra® is a trademark of GN Audio A/S. The Bluetooth® word mark and logos are registered trademarks owned by the Bluetooth SIG, Inc. and any use of such marks by GN Audio A/S is under license.

---

Made in Thailand

MODEL: VSM050; VTD050



---

**Declaration of Conformity** can be found on [www.jabra.com/doc](http://www.jabra.com/doc)

|  |    |   |    |
|--|----|---|----|
| 1. Welcome.....  | 5  | 5.6 Pan, Tilt, Zoom presets               |    |
| 2. Overview.....                                       | 6  | 5.7 Image quality settings                |    |
| 2.1 Jabra PanaCast 40 VBS bar overview                 |    | 5.8 Video flicker                         |    |
| 2.2 Jabra Control IP overview                          |    | 5.9 Enhanced Noise Suppression            |    |
| 2.3 Included accessories - Jabra PanaCast 40 VBS bar   |    | 5.10 Intelligent Meeting Space            |    |
| 2.4 Optional accessories                               |    | 6. Bring Your Own Device (BYOD) mode..... | 22 |
| 3. Visual indicators.....                              | 12 | 7. Share content.....                     | 24 |
| 4. Settings management.....                            | 13 | 7.1 Wireless content sharing              |    |
| 5. Video and audio settings.....                       | 15 | 7.2 Wired content sharing                 |    |
| 5.1 Intelligent Zoom                                   |    | 8. Privacy cover.....                     | 26 |
| 5.2 Virtual Director                                   |    | 9. Safety capacity settings.....          | 27 |
| 5.3 Panoramic View                                     |    | 10. Update firmware.....                  | 28 |
| 5.4 Single-stream Dynamic Composition                  |    | 11. Restart devices.....                  | 30 |
| 5.5 Smart Gallery - Multi-stream - only for Zoom Rooms |    |   |    |

|                                       |    |
|---------------------------------------|----|
| 12.Factory reset .....                | 33 |
| 13.Support.....                       | 37 |
| 13.1FAQ and technical specifications  |    |
| 13.2How to care for your Jabra device |    |

# 1. Welcome

Thank you for using the Jabra PanaCast 40 VBS. We hope you will enjoy it!

Here are some key features you will benefit from by using the Jabra PanaCast 40 VBS:

- Maximize your small meeting rooms with 180° field of view in 4K video and impressive audio
- Cutting-edge AI-powered video features for more inclusive meetings
- Use with Jabra touch controller, any touchscreen or in permanent BYOD mode
- Works seamlessly with Microsoft Teams and Zoom
- Built on Microsoft Device Ecosystem Platform (MDEP) for enterprise-grade security
- Easy remote management and updates with Jabra Plus Management

## 2. Overview

### 2.1 Jabra PanaCast 40 VBS bar overview

---

#### FRONT SIDE

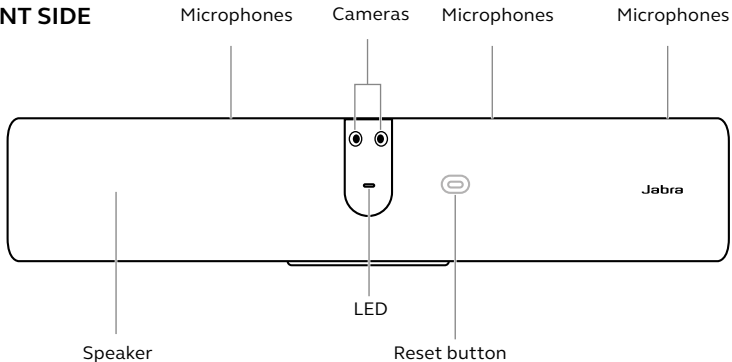

**SECURITY NOTE:** microphones and cameras can be used to record private conversations and footage.

## BACK SIDE

### PORT CONNECTIONS



AUX OUT for assistive listening devices



Ethernet network



USB-A for touchscreen, USB mouse or GN approved USB peripherals



HDMI for wired content sharing



HDMI OUT for monitor



USB-C for BYOD



Power

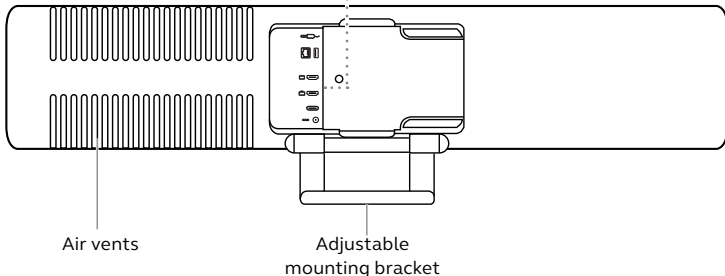

**Security note:** Bluetooth, Ethernet or Wi-Fi connections can potentially be used to transfer data to unauthorized devices.

## 2.2 Jabra Control IP overview

### FRONT SIDE

10-inch LCD  
touchscreen

Proximity  
sensor

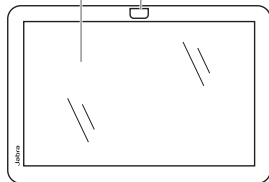

Proximity sensor

### BACK SIDE

Ultrasonic sound  
proximity emitter

Port connections  
(remove cover for  
access)

USB-C port  
(for future use)

Ethernet port (PoE)

Pinhole reset  
button

Kensington  
security  
slot

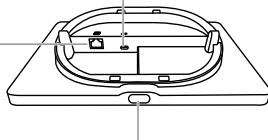
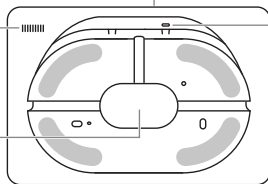

**SECURITY NOTE:** sensors can potentially be used to detect the presence of a user.

## 2.3 Included accessories - Jabra PanaCast 40 VBS bar

---

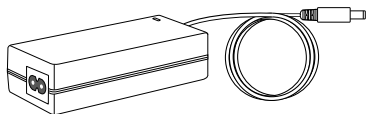

**AC power adapter** (2m/6.56ft)

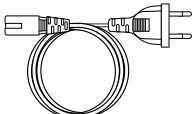

**AC power cable**  
(1m/3.28ft)

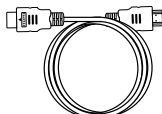

**HDMI 2.0  
Premium High  
Speed cable**  
(1.83m/6ft)

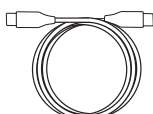

**USB-C to C  
2.0 cable**  
(3m/9.84ft)



**Camera privacy  
cover**

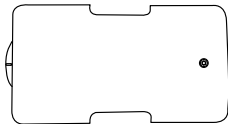

**Cable compartment cover  
with embedded screw**  
(T10 torx)

## 2.4 Optional accessories

---

Accessories can be purchased at [jabra.com/accessories](https://www.jabra.com/accessories)

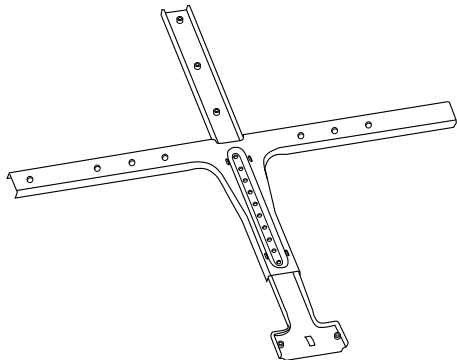

**Screen mount**

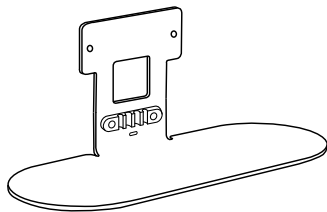

**Table stand**

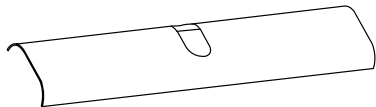

**Easy-clean cover**

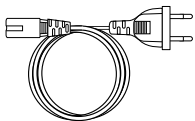

**Regional power cords**  
(1m/3.28ft)

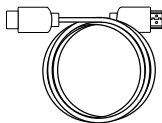

**HDMI cable**  
(1.83m/6ft)

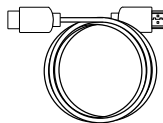

**HDMI ingest cable**  
(4.57m/15ft)

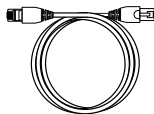

**RJ45 Ethernet cable**  
(4.57m/15ft)

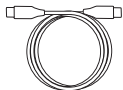

**USB-C to C cable**  
(4.57m/15ft)

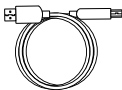

**USB-A to B cable**  
(1.83m/6ft)



**Camera tilt lock**

## POWER OVER ETHERNET (PoE) KIT

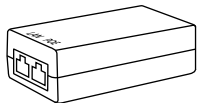

**PoE injector**

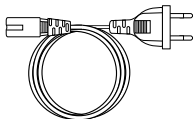

**AC power cable**  
(1m/3.28ft)



**RJ45 Ethernet cable**  
(4.57m/15ft)



**Jabra Control IP table mount**

### 3. Visual indicators

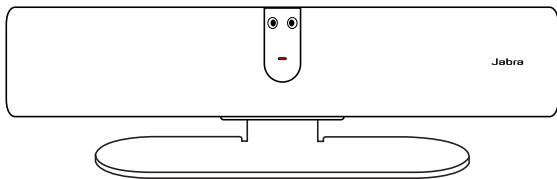

#### LED STATUS

- |                                  |                        |
|----------------------------------|------------------------|
| Off or not streaming             | (LED off)              |
| Starting up                      | ☼ (flashing white)     |
| In call or streaming video/media | ○ (solid white)        |
| In call, audio muted             | ● (solid red)          |
| Firmware updating                | ☼ (fast flashing pink) |

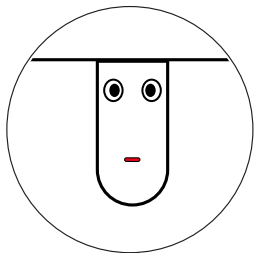

## 4. Settings management

After the Jabra PanaCast 40 VBS configuration process is completed, the Jabra device (video bar or touch controller) will display the video conferencing app of your service provider.

To access the Jabra PanaCast 40 VBS settings, go to the **More** menu in the video conferencing app, select **Settings** and then **Device settings**.

**Basic settings** and **general information** of the Jabra device will be displayed.

**Advanced settings** are available when logging in as an administrator. If this is the first login, the default username is **admin** and the password is the **last 6 digits of the Jabra device serial number**. After the first login, you must change the password.

Go to the **About** menu to find the the serial number of the Jabra device.

All Jabra PanaCast 40 VBS settings can be configured using the Web Console or Jabra Plus Management.

To access the Web Console, enter the IP address of the video bar or touch controller in a browser. The IP address is displayed on the installation screen during the configuration process of the Jabra PanaCast 40 VBS. The IP address is also available in the **About** section of the **Device settings** menu.

To access Jabra Plus Management, log in using your Jabra Plus Management account. Go to the **Meeting rooms > Room inventory** menu, select your organization and corresponding meeting room. Select the provisioned Jabra PanaCast 40 VBS to access its settings.

For more information on Jabra Plus Management, go to [jabra.com/help/jabraplus](https://jabra.com/help/jabraplus)

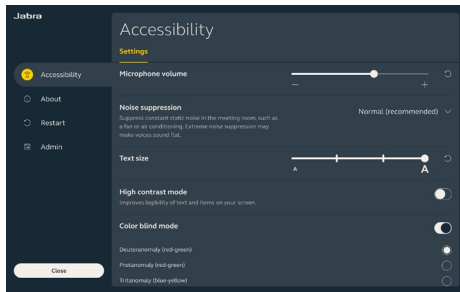

# 5. Video and audio settings

Administrators can configure the video and audio settings directly in the Jabra device (video bar or touch controller), remotely using the Web Console or Jabra Plus Management, or directly in your conferencing app, e.g. Microsoft Teams or Zoom.

To access the video and audio settings using the Jabra device, go to the **More** menu in the video conferencing app, select **Settings** and then **Device settings**. The Jabra PanaCast 40 VBS settings screen will be displayed. Go to the **Admin** menu and log in as an administrator.

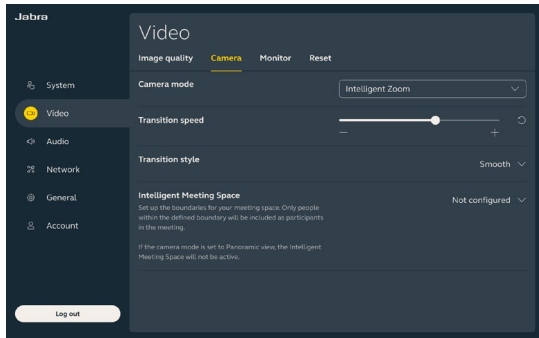

If this is the first login, the default username is **admin** and the password is the **last 6 digits of the serial number of the Jabra device**. The serial number of the Jabra device is available in the **Device settings** section of the **About** menu. **After the first login, you must change the password.**

To access the video and audio settings using the Web Console, enter the IP address of the video bar or touch controller in a browser. The IP address is displayed on the installation screen during the configuration process of the Jabra PanaCast 40 VBS. The IP address is also available in the **Device settings** section of the **About** menu.

To access Jabra Plus Management, log in using your Jabra Plus Management account. Go to the **Meeting room > Room inventory** menu, select your organization and corresponding meeting room. Select the provisioned Jabra PanaCast 40 VBS to access the video and audio settings.

## 5.1 Intelligent Zoom

---

Intelligent Zoom is a camera mode that dynamically frames all visible people in the meeting room in one view.

Only one camera mode can be active at a time. By default, the camera mode is set to Intelligent Zoom.

## 5.2 Virtual Director

---

Virtual Director is a camera mode that dynamically switches to and focuses on the person who is speaking.

## 5.3 Panoramic View

---

Panoramic View is a camera mode that displays a panoramic view of the meeting room.

## 5.4 Single-stream Dynamic Composition

---

Single-stream Dynamic Composition is an advanced camera mode that displays a tiled view of up to four speakers and a full room view. The tiled view will dynamically update to display the participants who are actively speaking.

## 5.5 Smart Gallery - Multi-stream - only for Zoom Rooms

---

The Jabra PanaCast 40 VBS creates individual streams of in-room participants, as well as a full room view, so each in-room participant gets their own stream in a Zoom meeting. The tiled view will dynamically update to highlight the participant who is actively speaking.

To select this video mode, go to **Zoom Room** settings and select **Multi-Stream** option.

To hide the panoramic view and only display the individual video streams, go to **Zoom Room** settings and select **Hide Room View**.

## 5.6 Pan, Tilt, Zoom presets

---

Pan, Tilt, Zoom presets allow users to adjust and save the camera view using the touch controller. Saved presets do not overwrite the default Pan, Tilt, Zoom settings. Users can select saved presets when a new meeting starts. Pan, Tilt, Zoom controls are only available when using panoramic view mode.

## 5.7 Image quality settings

---

The image brightness, contrast, saturation, sharpness, and white balance can be adjusted in the Web Console or using the touch controller through the admin device settings.

Automatic white balance is enabled by default. To manually adjust the white balance, automatic white balance must be disabled.

## 5.8 Video flicker

---

Video flicker can occur if the Jabra PanaCast 40 VBS is not set to the correct geographical region. If you encounter video flicker, select Auto (50Hz/60Hz) for regions that support NTSC format, or 50Hz for regions that support PAL format.

By default, Video flicker is set to Auto.

## 5.9 Enhanced Noise Suppression

---

The Jabra PanaCast 40 VBS provides noise suppression which addresses noise, echo cancellation and suppresses constant static noise, such as a fan or air conditioning.

Based on the meeting room conditions, you can select Extreme Noise Suppression to suppress all background noise. Extreme Noise suppression may make voices sound flat.

## 5.10 Intelligent Meeting Space

---

Define a customized boundary that can be applied to a meeting space. This will ensure that only people within this boundary will be considered as meeting room participants.

Intelligent Meeting Space is especially useful for meeting rooms that have glass walls.



## 6. Bring Your Own Device (BYOD) mode

BYOD mode allows hosting a meeting from a computer and not from the Jabra PanaCast 40 VBS. To enable BYOD mode, go to the **Admin** menu and log in as administrator. If this is the first login, the default username is **admin** and the password is the **last 6 digits of the serial number of the Jabra device**.

Go to **System > Bring Your Own Device** and **Enable BYOD**. This allows meeting participants to start and exit BYOD mode from the Jabra device when required.

After enabling BYOD mode, it will be automatically available when connecting a personal computer to the video bar via USB-C. The camera, microphone and speakers from the video bar will be used during the meeting. To view the personal computer screen on the meeting room monitor, connect an HDMI cable between the video bar and the computer.

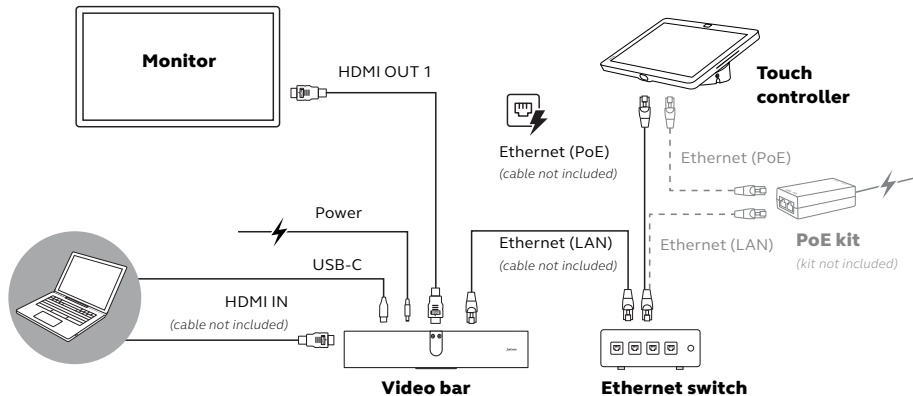

# 7. Share content

## 7.1 Wireless content sharing

---



The video bar and touch controller have Bluetooth® technology that allows users to share content directly from their computers or mobile devices.

When sharing content using a wireless signal, the **share content** feature must be enabled in the video conferencing app.

For more information on how to share content wirelessly, go to the support page of your video conferencing service provider.

## 7.2 Wired content sharing

---

Connect an HDMI cable from the computer to the **HDMI IN** port on the back of the video bar  . The content from the computer will be displayed in the meeting and on the room monitor connected to the video bar.

An additional HDMI cable is not supplied and can be purchased at [jabra.com/accessories](https://jabra.com/accessories)

## 8. Privacy cover

When the video bar is not in use, the privacy cover can be used to cover the lenses of the camera.

Remove the privacy cover when streaming video to avoid flickering, which may be triggering for photosensitive individuals.

To stop the video feed during the meeting, users can use the in-meeting controls in the video conferencing application.

## 9. Safety capacity settings

The Jabra PanaCast 40 VBS works together with the video conferencing app to monitor the safety capacity limit of a meeting room.

These settings are configured and managed directly in the admin portal of your video conferencing service provider.

# 10.Update firmware

Firmware updates improve performance or add new functionality to Jabra devices. It is recommended to update your Jabra device to the latest firmware available before first use. Jabra PanaCast 40 VBS firmware updates can be done:

- Locally on the video bar (mouse or touchscreen monitor required)
- Locally on the paired touch controller
- Remotely using the Web Console(s) for the video bar and touch controller
- Remotely using the admin portal of your video conferencing service provider
  - ideal for mass management
- Remotely using Jabra Plus Management - ideal for mass management

For local updates, access the **Device settings** menu on the video bar or touch controller, go to the **System** section and select **Update**.

For remote updates, access the Web Console of the video bar and touch controller individually. Enter the IP address of the video bar or touch controller in a browser. If this is the first time accessing the Web Console, the default username is **admin** and the password is the **last 6 digits of the serial number** of the video bar or the touch

controller. The serial number of the Jabra device is available in the **About** section of the **Device settings** menu. After the first login, you must change the password.

Firmware updates in Jabra Plus Management will follow the Firmware policy assigned to the meeting room configuration.

Go to the **Meeting rooms > Room configurations** menu and select **Firmware policy**.

# 11.Restart devices

The video bar and touch controller settings will remain the same when you restart them. You can restart the video bar and touch controller using one of the following options:

**Web Console** – enter the IP address of the video bar or touch controller in the browser and go to the **General > System reset** menu and select **Restart connected devices**.

**Jabra Plus Management** – log in using your Jabra Plus Management account. Go to the **Meeting room > Room inventory** menu, select your organization and corresponding meeting room. Go the action menu on the Jabra PanaCast 40 video bar or touch controller, and select **Reboot device**.

**Admin portal** of your video conferencing service provider.

**Touch Controller** – Go to the **Device settings** menu in your video conferencing app. Go to the **General > System reset** menu and select **Restart connected devices**. The video bar and touch controller will be restarted.

## Manual restart of the video bar

Lift the cover of the video bar. Press and hold the button. Release the button after 5 seconds and a restarting message will be displayed on the monitor.

The video bar will restart and play an audio notification when ready for use. The reboot takes approximately 1 minute.

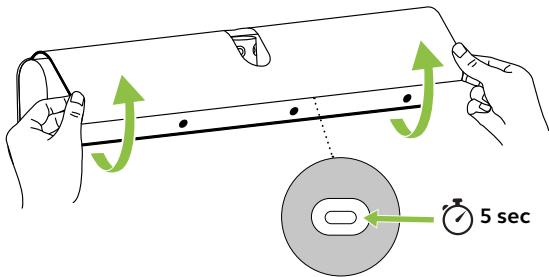

## Manual restart of the touch controller

Use a paperclip to press and hold the **Pinhole reset** button on the edge of the screen of the touch controller. Release the button after 5 seconds and a restarting message will be displayed on the screen.

The reboot takes approximately 1 minute.

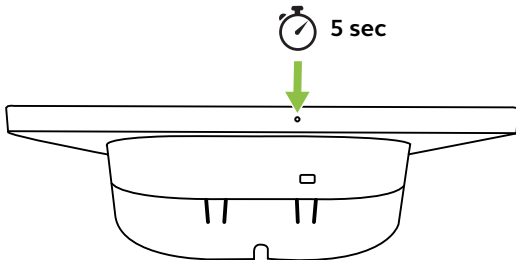

## 12. Factory reset

Factory reset will restore the touch controller and video bar to their factory default settings and it will be necessary to re-pair the devices.

You can factory reset the video bar and touch controller using one of the following options:

**Web Console** – enter the IP address of the video bar or touch controller in the browser and go to the **General > System reset** menu and select **Factory reset**.

**Touch Controller** – Go to the **Device settings** menu in your video conferencing app. Log in as admin and go to the **General > System reset** menu and select **Factory reset**. The video bar and touch controller will be reset.

## Manual factory reset of the video bar

Manual factory reset will restore the video bar to its factory default settings and it will be necessary to re-pair the video bar to the touch controller.

Lift the cover of the video bar. Press and hold the button for 20 seconds until the LED flashes pink and the factory data reset message is displayed on the monitor.

The video bar will restart and play an audio notification when ready for use. The reboot takes approximately 1 minute.

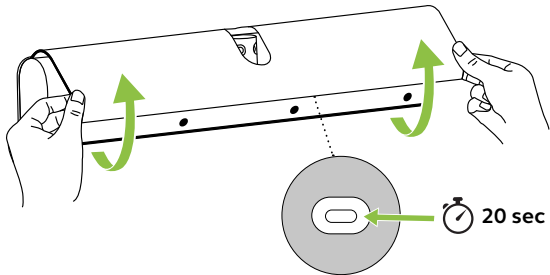

## Manual factory reset of the touch controller

Manual factory reset will restore the touch controller to its factory default settings and it will be necessary to re-pair the touch controller to the video bar.

Use a paperclip to press and hold the Pinhole reset button on the edge of the screen of the touch controller for 20 seconds until the factory data reset message is displayed on the screen.

The reboot takes approximately 1 minute.

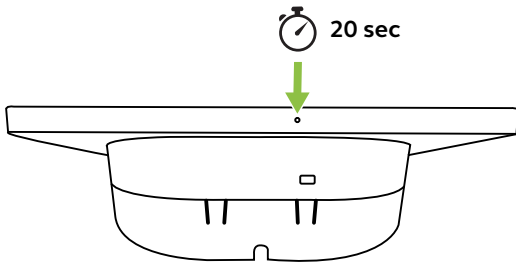

A security code can be configured to prevent users from manually factory resetting the Jabra devices. You can configure it using the Web Console or within the admin settings directly on the device.

**Web Console** - enter the IP address of the video bar or touch controller in the browser. Log in as an admin and go to **Account > Access**.

**Touch controller** - log in as an admin and go to **Account > Access**.

After manually starting the factory reset of the Jabra device, the security code must be entered to complete the factory reset.

# 13.Support

## 13.1 FAQ and technical specifications

---

View the FAQ, certifications, and technical specifications at [jabra.com/help/PanaCast40vbs](https://jabra.com/help/PanaCast40vbs)

## 13.2 How to care for your Jabra device

---

The Jabra PanaCast 40 VBS is for indoor use only.

- Avoid direct sunlight and temperatures above 40°C/104°F or below 0°C/32°F.
- Do not expose the camera or cables to rain or other liquids.
- Do not position the devices near the vents of a monitor or TV as this may cause the devices to overheat and malfunction.
- Clean the surface with a cloth dampened with a mild soap solution.

To learn more about the Jabra PanaCast 40 VBS,  
go to [\*\*jabra.com/help/PanaCast40vbs/getstarted\*\*](https://jabra.com/help/PanaCast40vbs/getstarted)