

# Canon

imagePROGRAF

## PRO-300

Getting Started  
Démarrage  
Inbetriebnahme  
Aan de Slag-gids  
Guida Rapida  
Para Começar  
Guía de inicio  
ΞΕΚΙΝΩΝΤΑΣ  
Uppstartsguide



<https://ij.start.canon>



Read **Safety and Important Information** (addendum) first.

Commencez par lire **Sécurité et informations importantes** (addendum).

Lesen Sie **Sicherheitsinformationen und wichtige Hinweise** (Anhang) zuerst.

Lees eerst **Veiligheidsinformatie en belangrijke informatie** (addendum).

Leggere innanzitutto **Informazioni importanti e sulla sicurezza** (addendum).

Leia **Informações Importantes e Sobre Segurança** (adendo) primeiro.

Lea primero **Información de seguridad e información importante** (apéndice).

Διαβάστε πρώτα τις **Πληροφορίες για την ασφάλεια και σημαντικές πληροφορίες** (συμπλήρωμα).

Läs **Information om säkerhet och annan viktig information** (bilaga) först.



Q T 6 3 5 4 0 V 0 1



Installing the Printer.....page 1  
Installation de l'imprimante.....page 1  
Installation des Druckers.....Seite 1  
De printer installeren.....pagina 1  
Installazione della stampante.....pagina 1  
Instalando a impressora.....página 1  
Instalación de la impresora.....página 1  
Εγκατάσταση του εκτυπωτή.....σελίδα 1  
Installera skrivaren.....sida 1

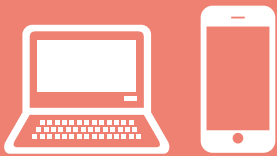

Connecting to a Computer, Smartphone or Tablet.....page 7  
Connexion à un ordinateur, un smartphone ou une tablette.....page 7  
Herstellen einer Verbindung mit einem Computer, Smartphone oder Tablet...Seite 7  
Verbinden met een computer, smartphone of tablet.....pagina 7  
Connessione a un computer, uno smartphone o un tablet.....pagina 7  
Conectando a um computador, smartphone ou tablet.....página 7  
Conexión con un ordenador, teléfono inteligente o tableta.....página 7  
Σύνδεση σε υπολογιστή, smartphone ή tablet.....σελίδα 7  
Ansluta till en dator, smarttelefon eller surfplatta.....sida 7



Instructional Videos  
Instructions vidéo  
Anleitungsvideos  
Instructievideo's  
Video informativi  
Vídeos instrucionais  
Vídeos instructivos  
Εκπαιδευτικό βίντεο  
Instruktionsfilmer

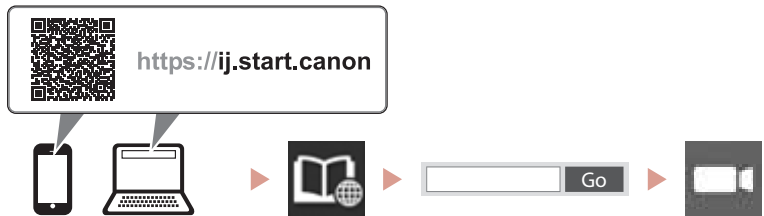

# Setting Up the Printer

**Online Setup**  
<https://ij.start.canon>



## Installation Space

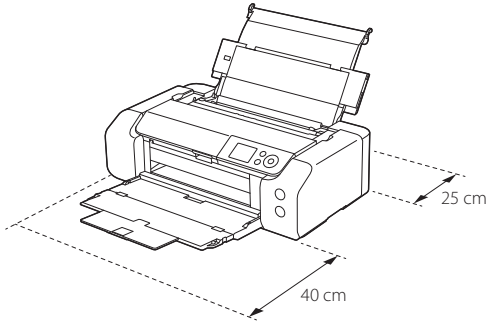

## 1. Box Contents

- Ink Tanks for setup



- Print Head

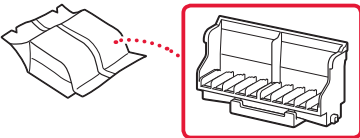

- Multi-purpose Tray

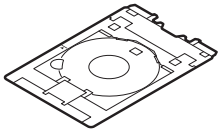

- Power Cord
- Setup CD-ROM for Windows
- Safety and Important Information
- Getting Started (this manual)

## 2. Removing Packing Materials



- 1 Remove and dispose of any packing materials and orange tape.
- 2 Open the top cover, remove and dispose of the orange tape and protective material inside.

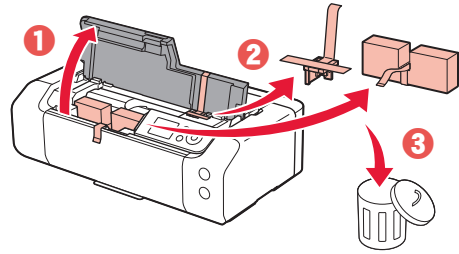

- 3 Close the top cover.

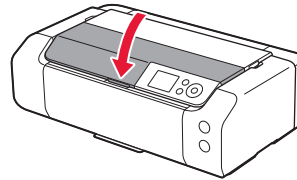

## 3. Turning on the Printer



- 1 Connect the power cord.

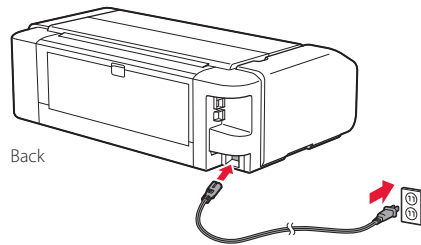

### Important

At this time, do not connect any other cables.

- 2 Press the **ON** button.

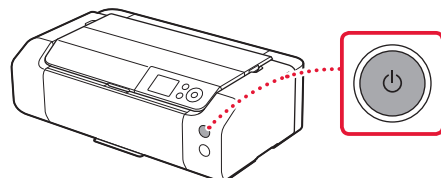

## Setting Up the Printer

- 3 Use the ▲, ▼ and **OK** buttons to select a language.

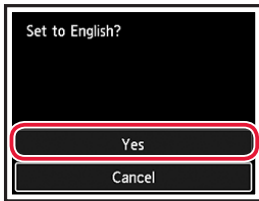
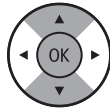

- 4 Press the **OK** button.

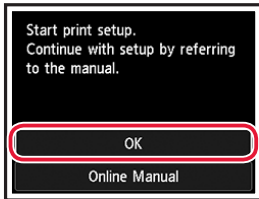

- 5 Set the date and time, and then press the **OK** button.

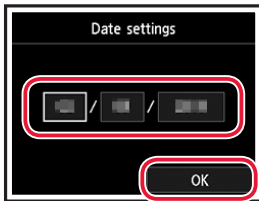

## 4. Installing the Print Head



- 1 Open the paper output tray.

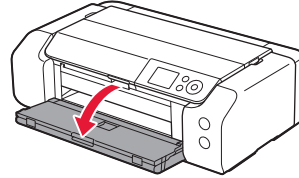

- 2 Open the top cover.

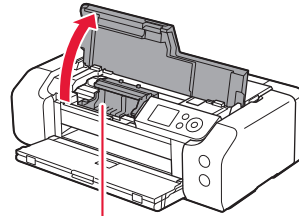

**▲ Caution**

Do not touch the print head holder until it stops moving.

- 3 Firmly raise the print head lock lever until it stops.

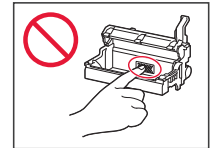
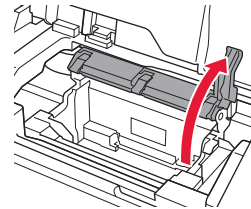

- 4 Remove the print head from its package.

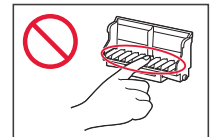
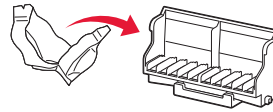

**▶▶▶ Important**

There may be some transparent or light color ink on the inside of the bag the print head comes in - this has no effect on print quality. Be careful not to get ink on yourself when handling these items.

## 5 Remove the protective cap.

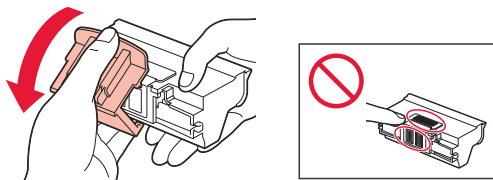

## 6 Set the print head in the print head holder.

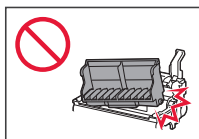
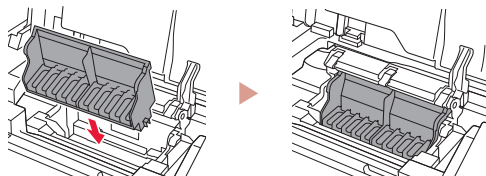

## 7 Lower the print head lock lever completely.

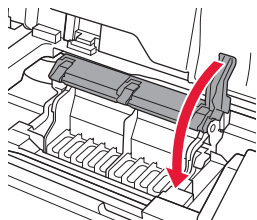

### Important

Once you have installed the print head, do not remove it unnecessarily.

## 5. Installing the Ink Tanks



### 1 Remove the ink tank from the bag, and then slowly remove the orange cap.

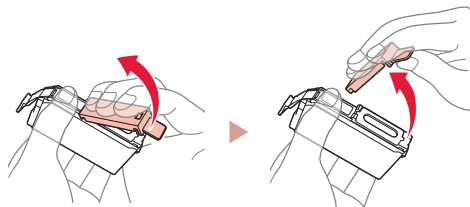

### Important

- Do not squeeze the sides of the ink tank.



- Do not touch the areas shown in the figure.

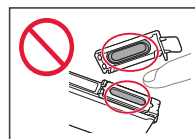

### 2 Install the ink tank.

- Insert the ink tank into the print head and press down until it clicks.

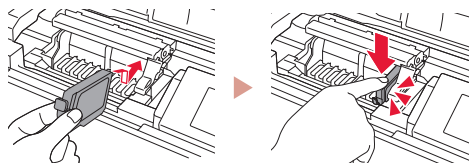

### 3 Check that the color of the ink tank you installed appears on the screen.

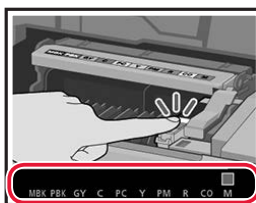

### Important

If the color is not displayed on the screen even though you have installed the ink tank, the color of the ink tank may be wrong or you may have installed an ink tank, such as one with a different model number, that is not supported by this printer. Either install an ink tank for the correct color or use the provided ink tank for setup.

## Setting Up the Printer

- 4 Repeat steps 1 through 3 to install all the ink tanks.

- Check that all the colors appear.

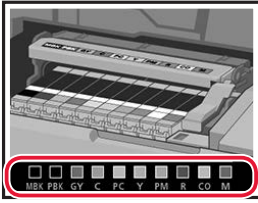

- 5 Close the top cover.

- The printer will start initializing.

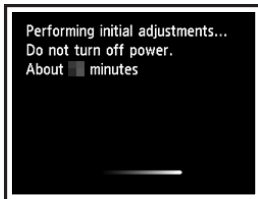
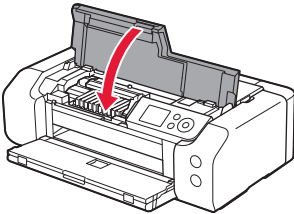

## 6. Loading Paper



- 1 Press the **OK** button.

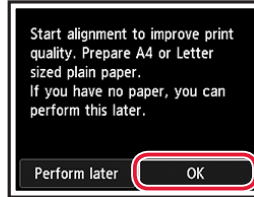

- 2 Open the paper support.

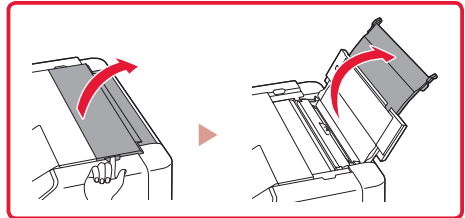
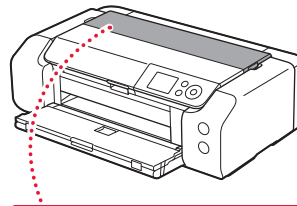

- 3 Open the feed slot cover.

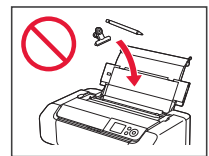
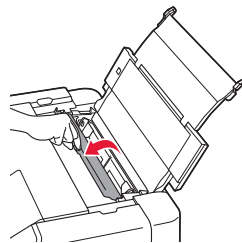

- 4 Slide the right-hand side paper guide to the far right.

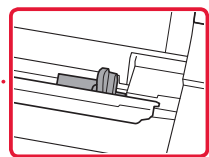
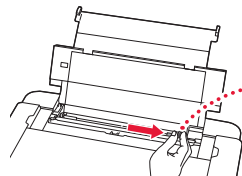

## 5 Load Letter or A4 sized plain paper.

- Load paper with the print side facing up.

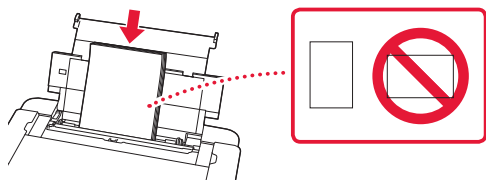

## 6 Slide the side paper guide against the edge of the paper stack.

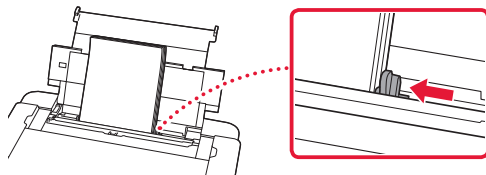

## 7 Close the feed slot cover.

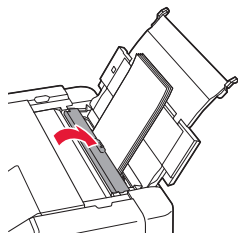

## 8 Open the output tray extension and extend the paper output support.

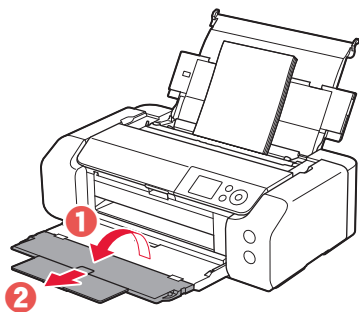

## 9 Press the **OK** button.

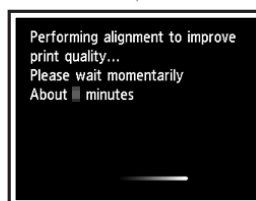
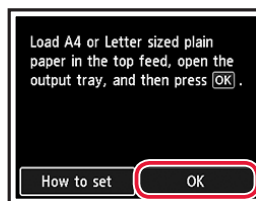

## 10 Press the **OK** button.



- Follow the on-screen instructions to continue setup. This includes making selections related to sending information. Refer to "Sending Information To Canon" in **Safety and Important Information**.
- When **Select the connection method.** appears on the printer's screen, proceed to "7. Selecting a Printer Connection Method" on page 6.

# Setting Up the Printer

## 7. Selecting a Printer Connection Method

Select a printer connection method from the table below. In the following descriptions, "smartphone" is used to refer collectively to smartphones and tablets.

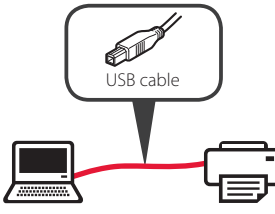
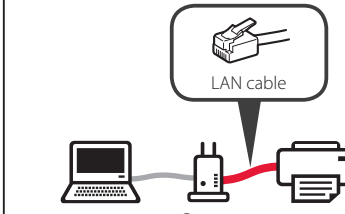
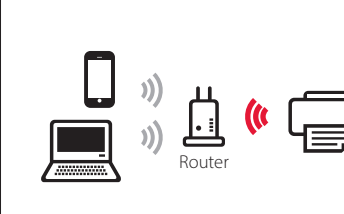
USB connection	Wired LAN connection	Wi-Fi connection
 <p>USB cable</p>	 <p>LAN cable</p> <p>Router</p>	 <p>Router</p>

1 Use the ▲, ▼ and OK buttons to select a connection method.

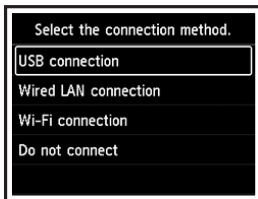

### ▶▶▶ Note

You can set up your connection later, even if you select **Do not connect**.

When setting up the connection at a later time, refer to "8-a. Connecting to a Computer" on page 7 or "8-b. Connecting to a Smartphone" on page 8, and continue setup from your computer or smartphone.

2 Follow the on-screen instructions to proceed with the setup.

- If you select **USB connection** :  
Do not connect a USB cable until instructed.
- If you select **Wired LAN connection** :  
The wired LAN connector is on the back of the printer.

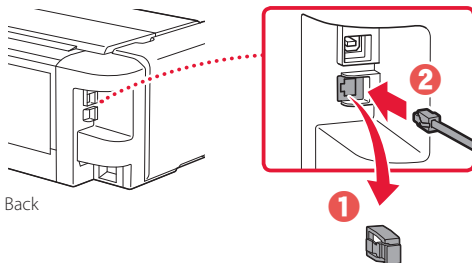

- If you select **Wi-Fi connection** :  
When **Continue to perform Wi-Fi setup from your computer or smartphone. Please confirm.** appears, select **Yes**.

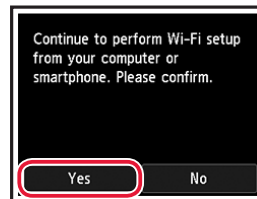

3 When either of the following screens appears, proceed to the next page.





## What device are you connecting?



Computer



Computer and  
smartphone



Smartphone

8-b  
page 8

### 8-a

## Connecting to a Computer

If you are using multiple computers, perform these steps on each computer.



- 1 Access the Canon website from a computer.

<https://ij.start.canon>



- 2 Select  **Set Up**.
- 3 Enter your printer's model name and click **Go**.
  - If prompted, select your country or region.
- 4 Click **Start**.
- 5 Click **If you have already prepared your printer, go to Connect**.

#### ▶▶▶ Note

The following steps are for Windows users.

- 6 Click **Download**.

- 7 Run the downloaded file.

- 8 Click **Start Setup**.

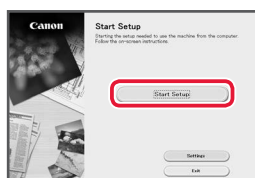

- 9 Follow the on-screen instructions.

- These operations may take some time.
- To connect to a smartphone as well, see "8-b. Connecting to a Smartphone" on page 8.



#### Using the Setup CD-ROM for Windows

Double click **EasySetup.exe** in the CD-ROM, and then continue from step 3. If you do not have an internet connection, open the **win** folder in the CD-ROM and double click **SETUP.exe**. This will install the printer driver.

# Setting Up the Printer

## 8-b

### Connecting to a Smartphone

If you are using multiple smartphones, perform these steps on each smartphone.



Prepare the following before starting.

- 1 Enable the Wi-Fi setting on your smartphone.
  - 2 Connect your smartphone to the wireless router (if you have a wireless router).
- Refer to your smartphone and wireless router manuals for more details.

#### 1 Install the "Canon PRINT Inkjet/SELPHY" app on your smartphone.

- Scan the QR code shown on the right to access the Canon website, and then download the app.



#### 2 Open your smartphone's Wi-Fi settings. Tap the network name (SSID) that starts with "Canon\_ij\_". If "Canon\_ij\_" does not appear, proceed to step 3.

(Example of iOS screen)

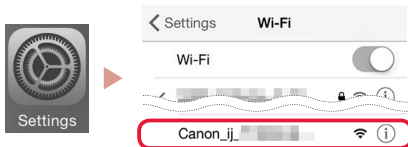

#### 3 Open the installed app.



#### 4 Follow the on-screen instructions in the app to add your printer.

Once you have added your printer, you can print from your smartphone.

# Configuration de l'imprimante

Configuration en ligne  
<https://ij.start.canon>



## Espace d'installation

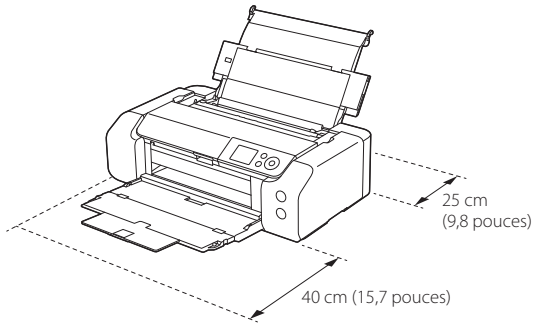

## 1. Contenu de la boîte

- Cartouches d'encre pour la configuration



- Tête d'impression

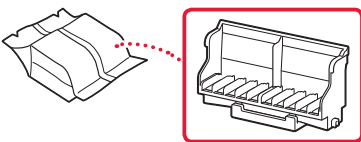

- Tiroir multifonctions

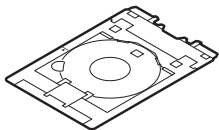

- Cordon d'alimentation
- CD-ROM d'installation pour Windows
- Sécurité et informations importantes
- Démarrage (ce manuel)

## 2. Retrait du matériel d'emballage



- 1 Enlevez et jetez tout matériel d'emballage et bande orange.
- 2 Ouvrez le capot supérieur, retirez et jetez la bande orange et le matériau protecteur se trouvant à l'intérieur.

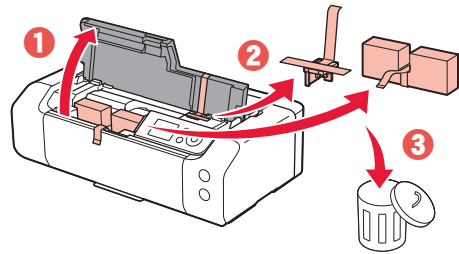

- 3 Fermez le capot supérieur.

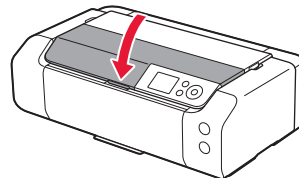

## 3. Mise sous tension de l'imprimante



- 1 Branchez le cordon d'alimentation.

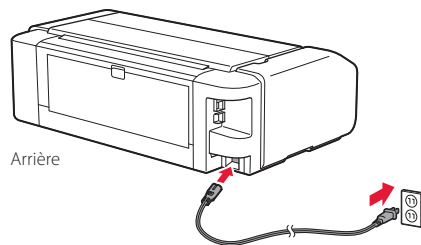

### Important

À ce stade, ne branchez aucun autre câble.

- 2 Appuyez sur le bouton **MARCHE (ON)**.

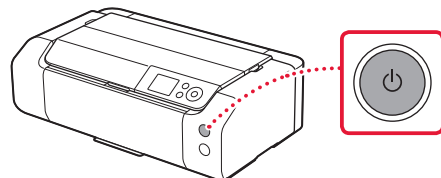

## Configuration de l'imprimante

- 3 Utilisez les boutons ▲, ▼ et **OK** pour sélectionner une langue.

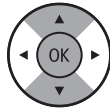
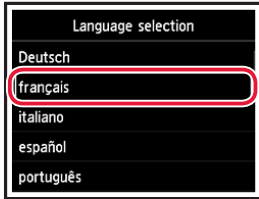

- 4 Appuyez sur le bouton **OK**.

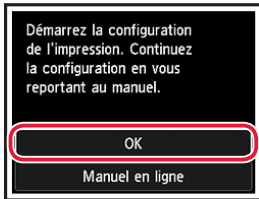

- 5 Définissez la date et l'heure, puis appuyez sur le bouton **OK**.

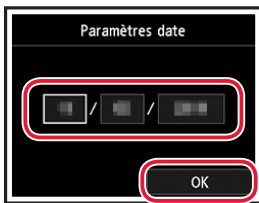

## 4. Installation de la tête d'impression



- 1 Ouvrez le bac de sortie papier.

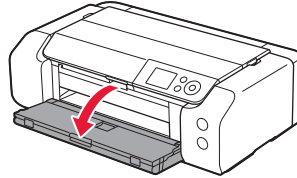

- 2 Ouvrez le capot supérieur.

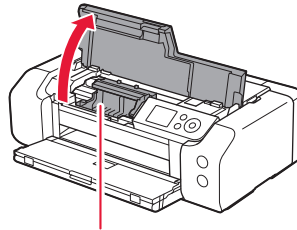

### ⚠ Attention

Évitez tout contact avec le support de tête d'impression tant que celui-ci n'est pas arrêté.

- 3 Levez fermement le levier de verrouillage de tête d'impression jusqu'à ce qu'il s'arrête.

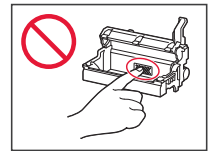
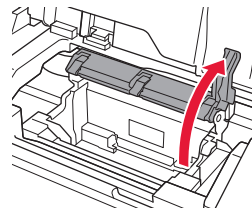

- 4 Sortez la tête d'impression de son paquet.

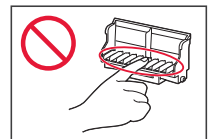
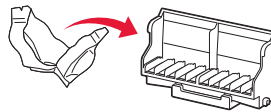

### »»» Important

Il peut y avoir de l'encre transparente ou de couleur claire à l'intérieur du sac contenant la tête d'impression ; ceci n'a aucune incidence sur la qualité de l'impression. Veillez à ne pas vous tacher avec l'encre lorsque vous manipulez ces éléments.

5 Retirez la capsule de protection.

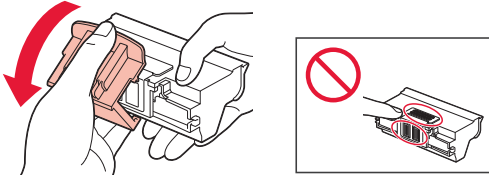

6 Placez la tête d'impression dans le support de tête d'impression.

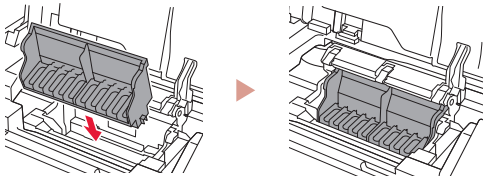

7 Abaissez complètement le levier de verrouillage de tête d'impression.

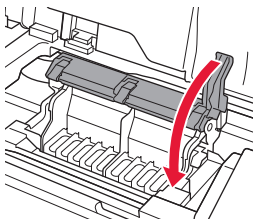

»»» Important

Une fois que vous avez installé la tête d'impression, ne la retirez pas inutilement.

## 5. Installation des cartouches d'encre



1 Sortez la cartouche d'encre du sac, puis retirez doucement le capuchon orange.

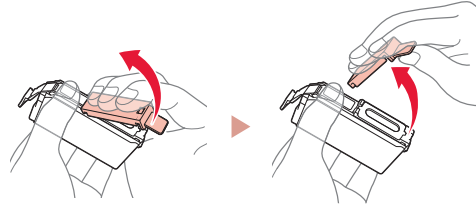

»»» Important

- N'appuyez pas sur les côtés de la cartouche d'encre.
- Ne touchez pas les zones présentées dans la figure.

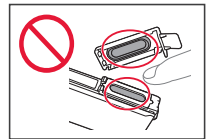
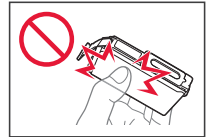

2 Installez la cartouche d'encre.

- Insérez la cartouche d'encre dans la tête d'impression et appuyez dessus jusqu'à ce qu'un clic se produise.

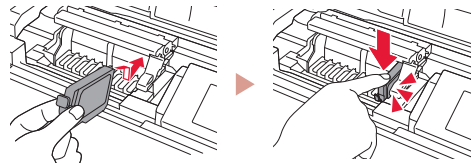

3 Vérifiez que la couleur de la cartouche d'encre que vous avez installée s'affiche à l'écran.

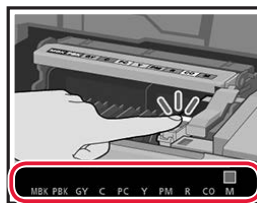

»»» Important

Si la couleur ne s'affiche pas à l'écran alors que vous avez installé la cartouche d'encre, la couleur de la cartouche d'encre est peut-être fautive, ou vous avez peut-être installé une cartouche d'encre non prise en charge par l'imprimante, par exemple une cartouche avec un numéro de modèle différent. Installez une cartouche d'encre de la bonne couleur ou utilisez la cartouche d'encre fournie pour la configuration.

## Configuration de l'imprimante

### 4 Répétez les étapes 1 à 3 pour installer toutes les cartouches d'encre.

- Vérifiez que toutes les couleurs s'affichent.

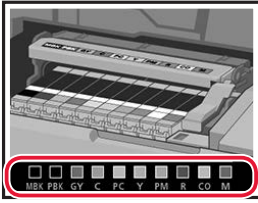

### 5 Fermez le capot supérieur.

- L'imprimante commence à s'initialiser.

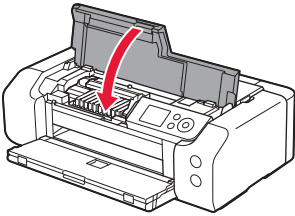

## 6. Chargement du papier



### 1 Appuyez sur le bouton OK.

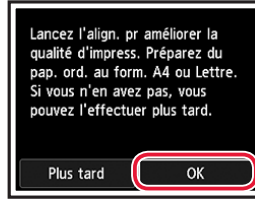

### 2 Ouvrez le support papier.

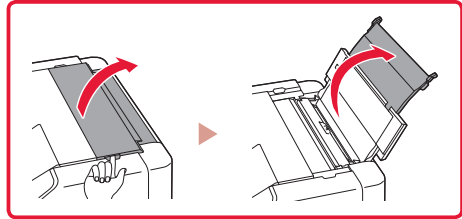
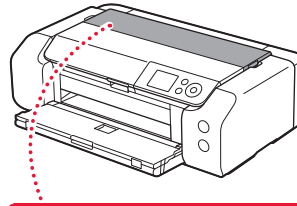

### 3 Ouvrez le couvercle de la fente d'alimentation.

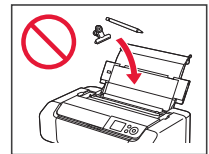
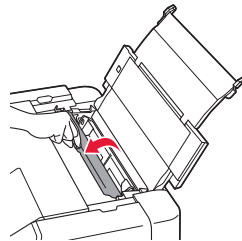

### 4 Faites glisser le côté droit du guide papier vers la droite.

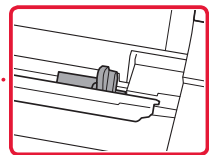
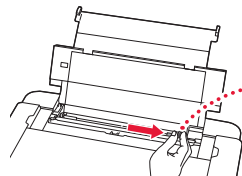

5 Chargez du papier ordinaire au format Lettre ou A4.

- Chargez le papier face à imprimer vers le haut.

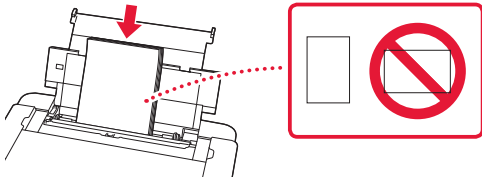

6 Faites glisser le côté du guide papier contre le bord de la pile de papier.

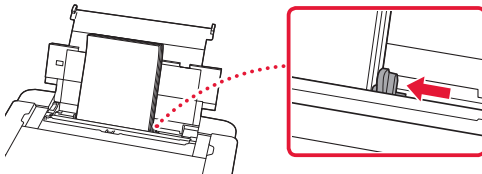

7 Fermez le couvercle de la fente d'alimentation.

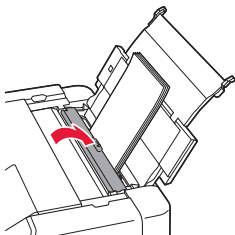

8 Ouvrez l'extension du bac de sortie papier et déployez le support de sortie papier.

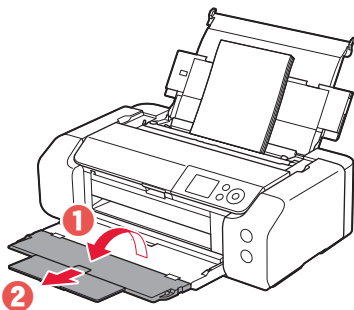

9 Appuyez sur le bouton **OK**.

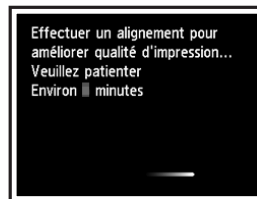
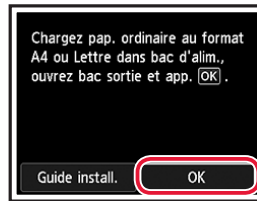

10 Appuyez sur le bouton **OK**.

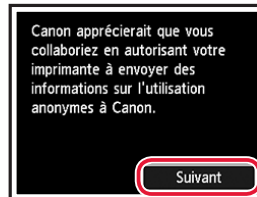

- Suivez les instructions à l'écran pour poursuivre la configuration. Cela inclut des sélections relatives à l'envoi d'informations. Reportez-vous à « Envoi d'informations à Canon » dans **Sécurité et informations importantes**.
- Lorsque **Sélectionner méth. de connexion** apparaît sur l'écran de l'imprimante, passez à la section « 7. Sélection d'une méthode de connexion à l'imprimante » à la page 6.

# Configuration de l'imprimante

## 7. Sélection d'une méthode de connexion à l'imprimante

Sélectionnez une méthode de connexion à l'imprimante dans le tableau ci-dessous. Dans les descriptions suivantes, le terme « smartphone » est utilisé pour désigner collectivement les smartphones et les tablettes.

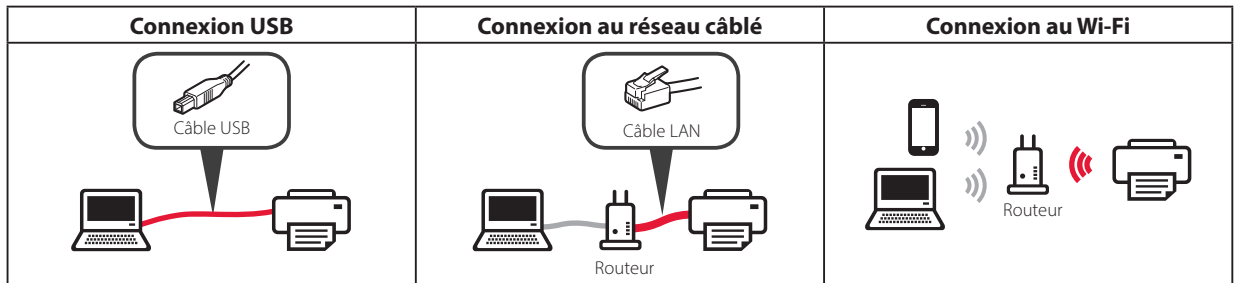

1 Utilisez les boutons ▲, ▼ et OK pour sélectionner une méthode de connexion.

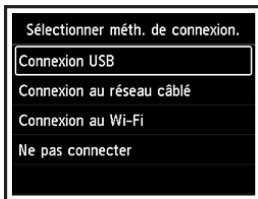

### Remarque

Vous pouvez définir votre connexion ultérieurement, même si vous sélectionnez **Ne pas connecter**.

Lorsque vous définissez la connexion ultérieurement, reportez-vous à la section « 8-a. Connexion à un ordinateur » à la page 7 ou « 8-b. Connexion à un smartphone » à la page 8 et poursuivez la configuration de votre ordinateur ou de votre smartphone.

2 Suivez les instructions à l'écran pour poursuivre la configuration.

- Si vous sélectionnez **Connexion USB** :  
Ne branchez pas de câble USB tant que vous n'en recevez pas l'instruction.
- Si vous sélectionnez **Connexion au réseau câblé** :  
Le connecteur de réseau câblé se trouve à l'arrière de l'imprimante.

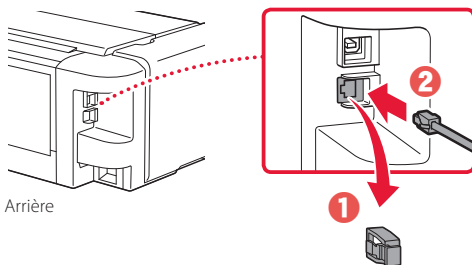

- Si vous sélectionnez **Connexion au Wi-Fi** :  
Lorsque **Poursuivre la configuration Wi-Fi depuis votre ordi./smartphone. Veuillez confirmer.** s'affiche, sélectionnez **Oui**.

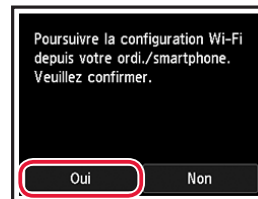

3 Lorsqu'un des écrans suivants s'affiche, passez à la page suivante.

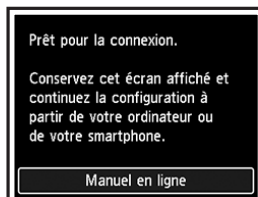



## Quel périphérique connectez-vous ?



Ordinateur



Ordinateur et  
smartphone



Smartphone

8-b  
page 8

### 8-a

## Connexion à un ordinateur

Si vous utilisez plusieurs ordinateurs, effectuez ces étapes sur chaque ordinateur.



- 1 Accédez au site Web Canon à partir d'un ordinateur.

<https://ij.start.canon>



- 2 Sélectionnez  **Configuration**.

- 3 Entrez le nom de modèle de votre imprimante et cliquez sur **Accéder**.

- Si vous y êtes invité, sélectionnez votre pays ou votre région.

- 4 Cliquez sur **Démarrer**.

- 5 Cliquez sur **Si vous avez déjà préparé votre imprimante, allez à Connecter**.

#### »»» Remarque

Les étapes suivantes concernent les utilisateurs Windows.

- 6 Cliquez sur **Télécharger**.

- 7 Exécutez le fichier téléchargé.

- 8 Cliquez sur **Commencer la configuration**.

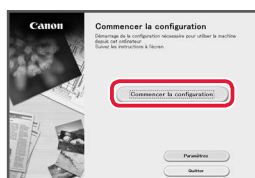

- 9 Suivez les instructions à l'écran.

- Ces opérations peuvent prendre du temps.
- Pour vous connecter aussi à un smartphone, voir « 8-b. Connexion à un smartphone » à la page 8.



#### Utilisation du CD-ROM d'installation pour Windows

Cliquez deux fois sur **EasySetup.exe** à partir du CD-ROM, puis continuez à partir de l'étape 3. Si vous ne disposez pas d'une connexion Internet, ouvrez le dossier **win** à partir du CD-ROM et cliquez deux fois sur **SETUP.exe**. Cette procédure permet d'installer le pilote d'imprimante.

## 8-b

### Connexion à un smartphone

Si vous utilisez plusieurs smartphones, effectuez ces étapes sur chaque smartphone.



Préparez les éléments suivants avant de démarrer.

- 1 Activez le paramètre Wi-Fi sur votre smartphone.
  - 2 Connectez votre smartphone au routeur sans fil (si vous disposez d'un routeur sans fil).
- Pour plus d'informations, consultez la documentation de votre smartphone et du routeur sans fil.

#### 1 Installez l'application « Canon PRINT Inkjet/SELPHY » sur votre smartphone.

- Scannez le code QR qui apparaît à droite pour accéder au site Web Canon, puis téléchargez l'application.



#### 2 Ouvrez les paramètres Wi-Fi de votre smartphone. Touchez le nom du réseau (SSID) qui commence par « Canon\_ij\_ ». Si « Canon\_ij\_ » n'apparaît pas, passez à l'étape 3.

(Exemple d'écran iOS)



#### 3 Ouvrez l'application installée.



#### 4 Suivez les instructions à l'écran fournies par l'application pour ajouter votre imprimante.

---

Une fois que vous avez ajouté votre imprimante, vous pouvez imprimer depuis votre smartphone.

---

# Einrichten des Druckers

Onlineeinrichtung  
<https://ij.start.canon>



## Benötigter Platz für die Installation

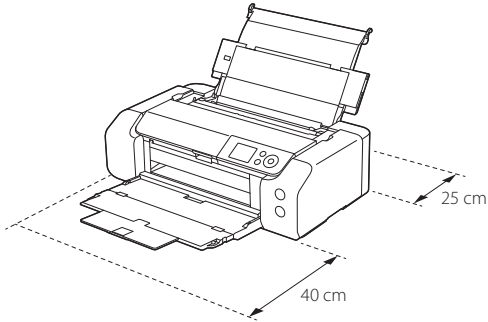

## 1. Inhalt der Box

- Tintenbehälter für die Einrichtung



- Druckkopf

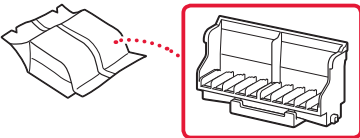

- Multifunktionsfach

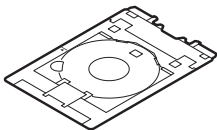

- Netzkabel
- Installations-CD-ROM für Windows
- Sicherheitsinformationen und wichtige Hinweise
- Inbetriebnahme (dieses Handbuch)

## 2. Entfernen des Verpackungsmaterials



- 1 Entfernen und entsorgen Sie das gesamte Verpackungsmaterial sowie das orangefarbene Klebeband.
- 2 Öffnen Sie die obere Abdeckung, entfernen und entsorgen Sie das orangefarbene Klebeband und das Schutzmaterial aus dem Inneren.

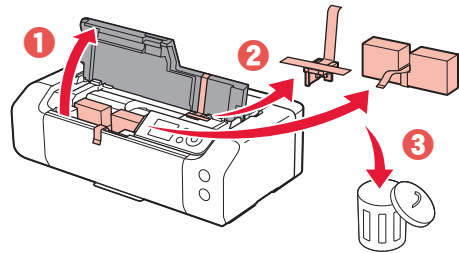

- 3 Schließen Sie die obere Abdeckung.

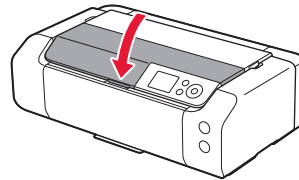

## 3. Einschalten des Druckers



- 1 Schließen Sie das Netzkabel an.

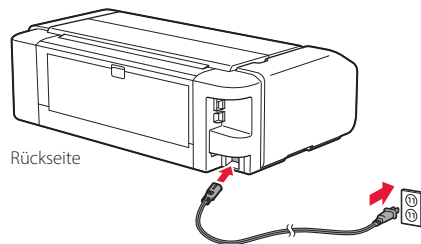

### Wichtig

Schließen Sie zum jetzigen Zeitpunkt keine weiteren Kabel an.

- 2 Drücken Sie die Taste **EIN (ON)**.

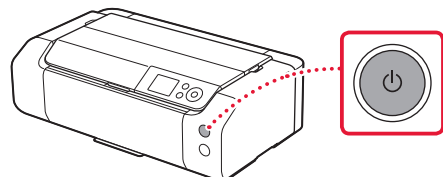

## Einrichten des Druckers

- 3 Verwenden Sie die Tasten ▲, ▼ und **OK**, um eine Sprache auszuwählen.

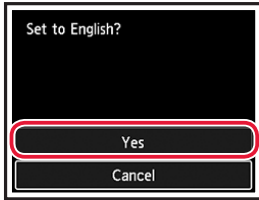
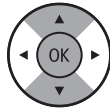

- 4 Drücken Sie die Taste **OK**.

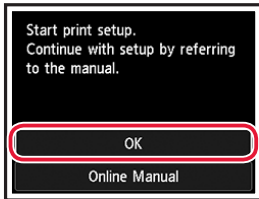

- 5 Stellen Sie Datum und Uhrzeit ein und drücken Sie dann die Taste **OK**.

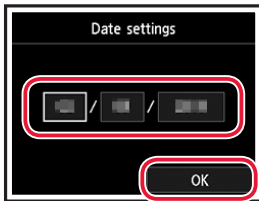

## 4. Installation des Druckkopfs



- 1 Öffnen Sie das Papierausgabefach.

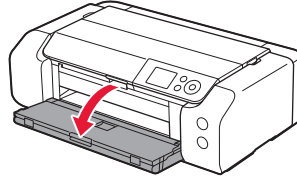

- 2 Öffnen Sie die obere Abdeckung.

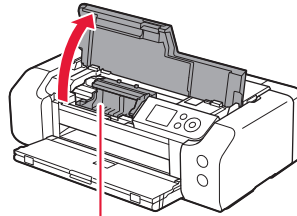

**⚠ Vorsicht**

Berühren Sie den Druckkopfhalter nicht, solange er sich bewegt.

- 3 Ziehen Sie den Sperrhebel für den Druckkopf bis zum Anschlag hoch.

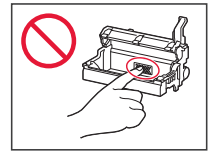
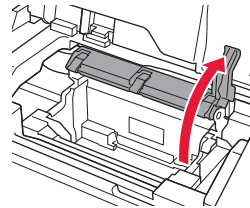

- 4 Entnehmen Sie den Druckkopf aus seiner Verpackung.

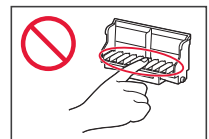
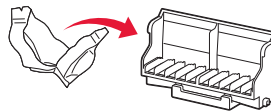

**»»» Wichtig**

Möglicherweise befindet sich etwas transparente oder helle Tinte auf der Innenseite der Tüte, in der der Druckkopf geliefert wird – dies hat keine Auswirkungen auf die Druckqualität. Achten Sie darauf, sich beim Umgang mit diesen Objekten nicht mit Tinte zu beschmutzen.

## 5 Entfernen Sie die Schutzkappe.

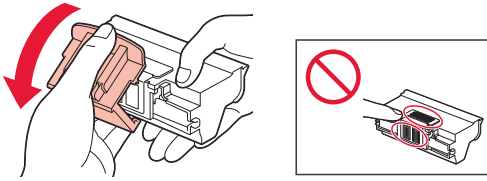

## 6 Setzen Sie den Druckkopf in den Druckkopfhalter ein.

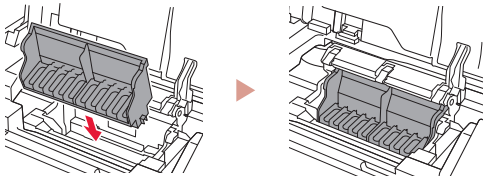

## 7 Drücken Sie den Sperrhebel für den Druckkopf vollständig nach unten.

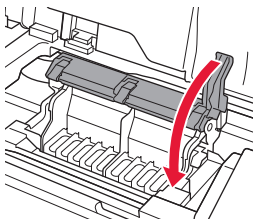

### Wichtig

Entfernen Sie den Druckkopf nach dem Einsetzen nicht unnötigerweise.

## 5. Installation der Tintenbehälter



### 1 Nehmen Sie den Tintenbehälter aus der Verpackung und entfernen Sie vorsichtig die orangefarbene Kappe.

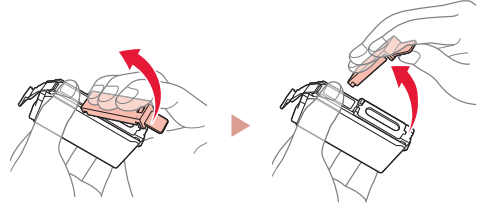

### Wichtig

- Quetschen Sie die Seiten des Tintenbehälters nicht zusammen.
- Berühren Sie nicht die in der Abbildung gezeigten Bereiche.

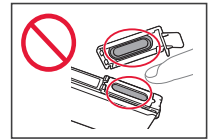
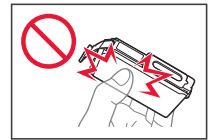

### 2 Setzen Sie den Tintenbehälter ein.

- Setzen Sie den Tintenbehälter in den Druckkopf ein und drücken Sie ihn nach unten, bis er einrastet.

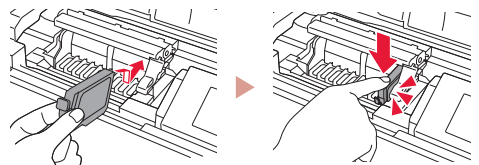

### 3 Überprüfen Sie, ob die Farbe des eingesetzten Tintenbehälters auf dem Bildschirm angezeigt wird.

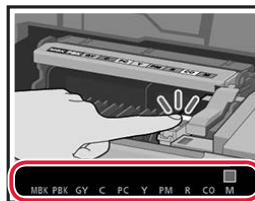

### Wichtig

Wenn die Farbe nicht auf dem Bildschirm angezeigt wird, obwohl Sie den Tintenbehälter eingesetzt haben, ist die Farbe des Tintenbehälters möglicherweise falsch oder Sie haben beispielsweise einen Tintenbehälter mit einer anderen Modellnummer eingesetzt, der von diesem Drucker nicht unterstützt wird. Setzen Sie entweder einen Tintenbehälter der richtigen Farbe ein oder verwenden Sie den im Lieferumfang enthaltenen Tintenbehälter für die Einrichtung.

## Einrichten des Druckers

### 4 Wiederholen Sie die Schritte 1 bis 3, um alle Tintenbehälter einzusetzen.

- Überprüfen Sie, ob alle Farben angezeigt werden.

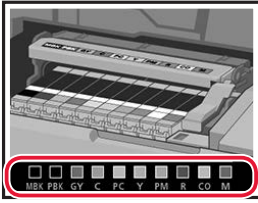

### 5 Schließen Sie die obere Abdeckung.

- Der Drucker wird initialisiert.

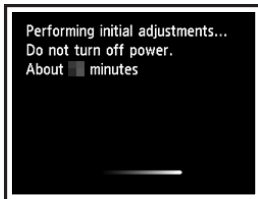
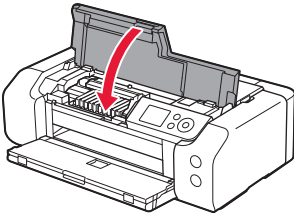

## 6. Einlegen von Papier



### 1 Drücken Sie die Taste **OK**.

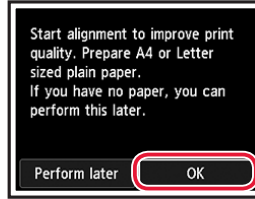

### 2 Öffnen Sie die Papierstütze.

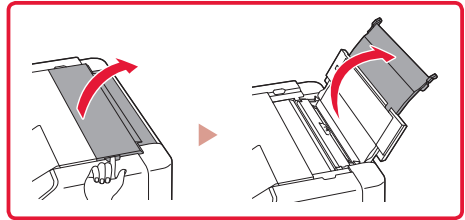
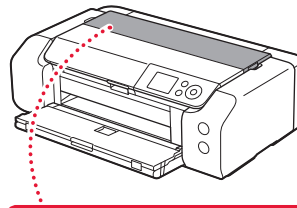

### 3 Öffnen Sie die Abdeckung für den Einzugschacht.

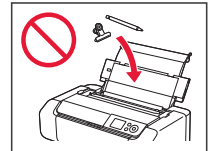
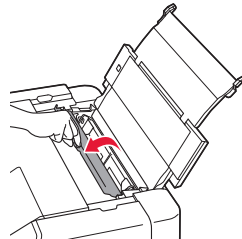

### 4 Schieben Sie die Papierführung auf der rechten Seite ganz nach rechts.

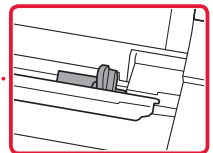
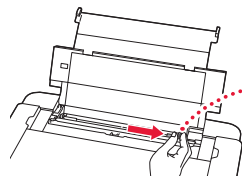

5 Legen Sie Normalpapier des Formats Letter oder A4 ein.

- Legen Sie Papier mit der bedruckbaren Seite nach oben ein.

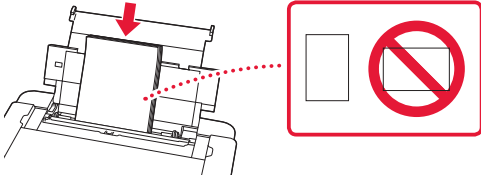

6 Schieben Sie die seitliche Papierführung gegen die Kante des Papierstapels.

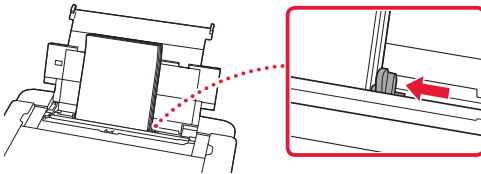

7 Schließen Sie die Abdeckung für den Einzugschacht.

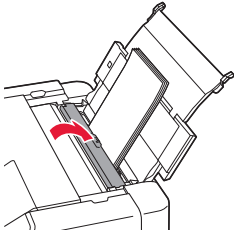

8 Öffnen Sie die Verlängerung des Ausgabefachs und ziehen Sie die Papierausgabestütze heraus.

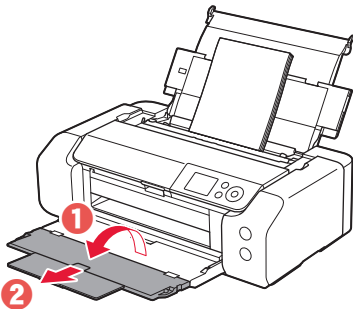

9 Drücken Sie die Taste **OK**.

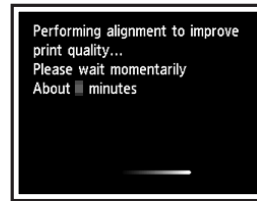
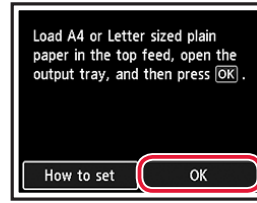

10 Drücken Sie die Taste **OK**.



- Befolgen Sie die Anweisungen auf dem Bildschirm, um mit der Einrichtung fortzufahren. Dazu gehört das Vornehmen von Auswahlen, die im Zusammenhang mit dem Senden von Informationen stehen. Siehe „Information an Canon senden“ in **Sicherheitsinformationen und wichtige Hinweise**.
- Wenn auf dem Bildschirm des Druckers **Verbindungsmethode auswählen. (Select the connection method.)** angezeigt wird, fahren Sie fort mit „7. Auswahl einer Druckeranschlussmethode“ auf Seite 6.

# Einrichten des Druckers

## 7. Auswahl einer Druckeranschlussmethode

Wählen Sie aus der nachfolgenden Tabelle eine Druckeranschlussmethode aus. In den folgenden Beschreibungen wird der Begriff „Smartphone“ als Sammelbegriff für Smartphones und Tablets verwendet.

USB-Verbindung (USB connection)	Drahtgebundenes LAN-Verb. (Wired LAN connection)	Wi-Fi-Verbindung (Wi-Fi connection)

1 Verwenden Sie die Tasten ▲, ▼ und OK, um eine Verbindungsmethode auszuwählen.

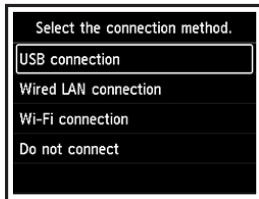

### »»» Hinweis

Falls Sie **Nicht verbinden (Do not connect)** auswählen, können Sie Ihre Verbindung auch noch zu einem späteren Zeitpunkt einrichten.

Wenn Sie die Verbindung zu einem späteren Zeitpunkt einrichten möchten, finden Sie die Anleitung dazu unter „8-a. Herstellen einer Verbindung mit einem Computer“ auf Seite 7 oder „8-b. Herstellen einer Verbindung mit einem Smartphone“ auf Seite 8. Sie können dann die Einrichtung von Ihrem Computer oder Smartphone aus fortsetzen.

2 Befolgen Sie die Anweisungen auf dem Bildschirm, um mit der Einrichtung fortzufahren.

- Wenn Sie **USB-Verbindung (USB connection)** auswählen:

Schließen Sie kein USB-Kabel an, bevor Sie dazu aufgefordert werden.

- Wenn Sie **Drahtgebundenes LAN-Verb. (Wired LAN connection)** auswählen:

Der Anschluss für drahtgebundenes LAN befindet sich auf der Rückseite des Druckers.

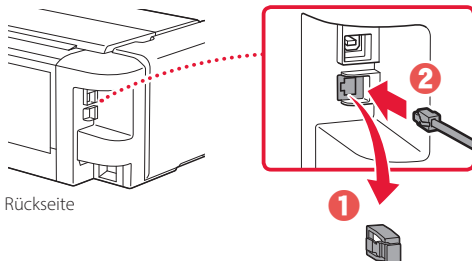

Rückseite

- Wenn Sie **Wi-Fi-Verbindung (Wi-Fi connection)** auswählen:

Wenn **Wi-Fi-Einrichtung über Computer oder Smartphone fortsetzen. Bitte bestätigen. (Continue to perform Wi-Fi setup from your computer or smartphone. Please confirm.)** angezeigt wird, wählen Sie **Ja (Yes)**.

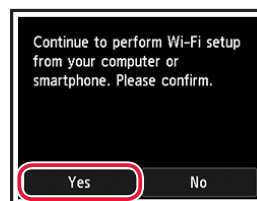

3 Wenn einer der folgenden Bildschirme angezeigt wird, fahren Sie auf der nächsten Seite fort.

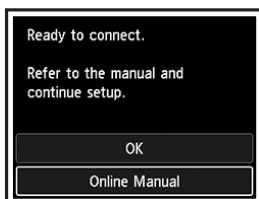



## Mit welchem Gerät stellen Sie eine Verbindung her?



Computer



Computer und  
Smartphone



Smartphone

8-b  
Seite 8

8-a

## Herstellen einer Verbindung mit einem Computer

Wenn Sie mehrere Computer verwenden, führen Sie diese Schritte auf jedem Computer aus.



- 1 Greifen Sie von einem Computer aus auf die Canon-Website zu.

<https://ij.start.canon>



- 2 Wählen Sie  **Einrichten** aus.
- 3 Geben Sie den Modellnamen Ihres Druckers ein und klicken Sie auf **Los**.
  - Wählen Sie Ihr Land oder Ihre Region aus, wenn Sie dazu aufgefordert werden.
- 4 Klicken Sie auf **Start**.
- 5 Klicken Sie auf **Wenn Sie Ihren Drucker bereits vorbereitet haben, wechseln Sie zu Verbindung herstellen**.

### »»» Hinweis

Die folgenden Schritte gelten für Benutzer von Windows.

- 6 Klicken Sie auf **Herunterladen**.

- 7 Führen Sie die heruntergeladene Datei aus.

- 8 Klicken Sie auf **Setup starten (Start Setup)**.

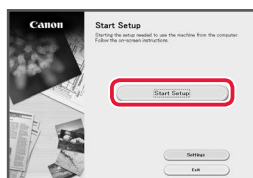

- 9 Befolgen Sie die Anweisungen auf dem Bildschirm.

- Diese Verfahren können einige Zeit dauern.
- Um auch eine Verbindung mit einem Smartphone herzustellen, lesen Sie unter „8-b. Herstellen einer Verbindung mit einem Smartphone“ auf Seite 8.



Verwenden der Installations-CD-ROM für Windows

Doppelklicken Sie auf **EasySetup.exe** auf der CD-ROM und fahren Sie dann bei Schritt 3 fort. Wenn Sie keinen Internetzugang haben, öffnen Sie den Ordner **win** auf der CD-ROM und doppelklicken Sie auf **SETUP.exe**. Dadurch wird der Druckertreiber installiert.

## 8-b

### Herstellen einer Verbindung mit einem Smartphone

Wenn Sie mehrere Smartphones verwenden, führen Sie diese Schritte auf jedem Smartphone aus.



Bereiten Sie Folgendes vor, bevor Sie beginnen.

- 1 Aktivieren Sie die Wi-Fi-Einstellung auf Ihrem Smartphone.
- 2 Stellen Sie eine Verbindung zwischen Ihrem Smartphone und dem Wireless Router her (wenn Sie über einen Wireless Router verfügen). Weitere Informationen finden Sie in den Handbüchern zu Ihrem Smartphone und dem Wireless Router.

#### 1 Installieren Sie die App „Canon PRINT Inkjet/SELPHY“ auf Ihrem Smartphone.

- Scannen Sie den QR-Code auf der rechten Seite, um die Canon-Website aufzurufen, und laden Sie dann die App herunter.



#### 2 Öffnen Sie die Wi-Fi-Einstellungen auf Ihrem Smartphone. Tippen Sie auf den Namen des Netzwerks (SSID), das mit „Canon\_ij\_“ beginnt. Wenn „Canon\_ij\_“ nicht angezeigt wird, fahren Sie mit Schritt 3 fort.

(Beispiel für iOS-Bildschirm)

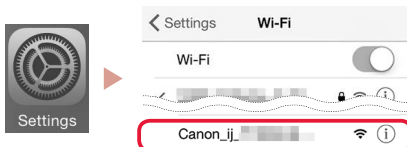

#### 3 Öffnen Sie die installierte App.



#### 4 Befolgen Sie die Anweisungen auf dem App-Bildschirm, um Ihren Drucker hinzuzufügen.

Sobald Sie Ihren Drucker hinzugefügt haben, können Sie über Ihr Smartphone drucken.

# De printer instellen

## Online installatie

<https://ij.start.canon>



### Installatieoppervlak

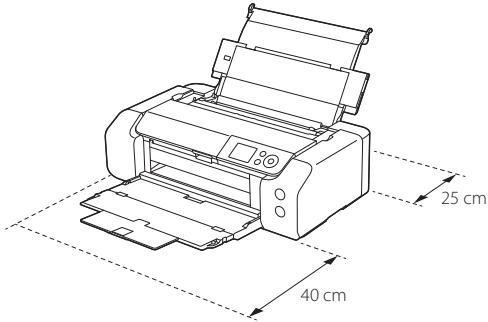

## 1. Inhoud van de doos

### ● Inktanks voor instelling



### ● Printkop

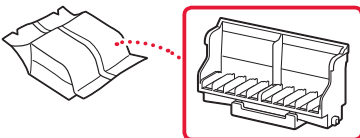

### ● Multifunctionele lade

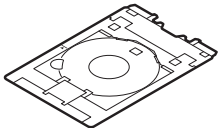

### ● Netsnoer

### ● Installatie-cd-rom voor Windows

### ● Veiligheidsinformatie en belangrijke informatie

### ● Aan de Slag-gids (deze handleiding)

## 2. Verpakkingsmateriaal verwijderen



- 1 Verwijder het verpakkingsmateriaal en de oranje tape en gooi het weg.
- 2 Open de bovenklep, verwijder de oranje tape en het beschermende materiaal erin en gooi het weg.

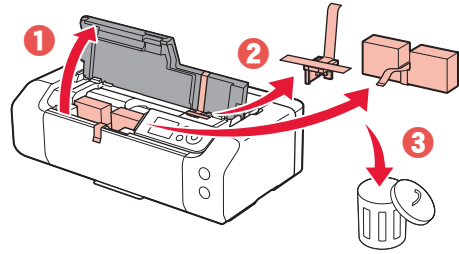

- 3 Sluit de bovenklep.

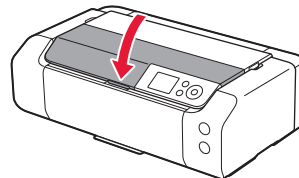

## 3. De printer inschakelen



- 1 Sluit het netsnoer aan.

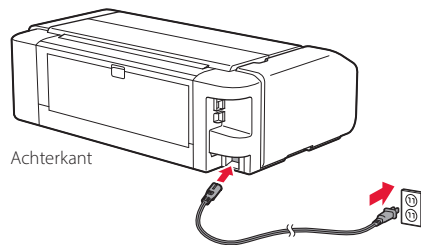

### ▶▶▶ Belangrijk

Sluit op dit moment nog geen andere kabels aan.

- 2 Druk op de knop **AAN (ON)**.

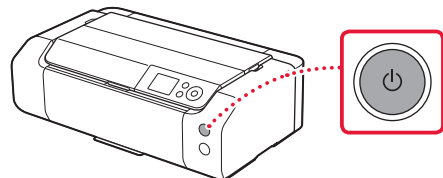

## De printer instellen

- 3 Gebruik de knoppen ▲, ▼ en **OK** om een taal te selecteren.

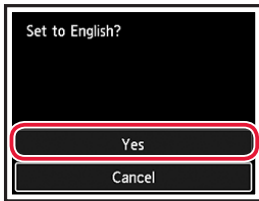
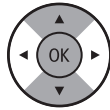

- 4 Druk op de knop **OK**.

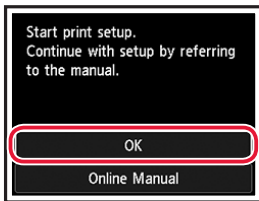

- 5 Stel de datum en tijd in en druk daarna op de knop **OK**.

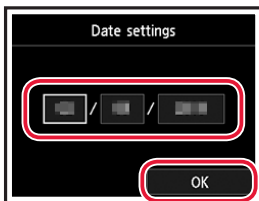

## 4. De printkop installeren



- 1 Open de papieruitvoerlade.

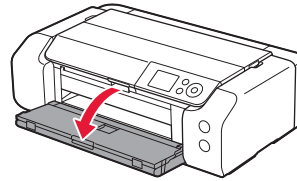

- 2 Open de bovenklep.

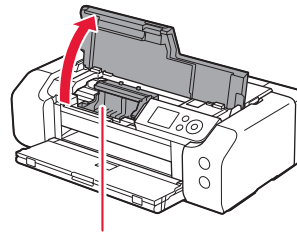

**▲ Let op**

Raak de printkophouder niet aan totdat deze stopt met bewegen.

- 3 Duw de printkopvergrendeling goed omhoog totdat deze stopt.

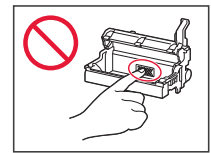
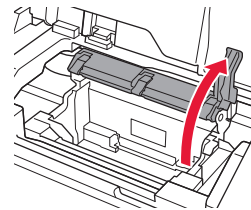

- 4 Haal de printkop uit de verpakking.

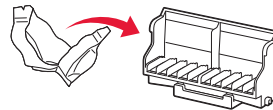

**»»» Belangrijk**

Er zit mogelijk wat transparante of lichte inkt op de binnenkant van de zak waarin de printkop wordt geleverd, maar dit is niet van invloed op de afdrukkwaliteit. Wees voorzichtig dat u geen inkt op u krijgt wanneer u deze items vastpakt.

## 5 Verwijder het beschermkapje.

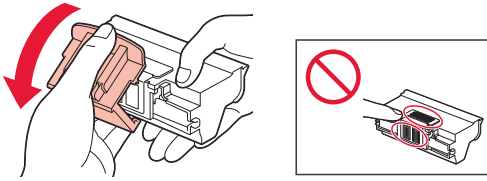

## 6 Plaats de printkop in de printkophouder.

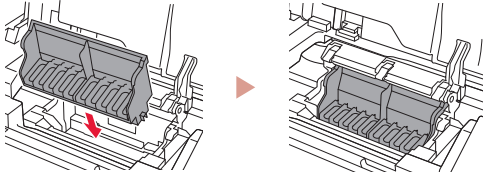

## 7 Duw de printkopvergrendeling helemaal omlaag.

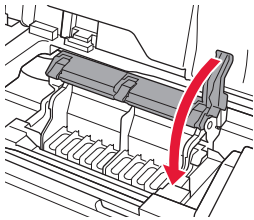

### Belangrijk

Nadat u de printkop hebt geïnstalleerd, mag u deze niet onnodig verwijderen.

## 5. De inktanks installeren



### 1 Haal de inktank uit de zak en verwijder langzaam het oranje kapje.

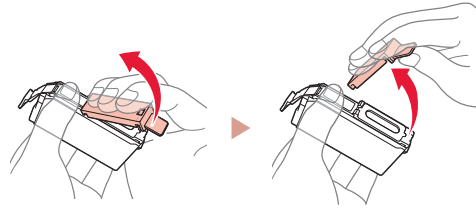

### Belangrijk

- Druk niet op de zijkanten van de inktank.

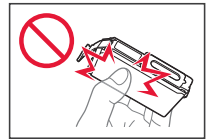

- Raak de aangegeven gebieden in de afbeelding niet aan.

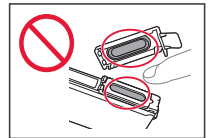

### 2 Installeer de inktank.

- Plaats de inktank in de printkop en druk deze omlaag totdat hij klikt.

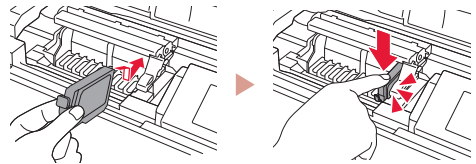

### 3 Controleer of de kleur van de geplaatste inktank op het scherm wordt weergegeven.

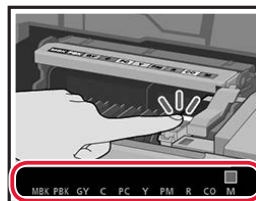

### Belangrijk

Als de kleur niet op het scherm wordt weergegeven, ook al hebt u de inktank geplaatst, dan is de kleur van de inktank mogelijk onjuist of hebt u mogelijk een inktank met een ander modelnummer geïnstalleerd die niet wordt ondersteund door deze printer. Plaats een inktank voor de juiste kleur of gebruik de bijgeleverde inktank voor de installatie.

## De printer instellen

- 4 Herhaal de stappen 1 tot en met 3 om alle inkttanks te plaatsen.
- Controleer of alle kleuren worden weergegeven.

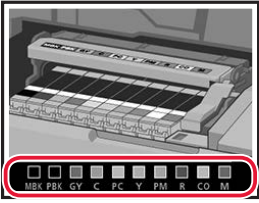

- 5 Sluit de bovenklep.
- De initialisatie van de printer wordt gestart.

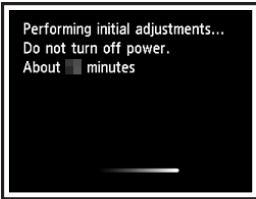
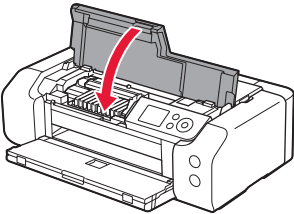

## 6. Papier plaatsen



- 1 Druk op de knop **OK**.

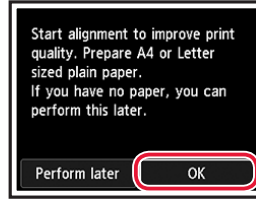

- 2 Open de papiersteun.

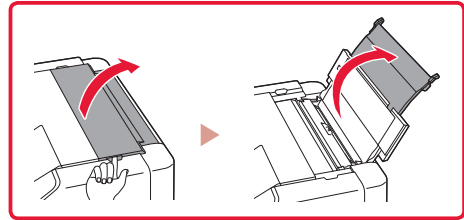
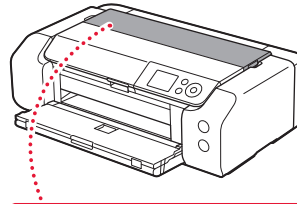

- 3 Open het klepje over de invoersleuf.

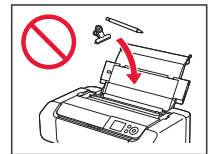
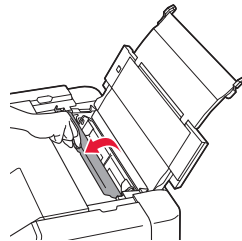

- 4 Schuif de rechterpapiergeleider helemaal naar rechts.

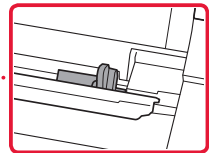
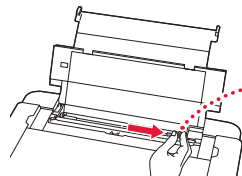

- 5 Plaats normaal papier van Letter- of A4-formaat.
- Plaats papier met de afdrukzijde omhoog gericht.

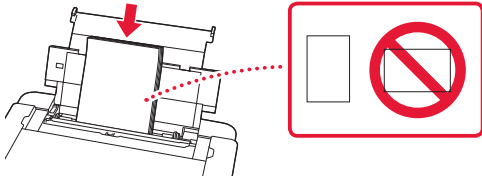

- 6 Schuif de papiergeleider vanaf de zijkant tegen de rand van de papierstapel.

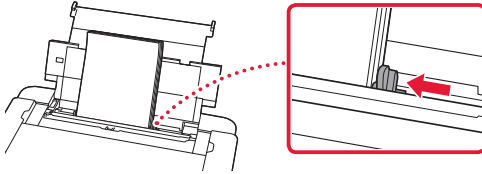

- 7 Sluit het klepje over de invoersleuf.

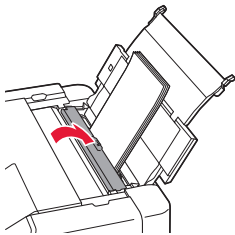

- 8 Open het verlengstuk van de uitvoerlade en trek de papieruitvoersteun uit.

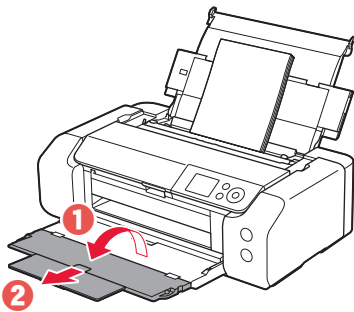

- 9 Druk op de knop **OK**.

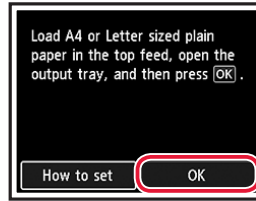

- 10 Druk op de knop **OK**.





- Volg de instructies op het scherm om door te gaan met de installatie. Hierbij moet u selecties maken die betrekking hebben op het verzenden van informatie. Raadpleeg "Gegevens verzenden naar Canon" in **Veiligheidsinformatie en belangrijke informatie**.
- Wanneer **Selecteer de verbindingmethode (Select the connection method.)** wordt weergegeven op het scherm van de printer, gaat u verder met "7. Een printerverbindingmethode selecteren" op pagina 6.

# De printer instellen

## 7. Een printerverbindingmethode selecteren

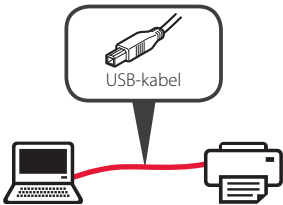
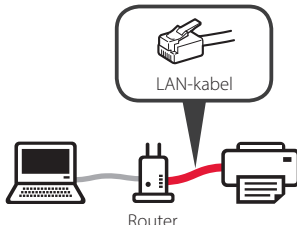
Selecteer een printerverbindingmethode in de onderstaande tabel. In de volgende omschrijvingen wordt de term "smartphone" gebruikt om te verwijzen naar smartphones en tablets.

USB-verbinding (USB connection)	Bedrade LAN-verbinding (Wired LAN connection)	Wi-Fi-verbinding (Wi-Fi connection)
		

1 Gebruik de knoppen ▲, ▼ en OK om een verbindingmethode te selecteren.

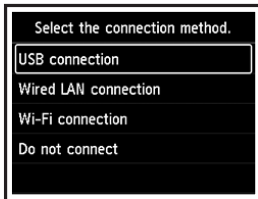

### Opmerking

U kunt de verbinding later instellen, zelfs als u **Niet verbinden (Do not connect)** selecteert.

Wanneer u de verbinding later instelt, raadpleegt u "8-a. Verbinden met een computer" op pagina 7 of "8-b. Verbinden met een smartphone" op pagina 8 en gaat u door met de installatie vanaf uw computer of smartphone.

2 Volg de instructies op het scherm om door te gaan met de installatie.

- Als u **USB-verbinding (USB connection)** selecteert: Sluit pas een USB-kabel aan wanneer dat wordt vermeld.
- Als u **Bedrade LAN-verbinding (Wired LAN connection)** selecteert: De aansluiting voor bedraad LAN zit aan de achterkant van de printer.

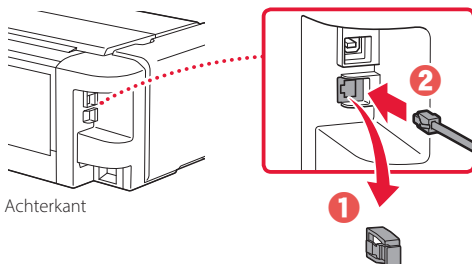

- Als u **Wi-Fi-verbinding (Wi-Fi connection)** selecteert: Selecteer **Ja (Yes)** wanneer **Ga verder met Wi-Fi-instelling op uw computer of smartphone. Graag bevestigen. (Continue to perform Wi-Fi setup from your computer or smartphone. Please confirm.)** wordt weergegeven.

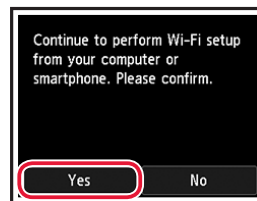

3 Wanneer een van de volgende schermen wordt weergegeven, gaat u verder met de volgende stap.

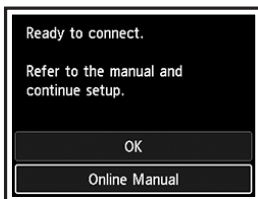



## Met welk apparaat maakt u verbinding?



Computer



Computer en  
smartphone



Smartphone

8-b  
pagina 8

### 8-a

## Verbinden met een computer

Als u meerdere computers gebruikt, voert u deze stappen uit op elke computer.



- 1 Ga naar de Canon-website op een computer.

<https://ij.start.canon>



- 2 Selecteer  **Installatie**.
- 3 Voer de modelnaam van de printer in en klik op **Ga**.
  - Selecteer uw land of regio wanneer u daarom wordt gevraagd.
- 4 Klik op **Start**.
- 5 Klik op **Als u uw printer al hebt voorbereid, gaat u naar Verbinden**.

#### »»» Opmerking

De volgende stappen zijn bedoeld voor Windows-gebruikers.

- 6 Klik op **Downloaden**.

- 7 Voer het gedownloadde bestand uit.

- 8 Klik op **Beginnen met instellen (Start Setup)**.

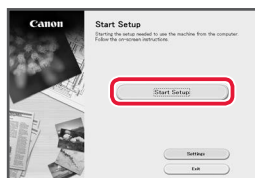

- 9 Volg de instructies op het scherm.

- Deze handelingen kunnen enige tijd duren.
- Als u ook verbinding wilt maken met een smartphone, raadpleegt u "8-b. Verbinden met een smartphone" op pagina 8.



De installatie-cd-rom gebruiken voor Windows

Dubbelklik op **EasySetup.exe** vanaf de cd-rom en ga verder vanaf stap 3. Als u geen internetverbinding hebt, opent u de map **win** van de cd-rom en dubbelklikt u op **SETUP.exe**. Hiermee wordt het printerstuurprogramma geïnstalleerd.

### 8-b

## Verbinden met een smartphone

Als u meerdere smartphones gebruikt, voert u deze stappen uit op elke smartphone.



Bereid het volgende voor voordat u begint.

- 1 Schakel de Wi-Fi-instelling op uw smartphone in.
- 2 Verbind uw smartphone met de draadloze router (als u een draadloze router gebruikt).  
Raadpleeg de handleiding van uw smartphone en draadloze router voor meer informatie.

### 1 Installeer de app "Canon PRINT Inkjet/SELPHY" op uw smartphone.

- Scan de QR-code rechts om naar de Canon-website te gaan en de app te downloaden.



### 2 Open de Wi-Fi-instellingen op uw smartphone. Tik op de netwerknaam (SSID) die met "Canon\_ij\_" begint. Als "Canon\_ij\_" niet wordt weergegeven, gaat u verder met stap 3.

(Voorbeeld van iOS-scherm)

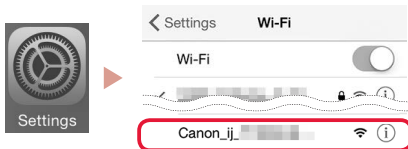

### 3 Open de geïnstalleerde app.



### 4 Volg de instructies op het scherm in de app om de printer toe te voegen.

---

Nadat u de printer hebt toegevoegd, kunt u afdrukken vanaf uw smartphone.

---

# Impostazione della stampante

Impostazione online  
<https://ij.start.canon>



## Spazio di installazione

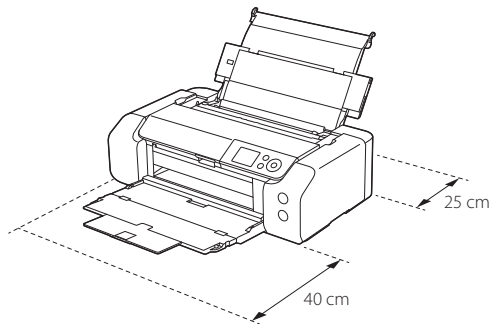

## 1. Contenuto della scatola

- Serbatoi d'inchiostro per l'impostazione



- Testina di stampa

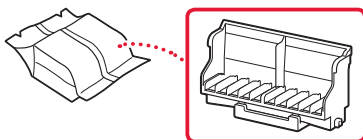

- Vassoio multiuso

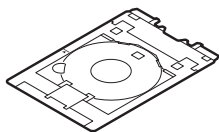

- Cavo di alimentazione
- CD-ROM di installazione per Windows
- Informazioni importanti e sulla sicurezza
- Guida Rapida (questo manuale)

## 2. Rimozione del materiale da imballaggio



- 1 Rimuovere e disfarsi di eventuale materiale da imballaggio e del nastro arancione.
- 2 Aprire il coperchio superiore, rimuovere e disfarsi del nastro arancione e del materiale di protezione all'interno.

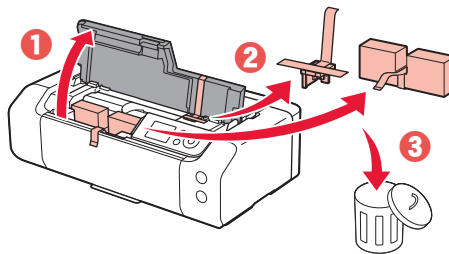

- 3 Chiudere il coperchio superiore.

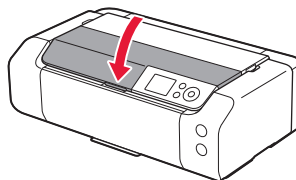

## 3. Accensione della stampante



- 1 Collegare il cavo di alimentazione.

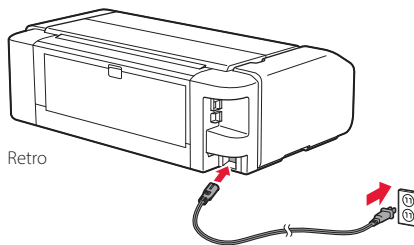

### ►►► Importante

In questa fase, non collegare altri cavi.

- 2 Premere il pulsante **ON**.

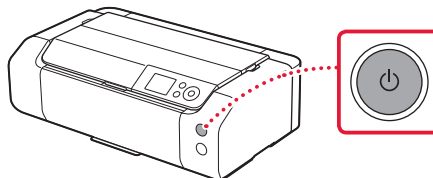

## Impostazione della stampante

- 3 Utilizzare i pulsanti ▲, ▼ e OK per selezionare una lingua.

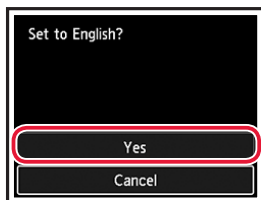
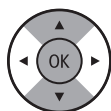

- 4 Premere il pulsante OK.

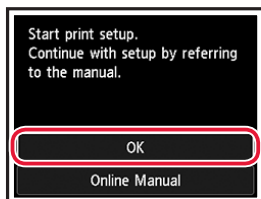

- 5 Impostare la data e l'ora, quindi premere il pulsante OK.

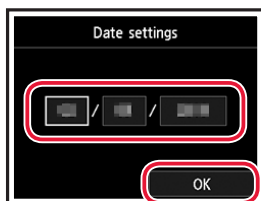

## 4. Installazione della testina di stampa



- 1 Aprire il vassoio di uscita della carta.

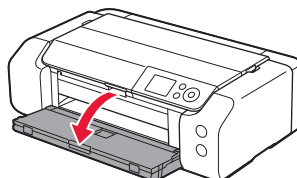

- 2 Aprire il coperchio superiore.

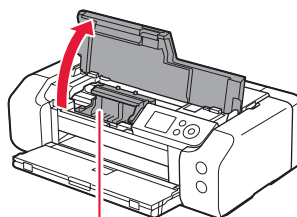

### ⚠ Attenzione

Non toccare il supporto della testina di stampa fino a quando non si ferma.

- 3 Sollevare con fermezza la leva di bloccaggio della testina di stampa fino a quando non si ferma.

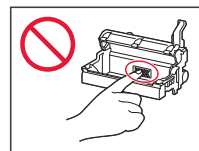
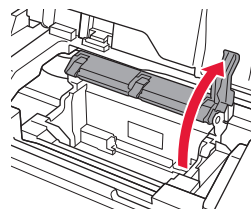

- 4 Rimuovere la testina di stampa dal pacchetto.

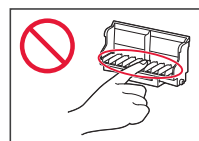
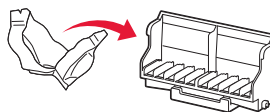

### »»» Importante

Potrebbe esserci dell'inchiostro trasparente o dell'inchiostro colore chiaro sulla busta della testina di stampa - ciò non ha alcun effetto sulla qualità di stampa. Fare attenzione a non sporcarsi di inchiostro quando si maneggiano questi elementi.

## 5 Rimuovere il cappuccio protettivo.

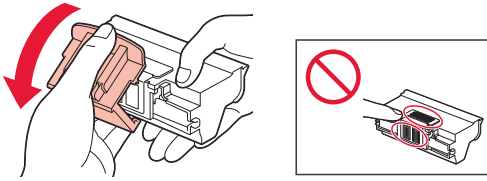

## 6 Inserire la testina di stampa nel supporto della testina di stampa.

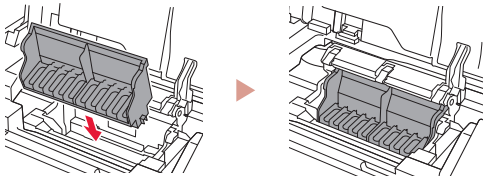

## 7 Abbassare la leva di bloccaggio della testina di stampa completamente.

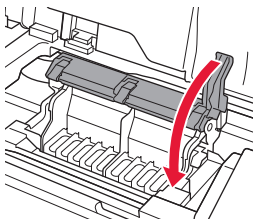

### Importante

Una volta installata la testina di stampa, non rimuoverla inutilmente.

## 5. Installazione dei serbatoi d'inchiostro



### 1 Estrarre il serbatoio d'inchiostro dalla confezione, quindi rimuovere lentamente il cappuccio arancione.

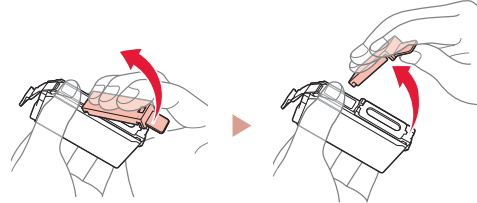

### Importante

- Non schiacciare i lati del serbatoio d'inchiostro.

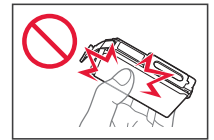

- Non toccare le aree mostrate nella figura.

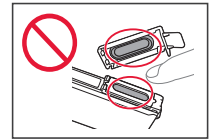

### 2 Installare il serbatoio d'inchiostro.

- Inserire il serbatoio d'inchiostro nella testina di stampa e premere verso il basso finché non scatta in posizione.

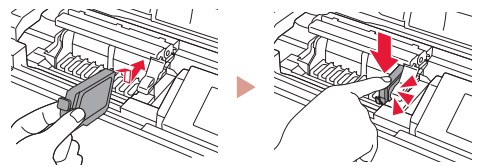

### 3 Verificare che il colore del serbatoio d'inchiostro installato appaia sullo schermo.

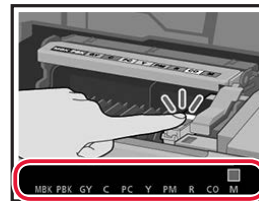

### Importante

Se il colore non è visualizzato sullo schermo nonostante sia stato installato il serbatoio d'inchiostro corrispondente, è possibile che il colore del serbatoio d'inchiostro sia sbagliato o che sia stato installato un serbatoio d'inchiostro non supportato dalla stampante, ad esempio uno avente un numero di modello diverso. Installare un serbatoio d'inchiostro del colore esatto o utilizzare il serbatoio d'inchiostro fornito per l'impostazione.

## Impostazione della stampante

### 4 Ripetere i passi da 1 a 3 per installare tutti i serbatoi d'inchiostro.

- Verificare che tutti i colori vengano visualizzati.

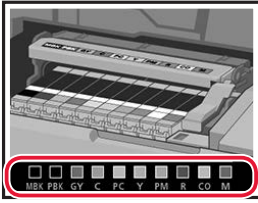

### 5 Chiudere il coperchio superiore.

- Verrà avviata l'inizializzazione della stampante.

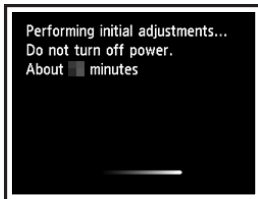
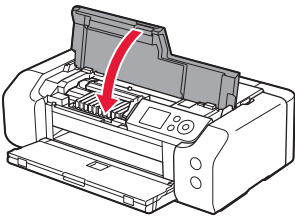

## 6. Caricamento della carta



### 1 Premere il pulsante **OK**.

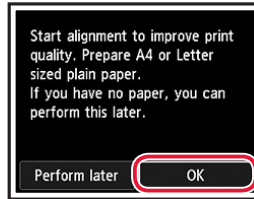

### 2 Aprire il supporto per la carta.

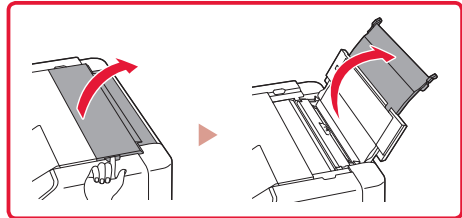
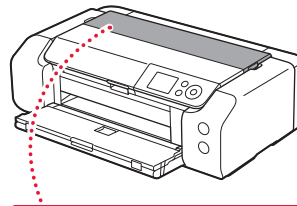

### 3 Aprire il coperchio dell'alimentatore manuale.

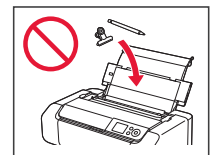
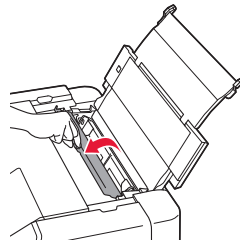

### 4 Far scorrere la guida della carta di destra verso l'estrema destra.

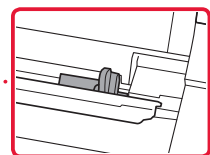
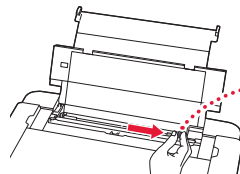

5 Caricare carta comune in formato Letter o A4.

- Caricare la carta con il lato di stampa rivolto verso l'alto.

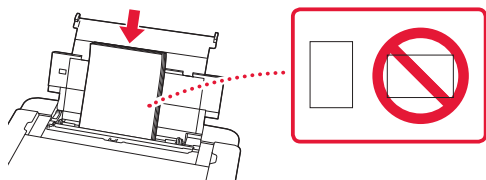

6 Far scorrere la guida della carta laterale contro il bordo della risma di carta.

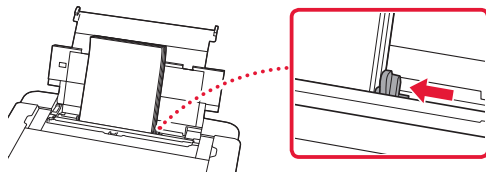

7 Chiudere il coperchio dell'alimentatore manuale.

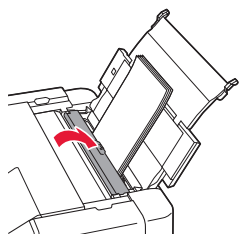

8 Aprire l'estensione del vassoio di uscita ed estendere il supporto di uscita della carta.

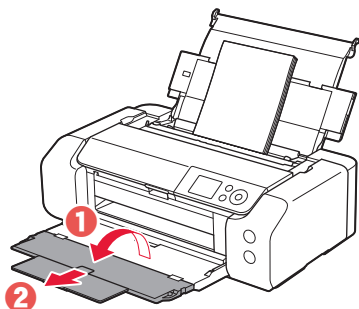

9 Premere il pulsante **OK**.

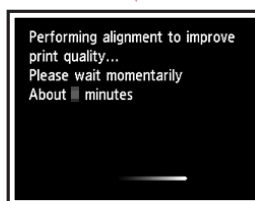
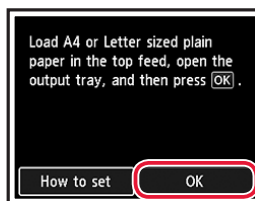

10 Premere il pulsante **OK**.





- Seguire le istruzioni visualizzate sullo schermo per continuare l'impostazione. Sono incluse le selezioni da effettuare in merito all'invio delle informazioni. Fare riferimento a "Invio di informazioni a Canon" in **Informazioni importanti e sulla sicurezza**.
- Quando viene visualizzato **Selezionare met. di connessione. (Select the connection method.)** sulla schermata della stampante, procedere fino a "7. Selezione di un metodo di connessione della stampante" a pagina 6.

# Impostazione della stampante

## 7. Selezione di un metodo di connessione della stampante

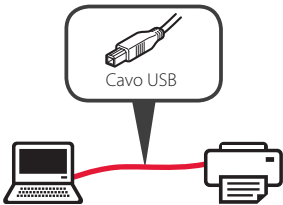
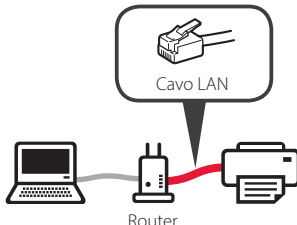
Selezionare un metodo di connessione della stampante dalla tabella riportata di seguito. Nelle seguenti descrizioni, il termine "smartphone" viene utilizzato per indicare collettivamente smartphone e tablet.

Connessione USB (USB connection)	Connessione LAN wired (Wired LAN connection)	Connessione Wi-Fi (Wi-Fi connection)
		

1 Utilizzare i pulsanti ▲, ▼ e OK per selezionare un metodo di connessione.

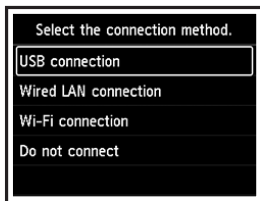

### »»» Nota

È possibile impostare un metodo di connessione in un secondo momento, anche se si seleziona **Non connettere (Do not connect)**.

Se si imposta la connessione in un secondo momento, vedere "8-a. Connessione a un computer" a pagina 7 o "8-b. Connessione a uno smartphone" a pagina 8 e continuare l'impostazione dal computer o dallo smartphone.

2 Seguire le istruzioni a video per procedere con l'impostazione.

- Se si seleziona **Connessione USB (USB connection)**: Non collegare un cavo USB finché non viene richiesto di farlo.
- Se si seleziona **Connessione LAN wired (Wired LAN connection)**: Il connettore della LAN wired è sul retro della stampante.
- Se si seleziona **Connessione Wi-Fi (Wi-Fi connection)**: Quando viene visualizzato **Continuare l'Impostazione Wi-Fi dal computer o dallo smartphone. Confermare. (Continue to perform Wi-Fi setup from your computer or smartphone. Please confirm.)**, selezionare **Sì (Yes)**.

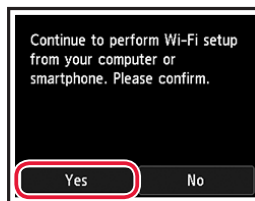
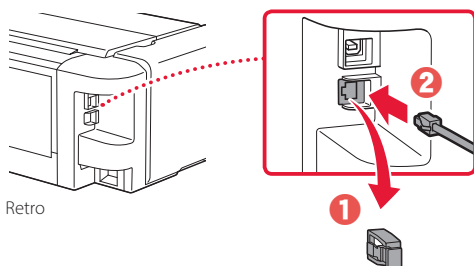

3 Quando viene visualizzata una delle seguenti schermate, procedere alla pagina successiva.

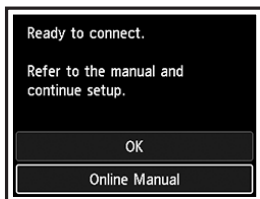



## Quale periferica si sta connettendo?



Computer



Computer e  
smartphone



Smartphone

8-b  
pagina 8

8-a

## Connessione a un computer

Se si utilizzano più computer, eseguire questi passaggi su ciascun computer.



- 1 Accedere al sito Web di Canon da un computer.

<https://ij.start.canon>



- 2 Selezionare  **Impostazione**.
- 3 Immettere il nome del modello della stampante e fare clic su **Vai**.
  - Se richiesto, selezionare il paese o la regione.

- 4 Fare clic su **Avvio**.

- 5 Fare clic su **Se la stampante è già preparata, connettersi**.

### »»» Nota

Le seguenti procedure sono destinate agli utenti Windows.

- 6 Fare clic su **Scarica**.

- 7 Eseguire il file scaricato.

- 8 Fare clic su **Avvia impostazione (Start Setup)**.

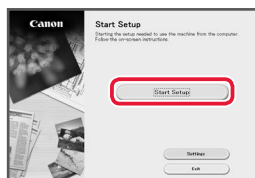

- 9 Seguire le istruzioni visualizzate sullo schermo.

- Queste operazioni possono richiedere del tempo.
- Per connettersi anche a uno smartphone, vedere "8-b. Connessione a uno smartphone" a pagina 8.



### Utilizzo del CD-ROM di installazione per Windows

Fare doppio clic su **EasySetup.exe** nel CD-ROM, quindi continuare dal passo 3. Se non si dispone di una connessione Internet, aprire la cartella **win** nel CD-ROM e fare doppio clic su **SETUP.exe**. Verrà installato il driver della stampante.

## 8-b

### Connessione a uno smartphone

Se si utilizzano più smartphone, eseguire questi passaggi su ciascuno smartphone.



Prima di iniziare, effettuare quanto segue.

- 1 Abilitare l'impostazione Wi-Fi sullo smartphone.
  - 2 Connettere lo smartphone al router wireless (se si dispone di un router wireless).
- Per ulteriori informazioni, fare riferimento ai manuali dello smartphone e del router wireless.

#### 1 Installare l'app "Canon PRINT Inkjet/SELPHY" sullo smartphone.

- Eseguire la scansione del codice QR sulla destra per accedere al sito Web di Canon e scaricare l'app.



#### 2 Aprire le impostazioni Wi-Fi dello smartphone. Toccare il nome di rete (SSID) che inizia con "Canon\_ij\_". Se "Canon\_ij\_" non appare, procedere al passo 3.

(Esempio di schermata iOS)

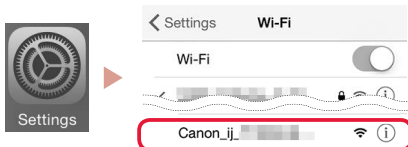

#### 3 Aprire l'app installata.



#### 4 Per aggiungere la stampante, attenersi alle istruzioni visualizzate nell'app.

Una volta aggiunta la stampante, è possibile stampare dallo smartphone.

# Configurando a impressora

Configuração On-line  
<https://ij.start.canon>



## Espaço de instalação

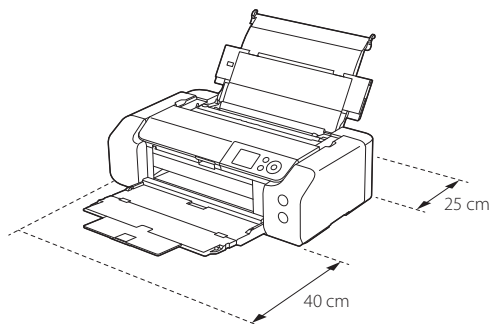

## 1. Conteúdo da Caixa

- Cartuchos de tinta para configuração



- Cabeça de impressão

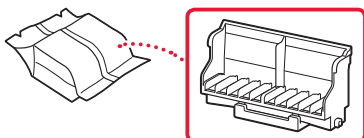

- Bandeja multipropósito

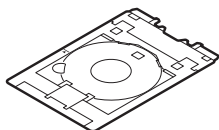

- Cabo de alimentação
- CD-ROM de instalação para Windows
- Informações Importantes e Sobre Segurança
- Para Começar (este manual)

## 2. Removendo os materiais da embalagem



- 1 Remova e descarte quaisquer materiais de embalagem e a fita laranja.
- 2 Abra a tampa superior, remova e descarte a fita laranja e o material de proteção que estão dentro.

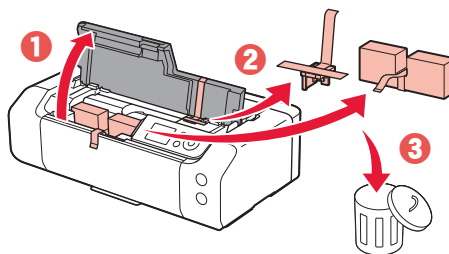

- 3 Feche a tampa superior.

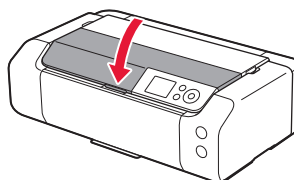

## 3. Ligando a Impressora



- 1 Conecte o cabo de alimentação.

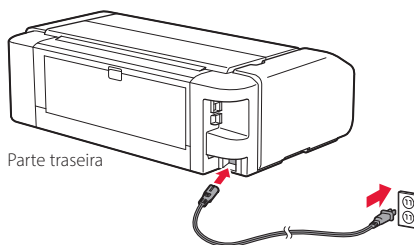

### ►►► Importante

Não conecte quaisquer outros cabos ainda.

- 2 Pressione o botão **ATIVADO (ON)**.

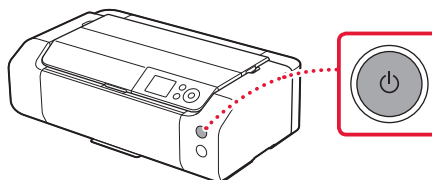

## Configurando a impressora

- 3 Use os botões ▲, ▼ e OK para selecionar um idioma.

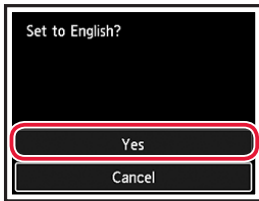
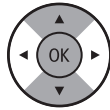

- 4 Pressione o botão OK.

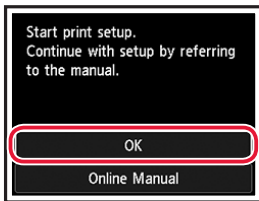

- 5 Defina a data e hora e, em seguida, pressione o botão OK.

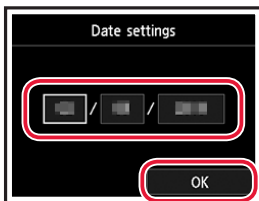

## 4. Instalando a Cabeça de Impressão



- 1 Abra a bandeja de saída do papel.

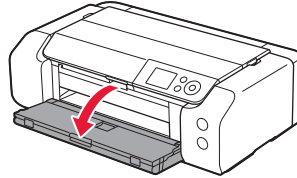

- 2 Abra a tampa superior.

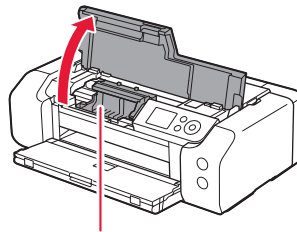

### ▲ Cuidado

Não toque no suporte da cabeça de impressão antes de ele parar de se mover.

- 3 Levante firmemente a alavanca de bloqueio da cabeça de impressão até que ela pare.

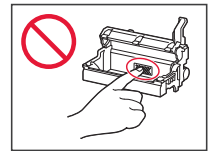
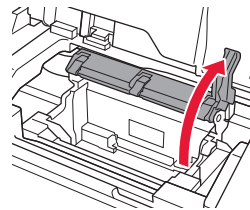

- 4 Remova a cabeça de impressão de seu pacote.

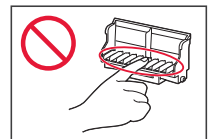
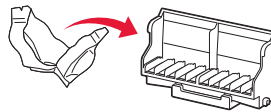

### ►►► Importante

Podem ser que haja tinta transparente ou de cor clara no interior da embalagem em que a cabeça de impressão veio; isso não tem nenhum efeito na qualidade de impressão. Tenha cuidado para não se manchar com a tinta ao manusear esses itens.

## 5 Remova a tampa de proteção.

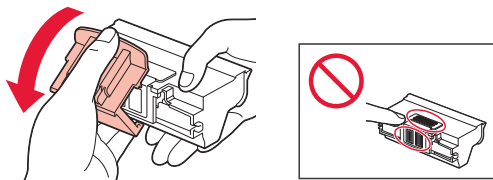

## 6 Coloque a cabeça de impressão no suporte da cabeça de impressão.

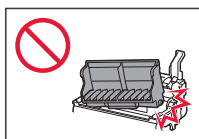
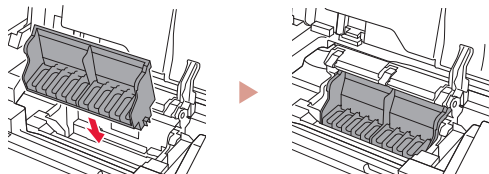

## 7 Abaixar a alavanca de bloqueio da cabeça de impressão completamente.

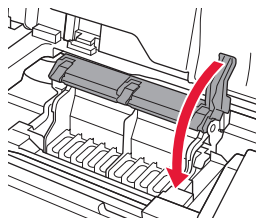

### Importante

Depois que tiver instalado a cabeça de impressão, não remova-a desnecessariamente.

## 5. Instalando os cartuchos de tinta



### 1 Retire o cartucho de tinta da bolsa e, em seguida, remova lentamente a tampa laranja.

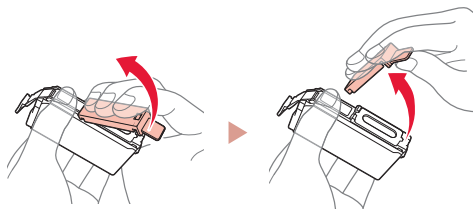

### Importante

- Não aperte as laterais do cartucho de tinta.

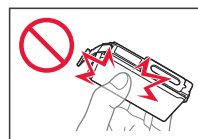

- Não toque nas áreas mostradas na figura.

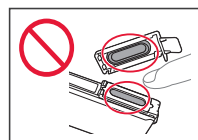

### 2 Instale o cartucho de tinta.

- Insira o cartucho de tinta na cabeça de impressão e pressione-o para baixo até ouvir um clique.

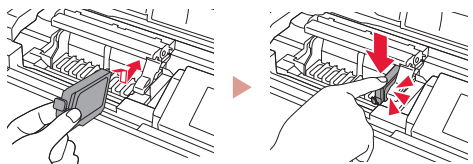

### 3 Confira se a cor do cartucho de tinta instalado aparece na tela.

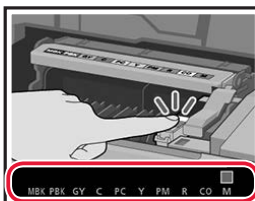

### Importante

Se a cor não for exibida na tela mesmo que você tenha instalado o cartucho de tinta, a cor do cartucho de tinta pode estar errada ou você pode ter instalado um cartucho de tinta que não é suportado por esta impressora, como com um número do modelo diferente. Instale um cartucho de tinta com a cor correta ou use o cartucho de tinta fornecido para configuração.

## Configurando a impressora

### 4 Repita as etapas 1 a 3 para instalar todos os cartuchos de tinta.

- Confira se todas as cores aparecem.

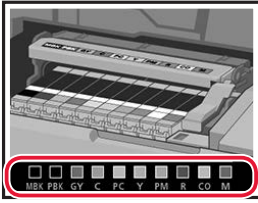

### 5 Feche a tampa superior.

- A impressora será inicializada.

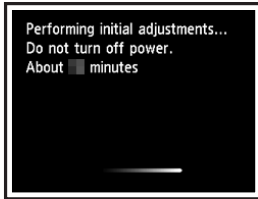
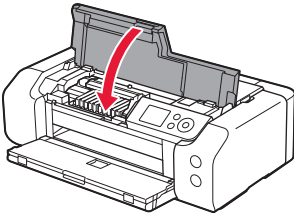

## 6. Colocando papel



### 1 Pressione o botão **OK**.

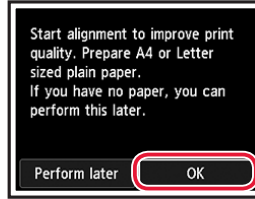

### 2 Abra o suporte de papel.

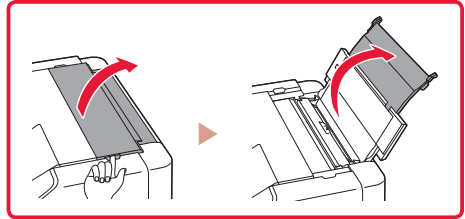
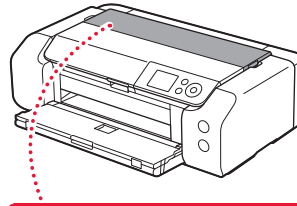

### 3 Abra a tampa do slot de alimentação.

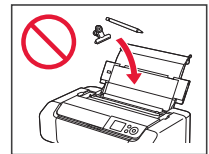
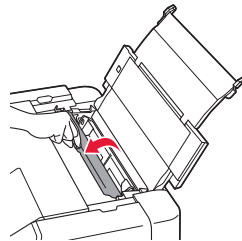

### 4 Deslize a guia do papel da direita até a extremidade direita.

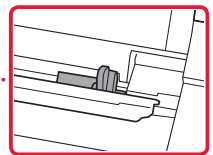
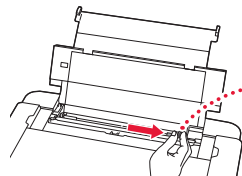

5 Carregue o papel comum de tamanho A4 ou Carta.

- Coloque papel com o lado a ser impresso voltado para cima.

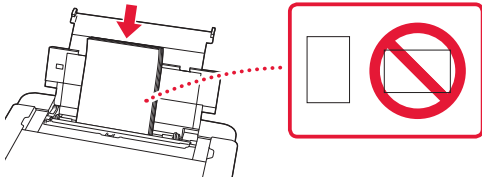

6 Deslize a guia do papel lateral contra a borda da pilha de papel.

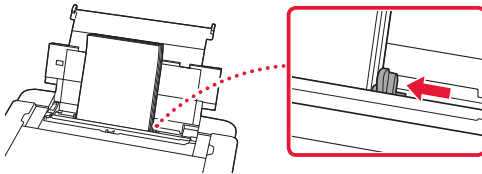

7 Feche a tampa do slot de alimentação.

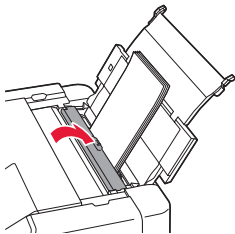

8 Abra a extensão da bandeja de saída e estenda o suporte de saída de papel.

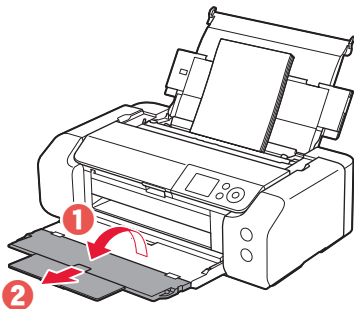

9 Pressione o botão **OK**.

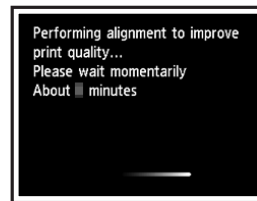
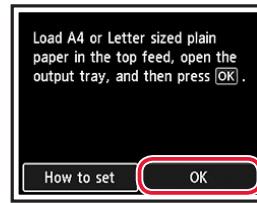

10 Pressione o botão **OK**.





- Siga as instruções da tela para continuar com a configuração. Isso inclui fazer escolhas relacionadas ao envio de informações. Consulte "Enviando informações para a Canon" em **Informações Importantes e Sobre Segurança**.
- Quando **Selecione o método de conexão. (Select the connection method.)** aparecer na tela da impressora, vá para "7. Selecionando um método de conexão para a impressora" na página 6.

## Configurando a impressora

### 7. Selecionando um método de conexão para a impressora

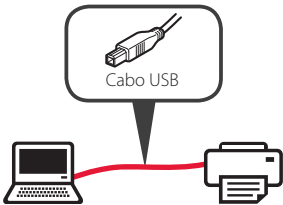
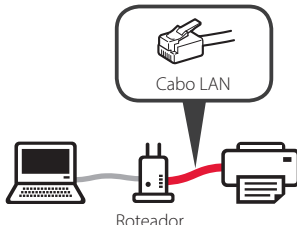
Selecione um dos métodos de conexão para a impressora da tabela abaixo. Na descrição abaixo, "smartphone" é usado para se referir coletivamente a smartphones e tablets.

Conexão USB (USB connection)	Conexão LAN com fio (Wired LAN connection)	Conexão Wi-Fi (Wi-Fi connection)
		

1 Use os botões ▲, ▼ e OK para selecionar um método de conexão.

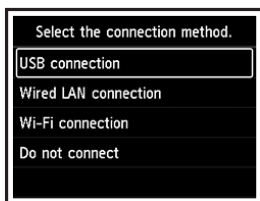

#### »»» Nota

Você pode configurar sua conexão mais tarde, mesmo se selecionar **Não conectar (Do not connect)**.

Ao configurar a conexão posteriormente, consulte "8-a. Conectando a um Computador" na página 7 ou "8-b. Conectando a um smartphone" na página 8, e continue a configuração do seu computador ou smartphone.

2 Siga as instruções na tela para prosseguir com a configuração.

- Se você selecionar **Conexão USB (USB connection)**:

Não conecte um cabo USB até ser instruído a fazer isso.

- Se você selecionar **Conexão LAN com fio (Wired LAN connection)**:

O conector da LAN com fio está na parte traseira da impressora.

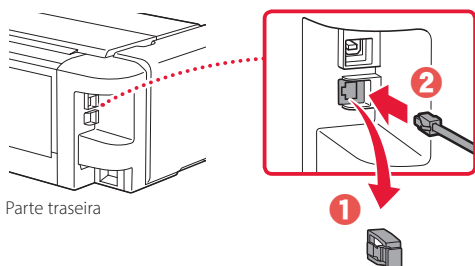

Parte traseira

- Se você selecionar **Conexão Wi-Fi (Wi-Fi connection)**:

Quando **Continue com a configuração do Wi-Fi em seu computador ou smartphone. Confirme. (Continue to perform Wi-Fi setup from your computer or smartphone. Please confirm.)** aparecer, selecione **Sim (Yes)**.

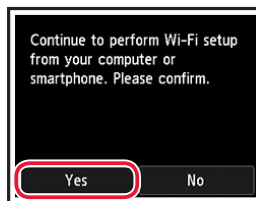

3 Quando alguma das telas a seguir for exibida, prossiga para a próxima página.

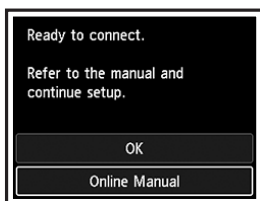



## Qual dispositivo você está conectando?



Computador



Computador e  
smartphone



Smartphone

8-b  
página 8

8-a

## Conectando a um Computador

Se você estiver usando vários computadores, execute estas etapas em cada computador.



- 1 Acesse o site Canon de um computador.

<https://ij.start.canon>



- 2 Selecione  **Configurar**.

- 3 Insira o nome do modelo da sua impressora e clique em **Ir**.

- Se solicitado, selecione seu país ou região.

- 4 Clique em **Iniciar**.

- 5 Clique em **Se você já tiver preparado a sua impressora, vá para Conectar**.

### »»» Nota

As etapas a seguir são para usuários do Windows.

- 6 Clique em **Download**.

- 7 Execute o arquivo baixado.

- 8 Clique em **Iniciar configuração (Start Setup)**.

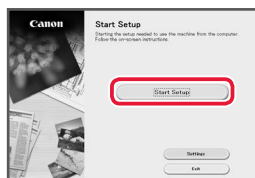

- 9 Siga as instruções na tela.

- Estas operações podem levar algum tempo.
- Para conectar a um smartphone também, consulte "8-b. Conectando a um smartphone" na página 8.



Usando o CD-ROM de instalação para Windows

Clique duas vezes em **EasySetup.exe** no CD-ROM e, em seguida, continue a partir da etapa 3. Se você não tiver uma conexão com a internet, abra a pasta **win** no CD-ROM clique duas vezes em **SETUP.exe**. Isso instalará o driver da impressora.

### 8-b

## Conectando a um smartphone

Se você estiver usando vários smartphones, execute estas etapas em cada smartphone.



Prepare o seguinte antes de iniciar.

- 1 Ative a configuração Wi-Fi no seu smartphone.
  - 2 Conecte seu smartphone ao roteador sem fio (se você tiver um roteador sem fio).
- Consulte os manuais do seu smartphone e do seu roteador sem fio para obter mais detalhes.

### 1 Instale o aplicativo "Canon PRINT Inkjet/SELPHY" no seu smartphone.

- Leia o código QR exibido à direita para acessar o site da Canon e fazer download do aplicativo.



### 2 Abra as configurações do seu Wi-Fi smartphone. Toque no nome da rede (SSID) que começa com "Canon\_ij\_". Se "Canon\_ij\_" não aparecer, prossiga para a etapa 3.

(Exemplo da tela do iOS)

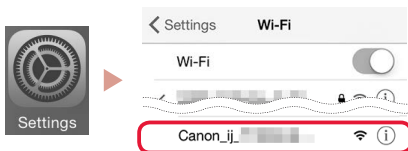

### 3 Abra o aplicativo instalado.



### 4 Siga as instruções na tela do aplicativo para adicionar sua impressora.

Depois que você adicionar a impressora, poderá imprimir do seu smartphone.

# Instalación de la impresora

Configuración en línea  
<https://ij.start.canon>



## Espacio de instalación

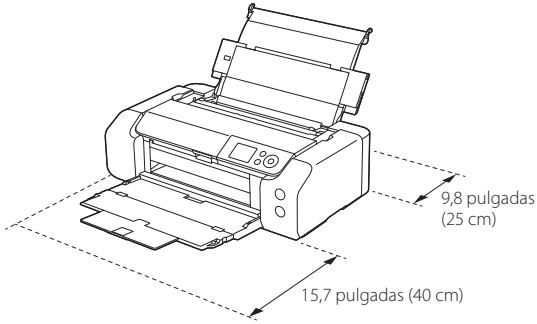

## 1. Contenido de la caja

- Depósitos de tinta para la configuración



- Cabezal de impresión

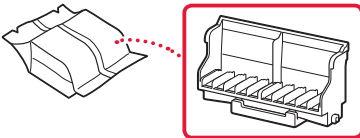

- Bandeja Multiusos

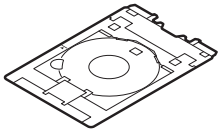

- Cable de alimentación
- CD-ROM de instalación para Windows
- Información de seguridad e información importante
- Guía de inicio (este manual)

## 2. Retirar los materiales de protección



- 1 Retire y tire los materiales de protección y la cinta naranja.
- 2 Abra la cubierta superior, retire y tire la cinta naranja y el material de protección que hay dentro.

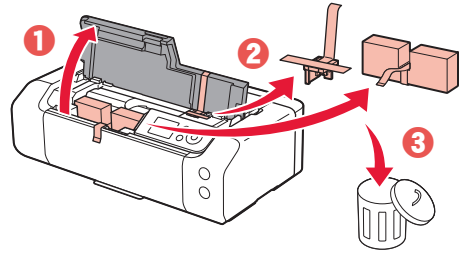

- 3 Cierre la cubierta superior.

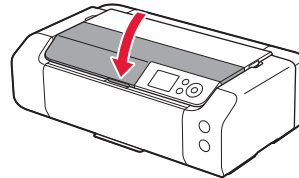

## 3. Encender la impresora



- 1 Conecte el cable de alimentación.

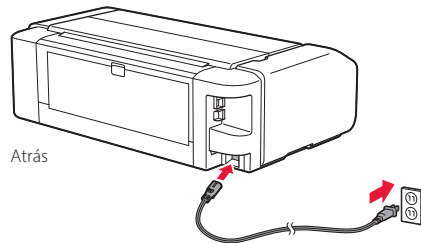

### ►►► Importante

En este momento, no conecte ningún otro cable.

- 2 Pulse el botón **ACTIVADO (ON)**.

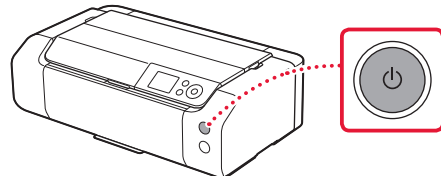

## Instalación de la impresora

- 3 Utilice los botones ▲, ▼ y OK para seleccionar un idioma.

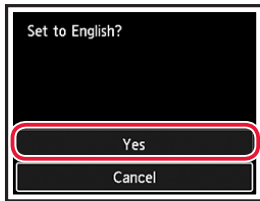
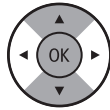

- 4 Pulse el botón OK.

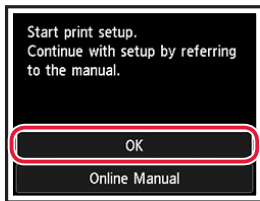

- 5 Establezca la fecha y la hora y, a continuación, pulse el botón OK.

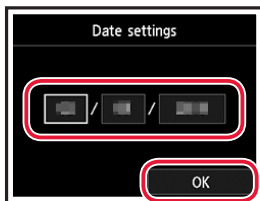

## 4. Instalar el cabezal de impresión



- 1 Abra la bandeja de salida del papel.

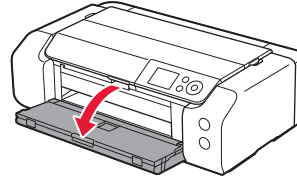

- 2 Abra la cubierta superior.

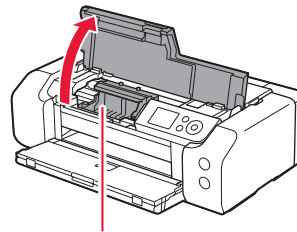

### ⚠ Precaución

No toque el soporte del cabezal de impresión hasta que deje de moverse.

- 3 Suba firmemente la palanca de bloqueo del cabezal de impresión hasta que se detenga.

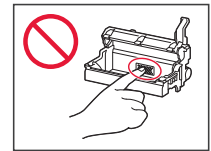
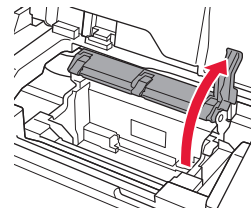

- 4 Saque el cabezal de impresión de su paquete.

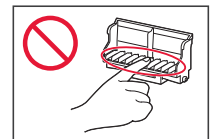
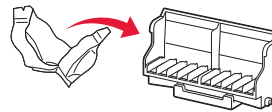

### »»» Importante

Puede haber algo de tinta transparente o de color claro en el interior de la bolsa en la que viene el cabezal de impresión; esto no tiene ningún efecto en la calidad de impresión. Tenga cuidado de no mancharse de tinta al manipular estos elementos.

5 Retire la tapa protectora.

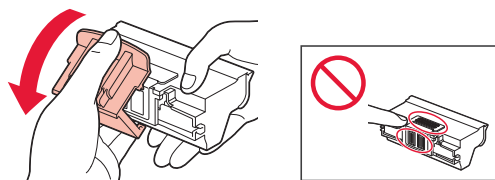

6 Coloque el cabezal de impresión en el soporte del cabezal de impresión.

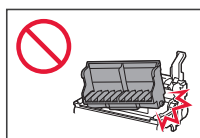
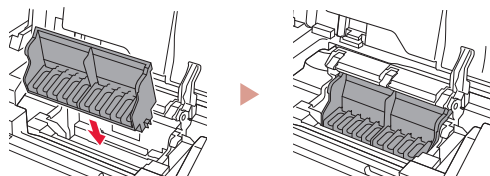

7 Baje la palanca de bloqueo del cabezal de impresión completamente.

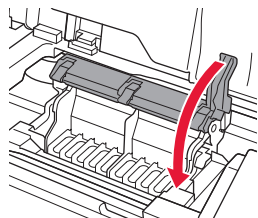

**Importante**

Cuando haya instalado el cabezal de impresión, no lo retire innecesariamente.

5. Instalación de los depósitos de tinta



1 Retire el depósito de tinta de la bolsa y, a continuación, retire lentamente la tapa naranja.

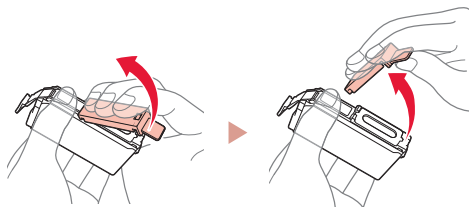

**Importante**

• No apriete los lados del depósito de tinta.

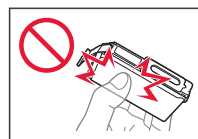

• No toque las áreas que se muestran en la imagen.

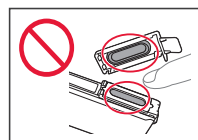

2 Instale el depósito de tinta.

• Inserte el depósito de tinta en el cabezal de impresión y empujelo hacia abajo hasta que encaje en su sitio.

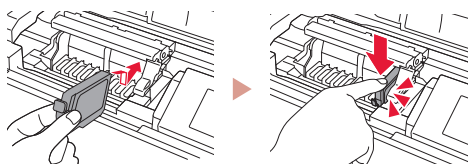

3 Compruebe si el color del depósito de tinta que instaló aparece en pantalla.

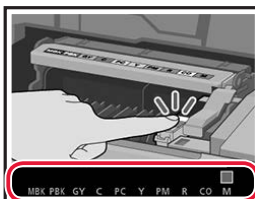

**Importante**

Si no se muestra el color en pantalla a pesar de haber instalado el depósito de tinta, es posible que el color del depósito de tinta no sea correcto o que haya instalado un depósito de tinta, por ejemplo con un número de modelo distinto que no sea compatible con esta impresora. Instale un depósito de tinta para el color correcto o utilice el depósito de tinta proporcionado para la configuración.

## Instalación de la impresora

### 4 Repita los pasos 1 a 3 para instalar todos los otros depósitos de tinta.

- Compruebe que aparezcan todos los colores.

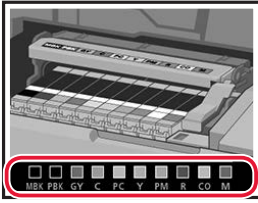

### 5 Cierre la cubierta superior.

- La impresora comenzará a iniciarse.

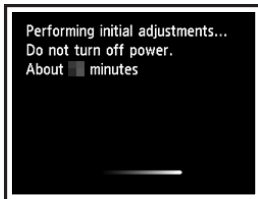
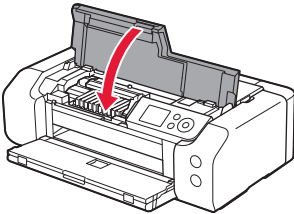

## 6. Carga del papel



### 1 Pulse el botón **OK**.

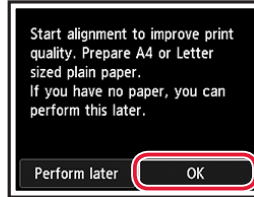

### 2 Abra el soporte del papel.

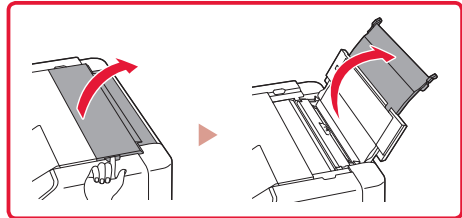
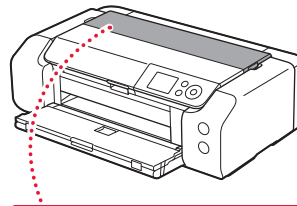

### 3 Abra la cubierta de la ranura de alimentación.

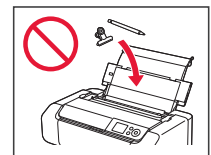
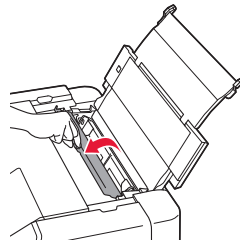

### 4 Deslice la guía del papel del lado derecho totalmente hacia la derecha.

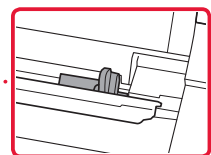
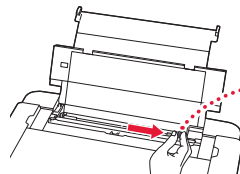

## 5 Cargue papel Carta o papel normal de tamaño A4.

- Cargue papel con la cara imprimible hacia arriba.

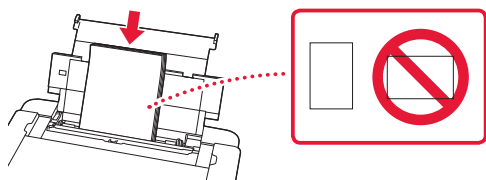

## 6 Deslice la guía del papel lateral contra el borde de la pila de papel.

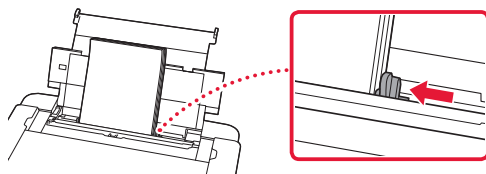

## 7 Cierre la cubierta de la ranura de alimentación.

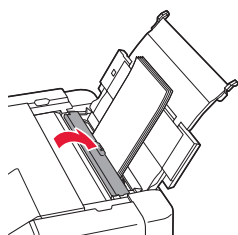

## 8 Abra la extensión de la bandeja de salida y extienda el soporte de la salida del papel.

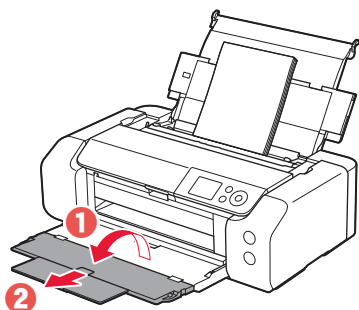

## 9 Pulse el botón **OK**.

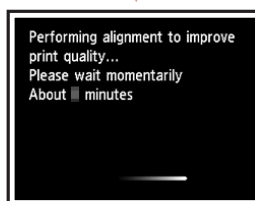
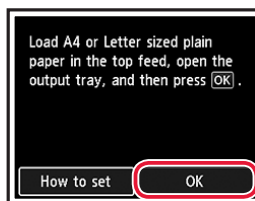

## 10 Pulse el botón **OK**.

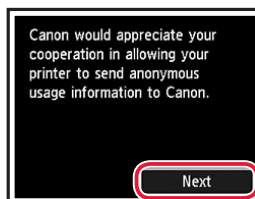

- Siga las instrucciones que aparecen en pantalla para continuar con la instalación. Esto incluye la realización de selecciones relacionadas con el envío de información. Consulte "Enviando información a Canon" en **Información de seguridad e información importante**.
- Cuando se muestre **Seleccione método de conexión. (Select the connection method.)** en la pantalla de la impresora, siga con "7. Selección del método de conexión de la impresora" en la página 6.

# Instalación de la impresora

## 7. Selección del método de conexión de la impresora

Seleccione un método de conexión de la impresora en la tabla a continuación. En las siguientes descripciones se utiliza "teléfono inteligente" para referirse colectivamente a teléfonos inteligentes y tabletas.

Conexión USB (USB connection)	Conexión LAN cableada (Wired LAN connection)	Conexión Wi-Fi (Wi-Fi connection)

1 Utilice los botones ▲, ▼ y OK para seleccionar un método de conexión.

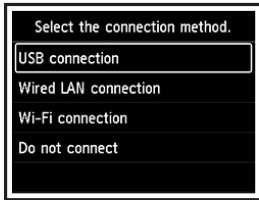

### Nota

Puede configurar su conexión más tarde, aunque seleccione **No conectar (Do not connect)**. Cuando configure la conexión más tarde, consulte "8-a. Conectar al ordenador" en la página 7 o "8-b. Conexión con un teléfono inteligente" en la página 8 y continúe la configuración desde el ordenador o el teléfono inteligente.

2 Siga las instrucciones en pantalla para continuar con la configuración.

- Si selecciona **Conexión USB (USB connection)** : No conecte un cable USB hasta que se le indique.
- Si selecciona **Conexión LAN cableada (Wired LAN connection)** : El conector de LAN cableada está en la parte posterior de la impresora.

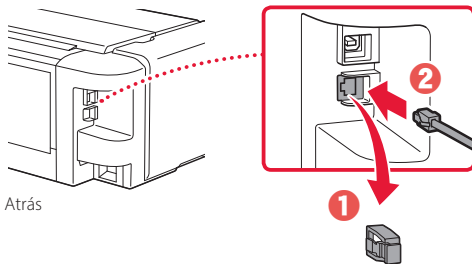

- Si selecciona **Conexión Wi-Fi (Wi-Fi connection)** : Cuando aparezca **Continúe realizando la configuración Wi-Fi desde el ordenador o tel. intel. Confirme. (Continue to perform Wi-Fi setup from your computer or smartphone. Please confirm.)**, seleccione **Sí (Yes)**.

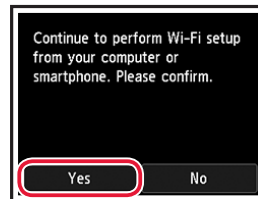

3 Si aparece cualquiera de las pantallas siguientes, avance a la siguiente página.

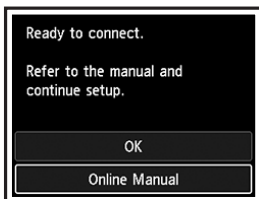



## ¿Qué dispositivo va a conectar?



Ordenador



Ordenador y  
teléfono inteligente



Teléfono inteligente

8-b  
página 8

### 8-a

## Conectar al ordenador

Si utiliza varios ordenadores, realice estos pasos en cada ordenador.



- 1 Acceda al sitio web de Canon desde un ordenador.

<https://ij.start.canon>



- 2 Seleccione  **Configurar**.
- 3 Escriba el nombre del modelo de su impresora y haga clic en **Ir**.
  - Si se le solicita, seleccione su país o región.

- 4 Haga clic en **Iniciar**.

- 5 Haga clic en **Si ya ha preparado la impresora, vaya a Conectar**.

#### »»» Nota

Los siguientes pasos son para usuarios de Windows.

- 6 Haga clic en **Descargar**.

- 7 Ejecute el archivo descargado.

- 8 Haga clic en **Iniciar configuración (Start Setup)**.

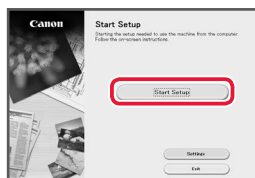

- 9 Siga las instrucciones que aparezcan en pantalla.

- Estas operaciones pueden llevar algún tiempo.
- Para conectar con un teléfono inteligente también, consulte "8-b. Conexión con un teléfono inteligente" en la página 8.



#### Uso del CD-ROM de instalación para Windows

Haga doble clic en **EasySetup.exe** en el CD-ROM y después continúe desde el paso 3. Si no tiene una conexión a Internet, abra la carpeta **win** en el CD-ROM y haga doble clic en **SETUP.exe**. Esto instalará el controlador de la impresora.

## 8-b

### Conexión con un teléfono inteligente

Si utiliza varios teléfonos inteligentes, realice estos pasos en cada teléfono inteligente.



Prepare lo siguiente antes de empezar.

- 1 Active la configuración de Wi-Fi en su teléfono inteligente.
  - 2 Conecte su teléfono inteligente al router inalámbrico (si tiene un router inalámbrico).
- Consulte los manuales de su teléfono inteligente y del router inalámbrico para obtener más detalles.

1 Instale la aplicación "Canon PRINT Inkjet/SELPHY" en su teléfono inteligente.

- Escanee el código QR que se muestra a la derecha para acceder al sitio web de Canon y, a continuación, descargue la aplicación.



2 Abra la configuración de Wi-Fi de su teléfono inteligente. Toque el nombre de red (SSID) que empieza con "Canon\_ij\_". Si no aparece "Canon\_ij\_", vaya al paso 3.

(Ejemplo de la pantalla de iOS)



3 Abra la aplicación instalada.



4 Siga las instrucciones en pantalla de la aplicación para agregar su impresora.

Cuando haya agregado la impresora, podrá imprimir desde su teléfono inteligente.

# Ρύθμιση του εκτυπωτή

Ρύθμιση online  
<https://ij.start.canon>



Χώρος εγκατάστασης

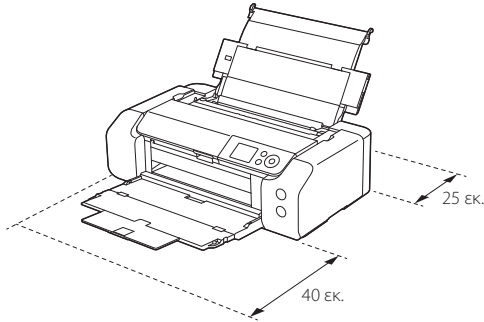

## 1. Περιεχόμενα συσκευασίας

● Δοχεία μελάνης για εγκατάσταση



● Κεφαλή εκτύπωσης

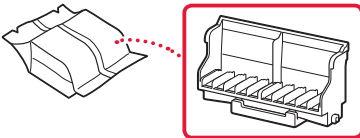

● Θήκη πολλών λειτουργιών

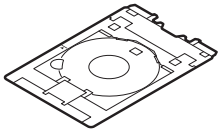

- Καλώδιο τροφοδοσίας
- CD-ROM εγκατάστασης για Windows
- Πληροφορίες για την ασφάλεια και σημαντικές πληροφορίες
- Ξεκινώντας (αυτό το εγχειρίδιο)

## 2. Αφαίρεση υλικών συσκευασίας



- 1 Αφαιρέστε και απορρίψτε τυχόν υλικά συσκευασίας και πορτοκαλί ταινία.
- 2 Ανοίξτε το επάνω κάλυμμα, αφαιρέστε και απορρίψτε την πορτοκαλί ταινία και το προστατευτικό υλικό από το εσωτερικό.

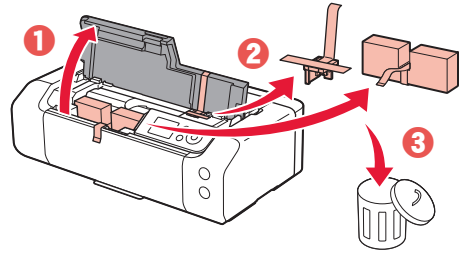

- 3 Κλείστε το επάνω κάλυμμα.

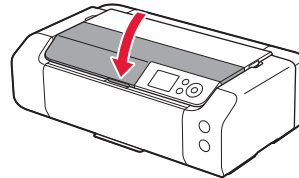

## 3. Ενεργοποίηση του εκτυπωτή



- 1 Συνδέστε το καλώδιο τροφοδοσίας.

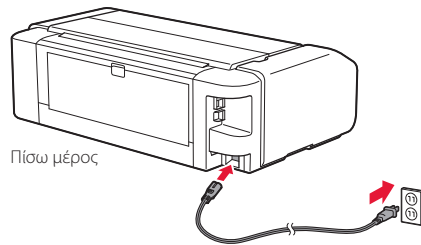

▶▶▶ **Σημαντικό**

Προς το παρόν, μη συνδέσετε άλλα καλώδια.

- 2 Πατήστε το κουμπί **ON**.

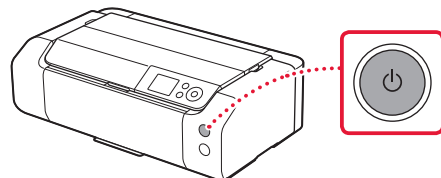

## Ρύθμιση του εκτυπωτή

- 3 Χρησιμοποιήστε τα κουμπιά ▲, ▼ και OK για να επιλέξετε μια γλώσσα.

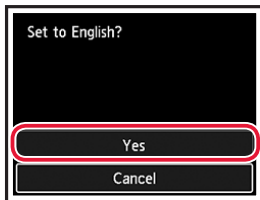
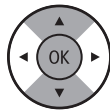

- 4 Πατήστε το κουμπί OK.

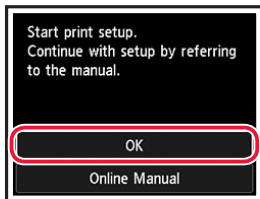

- 5 Ορίστε την ημερομηνία και την ώρα και μετά πατήστε το κουμπί OK.

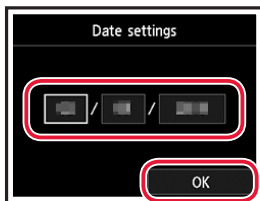

## 4. Εγκατάσταση της κεφαλής εκτύπωσης



- 1 Ανοίξτε τη θήκη εξόδου χαρτιού.

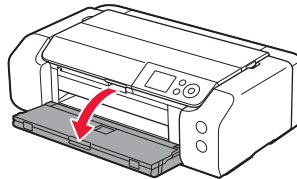

- 2 Ανοίξτε το επάνω κάλυμμα.

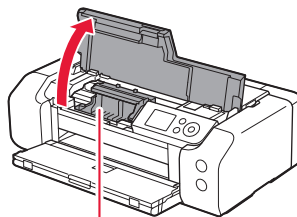

### ⚠ Προσοχή

Μην αγγίζετε τη θήκη κεφαλής εκτύπωσης μέχρι να σταματήσει να μετακινείται.

- 3 Ανασηκώστε σταθερά τον μοχλό ασφάλισης κεφαλής εκτύπωσης μέχρι να σταματήσει.

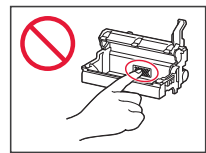
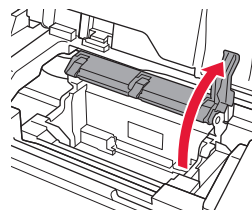

- 4 Βγάλτε την κεφαλή εκτύπωσης από τη συσκευασία της.

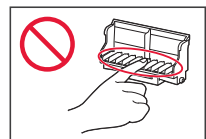
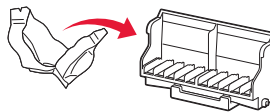

### »»» Σημαντικό

Ενδέχεται να υπάρχει διάφανο ή απαλό έγχρωμο μελάνι στο εσωτερικό της σακούλας μέσα στην οποία έρχεται η κεφαλή εκτύπωσης - αυτό δεν επηρεάζει την ποιότητα εκτύπωσης. Προσέχετε να μη λερωθείτε με μελάνη όταν χειρίζεστε αυτά τα αντικείμενα.

5 Αφαιρέστε το προστατευτικό κάλυμμα.

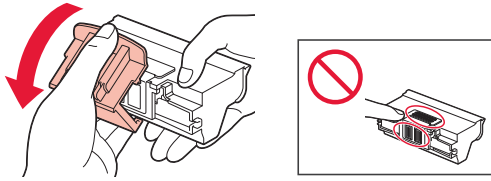

6 Τοποθετήστε την κεφαλή εκτύπωσης στη θήκη κεφαλής εκτύπωσης.

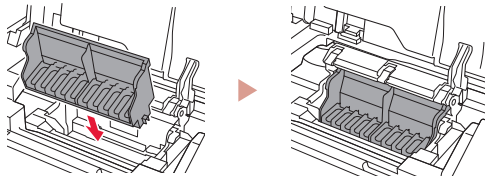

7 Κατεβάστε τον μοχλό ασφάλισης κεφαλής εκτύπωσης εντελώς.

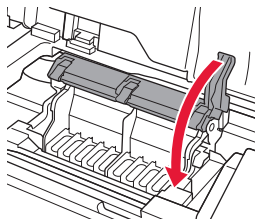

»»» Σημαντικό

Αφού τοποθετήσετε την κεφαλή εκτύπωσης, μην την αφαιρέσετε χωρίς λόγο.

## 5. Εγκατάσταση των δοχείων μελάνης



1 Αφαιρέστε το δοχείο μελάνης από τη σακούλα και μετά αφαιρέστε αργά το πορτοκαλί κάλυμμα.

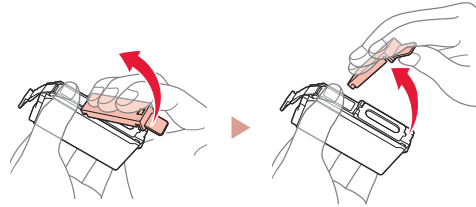

»»» Σημαντικό

• Μην πιέζετε τις πλευρές του δοχείου μελάνης.

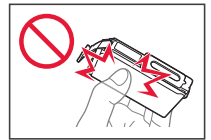

• Μην αγγίζετε τις περιοχές που υποδεικνύονται στην εικόνα.

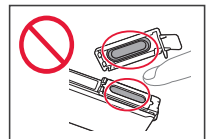

2 Εγκαταστήστε το δοχείο μελάνης.

• Τοποθετήστε το δοχείο μελάνης στην κεφαλή εκτύπωσης και πιέστε το προς τα κάτω μέχρι να εφαρμόσει.

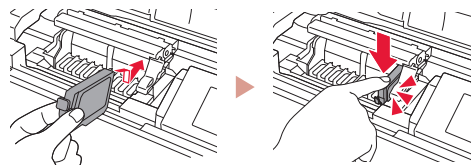

3 Ελέγξτε ότι το χρώμα του δοχείου μελάνης που εγκαταστήσατε εμφανίζεται στην οθόνη.

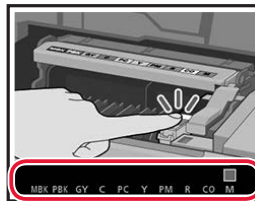

»»» Σημαντικό

Εάν το χρώμα δεν εμφανίζεται στην οθόνη παρόλο που έχετε εγκαταστήσει το δοχείο μελάνης, το χρώμα του δοχείου μελάνης μπορεί να μην είναι σωστό ή μπορεί να έχετε εγκαταστήσει ένα δοχείο μελάνης με διαφορετικό αριθμό μοντέλου, που δεν υποστηρίζεται από αυτό τον εκτυπωτή. Εγκαταστήστε ένα δοχείο μελάνης για το σωστό χρώμα ή χρησιμοποιήστε το δοχείο μελάνης που παρέχεται για την εγκατάσταση.

## Ρύθμιση του εκτυπωτή

- 4 Επαναλάβετε τα βήματα 1 έως 3 για να τοποθετήσετε όλα τα δοχεία μελάνης.
- Ελέγξτε ότι εμφανίζονται όλα τα χρώματα.

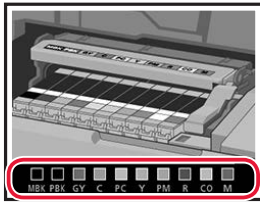

- 5 Κλείστε το επάνω κάλυμμα.
- Ο εκτυπωτής αρχίζει να προετοιμάζεται.

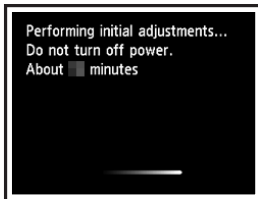
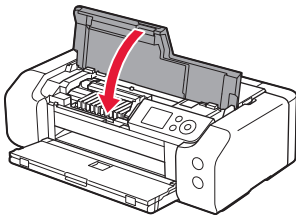

## 6. Τοποθέτηση χαρτιού



- 1 Πατήστε το κουμπί **OK**.

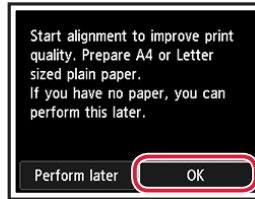

- 2 Ανοίξτε την υποστήριξη χαρτιού.

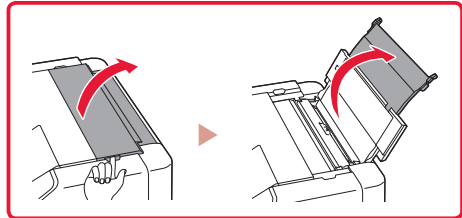
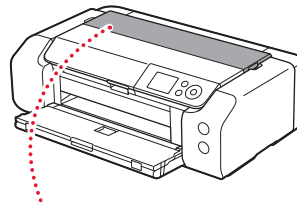

- 3 Ανοίξτε το κάλυμμα υποδοχής τροφοδοσίας.

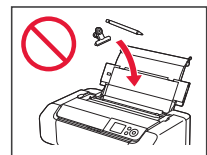
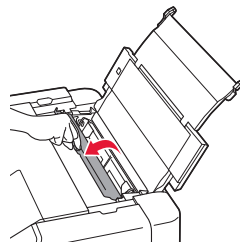

- 4 Σύρετε τον δεξιό οδηγό χαρτιού προς τα δεξιά έως το τέρμα.

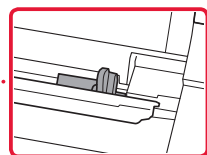
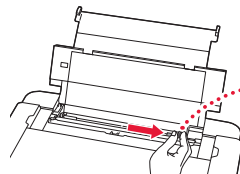

5 Τοποθετήστε απλό χαρτί μεγέθους Letter ή A4.

- Τοποθετήστε χαρτί με την πλευρά εκτύπωσης στραμμένη προς τα επάνω.

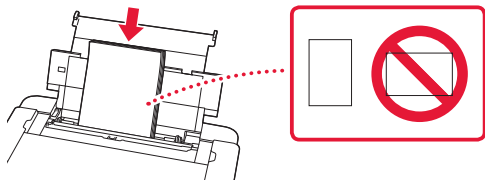

6 Σύρετε τον οδηγό χαρτιού στην άκρη της στοίβας χαρτιών.

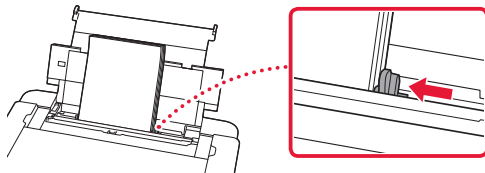

7 Κλείστε το κάλυμμα υποδοχής τροφοδοσίας.

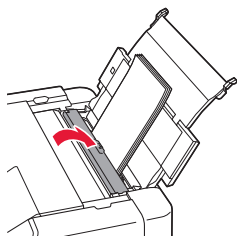

8 Ανοίξτε την προέκταση θήκης εξόδου και εκτείnete την υποστήριξη εξόδου χαρτιού.

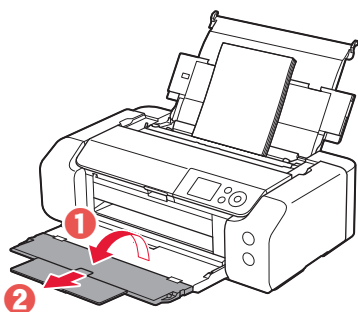

9 Πατήστε το κουμπί **OK**.

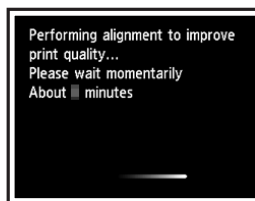
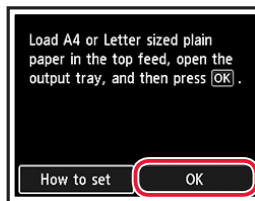

10 Πατήστε το κουμπί **OK**.





- Ακολουθήστε τις οδηγίες στην οθόνη για να συνεχίσετε την εγκατάσταση. Σε αυτές περιλαμβάνονται επιλογές που σχετίζονται με την αποστολή πληροφοριών. Ανατρέξτε στο κεφάλαιο «Αποστολή πληροφοριών στην Canon» στην ενότητα **Πληροφορίες για την ασφάλεια και σημαντικές πληροφορίες**.
- Όταν εμφανιστεί το μήνυμα **Επιλέξτε τη μέθοδο σύνδεσης. (Select the connection method.)** στην οθόνη του εκτυπωτή, προχωρήστε στο «7. Επιλογή μεθόδου σύνδεσης εκτυπωτή» στη σελίδα 6.

# Ρύθμιση του εκτυπωτή

## 7. Επιλογή μεθόδου σύνδεσης εκτυπωτή

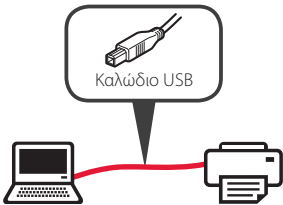
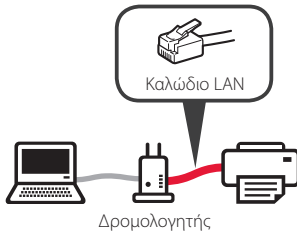
Επιλέξτε μία μέθοδο σύνδεσης εκτυπωτή από τον παρακάτω πίνακα. Στην ακόλουθες περιγραφές, ο όρος «smartphone» χρησιμοποιείται συλλογικά για την περιγραφή των smartphone και των tablet.

Σύνδεση USB (USB connection)	Σύνδεση ενσύρματου LAN (Wired LAN connection)	Σύνδεση Wi-Fi (Wi-Fi connection)
		

1 Χρησιμοποιήστε τα κουμπιά ▲, ▼ και OK για να επιλέξετε μια μέθοδο σύνδεσης.

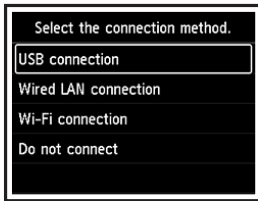

### »»» Σημείωση

Μπορείτε να ρυθμίσετε τη σύνδεσή σας αργότερα, ακόμη κι αν επιλέξετε **Μην γίνει σύνδεση (Do not connect)**.

Όταν ρυθμίζετε τη σύνδεση σε μεταγενέστερο χρόνο, ανατρέξτε στο «8-a. Σύνδεση με υπολογιστή» στη σελίδα 7 ή στο «8-b. Σύνδεση με Smartphone» στη σελίδα 8 και συνεχίστε τη ρύθμιση από τον υπολογιστή ή το smartphone σας.

2 Ακολουθήστε τις οδηγίες στην οθόνη για να συνεχίσετε τη ρύθμιση.

• Αν επιλέξετε **Σύνδεση USB (USB connection)** :  
Μην συνδέσετε το καλώδιο USB μέχρι να σας δοθεί σχετική οδηγία.

• Αν επιλέξετε **Σύνδεση ενσύρματου LAN (Wired LAN connection)** :  
Η υποδοχή σύνδεσης ενσύρματου LAN βρίσκεται στο πίσω μέρος του εκτυπωτή.

• Αν επιλέξετε **Σύνδεση Wi-Fi (Wi-Fi connection)** :

Όταν εμφανιστεί η ένδειξη **Συνεχίστε τη ρύθμιση Wi-Fi από υπολογιστή ή smartphone. Επιβεβαιώστε. (Continue to perform Wi-Fi setup from your computer or smartphone. Please confirm.)**, επιλέξτε **Ναι (Yes)**.

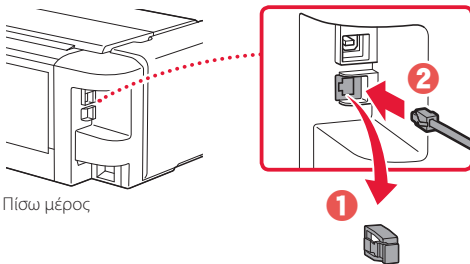

3 Αν εμφανιστεί οποιαδήποτε από τις δύο παρακάτω οθόνες, προχωρήστε στην επόμενη σελίδα.





## Τι συσκευή σκοπεύετε να συνδέσετε;



Υπολογιστής



Υπολογιστής και  
smartphone



Smartphone

8-b  
σελίδα 8

8-a

## Σύνδεση με υπολογιστή

Εάν χρησιμοποιείτε πολλούς υπολογιστές, εκτελέστε αυτά τα βήματα σε κάθε υπολογιστή.



- 1 Μεταβείτε στη διαδικτυακή τοποθεσία της Canon από έναν υπολογιστή.

<https://ij.start.canon>



- 2 Επιλέξτε  **Εγκατάσταση**.

- 3 Καταχωρίστε το όνομα μοντέλου του εκτυπωτή σας και κάντε κλικ στην επιλογή **Μετάβαση**.

- Αν ζητηθεί, επιλέξτε τη χώρα ή την περιοχή σας.

- 4 Κάντε κλικ στο **Έναρξη**.

- 5 Κάντε κλικ στο **Αν έχετε ήδη προετοιμάσει τον εκτυπωτή σας, μεταβείτε στη Σύνδεση**.

»»» **Σημείωση**

Τα παρακάτω βήματα αφορούν τους χρήστες Windows.

- 6 Κάντε κλικ στο **Λήψη**.

- 7 Εκτελέστε το ληφθέν αρχείο.

- 8 Κάντε κλικ στο **Εκκίνηση ρύθμισης (Start Setup)**.

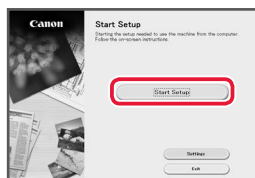

- 9 Ακολουθήστε τις οδηγίες στην οθόνη.

- Αυτές οι λειτουργίες ενδέχεται να χρειαστούν κάποιο χρόνο.
- Για να συνδέσετε και σε smartphone, ανατρέξτε στην ενότητα «8-b. Σύνδεση με Smartphone» στη σελίδα 8.



Χρήση του CD-ROM εγκατάστασης για Windows

Κάντε διπλό κλικ στο αρχείο **EasySetup.exe** που υπάρχει στο CD-ROM και, έπειτα, συνεχίστε από το βήμα 3. Αν δεν έχετε σύνδεση internet, ανοίξτε το φάκελο **win** στο CD-ROM και κάντε διπλό κλικ στο αρχείο **SETUP.exe**. Αυτή η ενέργεια θα εγκαταστήσει το πρόγραμμα οδήγησης του εκτυπωτή.

## 8-b

### Σύνδεση με Smartphone

Εάν χρησιμοποιείτε πολλά smartphone, εκτελέστε αυτά τα βήματα σε κάθε smartphone.



Προετοιμάστε τα εξής προτού ξεκινήσετε.

- 1 Ενεργοποιήστε τη ρύθμιση Wi-Fi στο smartphone σας.
- 2 Συνδέστε το smartphone σας στον ασύρματο δρομολογητή (εάν έχετε ασύρματο δρομολογητή).  
Για περισσότερες λεπτομέρειες, ανατρέξτε στα εγχειρίδια του smartphone και του ασύρματου δρομολογητή.

- 1 Εγκαταστήστε την εφαρμογή «Canon PRINT Inkjet/SELPHY» στο smartphone σας.

- Για πρόσβαση στην τοποθεσία web της Canon, σαρώστε τον κωδικό QR που εμφανίζεται στα δεξιά και, έπειτα, πραγματοποιήστε λήψη της εφαρμογής.



- 2 Ανοίξτε τις ρυθμίσεις Wi-Fi του smartphone σας. Πατήστε το όνομα δικτύου (SSID) που ξεκινά με «Canon\_ij\_». Αν το όνομα «Canon\_ij\_» δεν εμφανίζεται, συνεχίστε στο βήμα 3.

(Παράδειγμα της οθόνης iOS)



- 3 Ανοίξτε την εγκατεστημένη εφαρμογή.



- 4 Ακολουθήστε τις οδηγίες που εμφανίζονται στην οθόνη της εφαρμογής για να προσθέσετε τον εκτυπωτή σας.

Αφού προσθέσετε τον εκτυπωτή σας, μπορείτε πλέον να εκτυπώνετε από το smartphone σας.

# Ställa in skrivaren

Onlineinstallation  
<https://ij.start.canon>



## Installationsutrymme

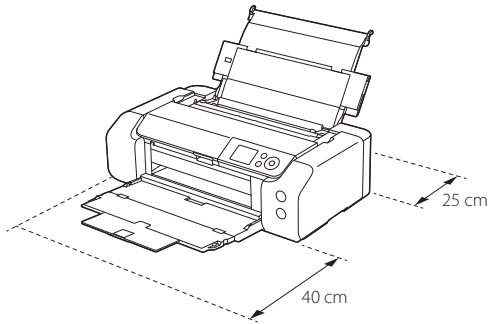

## 1. Boxens innehåll

- Bläckbehållare för installation



- Skrivhuvud

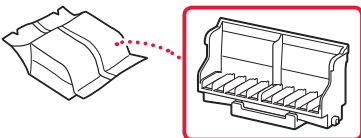

- Multifunktionsfack

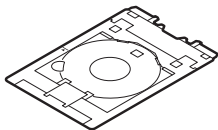

- Strömkabel
- Installations-CD för Windows
- Information om säkerhet och annan viktig information
- Uppstartsguide (denna handbok)

## 2. Ta bort förpackningsmaterial



- 1 Ta bort och kassera eventuellt förpackningsmaterial och orange tejp.
- 2 Öppna den övre luckan, ta bort och kassera den orange tejen och skyddsmaterialet inuti.

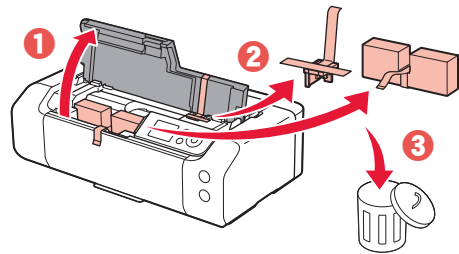

- 3 Stäng den övre luckan.

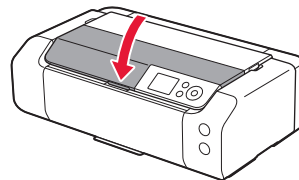

## 3. Slå på skrivaren



- 1 Anslut strömkabeln.

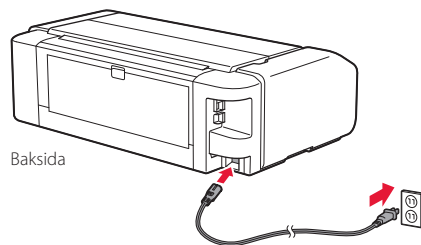

►►► **Viktigt!**

Anslut inga andra kablar än strömkabeln ännu.

- 2 Tryck på **PÅ (ON)**.

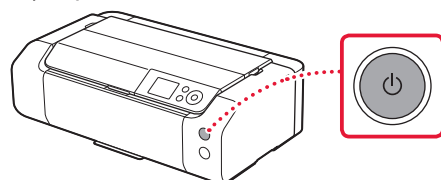

## Ställa in skrivaren

- 3 Använd knapparna ▲, ▼ och **OK** för att välja ett språk.

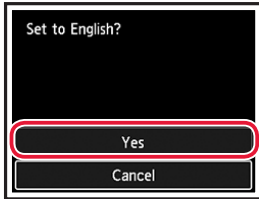
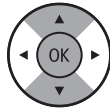

- 4 Tryck på **OK**.

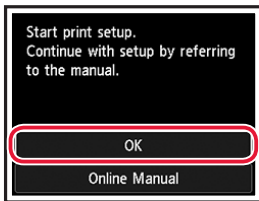

- 5 Ställ in datum och tid och tryck sedan på knappen **OK**.

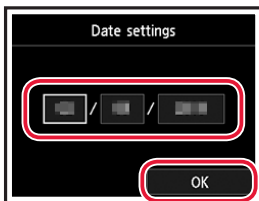

## 4. Installera skrivhuvudet



- 1 Öppna utmatningsfacket.

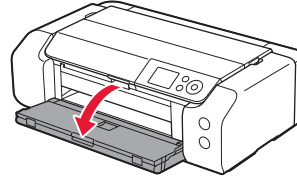

- 2 Öppna den övre luckan.

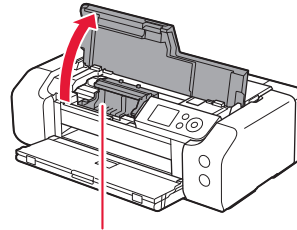

**▲** **Försiktighet**

Rör inte hållaren för skrivhuvudet förrän den slutar röra sig.

- 3 Lyft låsspaken för skrivhuvudet tills det tar stopp.

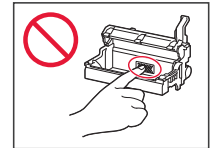
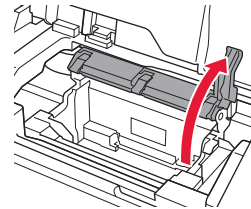

- 4 Ta ut skrivhuvudet ur förpackningen.

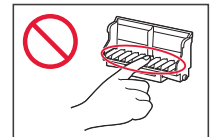
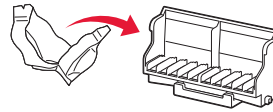

**»»» Viktigt!**

Det kan finnas genomskinligt eller ljusst färgat bläck på insidan av påsen som skrivhuvudet levereras i. Det påverkar inte utskriftskvaliteten. Var försiktig så att du inte får bläck på dig när du hanterar dessa delar.

## 5 Ta bort skyddslocket.

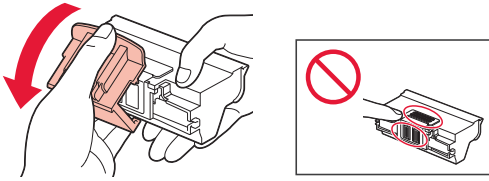

## 6 Sätt in skrivhuvudet i hållaren för skrivhuvudet.

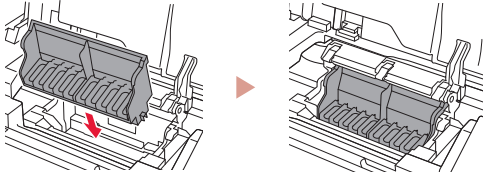

## 7 Sänk låsspaken för skrivhuvudet helt.

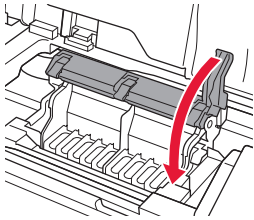

### »»» Viktigt!

När du har installerat skrivhuvudet ska du inte ta bort det i onödan.

## 5. Installera bläckbehållarna



### 1 Ta ut bläckbehållaren ur påsen och ta långsamt bort det orange locket.

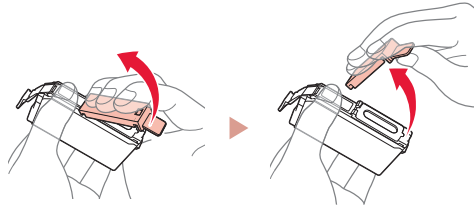

### »»» Viktigt!

- Kläm inte åt sidorna på bläckbehållaren.

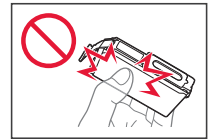

- Rör inte områdena som visas på bilden.

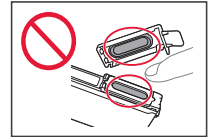

### 2 Installera bläckbehållaren.

- Sätt i bläckbehållaren i skrivhuvudet och tryck nedåt tills den klickar.

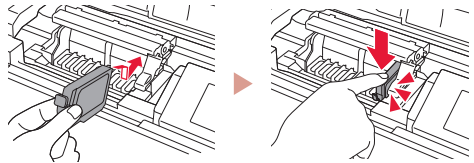

### 3 Kontrollera att färgen på bläckbehållaren du har installerat visas på skärmen.

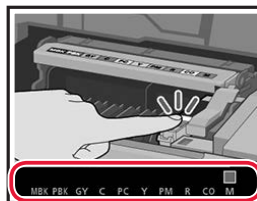

### »»» Viktigt!

Om färgen inte visas på skärmen sedan du installerat bläckbehållaren kanske bläckbehållarens färg är fel eller så kan du ha installerat en bläckbehållare med ett annat modellnummer som inte stöds av skrivaren. Antingen installerar du en bläckbehållare med rätt färg eller så använder du den tillhandahållna bläckbehållaren för configurationen.

## Ställa in skrivaren

### 4 Upprepa steg 1 till 3 för att installera alla bläckbehållare.

- Kontrollera att alla färger visas.

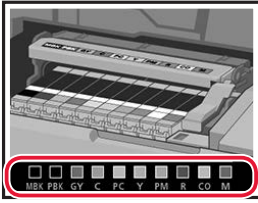

### 5 Stäng den övre luckan.

- Skrivaren börjar initialiseras.

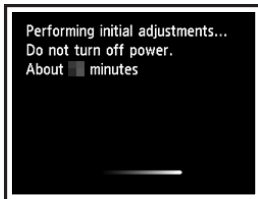
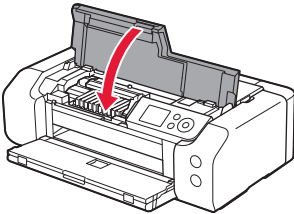

## 6. Fylla på paper



### 1 Tryck på OK.

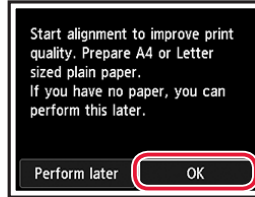

### 2 Öppna pappersstödet.

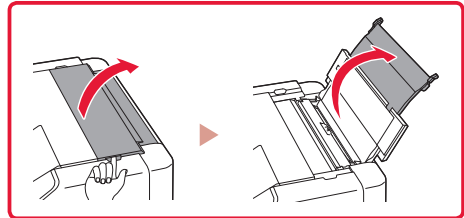
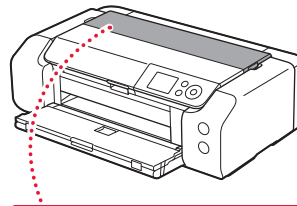

### 3 Öppna luckan för matningsfacket.

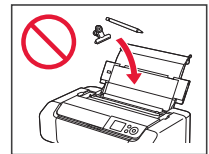
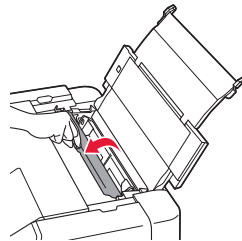

### 4 Skjut den högra pappersledaren längst ut åt höger.

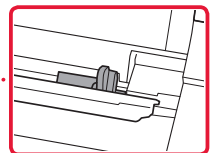
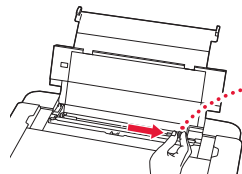

5 Lägga i vanligt Letter- eller A4-papper.

- Lägga i papper med utskriftssidan vänd uppåt.

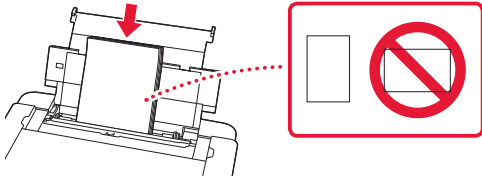

6 Skjut sidopappersledaren mot pappersbuntens kant.

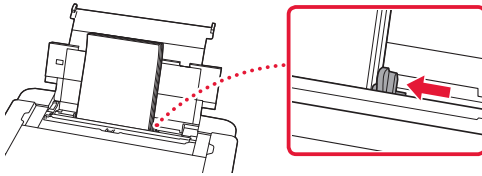

7 Stäng luckan för matningsfacket.

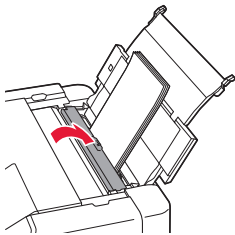

8 Öppna utmatningsfackets förlängningsdel och dra ut pappersutmatningsstödet.

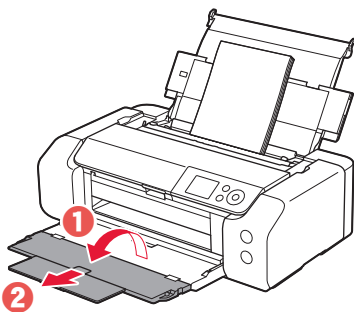

9 Tryck på **OK**.

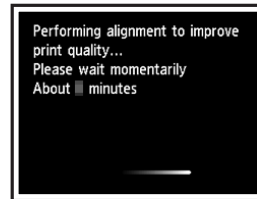
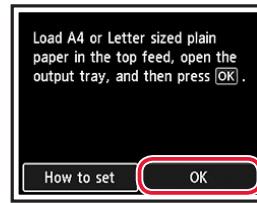

10 Tryck på **OK**.



- Följ instruktionerna på skärmen för att fortsätta inställningen. Detta omfattar att göra val i samband med överföring av information. Läs "Skicka information till Canon" i **Information om säkerhet och annan viktig information**.
- När **Välj anslutningsmetoden. (Select the connection method.)** visas på skrivarens skärm, fortsätter du till "7. Välja en anslutningsmetod för skrivaren" på sida 6.

# Ställa in skrivaren

## 7. Välja en anslutningsmetod för skrivaren

Välj en anslutningsmetod för skrivaren från tabellen nedan. I följande beskrivningar refererar "smarttelefon" både till smarttelefoner och till surfplattor.

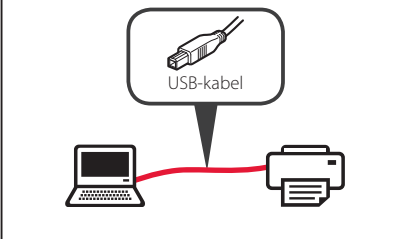
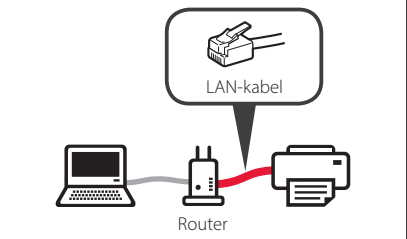
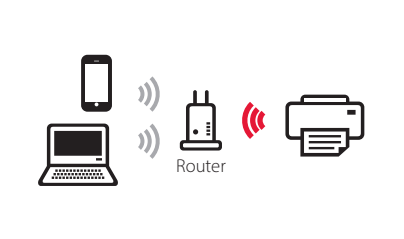
USB-anslutning (USB connection)	Kablad LAN-anslutning (Wired LAN connection)	Wi-Fi-anslutning (Wi-Fi connection)
		

1 Använd knapparna ▲, ▼ och OK för att välja anslutningsmetod.

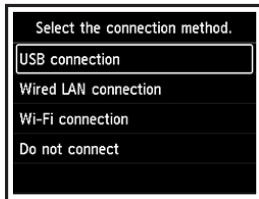

### »»» Obs!

Du kan ansluta senare även om du väljer **Anslut inte (Do not connect)**.

Om du ansluter vid ett senare tillfälle, läs "8-a. Ansluta till dator" på sida 7 eller "8-b. Ansluta till en smarttelefon" på sida 8 och fortsätt installationen från din dator eller smarttelefon.

2 Följ instruktionerna på skärmen för att fortsätta med installationen.

- Om du väljer **USB-anslutning (USB connection)**: anslut inte en USB-kabel förrän du ombeds göra det.
- Om du väljer **Kablad LAN-anslutning (Wired LAN connection)**: kontakten för kablat LAN sitter på skrivarens baksida.

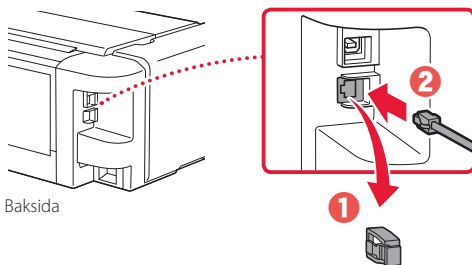

- Om du väljer **Wi-Fi-anslutning (Wi-Fi connection)**: när **Fortsatt utföra Wi-Fi-installn. från en dator eller smarttelefon. Bekräfta. (Continue to perform Wi-Fi setup from your computer or smartphone. Please confirm.)** visas väljer du **Ja (Yes)**.



3 Om någon av följande skärmar visas fortsätter du till nästa sida.

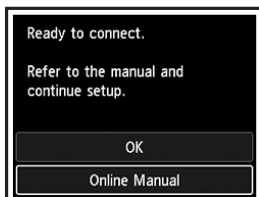



## Vilken enhet ansluter du?



Dator



Dator och  
smarttelefon



Smarttelefon

8-b  
sida 8

## 8-a

### Ansluta till dator

Om du använder flera datorer utför du dessa steg på varje dator.



- 1 Gå till Canons webbplats på en dator.

<https://ij.start.canon>



- 2 Välj  **Konfigurera**.

- 3 Mata in skrivarens modellnamn och klicka på **Kör**.

- Välj land eller region om du blir ombedd att göra det.

- 4 Klicka på **Starta**.

- 5 Klicka på **Om du redan har förberett skrivaren går du till Anslut**.

►►► **Obs!**

Följande steg gäller för Windows-användare.

- 6 Klicka på **Hämta**.

- 7 Starta den hämtade filen.

- 8 Klicka på **Starta inställningar (Start Setup)**.

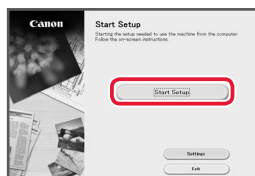

- 9 Följ instruktionerna på skärmen.

- Dessa åtgärder kan ta en stund.
- Om du vill ansluta till en smarttelefon också, läs "8-b. Ansluta till en smarttelefon" på sida 8.



Använda installations-CD:n för Windows

Dubbelklicka på **EasySetup.exe** på CD:n och fortsätt sedan från steg 3. Om du inte har någon internetanslutning öppnar du **win**-mappen på CD:n och dubbelklickar på **SETUP.exe**. Då installeras skrivardrivrutinen.

## 8-b

### Ansluta till en smarttelefon

Om du använder flera smarttelefoner utför du dessa steg på varje smarttelefon.



Förbered följande innan du börjar.

- 1 Aktivera inställningen Wi-Fi på smarttelefonen.
- 2 Anslut smarttelefonen till den trådlösa routern (om du har en trådlös router).  
Läs smarttelefonens och den trådlösa routerns handböcker för mer detaljer.

#### 1 Installera appen "Canon PRINT Inkjet/SELPHY" på smarttelefonen.

- Skanna QR-koden som visas till höger för att komma till Canons webbplats och ladda sedan ner appen.



#### 2 Öppna Wi-Fi-inställningarna på smarttelefonen. Tryck på nätverksnamnet (SSID) som börjar med "Canon\_ij\_". Om "Canon\_ij\_" inte visas går du vidare till steg 3.

(Exempel på iOS-skärm)

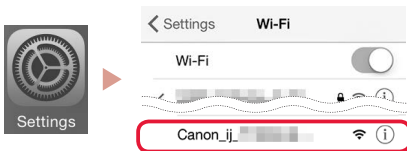

#### 3 Öppna den installerade appen.



#### 4 Följ instruktionerna på skärmen i appen för att lägga till skrivaren.

När du har lagt till skrivaren kan du skriva ut från din smarttelefon.





Access Online Manual  
Zugriff auf das Online-Handbuch  
Accedere al Manuale online  
Acceso al Manual en línea  
Läs Onlinehandbok

Accès au Manuel en ligne  
Online handleiding openen  
Acesse o Manual On-line  
Αποκτήστε πρόσβαση στο Εγχειρίδιο Online

From your browser

À partir de votre navigateur

Über Ihren Browser

Via de browser

Dal browser

Do seu navegador

Desde su navegador

Από το πρόγραμμα περιήγησής σας

Från webbläsaren

