



LCD MONITOR

quick start guide

700DXn, 820DXn



Model

SyncMaster



www.samsung.com

The color and appearance of the product may vary depending on the model, and the product specifications are subject to change without prior notice for reasons of performance enhancement.

Introduction

Package Contents

Note

- Please make sure the following items are included with your LCD Display.

If any items are missing, [contact your dealer](#).
[Contact a local dealer](#) to buy optional items.

Note

- This stand is not for the Floor Standing Type.



LCD Display

Manuals



Quick Setup Guide



Warranty Card
(Not available in all locations)



User's Guide, MDC Software,
MagicNet Software

Cables



D-Sub Cable



Power Cord

Other



Remote Control



Batteries (AAA X 2)
(Not available in all locations)



BNC to RCA
Adaptor Jack

Sold separately



Wall Mount KIT



DVI Cable



BNC Cable



LAN Cable

Your LCD Display

> Front



- 1) **MENU**
Opens the on-screen menu and exits from the menu or closes the adjustment menu.
- 2) **Navigate buttons (Up-Down buttons)**
Moves from one menu item to another vertically or adjusts selected menu values.
- 3) **Adjust buttons (Left-Right buttons)/ Volume buttons**
Moves from one menu item to another horizontally or adjusts selected menu values.
Adjusts the audio volume.
- 4) **ENTER**
Activates a highlighted menu item.
- 5) **SOURCE**
Switches from PC mode to Video mode.
Changing the source is only allowed for external devices that are connected to the LCD Display at the time.
[PC] → [BNC] → [DVI] → [AV] → [S-Video] → [Component] → [HDMI] → [MagicNet]
>> [Click here to see an animation clip.](#)
- 6) **PIP**
Push the PIP button to turn the PIP screen On / Off.
More than one PIP cannot overlap on screen as BNC and the component use the same terminal.
>> [Click here to see an animation clip.](#)

- **PC**
AV / S-Video / Component / HDMI Mode
- **BNC**
AV / S-Video / HDMI Mode
- **DVI**
AV / S-Video / Component Mode
- **AV / S-Video**
PC / BNC / DVI Mode
- **Component**
PC / DVI Mode
- **HDMI**
PC / BNC Mode

7)  **Power button**

Turns the LCD Display On/Off.

8) **Brightness Sensor**

The product's Brightness Sensor function automatically detects the surrounding brightness using a brightness sensor and adjusts its brightness accordingly.

9) **Power indicator**

Shows PowerSaver mode by blinking green.

10) **Remote Control Sensor**

Aim the remote control towards this spot on the LCD Display.

 **Note**

- See **PowerSaver** described in the manual for further information regarding power saving functions. For energy conservation, turn your LCD Display OFF when it is not needed or when leaving it unattended for long periods.

 **Rear**

 **Note**

- For detailed information concerning cable connections, refer to Connecting Cables under Setup. The LCD Display's configuration at the back may vary slightly depending on the LCD Display model.

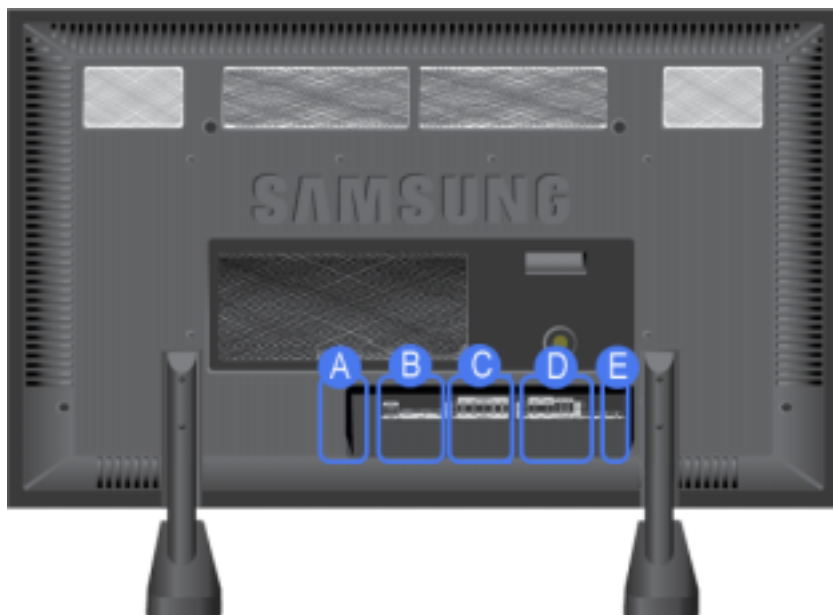

1) **POWER IN**

The power cord plugs into the LCD Display and the wall plug.

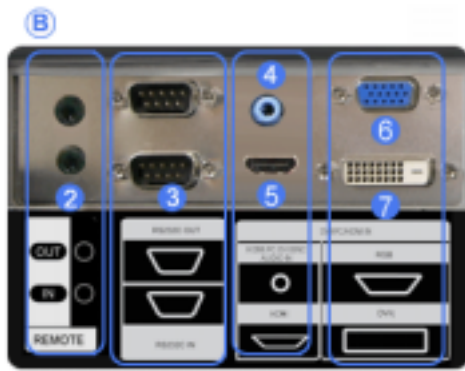

- 2) **REMOTE OUT/IN**
You can use a wired remote control by connecting it to your monitor.
- 3) **RS232C OUT/IN (RS232C Serial PORT)**
MDC(Multiple Display Control) Program Port
- 4) **DVI / PC / HDMI IN [HDMI/PC/DVI/BNC AUDIO IN](HDMI/PC/DVI/BNC Audio Connection Terminal (Input))**
- 5) **DVI / PC / HDMI IN [HDMI]**
Connect the HDMI terminal at the back of your monitor to the HDMI terminal of your digital output device using a HDMI cable.
- 6) **DVI / PC / HDMI IN [RGB] (PC Video Connection Terminal)**
Using a D-Sub Cable (15 pin D-Sub) - PC mode (Analog PC)
- 7) **DVI / PC / HDMI IN [DVI(HDCP)] (PC Video Connection Terminal)**
Using a DVI Cable (DVI-D to DVI-D) - DVI mode (Digital PC)



- 8) **COMPONENT AUDIO IN [L-AUDIO-R] (Component Audio Connection Terminal (Input))**
- 9) **BNC/COMPONENT OUT [R/PR, G/Y, B/Pb, H, V] (BNC/Component Connection Terminal (Output))**
BNC (Analog PC) Connection: connecting the R, G, B, H, V ports
Component Connection: connecting the PR, Y, PB ports
- 10) **BNC/COMPONENT IN [R/PR, G/Y, B/Pb, H, V] (BNC/Component Connection Terminal (Input))**

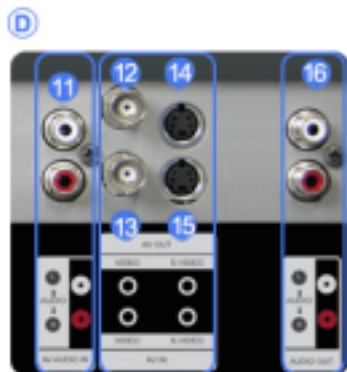

- 11) **AV AUDIO IN [L-AUDIO-R] (LCD Display Audio Connection Terminal (Input))**
- 12) **AV OUT [VIDEO] (VIDEO Connection Terminal): AV mode (Output)**
- 13) **AV IN [VIDEO] (VIDEO Connection Terminal) (Input)**
- 14) **AV OUT [S-VIDEO] (S-VIDEO Connection Terminal): S-VIDEO mode (Output)**
- 15) **AV IN [S-VIDEO] (S-VIDEO Connection Terminal) (Input)**
- 16) **AUDIO OUT [L-AUDIO-R] (LCD Display Audio Connection Terminal (Output))**
AUDIO OUT is the terminal for sound output of PC, DVI or BNC.

- 17) **LAN (LAN Connection Terminal)**
- 18) **USB (USB Connection Terminal)**
Keyboard / Mouse, Mass Storage Device Compatible.



Note

- The number of LCD Displays that can be connected to loopout may differ depending on the cables, signal source etc. With cables where there is no degradation or signal source, up to ten LCD Displays can be connected.

Note

- See [Connecting the LCD Display](#) for further information regarding cable connections.

Remote Control

Note

- The performance of the remote control may be affected by a TV or other electronic device operating near the LCD Display, causing a malfunction due to interference with the frequency.

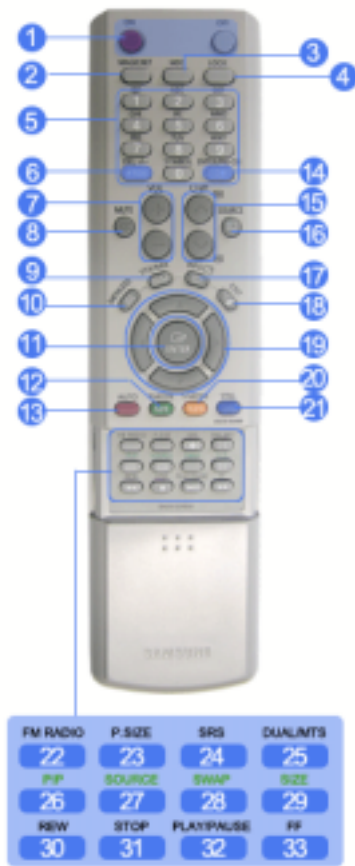

1. ON / OFF
2. MAGICNET
3. MDC
4. LOCK
5. MagicNet buttons
- 6.+100 -/--
7. VOL
8. MUTE
9. TTX/MIX
10. MENU
11. ENTER
12. M/B P.MODE
13. AUTO
14. ENTER/PRE-CH
15. CH/P
16. SOURCE
17. INFO
18. EXIT
19. Up-Down Left-Right buttons
20. S.MODE
21. STILL
22. FM RADIO
23. P.SIZE
24. SRS
25. DUAL/MTS
26. PIP
27. SOURCE
28. SWAP
29. SIZE
30. REW
31. STOP
32. PLAY/PAUSE
33. FF

1) ON / OFF

Turns the LCD Display On/Off.

2) MAGICNET

MagicNet Quick Launch Button.

3) **MDC**

MDC Quick Launch Button.

4) **LOCK**

Activates or deactivates all function keys on both the remote control and the LCD Display except for the Power and LOCK buttons.

5) **MagicNet buttons**

Used for MagicNet.

- Alphanumeric: Used to enter the Internet address.
- DEL: Functions as the backspace.
- SYMBOL: Used to enter the symbols. (.O_-)
- ENTER: Used to enter values.

6) **+100 -/--**

Press to select channels over 100.

For example, to select channel 121, press "+100", then press "2" and "1".

- **This function does not work for this monitor.**

7) **VOL**

Adjusts the audio volume.

8)  **MUTE**

Pauses (mutes) the audio output temporarily.

This is displayed on the lower left corner of the screen.

The audio resumes if MUTE or - VOL + is pressed in the Mute mode.

9)  **TTX/MIX**

TV channels provide text information services via teletext.

- **This function does not work for this monitor.**

10)  **MENU**

Opens the on-screen menu and exits from the menu screen or closes the screen adjustment menu.

11)  **ENTER**

Activates a highlighted menu item.

12)  **P.MODE**

When you press this button, current picture mode is displayed on the lower center of the screen.

AV / S-Video / Component : P.MODE

The Monitor has four automatic picture settings that are preset at the factory.

Then push button again to circle through available preconfigured modes.

(Dynamic → Standard → Movie → Custom)

PC/DVI/BNC : M/B (MagicBright™)

MagicBright™ is a new feature providing the optimum viewing environment depending on the contents of the image you are watching.

Then push button again to circle through available preconfigured modes.

(Entertain → Internet → Text → Custom)

13) **AUTO**

Adjusts the screen display automatically in PC mode.

By changing the resolution in the control panel, auto function is performed.

14)  **ENTER/PRE-CH**

Returns to the immediately previous channel.

- **This function does not work for this monitor.**

15)  **CH/P**

In TV mode, selects TV channels.

- **This function does not work for this monitor.**

16)  **SOURCE**

Changes the video source.

17)  **INFO**

The current picture information is displayed in the top left corner of the screen.

18)  **EXIT**

Exits from the menu screen.

19) **Up-Down Left-Right buttons**

Moves from one menu item to another horizontally, vertically or adjusts selected menu values.

20)  **S.MODE**

When pressing this button, the current mode is displayed at the bottom centre of the screen.

The LCD Display has a built-in high fidelity stereo amplifier.

Then press the button again to circle through available preconfigured modes.

(Standard → Music → Movie → Speech → Custom)

21) STILL

Press the button once to freeze the screen. Press it again to unfreeze.

22) FM RADIO

Turns the FM Radio on/off.

In PC/DVI mode, sets the SOUND to FM Radio.

In general Video mode, selects FM Radio, and turns off the screen.

In areas where the signal is weak, noise may occur during FM radio broadcasts.

- This function does not work for this monitor.

23) P.SIZE

Press to change the screen size.

24) SRS

SRS

25) DUAL/MTS

DUAL-

STEREO/MONO, DUAL I / DUAL II and MONO/NICAM MONO/NICAM STEREO can be operated depending on the broadcasting type by using the DUAL button on the remote control while watching TV.

MTS-

You can select MTS (Multichannel Television Stereo) mode.

	Audio Type	MTS/S_Mode	Default
FM Stereo	Mono	Mono	Manual Change
	Stereo	Mono ↔ Stereo	
	SAP	Mono ↔ SAP	Mono

- This function does not work for this monitor.

26) PIP

Every time you press the button, a PIP screen appears.

27) SOURCE

Changes the source of the PIP window signal.

28) SWAP

Swaps the contents of the PIP and main image.

The image in the PIP window will appear on the main screen, and the main screen image will appear in the PIP window.

29) SIZE

Switches the PIP Picture Size.

30) REW

Rewind

31) STOP

Stop

32) PLAY / PAUSE

Play/Pause

33) FF

Fast forward



- Safety Instructions
- Introduction
- Connections
- Installing the Stand KIT
- Connecting the LCD Display
- Using the Software
- Adjusting the LCD Display
- Troubleshooting
- Specifications
- Information
- Appendix

SyncMaster

www.samsung.com

The color and appearance of the product may vary depending on the model, and the product specifications are subject to change without prior notice for reasons of performance enhancement.

Connections

Installing the Stand KIT

Note

- Only the supplied bolts should be used.

Caution

Samsung Electronics will not be responsible for damages caused by using a base other than those specified.

Installing the Semi Stand

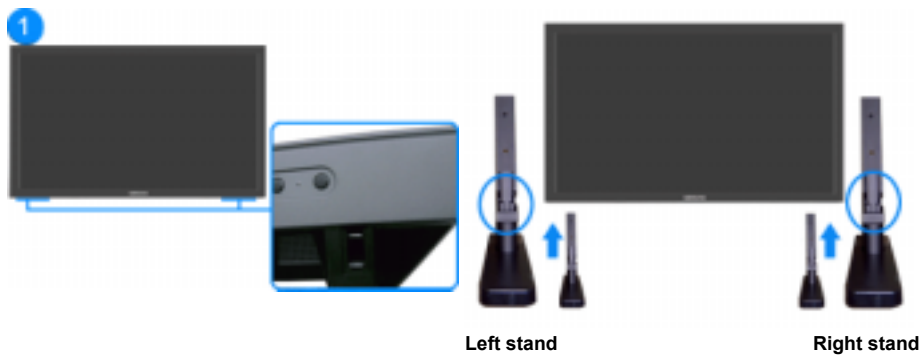

Left stand

Right stand

Caution

Make sure to install the stand with the Caution label folded backwards.



Caution

The resolution may differ for each product model. For information on the optimal resolution, refer to the user manual.

Connecting the LCD Display

Using a Power cord with Earth

In the event of failure, the earth lead may cause electric shock. Make sure to wire the earth lead in correctly, before connecting the AC power. When un-wiring the earth lead, make sure to disconnect the AC power in advance.



Note

- AV input devices such as DVD players, VCR's or camcorders as well as your computer can be connected to the LCD Display. For detailed information on connecting AV input devices, refer to the User Controls under Adjusting Your LCD Display.

Connecting a Computer

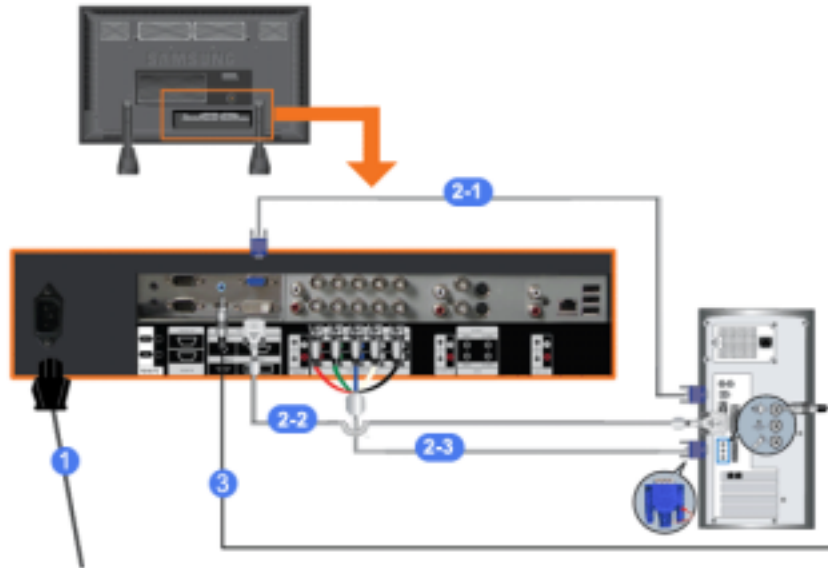

- 1) Connect the power cord for your LCD Display to the power port on the back of the LCD Display. Turn on the power switch.
- 2) There are 3 ways to connect the D-sub to your LCD Display. Choose one of the following:
 - 2-1) Using the D-sub (Analog) connector on the video card. Connect the D-sub to the 15-pin, **RGB port** on the back of your LCD Display and the **15 pin D-sub Port** on the computer.



- 2-2) Using the DVI (Digital) connector on the video card. Connect the DVI Cable to the **DVI(HDCP) port** on the back of your LCD Display and the **DVI port** on the computer.



2-3)

Using the BNC (Analog) connector on the video card.
Connect the BNC Cable to the **BNC/COMPONENT IN - R, G, B, H, V ports** on the back of your LCD Display and the **15 pin D-sub Port** on the computer.



3) Connect the audio cable for your LCD Display to the audio port on the back of your computer.

 Note

- Turn on both your computer and the LCD Display.

 Note

- The DVI cable or BNC cable is optional.
Contact a local Samsung Electronics [Service Center](#) to buy optional items.

➤ **Connecting a VCR**

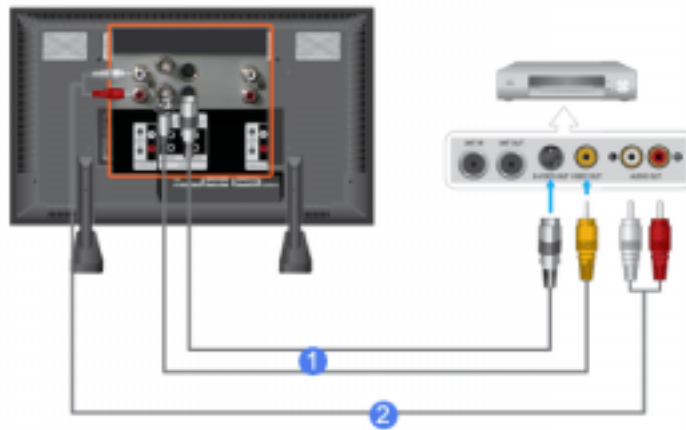

- 1) AV input devices such as VCRs or Camcorders are connected via the **AV IN [VIDEO]** or **AV IN [S-VIDEO]** of the LCD Display using an S-VHS or BNC cable.
- 2) Connect the Audio (L) and Audio (R) terminals of a VCR or Camcorders to the LCD Display's **AV AUDIO IN [L-AUDIO-R]** using audio cables.

 Note

- Select **AV** or **S-Video** for a connected VCR or Camcorder using the **SOURCE** button on the front of the LCD Display or on the remote control.
- Then, start the VCR or Camcorders with a tape inserted.

 Note

- The S-VHS or BNC cable is optional.

➤ **Connecting a DVD Player**

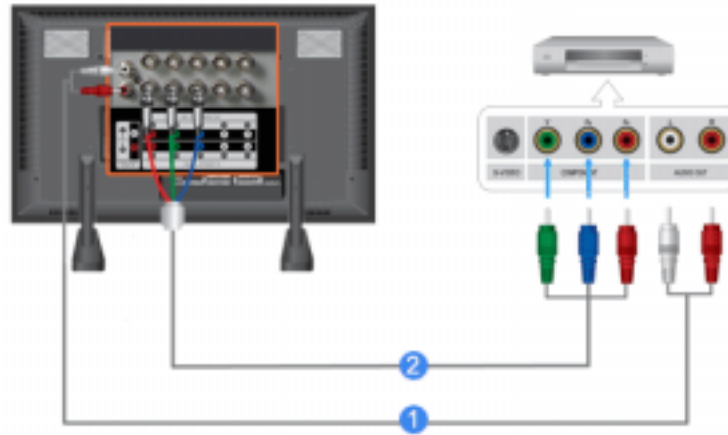

- 1) Connect a set of audio cables between the **COMPONENT AUDIO IN [L-AUDIO-R]** on the LCD Display and the **AUDIO OUT** jacks on the DVD player.
- 2) Connect a Component cable between the **BNC/COMPONENT IN - PR, Y, PB** port on the LCD Display and the **PR, Y, PB** jacks on the DVD player.

Note

- Select **Component** for the connection to a DVD player using the **SOURCE** button on the front of the LCD Display or on the remote control.
- Then, start the DVD Player with a DVD disc inserted.

Note

- A component cable is optional.
For an explanation of Component video, consult your DVD manual.

➤ **Connecting a Camcorder**

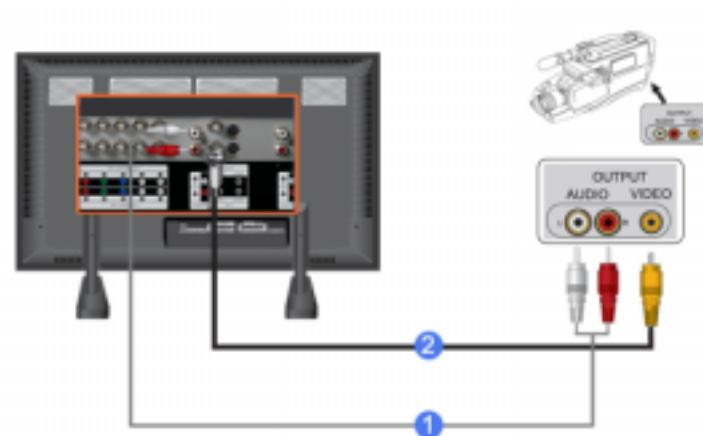

- 1) Locate the **AV** output jacks on the camcorder. They are usually found on the side or back of the camcorder.
Connect a set of audio cables between the **AUDIO OUTPUT** jacks on the camcorder and the **AV AUDIO IN [L-AUDIO-R]** on the LCD Display.
- 2) Connect a video cable between the **VIDEO OUTPUT** jack on the camcorder and the **AV IN [VIDEO]** on the LCD Display.

Note

- Select **AV** for the Camcorder connection using the **SOURCE** button on the front of the LCD Display or on the remote control.
- Then, start the Camcorders with a tape inserted.

Note

- The audio-video cables shown here are usually included with a Camcorder.

(If not, check your local electronics store.)

If your camcorder is stereo, you need to connect a set of two cables.

➤ Connecting a DTV Set Top Box

📌 Note

- The connections for a typical Set Top Box are shown below.

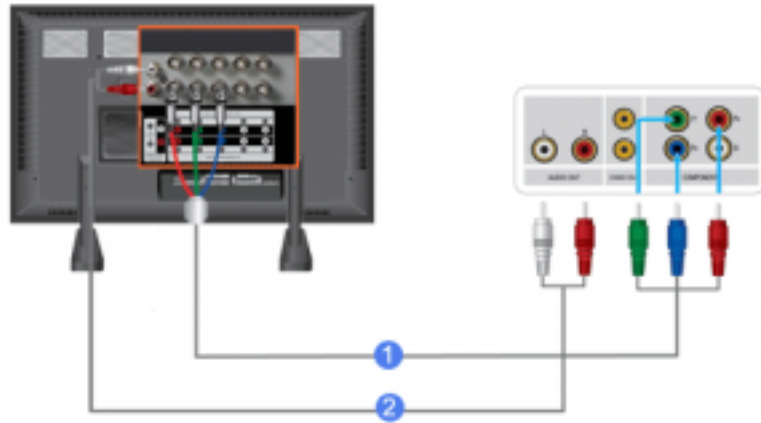

- 1) Connect a Component cable between the **BNC / COMPONENT IN - PR, Y, PB** port on the LCD Display and the PR, Y, PB jacks on the Set Top Box.
- 2) Connect a set of audio cables between the **COMPONENT AUDIO IN [L-AUDIO-R]** on the LCD Display and the AUDIO OUT jacks on the Set Top Box.

📌 Note

- Select **Component** for the connection to a DTV Set Top Box using the SOURCE button on the front of the LCD Display or on the remote control.

📌 Note

- For an explanation of Component video, see your Set Top Box owner's manual.

➤ Connecting to an Audio System

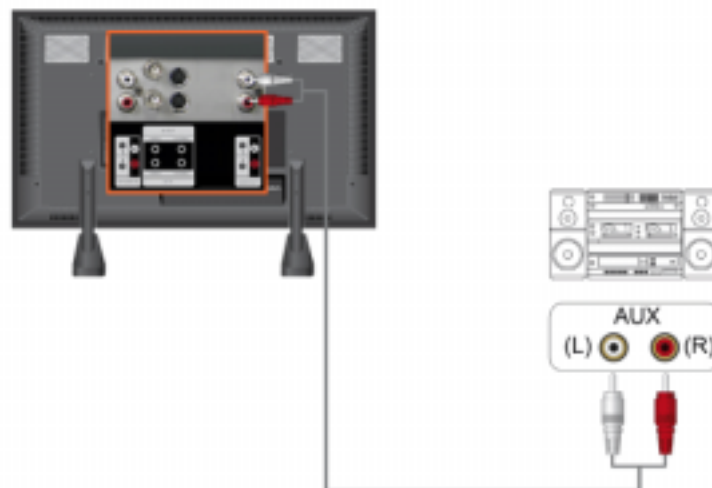

📌 Note

- Connect a set of audio cables between the AUX L, R jacks on the **AUDIO SYSTEM** and the **AUDIO OUT [L-AUDIO-R]** on LCD Display.

➤ Connecting to a Wired Remote Control

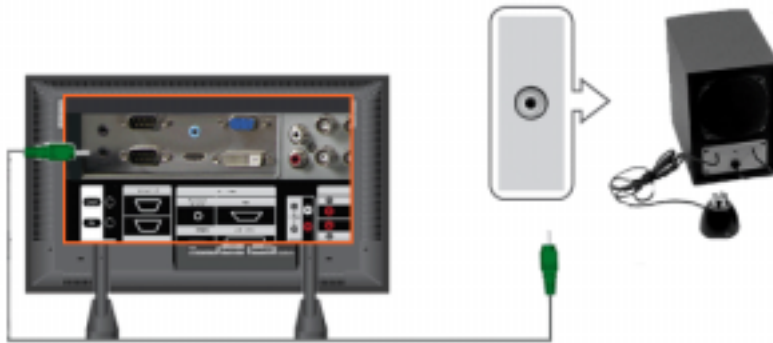

☑ Note

- You can control your monitor by allowing it to receive the remote control signals of other devices through the REMOTE OUT terminal.
- You can control a device by allowing it to receive remote control signals from other devices through the REMOTE IN terminal.

☑ Note

- Restrictions: Available only if other devices support the wired remote control I/O terminals.

➤ Connecting HDMI



☑ Note

- Input devices such as digital DVD are connected to the HDMI IN terminal of the monitor using the HDMI cable.

☑ Note

- You cannot connect a PC to the HDMI IN terminal.

➤ Connecting Using a DVI to HDMI Cable

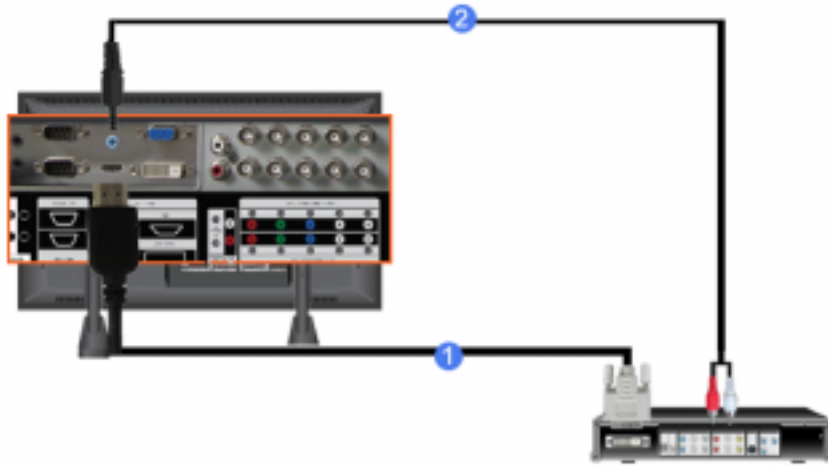

- 1) Connect the DVI output terminal of a digital output device to the HDMI IN terminal of the monitor using a DVI to HDMI cable.
- 2) Connect the red and white jacks of an RCA to stereo (for PC) cable to the same colored audio output terminals of the digital output device, and connect the opposite jack to the HDMI / PC / DVI-D AUDIO IN terminal of the monitor.

➤ **Connecting a LAN Cable**



- 1) Connect the LAN cable.

➤ **Connecting a USB device**



- 1) You can connect USB devices such as a mouse or keyboard.



- Safety Instructions
- Introduction
- Connections
- Using the Software
- Adjusting the LCD Display
- Troubleshooting
- Self-Test Feature Check
- Check List
- Q & A
- Specifications
- Information
- Appendix

SyncMaster

www.samsung.com

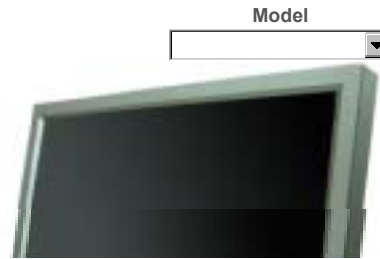

The color and appearance of the product may vary depending on the model, and the product specifications are subject to change without prior notice for reasons of performance enhancement.

Troubleshooting

Self-Test Feature Check

Note

- Check the following items yourself before calling for assistance. Contact a Service Center for problems that you cannot solve by yourself.

➤ Self-Test Feature Check

Your LCD Display provides a self test feature that allows you to check whether your LCD Display is functioning properly.

- 1) Turn off both your computer and the LCD Display.
- 2) Unplug the video cable from the back of the computer.
- 3) Turn on the LCD Display.

The figure shown below ("Check Signal Cable") appears on a black background when the LCD Display is working normally even though no video signal is detected: While in the Self-Test mode, the LED power indicator remains green and the figure moves around on the screen.



- 4) Turn off your LCD Display and reconnect the video cable; then turn on both your computer and the LCD Display

If your LCD Display screen remains blank after using the previous procedure, check your video controller and computer system; **your LCD Display is functioning properly.**

➤ Not Optimum Mode

You can even view the screen at a resolution of 1920 x 1080 . However, you will receive the following message for a minute; You can choose to change the screen resolution or stay in the current mode during that time. And if the resolution is more than 85Hz, you will see the black screen because the LCD Display does not support over 85Hz.

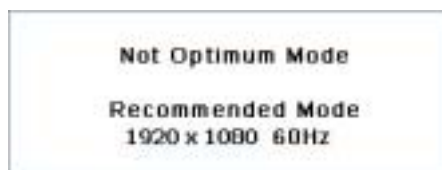

Note

- Refer to [Specifications](#) > [Preset Timing Modes](#) for the resolutions or frequencies supported by the LCD Display.

➤ Maintenance and Cleaning

- 1) Maintaining the LCD Display Case.
Clean with a soft cloth after disconnecting the power cord.



- Do not use benzene, thinner or other flammable substances, or a wet cloth.
- We recommend that a Samsung cleansing agent is used to prevent damage to the screen.

- 2) Maintaining the Flat Panel Display Screen.
Clean with a soft cloth (cotton flannel) smoothly.



- Never use acetone, benzene or thinner.
(They may cause flaws or deformation of the screen surface.)
- The user will be required to pay costs and related expenses for repairing damages caused.

➤ Symptoms and Recommended Actions

Note

- A LCD Display recreates visual signals received from the computer. Therefore, if there is a problem with the computer or the video card, this can cause the LCD Display to become blank, have poor coloring, become noisy, and video mode not supported, etc. In this case, first check the source of the problem, and then contact a [Service Center or your dealer](#).

- 1) Check if the power cord and the video cables are properly connected to the computer.
- 2) Check if the computer beeps more than 3 times when booting.
(If it does, request an a service for the main board of the computer.)
- 3) If you installed a new video card or if you assembled the PC, check if you installed the Adaptor(video).
- 4) Check if the scanning ratio of the video screen is set to between 50 Hz ~ 85 Hz.
(Do not exceed 60Hz when using the maximum resolution.)
- 5) If you have problems in installing the Adaptor (video) driver, boot the computer in Safe Mode, remove the Display Adaptor in the "Control Panel, System, Device Administrator" and then reboot the computer to reinstall the Adaptor (video) driver.

Check List

Note

- The following table lists possible problems and their solutions. Before calling for assistance, check the information in this section to see if you can remedy any problems for yourself. If you do need assistance, [please call the phone number on the Information section or contact your dealer](#).
- For more network-related information, refer to the [MagicNet Troubleshooting](#) section.

➤ Problems related to the Installation (PC Mode)

Note

- Problems related to the LCD Display installation and their solutions are listed.

Problems

Solutions

- Check if the signal cable between the computer and the LCD

The LCD Display screen flickers.

Display is securely connected.
(Refer to [Connecting a Computer](#))

➤ Problems related to the Screen

 Note

- Problems related to the LCD Display screen and their solutions are listed.

Problems	Solutions
The screen is blank and the power indicator is off.	<ul style="list-style-type: none">• Ensure that the power cord is firmly connected and the LCD LCD Display is on. (Refer to the Connecting the LCD Display)
"Check Signal Cable" message.	<ul style="list-style-type: none">• Ensure that the signal cable is firmly connected to the PC or video sources. (Refer to the Connecting the LCD Display)• Ensure that the PC or video sources are turned on.
"Not Optimum Mode " message.	<ul style="list-style-type: none">• Check the maximum resolution and the frequency of the video Adaptor.• Compare these values with the data in the Preset Timing Modes Chart.
The picture rolls vertically.	<ul style="list-style-type: none">• Check if the signal cable is securely connected. Re-connect it, if necessary. (Refer to Connecting a Computer)
The image is not clear; picture is blurred.	<ul style="list-style-type: none">• Run Frequency Coarse and Fine tuning.• Turn on again after removing all accessories (video extension cable, etc.)• Set the resolution and frequency to the recommended ranges.
The picture image is unstable and shakes.	<ul style="list-style-type: none">• Check if the resolution and frequency set for the computer video card falls in the range supported by the LCD Display. If not, reset them referring to the current Information under the LCD Display menu and Preset Timing Modes.
Ghost images are shown in the picture.	
The image is too light or too dark.	<ul style="list-style-type: none">• Adjusts the brightness and contrast. (Refer to the Brightness, Contrast)
The screen color is inconsistent.	
The color image is distorted by dark shadows.	<ul style="list-style-type: none">• Adjust color using Custom under OSD Color Adjustment menu.
The color white is poor.	
The power Indicator blinks green.	<ul style="list-style-type: none">• The LCD Display is currently saving the changes made to the settings to the OSD memory.
The screen is blank and the power indicator light is steady green or blinks every 0.5 or 1 seconds.	<ul style="list-style-type: none">• The LCD Display is using its power management system.• Press a key on the keyboard.
The screen is blank and it is blinking.	<ul style="list-style-type: none">• If you see the "TEST GOOD" message on the screen when you pressing the MENU button, check the cable connection between the LCD Display and the computer to ensure that the connector is properly connected.

➤ Problems related to Audio

 Note

- Problems related to audio signals and their solutions are listed below.

Problems	Solutions
No sound.	<ul style="list-style-type: none"> • Ensure that the audio cable is firmly connected to both the audio-in port on your LCD Display and the audio-out port on your sound card. (Refer to the Connecting the LCD Display) • Check the volume level.
The sound level is too low.	<ul style="list-style-type: none"> • Check the volume level. • If the volume is still too low after turning the control to its maximum, check the volume control on the computer sound card or software program.
The sound is too high or too low.	<ul style="list-style-type: none"> • Adjusts the Treble and Bass to the appropriate levels.

➤ **Problems related to the Remote Control**

Note

- Problems related to the remote control and their solutions are listed.

Problems	Solutions
The remote control buttons do not respond.	<ul style="list-style-type: none"> • Check the polarities (+/-) of the batteries. • Check if the batteries are empty. • Check if the power is on. • Check if the power cord is securely connected. • Check if a special fluorescent or neon lamp is on in the vicinity.

➤ **Problems related to MagicNet**

Note

- Making a Bootable USB Flash Disk.

Problems	Solutions
Making a Bootable USB Flash Disk	<ol style="list-style-type: none"> 1. You can turn a common 512-MB or bigger USB storage media into a bootable disk using a USB bootable disk creation tool. (For example, the HP USB Disk Storage Format Tool) 2. Copies the OS ghost image and executables to your USB disk. 3. Enter the BIOS menu of your set by pressing the F2 key in the BIOS logo screen. Then, enable the USB Boot First option by selecting that option and pressing the Enter key in the Boot menu. 4. Switch your set on while your USB disk is connected and boot up in DOS mode. 5. Run C:\ghost.exe and choose Local → Partition → From Image from the menu. Choose the ghost image to update your USB disk with and choose the target disk. 6. When the ghost image update finishes, the set will be rebooted automatically.

Q & A

Question	Answer
How can I change the frequency?	<p>The frequency can be changed by reconfiguring the video card.</p> <p>Note that video card support can vary, depending on the version of the driver used. (Refer to the computer or the video card manual for details.)</p>
How can I Adjusts the resolution?	<ul style="list-style-type: none"> • Windows XP:

Set the resolution in the Control Panel → Appearance and Themes → Display → Settings.

- Windows ME/2000:

Set the resolution in the Control Panel → Display → Settings.

* Contact the video card manufacturer for details.

How can I set the Power Saving function?

- Windows XP:

Set the resolution in the Control Panel → Appearance and Themes → Display → Screen Saver.

Set the function in the BIOS-SETUP of the computer. (Refer to the Windows / Computer Manual).

- Windows ME/2000:

Set the resolution at the Control Panel → Display → Screen Saver.

Set the function in the BIOS-SETUP of the computer. (Refer to the Windows / Computer Manual).

How can I clean the outer case/LCD Panel?

Disconnect the power cord and then clean the LCD Display with a soft cloth, using either a cleaning solution or plain water.

Do not leave any detergent or scratches on the case. Do not let any water enter the LCD Display.

How can I play the video?

The video supports the MPEG1 and WMV codecs only. Install the corresponding codec to play the video. Note that some of the codecs can be incompatible.