

Acer LCD Monitor

User's Guide

Copyright © 2019. Acer Incorporated.
All Rights Reserved.

Acer LCD Monitor User's Guide
Original Issue: 09/2019

Changes may be made periodically to the information in this publication without obligation to notify any person of such revisions or changes. Such changes will be incorporated in new editions of this manual or supplementary documents and publications. This company makes no representations or warranties, either expressed or implied, with respect to the contents hereof and specifically disclaims the implied warranties of merchantability or fitness for a particular purpose.

Record the model number, serial number, purchase date and place of purchase information in the space provided below. The serial number and model number are recorded on the label affixed to your computer. All correspondence concerning your unit should include the serial number, model number and purchase information.

No part of this publication may be reproduced, stored in a retrieval system, or transmitted, in any form or by any means, electronically, mechanically, by photocopy, recording or otherwise, without the prior written permission of Acer Incorporated.

Acer LCD Monitor User's Guide

Model number: _____

Serial number: _____

Date of purchase: _____

Place of purchase: _____

Acer and the Acer logo are registered trademarks of Acer Incorporated. Other companies' product names or trademarks are used herein for identification purposes only and belong to their respective companies.

Special notes on LCD monitors

The following are normal with the LCD monitor and do not indicate a problem.

- Due to the nature of the fluorescent light, the screen may flicker during initial use. Turn off the power switch and then turn it on again to make sure the flicker disappears.
- You may find slightly uneven brightness on the screen depending on the desktop pattern you use.
- The LCD screen has 99.99% or more effective pixels. It may include blemishes of 0.01% or less such as a missing pixel or a pixel lit all the time.
- Due to the nature of the LCD screen, an afterimage of the previous screen may remain after switching the image, when the same image is displayed for hours. In this case, the screen is recovered slowly by changing the image or turning off the power switch for a few hours.
- Acer monitor is purposed for video and visual display of information obtained from electronic devices.

Information for your safety and comfort

Safety instructions

Read these instructions carefully. Keep this document for future reference. Follow all warnings and instructions marked on the product.

Cleaning your monitor

Please carefully follow these guidelines when cleaning the monitor:

- Always unplug the monitor before cleaning.
- Use a soft cloth to wipe the screen and cabinet front and sides.

Connecting/disconnecting the device

Observe the following guidelines when connecting and disconnecting power from the LCD monitor:

- Make sure the monitor is attached to its base before connecting the power cord to the AC power outlet.
- Make sure both the LCD monitor and the computer are turned off before connecting any cable or unplugging the power cord.
- If the system has multiple sources of power, disconnect power from the system by unplugging all power cords from the power supplies.

Accessibility

Be sure that the power outlet you plug the power cord into is easily accessible and located as close to the equipment operator as possible. When you need to disconnect power from the equipment, be sure to unplug the power cord from the electrical outlet.

Safe listening

To protect your hearing, follow these instructions.

- Gradually increase the volume until you can hear it clearly and comfortably and without distortion.
- After setting the volume level, do not increase it after your ears have adjusted.
- Limit the amount of time listening to music at high volume.
- Avoid turning up the volume to block out noisy surroundings.
- Turn the volume down if you can't hear people speaking near you.

Warnings

- Do not use this product near water.
- Do not place this product on an unstable cart, stand or table. If the product falls, it could be seriously damaged.
- Slots and openings are provided for ventilation to ensure reliable operation of the product and to protect it from overheating. These openings must not be blocked or covered. The openings should never be blocked by placing the product on a bed, sofa, rug or other similar surface. This product should never be placed near or over a radiator or heat register, or in a built-in installation unless proper ventilation is provided.
- Never push objects of any kind into this product through cabinet slots as they may touch dangerous voltage points or short-out parts that could result in a fire or electric shock. Never spill liquid of any kind onto or into the product.
- To avoid damage of internal components and to prevent battery leakage, do not place the product on a vibrating surface.
- Never use it under sporting, exercising, or any vibrating environment which will probably cause unexpected short current or damage internal devices.

Using electrical power

- This product should be operated from the type of power indicated on the marking label. If you are not sure of the type of power available, consult your dealer or local power company.

- Do not allow anything to rest on the power cord. Do not locate this product where people will walk on the cord.
- If an extension cord is used with this product, make sure that the total ampere rating of the equipment plugged into the extension cord does not exceed the extension cord ampere rating. Also, make sure that the total rating of all products plugged into the wall outlet does not exceed the fuse rating.
- Do not overload a power outlet, strip or receptacle by plugging in too many devices. The overall system load must not exceed 80% of the branch circuit rating. If power strips are used, the load should not exceed 80% of the power strip's input rating.
- This product's power cord is equipped with a three-wire grounded plug. The plug only fits in a grounded power outlet. Make sure the power outlet is properly grounded before inserting the power cord plug. Do not insert the plug into a non-grounded power outlet. Contact your electrician for details.



.....

Warning! The grounding pin is a safety feature. Using a power outlet that is not properly grounded may result in electric shock and/or injury.



.....

Note: The grounding pin also provides good protection from unexpected noise produced by other nearby electrical devices that may interfere with the performance of this product.

- Use the product only with the supplied power supply cord set. If you need to replace the power cord set, make sure that the new power cord meets the following requirements: detachable type, UL listed/CSA certified, type SPT-2, rated 7 A 125 V minimum, VDE approved or its equivalent, 4.5 meters (15 feet) maximum length.

Product servicing

Do not attempt to service this product yourself, as opening or removing covers may expose you to dangerous voltage points or other risks. Refer all servicing to qualified service personnel.

Unplug this product from the wall outlet and refer servicing to qualified service personnel when:

- the power cord or plug is damaged, cut or frayed
- liquid was spilled into the product
- the product was exposed to rain or water

- the product has been dropped or the case has been damaged
- the product exhibits a distinct change in performance, indicating a need for service
- the product does not operate normally after following the operating instructions



.....

Note: Adjust only those controls that are covered by the operating instructions, since improper adjustment of other controls may result in damage and will often require extensive work by a qualified technician to restore the product to normal condition.

Potentially explosive environments

Switch off your device in any area with a potentially explosive atmosphere and obey all signs and instructions. Potentially explosive atmospheres include areas where you would normally be advised to turn off your vehicle engine. Sparks in such areas could cause an explosion or fire resulting in bodily injury or even death. Switch off the device near gas pumps at service stations. Observe restrictions on the use of radio equipment in fuel depots, storage and distribution areas; chemical plants; or where blasting operations are in progress. Areas with a potentially explosive atmosphere are often, but not always, marked. They include below deck on boats, chemical transfer or storage facilities, vehicles using liquefied petroleum gas (such as propane or butane), and areas where the air contains chemicals or particles such as grain, dust or metal powders.

Additional safety information

Your device and its enhancements may contain small parts. Keep them out of the reach of small children.

IT Equipment Recycling Information

Acer is strongly committed to environmental protection and views recycling, in the form of salvaging and disposal of used equipment, as one of the company's top priorities in minimizing the burden placed on the environment.

We at Acer are very conscious of the environmental effects of our business and strive to identify and provide the best working procedures to reduce the environmental impact of our products.

For more information and help when recycling, please go to this website:

<https://www.acer-group.com/sustainability/en/our-products-environment.html>

Visit www.acer-group.com for further information on the features and benefits of our other products.

Disposal instructions

This symbol on the product or on its packaging indicates that this product must not be disposed of with your other household waste. Instead, it is your responsibility to dispose of your waste equipment by handing it over to a designated collection point for the recycling of waste electrical and electronic equipment. The separate collection and recycling of your waste equipment at the time of disposal will help to conserve natural resources and ensure that it is recycled in a manner that protects human health and the environment. For more information about where you can drop off your waste equipment for recycling, please contact your local office, your household waste disposal service or the shop where you purchased the product.

<https://www.acer-group.com/sustainability/en/our-products-environment.html>



Recycling Information for the United States of America

Acer encourages information technology (IT) equipment owners to responsibly recycle their equipment when it is no longer needed. Acer offers programs and services to assist equipment owners with this process.

For more information on recycling IT equipment, please go to:

<https://www.acer.com/ac/en/US/content/recycling>

LCD pixel statement

The LCD unit is produced with high-precision manufacturing techniques. Nevertheless, some pixels may occasionally misfire or appear as black or red dots. This has no effect on the recorded image and does not constitute a malfunction.

This product has been shipped enabled for power management:

- Activate display's Sleep mode within 5 minutes of user inactivity.
- Wake the monitor when it is in Active Off mode, move the mouse or press any keyboard key.

Tips and information for comfortable use

Computer users may complain of eyestrain and headaches after prolonged use. Users are also at risk of physical injury after long hours of working in front of a computer. Long work periods, bad posture, poor work habits, stress, inadequate working conditions, personal health and other factors greatly increase the risk of physical injury.

Incorrect computer usage may lead to carpal tunnel syndrome, tendonitis, tenosynovitis or other musculoskeletal disorders. The following symptoms may appear in the hands, wrists, arms, shoulders, neck or back:

- numbness, or a burning or tingling sensation
- aching, soreness or tenderness
- pain, swelling or throbbing
- stiffness or tightness
- coldness or weakness

If you have these symptoms, or any other recurring or persistent discomfort and/or pain related to computer use, consult a physician immediately and inform your company's health and safety department.

The following section provides tips for more comfortable computer use.

Finding your comfort zone

Find your comfort zone by adjusting the viewing angle of the monitor, using a footrest, or raising your sitting height to achieve maximum comfort. Observe the following tips:

- refrain from staying too long in one fixed posture
- avoid slouching forward and/or leaning backward
- stand up and walk around regularly to remove the strain on your leg muscles

Taking care of your vision

Long viewing hours, wearing incorrect glasses or contact lenses, glare, excessive room lighting, poorly focused screens, very small typefaces and low-contrast displays could stress your eyes. The following sections provide suggestions on how to reduce eyestrain.

Eyes

- Rest your eyes frequently.
- Give your eyes regular breaks by looking away from the monitor and focusing on a distant point.
- Blink frequently to keep your eyes from drying out.

Display

- Keep your display clean.
- Keep your head at a higher level than the top edge of the display so your eyes point downward when looking at the middle of the display.
- Adjust the display brightness and/or contrast to a comfortable level for enhanced text readability and graphics clarity.
- Eliminate glare and reflections by:
 - placing your display in such a way that the side faces the window or any light source
 - minimizing room light by using drapes, shades or blinds
 - using a task light
 - changing the display's viewing angle
 - using a glare-reduction filter
 - using a display visor, such as a piece of cardboard extended from the display's top front edge
- Avoid adjusting your display to an awkward viewing angle.
- Avoid looking at bright light sources, such as open windows, for extended periods of time.

Developing good work habits

Develop the following work habits to make your computer use more relaxing and productive:

- Take short breaks regularly and often.
- Perform some stretching exercises.
- Breathe fresh air as often as possible.
- Exercise regularly and maintain a healthy body.

TABLE OF CONTENTS

UNPACKING	1
ATTACHING/REMOVING THE BASE	2
SCREEN POSITION ADJUSTMENT	4
CONNECTING THE POWER CORD	5
SAFETY PRECAUTION	6
CLEANING YOUR MONITOR	6
POWER SAVING	7
DISPLAY DATA CHANNEL (DDC)	7
CONNECTOR PIN ASSIGNMENT	8
STANDARD TIMING TABLE	10
INSTALLATION	11
USER CONTROLS	12
TROUBLESHOOTING	25

UNPACKING

Please check the following items are present when you unpack the box, and save the packing materials in case you will need to ship or transport the monitor in future.

*Below items shown here is indicative only. The actual product may be different.

- LCD Monitor
- Quick Start Guide
- AC Power Cord (Optional)

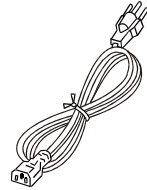
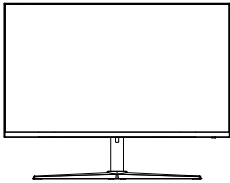

- Power adapter (Optional)
- D-Sub Cable (Optional)
- HDMI Cable (Optional)

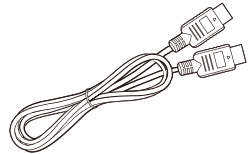
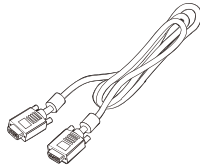
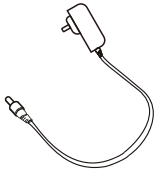

- DP cable (Optional)
- Audio Cable (Optional)
- USB Cable (Optional)

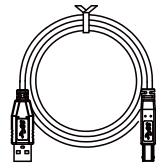
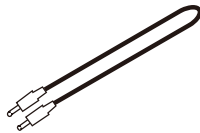
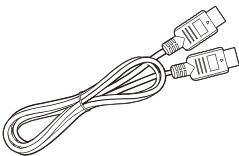

- USB Type C Cable (Optional)

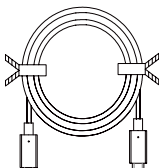

ATTACHING/REMOVING THE BASE



Note: Remove the monitor and monitor base from its packaging. Carefully place the monitor face-down on a stable surface -- use a cloth to avoid scratching the screen.

1. Attach the monitor stand arm to the base.
2. Secure the base to the arm of the monitor stand base.

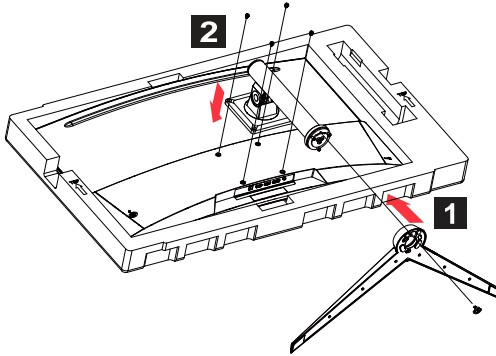

Note: If installing with a wall mounting kit, it is recommended to use VESA mounting kit (100 x 100mm) with M4 x 6 (L) mm screws to fix your monitor on the wall.

Follow these instructions to remove the base from the monitor.



Note: Carefully place the monitor face down on a flat surface-sue a cloth pad to prevent scratching the screen.

1. Press the release latch with a screwdriver.
2. Remove the screws that connect to the base.

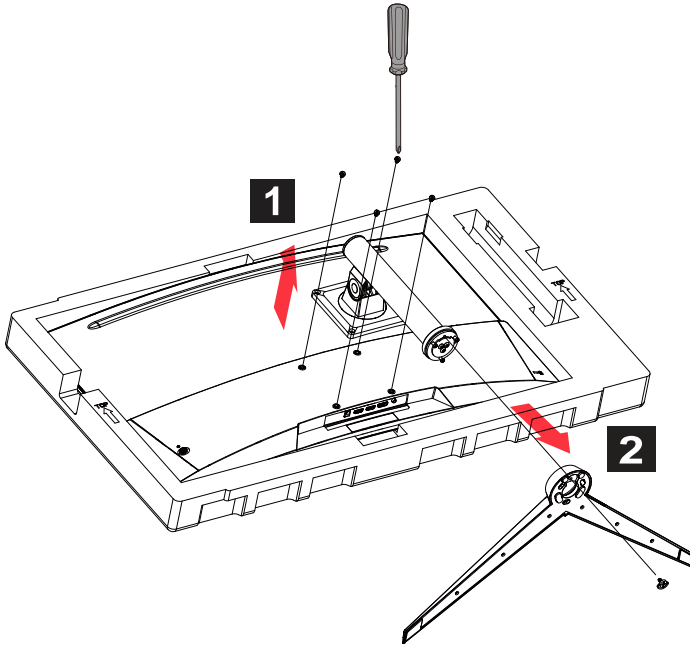

SCREEN POSITION ADJUSTMENT

In order to optimize the best viewing position, you can adjust the height/tilt of the monitor.

- **Tilt**

Please see the illustration below for an example of the tilt range.

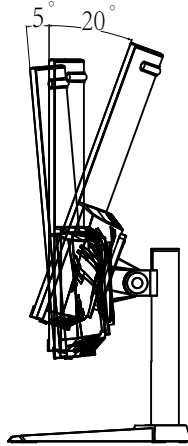

- **Height Adjustment**

After pressing the top of the monitor then you can adjust the height of the monitor.

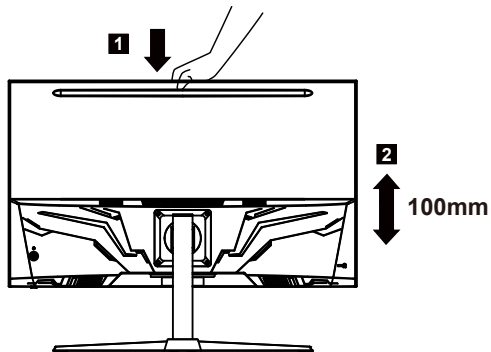

- **Swivel**

With the built-in pedestal, you can swivel the monitor for the most comfortable viewing angle.

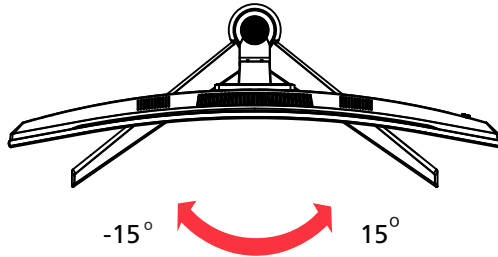

CONNECTING THE POWER CORD

- Check first to make sure that the power cord you use is the correct type required for your area.
- This monitor has a universal power supply that allows operation in either 100/120V AC or 220/240 V AC voltage area. No user-adjustment is required.
- Plug one end of the AC power cord to an AC inlet, and plug the other end into an AC outlet.
- For unit using at 120 V AC:
Use a UL Listed Cord Set, Type SVT wire and plug rated 10 A/125 V.
- For unit using at 220/240 V AC (outside of U.S.):
Use a Cord Set consisting of H05VV-F cord and plug rated 10 A, 250 V.
The cord set should have the appropriate safety approvals for the country in which the equipment will be installed.

SAFETY PRECAUTION

- Avoid placing the monitor, or any other heavy object, on the power cord to avoid damage to the cable.
- Do not expose the monitor to rain, excessive moisture, or dust.
- Do not cover the ventilation slots or openings of the monitor. Always put the monitor in a place where there is adequate ventilation.
- Avoid placing the monitor against a bright background or where sunlight or other light sources may reflect on the face of the monitor. Place the monitor just below eye level.
- Handle with care when transporting the monitor.
- Refrain from giving shock or scratch to the screen, as screen is fragile.
- In order to prevent damage to the monitor, do not lift the monitor by its base.

CLEANING YOUR MONITOR

Please carefully follow the below guidelines when cleaning the monitor.

- Always unplug the monitor before cleaning.
- Use a soft cloth to gently wipe the screen and cabinet front and sides.
- **NEVER SPRAY OR POUR ANY LIQUID DIRECTLY ONTO THE SCREEN OR CASE.**
- **PLEASE DO NOT USE ANY AMMONIA OR ALCOHOL-BASED CLEANERS ON THE LCD DISPLAY SCREEN OR CASE.**
- Acer will not be liable for damage resulting from use of any ammonia or alcohol-based cleaners.

POWER SAVING

The monitor will be driven into “Power Saving” mode by the control signal from the display controller, as indicated by the LED flashes power LED.

State	LED Light
ON	Blue
Power Saving Mode	Type 1: Amber Type 2: LED flashes

The power saving states will be kept until a control signal has been detected or the keyboard or mouse is activated. The recovery time from Active OFF state back to ON state is around 3 seconds.

DISPLAY DATA CHANNEL (DDC)

To make your installation easier, the monitor is able to Plug and Play with your system if your system also supports DDC protocol. The DDC (Display Data Channel) is a communication protocol through which the monitor automatically informs the host system about its capabilities, for example, supported resolutions and corresponding timing. The monitor supports DDC2B standard.

CONNECTOR PIN ASSIGNMENT

19-Pin Color Display Signal Cable*

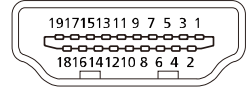

PIN	Meaning	PIN	Meaning
1.	TMDS Data2+	10.	TMDS Clock+
2.	TMDS Data2 Shield	11.	TMDS Clock Shield
3.	TMDS Data2-	12.	TMDS Clock-
4.	TMDS Data1+	13.	CEC
5.	TMDS Data1 Shield	14.	Reserved (N.C. on device)
6.	TMDS Data1-	15.	SCL
7.	TMDS Data0+	16.	SDA
8.	TMDS Data0 Shield	17.	DDC/CEC Ground
9.	TMDS Data0-	18.	+5V Power
		19.	Hot Plug Detect

* only for certain models

20-Pin Color Display Signal Cable*

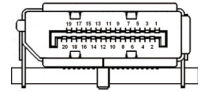

PIN	Description	PIN	Description
1.	Lane0(p)	11.	GND
2.	GND	12.	Lane3(n)
3.	Lane0(n)	13.	Config1
4.	Lane1(p)	14.	Config2
5.	GND	15.	AUX_CH (n)
6.	Lane1(n)	16.	GND
7.	Lane2(p)	17.	AUX_CH (p)
8.	GND	18.	Hot Plug Detect
9.	Lane3(n)	19.	DP Power_Return
10.	Lane3(p)	20.	DP Power

* only for certain models

15-pin color display signal cable

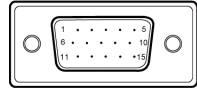

Threading	Explanations	Threading	Explanations
1.	Red	9.	+5 V
2.	Green	10.	Logic ground
3.	Blue	11.	Monitor ground
4.	Monitor ground	12.	DDC-continuous data
5.	DDC return	13.	Line sync signal
6.	Red-ground	14.	Field sync signal
7.	Green-ground	15.	DDC-continuous clock
8.	Blue-ground		

* only for certain models

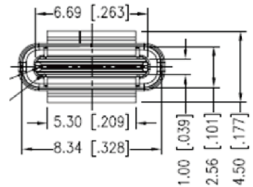

24-pin USB Type C cable

PIN No.	Signal Assignment	PIN No.	Signal Assignment
A1	GND	B12	GND
A2	SSTXp1	B11	SSTXp1
A3	SSTXn1	B10	SSTXn1
A4	VBUS	B9	VBUS
A5	CC1	B8	CC1
A6	Dp1	B7	Dp1
A7	Dn1	B6	Dn1
A8	SBU1	B5	SBU1
A9	VBUS	B4	VBUS
A10	SSTXn2	B3	SSTXn2
A11	SSTXp2	B2	SSTXp2
A12	GND	B1	GND

* only for certain models

STANDARD TIMING TABLE

	Mode	Resolution	Remark
1	VGA	640x480	60Hz
2		640x480	72Hz
3		640x480	75Hz
4	MAC	640x480	66.66Hz
5	VESA	720x400	70Hz
6	SVGA	800x600	56Hz
7		800x600	60Hz
8		800x600	72Hz
9		800x600	75Hz
10	MAC	832x624	74.55Hz
11	XGA	1024x768	60Hz
12		1024x768	70Hz
13		1024x768	75Hz
14	MAC	1152x870	75Hz
15	VESA	1152x864	75Hz
16		1280x960	60Hz
17	SXGA	1280x1024	60Hz
18		1280x1024	75Hz
19	VESA	1280x720	60Hz
20	WXGA	1280x800	60Hz
21	WXGA+	1440x900	60Hz
22	WSXGA+	1680x1050	60Hz
23	UXGA	1920x1080	60Hz
24		1920x1080	75Hz
25		1920x1080	120Hz
26		1920x1080	144Hz
27		1920x1080	180Hz



Note: If the monitor support DisplayPort, it is purposely supporting the G-Sync compatible/Freesync/Freesync Premium/Freesync Premium Pro /Adaptive-Sync (DP) support technology. This technology allows Freesync/ Freesync Premium/Freesync Premium Pro/Adaptive-Sync (DP) supported graphics source to dynamically adjust display refresh rate based on typical content frame rates in order to eliminate stuttering and enhance low-latency display.

INSTALLATION

To install the monitor to your host system, please follow the steps as given below:

Steps

1. Turn off your computer and unplug the power cord.
2. 2-1 Connect Video Cable
 - a. Make sure both the monitor and computer are powered-OFF.
 - b. Connect the VGA cable to the computer. (Optional)
- 2-2 Connect HDMI Cable (Only HDMI-input model) (Optional)
 - a. Make sure both the monitor and computer are powered-OFF.
 - b. Connect the HDMI cable to the computer.
- 2-3 Connect DP Cable (Only DP-input model) (Optional)
 - a. Make sure both the monitor and computer are powered-OFF.
 - b. Connect the DP cable to the computer.
3. Connect the Audio cable (only Audio input model) (optional)
4. Connect the USB Type C Cable (only USB Type C input model) (Optional)
5. Insert the monitor power cable into the power port at the back of the monitor.
6. Plug the power cords of your computer and your monitor into a near by electrical outlet.
7. Select Power-off USB charge ON/OFF to enable/disable Power-off USB charge function. (Optional)

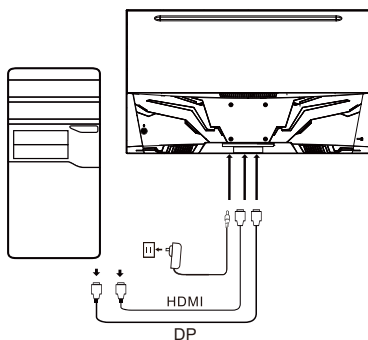

~		Note: The location and names of the sockets on the monitor may vary according to monitor model, and some sockets may not available for some models.
HDMI (optional)	🎧 (optional)	
VGA IN (optional)	USB (optional)	
AUDIO IN (optional)	DP (optional)	
AUDIO OUT(optional)	USB Type C (Optional)	

USER CONTROLS

Base Controls

Note: The location and names of the function buttons and power button on the monitor may vary according to monitor model, and some button may not available for some models.

Type 1

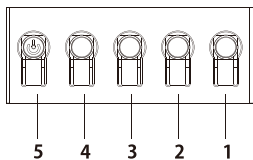

No.	Description
1	Go to the main menu.
2	Enter the source mode.
3/4	HotKey 1, 2 buttons. Press to activate user defined hotkey function.
5	In the powered-off state, pressing the button powers on the device; in the powered-on state, pressing the button normally enters the mode switching menu, and long-pressing for 3 seconds powers off the device.

Type 2

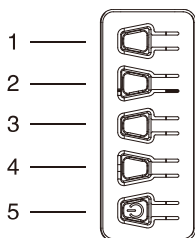

No.	Description
1	Enter the mode switching menu.
2	Enter brightness adjustment.
3	Enter the source mode.
4	Go to the main menu.
5	Power on/off.

Type 3-1

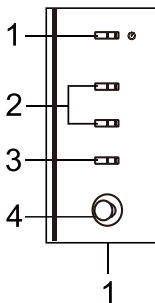

No.	Item	Description
1	Power button/indicator	Turns the monitor on/off. Blue indicates power on. Amber indicates standby/power saving mode.
2	Hotkey 1, 2 buttons	Press to activate user defined hotkey function.
3	Input button	Press to toggle input sources.
4	Navi/OK button	Press to activate the OSD menu, then use it as directional key to highlight the desired function. Press it again to enter a selection.

Type 3-2

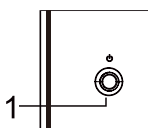

No.	Item	Description
1	Menu/Navi/OK button	Power on/Long press to Power off. Enter the main menu, Select/Adjust menu options.

Using the Shortcut Menu



Note: The following content is for general reference only. Actual product specifications may vary.

The OSD (on-screen display) can be used for adjusting the settings of your LCD Monitor. Press the MENU key to open the OSD. You can use the OSD to adjust the picture quality, OSD position and general settings. For advanced settings, please refer to following page:

The button and the actual functions depend on detail model. Some functions might be grayed if the model can not support.

Main Page

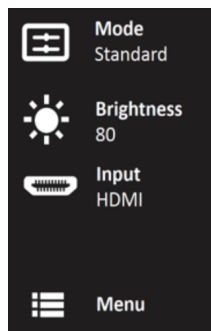

Turn Modes on or off



Note: Please select the button function operation according to the actual button type.

The button of Type 1

From any function page, press buttons 5 to open the Modes control and select which user-defined profile to use (please see the OSD section for more information).

The button of Type 2

From any function page, press buttons 1 to open the Modes control and select which user-defined profile to use (please see the OSD section for more information).

The button of Type 3-1

From any function page, press  to open the Modes control and select which user-defined profile to use (please see The Function page section for more information).

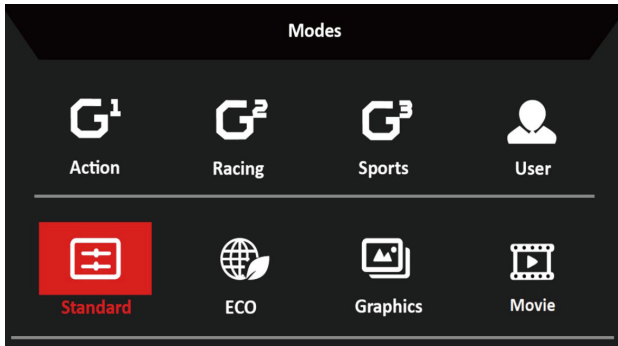

The Function page



The button of Type 1

Double-press Button 1 to select the menu function, and then use Buttons 1/2/3/4 to adjust the settings you need. When finished, use Button 4 to return to the previous level or exit the menu.

The button of Type 2

Double-press Button 4 to select the menu function, and then use Buttons 1/2/3/4 to adjust the settings you need. When finished, use Button 4 to return to the previous level or exit the menu.

The button of Type 3-1

Open the Function page to select a menu function, and adjust the settings which you want using the Navi/OK button. When you are done, press  to exit. You can also press  from any function page to select your preferred Mode.

The button of Type 3-2

Open the Function page to select the menu function, and then use the Button Menu/Navi/Ok to adjust the settings you need. When finished, Pull left the Button Menu/Navi/Ok to return to the previous level or exit the menu.

Adjusting the Settings

Use buttons to open the OSD and navigate to the Settings you need.

The button of Type 1

1. Double-press Button 1 to bring up the OSD.
2. Use Buttons 1/2 to select the Settings you need from the OSD.
3. Then press Button 3 to navigate to the setting you want to adjust.

The button of Type 2

1. Double-press Button 4 to bring up the OSD.
2. Use Buttons 1/2 to select the Settings you need from the OSD.
3. Then press Button 3 to navigate to the setting you want to adjust.

The button of Type 3-1

1. Press the MENU button to open the OSD.
2. Using the Navi/Ok button, to select the Settings you need from the OSD.
3. Then Using the Navi/Ok button to navigate to the setting you want to adjust.

The button of Type 3-2

1. Press the Menu/Navi/OK button to open the OSD.
2. Using the Menu/Navi/Ok button, to select the Settings you need from the OSD.
3. Then Using the Menu/Navi/Ok button to navigate to the setting you want to adjust.

Adjusting the Picture

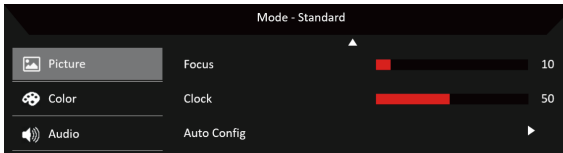
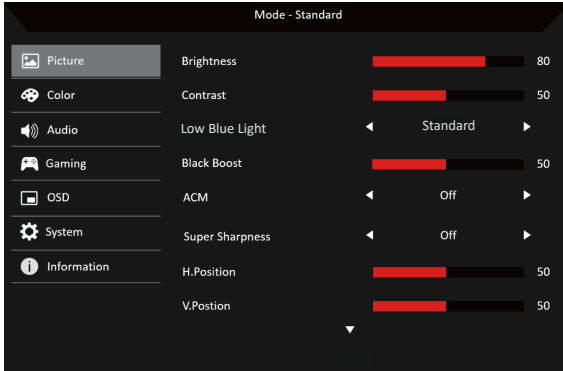

1. Brightness: Adjust the brightness from 0 to 100.



Note: Adjusts the balance between light and dark shades.

2. Contrast: adjust the contrast from 0 to 100.



Note: Sets the degree of difference between light and dark areas.

3. Low Blue Light: Filter out blue light to protect your eyes by adjusting how much blue light is shown --Level 1, 2, 3, 4.



Note: A lower level allows more blue light to pass through, so in order to achieve the best protection, please select a higher level, of which Level 4 is in the best state.

4. Black Boost: This boosts the amplitude of the dark color levels of the display— blacks will be less black. The higher the level, the higher the boost.

5. ACM: Turn ACM on or off. The default is off.
6. Super Sharpness technology can simulate high-resolution images by boosting the pixel density of the original source. It can make images sharper and clear.
7. H. Position: Adjust the horizontal position from 0 to 100.
8. V. Position: Adjust the vertical position from 0 to 100.
9. Focus: Adjust the focus from 0 to 100.
10. Clock: Adjust the clock from 0 to 100.

Adjusting the Color

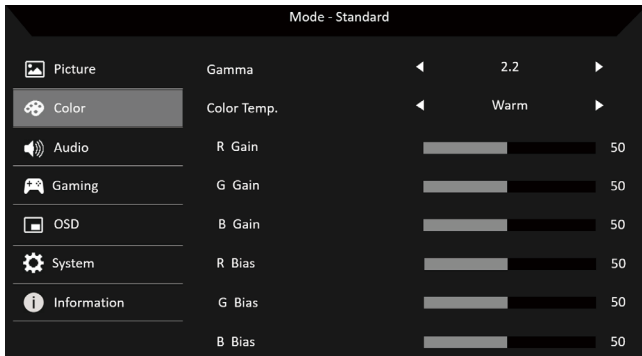

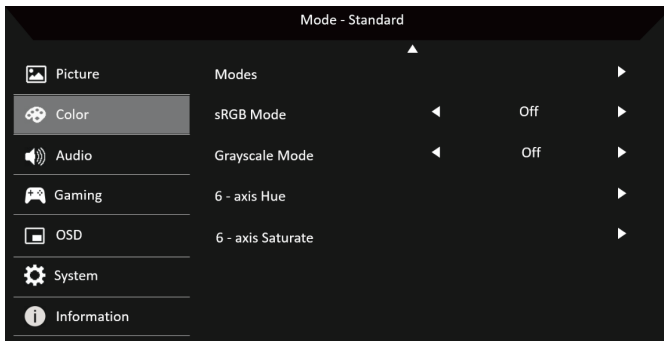

1. Gamma mode allows you to adjust the luminance tone. The default value is 2.2 (standard value for Windows).

2. Color temperature: Default is warm. You can choose Cool, Warm, Normal, Low Blue Light or User.
3. Modes: Select your preferred mode.
4. sRGB mode is for getting better color matching representation with the peripheral device, such as DSCs or printers.
5. Grayscale Mode: Turn grayscale mode On or Off.
6. 6-axis Hue: Adjust the red, green, blue, yellow, magenta and cyan hue.
7. 6-axis Saturate: Adjust the red, green, blue, yellow, magenta and cyan saturation.

Adjusting the Audio

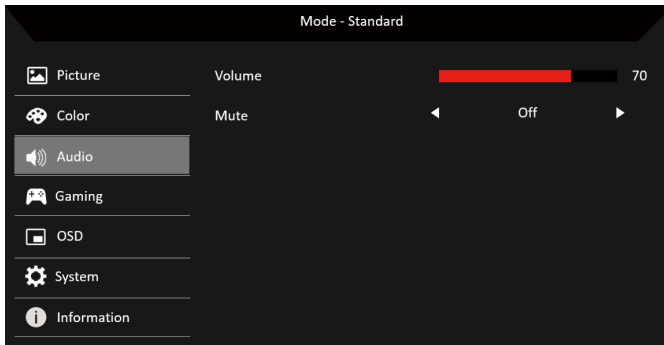

1. Volume: Adjusts the volume.
2. Mute: Select On or Off.

Adjusting the Gaming

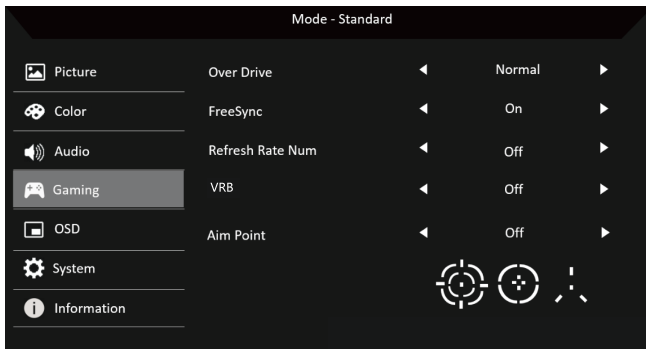

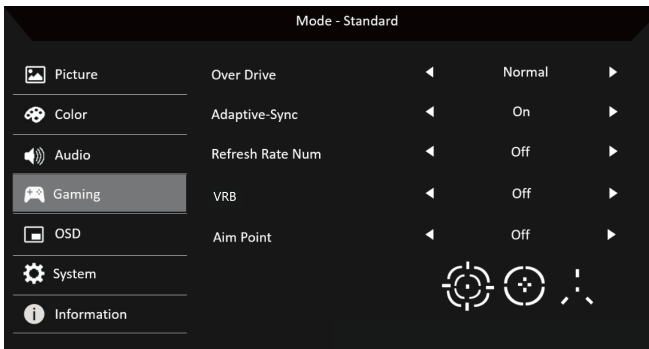
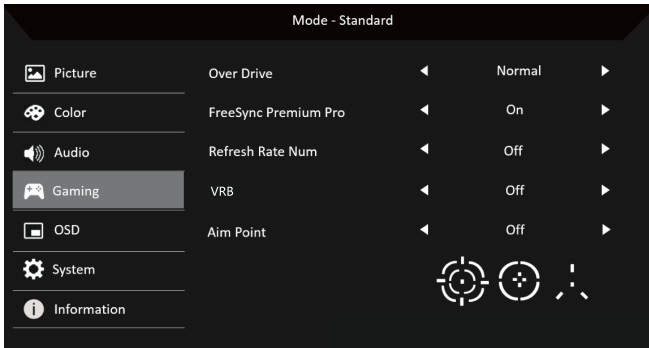
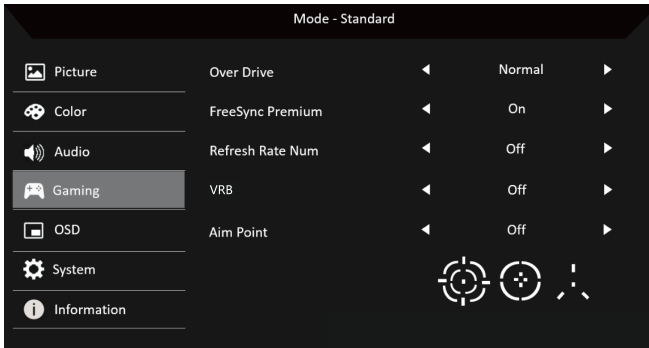

1. Over Drive: Select Off, Normal, or Extreme.



Note:

1. If FreeSync/Freesync Premium/Freesync Premium Pro/Adaptive-Sync is “ON”, then the Over Drive selection is set to “Normal” automatically
2. If FreeSync/Freesync Premium/Freesync Premium Pro/Adaptive-Sync is “OFF”, then the user can set Over Drive to either one of the three settings including: (a) Extreme (b) Normal (c) Off

2. FreeSync: Select On or Off. FreeSync is available for AMD supported graphic cards only.
FreeSync Premium: Select On or Off. FreeSync Premium is available for AMD supported graphic cards only.
FreeSync Premium Pro: Select On or Off. FreeSync Premium pro is available for AMD supported graphic cards only.
Adaptive-Sync: Select On or Off. Adaptive-Sync is available for AMD supported graphic cards only.



Note: FreeSync/FreeSync Premium/FreeSync Premium Pro/Adaptive-Sync depend on detail model.

3. Refresh Rate Num: Display the panel's current refresh rate on the screen.
4. VRB: When VRB is Extreme or Normal, VRB provides a sharper and clearer dynamic picture; the default is Off.



- VRB does not support PIP/PBP Mode and HDR Mode. (Selective models)
- When VRB is Extreme or Normal, FreeSync/FreeSync Premium/FreeSync Premium Pro/Adaptive-Sync is automatically turned off.
- VRB will affect the brightness of the following: Logo, Aim Point, Message and Input Icon.
- VRB feature is dependent on the monitor's maximum refresh rate. And it is available when the refresh rate is greater or equal to 75Hz.

5. Aim Point: Show an Aim point on the screen for shooting games.



Note: Aim Point is not supported in PBP mode.

Adjusting the OSD

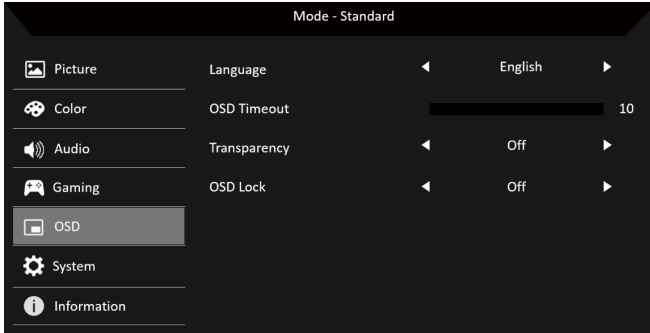

1. Language: Set the OSD menu language.
2. OSD Timeout: Adjust the delay before turning the off the OSD menu.
3. Transparency: Select the transparency when using gaming mode. The transparency can be 0% (OFF), 20%, 40%, 60%, or 80%.
4. OSD Lock: OSD Lock function is used to prevent OSD button from being pressed accidentally.



Note:

1. For Side 9 key, Must press Navi Key in the middle to unlock OSD.
2. For side/Bottom 1/5 key, except power key can be unlocked.

Adjusting the System

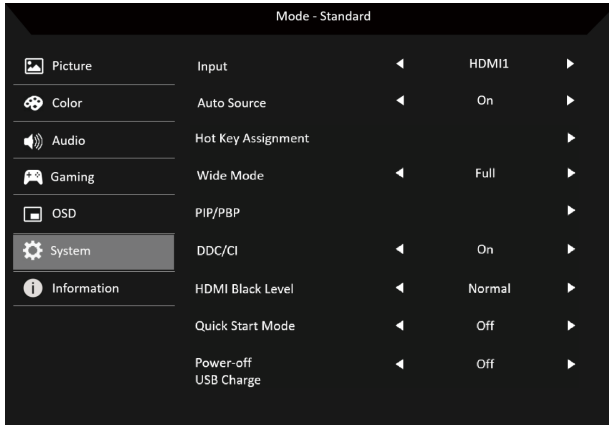

1. Input: Select the source from an available input source.
2. Auto Source: Automatically searches for available input sources.
3. Hot Key Assignment: Select the function of Hot Key 1 or Hot Key 2.
4. Wide Mode: You can select which screen aspect you are using.
5. PIP/PBP: The options for PIP/PBP Mode are Off, PIP Large, PIP Small, and PBP. You can also adjust the PIP Position, PBP Size, Sub Source, Source Swap, and Audio Source.
6. DDC/CI: Allows the monitor settings to be set through the software on the PC.



Note: DDC/CI, short for Display Data Channel/Command Interface, which allows monitor controls to be sent via software.

7. HDMI Black Level: You can select the level of blackness under HDMI source. The options are Normal and Low.
8. Quick Start Mode: Enable monitor rapidly.
9. Power-off USB charge (Optional): Turn On or Off.
(*only for USB function)

Product information

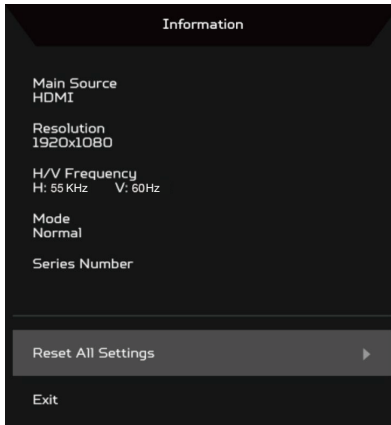
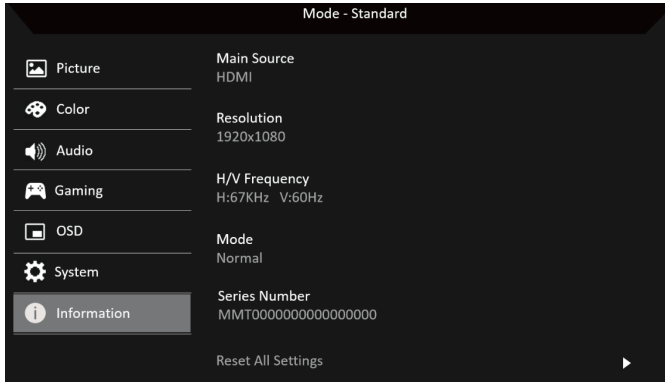

1. View the basic information of the machine.
2. Reset All Settings: Reset all settings to factory defaults.

TROUBLESHOOTING

Before sending your LCD monitor for servicing, please check the troubleshooting list below to see if you can self-diagnose the problem. (HDMI/DP Mode)

Problems	Current Status	Remedy
No Picture	LED ON	<ul style="list-style-type: none"> Using OSD, adjust brightness and contrast to maximum or reset to their default settings.
	LED OFF	<ul style="list-style-type: none"> Check the power switch.
		<ul style="list-style-type: none"> Check if AC power cord is properly connected to the monitor.
	LED flashes	<ul style="list-style-type: none"> Check that the video signal cable is properly connected to the back of the monitor.
		<ul style="list-style-type: none"> Check whether the computer system's power is on.
Abnormal Sound (Only Audio-Input model) (Optional)	No sound, or sound level is too low	<ul style="list-style-type: none"> Check the audio cable with the host PC is connected.
		<ul style="list-style-type: none"> Check if the volume setup of the host PC is in minimum position and try to raise the volume level.

(VGA Mode)

Problems	Current Status	Remedy
No Picture	LED ON	<ul style="list-style-type: none">Using OSD, adjust brightness and contrast to maximum or reset to their default settings.
	LED OFF	<ul style="list-style-type: none">Check the power switch.
		<ul style="list-style-type: none">Check if AC power cord is properly connected to the monitor.
LED flashes	<ul style="list-style-type: none">Check if video signal cable is properly connected at the back of monitor.	
	<ul style="list-style-type: none">Check if the power of computer system is ON.	
Abnormal Picture	Unstable Picture	<ul style="list-style-type: none">Check if the specification of graphics adapter and monitor is in compliance which may be causing the input signal frequency mismatch.
	Display is missing, center shift, or too small or too large in display size	<ul style="list-style-type: none">Using OSD, adjust RESOLUTION, CLOCK, CLOCK-PHASE, H-POSITION and V-POSITION with non-standard signals.
		<ul style="list-style-type: none">Using OSD, in case of missing full-screen image, please select other resolution or other vertical refresh timing.
Abnormal Sound (Only Audio- Input model) (Optional)	No sound, or sound level is too low	<ul style="list-style-type: none">Wait for a few seconds after adjusting the size of the image before changing or disconnecting the signal cable or powering OFF the monitor.
		<ul style="list-style-type: none">Check the audio cable with the host PC is connected.
		<ul style="list-style-type: none">Check if the volume setup of the host PC is in minimum position and try to raise the volume level.



EU Declaration of Conformity

We,

Acer Incorporated

8F, 88, Sec. 1, Xintai 5th Rd., Xizhi, New Taipei City 221

And,

Acer Italy s.r.l.

Viale delle Industrie 1/A, 20044 Arese (MI), Italy

Tel: +39-02-939-921, Fax: +39-02 9399-2913

www.acer.it

Product:	LCD Monitor
Trade Name:	ACER
Model Number:	XZ320Q
SKU Number:	XZ320Q xxxxxx (“x” = 0~9, a ~ z, A ~ Z, or blank)

We, Acer Incorporated, hereby declare under our sole responsibility that the product described above is in conformity with the relevant Union harmonization legislations as below Directive and following harmonized standards and/or other relevant standards have been applied:

EMC Directive: 2014/30/EU

<input checked="" type="checkbox"/> EN55032:2015+A1: 2020 Class B	<input checked="" type="checkbox"/> EN 55035:2017+A11: 2020
<input checked="" type="checkbox"/> EN IEC 61000-3-2:2019+A1:2021 Class D	<input checked="" type="checkbox"/> EN 61000-3-3:2013+A2:2021

LVD Directive: 2014/35/EU

<input checked="" type="checkbox"/> EN 62368-1: 2014+ A11: 2017

RoHS Directive: 2011/65/EU

<input checked="" type="checkbox"/> EN IEC 63000: 2018
--

ErP Directive: 2009/125/EC

<input checked="" type="checkbox"/> (EU) 2019/ 2021 ; EN 50564:2011

Year to begin affixing CE marking: 2023.

RU Jan / Sr. Manager
Acer Incorporated (New Taipei City)

Aug. 30,2023
Date



Acer America Corporation
333 West San Carlos St.,
Suite 1500
San Jose, CA 95110
U. S. A.
Tel : 254-298-4000
Fax : 254-298-4147
www.acer.com



Federal Communications Commission Declaration of Conformity

This device complies with Part 15 of the FCC Rules. Operation is subject to the following two conditions:
(1) this device may not cause harmful interference, and (2) this device must accept any interference received, including interference that may cause undesired operation.

The following local Manufacturer /Importer is responsible for this declaration:

Product:	LCD Monitor
Model Number:	XZ320Q
SKU Number:	XZ320Q xxxxxx (“x” = 0~9, a~z, A~Z, or blank)
Name of Responsible Party:	Acer America Corporation
Address of Responsible Party:	333 West San Carlos St. Suite 1500 San Jose, CA 95110 U. S. A.
Contact Person:	Acer Representative
Phone No.:	254-298-4000
Fax No.:	254-298-4147

English	Product Information for EU Energy Label
Bahasa Indonesian	Informasi produk untuk Label Energi UE
Deutsch	Produktinformationen für das EU Energielabel
Español	Información de producto para EU Energy Label
Français	Informations produit pour le label énergétique de l'UE
Italiano	Informazioni prodotto per la classe di efficienza energetica UE
Nederlands	Productinformatie voor EU-energielabel
Polski	Informacje o produkcie dla etykiety energetycznej UE
Português	Informação de Produto para Etiqueta Energética da UE
Svenska	Produktinformation för EU:s energimärkning
繁體中文	用於歐盟能源標示的產品資訊
简体中文	用于欧盟能源标识的产品信息
日本語	EU エネルギーラベルのための製品情報
Magyar	Termékinformációk az EU energiacímkehez
Ελληνικά	Πληροφορίες προϊόντος για την ενεργειακή ετικέτα της ΕΕ
Slovensky	Informácie o výrobku pre energetický štítok EU
Dansk	Produktoplysninger for EU-energimærke
Suomi	Tuotetiedot EU-energiatarraa varten
Norsk	Produktinformasjon for EU-energetikett
Türkçe	AB Enerji Etiketleri için Ürün Bilgileri
Română	Informații despre produs pentru eticheta UE privind eficiența energetică
български	Продуктова информация за енергийния етикет на Европейския съюз
Eesti	Tooteteave EL-i energiämärgisele
Lietuvių	Gaminio informacija ES energijos vartojimo efektyvumo etiketei
Latviski	Produkta informācija ES Enerģijas marķējumam
Hrvatski	Podaci o proizvodu za energetska oznaku EU
ไทย	ข้อมูลผลิตภัณฑ์สำหรับฉลากพลังงานสหภาพยุโรป
Srpski	Informacije o proizvodu za EU energetska oznaku
العربية	معلومات المنتج لعلامة الطاقة في الاتحاد الأوروبي
Português (Brasil)	Informações do produto para a Etiqueta de Energia da UE
Українська	Інформація про продукт для маркування енергоефективності ЄС
Čeština	Informace o produktu pro energetický štítek v EU
Русский	Информация о продукте для маркировки этикеткой энергетической эффективности ЕС
Slovenščina	Informacije o izdelku za energijsko nalepko EU

