



# OWNER'S MANUAL

# LED LCD TV

Please read this manual carefully before operating your set and retain it for future reference.

LM6200 series  
LM6250 series

LM6400 series  
LM6450 series

LM6700 series  
LM7600 series

## LICENSES

Supported licenses may differ by model. For more information about licenses, visit [www.lg.com](http://www.lg.com).



Manufactured under license from Dolby Laboratories. "Dolby" and the double-D symbol are trademarks of Dolby Laboratories.



HDMI, the HDMI logo and High-Definition Multimedia Interface are trademarks or registered trademarks of HDMI Licensing LLC.



ABOUT DIVX VIDEO: DivX® is a digital video format created by DivX, LLC, a subsidiary of Rovi Corporation. This is an official DivX Certified® device that plays DivX video. Visit [divx.com](http://divx.com) for more information and software tools to convert your files into DivX video.

ABOUT DIVX VIDEO-ON-DEMAND: This DivX Certified® device must be registered in order to play purchased DivX Video-on-Demand (VOD) movies. To obtain your registration code, locate the DivX VOD section in your device setup menu. Go to [vod.divx.com](http://vod.divx.com) for more information on how to complete your registration.

"DivX Certified® to play DivX® video up to HD 1080p, including premium content."

"DivX®, DivX Certified® and associated logos are trademarks of Rovi Corporation or its subsidiaries and are used under license."

"Covered by one or more of the following U.S. patents:  
7,295,673; 7,460,668; 7,515,710; 7,519,274"



Manufactured under license under U.S. Patent Nos: 5,956,674; 5,974,380; 6,487,535 & other U.S. and worldwide patents issued & pending. DTS, the Symbol & DTS and the Symbol together are registered trademarks & DTS 2.0+Digital Out is a trademark of DTS, Inc. Product includes software. © DTS, Inc. All Rights Reserved.

## OPEN SOURCE SOFTWARE NOTICE

To obtain the source code under GPL, LGPL, MPL and other open source licenses, that is contained in this product, please visit <http://opensource.lge.com>.

In addition to the source code, all referred license terms, warranty disclaimers and copyright notices are available for download.

LG Electronics will also provide open source code to you on CD-ROM for a charge covering the cost of performing such distribution (such as the cost of media, shipping and handling) upon email request to [opensource@lge.com](mailto:opensource@lge.com). This offer is valid for three (3) years from the date on which you purchased the product.

# IMPORTANT SAFETY INSTRUCTIONS

Always comply with the following precautions to avoid dangerous situations and ensure peak performance of your product.





**WARNING/CAUTION**

**RISK OF ELECTRIC SHOCK  
DO NOT OPEN**



TO REDUCE THE RISK OF ELECTRIC SHOCK DO NOT REMOVE COVER (OR BACK). NO USER SERVICEABLE PARTS INSIDE. REFER TO QUALIFIED SERVICE PERSONNEL.

 The lightning flash with arrowhead symbol, within an equilateral triangle, is intended to alert the user to the presence of uninsulated "dangerous voltage" within the product's enclosure that may be of sufficient magnitude to constitute a risk of electric shock to persons.

 The exclamation point within an equilateral triangle is intended to alert the user to the presence of important operating and maintenance (servicing) instructions in the literature accompanying the appliance.

**WARNING/CAUTION**  
- TO REDUCE THE RISK OF FIRE AND ELECTRIC SHOCK, DO NOT EXPOSE THIS PRODUCT TO RAIN OR MOISTURE.

Read these instructions.  
Keep these instructions.  
Heed all warnings.  
Follow all instructions.



- Do not use this apparatus near water.



- Clean only with a dry cloth.



- Do not block any ventilation openings. Install in accordance with the manufacturer's instructions.



- Do not install near any heat sources such as radiators, heat registers, stoves, or other apparatus (including amplifiers) that produce heat.



- Do not defeat the safety purpose of the polarized or grounding-type plug. A polarized plug has two blades with one wider than the other. A grounding type plug has two blades and a third grounding prong. The wide blade or the third prong are provided for your safety. If the provided plug does not fit into your outlet, consult an electrician for replacement of the obsolete outlet (Can differ by country).



- Protect the power cord from being walked on or pinched particularly at plugs, convenience receptacles, and the point where they exit from the apparatus.



- Only use attachments/accessories specified by the manufacturer.



- Use only with a cart, stand, tripod, bracket, or table specified by the manufacturer, or sold with the apparatus. When a cart is used, use caution when moving the cart/apparatus combination to avoid injury from tip-over.



- Unplug this apparatus during lightning storms or when unused for long periods of time.

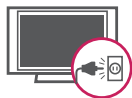

- Refer all servicing to qualified service personnel. Servicing is required when the apparatus has been damaged in any way, such as power-supply cord or plug is damaged, liquid has been spilled or objects have fallen into the apparatus, the apparatus has been exposed to rain or moisture, does not operate normally, or has been dropped.



- Do not stick metal objects or any other conductive material into the power cord. Do not touch the end of the power cord while it is plugged in.



- Keep the packing anti-moisture material or vinyl packing out of the reach of children. Anti-moisture material is harmful if swallowed. If swallowed by mistake, force the patient to vomit and visit the nearest hospital. Additionally, vinyl packing can cause suffocation. Keep it out of the reach of children.

- CAUTION concerning the Power Cord (Can differ by country):

It is recommended that appliances be placed upon a dedicated circuit; that is, a single outlet circuit which powers only that appliance and has no additional outlets or branch circuits. Check the specification page of this owner's manual to be certain. Do not connect too many appliances to the same AC power outlet as this could result in fire or electric shock. Do not overload wall outlets. Overloaded wall outlets, loose or damaged wall outlets, extension cords, frayed power cords, or damaged or cracked wire insulation are dangerous. Any of these conditions could result in electric shock or fire. Periodically examine the cord of your appliance, and if its appearance indicates damage or deterioration, unplug it, discontinue use of the appliance, and have the cord replaced with an exact replacement part by an authorized service. Protect the power cord from physical or mechanical abuse, such as being twisted, kinked, pinched, closed in a door, or walked upon. Pay particular attention to plugs, wall outlets, and the point where the cord exits the appliance. Do not move the TV with the power cord plugged in. Do not use a damaged or loose power cord. Be sure do grasp the plug when unplugging the power cord. Do not pull on the power cord to unplug the TV.



- **Warning** - To reduce the risk of fire or electrical shock, do not expose this product to rain, moisture or other liquids. Do not touch the TV with wet hands. Do not install this product near flammable objects such as gasoline or candles, or expose the TV to direct air conditioning.



- Do not expose to dripping or splashing and do not place objects filled with liquids, such as vases, cups, etc. on or over the apparatus (e.g. on shelves above the unit).



- **Grounding**  
(Except for devices which are not grounded.) Ensure that you connect the earth ground wire to prevent possible electric shock (i.e. a TV with a three-prong grounded AC plug must be connected to a three-prong grounded AC outlet). If grounding methods are not possible, have a qualified electrician install a separate circuit breaker. Do not try to ground the unit by connecting it to telephone wires, lightning rods, or gas pipes.

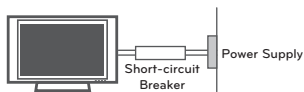

- **DISCONNECTING DEVICE FROM THE MAIN POWER**  
Mains plug is the disconnecting device. The plug must remain readily operable.

- As long as this unit is connected to the AC wall outlet, it is not disconnected from the AC power source even if the unit is turned off.
- Do not attempt to modify this product in any way without written authorization from LG Electronics. Unauthorized modification could void the user's authority to operate this product.
- **ANTENNAS Outdoor antenna grounding**  
(Can differ by country):

If an outdoor antenna is installed, follow the precautions below. An outdoor antenna system should not be located in the vicinity of overhead power lines or other electric light or power circuits, or where it can come in contact with such power lines or circuits as death or serious injury can occur. Be sure the antenna system is grounded so as to provide some protection against voltage surges and built-up static charges. Section 810 of the National Electrical Code (NEC) in the U.S.A. provides information with respect to proper grounding of the mast and supporting structure, grounding of the lead-in wire to an antenna discharge unit, size of grounding conductors, location of antenna discharge unit, connection to grounding electrodes and requirements for the grounding electrode.

**Antenna grounding according to the National Electrical Code, ANSI/NFPA 70**

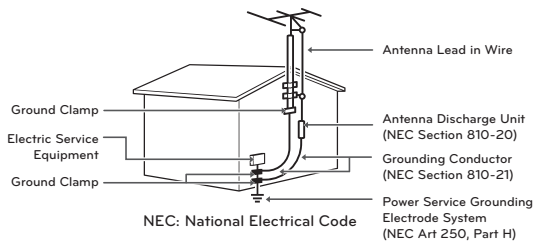

- **Cleaning**

When cleaning, unplug the power cord and wipe gently with a soft cloth to prevent scratching. Do not spray water or other liquids directly on the TV as electric shock may occur. Do not clean with chemicals such as alcohol, thinners or benzene.

- **Moving**

Make sure the product is turned off, unplugged and all cables have been removed. It may take 2 or more people to carry larger TVs. Do not press or put stress on the front panel of the TV.

- **Ventilation**

Install your TV where there is proper ventilation. Do not install in a confined space such as a bookcase. Do not cover the product with cloth or other materials while plugged. Do not install in excessively dusty places.

- If you smell smoke or other odors coming from the TV, unplug the power cord and contact an authorized service center.
- Do not press strongly upon the panel with a hand or a sharp object such as a nail, pencil or pen, or make a scratch on it.
- Keep the product away from direct sunlight.



- Never touch this apparatus or antenna during a thunder or lightning storm.
- When mounting a TV on the wall, make sure not to install the TV by hanging the power and signal cables on the back of the TV.
- Do not allow an impact shock or any objects to fall into the product, and do not drop anything onto the screen.

- **Dot Defect**

The Plasma or LCD panel is a high technology product with resolution of two million to six million pixels. In a very few cases, you could see fine dots on the screen while you're viewing the TV. Those dots are deactivated pixels and do not affect the performance and reliability of the TV.

- **Generated Sound**

"Cracking" noise: A cracking noise that occurs when watching or turning off the TV is generated by plastic thermal contraction due to temperature and humidity. This noise is common for products where thermal deformation is required.

Electrical circuit humming/panel buzzing: A low level noise is generated from a high-speed switching circuit, which supplies a large amount of current to operate a product. It varies depending on the product.

This generated sound does not affect the performance and reliability of the product.

- Take care not to touch the ventilation openings. When watching the TV for a long period, the ventilation openings may become hot. This does not affect the performance of the product or cause defects in the product.
- If the TV feels cold to the touch, there may be a small "flicker" when it is turned on. This is normal, there is nothing wrong with TV. Some minute dot defects may be visible on the screen, appearing as tiny red, green, or blue spots. However, they have no adverse effect on the TV's performance. Avoid touching the LCD screen or holding your finger(s) against it for long periods of time. Doing so may produce some temporary distortion effects on the screen.

**DISPOSAL (Hg lamp only used in LCD TVs)**

The fluorescent lamp used in this product contains a small amount of mercury. Do not dispose of this product with general household waste. Disposal of this product must be carried out in accordance to the regulations of your local authority.

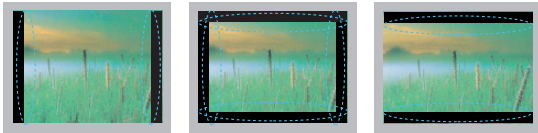
**Preventing "Image burn" or "Burn-in" on your TV screen**

- If a fixed image displays on the TV screen for a long period of time, it will be imprinted and become a permanent disfigurement on the screen. This is "image burn" or "burn-in" and not covered by the warranty.
- If the aspect ratio of the TV is set to 4:3 for a long period of time, image burn may occur on the letterboxed area of the screen.
- Avoid displaying a fixed image on the TV screen for a long period of time (2 or more hours for LCD, 1 or more hours for the Plasma TV) to prevent image burn.

**For USA and Canada****NOTE TO CABLE/TV INSTALLER**

This reminder is provided to call the CATV system installer's attention to Article 820-40 of the National Electric Code (U.S.A.). The code provides guidelines for proper grounding and, in particular, specifies that the cable ground shall be connected to the grounding system of the building, as close to the point of the cable entry as practical.

## Viewing 3D Imaging

### WARNING

#### Viewing Environment

- Viewing Time
  - When watching 3D contents, take 5 - 15 minute breaks every hour. Viewing 3D contents for a long period of time may cause headache, dizziness, fatigue or eye strain.

#### Those that have a photosensitive seizure or chronic illness

- Some users may experience a seizure or other abnormal symptoms when they are exposed to a flashing light or particular pattern from 3D contents.
- Do not watch 3D videos if you feel nausea, are pregnant and/ or have a chronic illness such as epilepsy, cardiac disorder, or blood pressure disease, etc.
- 3D Contents are not recommended to those who suffer from stereo blindness or stereo anomaly. Double images or discomfort in viewing may be experienced.
- If you have strabismus (cross-eyed), amblyopia (weak eyesight) or astigmatism, you may have trouble sensing depth and easily feel fatigue due to double images. It is advised to take frequent breaks than the average adult.
- If your eyesight varies between your right and left eye, revise your eyesight prior to watching 3D contents.

#### Symptoms which require discontinuation or refraining from watching 3D contents

- Do not watch 3D contents when you feel fatigue from lack of sleep, overwork or drinking.
- When these symptoms are experienced, stop using/watching 3D contents and get enough rest until the symptom subsides.
  - Consult your doctor when the symptoms persist. Symptoms may include headache, eyeball pain, dizziness, nausea, palpitation, blurriness, discomfort, double image, visual inconvenience or fatigue.

 **CAUTION****Viewing Environment**

- Viewing Distance
  - Maintain a distance of at least twice the screen diagonal length when watching 3D contents. If you feel discomfort in viewing 3D contents, move further away from the TV.

**Viewing Age**

- Infants / Children
  - Usage/ Viewing 3D contents for children under the age of 5 are prohibited.
  - Children under the age of 10 may overreact and become overly excited because their vision is in development (for example: trying to touch the screen or trying to jump into it. Special monitoring and extra attention is required for children watching 3D contents.
  - Children have greater binocular disparity of 3D presentations than adults because the distance between the eyes is shorter than one of adults. Therefore they will perceive more stereoscopic depth compared to adults for the same 3D image.
- Teenagers
  - Teenagers under the age of 19 may be stimulated to light coming from 3D videos. Advise them not to watch 3D videos for a long time when they are tired.
- Elderly
  - The elderly may perceive less of a 3D effect than the youth. Do not sit closer to the TV than the recommended distance.

**Cautions when using the 3D glasses**

- Make sure to use LG 3D glasses. Otherwise, you may not be able to view 3D videos properly.
- Do not use 3D glasses instead of your normal glasses, sunglasses or protective goggles.
- Using modified 3D glasses may cause eye strain or image distortion.
- Do not keep your 3D glasses in extremely high or low temperatures. It will cause deformation.
- The 3D glasses are fragile and are easy to be scratched. Always use a soft, clean piece of cloth when wiping the lenses. Do not scratch the lenses of the 3D glasses with sharp objects or clean/wipe them with chemicals.

# TABLE OF CONTENTS

## 2 LICENSES

---

## 2 OPEN SOURCE SOFTWARE NOTICE

---

## 3 IMPORTANT SAFETY INSTRUCTIONS

---

8 Viewing 3D Imaging

## 10 TABLE OF CONTENTS

---

## 11 INSTALLATION PROCEDURE

---

### 11 ASSEMBLING AND PREPARING

---

- 11 Unpacking
- 13 Optional Extras
- 14 Parts and buttons
- 16 Lifting and moving the TV
- 17 Setting up the TV
  - 17 - Attaching the stand
  - 18 - Mounting on a table
  - 19 - Tidying cables
  - 20 - Mounting on a wall

### 21 MAKING CONNECTIONS

---

- 21 Connecting to an antenna or cable
- 22 Connecting to a HD receiver, DVD, or VCR player
  - 22 - HDMI Connection
  - 23 - DVI to HDMI Connection
  - 24 - Component Connection
  - 25 - Composite Connection
- 26 Connecting to a PC
  - 26 - HDMI Connection, DVI to HDMI Connection or RGB Connection
- 28 Connecting to an Audio System
  - 28 - Digital Optical Audio Connection
- 29 Connecting to a USB

## 30 REMOTE CONTROL

---

- 30 Magic Remote Control Functions
  - 31 - Registering Magic Remote Control
  - 31 - How to use Magic Remote Control
  - 31 - Precautions to Take when Using the Magic Remote Control

## 32 WATCHING TV

---

- 32 Turning the TV on for the first time

## 33 USING THE USER GUIDE

---

## 34 SPECIFICATIONS

---

## 40 MAINTENANCE

---

- 40 Cleaning Your TV
  - 40 - Screen, frame, cabinet and stand
  - 40 - Power cord

## 40 TROUBLESHOOTING

---



### NOTE

- Image shown may differ from your TV.
- Your TV's OSD (On Screen Display) may differ slightly from that shown in this manual.
- The available menus and options may differ from the input source or product model that you are using.
- New features may be added to this TV in the future.

## INSTALLATION PROCEDURE

- 1 Open the package and make sure all the accessories are included.
- 2 Attach the stand to the TV set.
- 3 Connect an external device to the TV set.
- 4 Make sure the network connection is available.  
You can use the TV network functions only when the network connection is made.

## ASSEMBLING AND PREPARING

### Unpacking

Check your product box for the following items. If there are any missing accessories, contact the local dealer where you purchased your product. The illustrations in this manual may differ from the actual product and item.



#### CAUTION

- Do not use any unapproved items to ensure the safety and product life span.
- Any damages or injuries by using unapproved items are not covered by the warranty.
- In case of some model, the thin film on screen is a part of TV, So don't take it off.



#### NOTE

- The items supplied with your product may vary depending on the model.
- Product specifications or contents of this manual may be changed without prior notice due to upgrade of product functions.
- For an optimal connection, HDMI cables and USB devices should have bezels less than 10 mm (0.39 inches) thick and 18 mm (0.7 inches) width.
- Use an extension cable that supports USB 2.0 if the USB cable or USB memory stick does not fit into your TV's USB port.

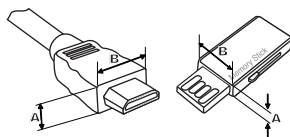

\*A ≤ 10 mm (0.39 inches)

\*B ≤ 18 mm (0.7 inches)

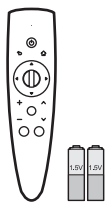

**Magic Remote Control, Batteries (AA)**  
(See p.30)

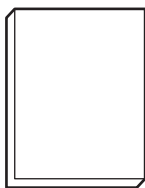

**Owner's manual**

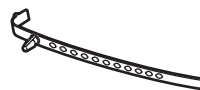

**Cable holder**  
(Depending on model)  
(See p.19)



**Stand Screws**  
8 EA, M4 x 20  
(See p.17)

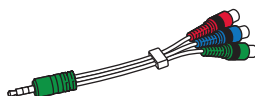

**Component video cable**  
(See p.24)

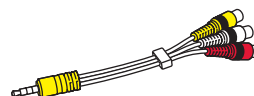

**Composite video cable**  
(See p.24, 25)



**Cinema 3D Glasses**  
The number of 3D glasses may differ depending on the model or country.

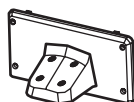

**Stand Body**  
(See p.17)

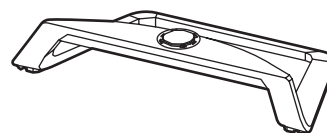

**Stand Base**  
(See p.17)



**Polishing cloth**  
(Depending on model)  
Use this to remove dust from the cabinet.

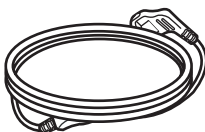

**Power Cord**  
(Depending on model)



**Wall mount inner spacers**  
4 EA  
(Depending on model)  
(See p.20)



**Desk-mount Screw**  
2 EA  
(Depending on model)  
(See p.18)



**Bracket Screw**  
M4 x 8, 2 EA  
(Depending on model)  
(See p.18)



**Desk-mount Cable**  
2 EA  
(Depending on model)  
(See p.18)



## Optional Extras

Optional extras can be changed or modified for quality improvement without any notification. Contact your dealer for buying these items. These devices only work with certain models.



**AN-MR300**

Magic remote control



**AG-F2\*\*, AG-F3\*\***

Cinema 3D glasses

The model name or design may be changed manufacturer's circumstances or policies.

## Parts and buttons

For LM6400/6450/6700/7600 series

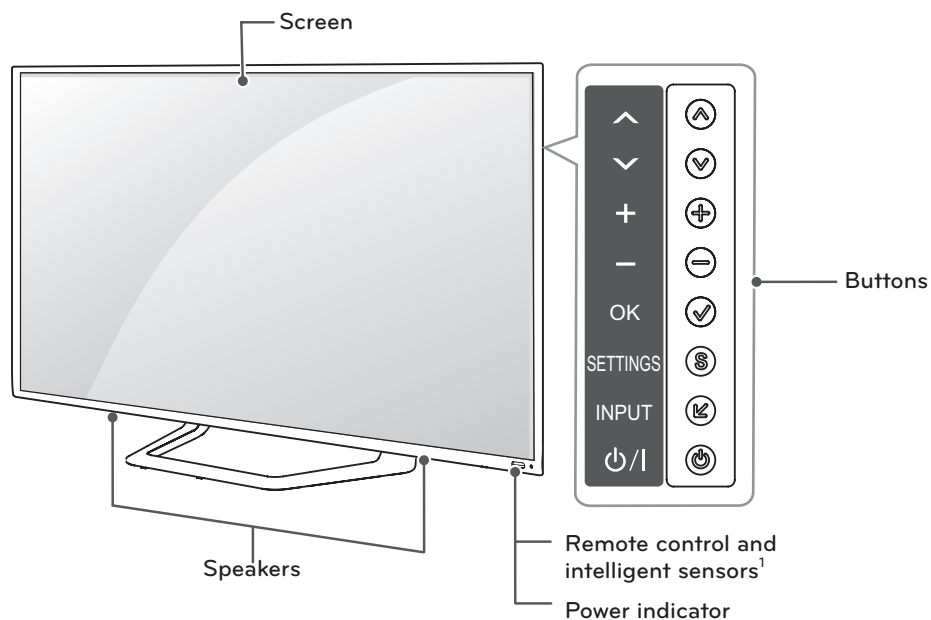

ENGLISH

Button	Description
^ v	Scrolls through the saved channels.
+ -	Adjusts the volume level.
✓ OK	Selects the highlighted menu option or confirms an input.
S SETTINGS	Accesses the main menu, or saves your input and exits the menus.
↙ INPUT	Changes the input source.
⏻ (⏻ / I)	Turns the power on or off.

1 Intelligent sensor - Adjusts the image quality and brightness based on the surrounding environment.

For LM6200/6210/6250 series

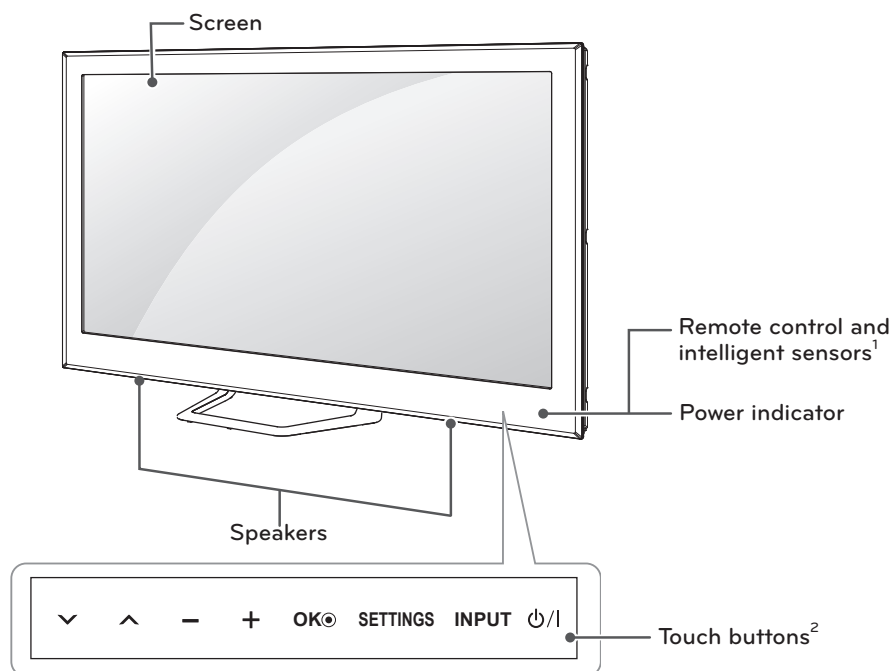

ENGLISH

Touch Button	Description
∨ ^	Scrolls through the saved channels.
- +	Adjusts the volume level.
OKⓄ	Selects the highlighted menu option or confirms an input.
SETTINGS	Accesses the main menu, or saves your input and exits the menus.
INPUT	Changes the input source.
⏻/⏿	Turns the power on or off.

- 1 Intelligent sensor - Adjusts the image quality and brightness based on the surrounding environment.
- 2 All of the buttons are touch sensitive and can be operated through simple touch with your finger.

## Lifting and moving the TV

When moving or lifting the TV, read the following to prevent the TV from being scratched or damaged and for safe transportation regardless of its type and size.

### CAUTION

- Avoid touching the screen at all times, as this may result in damage to the screen.

- It is recommended to move the TV in the box or packing material that the TV originally came in.
- Before moving or lifting the TV, disconnect the power cord and all cables.
- When holding the TV, the screen should face away from you to avoid damage.



- Hold the top and bottom of the TV frame firmly. Make sure not to hold the transparent part, speaker, or speaker grill area.

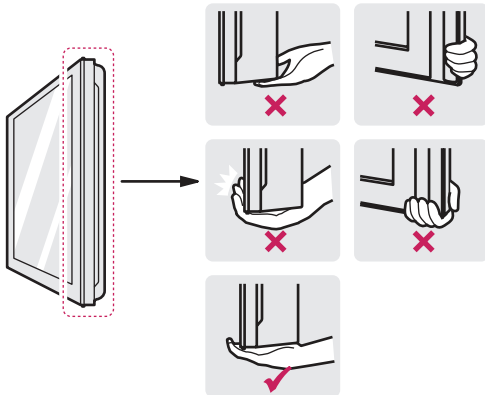

- When transporting a large TV, there should be at least 2 people.
- When transporting the TV by hand, hold the TV as shown in the following illustration.

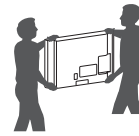

- When transporting the TV, do not expose the TV to jolts or excessive vibration.
- When transporting the TV, keep the TV upright, never turn the TV on its side or tilt towards the left or right.

## Setting up the TV

Put your TV on a pedestal stand and mount the TV on a table or wall.

### Attaching the stand

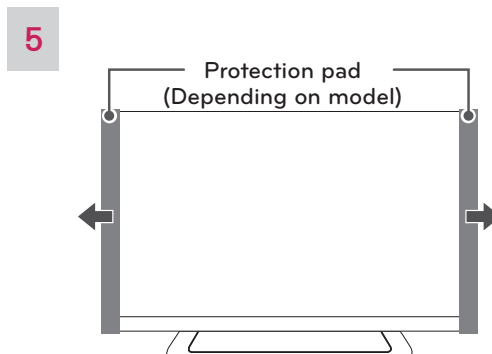
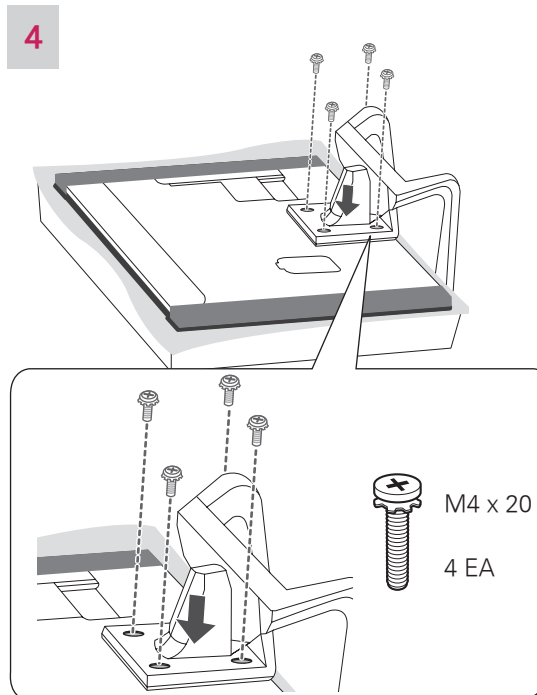
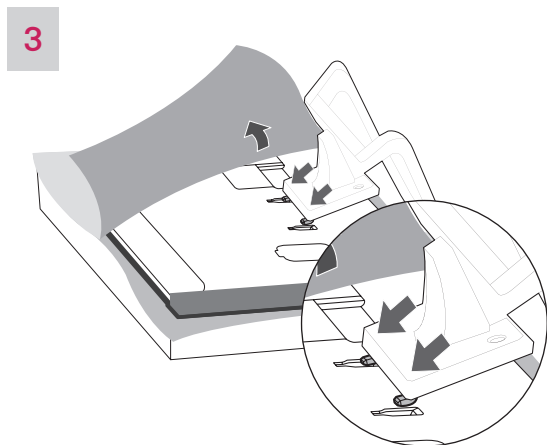
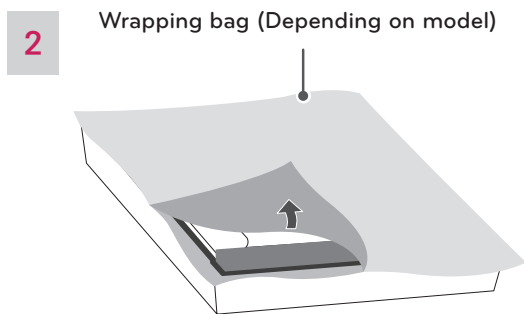
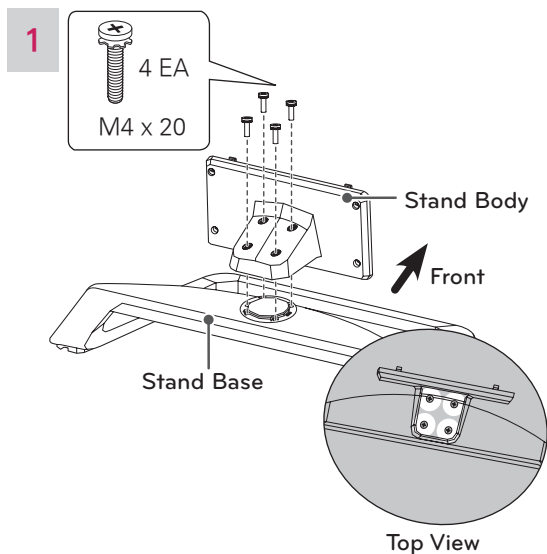

#### CAUTION

- When attaching the stand to the TV set, place the screen facing down on a cushioned table or flat surface to protect the screen from scratches.
- Tighten the screws firmly to prevent the TV from tilting forward.

## Mounting on a table

- Lift and tilt the TV into its upright position on a table.
  - Leave a 10 cm (4 inches) (minimum) space from the wall for proper ventilation.

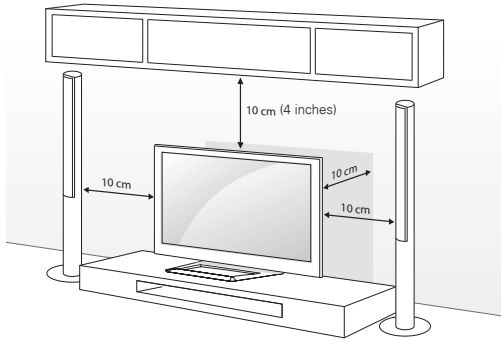

- Connect the power cord to a wall outlet.



### CAUTION

- Do not place the TV near or on sources of heat, as this may result in fire or other damage.

### Adjusting the angle of the TV to suit view

Swivel 10 degrees to the left or right and adjust the angle of the TV to suit your view.

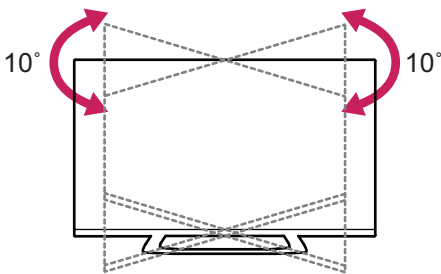

### NOTE

- When adjusting the angle of the TV, watch out for your fingers.
  - Personal injury may occur if hands or fingers are pinched. If the product is tilted too much, it may fall, causing damage or injury.

### Securing the TV to a table

(Depending on model)

Fix the TV to a table to prevent from tilting forward, damage, and potential injury.

- Connect the Desk-mount Cables to the Stand Base using the Bracket Screws.
- Fix the Desk-mount Cables to a table using the Desk-mount Screws.
- Once the TV is fixed, move the table close to the wall. Children may go in, causing injuries.

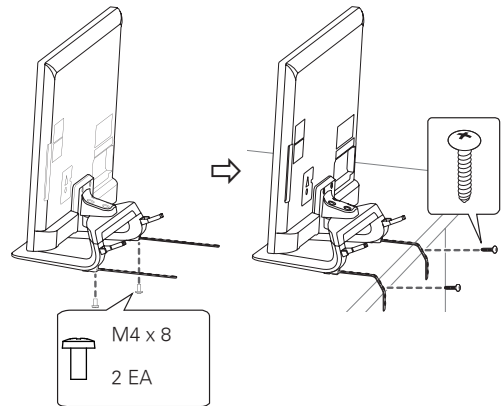

### WARNING

- To prevent TV from falling over, the TV should be securely attached to the floor/wall per installation instructions. Tipping, shaking, or rocking the TV may cause injury.

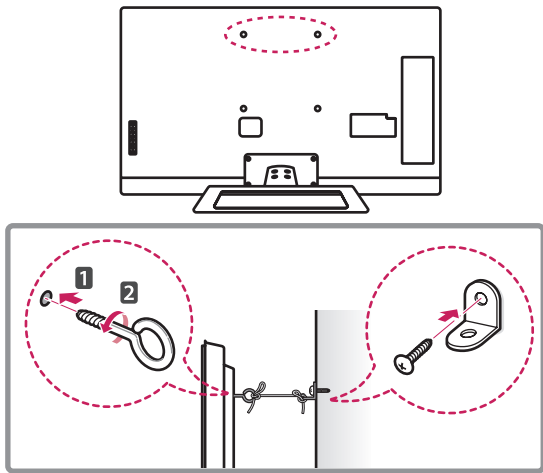
**Securing the TV to a wall (optional)**

- 1 Insert and tighten the eye-bolts, or TV brackets and bolts on the back of the TV.
  - If there are bolts inserted at the eye-bolts position, remove the bolts first.
- 2 Mount the wall brackets with the bolts to the wall.
 

Match the location of the wall bracket and the eye-bolts on the rear of the TV.
- 3 Connect the eye-bolts and wall brackets tightly with a sturdy rope.
 

Make sure to keep the rope horizontal with the flat surface.

 **CAUTION**

- Make sure that children do not climb on or hang on the TV.

 **NOTE**

- Use a platform or cabinet that is strong and large enough to support the TV securely.
- Brackets, bolts and ropes are optional. You can obtain additional accessories from your local dealer.

**Tidying cables**

- 1 Gather and bind the cables with the cable holder.

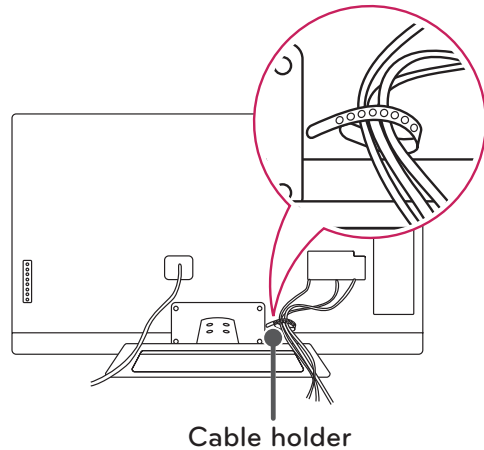

- 2 Fix the cable management clip firmly to the TV.

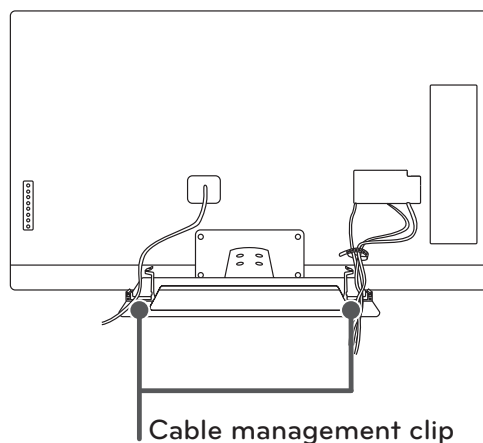
 **CAUTION**

- Do not move the TV by holding the cable holder and cable management holder, as the cable holders may break, and injuries and damage to the TV may occur.

## Mounting on a wall

Attach an optional wall mount bracket at the rear of the TV carefully and install the wall mount bracket on a solid wall perpendicular to the floor. When you attach the TV to other building materials, please contact qualified personnel. LG recommends that wall mounting be performed by a qualified professional installer.

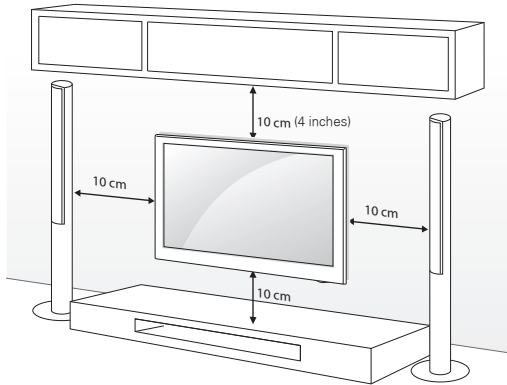

Make sure to use screws and wall mount bracket that meet the VESA standard. Standard dimensions for the wall mount kits are described in the following table.

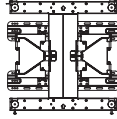
<b>Model</b>	32LM6200	42/47/55LM6200 47/55LM6250 47/55LM6400 60LM6450 42/47/55LM6700 47/55LM7600
<b>VESA</b>	200 x 200	400 x 400
<b>Standard screw</b>	M6	M6
<b>Number of screws</b>	4	4
<b>Wall mount bracket (optional)</b>	LSW200BX, LSW220BX 	LSW400BX, LSW420BX 



### CAUTION

- Disconnect the power first, and then move or install the TV. Otherwise electric shock may occur.
- If you install the TV on a ceiling or slanted wall, it may fall and result in severe injury. Use an authorized LG wall mount and contact the local dealer or qualified personnel.
- Do not over tighten the screws as this may cause damage to the TV and void your warranty.
- Use the screws and wall mounts that meet the VESA standard. Any damages or injuries by misuse or using an improper accessory are not covered by the warranty.



### NOTE

- Use the screws that are listed on the VESA standard screw specifications.
- The wall mount kit includes an installation manual and necessary parts.
- The wall mount bracket is optional. You can obtain additional accessories from your local dealer.
- The length of screws may differ depending on the wall mount. Make sure to use the proper length.
- For more information, refer to the manual supplied with the wall mount.
- When attaching a third-party wall mounting bracket to the TV, insert the wall mount inner spacers into the TV wall mount holes to move your TV in vertical angle. Please make sure not to use the spacers for LG wall mounting bracket.

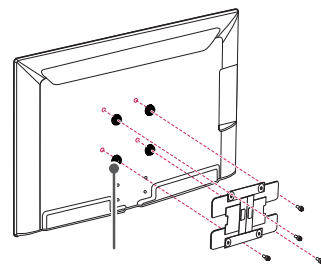

Wall Mount Inner Spacer



# MAKING CONNECTIONS

Connect various external devices to the TV and switch input modes to select an external device. For more information on external device's connection, refer to the manual provided with each device. Available external devices are: HD receivers, DVD players, VCRs, audio systems, USB storage devices, PC, gaming devices, and other external devices.

**! NOTE**

- If you record a TV program on a DVD recorder or VCR, make sure to connect the TV signal input cable to the TV through a DVD recorder or VCR. For more information on recording, refer to the manual provided with the connected device.
- The external device connection may differ from the model.
- Connect external devices to the TV regardless of the order of the TV port.
- If you connect a gaming device to the TV, use the cable supplied with the gaming device.
- Refer to the external equipment's manual for operating instructions.

## Connecting to an antenna or cable

Connect an antenna, cable, or cable box to watch TV while referring to the following. The illustrations may differ from the actual items and a RF cable is optional.

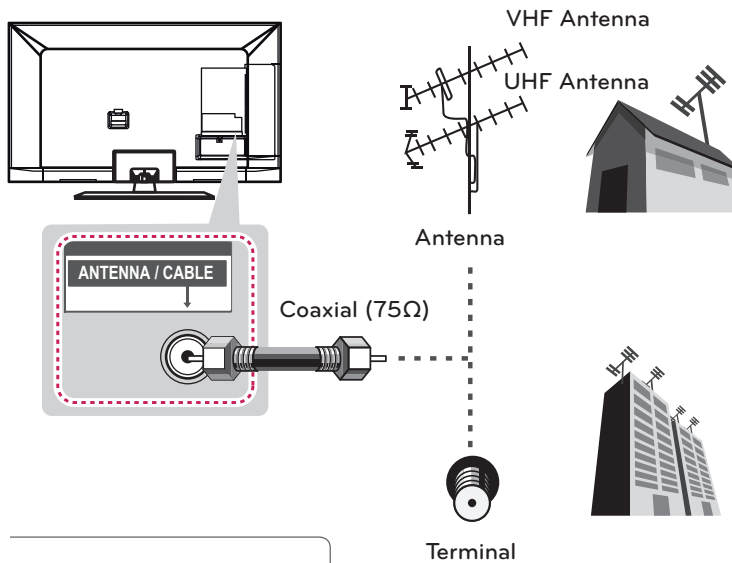

**! CAUTION**

- Make sure not to bend the copper wire of the RF cable.

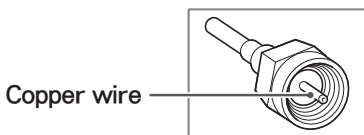

- Complete all connections between devices, and then connect the power cord to the power outlet to prevent damage to your TV.

**! NOTE**

- Use a signal splitter to use more than 2 TVs.
- Visit <http://lgknowledgebase.com> for more information about the antenna and cable connection. Search for antenna.

## Connecting to a HD receiver, DVD, or VCR player

Connect a HD receiver, DVD, or VCR player to the TV and select an appropriate input mode.

### HDMI Connection

**HDMI is the best way to connect a device.**

Transmits the digital video and audio signals from an external device to the TV. Connect the external device and the TV with the HDMI cable as shown in the following illustration.



#### NOTE

- Use the latest High Speed HDMI™ Cable with CEC (Customer Electronics Control) function.
- High Speed HDMI™ Cables are tested to carry an HD signal up to 1080p and higher.

Choose any HDMI input port to connect.  
It does not matter which port you use.

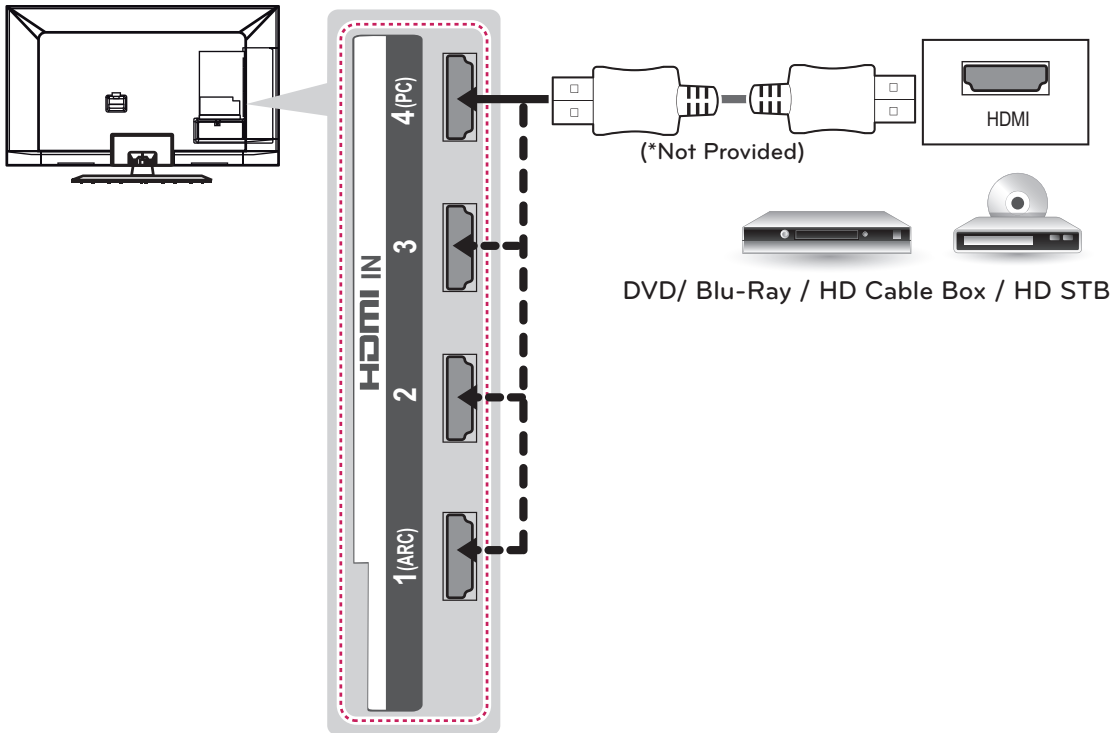

#### NOTE

- DTV Audio Supported Codec: MPEG, Dolby Digital
- HDMI Audio Supported Format: Dolby Digital, PCM (Up to 192 KHz, 32k/44.1k/48k/88k/96k/176k/192k) -> Not supported DTS.

#### ARC (Audio Return Channel)

- When connected with a high-speed HDMI cable, digital audio can be sent to a compatible device without an additional optical audio cable.
- ARC is only supported on the HDMI input 1 (ARC) port. An external audio device that supports ARC should be connected to HDMI 1 if you wish to use ARC.

## DVI to HDMI Connection

Transmits the digital video signal from an external device to the TV. Connect the external device and the TV with the DVI-HDMI cable as shown in the following illustration. To transmit an audio signal, connect an audio cable.

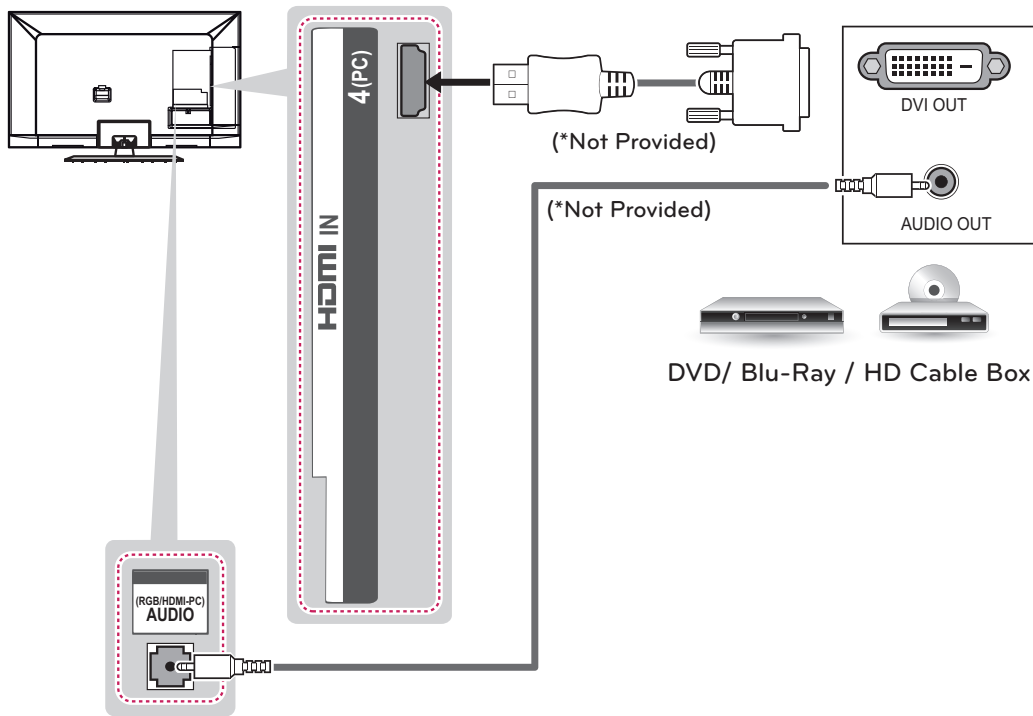

## Component Connection

Transmits analog video and audio signals from an external device to the TV. Connect the external device and the TV with a component cable as shown in the following illustration.



**NOTE**

- If cables are installed incorrectly, it could cause the image to display in black and white or with distorted color.
- Check to ensure each cable is matched with the corresponding color connection.

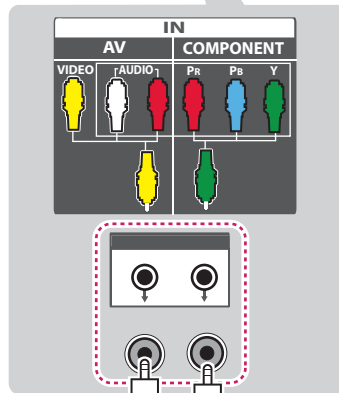
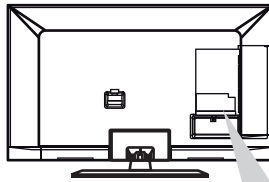

YELLOW

GREEN

(Use the composite video cable provided.)

(Use the component video cable provided.)

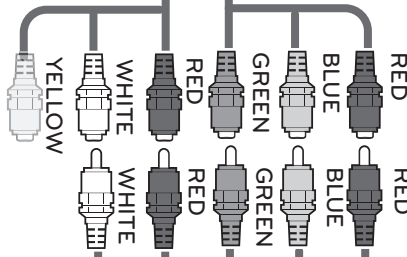

(\*Not Provided)

(\*Not Provided)

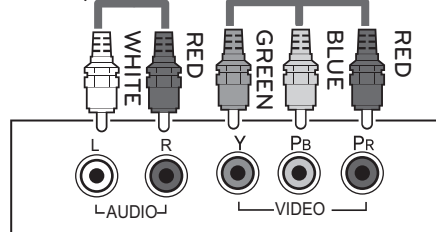

DVD/ Blu-Ray / HD Cable Box

## Composite Connection

Transmits analog video and audio signals from an external device to the TV. Connect the external device and the TV with the composite cable as shown in the following illustration.



**NOTE**

- Check to ensure each cable is matched with the corresponding color connection.

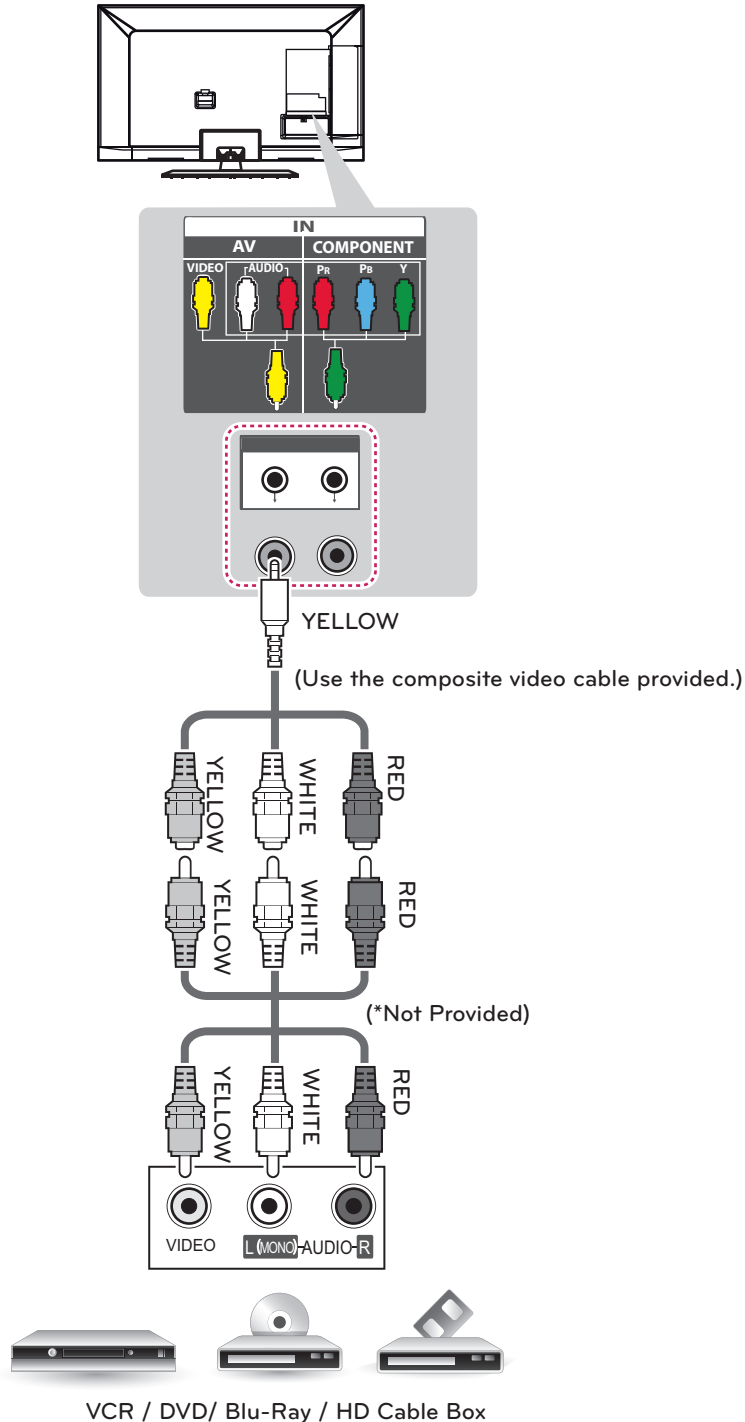

ENGLISH

## Connecting to a PC



### NOTE

- It is recommended to use the HDMI connection for the best image quality.
- Depending on the graphics card, DOS mode video may not work if a HDMI to DVI Cable is in use.
- In PC mode, there may be noise associated with the resolution, vertical pattern, contrast or brightness. If noise is present, change the PC output to another resolution, change the refresh rate to another rate or adjust the brightness and contrast on the PICTURE menu until the picture is clear.
- The synchronization input form for Horizontal and Vertical frequencies is separate.
- Depending on the graphics card, some resolution settings may not allow the image to be positioned on the screen properly.

## HDMI Connection, DVI to HDMI Connection or RGB Connection

Choose method A, B, or C to make connection.

### Method A: HDMI Connection

Choose any HDMI input port to connect.  
It is recommended to connect the DVI-HDMI  
to HDMI IN 4.

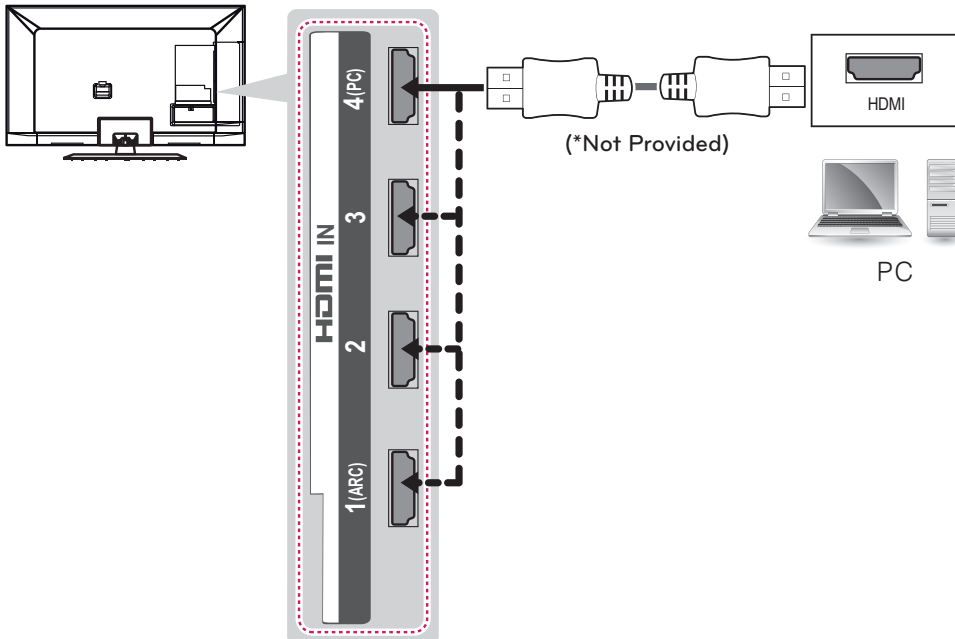

Method B: DVI to HDMI Connection

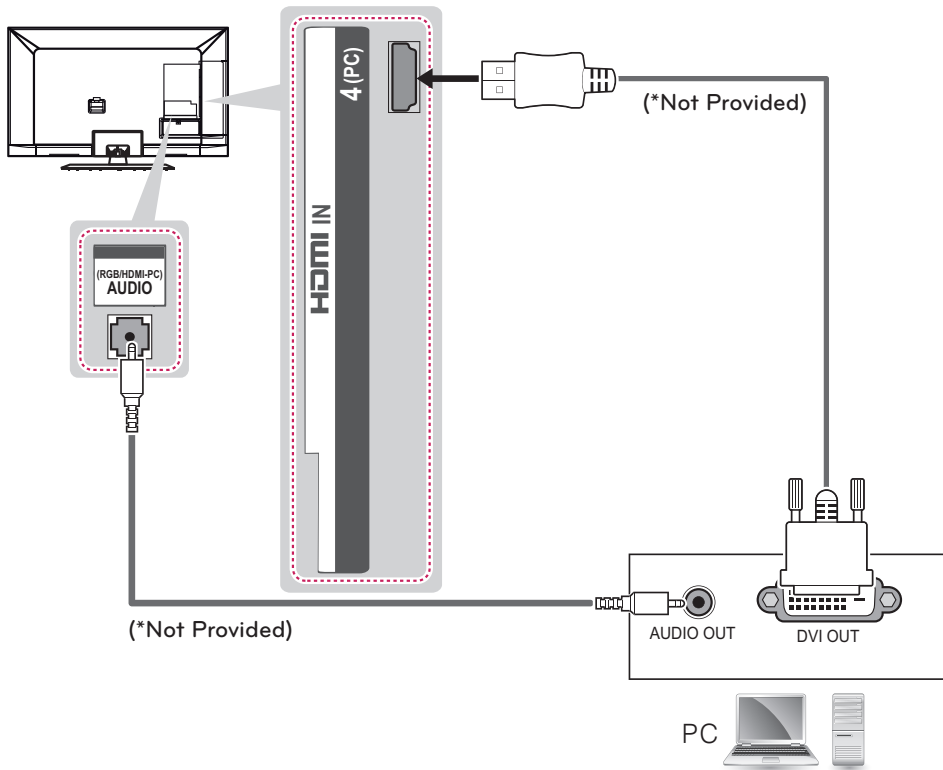

Method C: RGB Connection

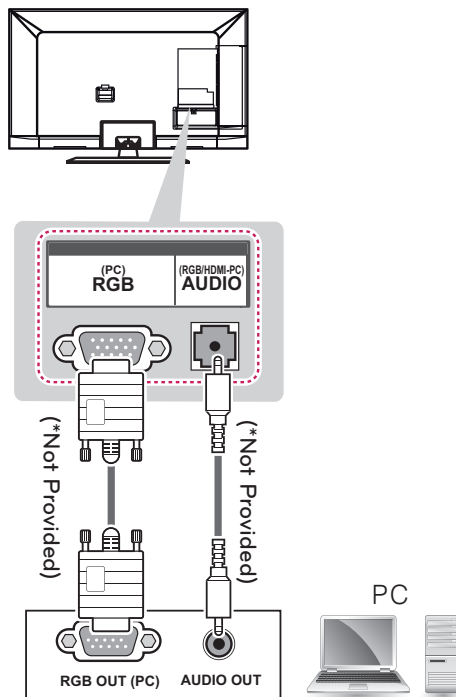

## Connecting to an Audio System

You may use an optional external audio system instead of the built-in speaker.



### NOTE

- If you use an optional external audio device instead of the built-in speaker, set the TV speaker feature to off.

## Digital Optical Audio Connection

Transmits a digital audio signal from the TV to an external device. Connect the external device and the TV with the optical audio cable as shown in the following illustration.



### NOTE

- Do not look into the optical output port. Looking at the laser beam may damage your vision.
- Audio with ACP (Audio Copy Protection) function may block digital audio output.

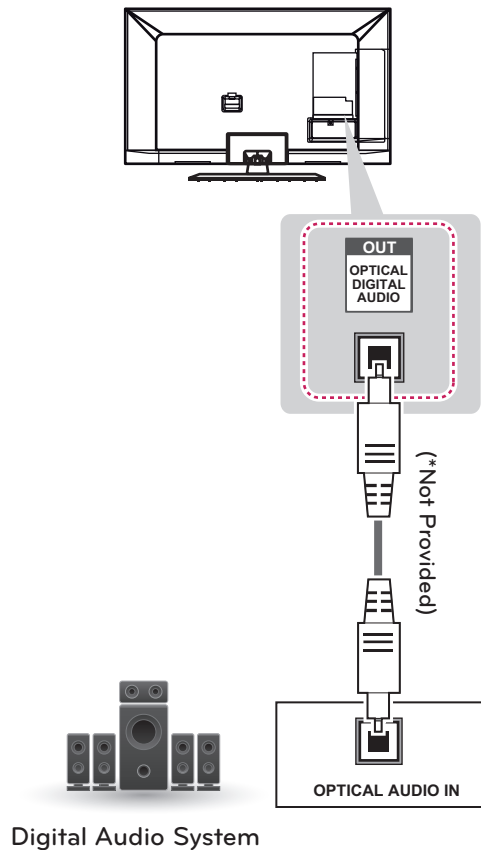



## Connecting to a USB

Connect a USB storage device such as a USB flash memory, external hard drive, or a USB memory card reader to the TV and access the Smart Share menu to use various multimedia files.



### NOTE

- To store apps on a USB storage device, make sure that it is connected to the USB IN 3 USB Apps port.
- To use a USB Hub device, make sure that it is connected to the USB IN 2 USB Hub port.
- Some USB Hubs may not work. If a USB device connected using a USB Hub is not detected, connect it to the USB port on the TV directly.

Choose any USB input port to connect.  
It does not matter which port you use.

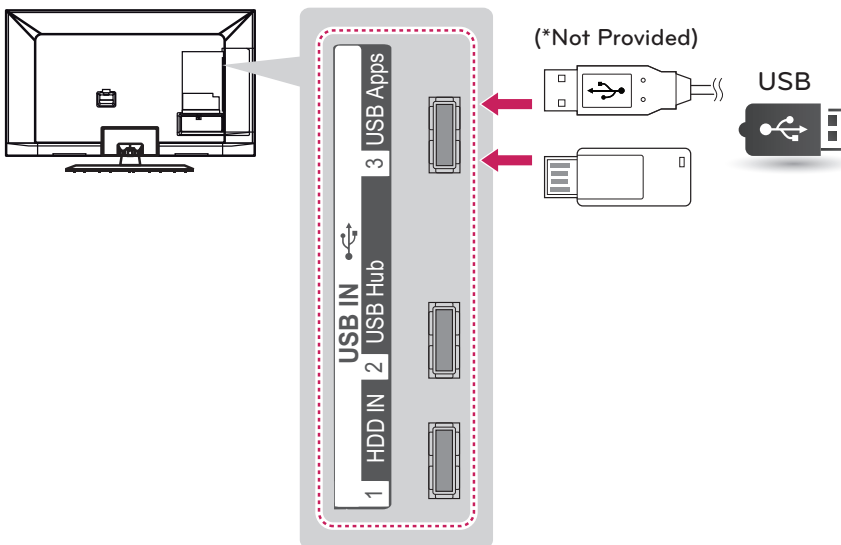

# REMOTE CONTROL

## Magic Remote Control Functions

When the message "Magic remote control battery is low. Change the battery." is displayed, replace the battery. To replace batteries, open the battery cover, replace batteries (1.5 V AA) matching ⊕ and ⊖ ends to the label inside the compartment, and close the battery cover. Be sure to point the remote control at the remote control sensor on the TV. To remove the batteries, perform the installation actions in reverse.

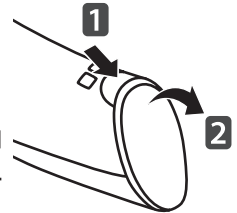

### CAUTION

- Do not mix old and new batteries, as this may damage the remote control.

Make sure to point the remote control at the remote control sensor on the TV.

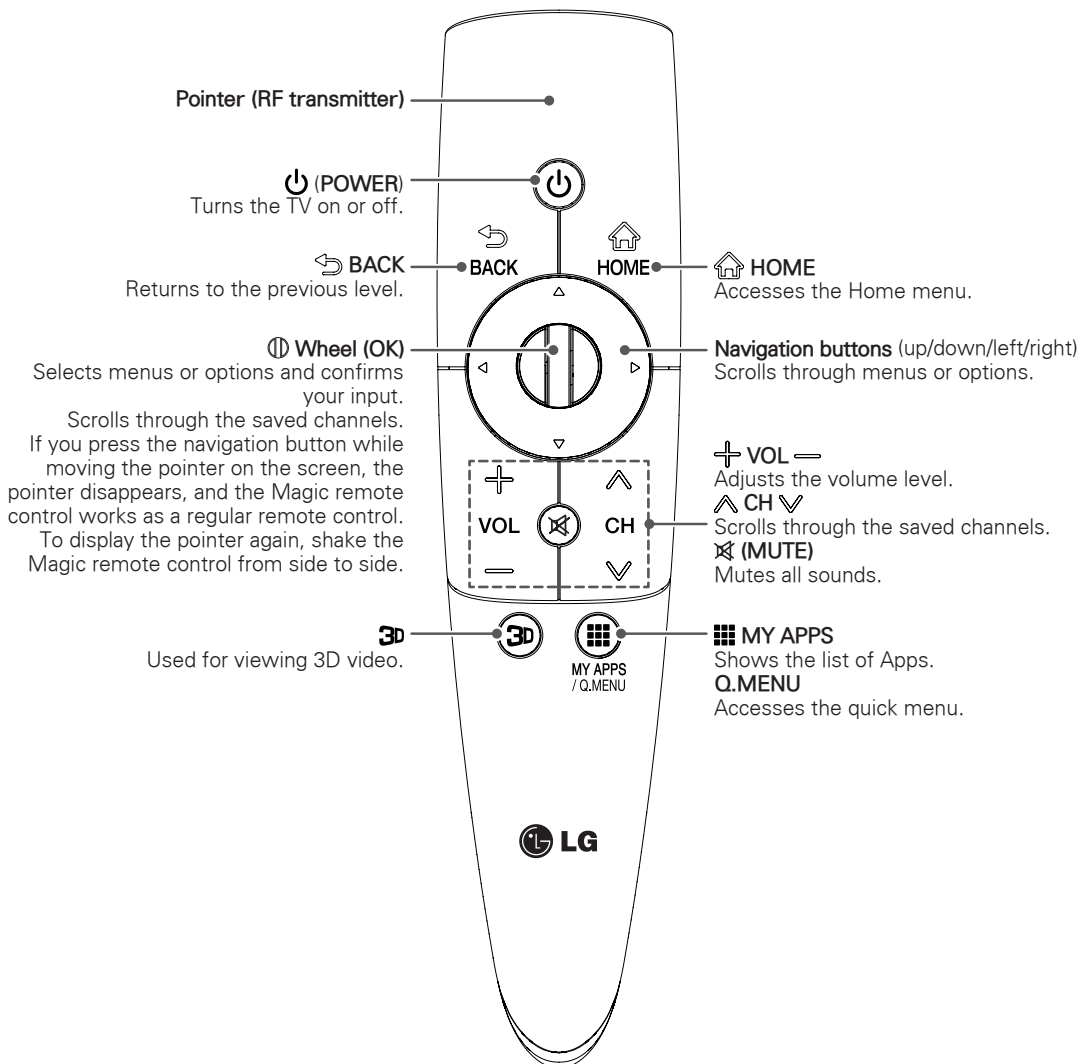



## Registering Magic Remote Control

The Magic Remote Control operates by pairing with your TV.  
Once you purchased the TV, please register the Magic remote control as follows;

### How to register the Magic Remote Control

 <b>(Wheel)</b>	<p>To register automatically, turn the TV on and press the <b>Wheel (OK)</b>. When registration is completed, the completion message appears on the screen. If registration fails, turn the TV off and back on, then press the <b>Wheel (OK)</b> to complete registration.</p>
---	--

### How to Re-register the Magic Remote Control

 <b>BACK</b>	<p>1 Press and hold the <b>BACK</b> and <b>HOME</b> buttons together for 5 seconds to reset, then register it by following "How to register the Magic remote control" above.</p>
 <b>HOME</b>	<p>2 To re-register the Magic remote control, press and hold the <b>BACK</b> button for 5 seconds toward the TV.</p>

## How to use Magic Remote Control

	<p>1 You can move the pointer by aiming the Pointer Receiver of the remote control at your TV then move it left, right, up or down. » If the pointer does not work properly leave the remote control for 10 seconds then use it again.</p> <p>2 If the pointer disappears, move the remote control slightly to left or right. Then, it will automatically appear on the screen. » If the pointer has not been used for a certain period of time, it will disappear.</p>
---	---

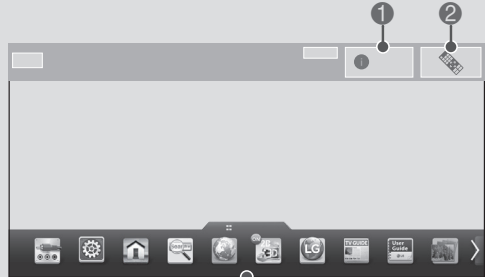

1	If you press <b>Wheel (OK)</b> on the Magic remote control, the screen appears. Shows information about the current program and screen.
2	Pressing this button will display number keypad which you can select channel number.
3	You can select My Apps Menu.

## Precautions to Take when Using the Magic Remote Control

- Use the Magic remote control within the maximum communication distance (10 m, 32.8ft). Using the remote control beyond this distance, or with an object obstructing it, may cause a communication failure.
- A communication failure may occur due to nearby devices. Electrical devices such as a microwave oven or wireless LAN product may cause interference, as these use the same bandwidth (2.4 GHz) as the Magic remote control.
- The Magic remote control may be damaged or may malfunction if it is dropped or receives a heavy impact.
- Take care not to bump into nearby furniture or other people when using the Magic remote control.
- Manufacturer and installer cannot provide service related to human safety as the applicable wireless device has possibility of electric wave interference.
- It is recommended that an Access Point (AP) be located more than 1 m (3.28 ft) away from the TV. If the AP is installed closer than 1 m (3.28 ft), the Magic remote control may not perform as expected due to frequency interference.

# WATCHING TV

## Turning the TV on for the first time

When you turn the TV on for the first time, the Initial setting screen appears. Select a language and customize the basic settings.

- 1 Connect the power cord to a power outlet.
- 2 In Standby mode, press the power button on the remote control to turn the TV on. The Initial setting screen appears if you turn the TV on for the first time.

### ! NOTE

- You can also access **Initial Setting** by accessing **OPTION** in the main menu.

- 3 Follow the on-screen instructions to customize your TV settings according to your preferences.

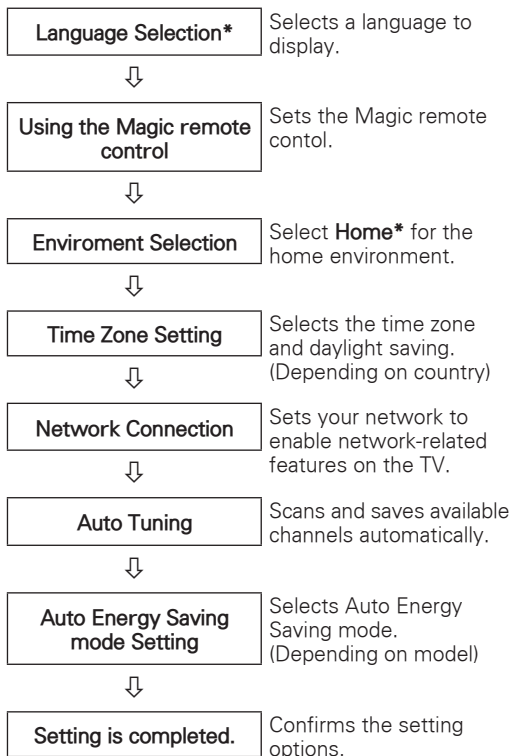

### ! NOTE

- Select **Home** when prompted. **Store** mode puts the TV in demo mode.
- If you select **Store**, the any customized settings will switch back to the default settings of **Store** in 5 minutes.

- 4 When the basic settings are complete, press **(Wheel)**.

### ! NOTE

- If you do not complete the Initial setting, it will appear whenever the TV turns on.
- Disconnect the power cord from the power outlet when you do not use the TV for a long period of time.

- 5 To turn the TV off, press the power button on the remote control.

# USING THE USER GUIDE

User Guide allows you to more easily access the detailed TV information.

- 1 Press **HOME** button to access the HOME menu.
- 2 Select **User Guide** and press the **Wheel (OK)**.

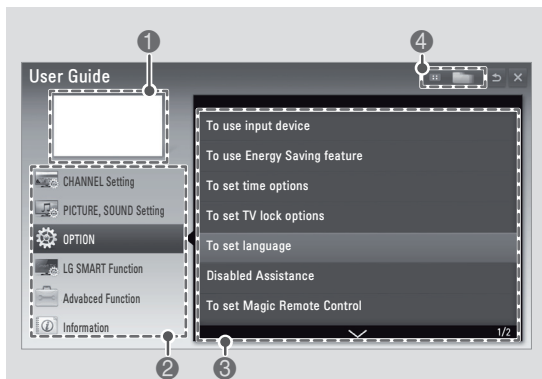
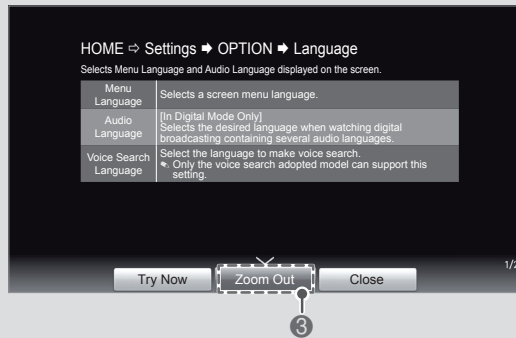
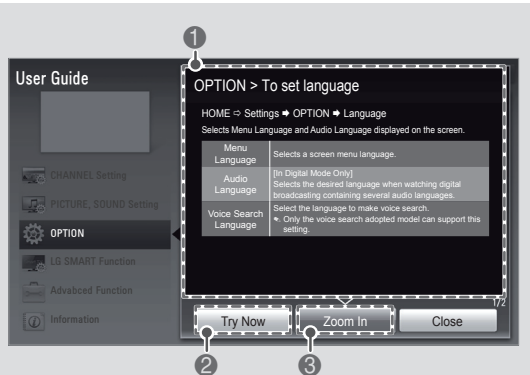

- |   |  |
|---|--|
| 1 | Shows the current channel.   |
| 2 | Allows to select the category you want.  |
| 3 | Allows to select the item you want. You can use <b>▲ / ▼</b> button to move between pages. |
| 4 | Allows to browse the description of the function you want from the index.                  |

- |   |   |
|---|---|
| 1 | Shows the description of the selected menu. You can use <b>▲ / ▼</b> to move between pages. |
| 2 | Moves to the selected menu directly from the User Guide.                                    |
| 3 | Zooms in or out the screen.   |

# SPECIFICATIONS

Product specifications may be changed without prior notice due to upgrade of product functions.

Power requirement	USA, Canada, Mexico: AC 120 V ~ 50 / 60 Hz Other Country: AC 100 - 240 V ~ 50 / 60 Hz	
Television System	NTSC-M, ATSC, 64 & 256 QAM	
Program Coverage	VHF 2-13, UHF 14-69, CATV 1-135, DTV 2-69, CADTV 1-135	
External Antenna Impedance	75 Ω	
Environment condition	Operating Temperature	0 - 40 °C
	Operating Humidity	Less than 80 %
	Storage Temperature	-20 - 60 °C
	Storage Humidity	Less than 85 %

MODELS		32LM6200 (32LM6200-UE)
Dimensions (Width x Height x Depth)	With stand	746.0 x 528.0 x 225.0 mm (29.3 x 20.7 x 8.8 inch)
	Without stand	746.0 x 462.0 x 35.5 mm (29.3 x 18.1 x 1.3 inch)
Weight	With stand	10.0 kg (22.0 lbs)
	Without stand	8.5 kg (18.7 lbs)
Current Value / Power consumption		0.8 A / 80 W

MODELS		42LM6200 (42LM6200-UE)	47LM6200 (47LM6200-UE)
		47LM6250 (47LM6250-UD)	
Dimensions (Width x Height x Depth)	With stand	979.0 x 670.0 x 263.0 mm (38.5 x 26.3 x 10.3 inch)	1089.0 x 730.0 x 263.0 mm (42.8 x 28.7 x 10.3 inch)
	Without stand	979.0 x 594.0 x 35.5 mm (38.5 x 23.3 x 1.3 inch)	1089.0 x 655.0 x 35.5 mm (42.8 x 25.7 x 1.3 inch)
Weight	With stand	15.3 kg (33.7 lbs)	17.8 kg (39.2 lbs)
	Without stand	13.1 kg (28.8 lbs)	15.6 kg (34.3 lbs)
Current Value / Power consumption		1.0 A / 100 W	1.2 A / 120 W

MODELS		55LM6200 (55LM6200-UE)
		55LM6250 (55LM6250-UD)
Dimensions (Width x Height x Depth)	With stand	1263.0 x 830.0 x 331.0 mm (49.7 x 32.6 x 13.0 inch)
	Without stand	1263.0 x 754.0 x 35.5 mm (49.7 x 29.6 x 1.3 inch)
Weight	With stand	25.3 kg (55.7 lbs)
	Without stand	21.9 kg (48.2 lbs)
Current Value / Power consumption		1.5 A / 150 W

MODELS		47LM6400 (47LM6400-UA)	55LM6400 (55LM6400-UA)
		Dimensions (Width x Height x Depth)	With stand
Without stand	1073.0 x 639.0 x 35.7 mm (42.2 x 25.1 x 1.4 inch)		1243.2 x 735.0 x 35.5 mm (48.9 x 28.9 x 1.3 inch)
Weight	With stand	16.9 kg (37.2 lbs)	24.7 kg (54.4 lbs)
	Without stand	14.7 kg (32.4 lbs)	21.0 kg (46.2 lbs)
Current Value / Power consumption		1.1 A / 110 W	1.2 A / 120 W

MODELS		60LM6450 (60LM6450-UA)
Dimensions (Width x Height x Depth)	With stand	1391.0 x 889.0 x 315.0 mm (54.7 x 35.0 x 12.4 inch)
	Without stand	1391.0 x 821.0 x 43.2 mm (54.7 x 32.3 x 1.7 inch)
Weight	With stand	32.0 kg (70.5 lbs)
	Without stand	28.2 kg (46.9 lbs)
Current Value / Power consumption		1.6 A / 160 W

MODELS		42LM6700 (42LM6700-UA)	47LM6700 (47LM6700-UA)
Dimensions (Width x Height x Depth)	With stand	953.0 x 636.0 x 263.0 mm (37.5 x 25.0 x 10.3 inch)	1063.0 x 701.0 x 263.0 mm (41.8 x 27.5 x 10.3 inch)
	Without stand	953.0 x 566.0 x 33.4 mm (37.5 x 22.2 x 1.3 inch)	1063.0 x 628.0 x 33.4 mm (41.8 x 24.7 x 1.3 inch)
Weight	With stand	14.8 kg (32.6 lbs)	17.5 kg (38.5 lbs)
	Without stand	12.6 kg (27.7 lbs)	15.3 kg (33.7 lbs)
Current Value / Power consumption		1.0 A / 100 W	1.1 A / 110 W

MODELS		55LM6700 (55LM6700-UA)
Dimensions (Width x Height x Depth)	With stand	1232.0 x 795.0 x 331.0 mm (48.5 x 31.2 x 13.0 inch)
	Without stand	1232.0 x 723.0 x 33.6 mm (48.5 x 28.4 x 1.3 inch)
Weight	With stand	25.0 kg (55.1 lbs)
	Without stand	21.3 kg (46.9 lbs)
Current Value / Power consumption		1.2 A / 120 W

MODELS		47LM7600 (47LM7600-UA)	55LM7600 (55LM7600-UA)
Dimensions (Width x Height x Depth)	With stand	1063.0 x 701.0 x 263.0 mm (41.8 x 27.5 x 10.3 inch)	1232.0 x 795.0 x 331.0 mm (48.5 x 31.2 x 13.0 inch)
	Without stand	1063.0 x 628.0 x 33.4 mm (41.8 x 24.7 x 1.3 inch)	1232.0 x 723.0 x 33.6 mm (48.5 x 28.4 x 1.3 inch)
Weight	With stand	17.5 kg (38.5 lbs)	25.0 kg (55.1 lbs)
	Without stand	15.3 kg (33.7 lbs)	21.3 kg (46.9 lbs)
Current Value / Power consumption		1.3 A / 130 W	1.6 A / 160 W



### 3D supported mode

- Video, which is input as below media contents is switched into the 3D screen automatically.
- The method for 3D digital broadcast may differ depending on the signal environment. If video is not switched automatically into 3D, manually convert the settings to view 3D images.

3D supported mode automatically				
Input	Signal	Horizontal Frequency (kHz)	Vertical Frequency (Hz)	Playable 3D video format
HDMI	640 X 480	31.469 / 31.5	59.94 / 60	Top & Bottom, Side by Side(Half), Side by Side(Full)
		62.938 / 63		Frame Packing, Line Alternative
	480p	31.469 / 31.5		Top & Bottom, Side by Side(Half), Side by Side(Full)
		62.938 / 63		Frame Packing, Line Alternative
	720p	44.96 / 45	59.94 / 60	Top & Bottom, Side by Side(Half), Side by Side(Full)
		89.91 / 90	59.94 / 60	Frame Packing, Line Alternative
	1080i	33.72 / 33.75	59.94 / 60	Top & Bottom, Side by Side(Half), Side by Side(Full)
		67.5	59.94 / 60	Frame Packing, Line Alternative
	1080p	26.97 / 27	23.97 / 24	Top & Bottom, Side by Side(Half), Side by Side(Full)
		28.125	25	
		33.72 / 33.75	29.976 / 30	
		43.94 / 54	23.97 / 24	Frame Packing, Line Alternative
		56.25	25	
		67.432 / 67.5	29.976 / 30	
	67.432 / 67.5	59.94 / 60	Top & Bottom, Side by Side(Half)	
USB	1080p	33.75	30	Side by Side(Half), Top & Bottom, Checker Board, MPO(Photo)
DLNA	1080p	33.75	30	Side by Side(Half), Top & Bottom, Checker Board
	Signal			Playable 3D video format
DTV	Frame Compatible			Side by Side(Half), Top & Bottom

- For models supporting WiDi, you can set the 3D mode in the same way as in RGB (PC) mode.

3D supported mode manually				
Input	Signal	Horizontal Frequency (kHz)	Vertical Frequency (Hz)	Playable 3D video format
HDMI-DTV	720p	45.00	60	2D to 3D, Side by Side(Half), Top & Bottom, Single Frame Sequential
	1080i	33.75	60	2D to 3D, Side by Side(Half), Top & Bottom
	1080p	27.00	24	2D to 3D, Side by Side(Half), Top & Bottom, Checker Board
		28.12	25	
		33.75	30	
67.50	60	2D to 3D, Side by Side(Half), Top & Bottom, Checker Board, Single Frame Sequential, Row Interleaving, Column Interleaving		
HDMI-PC	1024x768	48.36	60	2D to 3D, Side by Side(Half), Top & Bottom
	1360x768	47.71		2D to 3D, Side by Side(Half), Top & Bottom, Checker Board, Single Frame Sequential, Row Interleaving, Column Interleaving
	1920x1080	67.50		
	Others	-	-	2D to 3D
RGB-PC	1024x768	48.36	60	2D to 3D, Side by Side(Half), Top & Bottom
	1360x768	47.71		
	1920x1080	67.50		
	Others	-	-	2D to 3D
Component	720p	45.00	60	2D to 3D, Side by Side(Half), Top & Bottom
	1080i	33.75	60	
	1080p	27.00	24	
		28.12	25	
		33.75	30	
		67.50	60	
	Others	-	-	2D to 3D
USB	1080p	33.75	30	2D to 3D, Side by Side(Half), Top & Bottom, Checker Board, Row Interleaving, Column Interleaving(Photo : Side by Side(Half), Top & Bottom)
DLNA	1080p	33.75	30	
	Signal			Playable 3D video format
DTV	HD			2D to 3D, Side by Side(Half), Top & Bottom
	SD			2D to 3D

**HDMI/DVI-DTV supported mode**

Resolution	Horizontal Frequency (kHz)	Vertical Frequency (Hz)
720X480	31.469	59.94
	31.5	60
1280X720	44.96	59.94
	45	60
1920X1080	33.72	59.94
	33.75	60
	26.97	23.97
	27	24
	33.716	29.976
	33.75	30.00
	67.43	59.94
67.5	60	

**Component port connecting information**

Component ports on the TV	Y	P <sub>B</sub>	P <sub>R</sub>

Video output ports on DVD player	Y	P <sub>B</sub>	P <sub>R</sub>
	Y	B-Y	R-Y
	Y	Cb	Cr
	Y	Pb	Pr

Signal	Component
480i	O
480p	O
720p/1080i	O
1080p	O (60 Hz only)

**Wireless LAN module(TWFM-B003D) specification**

<b>Standard</b>	IEEE802.11a/b/g/n
<b>Frequency Range</b>	2400 to 2483.5 MHz 5150 to 5250 MHz 5725 to 5850 MHz
<b>Modulation</b>	CCK / OFDM / MIMO
<b>Output Power (Typical)</b>	802.11a: 15 dBm 802.11b: 14 dBm 802.11g: 17 dBm 802.11n - 2.4GHz: 17 dBm 802.11n - 5GHz: 15 dBm
<b>Data rate</b>	802.11a/g: 54 Mbps 802.11b: 11 Mbps 802.11n: 300 Mbps
<b>Antenna Gain (Typical)</b>	2400 to 2483.5 MHz: -2.5 dBi 5150 to 5250 MHz: -2.2 dBi 5725 to 5850 MHz: -2.9 dBi
<b>Occupied bandwidth</b>	802.11a/b/g: HT20 802.11n: HT20/40

Because band channel used by the country could be different, the user can not change or adjust the operating frequency and this product is set for the regional frequency table.

- FCC ID of Wi-Fi module inside TV  
FCC ID: BEJTWFM-B003D

**Bluetooth module (BM-LDS302) specification**

<b>Standard</b>	Bluetooth Version 3.0
<b>Frequency Range</b>	2400 ~ 2483.5 MHz
<b>Output Power (Max.)</b>	10 dBm or lower
<b>Data rate (Max.)</b>	3 Mbps
<b>Communication Distance</b>	Line of Open Sight approx. 10 m

- FCC ID of Bluetooth module inside TV  
FCC ID: BEJLDS302



# MAINTENANCE

## Cleaning Your TV

Clean your TV regularly to keep the best performance and to extend the product lifespan.



### CAUTION

- Make sure to turn the power off and disconnect the power cord and all other cables first.
- When the TV is left unattended or unused for a long time, disconnect the power cord from the wall outlet to prevent possible damage from lightning or power surges.

## Screen, frame, cabinet and stand

To remove dust or light dirt, wipe the surface with a dry, clean, and soft cloth.

To remove major dirt, wipe the surface with a soft cloth dampened in clean water or a diluted mild detergent. Then wipe immediately with a dry cloth.



### CAUTION

- Do not push, rub, or hit the surface with your fingernail or a sharp object, as this may result in scratches on the screen and image distortions.
- Do not use any chemicals, such as waxes, benzene, alcohol, thinners, insecticides, air fresheners, lubricants, as these may damage the screen's finish and cause discoloration.
- Do not spray liquid onto the surface. If water enters the TV, it may result in fire, electric shock, or malfunction.

## Power cord

Remove the accumulated dust or dirt on the power cord regularly.

# TROUBLESHOOTING

Problem	Solution
Cannot control the TV with the remote control.	<ul style="list-style-type: none"> <li>• Check the remote control sensor on the product and try again.</li> <li>• Check if there is any obstacle between the product and the remote control.</li> <li>• Check if the batteries are still working and properly installed (⊕ to ⊕, ⊖ to ⊖).</li> </ul>
No image display and no sound is produced.	<ul style="list-style-type: none"> <li>• Check if the product is turned on.</li> <li>• Check if the power cord is connected to a wall outlet.</li> <li>• Check if there is a problem in the wall outlet by connecting other products.</li> </ul>
The TV turns off suddenly.	<ul style="list-style-type: none"> <li>• Check the power control settings. The power supply may be interrupted.</li> <li>• Check if the Auto sleep feature is activated in the Time settings.</li> <li>• If there is no signal while the TV is on, the TV will turn off automatically after 15 minutes of inactivity.</li> </ul>





# CHILD SAFETY:

It Makes A Difference How and Where  
You Use Your Flat Panel Display

**Congratulations on your purchase! As you enjoy your new product, please keep these safety tips in mind:**



## THE ISSUE

- The home theater entertainment experience is a growing trend and larger flat panel displays are popular purchases. However, flat panel displays are not always supported on the proper stands or installed according to the manufacturer's recommendations.
- Flat panel displays that are inappropriately situated on dressers, bookcases, shelves, desks, speakers, chests or carts may fall over and cause injury.

## THIS MANUFACTURER CARES!

- The consumer electronics industry is committed to making home entertainment enjoyable and safe.

## TUNE INTO SAFETY

- One size does NOT fit all. Follow the manufacturer's recommendations for the safe installation and use of your flat panel display.
- Carefully read and understand all enclosed instructions for proper use of this product.
- Don't allow children to climb on or play with furniture and television sets.
- Don't allow place flat panel displays on furniture that can easily be used as steps, such as a chest of drawers.
- Remember that children can become excited while watching a program, especially on a "larger than life" flat panel display. Care should be taken to place or install the display where it cannot be pushed, pulled over, or knocked down.
- Care should be taken to route all cords and cables connected to the flat panel display so that they cannot be pulled or grabbed by curious children.

## WALL MOUNTING: IF YOU DECIDE TO WALL MOUNT YOUR FLAT PANEL DISPLAY, ALWAYS:

- Use a mount that has been recommended by the display manufacturer and/or listed by an independent laboratory (such as UL, CSA, ETL).
- Follow all instructions supplied by the display and wall mount manufacturers.
- If you have any doubts about your ability to safely install your flat panel display, contact your retailer about professional installation.
- Make sure that the wall where you are mounting the display is appropriate. Some wall mounts are not designed to be mounted to walls with steel studs or old cinder block construction. If you are unsure, contact a professional installer.
- A minimum of two people are required for installation. Flat panel displays can be heavy





### LG Customer Information Center

For inquires or comments, visit [www.lg.com](http://www.lg.com) or call;

**1-800-243-0000** USA, Consumer User

**1-888-865-3026** USA, Commercial User

**1-888-542-2623** CANADA

**Register your product Online!**

**[www.lg.com](http://www.lg.com)**

The model and serial number of the TV is located on the back and one side of the TV.

Record it below should you ever need service.

MODEL \_\_\_\_\_

SERIAL \_\_\_\_\_

(For LM6200/LM6400/LM6700/LM7600 series)



This product qualifies for ENERGY STAR in the "factory default (Home Use)" setting.

Changing the factory default settings or enabling other features may increase power consumption that could exceed the limits necessary to quality for ENERGY STAR.