

# **dji** AVATA

## User Manual

v1.2 2023.03

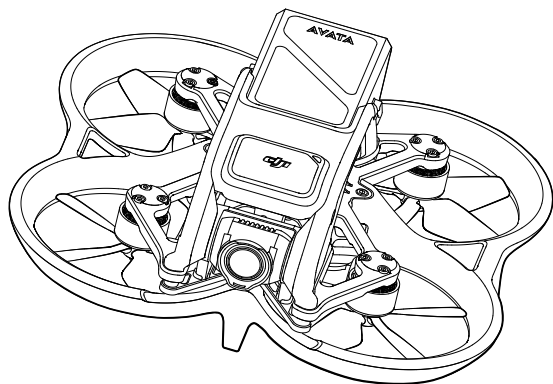

### **Searching for Keywords**

Search for keywords such as “battery” and “install” to find a topic. If you are using Adobe Acrobat Reader to read this document, press Ctrl+F on Windows or Command+F on Mac to begin a search.

### **Navigating to a Topic**

View a complete list of topics in the table of contents. Click on a topic to navigate to that section.

### **Printing this Document**

This document supports high resolution printing.

## Revision Log

Version	Date	Revisions
v1.2	2023.03	Added new supported devices for the aircraft and feature descriptions for the goggles.

# Using this Manual

## Legend

 Warning

 Important

 Hints and Tips

 Reference

## Read Before the First Flight

Read the following documents before using DJI AVATA™.

1. User Manual
2. Quick Start Guide
3. Safety Guidelines

It is recommended to watch all tutorial videos and read the safety guidelines before using for the first time. Prepare for your first flight by reviewing the quick start guide and refer to this user manual for more information.

## Video Tutorials

Visit the link below to watch the tutorial videos, which demonstrate how to use DJI Avata safely:



<https://s.dji.com/guide24>

## Download the DJI Fly App

Scan the QR code above to download DJI Fly.

The Android version of DJI Fly is compatible with Android v6.0 and later. The iOS version of DJI Fly is compatible with iOS v11.0 and later.

\* For increased safety, flight is restricted to a height of 98.4 ft (30 m) and a range of 164 ft (50 m) when not connected or logged into the app during flight. This applies to DJI Fly and all apps compatible with DJI aircraft.

## Download the DJI Virtual Flight App

Scan the QR code on the right to download DJI Virtual Flight.

The iOS version of DJI Virtual Flight is compatible with iOS v11.0 and later.



## Download DJI Assistant 2 (Consumer Drones Series)

Download DJI ASSISTANT™ 2 (Consumer Drones Series) at <https://www.dji.com/avata/downloads>.

 The operating temperature of this product is -10° to 40° C. It does not meet the standard operating temperature for military grade application (-55° to 125° C), which is required to endure greater environmental variability. Operate the product appropriately and only for applications that meet the operating temperature range requirements of that grade.

# Contents

<b>Using this Manual</b>	1
Legend	1
Read Before the First Flight	1
Video Tutorials	1
Download the DJI Fly App	1
Download the DJI Virtual Flight App	1
Download DJI Assistant 2 (Consumer Drones Series)	1
<b>Product Profile</b>	4
Introduction	4
Preparing the Aircraft	5
Preparing the Goggles	6
Preparing the Remote Control Devices	9
Diagram	11
Linking	17
Activation	18
<b>Aircraft</b>	19
Flight Modes	19
Aircraft Status Indicator	20
Return to Home	21
Vision System and Infrared Sensing System	23
Flight Recorder	25
Propellers	26
Intelligent Flight Battery	28
Gimbal and Camera	32
<b>Goggles</b>	34
DJI Goggles 2	34
DJI FPV Goggles V2	43
<b>Remote Control Devices</b>	48
DJI Motion Controller	48
DJI FPV Remote Controller 2	52
<b>DJI Fly App</b>	58

<b>Flight</b>	59
Flight Environment Requirements	59
Flight Restrictions	59
Pre-Flight Checklist	61
Starting/Stopping the Motors	61
Flight Test	63
<b>Maintenance</b>	64
Aircraft	64
Goggles	74
<b>Appendix</b>	77
Specifications	77
Firmware Update	83
Aftersales Information	83
FAR Remote ID Compliance Information	84

# Product Profile

## Introduction

DJI Avata features a compact and portable aircraft body, which is equipped with a propeller guard. With both a Vision System and an Infrared Sensing System, it can hover stably and fly flexibly indoors as well as outdoors, and automatically initiate Return to Home (RTH). With a gimbal and 1/1.7" sensor camera, the aircraft stably shoots 4K 60fps ultra-HD video and 4K photos. The aircraft has a maximum hover time of approximately 18 minutes.

DJI Avata uses DJI O3+ technology, when used with compatible goggles and remote control devices, it provides video transmission with a maximum range of 6 mi (10 km), and a bit rate of up to 50 Mbps, bringing an immersive flight experience.

The goggles are equipped with a high-performance display. By receiving the video signal from the aircraft, users can enjoy a first-person view of their aerial experience in real time. The remote control devices are equipped with a range of function buttons, which can be used to control the aircraft and operate the camera. DJI Goggles 2 and DJI Motion Controller can easily control the flight of the aircraft by tracking your head or hand movements, bringing a new and convenient flight control experience.

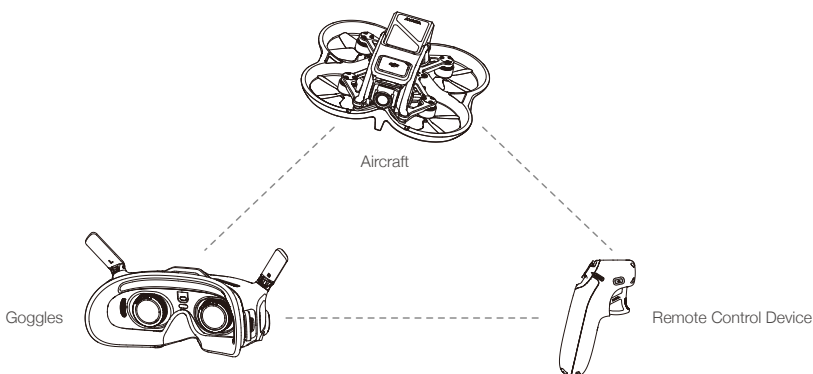

• Refer to the appendix for the goggles and remote control devices supported by DJI Avata. This manual only takes DJI Goggles 2, DJI FPV Goggles V2, DJI Motion Controller, and DJI FPV Remote Controller 2 as examples. Refer to the user manuals of other supported devices respectively for use.



- The remote control devices reach their maximum transmission distance (FCC) in a wide open area with no electromagnetic interference at an altitude of about 120 m (400 ft). The maximum transmission distance refers to the maximum distance that the aircraft can still send and receive transmissions. It does not refer to the maximum distance the aircraft can fly in a single flight.
- Maximum hover time was tested in an environment with no wind or interference.
- Using the goggles does not satisfy the requirement of visual line of sight (VLOS). Some countries or regions require a visual observer to assist during flight. Make sure to comply with local regulations when using the goggles.

## Preparing the Aircraft

1. Remove the gimbal protector from the camera.

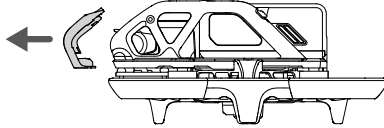

2. Remove the Intelligent Flight Battery and use a USB charger to charge the battery. It takes approximately 90 minutes to fully charge an Intelligent Flight Battery.

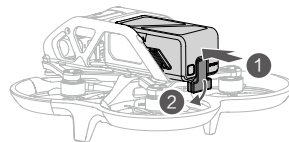
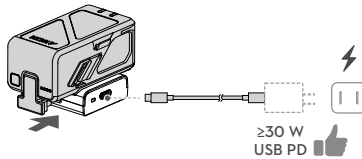
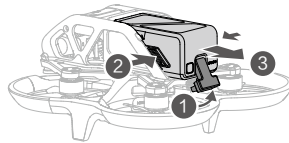

- It is recommended to use the DJI 30W USB-C Charger or other USB Power Delivery chargers.
- It is recommended to attach a gimbal protector to protect the gimbal when the aircraft is not in use. Adjust the camera to the horizontal position, then install the gimbal protector and make sure it is secure.



- Make sure to remove the gimbal protector before powering on the aircraft. Otherwise, it may affect the aircraft self-diagnostics.

## Preparing the Goggles

### DJI Goggles 2

1. Unfold the antennas.

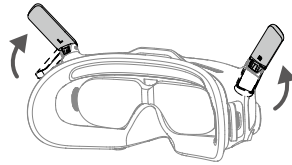

2. Remove the screen protector.

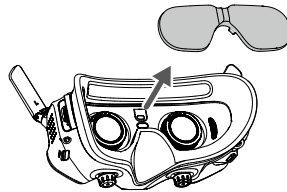

3. Attach the headband to the goggles.

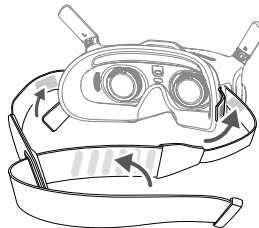

4. Use the power cable (USB-C) provided to connect the power port of the goggles to the goggles battery. Press the power button once, then press again and hold for two seconds to power the goggles on.

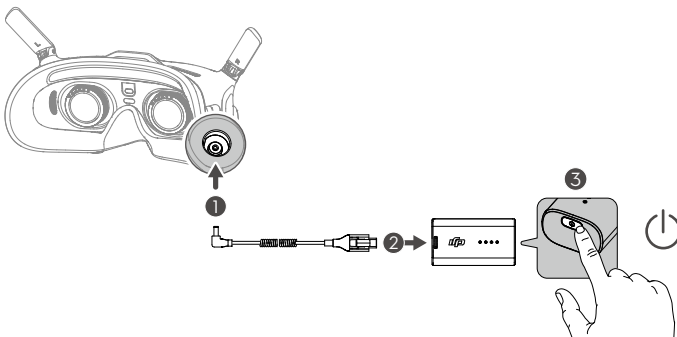



5. Wear the goggles and adjust the headband until the goggles fit comfortably.



6. Use the IPD (Interpupillary Distance) Slider / Diopter Adjustment Knob (hereinafter referred to as "knob") to adjust the distances between the lenses and the diopter to get a clear view.

a. Rotate both the knobs in the direction as shown to unlock them. Once unlocked, the knobs will pop out.

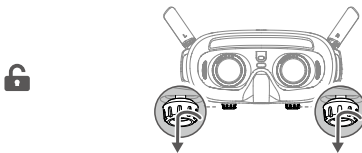

b. Toggle the knobs left and right to adjust the distance between the lenses until the images are properly aligned.

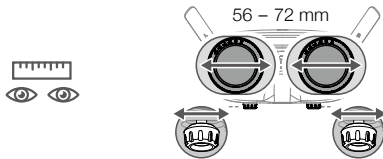

c. Slowly rotate the knobs to adjust the diopter. The supported adjustment range is from -8.0 D to +2.0 D.

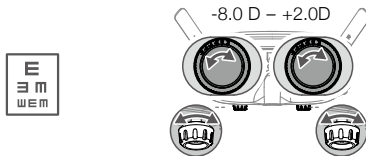

d. After you get a clear view, press the knobs in and rotate them in the direction as shown to lock in the lenses' position and the diopter.

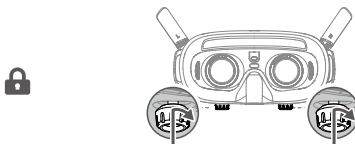



- The diopter lenses do not support astigmatism correction. If you require astigmatism correction or if the goggles' diopter is unsuitable, you can purchase additional lenses and use the eyeglass frames provided to install them on the goggles. Refer to the "Using the Eyeglass Frames" for more information.
- When adjusting the diopter for the first time, you are advised to adjust to a degree that is slightly lower than the strength of your actual eyeglasses. Give your eyes enough time to adapt, then adjust the diopter again until you get a clear view. Do not use a diopter higher than your actual eyeglass power to avoid eyestrain.



- Fold the antennas to avoid damage when the goggles are not in use.
- Re-attach the screen protector after use to protect the lens and prevent damage caused by direct sunlight.
- Only use the DJI goggles battery provided. DO NOT use non-DJI batteries.
- DO NOT use the goggles battery to power other devices.

## DJI FPV Goggles V2

1. Install the four antennas to the mounting holes on the front of the goggles. Make sure that the antennas are installed securely.

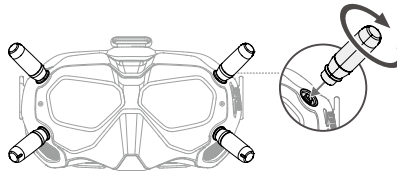

2. Attach the strap to the headband attachment on the top and sides of the goggles.

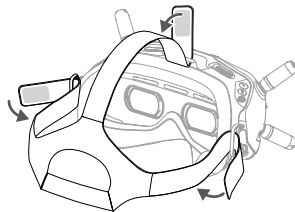

3. Use the included power cable to connect the power port of the goggles to the goggles battery. Press the power button once, then press again and hold for two seconds to power the goggles on.

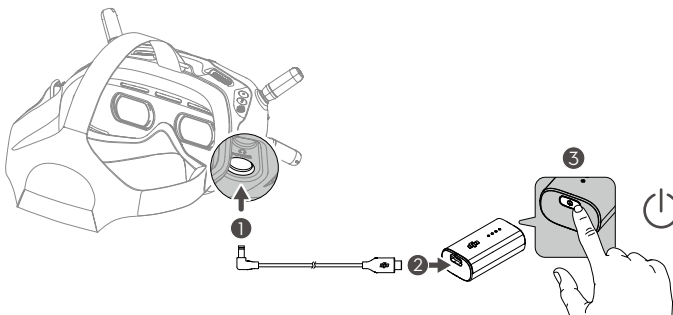

- Align the lenses over your eyes and pull the headband down. Adjust the headband size until the goggles fit securely and comfortably on your face and head.

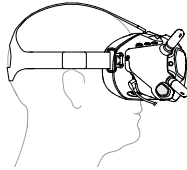

- Turn the IPD slider to adjust the distance between the lenses until the images are properly aligned.



- 
-  The goggles can be worn over glasses.

-  DO NOT use the goggles battery to power other mobile devices.
- 

## Preparing the Remote Control Devices

Press the power button once to check the current battery level. Charge before using if the battery level is too low.

### DJI Motion Controller

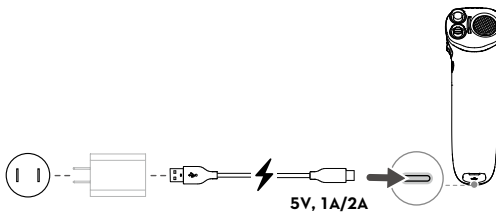

- 
-  USB Power Delivery chargers are not supported.
-

## DJI FPV Remote Controller 2

1. Charge the battery.

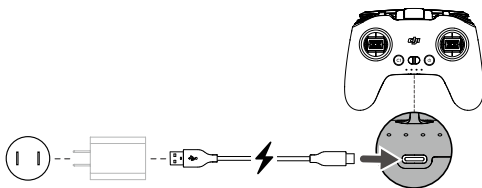

2. Remove the control sticks from the storage slots and mount them on the remote controller.
3. Unfold the antennas.

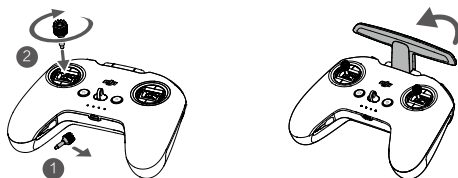

## Diagram

### Aircraft

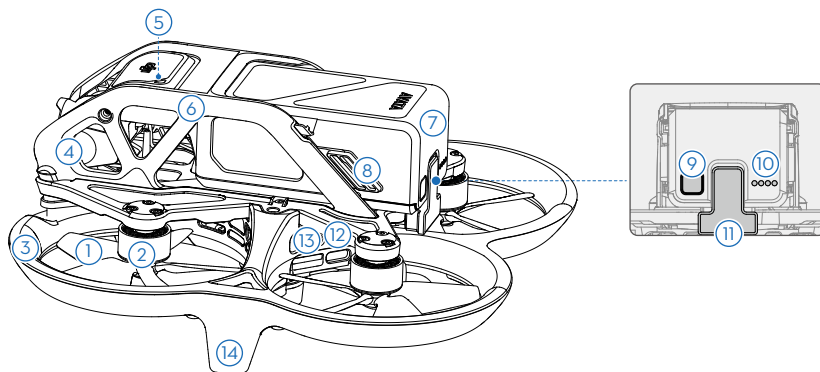

- |                              |                               |                       |
|------------------------------|-------------------------------|-----------------------|
| 1. Propellers                | 6. Upper Frame                | 11. Power Port        |
| 2. Motors                    | 7. Intelligent Flight Battery | 12. USB-C Port        |
| 3. Propeller Guard           | 8. Battery Buckles            | 13. microSD Card Slot |
| 4. Gimbal and Camera         | 9. Power Button               | 14. Landing Gears     |
| 5. Aircraft Status Indicator | 10. Battery Level LEDs        | (Built-in antennas)   |

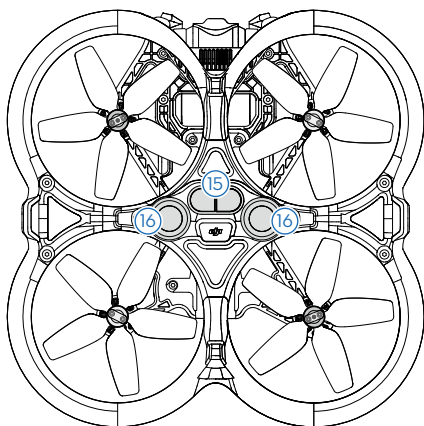

- |                             |
|-----------------------------|
| 15. Infrared Sensing System |
| 16. Downward Vision System  |



• Before flying, make sure the USB-C port and microSD card slot cover is correctly and securely sealed to avoid interference with the propellers.

## Goggles

### DJI Goggles 2

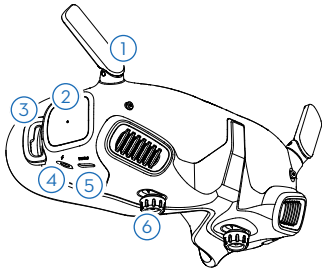

1. Antennas
2. Touch Panel
3. Headband Attachment
4. Power Port
5. USB-C Port
6. IPD Slider / Diopter Adjustment Knob
7. microSD Card Slot
8. 3.5 mm Audio Port
9. LED Dot Matrix Display
10. Lenses
11. Proximity Sensor  
Detects whether the user is wearing the goggles and automatically turns the screen on or off.
12. Link Button
13. Foam Padding

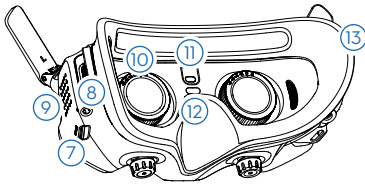

### DJI FPV Goggles V2

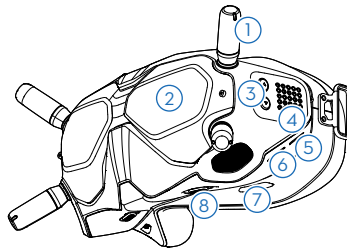

1. Antennas
2. Front Cover
3. Channel Adjustment Buttons
4. Channel Display
5. USB-C Port
6. microSD Card Slot
7. Air Intake
8. IPD Slider

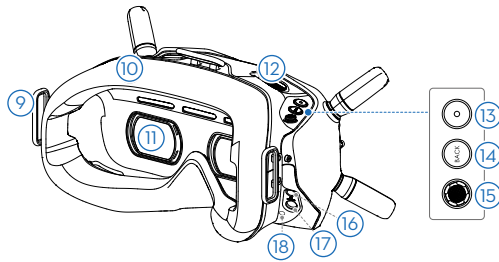

9. Headband Attachment

10. Foam Padding

11. Lenses

12. Air Vent

13. Shutter/Record Button

Press once to take photos or start or stop recording. Press and hold to switch between photo and video mode.

14. Back Button

Press to return to the previous menu or exit the current mode.

15. 5D Button

Toggle the button to scroll through the menu. Press the button to confirm.

On the home screen, toggle left or right to adjust the screen brightness. Toggle up or down to adjust the volume. Press the button to enter the menu.

16. Audio/AV-IN Port

17. Power Port (DC5.5x2.1)

18. Link Button

## Remote Control Devices

### DJI Motion Controller

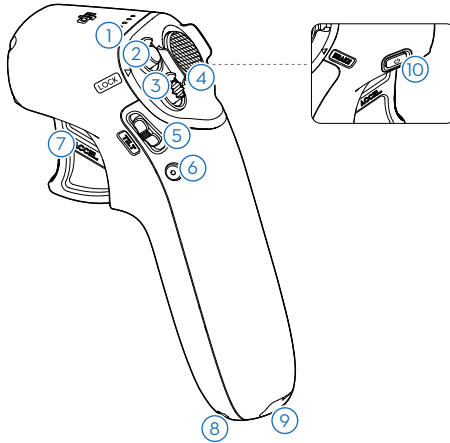

**1. Battery Level LEDs**

Indicates the battery level of the motion controller.

**2. Lock Button**

Press twice to start the motors of the aircraft.  
Press and hold to make the aircraft automatically take off, ascend to approx. 1.2 m, and hover.  
Press and hold while hovering to make the aircraft automatically land and the motors stop.  
Press once to cancel the Low Battery RTH countdown when the prompt appears in the goggles, and the aircraft will not enter the Lower Battery RTH.

**3. Mode Button**

Press once to switch between Normal and Sport mode.

**4. Brake Button**

Press once to make the aircraft brake and hover in place (only when GNSS or Vision System is available). Press again to unlock the attitude.  
Press and hold to initiate RTH.  
When the aircraft is performing RTH or auto landing, press the button once to cancel RTH or landing.

**5. Gimbal Tilt Slider**

Push up and down to adjust the tilt of the gimbal. Only available before takeoff, during RTH, or landing.

**6. Shutter/Record Button**

Press once to take photos or start or stop recording. Press and hold to switch between photo and video mode.

**7. Accelerator**

Press to fly the aircraft in the direction of the circle in the goggles. Apply more pressure to accelerate. Release to stop and hover.

**8. Lanyard Hole**

**9. USB-C Port**

For charging and connecting the motion controller to a computer for firmware updates.

**10. Power Button**

Press once to check the current battery level. Press once then again and hold to power the motion controller on or off.



DJI FPV Remote Controller 2

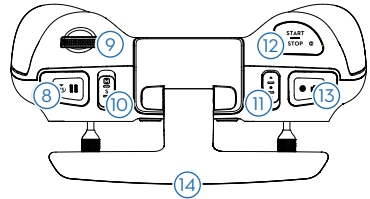
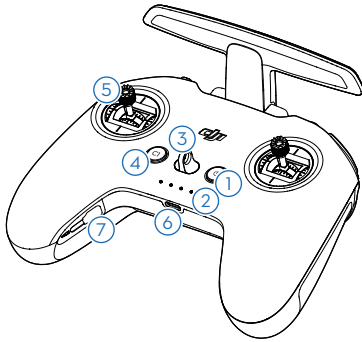

1. **Power Button**  
Press once to check the current battery level. Press, and then press and hold to power the remote controller on or off.
2. **Battery Level LEDs**  
Displays the current battery level of the remote controller.
3. **Lanyard Attachment**
4. **C1 Button (Customizable)**  
The function of this button can be adjusted in the goggles. By default, press once to enable or disable ESC Beeping.
5. **Control Sticks**  
Used to control the movements of the aircraft. The control sticks mode can be set in the goggles. The control sticks are removable and easy to store.
6. **USB-C Port**  
For charging and connecting the remote controller to your computer.
7. **Control Sticks Storage Slots**  
For storing the control sticks.
8. **Flight Pause/RTH Button**  
Press once to make the aircraft brake and hover in place (only when GNSS or Vision System is available). Press and hold to initiate RTH.  
  
When the aircraft is performing RTH or auto landing, press the button once to cancel RTH or landing.

9. **Gimbal Dial**  
Controls the tilt of the camera.
10. **Flight Mode Switch**  
Switch between Normal, Sport, and Manual mode. Manual mode is disabled by default and must be enabled in the goggles.
11. **C2 Switch (Customizable)**  
The function of this switch can be adjusted in the goggles. By default, toggle the switch to recenter the gimbal and adjust up and down.
12. **Start/Stop Button**  
When using Manual mode, press twice to start or stop the motor.  
  
When using Normal or Sport mode, press once to cancel Low Battery RTH countdown when the prompt appears in the goggles, and the aircraft will not enter the lower battery RTH.
13. **Shutter/Record Button**  
Press once to take photos or start or stop recording. Press and hold to switch between photo and video mode.
14. **Antennas**  
Relay aircraft control wireless signals.

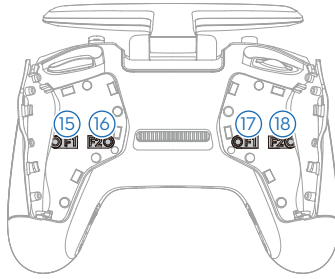

**15. F1 Right Stick Resistance Adjustment Screw (Vertical)**

Tighten the screw clockwise to increase the vertical resistance of the corresponding stick. Loosen the screw to decrease vertical resistance.

**16. F2 Right Stick Recentering Adjustment Screw (Vertical)**

Tighten the screw clockwise to disable the vertical recentering of the corresponding stick. Loosen the screw to enable vertical recentering.

**17. F1 Left Stick Resistance Adjustment Screw (Vertical)**

Tighten the screw clockwise to increase the vertical resistance of the corresponding stick. Loosen the screw to decrease vertical resistance.

**18. F2 Left Stick Recentering Adjustment Screw (Vertical)**

Tighten the screw clockwise to disable the vertical recentering of the corresponding stick. Loosen the screw to enable vertical recentering.

## Linking

Follow the steps below to link the aircraft, goggles, and remote control devices. Make sure that the DJI devices used with the aircraft are activated through the DJI Assistant 2 (Consumer Drones Series) and updated to the latest firmware before linking.

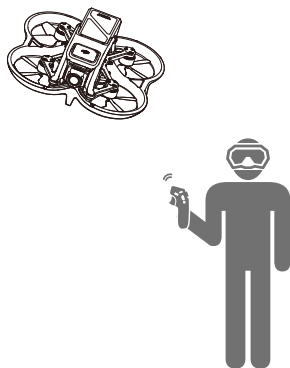

1. Power on the aircraft, goggles, and remote control devices. Press and then press and hold the power button to power devices on or off.
2. Press the link button on the goggles. The goggles will start to beep continually.
3. Press and hold the power button on the aircraft until the battery level LEDs start to blink in sequence.

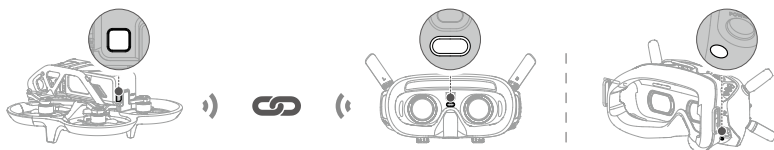

4. Once linking is completed, the battery level LEDs of the aircraft turn solid and display the battery level, the goggles stop beeping, and image transmission can be displayed normally.
5. Press and hold the power button on the aircraft until the battery level LEDs start to blink in sequence.
6. Press and hold the power button of the remote control device until it starts to beep continually and the battery level LEDs blinks in sequence.



7. Once linking is successful, the remote control device stops beeping and both the battery level LEDs turn solid and display the battery level.

- ☀️ • Make sure the goggles and the remote control device are within 0.5 m of the aircraft during linking.
  - To switch between the aircraft or air unit, enter the goggles menu and select before linking. For DJI Goggles 2, enter the Status page to select the aircraft or air unit. For DJI FPV Goggles V2, switch in Settings and then go to About page.
- 
- ⚠️ • The aircraft can be controlled with only one remote control device during flight. If your aircraft has been linked with multiple remote control devices, turn off other remote control devices before flight.
- 

## Activation

DJI Avata must be activated before using for the first time. Make sure all devices are linked after powering on the aircraft, goggles, and remote control device. Connect the USB-C port of the goggles to the mobile device, run DJI Fly, and follow the prompts to activate. An internet connection is required for activation.

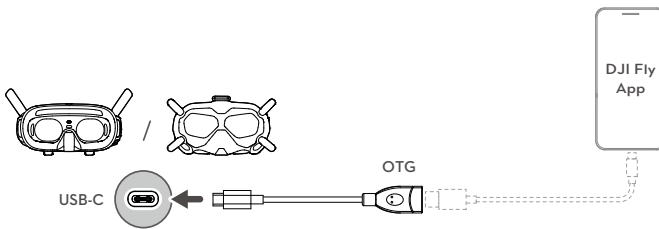

# Aircraft

DJI Avata contains a flight controller, gimbal and camera, video downlink system, vision system, propulsion system, and an Intelligent Flight Battery.

## Flight Modes

DJI Avata has three flight modes, which can be switched via the flight mode switch or button on the remote control devices.

**Normal Mode:** The aircraft utilizes GNSS, the Downward Vision System, and the Infrared Sensing System to locate itself and stabilize. When the GNSS signal is strong, the aircraft uses GNSS to locate itself and stabilize. When the lighting and other environmental conditions are sufficient, the aircraft uses the vision system. When the Downward Vision System is enabled and lighting conditions are sufficient, the maximum flight attitude angle is 25° and the maximum flight speed is 8 m/s.

**Sport Mode:** The aircraft utilizes the GNSS and Downward Vision System to automatically stabilize itself. In Sport mode, aircraft responses are optimized for agility and speed making it more responsive to control stick movements. The maximum flight speed is 14 m/s.

**Manual Mode:** Classic FPV aircraft control mode with the highest maneuverability, which can be used for racing and freestyle flying. In Manual mode, all flight assistance functions such as automatic stabilization are disabled and proficient control skills are required.

In Normal or Sport mode, when the Downward Vision System is unavailable or disabled and when the GNSS signal is weak or the compass experiences interference, the aircraft cannot position itself or brake automatically, which increases the risk of potential flight hazards. At this time, the aircraft may be more easily affected by its surroundings. Environmental factors such as wind can result in horizontal shifting, which may present hazards, especially when flying in confined spaces.



- Manual mode is only supported when using the DJI FPV remote controller 2 to operate the aircraft, and the throttle stick can be adjusted in this mode. DJI motion controller does not support Manual mode.



- When using Manual mode, move the remote control sticks to directly control the throttle and attitude of the aircraft. The aircraft has no flight assistance functions such as automatic stabilization and can reach any attitude. Only experienced pilots should use Manual mode. Failure to operate in this mode properly is a safety risk and may even lead to the aircraft crashing.
- Manual mode is disabled by default. Make sure that the switch is set to Manual mode in the goggles before switching to Manual mode. The aircraft will remain in Normal or Sport mode if the switch is not set to Manual mode in the goggles. Go to Settings > Control > Remote Controller > Button Customization, and then set the Custom Mode to Manual Mode.
- Before using Manual mode, it is recommended to adjust the screw on the rear of the throttle stick so that the stick does not recenter and to practice flying in the mode using DJI Virtual Flight.
- When using Manual mode for the first time, the maximum attitude of the aircraft will be limited. After you are familiar with flying in Manual mode, the attitude restriction can be disabled in the goggles. Go to Settings > Control > Remote Controller > Gain & Expo > M Mode Attitude Limit.
- When turning the aircraft at high speed in Manual mode, the attitude may become unstable. Avoid moving the aircraft laterally to ensure a stable flight.
- If using the manual mode when the battery is low, the aircraft power output is limited, please fly with caution.
- The maximum speed and braking distance of the aircraft significantly increase in Sport mode. A minimum braking distance of 30 m is required in windless conditions.
- The responsiveness of the aircraft significantly increases in Sport mode, which means a small control stick movement on the remote controller translates into the aircraft moving a large distance. Make sure to maintain adequate maneuvering space during flight.

## Aircraft Status Indicator

DJI Avata has an aircraft status indicator on the top.

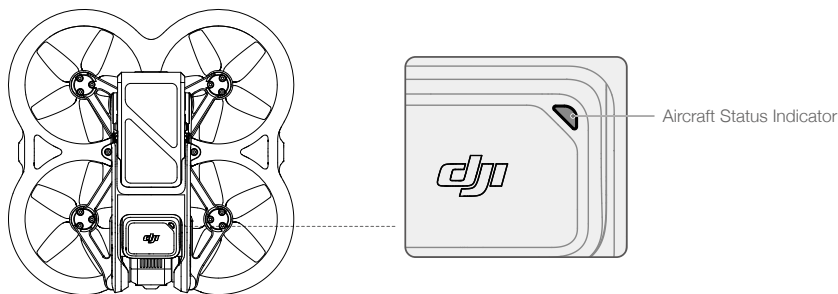

The aircraft status indicator shows the status of the flight control system of the aircraft. Refer to the table below for more information about the aircraft status indicator.

### Aircraft Status Indicator Descriptions

#### Normal States



	Blinks red, yellow, and green alternately	Powering on and performing self-diagnostic tests
	Blinks green slowly	GNSS or vision system enabled for positioning
	Blinks yellow slowly	GNSS and vision system disabled

#### Warning States

	Blinks yellow quickly	Remote control device signal lost
	Blinks red slowly	Low battery
	Blinks red quickly	Critically low battery
	Blinks red	IMU error
	Solid red	Critical error
	Blinks red and yellow alternately	Compass calibration required

## Return to Home

The Return to Home (RTH) function brings the aircraft back to the last recorded Home Point and lands when the GNSS signal is strong. There are three types of RTH: Smart RTH, Low Battery RTH, and Failsafe RTH. If the aircraft successfully recorded the Home Point and the GNSS signal is strong, the RTH will be triggered when either Smart RTH is initiated, the aircraft battery level is low, or the signal between the remote control device and the aircraft is lost. RTH will also be triggered in other abnormal scenarios such as where video transmission is lost.

	GNSS	Description
Home Point		The default Home Point is the first location where the aircraft received a strong or moderately strong GNSS signal (where the icon shows white). The aircraft status indicator blinks green quickly and a prompt appears in the goggles to confirm the Home Point has been recorded.

### Smart RTH

If the GNSS signal is sufficient, Smart RTH can be used to bring the aircraft back to the Home Point. Smart RTH can be initiated or canceled by the remote control devices. After exiting RTH, users will regain control of the aircraft.

### Low Battery RTH

When the Intelligent Flight Battery level is too low and there is not enough power to return home, land the aircraft as soon as possible.

In order to avoid unnecessary danger due to insufficient power, DJI Avata will intelligently determine whether the current battery level is sufficient to return to the Home Point based on the current location. Low Battery RTH is triggered when the Intelligent Flight Battery is depleted to the point that the safe return of the aircraft may be affected.

RTH can be canceled by the remote control devices. If RTH is canceled following a low battery warning, the Intelligent Flight Battery may not have enough power for the aircraft to land safely, which may lead to the aircraft being crashed or lost.

The aircraft will land automatically if the current battery level can only support the aircraft long enough to descend from its current altitude. The remote control devices can be used to alter the direction of the aircraft during the landing process. Pressing the accelerator when using the motion controller during landing can make the aircraft stop descending and fly at the current altitude to adjust the horizontal position. The aircraft will continue to descend after releasing the accelerator.

### Failsafe RTH

If the Home Point was successfully recorded and the compass is functioning normally, Failsafe RTH automatically activates after the remote control signal is lost for more than 3.5 seconds.

The aircraft will fly backwards for 50 m on its original flight route and enter Straight Line RTH. The aircraft enters Straight Line RTH if the remote control signal is restored during Failsafe RTH.

The response of the aircraft when the wireless signal is lost can be changed in the goggles. The aircraft will not execute Failsafe RTH if land or hover has been selected in the settings.

### Other RTH Scenarios

A prompt will appear in the goggles and RTH will be initiated if the video download signal is lost during flight, while the remote control devices can still be used to control the movements of the aircraft.

## RTH (Straight Line)

1. The Home Point is recorded automatically.
  2. RTH is triggered.
  3. If the aircraft is less than 5 m from the Home Point when RTH begins, it lands immediately.  
If the aircraft is more than 5 m and less than 50 m from the Home Point when RTH begins, it will return home at the current altitude with a maximum horizontal speed of 3 m/s.  
If the aircraft is further than 50 m from the Home Point when RTH begins, it will ascend to the RTH altitude and return home at a horizontal speed of 12 m/s. The aircraft flies to the Home Point at the current altitude if the RTH altitude is lower than the current altitude.
  4. After reaching the Home Point, the aircraft lands and the motors stop.
- 



- During RTH, obstacles around and above the aircraft cannot be detected or avoided.
  - The aircraft cannot return to the Home Point if the GNSS signal is weak or unavailable. If the GNSS signal becomes weak or unavailable after Failsafe RTH is triggered, the aircraft will hover for a while before landing.
  - Before each flight, it is important to enter Settings and then Safety on the goggles and set a suitable RTH altitude.
  - During RTH, if the aircraft is flying forward and the remote controller signal is normal, the DJI FPV remote controller 2 can be used to control the speed of the aircraft, but cannot control the orientation or fly left or right. The orientation and horizontal position of the aircraft can be controlled when it is descending. When the aircraft is ascending or flying forward, push the control stick completely in the opposite direction to exit RTH.
  - The aircraft will hover if it flies into a GEO Zone during RTH.
  - The aircraft may not be able to return to the Home Point when the wind speed is too high. Fly with caution.
- 

## Landing Protection

Landing Protection will activate during Smart RTH. Landing Protection is enabled once the aircraft begins to land.

1. Once Landing Protection determines that the ground is suitable, the aircraft will land gently.
  2. If the ground is determined unsuitable for landing, the aircraft will exit landing, then hover and wait for pilot confirmation.
  3. If Landing Protection is not operational, the goggles will display a landing prompt when the aircraft descends to 0.25 m. Press and hold the lock button on the motion controller, or pull down on the throttle stick of the remote controller to land.
- 



- When flying in strong winds, the aircraft will save power for landing by automatically adjusting the orientation to be consistent with the wind direction before landing.
  - The landing protection only works in certain scenarios and cannot replace the control and judgment of the user. During landing, pay attention to the surrounding environment of the landing point and avoid obstacles that are not suitable for landing such as trees, branches, and bushes.
-



## Vision System and Infrared Sensing System

DJI Avata aircraft is equipped with both an Infrared Sensing System and a Downward Vision System.

The Downward Vision System consists of two cameras. The Infrared Sensing System consists of two 3D infrared modules. The Downward Vision System and Infrared Sensing System help the aircraft maintain its current position, hover more precisely, and to fly indoors or in other environments where GNSS is unavailable.

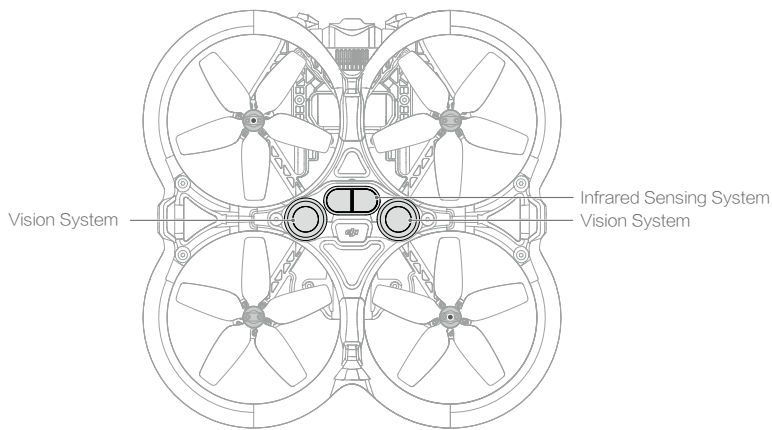

### Detection Range

The Downward Vision System works best when the aircraft is at an altitude of 0.5 to 10 m and its operating range is 0.5 to 20 m. The FOV to the front and rear is 106° and 90° to the right and left.

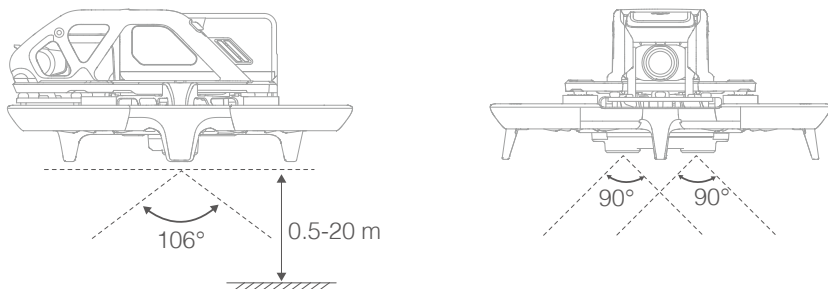

## Calibrating Vision System Cameras

### Auto Calibration

The Downward Vision System cameras installed on the aircraft are calibrated before shipping. If any abnormality is detected with a vision system camera, the aircraft will automatically calibrate and a prompt will appear in the goggles. No further action is required to address the issue.

### Advanced Calibration

If the abnormality persists after auto calibration, a prompt appears in the goggles that advanced calibration is required. Advanced calibration can only be performed using DJI Assistant 2 (Consumer Drones Series). Follow the steps below to calibrate the vision system cameras.

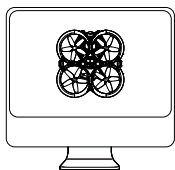

1

Point the aircraft toward the screen.

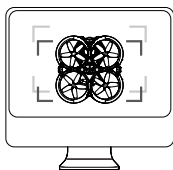

2

Align the boxes.

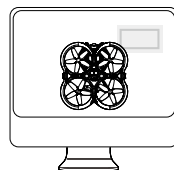

3

Pan and tilt the aircraft.

## Using the Vision System

The positioning function of the Downward Vision System is applicable when the GNSS signals are unavailable or weak. It is automatically enabled in Normal or Sport mode.

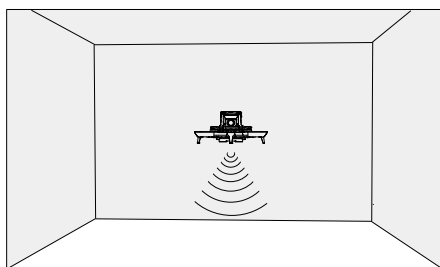



- Pay attention to the flight environment. The Downward Vision System and Infrared Sensing System only work in certain scenarios and cannot replace human control and judgment. During flight, pay attention to the surrounding environment and to the warnings on the goggles. Be responsible for and maintain control of the aircraft at all times.
  - The aircraft has a max hovering altitude of 20 m when using the vision system in an open and flat environment with clear texture. The best positioning altitude range of the vision system is 0.5 to 10 m. The vision positioning performance may decrease when flying beyond this range. Fly with caution.
  - The Downward Vision System may not function properly when the aircraft is flying over water. Therefore, the aircraft may not be able to actively avoid the water below when landing. It is recommended to maintain flight control at all times, make reasonable judgments based on the surrounding environment, and avoid over-relying on the Downward Vision System.
  - Note that the Downward Vision System and Infrared Sensing System may not function properly when the aircraft is flying too fast.
  - The vision system cannot work properly over surfaces without clear pattern variations or where the light is too weak or too strong. The vision system cannot work properly in the following situations:
    - a) Flying over monochrome surfaces (e.g., pure black, white, red, or green).
    - b) Flying over highly reflective surfaces.
    - c) Flying over water or transparent surfaces.
    - d) Flying over moving surfaces or objects.
    - e) Flying in an area with frequent and drastic lighting changes.
    - f) Flying over extremely dark (< 10 lux) or bright (> 40,000 lux) surfaces.
    - g) Flying over surfaces that strongly reflect or absorb infrared waves (e.g., mirrors).
    - h) Flying over surfaces without clear patterns or texture (e.g., power poles).
    - i) Flying over surfaces with repeating identical patterns or texture (e.g., tiles with the same design).
    - j) Flying over obstacles with small surface areas (e.g., tree branches).
  - Keep the sensors clean at all times. DO NOT tamper with the sensors. DO NOT use the aircraft in environments with significant dust or humidity. DO NOT obstruct the Infrared Sensing System.
  - If the aircraft is involved in a collision, it may be necessary to calibrate the vision system. Calibrate the vision system if the app prompts you to do so.
  - DO NOT fly when it is rainy, smoggy, or the visibility is lower than 100 m.
  - Check the following every time before takeoff:
    - a) Make sure there are no stickers or any other obstructions over the glass of the Downward Vision System and Infrared Sensing system.
    - b) Use soft cloth if there is any dirt, dust, or water on the glass of the Downward Vision System and Infrared Sensing system. DO NOT use any cleaning product that contains alcohol.
    - c) Contact DJI Support if there is any damage to the glass of the Downward Vision System or Infrared Sensing System.
- 

## Flight Recorder

Flight data including flight telemetry, aircraft status information, and other parameters are automatically saved to the internal data recorder of the aircraft. The data can be accessed using DJI Assistant 2 (Consumer Drones Series).

## Propellers

There are two types of DJI Avata propellers, which are designed to spin in different directions. Make sure to match the propellers and motors by following the instructions.

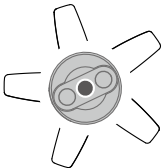
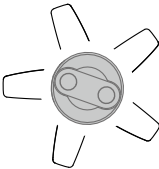
Propellers	With Marks	Without Marks
Illustration		
Mounting Position	Attach on motors with marks	Attach on motors without marks

### Attaching the Propellers

Flip the aircraft over so that the bottom is facing up, and mount the marked propellers onto the motors with marks. Insert the propeller into the motor base, slightly rotate the propeller to align the positioning holes and insert them, and then use a screwdriver to fasten the two screws. Mount the unmarked propellers to the motors without marks.

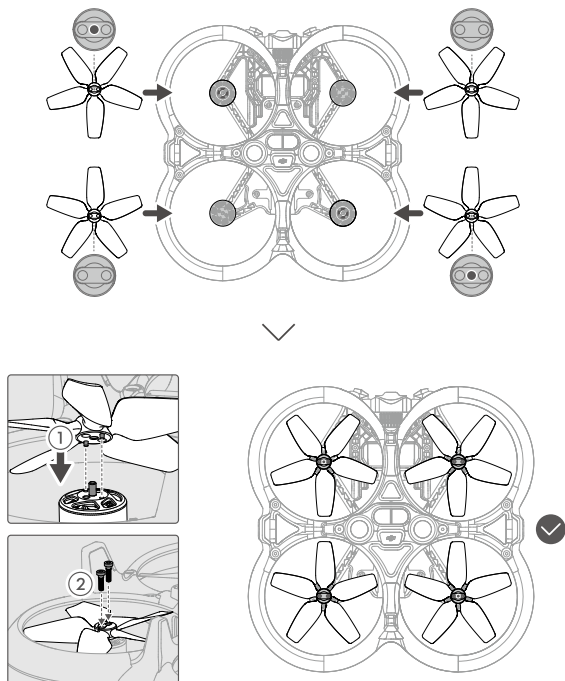

## Detaching the Propellers

Flip the aircraft so that the bottom is facing up, use a screwdriver to loosen the two screws and detach the propellers from the motors.

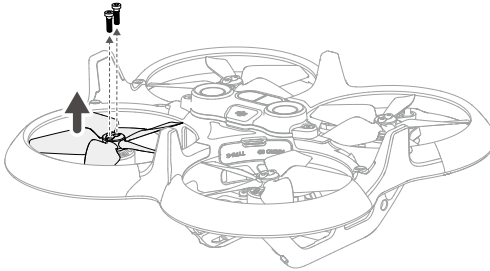

- Propeller blades are sharp. Handle with care.
  - Only use official DJI propellers. DO NOT mix propeller types.
  - Propellers are consumable components. Purchase additional propellers if necessary.
  - Make sure that the propellers and motors are installed securely before each flight.
  - Make sure that all propellers are in good condition before each flight. DO NOT use aged, chipped, or broken propellers.
  - To avoid injury, stay away from rotating propellers or motors.
  - Make sure the motors are mounted securely and rotating smoothly. Land the aircraft immediately if a motor is stuck and unable to rotate freely.
  - DO NOT attempt to modify the structure of the motors.
  - DO NOT touch or let hands or body parts come in contact with the motors after flight as they may be hot.
  - DO NOT block any of the ventilation holes on the motors or the body of the aircraft.
  - Make sure the ESCs sound normal when powered on.
-

## Intelligent Flight Battery

The Avata Intelligent Flight Battery is a 14.76 V, 2420 mAh battery with smart charging and discharging functionality.

### Battery Features

1. **Battery Level Display:** The battery level LEDs display the current battery level.
2. **Auto-Discharging Function:** To prevent swelling, the battery automatically discharges to approximately 96% of the battery level when it is idle for one day, and approximately 60% when idle for five days. It is normal to feel moderate heat from the battery, while it is discharging.
3. **Balanced Charging:** During charging, the voltages of the battery cells are automatically balanced.
4. **Overcharge Protection:** The battery stops charging automatically once fully charged.
5. **Temperature Detection:** To prevent damage, the battery only charges when the temperature is between 5° and 40° C (41° and 104° F). Charging stops automatically if the temperature of the battery exceeds 50° C (122° F) during charging.
6. **Overcurrent Protection:** The battery stops charging if an excess current is detected.
7. **Over-Discharge Protection:** Discharging stops automatically to prevent excess discharge when the battery is not in use. Over-discharge protection is not enabled when the battery is in use.
8. **Short Circuit Protection:** The power supply is automatically cut if a short circuit is detected.
9. **Battery Cell Damage Protection:** DJI goggles display a warning prompt when a damaged battery cell is detected.
10. **Hibernation Mode:** The battery switches off after 20 minutes of inactivity to save power. If the battery level is less than 10%, the battery enters Hibernation mode to prevent over-discharge after being idle for six hours. In Hibernation mode, the battery level indicators do not illuminate. Charge the battery to wake it from hibernation.
11. **Communication:** Information about the voltage, capacity, and current of the battery is transmitted to the aircraft.





- Refer to the DJI Avata Safety Guidelines and the stickers on the battery before use. Users shall take full responsibility for all operations and usage.



## Using the Battery

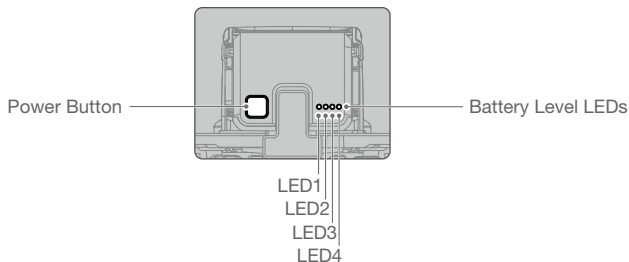































### Checking the Battery Level

Press the power button once to check the battery level.



 The battery level LEDs display the power level of the battery during charging and discharging. The statuses of the LEDs are defined below:

 LED is on.       LED is off.       LED is blinking.

LED1	LED2	LED3	LED4	Battery Level
				89%-100%
				76%-88%
				64%-75%
				51%-63%
				39%-50%
				26%-38%
				14%-25%
				1%-13%

### Powering On/Off

Press the power button once and then press again and hold for two seconds to power the aircraft on or off. The battery level LEDs display the battery level when the aircraft is powered on. The battery level LEDs turn off when the aircraft is powered off.

### Low Temperature Notice

1. Battery capacity is significantly reduced when flying at low temperatures from  $-10^{\circ}$  to  $5^{\circ}$  C ( $14^{\circ}$  to  $41^{\circ}$  F). Make sure to fully charge the battery before takeoff.
2. Batteries cannot be used in extremely low-temperature environments lower than  $-10^{\circ}$  C ( $14^{\circ}$  F).
3. When in low-temperature environments, end the flight as soon as the goggles display the low battery voltage warning.
4. To ensure optimal performance, keep the battery temperature above  $20^{\circ}$  C ( $68^{\circ}$  F).
5. The reduced battery capacity in low-temperature environments reduces the wind speed resistance performance of the aircraft. Fly with caution.
6. Fly with extra caution at high altitudes.

 • In cold environments, insert the battery into the battery compartment and power on the aircraft to warm up before taking off.

### Charging the Battery

Fully charge the battery before each use.

1. Charge with a USB charger and connect it to an AC outlet (100-240V, 50/60 Hz). Use a power adapter if necessary.
2. Connect the Intelligent Flight Battery to the USB charger using DJI Avata Adapter with the battery powered off.
3. The battery level LEDs display the current battery level during charging.
4. The Intelligent Flight Battery is fully charged when all the battery level LEDs are off. Detach the adapter when the battery is fully charged.

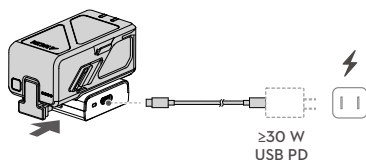

- ☀️ • It is recommended to use the DJI 30W USB-C Charger or other USB Power Delivery chargers.
  - The charging time is approximately 90 minutes.
  - For safety purposes, keep the batteries at a low power level in transit. Before transportation, it is recommended to discharge the batteries to 30% or lower.
- 
- ⚠️ • DO NOT charge an Intelligent Flight Battery immediately after flight as it may be too hot. Wait for the battery to cool down to room temperature before charging again.
  - The charger stops charging the battery if the cell temperature is not within 5° to 40° C (41° to 104° F). The ideal charging temperature is from 22° to 28° C (71.6° to 82.4° F).
  - The Battery Charging Hub (not included) can charge up to four batteries. Visit the official DJI online store for more information.
  - Fully charge the battery at least once every three months to maintain battery health.
  - DJI does not take any responsibility for damage caused by not using DJI Avata Adapter or DJI Avata Battery Charging Hub.

The table below shows the battery level during charging.

LED1	LED2	LED3	LED4	Battery Level
☀️	☀️	○	○	1%-50%
☀️	☀️	☀️	○	51%-75%
☀️	☀️	☀️	☀️	76%-99%
○	○	○	○	100%

## DJI Avata Adapter Status LED Descriptions

LED Indicator	Description
Solid yellow	No battery attached
Pulses green	Charging
Solid green	Fully charged
Blinks yellow	Temperature of battery too low or too high (no further operation needed)
Solid red	Power supply or battery error (unplug and plug the batteries or charger to resume charging)



## Battery Protection Mechanisms

The battery level LEDs can display battery protection notifications triggered by abnormal charging conditions.

Battery Protection Mechanisms					
LED1	LED2	LED3	LED4	Blinking Pattern	Status
○	☀	○	○	LED2 blinks twice per second	Overcurrent detected
○	☀	○	○	LED2 blinks three times per second	System abnormal
○	○	☀	○	LED3 blinks twice per second	Overcharge detected
○	○	☀	○	LED3 blinks three times per second	Over-voltage charger detected
○	○	○	☀	LED4 blinks twice per second	Charging temperature is too low
○	○	○	☀	LED4 blinks three times per second	Charging temperature is too high
○	○	○	☀	LED4 blinks four times per second	Non-DJI adapter

If any of the battery protection mechanisms are activated, unplug the charger, and plug it in again to resume charging. If the charging temperature is abnormal, wait for it to return to normal and the battery will automatically resume charging without the need to unplug and plug the charger again.

## Installing/Removing the Battery

Install the Intelligent Flight Battery in the aircraft before use. Insert the Intelligent Flight Battery into the battery compartment of the aircraft. Make sure it is mounted securely and that the battery buckles are clicked into place before connecting it to the power port.

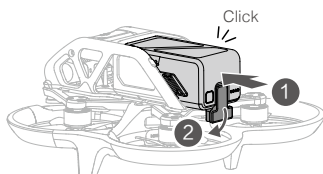

Disconnect the power port, press the battery buckles on the sides of the Intelligent Flight Battery, and remove it from the compartment.

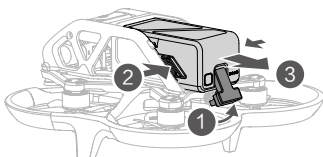

- ⚠ • DO NOT insert or remove the battery while the aircraft is powered on.
- Make sure the battery is mounted securely.

### Maintenance

Return to home or land promptly if a prompt appears in the goggles that the Intelligent Flight Battery requires maintenance.

1. Fully charge the battery.
2. Leave the battery for 24 hours.
3. Insert the battery in the aircraft and hover at an altitude of up to 2 m after takeoff. When the battery reaches 20%, land the aircraft and power off, and remove the battery.
4. Leave the battery for 6 hours.
5. Maintenance should now be complete and the battery is ready to use. Repeat the steps above if the maintenance prompt continues to appear in the goggles.

### Gimbal and Camera

#### Gimbal Profile

The gimbal of DJI Avata stabilizes the camera and supports tilt angle adjustment, allowing you to capture clear and steady images and videos at high flight speed. The control tilt range is  $-80^{\circ}$  to  $+65^{\circ}$ . Use the remote control devices to control the tilt of the camera.

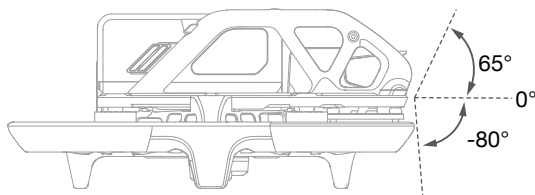

#### Gimbal Mode

The gimbal mode will automatically switch according to the flight mode.

Normal/Sport mode: the gimbal is in attitude stabilization mode. The tilt angle of the gimbal remains stable relative to the horizontal plane.

Manual mode: the gimbal is in lock mode. The tilt angle of the gimbal remains stable relative to the aircraft body.



- DO NOT tap or knock the gimbal after the aircraft is powered on. Launch the aircraft from open and flat ground to protect the gimbal during takeoff.
- Precision elements in the gimbal may be damaged in a collision or impact, which may cause the gimbal to function abnormally.
- Avoid getting dust or sand on the gimbal, especially in the gimbal motors.
- A gimbal motor error may occur if the aircraft is on uneven ground, the gimbal is obstructed, or the gimbal experiences a collision or crash.
- DO NOT apply external force to the gimbal after the gimbal is powered on. DO NOT add any extra payload to the gimbal as this may cause the gimbal to function abnormally or even lead to permanent motor damage.
- Make sure to remove the gimbal protector before powering on the aircraft. Make sure to mount the gimbal protector when the aircraft is not in use.
- Flying in heavy fog or clouds may make the gimbal wet, leading to temporary failure. The gimbal will recover full functionality once it is dry.

### Camera

DJI Avata uses a 1/1.7" CMOS sensor camera with up to 12 million effective pixels. The aperture of the lens is F2.8, the focus range is 0.6 m to infinity, and the FOV of the lens can reach 155°.

DJI Avata camera can shoot up to 4K 60fps HD video and 4K photos.

---



- Make sure the temperature and humidity are suitable for the camera during use and storage.
  - Use a lens cleanser to clean the lens to avoid damage or poor image quality.
  - DO NOT block any ventilation holes on the gimbal and camera as the heat generated may damage the device and cause harm.
- 

### Storing Photos and Videos

DJI Avata has 20 GB of built-in storage and supports the use of a microSD card to store photos and videos. A UHS-I Speed Grade 3 rating or above microSD card is required due to the fast read and write speeds necessary for high-resolution video data. Refer to the Specifications for more information about recommended microSD cards.

---



- Photos and videos recorded by the aircraft can be previewed. Insert the microSD card of the aircraft into the microSD card slot of the goggles.
- 



- DO NOT remove the microSD card from the aircraft while it is powered on. Otherwise, the microSD card may be damaged.
  - Check camera settings before use to ensure they are configured correctly.
  - Before shooting important photos or videos, shoot a few images to test whether the camera is operating correctly.
  - Make sure to power off the aircraft correctly. Otherwise, the camera parameters will not be saved and any recorded videos may be affected. DJI is not responsible for any loss caused by an image or video recorded in a way that is not machine-readable.
-

# Goggles

## DJI Goggles 2

DJI Goggles 2 are equipped with high-performance dual displays and ultra-low-latency image transmission for use with DJI aircraft, giving you a real-time aerial FPV (First Person View) experience. The wireless streaming function enables you to project the live-feed from your mobile phone or computer to the goggles screen, bringing you an immersive viewing experience. DJI Goggles 2 support the Head Tracking function. With this function, the aircraft and gimbal can be controlled through head movements. When used with the DJI Motion Controller, you can control the aircraft and the gimbal camera freely to meet your shooting needs in various scenarios. The touch panel enables you to easily complete operations using only one hand while watching the screen. To provide a more comfortable experience for users who are visually impaired, the goggles support diopter adjustment so that glasses are not required during use.

### Power Supply

Use the power cable provided to connect the power port of the goggles to the goggles battery.

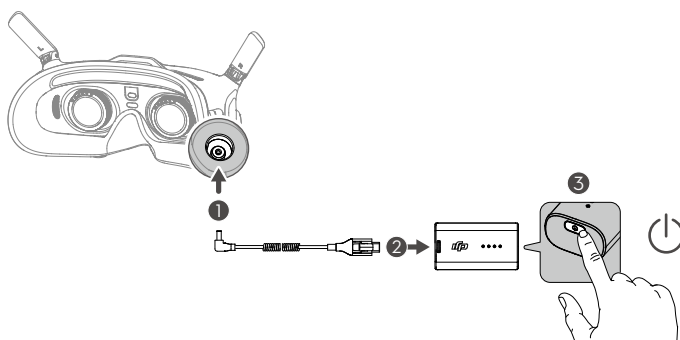

Press the power button once to check the current battery level.

Press once, then press again and hold for two seconds to power the goggles on or off.

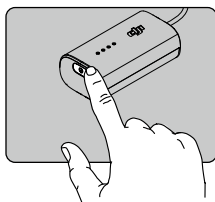

It is recommended to use a USB Power Delivery charger when the battery of the goggles is low.

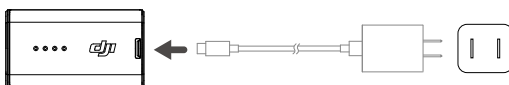

## Using the Eyeglass Frames

The goggles support diopter adjustment in the range of -8.0 D to +2.0 D. The goggles do not support astigmatism correction. If you require astigmatism correction or the goggles' diopter is unsuitable, you can purchase additional lenses and use the eyeglass frames to install them on the goggles.

- ⚠ When purchasing lenses, bring the eyeglass frames (a pair) to a professional optical shop to ensure that the shape, size, astigmatism axis, and edge thickness (< 2.8 mm) of the lenses meet the installation requirements of the eyeglass frames.
- The overall diopter is the sum of the goggles' diopter and the diopter of the additional lenses. Make sure to adjust the diopter of the goggles first and lock the knobs before installing the eyeglass frames.
- If the installed lens supports astigmatism correction, do not rotate the knob after the eyeglass frame is installed. Otherwise, the astigmatism axis will shift resulting in blurred vision. Make sure to adjust the diopter of the goggles before installing the eyeglass frames.

1. Detach the eyeglass frame and remove the original dummy lens.

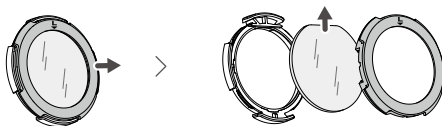

2. Install the prepared lens as shown. Make sure to distinguish the left lens and the right one.

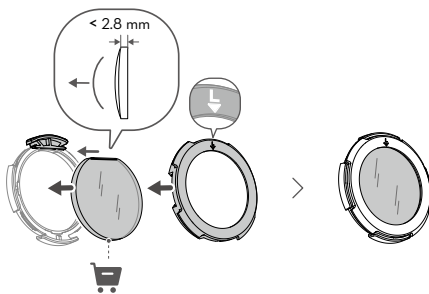

3. Adjust the diopter of the goggles according to your needs and lock the knobs.

For example, if you usually wear -6.0 D glasses and the self-prepared lens is -3.0 D, then you will need to adjust the diopter of the goggles to -3.0 D to ensure that the overall diopter is -6.0 D after the eyeglass frame is installed on the goggles.

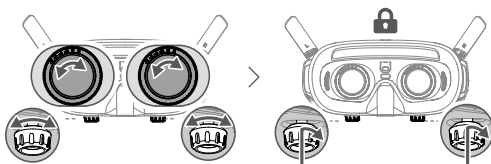

4. Install the left and right frames onto the goggles. When installing, make sure that the mark on the top of the frame is facing upwards, and the triangular arrow is aligned with the white dot on the upper edge of the goggle lens.

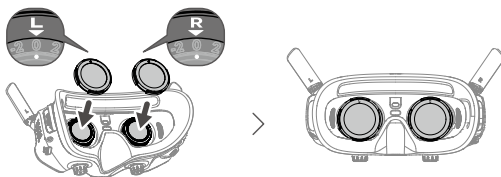

## Operation

The touch panel enables you to operate with only one hand.

-  • To ensure flight safety when using the motion controller, press the brake button once to brake and hover before operating the touch panel of the goggles. Failure to do so is a safety risk and may lead to the aircraft losing control or injury.
- 

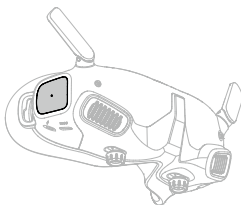

Swipe down from the top: Enter the shortcut menu

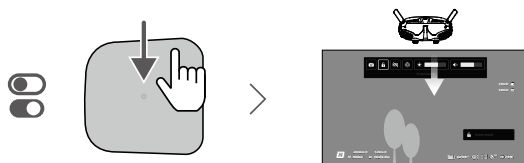

Swipe up from the bottom: Enter the camera settings

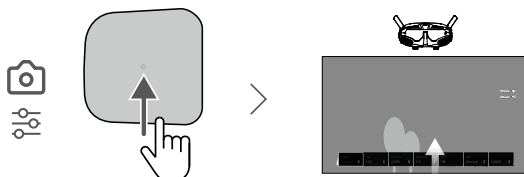

Swipe right from the left: Enter the menu

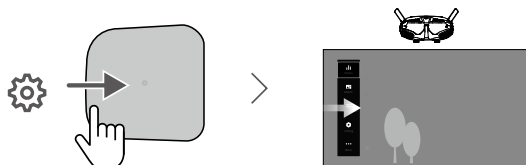

Swipe up/down/right/left: Navigate the menu

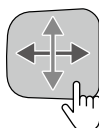

Single tap: Confirm/Select



Tap with two fingers: Back

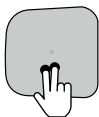

Press and hold with two fingers on the Home Screen: Lock/Unlock the screen

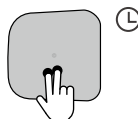

When playing video:

Swipe left/right: Control the progress bar

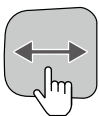

Swipe up/down: Adjust volume

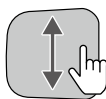

Tap once: Pause/Play



- When operating the touch panel, use slow and precise swipes to maximize function accuracy.
- You can change the setting to enter the menu by swiping left to right. Go to Settings > Control > Invert Horizontal Swipe to make the changes.

## Home Screen

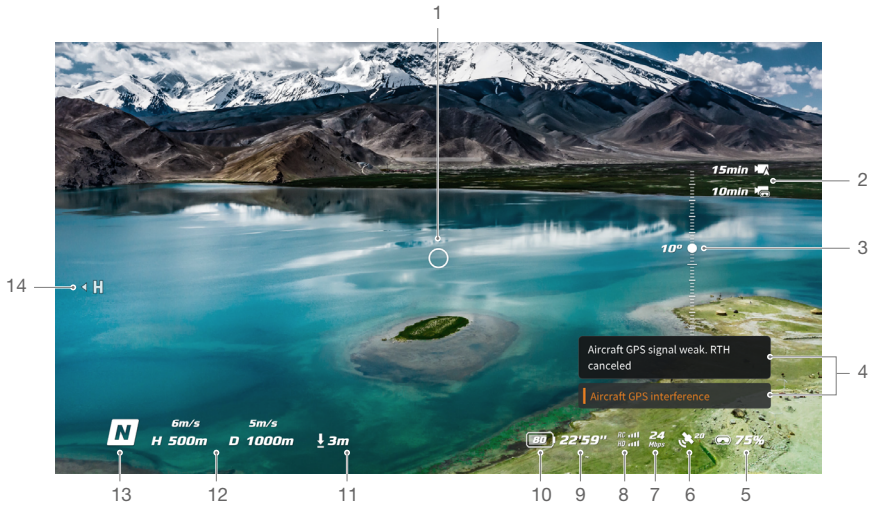

### 1. Flight Direction Indicator

When the motion controller is stationary, it indicates the midpoint of the screen. When the motion controller is moved, it indicates the change of the aircraft orientation or gimbal tilt.

### 2. Storage Information

Displays the remaining capacity of the aircraft and goggles. A flashing icon will appear when recording.

### 3. Gimbal Slider

Displays the gimbal tilt angle when the gimbal slider or dial is toggled.

### 4. Prompts

Displays notifications and information such as when a new mode is applied or battery level is low.

### 5. Goggles Battery Level

Displays the battery level of the goggles.

### 6. GNSS Status

Displays the current strength of the aircraft GNSS signal.

### 7. Video Bitrate

Displays the current video bitrate of the live view.

### 8. Remote Control Device and Video Downlink Signal Strength

Displays the remote control signal strength between the aircraft and remote control device and the video downlink signal strength between the aircraft and the goggles.

When the remote control or image transmission signals are weak, a visual prompt will display at the bottom of the screen. The user can keep flying or perform RTH.

Orange: moderately weak signal

Red: weak signal



9. Remaining Flight Time

Displays the remaining flight time of the aircraft after starting the motors.

10. Aircraft Battery Level

11. Distance to the Ground

Displays the current altitude information of the aircraft from the ground when the aircraft is less than 10 m above the ground.

12. Flight Telemetry

Displays the horizontal distance (D) and speed as well as vertical distance (H) and speed between the aircraft and the Home Point.

13. Flight Modes

Displays the current flight mode.

14. Home Point

Indicates the location of the Home Point.



- The goggles will display the screen saver if they are disconnected from the aircraft and not used for an extended period. Tap the touch panel to exit the screen saver. Reconnect the goggles to the aircraft and image transmission will be restored.
- If the devices are not used for an extended period, it may take longer than usual to search for the GNSS signal. If the signal is unobstructed, it takes approximately 20 seconds to search for the GNSS signal when powering on and off within a short period.



- If you select to record with both the aircraft and the goggles, the storage information of both the aircraft and goggles will be displayed on the home screen. If you select to record with only the aircraft or goggles, only the storage information of the corresponding device will be displayed.

## Menu

### Shortcut Menu

Swipe down from the top of the touch panel to enter the shortcut menu and perform the following functions:

- Start/stop recording
- Lock/unlock the screen
- Enable/disable Enhanced Display
- Enable/disable Head Tracking
- Adjust brightness
- Adjust volume

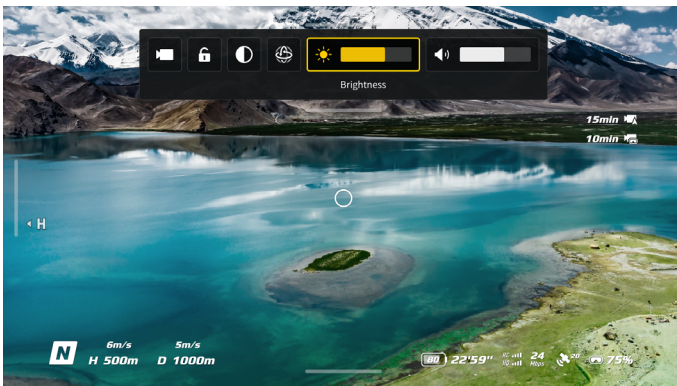

## Camera Settings

Swipe up from the bottom of the touch panel to enter the camera settings to change the camera parameters.



## Menu

Swipe right from the left of the touch panel to open the goggles menu.

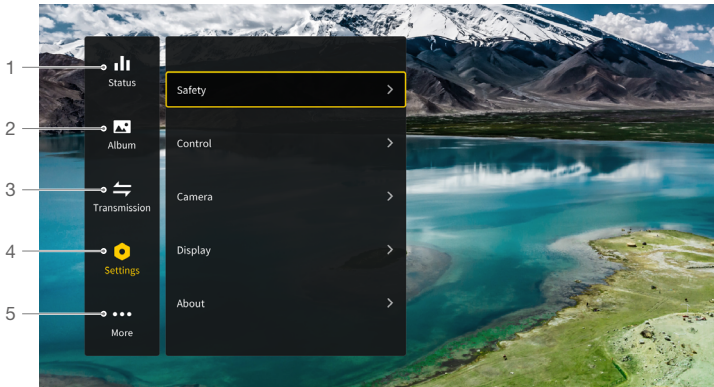

### 1. Status

Displays the in-use aircraft model and detailed information of prompt alerts. To change aircraft, use the switch function in the upper right corner.

### 2. Album

Shows the photos or videos stored on the microSD of the goggles. Select the file and confirm to preview.

### 3. Transmission

The Transmission menu has a Pilot sub-menu and Audience sub-menu.

- The video transmission settings for the current device can be set under the Pilot sub-menu, including but not limited to:
  - a. Enable or disable the broadcast mode. The device number will be displayed when Broadcast mode is enabled so that other devices can find the device and enter the channel to see the camera view.
  - b. Set the focus mode to on, off, or auto. If Focus mode is turned on, the center of the screen will be clearer and the edges will be blurred.
  - c. Set the channel mode to auto or manual. It is recommended to select auto so that the video transmission will intelligently select the channel with the best signal.
  - d. Set the frequency band. Only 5.8 GHz frequency band is supported.
  - e. Set the bandwidth of the video transmission. The number of channels available varies according to the bandwidth. The channel with the best signal strength can be manually selected.

The larger the bandwidth, the more spectrum resources it occupies, which provides a higher video transmission rate and clearer image quality. However, there will also be a higher chance of wireless interference and the amount of equipment that can be accommodated will be more limited. To avoid interference in a multiplayer scenario, manually select a fixed bandwidth and channel.
- If any nearby video transmission device turns on the Broadcast mode, the device and its signal strength can be viewed in the Audience sub-menu. Select a channel to see the camera view.

### 4. Settings

- Safety
  - a. Set the safety configurations such as max flight altitude, max flight distance, and RTH altitude. Users can also update the Home Point, and view the IMU and compass status and calibrate them if necessary.
  - b. Find My Drone helps to find the location of the aircraft on the ground by using the cached video in the goggles. If the aircraft still has battery, turn on ESC beeping to help find the aircraft using sound.
  - c. Advanced Safety Settings include aircraft signal lost action, enabling/disabling AirSense, and emergency propeller stop. The aircraft can be set to hover, land, or RTH when it loses the signal from the remote control devices. If the emergency propeller stop is enabled, the motors can be stopped mid-flight anytime by pressing the lock button twice on the motion controller or performing a combination stick command (CSC) on the remote controller. If the switch is disabled, the motors can only be stopped mid-flight with the same control action in an emergency situation, such as if a collision occurs, a motor stalls, the aircraft rolls in the air, or is out of control and is ascending or descending quickly.

**Stopping the motors mid-flight will cause the aircraft to crash.**
- Control
  - a. Set stick mode and customize functions of certain remote controller buttons in Remote Controller. The exponential can be adjusted when using Manual mode. Users can also calibrate the remote controller.
  - b. Calibrate the motion controller, or view its tutorial video.
  - c. Calibrate the gimbal or adjust the gimbal tilt speed.
  - d. Set the unit, or invert horizontal swipe for the touch panel.
  - e. Use flip function.
  - f. Watch the goggles tutorial.
- Camera
  - a. Set video quality, camera FOV, EIS (electronic image stabilization), gridlines, enable or disable the center point of the screen, and format the microSD card. Note that the data cannot be recovered after formatting. Operate with caution.
  - b. In Advanced Camera Settings, users can set the recording device, color, and anti-flicker, as well as enable or disable auto record on takeoff, and video subtitles.
  - c. Select Reset Camera Parameters to restore all camera settings to default.

- Display  
Adjust screen brightness, zoom, and display or hide the Home Point.
  - About
    - a. View device information, such as the serial number and the firmware of the goggles and linked devices.
    - b. Select the system language.
    - c. Select Reset All to reset the goggles and the linked devices to their default settings.
    - d. Select Clear All Data to clear all aircraft data, including data in the aircraft internal storage and SD card, unlocking licenses, aircraft logs, and other user data stored on the aircraft, and the aircraft will be reset to the default settings.
- 



- The cleared data cannot be restored. Perform with caution.
- 

### 5. More

The wireless streaming function enables you to cast the video playing on the mobile device to the goggles screen (the video player must support the screen casting function).

## Using the Head Tracking Function

DJI Avata supports a head tracking function, which can be enabled by clicking  in the shortcut menu of the goggles.

After enabling the head tracking, the horizontal orientation of the aircraft and the gimbal tilt can be controlled through head movements. The remote control device will only control the flight path of the aircraft. The gimbal will not be able to be controlled by the remote control device.

## Using the Wireless Streaming Function

The wireless streaming function enables you to project the video playing on your mobile phone or computer to the goggles display. For this to work, the video player must support screen casting.

To use this function, open the goggles menu and select More, then tap Wireless Streaming and follow the on-screen instructions.

## DJI FPV Goggles V2

The DJI FPV Goggles V2 are equipped with a high-performance display and support 810p 120fps HD display and real-time audio transmission. By receiving the video signal from the aircraft, users can enjoy a first-person view of their aerial experience in real-time. They can also be used to play videos recorded by the goggles and set transmission, control, and camera parameters.

### Power Supply

Use the included goggles power cable (USB-C) to connect the power port of the goggles to the goggles battery.

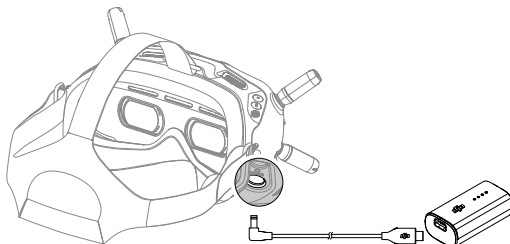

Press the power button once to check the current battery level.

Press once, then press again and hold for two seconds to power the goggles on or off.

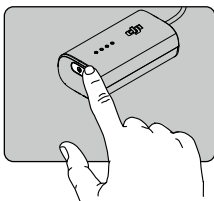

Charge the goggles battery if the battery level is low.

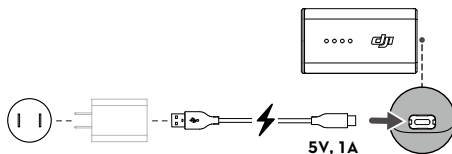

## Operation



### 5D Button

Toggle the button to scroll through the menu. Press the button to confirm.

On the home screen, press the button to enter the menu. Toggle left or right to adjust the screen brightness. Toggle up or down to adjust the volume.

During video playback, press the 5D button to pause or continue, toggle the 5D button left or right to adjust the progress bar, and toggle up or down to adjust the volume.



### Shutter/Record Button

Press once to take photos or start or stop recording. Press and hold to switch between photo and video mode.



### Back Button

Press to return to the previous menu or exit the current mode.



## Channel Adjustment Buttons

Press the up or down button to switch channels (only available when in manual channel mode).

## Channel Display

Displays the current channel of the goggles (will display A when in auto channel mode).

## Home Screen



### 1. Flight Direction Indicator

When the motion controller is stationary, it indicates the midpoint of the screen. When the motion controller is moved, it indicates the change of the aircraft orientation or gimbal tilt.

### 2. Storage Information

Displays the remaining capacity of the aircraft and goggles. A flashing icon will appear when recording.

### 3. Gimbal Slider

Displays the gimbal tilt angle when the gimbal slider or dial is toggled.

### 4. Prompts

Displays notifications and information such as when a new mode is applied or battery level is low.

### 5. Goggles Battery Level

Displays the battery level of the goggles. The goggles will beep when the battery level is too low.

### 6. GNSS Status

Displays the current GNSS signal strength.

### 7. Remote Control Device and Video Downlink Signal Strength

Displays the remote control signal strength between the aircraft and remote control device and the video downlink signal strength between the aircraft and the goggles.

### 8. Remaining Flight Time

Displays the remaining flight time of the aircraft after starting the motors.

### 9. Aircraft Battery Level

Displays the current battery level of the Intelligent Flight Battery on the aircraft.

### 10. Distance to the Ground

Displays the current altitude information of the aircraft from the ground when the aircraft is less than 10 m above the ground.

### 11. Flight Telemetry

Displays the horizontal distance (D) and speed as well as vertical distance (H) and speed between the aircraft and the Home Point.

### 12. Flight Modes

Displays the current flight mode.

### 13. Home Point

Indicates the location of the Home Point.



- The goggles will display the screen saver if they are not used for an extended period or disconnected from the aircraft. Press any button of the goggles or relink them to the aircraft to restore the video transmission display.
- If the devices are not used for an extended period, it may take longer than usual to search for the GNSS signal. If the signal is unobstructed, it takes approximately 20 seconds to search for the GNSS signal when powering on and off within a short period.



- If you select to record with both the aircraft and the goggles, the storage information of both the aircraft and goggles will be displayed on the home screen. If you select to record with only the aircraft or goggles, only the storage information of the corresponding device will be displayed.
-

## Menu

Press the 5D button on the goggles to enter the menu bar.

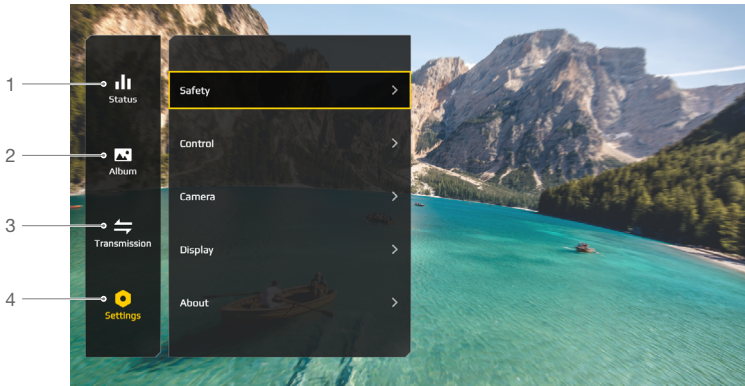

### 1. Status

Displays detailed information for current status warning prompts.

### 2. Album

Shows the photos or videos stored on the microSD of the goggles. Select the file and confirm to preview.

### 3. Transmission

The Transmission menu has a Pilot sub-menu and Audience sub-menu.

- The video transmission mode for the current device can be set under the Pilot sub-menu, including but not limited to:
  - a. Enable or disable the broadcast mode. The device number will be displayed when Broadcast mode is enabled so that other devices can find the device and enter the channel to see the camera view.
  - b. Set the focus mode to on, off, or auto. If Focus mode is turned on, the center of the screen will be clearer and the edges will be blurred.
  - c. Set the channel mode to auto or manual. It is recommended to select auto so that the video transmission will intelligently select the channel with the best signal.
  - d. Set the frequency band. Only 5.8 GHz frequency band is supported.
  - e. Set the bandwidth of the video transmission. The number of channels available varies according to the bandwidth. The channel with the best signal strength can be manually selected.

The larger the bandwidth, the more spectrum resources it occupies, which provides a higher video transmission rate and clearer image quality. However, there will also be a higher chance of wireless interference and the amount of equipment that can be accommodated will be more limited. To avoid interference in a multiplayer scenario, manually select a fixed bandwidth and channel.

- If any nearby video transmission device turns on the Broadcast mode, the device and its signal strength can be viewed in the Audience sub-menu. Select a channel to see the camera view.

### 4. Settings

- Safety
  - a. Set the safety configurations such as max flight altitude, max flight distance, and RTH altitude. Users can also update the Home Point, and view the IMU and compass status and calibrate them if necessary.
  - b. Find My Drone helps to find the location of the aircraft on the ground by using the cached video in the goggles.



- c. Advanced Safety Settings include aircraft signal lost action, enabling/disabling AirSense, and emergency propeller stop. The aircraft can be set to hover, land, or RTH when it loses the signal from the remote controller devices. If the emergency propeller stop is enabled, the motors can be stopped mid-flight anytime by pressing the lock button twice on the motion controller or performing a combination stick command (CSC) on the remote controller. If the switch is disabled, the motors can only be stopped mid-flight with the same control action in an emergency situation, such as if a collision occurs, a motor stalls, the aircraft rolls in the air, or is out of control and is ascending or descending quickly.

**Stopping the motors mid-flight will cause the aircraft to crash.**

- Control

Set the parameters for the remote controller or the motion controller. Calibrate the gimbal or adjust aircraft parameters such as the gimbal tilt speed.

- Camera

- a. Camera parameters such as ISO, shutter, EV, and WB can be adjusted. Also, the camera mode can be set to auto or manual.
- b. Set video quality, camera FOV, EIS (electronic image stabilization), gridlines, enable or disable the center point of the screen, and format the microSD card. Note that the data cannot be recovered after formatting. Operate with caution.
- c. In Advanced Camera Settings, users can set the recording device, color, and anti-flicker, as well as enable or disable auto record on takeoff, and video subtitles.
- d. Select Reset Camera Parameters settings to restore all camera settings to default.

- Display

Adjust screen brightness, zoom, and display or hide the Home Point.

- About

- a. View device information, such as the serial number and the firmware of the goggles and linked devices.
- b. Select the system language.
- c. Select Reset All to reset the goggles and the linked devices to their default settings.
- d. Switch aircraft model.

# Remote Control Devices

## DJI Motion Controller

When used with the goggles, the DJI Motion Controller provides an immersive and intuitive flying experience that allows users to easily control the aircraft using hand movements. Built into the DJI Motion Controller is DJI's O3+ transmission technology, offering a maximum transmission range of 6 mi (10 km). The motion controller works at both 2.4 and 5.8 GHz and is capable of selecting the best transmission channel automatically.

### Operation

#### Powering On/Off

Press the power button once to check the current battery level. Charge before using if the battery level is too low. Press once then press again and hold for two seconds to power the motion controller on or off.

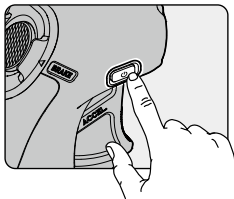

#### Charging the Battery

Use a USB-C cable to connect a charger to the USB-C port of the motion controller.

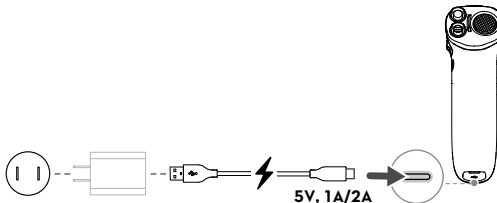

 • USB Power Delivery chargers are not supported.

#### Controlling the Camera



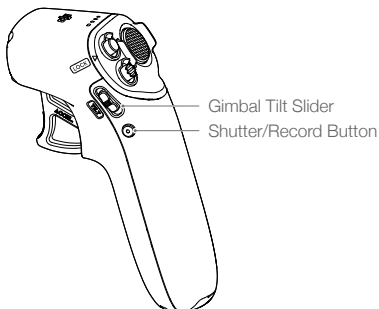

1. Shutter/Record Button: Press once to take a photo or to start or stop recording. Press and hold to switch between photo and video mode.
2. Gimbal Tilt Slider: Push up or down to adjust the tilt of the gimbal (only available before takeoff, during RTH or landing).

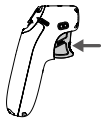
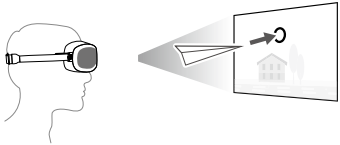

## Controlling the Aircraft

The motion controller has two modes: Normal mode and Sport mode. Normal mode is selected by default.

- ☀️ It is recommended to watch the tutorial video in the goggles before using for the first time. Go to Settings > Control > Motion Controller > Flight Control > First Flight Tutorial.
- Before using for the first time, practice flying with the motion controller using DJI Virtual Flight.

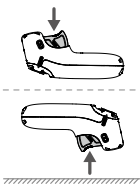
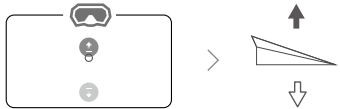
Motion Controller	Aircraft & Goggles Screen	Remarks
		<p>Press the accelerator to fly in the direction of the circle in the goggles.</p> <p>Apply more pressure to accelerate. Release to stop and hover.</p>
		<p>The orientation of the aircraft can be controlled by tilting the motion controller left and right.</p> <p>Tilt left to rotate the aircraft counterclockwise and tilt right to rotate clockwise. The aircraft hovers in place if the motion controller is vertically fixed.</p> <p>The tilt angle corresponds to the angular velocity of the rotation of the aircraft.</p> <p>The greater the tilt angle of the motion controller, the faster the aircraft will rotate.</p> <p>The circle in the goggles will move left and right and the video transmission will change accordingly.</p>
		<p>Tilt the motion controller up or down to control the tilt of the gimbal.</p> <p>The tilt of the gimbal changes with the tilt of the motion controller accordingly and is always consistent with the orientation of the motion controller.</p> <p>The circle in the goggles will move up and down and the video transmission will change accordingly.</p>
		<p>To control the ascent or descent of the aircraft, first tilt the motion controller 90° up or down. Once the circle in the goggles goes into the ascend (↑) or descend (↓) icon, press the accelerator to make the aircraft ascend or descend.</p>

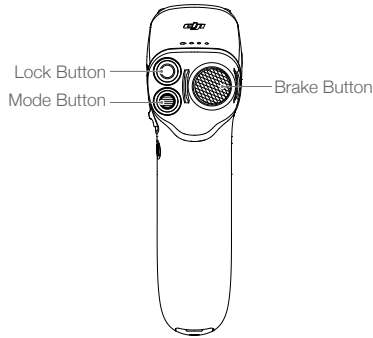

### Lock Button

Press twice to start the motors of the aircraft.

Press and hold to make the aircraft take off automatically, ascend to approximately 1.2 m, and hover.

Press and hold while the aircraft is hovering to land it automatically and stop the motors.

Press once to cancel the Low Battery RTH countdown when the prompt appears in the goggles, and the aircraft will not enter the Lower Battery RTH.



- Critical Low Battery landing cannot be canceled.
- 

### Brake Button

Press once to make the aircraft brake and hover in place. Press again to unlock the attitude.

When the aircraft is performing RTH or auto landing, press the button once to cancel RTH or landing.

Press and hold the brake button until the motion controller beeps to indicate that RTH has started. Press the button again to cancel RTH and regain control of the aircraft.

### Mode Button

Press once to switch between Normal and Sport mode. The current mode is displayed in the goggles.

### Motion Controller Alert

The motion controller sounds an alert during RTH. The alert cannot be canceled. The motion controller sounds an alert when the battery level is 6% to 15%. A low battery level alert can be canceled by pressing the power button. A critical battery level alert will sound when the battery level is less than 5% and cannot be canceled.

## Optimal Transmission Zone

The signal between the aircraft and the motion controller is most reliable when the motion controller is positioned in relation to the aircraft as shown below.

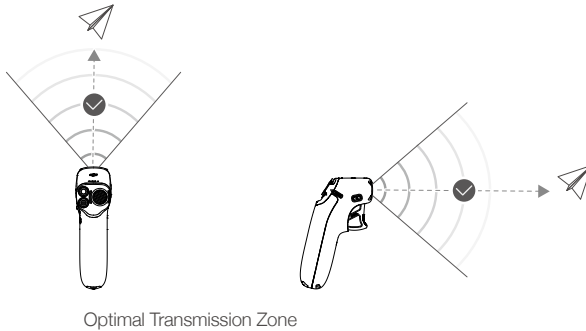

- In order to avoid interference, DO NOT use other wireless devices on the same frequency as the motion controller.
- 

## Motion Controller Calibration

The compass, IMU, and accelerator of the motion controller can be calibrated. Immediately calibrate any of the modules when prompted to do so.

On the linked goggles, go to Settings > Control > Motion Controller > Motion Controller Calibration. Select the module and follow the prompts to complete calibration.



- DO NOT calibrate your compass in locations with strong magnetic interference, such as near magnets, parking lots, or construction sites with underground reinforced concrete structures.
  - DO NOT carry ferromagnetic materials such as mobile phones during calibration.
-

## DJI FPV Remote Controller 2

Built into the DJI FPV Remote Controller 2 is DJI O3+ transmission technology, offering a maximum transmission range of 6 mi (10 km). The buttons make control of the aircraft and camera effortless while the detachable control sticks allow for the remote controller to be easily stored.

### Operation

#### Powering On/Off

Press the power button once to check the current battery level. If the battery level is too low, recharge before use. Press once then press again and hold for two seconds to power the remote controller on or off.

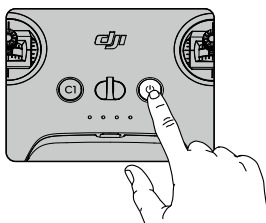

#### Charging the Battery

Use a USB-C cable to connect a charger to the USB-C port of the remote controller.

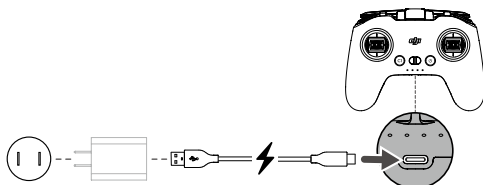

#### Controlling the Camera

1. Shutter/Record Button: Press once to take a photo or to start or stop recording. Press and hold to switch between photo and video mode.
2. Gimbal Dial: Control the tilt of the gimbal.

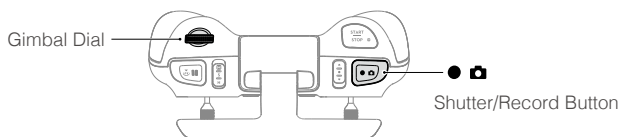

## Controlling the Aircraft

The control sticks can be operated in Mode 1, Mode 2, or Mode 3, as shown below.

### Mode 1

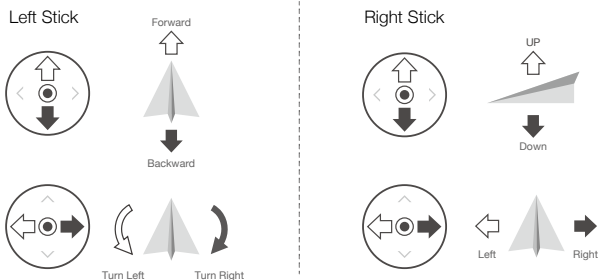

### Mode 2

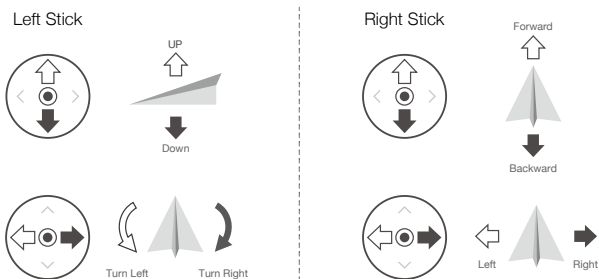



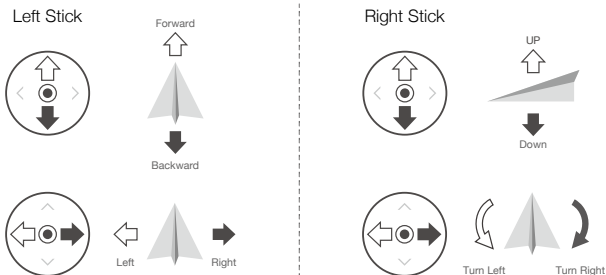



### Mode 3

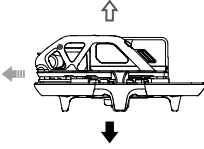

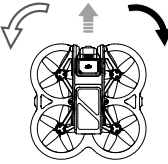
The default control mode of the remote controller is Mode 2. In this manual, Mode 2 is used as the example to illustrate how to use the control sticks.

- Stick Neutral/Center Point: Control sticks are in the center.
- Moving the control stick: Push the control stick away from the center or push the throttle stick away from the lowest position when using Manual mode.

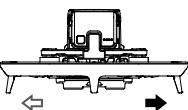
Remote Controller (Mode 2)	Aircraft (← Indicates nose direction)	Remarks
		<p>Throttle Stick: moving the left stick up or down changes the altitude of the aircraft. Push the stick up to ascend and down to descend. Push the stick gently to prevent sudden and unexpected changes in altitude.</p> <p><b>Normal/Sport mode</b> The aircraft hovers in place if the stick is in the center. Use the left stick to take off when the motors are spinning at an idle speed. The further the stick is pushed away from the center, the faster the aircraft changes elevation.</p> <p><b>Manual mode</b> The throttle stick has no center. Before flying, adjust the throttle stick to prevent it from returning to the center.</p>
		<p>Yaw Stick: moving the left stick to the left or right controls the orientation of the aircraft. Push the stick left to rotate the aircraft counterclockwise and right to rotate the aircraft clockwise. The aircraft hovers in place if the stick is in the center. The more the stick is pushed away from the center, the faster the aircraft rotates.</p>
		<p>Pitch Stick: moving the right stick up and down to change the pitch of the aircraft. Push the stick up to fly forward and down to fly backward. The aircraft hovers in place if the stick is in the center. The more the stick is pushed away from the center, the faster the aircraft moves.</p>
		<p>Roll Stick: moving the right stick to the left or right changes the roll of the aircraft. Push the stick left to fly left and right to fly right. The aircraft hovers in place if the stick is in the center. The more the stick is pushed away from the center, the faster the aircraft moves.</p>

## Flight Mode Switch

Toggle the switch to select the desired flight mode.

Position	Flight Mode
M	Manual mode
S	Sport mode
N	Normal mode

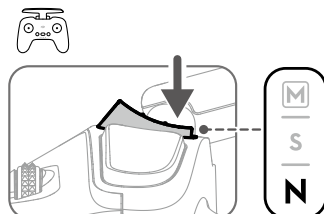



Manual mode is disabled by default. Make sure that the switch is set to Manual mode in the goggles before switching to Manual mode. The aircraft will remain in Normal or Sport mode if the switch is not set to Manual mode in the goggles. Go to Settings > Control > Remote Controller > Button Customization, and then set Custom Mode to Manual mode.

Before using Manual mode, it is recommended to tighten the F2 screw on the rear of the throttle stick so that the stick does not return to the center and adjust the F1 screw to make sure the stick resistance is suitable.

- ⚠ When using Manual mode, the aircraft has no flight assistance functions such as automatic stabilization. Before using Manual mode, practice flying in Manual mode using DJI Virtual Flight to ensure that you can fly safely.
- Only adjust the throttle stick before the aircraft takes off. DO NOT adjust during flight.

## Start/Stop Button

When using Manual mode, press twice to start or stop the motor.

When using Normal or Sport mode, press once to cancel Low Battery RTH countdown when the prompt appears in the goggles, and the aircraft will not enter the lower battery RTH.

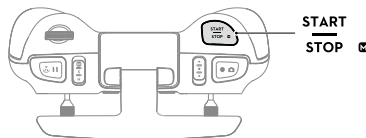

## Flight Pause/RTH Button

Press once to make the aircraft brake and hover in place. Make sure that the pitch stick and roll stick return to the center and push the throttle stick to resume control of the flight. When the aircraft is performing RTH or auto landing, press the button once to cancel RTH or landing.

When the aircraft is in Manual mode, press the button to make the aircraft brake and hover in place. The aircraft attitude returns to level and the flight mode automatically switches to Normal mode.

Press and hold the RTH button until the remote controller beeps to indicate that RTH has started. Press the button again to cancel RTH and regain control of the aircraft. Refer to the Return to Home section for more information about RTH.

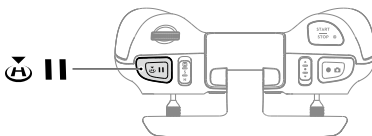

## Customizable Buttons

The functions of the customizable buttons can be set on the remote controller settings in the goggles, including the C1 button, C2 switch, and the custom mode.

The C1 button and C2 switch can be used as shortcuts for functions such as raising, lowering, or recentering the gimbal, flipping the aircraft, or enabling or disabling ESC beeping.

The custom mode can be set to Manual or Sport mode.

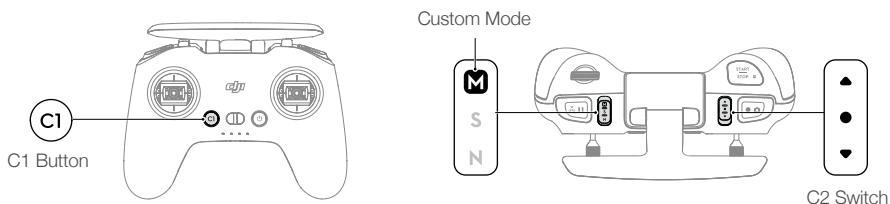

## Remote Controller Alert

The remote controller sounds an alert during RTH. The alert cannot be canceled. The remote controller sounds an alert when the battery level is 6% to 15%. A low battery level alert can be canceled by pressing the power button. A critical battery level alert will sound when the battery level is less than 5% and cannot be canceled.

## Optimal Transmission Zone

The signal between the aircraft and the remote controller is most reliable when the antennas are positioned in relation to the aircraft as shown below.

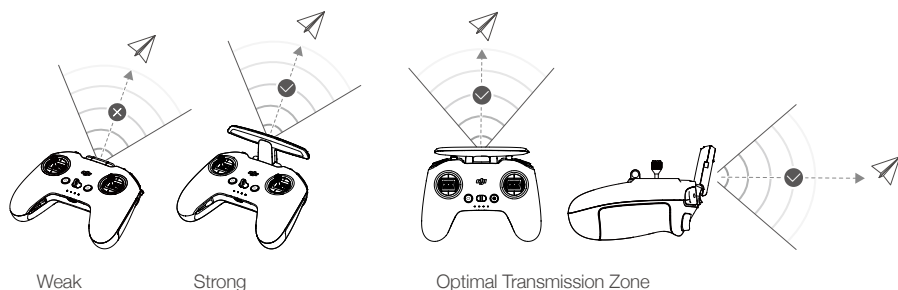

- In order to avoid interference, DO NOT use other wireless devices on the same frequency as the remote controller.

## Stick Adjustment

When using Manual mode, adjust the throttle stick based on your stick mode for a better user experience.

1. Turn the remote controller over and lift the rear rubber grip from the inside groove.

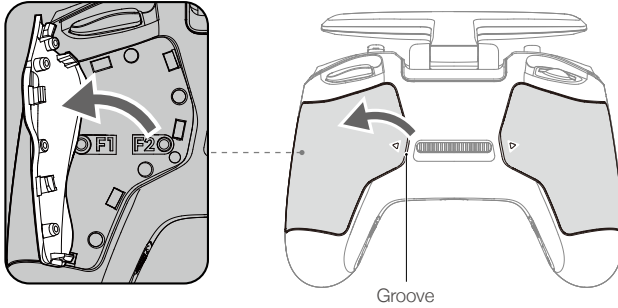

2. The screws under the grip can adjust the corresponding stick on the front of the remote controller. Use an H1.5 hex key to adjust the resistance of the stick and recenter the stick vertically. The control resistance increases when the F1 screw is tightened, and the control resistance decreases when the F1 screw is loosened. The recentering is disabled when the F2 screw is tightened, and the recentering is enabled when the F2 screw is loosened.

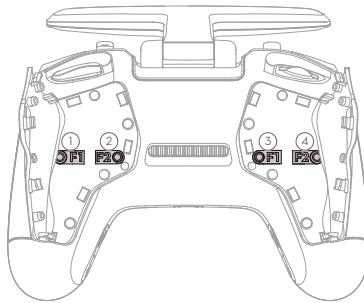

- |                                                          |                                                         |
|----------------------------------------------------------|---------------------------------------------------------|
| ① F1 Right Stick Resistance Adjustment Screw (Vertical)  | ③ F1 Left Stick Resistance Adjustment Screw (Vertical)  |
| ② F2 Right Stick Recentering Adjustment Screw (Vertical) | ④ F2 Left Stick Recentering Adjustment Screw (Vertical) |

3. Reattach the rubber grip once the adjustment is complete.

# DJI Fly App

Connect the goggles to the mobile device, launch DJI Fly, and enter the home screen. Tap GO FLY to display the video transmission, which allows you to share the FPV camera view.

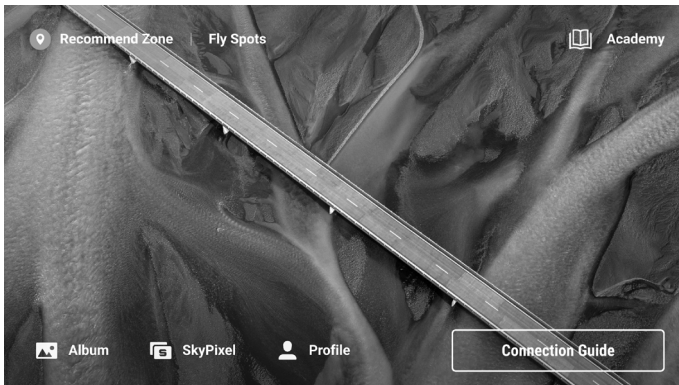

## Fly Spots

View or share nearby suitable flight and shooting locations, learn more about GEO zones, and preview aerial photos of different locations taken by other users.

## Academy

Tap the icon in the top right corner to enter Academy and view product tutorials, flight tips, flight safety notices, and manual documents.

## SkyPixel

Enter SkyPixel to view videos and photos shared by other users.

## Profile

View the account information, flight records, DJI forum, online store, Find My Drone, and other settings.



- Some countries and regions require real-time reporting of the location of the aircraft while flying. As a result, it is necessary to connect the goggles to the mobile device and run DJI Fly. Make sure to check and comply with local regulations.



- Fully charge your mobile device before launching DJI Fly.
- Mobile cellular data is required when using DJI Fly. Contact your wireless carrier for data charges.
- DO NOT accept phone calls or use texting features during flight if you are using a mobile phone as your display device.
- Read all safety prompts, warning messages, and disclaimers carefully. Familiarize yourself with relevant regulations in your area. You are solely responsible for being aware of all relevant regulations and flying in a way that is compliant.
- Use the in-app tutorial to practice your flight skills if you have never operated the aircraft or if you do not have sufficient experience to operate the aircraft with confidence.
- The app is designed to assist your operation. Use sound discretion and DO NOT rely on the app to control the aircraft. The use of the app is subject to DJI Fly Terms of Use and DJI Privacy Policy. Read them carefully in the app.

# Flight

After completing the pre-flight preparation, it is recommended to train your flying skills and practice flying safely. Make sure that all flights are carried out in an open area. The flying height is limited to 500 m. DO NOT exceed this height. Strictly abide by local laws and regulations when flying. Make sure to read the DJI Avata Safety Guidelines to understand the safety notices before flying.

## Flight Environment Requirements

1. Do not operate the aircraft in severe weather conditions including wind speeds exceeding 10.7 m/s, snow, rain, and fog.
2. Only fly in open areas. Tall buildings and large metal structures may affect the accuracy of the onboard compass and GNSS system. It is recommended to keep the aircraft at least 5 m away from structures.
3. Avoid obstacles, crowds, trees, and bodies of water (recommended height is at least 3 m above water).
4. Minimize interference by avoiding areas with high levels of electromagnetism such as locations near power lines, base stations, electrical substations, and broadcasting towers.
5. The aircraft and battery performance are limited when flying at high altitudes. Be careful when flying 16,404 ft (5,000 m) or more above sea level.
6. GNSS cannot be used on the aircraft in the polar regions. Use the vision system instead.
7. DO NOT take off from moving objects, such as cars and ships.
8. In strong winds, the vertical speed of the aircraft may be limited. Adjusting the nose of the aircraft to fly downwind can reduce power loss for a greater vertical speed.
9. When the aircraft turns at high speed or side brakes suddenly in a strong wind environment, the attitude may become unstable. Please fly with caution.
10. DO NOT use the aircraft in an environment at risk of a fire or explosion.

## Flight Restrictions

### GEO (Geospatial Environment Online) System

DJI's Geospatial Environment Online (GEO) System is a global information system that provides real-time information on flight safety and restriction updates and prevents UAVs from flying in restricted airspace. Under exceptional circumstances, restricted areas can be unlocked to allow flights in. Prior to that, the user must submit an unlocking request based on the current restriction level in the intended flight area. The GEO system may not fully comply with local laws and regulations. Users shall be responsible for their own flight safety and must consult with the local authorities on the relevant legal and regulatory requirements before requesting to unlock a flight in a restricted area. For more information about the GEO system, visit <https://www.dji.com/flysafe>.

### Flight Limits

For safety reasons, flight limits are enabled by default to help users operate this aircraft safely. Users can set flight limits on height and distance. Altitude limits, distance limits, and GEO zones function concurrently to manage flight safety when GNSS is available. Only altitude can be limited when GNSS is unavailable.

### Flight Altitude and Distance Limits

Maximum flight altitude restricts an aircraft's flight altitude, while maximum flight distance restricts an aircraft's flight radius around the Home Point. These limits can be set using the goggles for improved flight safety.

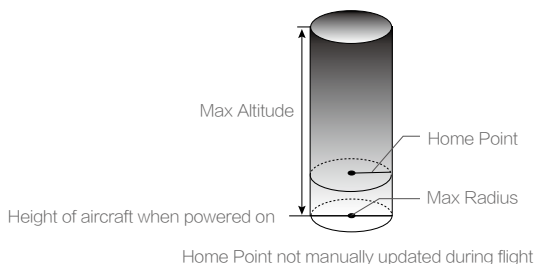

### Strong GNSS Signal

	Restriction	Goggles
Max Altitude	Aircraft's altitude cannot exceed the specified value set in goggles.	Prompt: Max flight altitude reached.
Max Radius	The straight-line distance from the aircraft to the Home Point cannot exceed the max flight distance set in goggles.	Prompt: Max flight distance reached.

### Weak GNSS Signal

	Restriction	Goggles
Max Altitude	Height is restricted to 50 m from the takeoff point if lighting is sufficient. Height is restricted to 3 m above the ground if lighting is not sufficient and the Infrared Sensing System is operating. Height is restricted to 50 m from the takeoff point if lighting is not sufficient and the Infrared Sensing System is not operating.	Prompt: Max flight altitude reached.
Max Radius	No limits	



- There will be no altitude limit if the GNSS signal becomes weak during flight as long as the GNSS signal display was white or yellow when the aircraft was powered on.
- If the aircraft reaches one of the limits, users can still control the aircraft, but cannot fly it any further. If the aircraft flies out of the max radius, it will automatically fly back within range when the GNSS signal is strong.
- For safety reasons, do not fly close to airports, highways, railway stations, railway lines, city centers, or other sensitive areas. Only fly the aircraft within visual line of sight.

### GEO Zones

DJI's GEO system designates safe flight locations, provides risk levels and safety notices for individual flights, and offers information on restricted airspace. All restricted flight areas are referred to as GEO Zones, which are further divided into Restricted Zones, Authorization Zones, Warning Zones, Enhanced Warning Zones, and Altitude Zones. Users can view such information in real-time in DJI Fly. GEO Zones are specific flight areas, including but not limited to airports, large event venues, locations where public emergencies have occurred (such as forest fires), nuclear power plants, prisons, government properties, and military facilities. By default, the GEO system limits takeoffs and flights in zones that may cause safety or security concerns. A GEO Zone map that contains comprehensive information on GEO Zones around the globe is available on the official DJI website: <https://www.dji.com/flysafe/geo-map>.

### Pre-Flight Checklist

1. Make sure the goggles battery, remote control devices, Intelligent Flight Battery, and mobile device are fully charged.
2. Make sure the propellers are mounted correctly and securely.
3. Make sure the Intelligent Flight Battery and goggles battery are properly connected and secure.
4. Make sure the USB-C port and microSD card slot cover is correctly and securely sealed.
5. Make sure the gimbal and camera are functioning normally.
6. Make sure that there is nothing obstructing the motors and that they are functioning normally.
7. Make sure that the goggles are functioning normally and display the video transmission.
8. Make sure that the gimbal protector is detached and the camera lens and the sensors are clean.
9. Make sure that the goggles antennas are installed securely and the remote controller antenna is lifted.
10. Only use genuine DJI parts or DJI authorized parts. Unauthorized parts may cause system malfunctions and compromise flight safety.

### Starting/Stopping the Motors

#### DJI Motion Controller

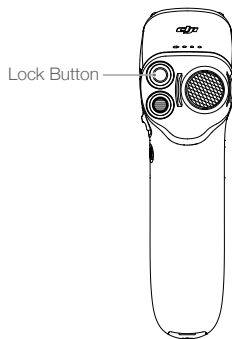

Press the lock button twice to start the motors of the aircraft.

Press and hold the lock button to make the aircraft take off automatically, ascend to approximately 1.2 m, and hover.

Press and hold the lock button while the aircraft is hovering to land it automatically and stop the motors.

## DJI FPV Remote Controller 2

### Starting the Motors

Normal/Sport mode:

A CSC is used to start the motors. Push both sticks to the inner or outer bottom corners to start the motors. Once the motors start spinning, release both sticks simultaneously.

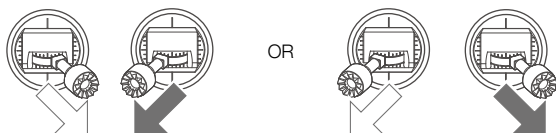

Manual mode:

Make sure the throttle stick is in the lowest position and press the start/stop button twice to start the motors.

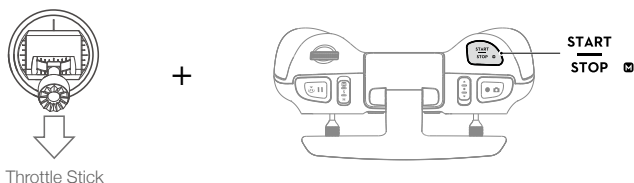

### Stopping the Motors

Normal/Sport mode:

The motors can be stopped in two ways:

Method 1: When the aircraft has landed, push the throttle stick down and hold. The motors will stop after three seconds.

Method 2: When the aircraft has landed, push the throttle stick down, and perform the same CSC used to start the motors. Release both sticks once the motors have stopped.

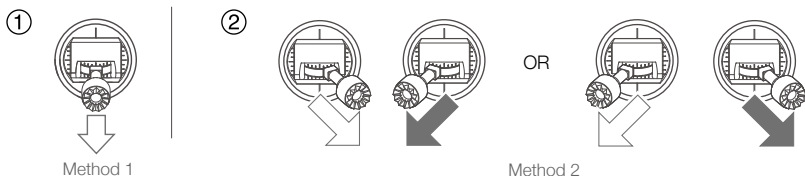

Manual mode:

Press the start/stop button twice to stop the motors once the aircraft has landed.

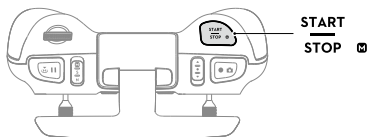



### Stopping the Motors Mid-Flight

When using Normal or Sport mode, the motors can only be stopped by pressing the lock button twice on the motion controller or performing a CSC on the remote controller mid-flight in an emergency situation such as if the aircraft has a stalled motor, is involved in a collision, is rolling in the air, is out of control, or is ascending or descending quickly. The default setting can be changed in goggles.

When using the Manual mode, press the start/stop button twice on the remote controller to stop the motors at any time.



- Stopping motors mid-flight will cause the aircraft to crash.
- 

## Flight Test

### Takeoff/Landing Procedures

1. Place the aircraft in an open, flat area with the aircraft rear facing towards you.
2. Power on the goggles, remote control device, and the aircraft.
3. Wait until the aircraft status indicator blinks green slowly to indicate that the Home Point has been recorded and put on the goggles.
4. Start the motors.
5. For DJI motion controller, press and hold the lock button, to make the aircraft take off automatically, ascend to approximately 1.2 m, and hover.  
For DJI FPV remote controller V2, gently push the throttle stick up to take off.
6. For DJI motion controller, press and hold the lock button while the aircraft is hovering to land it automatically and stop the motors.  
For DJI FPV remote controller V2, pull the throttle stick down to land the aircraft. Stop the motors after landing.
7. Power off the aircraft, goggles, and remote control device.

### Video Suggestions and Tips

1. The pre-flight checklist is designed to help you fly safely and shoot videos during flight. Go through the full pre-flight checklist before each flight.
2. Select the desired gimbal operation mode.
3. It is recommended to use Normal mode to take photos or record videos.
4. DO NOT fly in bad weather such as on rainy or windy days.
5. Choose the camera settings that best suit your needs.
6. Perform flight tests to establish flight routes and preview scenes.
7. Push the control sticks gently to ensure smooth and stable movement of the aircraft.
8. When using Manual mode, fly in an open, wide, and sparsely populated environment to ensure flight safety.



It is important to understand the basic flight guidelines, both for your protection and for the safety of those around you.

DO NOT forget to read the **safety guidelines**.

---

# Maintenance

## Aircraft

Follow the steps below to replace components of the aircraft such as the propeller guard, or upper frame.

- ⚠: • It is recommended to remove the propellers and Intelligent Flight Battery before replacing the propeller guard and upper frame.

## Propeller Guard

### Detaching

1. Flip the aircraft over, remove the two screws as shown in the figure below, then gently remove the vision module and disconnect the FPC connector. DO NOT over-extend the cable to avoid irreversible damage.

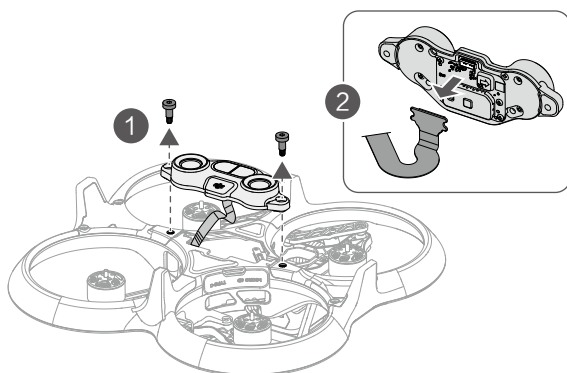

2. Remove the four screws on the landing gears, then remove the antenna covers. Pull the tab to remove the antenna board, then remove the antenna cables along the cable groove.

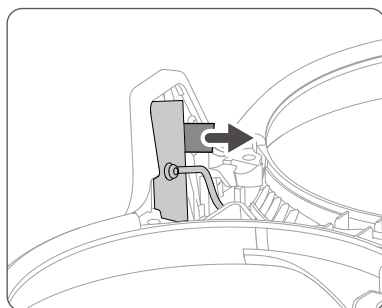
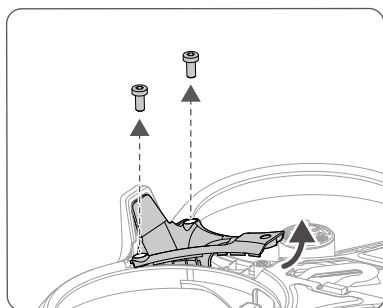

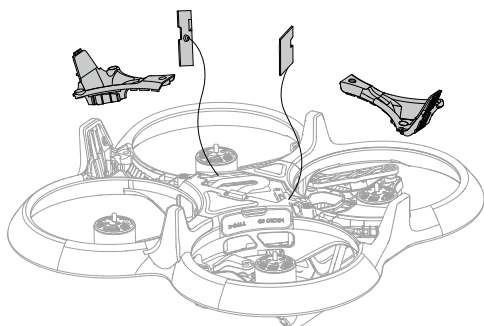

3. Remove the four screws on the bottom of the aircraft and the two screws on the top, then gently turn left and right to remove the propeller guard. Be careful not to pull out the propeller guard with force to avoid damaging the cables.

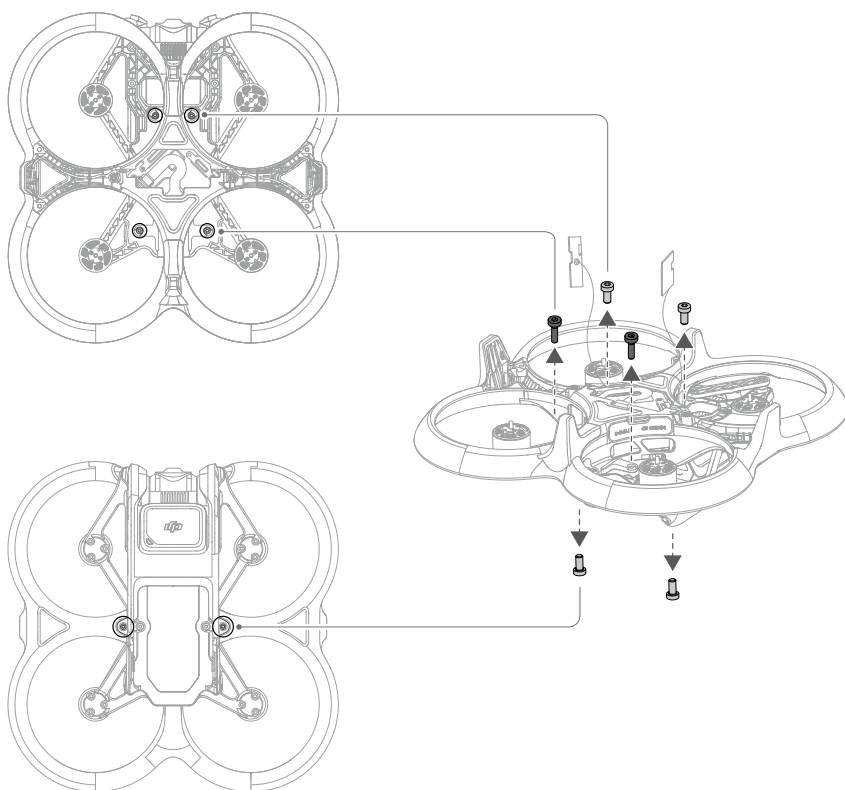

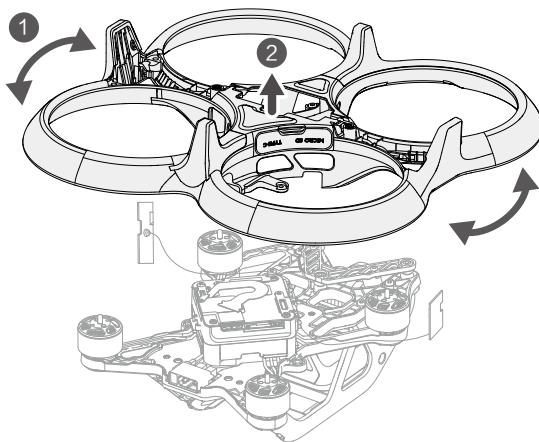

## Attaching

1. Fix the antenna cables in the cable slot on the side of the center module to avoid damaging the cables.

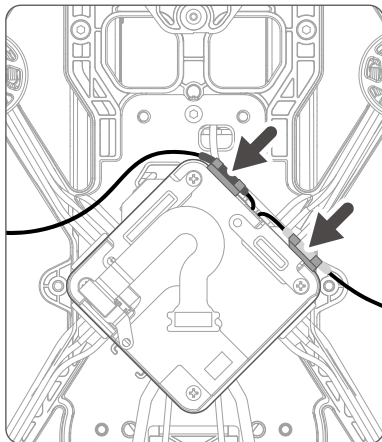

2. Prepare a new propeller guard and pass the two antenna boards through the hole in the center of the propeller guard. Adjust the propeller guard so that the square groove at the rear aligns with the battery port.

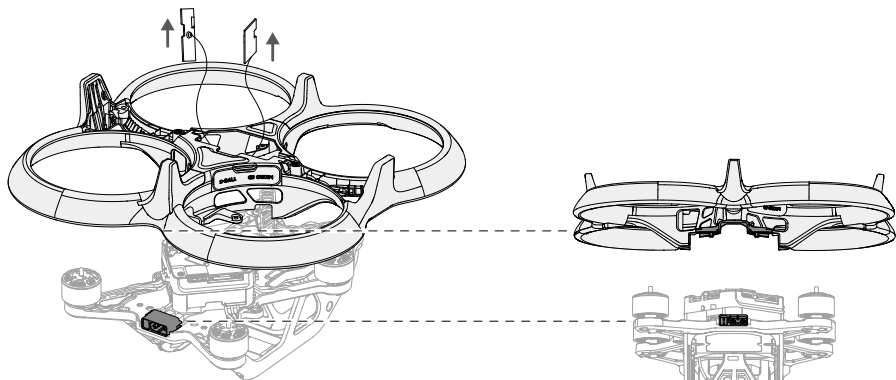

3. When installing, slowly tilt and press the side with the USB-C port and microSD card slot cover first, be careful not to catch the antenna cable on this side, then gently turn the propeller guard left and right to secure the other side.

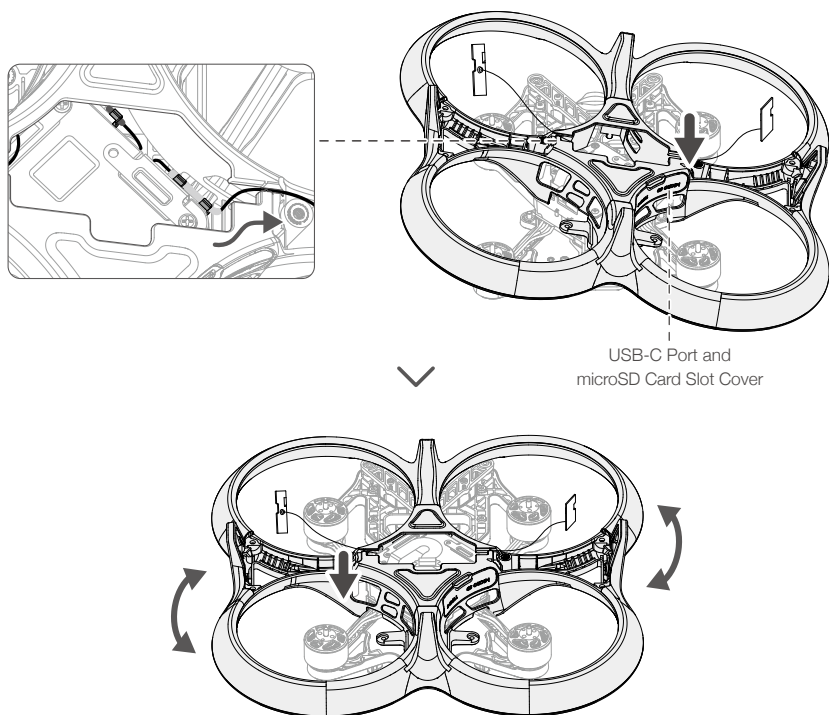

4. Check the L and R marks on the antenna board and the inside of the propeller guard, and install the antenna board on the corresponding landing gear. Tilting the antenna board to make it fit tightly into the slot on the inner side of the landing gear and then arranging the antenna cable to fix it in the cable groove.

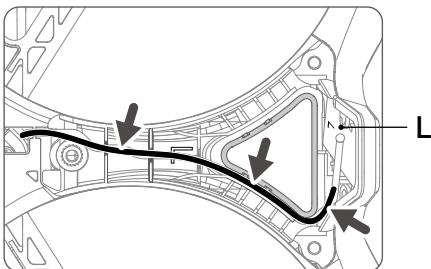
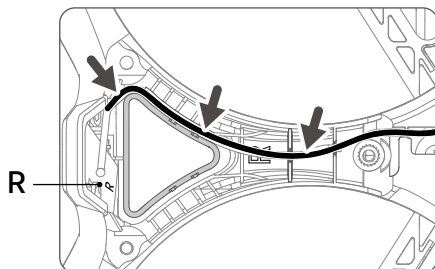
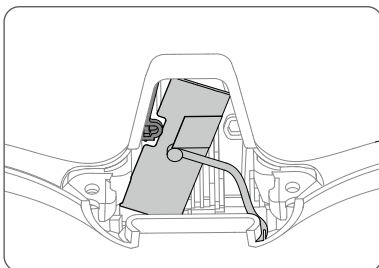
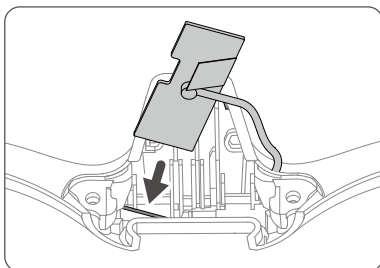

5. Tighten the two M2×4.3 screws and the two M1.6×5 screws on the bottom of the aircraft in turn, and then the two M2×4.3 screws on the top. (Note that the two M1.6×5 screws on the rear side of the bottom are relatively longer).

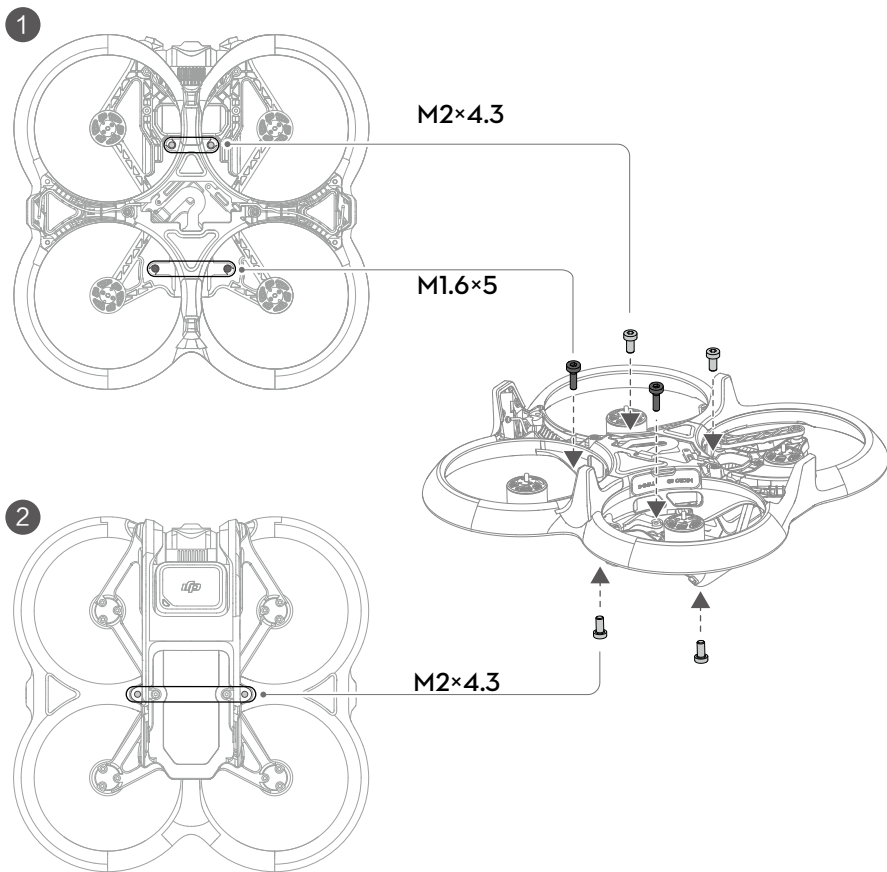

6. Insert the end of the antenna cover into the landing gear, press the antenna cover to fit the propeller guard, and then tighten the four M2×4.3 screws. Make sure that the antennas and antenna covers on both sides are firmly installed.

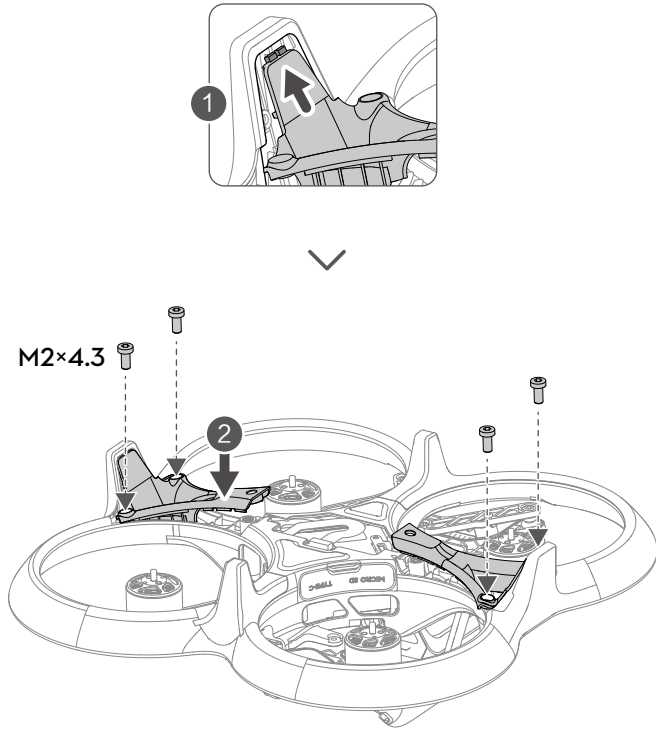



7. Check the shape of the vision module and the position of the opening in the center of the propeller guard, and then connect the FPC cable to the vision module correctly. After ensuring that the FPC cable is completely placed inside the propeller guard, tighten the two M2×6.3 screws to complete the installation.

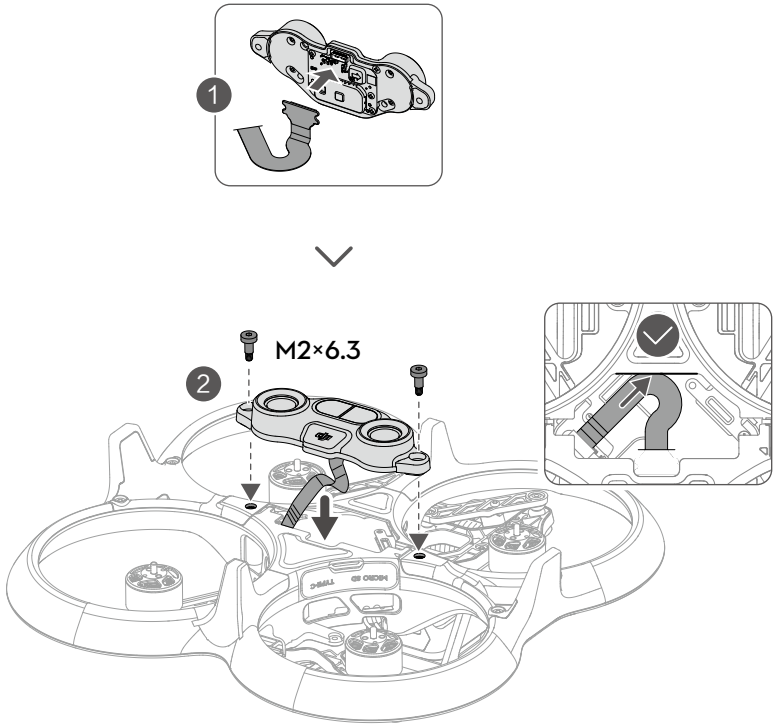

- Check to make sure the USB-C port and microSD card slot cover is correctly and securely sealed to avoid contact with the propellers.

## Upper Frame

### Detaching

1. Remove the two screws on both sides of the upper frame.

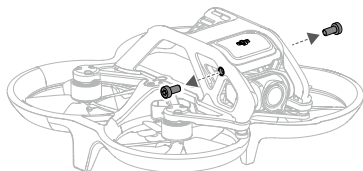

2. Flip the aircraft over, remove the six screws as shown in the figure below, then remove the upper frame. Remove the upper frame gently to avoid damaging the GNSS module above.

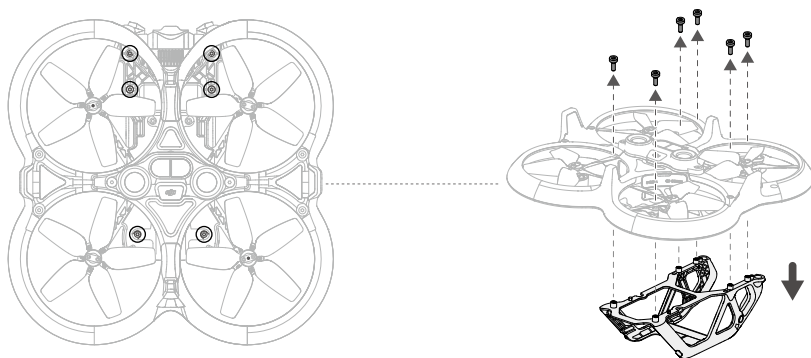

### Attaching

1. Prepare a new upper frame and install it on the top of the aircraft. Make sure to align the corresponding holes and that the gimbal and camera cable is in the groove to avoid damage.

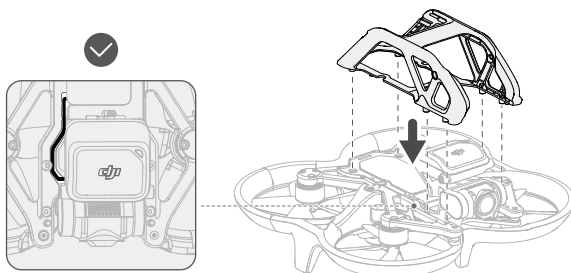

- Adjust the position of the GNSS module so that the screw holes on the module are aligned with the screw holes on both sides of the upper frame, then tighten the two M2×4.3 screws.

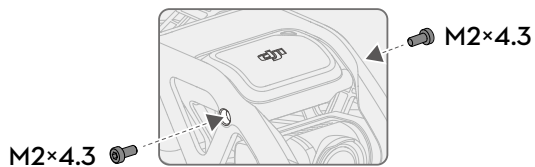
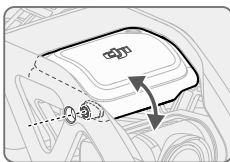

- Tighten the six M1.6×5 screws on the bottom to complete the installation.

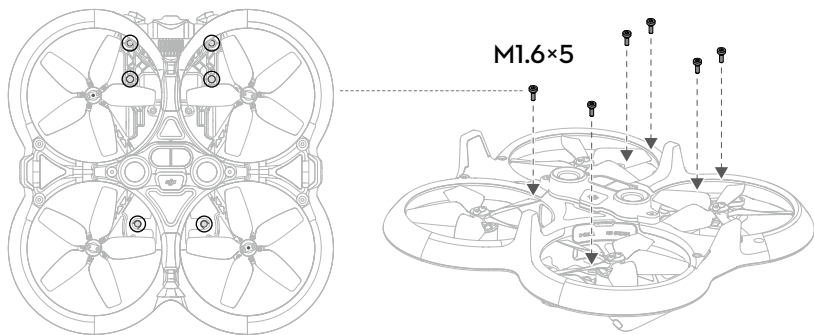

## Goggles

### DJI Goggles 2

#### Replacing the Antennas

If an antenna is damaged, you can contact DJI after-sales to purchase a new one for replacement.

To remove the antenna, hold the bottom of the antenna and pull it upwards.

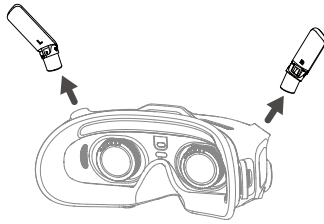

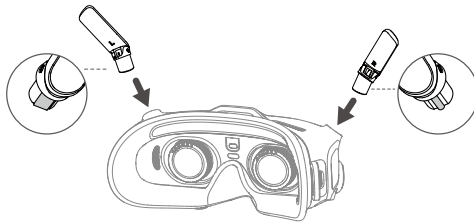

When installing, distinguish the left and right antennas and make sure the antenna is properly aligned with the port.

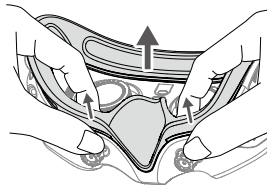

#### Replacing the Foam Padding

1. Hold the bottom of the foam padding and remove it gently as shown below.



-  • DO NOT pull the sides when removing the foam padding. Otherwise, the padding may be damaged.

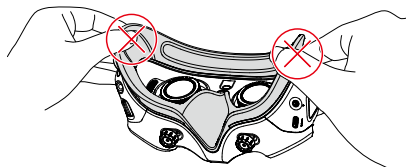

2. Align the positioning columns of the new foam padding with the positioning holes on the goggles, install it and press the left and right sides. After hearing a "click", check and make sure that there is no gap between the foam padding and the goggles.

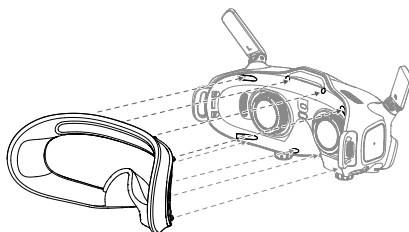

### Cleaning and Maintenance of the Lenses

Use a piece of soft, dry, and clean cloth to wipe in a circular motion from the center to the outer edges of each lens.

Re-attach the screen protector to protect the lenses when the goggles are not in use.

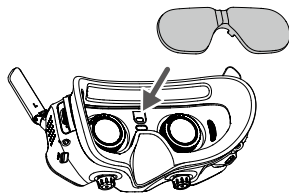

-  • Make sure to disconnect the goggles from the power outlet before cleaning and make sure that no cables are connected.
- DO NOT clean the lenses with alcohol.
  - The lenses are delicate. Clean them gently. DO NOT scratch them as this will affect viewing quality.
  - Store the goggles in a dry place at room temperature to avoid damage to the lenses and other optical components from high temperatures and humid environments.
  - Keep the lenses away from direct sunlight to avoid screen damage.

## DJI FPV Goggles V2

### Cleaning

Make sure to disconnect the goggles from the power outlet before cleaning and make sure that there are no cables connected.

Clean the surface of the goggles with a soft, dry, clean cloth. To clean the foam padding, moisten the cloth with clean water and wipe the foam padding.

### Replacing the Foam Padding

The foam padding is attached to the goggles with Velcro. When replacing the foam padding, peel it gradually from the left or right side. Align the new foam padding with the goggles and press the foam padding down so it is securely attached.

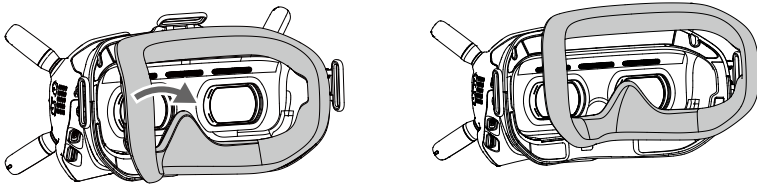

### Maintenance of Lenses

Use a cleaning cloth to wipe the lenses gently.

1. Moisten the cleaning cloth with alcohol or a lens cleaner.
2. Wipe in a circular motion from the center to the outer edges of the lenses.



- DO NOT clean the foam padding with alcohol.
  - The lenses are delicate. Clean them gently. DO NOT scratch them as this will affect viewing quality.
  - Store the goggles in a dry room at room temperature to avoid damage to the lenses from high temperature and humid environments.
-

# Appendix

## Specifications

### DJI Avata

Aircraft	
Model	QF2W4K
Takeoff Weight	Approx. 410 g
Dimensions (LxWxH)	180x80x80 mm
Diagonal Distance	120 mm
Max Ascent Speed	6 m/s (Normal/Sport mode)
Max Descent Speed	6 m/s (Normal/Sport mode)
Max Horizontal Speed (near sea level, no wind)	8 m/s (Normal mode) 14 m/s (Sport mode) 27 m/s (Manual mode)
Max Service Ceiling Above Sea Level	5000 m
Max Hover Time	Approx. 18 mins
Max Flight Distance	11.6 km
Max Wind Speed Resistance	10.7 m/s
Operating Temperature	-10° to 40° C (14° to 104° F)
GNSS	GPS + Galileo + BeiDou
Hovering accuracy range	Vertical: ±0.1 m (with Vision Positioning), ±0.5 m (with GNSS Positioning) Horizontal: ±0.3 m (with Vision Positioning), ±1.5 m (with GNSS Positioning)
Antennas	Dual Antennas, 2T2R
Internal Storage	20 GB
Supported DJI Goggles	DJI Goggles 2 DJI FPV Goggles V2 DJI Goggles Integra
Supported DJI Remote Controller Devices	DJI FPV Remote Controller 2 DJI Motion Controller DJI RC Motion 2
Transmission	
Operating Frequency	2.400-2.4835 GHz (Rx) 5.725-5.850 GHz (Tx/Rx)
Transmitter Power (EIRP)	5.8 GHz: <33 dBm (FCC), <14 dBm (CE), <30 dBm (SRRC)
Communication Bandwidth	Max 40 MHz
Live View Modes and Latency	With DJI Goggles 2 1080p/100fps: The lowest transmission latency is 30 ms 1080p/60fps: The lowest transmission latency is 40 ms With DJI FPV Goggles V2 810p/120fps: The lowest transmission latency is lower 28 ms 810p/60fps: The lowest transmission latency is lower than 40 ms
Max Video Bitrate	50 Mbps
Max Transmission Range	10 km (FCC), 2 km (CE), 6 km (SRRC)
Audio Transmission	No

<b>Gimbal</b>	
Mechanical Range	Tilt: -95° to +75°
Controllable Rotating Range	Tilt: -80° to +65°
Stabilization	Single-axis (tilt)
Max Control Speed	60°/s
Angular vibration range	±0.01° (Normal mode)
Electronic Roll Axis	Live view correction not supported, supports video correction
<b>Sensing System</b>	
Downward Vision System	Infrared Sensor Measurement Range: 10 m Precision Measurement Range: 0.5-10 m Effective Measurement Range: 0.5-20 m
Operating Environment	Non-reflective, discernible surfaces with diffuse reflectivity of >20% Adequate lighting of lux >15
<b>Camera</b>	
Image Sensor	1/1.7" CMOS, Effective Pixels: 12 MP
Lens	FOV: 155° Equivalent Focal Length: 12.7 mm Actual Focal Length: 2.34 mm Aperture: f/2.8 Focus Mode: Fixed focus Focus Range: 0.6 m to ∞
ISO Range	100-6400 (auto) 100-25600 (manual)
Shutter speed	1/8000-1/50 s (photo) 1/8000-1/50 s (video)
Still Photography Modes	Single shot
Max Photo Size	4000×3000
Photo Format	JPEG
Video Resolution	4K@30/50/60fps 2.7K@30/50/60/100/120fps 1080p@30/50/60/100/120fps
Video format	MP4
Max Video Bitrate	150 Mbps
Color Profiles	Standard, D-Cinelike
RockSteady EIS	Supported (Off, RockSteady, HorizonSteady)
Distortion Correction	Supported (Standard, Wide-Angle, Super Wide Angle)
Supported File System	exFAT (recommend) FAT32
<b>Intelligent Flight Battery</b>	
Capacity	2420 mAh
Standard Voltage	14.76 V
Max Charging Voltage	17 V
Battery Type	Li-ion
Chemical System	LiNiMnCoO <sub>2</sub>
Energy	35.71 Wh@0.5C
Discharge Rate	7C (typical)
Weight	Approx. 162 g
Charging Temperature	5° to 40° C (41° to 104° F)



**SD Cards**

Supported microSD Cards	microSD card, UHS-I Speed Grade 3 SanDisk Extreme 32GB U3 V30 A1 microSDXC SanDisk Extreme Pro 32GB U3 V30 A1 microSDXC
Recommended microSD Cards	Kingston Canvas Go!Plus 64GB U3 V30 A2 microSDXC Kingston Canvas React Plus 64GB U3 V90 A1 microSDXC Kingston Canvas React Plus 128GB U3 V90 A1 microSDXC Kingston Canvas React Plus 256GB U3 V90 A1 microSDXC Samsung PRO Plus 256GB V30 U3 V30 A2 microSDXC



- DJI Avata dissipates heat by using the airflow of the propellers to prevent the aircraft from overheating. When the aircraft is in standby mode for a long time, the temperature may rise. In this situation, the built-in temperature control system can detect the current temperature and will power off the aircraft automatically to prevent overheating. The general standby time periods of the aircraft in the stationary state are as follows. If these times are exceeded, the aircraft may automatically power off to prevent overheating (tested in an indoor environment with an ambient temperature of 25°C).
    - a. When in standby mode on the ground: about 21 minutes;
    - b. When updating firmware: about 18 minutes (please update within 10 minutes of powering on the aircraft, otherwise the update may fail due to overheating);
    - c. When connecting to the computer using the USB-C port, the aircraft will not overheat and can be used for longer.
  - These specifications have been determined through tests conducted with the latest firmware. Firmware updates can enhance performance. It is highly recommended to update to the latest firmware.
-

## DJI Goggles 2

<b>Goggles</b>	
Model	RCDS18
Weight	Approx. 290 g (with headband)
Dimensions	167.4×103.9×81.31 mm (antenna folded) 196.69×103.9×104.61 mm (antenna unfolded)
Screen Size (single screen)	0.49 inch
Resolution (single screen)	1920×1080
Screen Refresh Rate	Max. 100 Hz
FOV	51°
IPD Range	56-72 mm
Diopter Range	+2.0 D to -8.0 D
<b>Transmission</b>	
Operating Frequency	2.400-2.4835 GHz, 5.725-5.850 GHz
Transmitter Power (EIRP)	2.4 GHz: <30 dBm (FCC), <20 dBm (CE/SRRC/MIC/KC) 5.8 GHz: <30 dBm (FCC), <23 dBm (SRRC), <14 dBm (CE/KC)
<b>Wi-Fi</b>	
Protocol	Wi-Fi 802.11b/a/g/n/ac
Operating Frequency	2.400-2.4835 GHz 5.150-5.250 GHz (indoor use only) 5.725-5.850 GHz
Transmitter Power (EIRP)	2.4 GHz: <20 dBm (FCC/CE/SRRC/MIC/KC) 5.1 GHz: <20 dBm (FCC/CE/MIC/KC) 5.8 GHz: <20 dBm (FCC/SRRC/KC), <14 dBm (CE)
<b>Bluetooth</b>	
Protocol	Bluetooth 5.2
Operating Frequency	2.400-2.4835 GHz
Transmitter Power (EIRP)	<8 dBm
Max Video Bitrate	50 Mbps
Supported Video Recording Format	MOV
Supported Video Playback Format	MP4, MOV (Video format: H.264, H.265; Audio format: ACC, PCM)
Wi-Fi Wireless Streaming	DLNA
Operating Temperature	-10° to 40° C (14° to 104° F)
Power Input	DJI Goggles 2 Battery
Supported microSD Cards	microSD Card, max 256 GB
<b>DJI Goggles 2 Battery</b>	
Weight	Approx. 122 g
Dimension	73.04×40.96×26 mm
Capacity	1800 mAh
Voltage	7-9 V = 1.5 A
Battery Type	Li-ion
Chemical System	LiNiMnCoO2
Energy	18 Wh
Charging Temperature	0° to 45° C (32° to 113° F)
Max Charging Power	12.6 W (5 V = 2 A / 9 V = 1.4 A)
Operating Time	Around 2 hours

## DJI FPV Goggles V2

<b>Goggles</b>	
Model	FGDB28
Weight	Approx. 420 g (incl. headband and antennas)
Dimensions	184×122×110 mm (excl. antennas) 202×126×110 mm (incl. antennas)
Screen Size	2-inch
Screen Resolution (Single Screen)	1440×810
Screen Refresh Rate	144 Hz
FOV	30° to 54°; Image size: 50-100%
IPD Range	58-70 mm
Operating Frequency	2.400-2.4835 GHz, 5.725-5.850 GHz
Transmitter Power (EIRP)	2.4 GHz: ≤28.5 dBm (FCC), ≤20 dBm (CE/SRRC/MIC) 5.8 GHz: ≤31.5 dBm (FCC), ≤19 dBm (SRRC), ≤14 dBm (CE)
Communication Bandwidth	Max 40 MHz
Max Video Bitrate	50 Mbps
Supported Video Recording Format	MOV (Video format: H.264)
Supported Video Playback Format	MP4, MOV, MKV (Video format: H.264; Audio format: AAC-LC, AAC-HE, AC-3, MP3)
Operating Temperature	0° to 40° C (32° to 104° F)
Power Input	DJI FPV Goggles Battery
Supported microSD Cards	microSD Card, max 256 GB
<b>DJI FPV Goggles Battery</b>	
Weight	Approx. 119 g
Dimension	73.04×40.96×26 mm
Capacity	1800 mAh
Voltage	Max 9 V
Battery Type	LiPo 2S
Chemical System	LiNiMnCoO <sub>2</sub>
Energy	18 Wh
Charging Temperature	0° to 45° C (32° to 113° F)
Max Charging Power	10 W
Operating Time	Approx. 1 hour and 50 minutes

## DJI Motion Controller

Model	FC7BMC
Weight	Approx. 167 g
Operating Frequency	2.400-2.4835 GHz, 5.725-5.850 GHz
Transmitter Power (EIRP)	2.4 GHz: ≤28.5 dBm (FCC), ≤20 dBm (CE/SRRC/MIC) 5.8 GHz: ≤31.5 dBm (FCC), ≤19 dBm (SRRC), ≤14 dBm (CE)
Operating Temperature	-10° to 40° C (14° to 104° F)
Operating Time	Approx. 5 hours

## DJI FPV Remote Controller 2

Model	FC7BGC
Weight	Approx. 346 g
Dimensions	190×140×51 mm
Operating Frequency	2.400-2.4835 GHz, 5.725-5.850 GHz
Transmitter Power (EIRP)	2.4 GHz: ≤28.5 dBm (FCC), ≤20 dBm (CE/SRRC/MIC) 5.8 GHz: ≤31.5 dBm (FCC), ≤19 dBm (SRRC), ≤14 dBm (CE)
Operating Temperature	-10° to 40° C (14° to 104° F)
Charging Time	2 hours and 30 minutes
Operating Time	Approx. 9 hours

### Firmware Update

Use one of the following methods to update the firmware:

1. Use the DJI Fly App to update the firmware for the entire set of devices including the aircraft, goggles, and remote control device.
2. Use DJI Assistant 2 (Consumer Drones Series) to update the firmware for a single device.

#### Using DJI Fly

Power on the aircraft, goggles, and remote control device. Make sure all the devices are linked. Connect the USB-C port of the goggles to the mobile device, run DJI Fly, and follow the prompt to update. An internet connection is required.

#### Using DJI Assistant 2 (Consumer Drones Series)

1. Power on the device and connect it to a computer with a USB-C cable.
2. Launch DJI Assistant 2 (Consumer Drones Series) and log in with a DJI account.
3. Select the device and click "Firmware Update" on the left side of the screen.
4. Select the firmware version.
5. The firmware will be downloaded and updated automatically.
6. The device will restart automatically after the firmware update is complete.



- Make sure to follow all the steps to update the firmware, otherwise the update may fail.
  - The firmware update will take several minutes. When updating the firmware, it is normal for the gimbal to go limp, and the aircraft to reboot. Wait until the update is complete.
  - Make sure the computer is connected to the internet during the update.
  - Make sure that the device has sufficient power before updating the firmware.
  - Do not unplug the USB-C cable during an update.
  - If there are any additional batteries that needs to be updated after the update is complete, insert it into the aircraft and power on the aircraft. A prompt will appear in the goggles to update the battery. Make sure to update the battery before takeoff.
  - Note that the update may reset various flight parameters such as the RTH altitude and the maximum flight distance. Before updating, take note of your preferred settings and readjust them after the update.
- 

### Aftersales Information

Visit <https://www.dji.com/support> to learn more about aftersales service policies, repair services, and support.

## FAR Remote ID Compliance Information

The aircraft complies with the requirements of 14 CFR Part 89:

- The aircraft automatically broadcasts Remote ID messages from takeoff to shut down. An external device such as a cell phone or tablet is required to be connected as a location source to DJI mobile devices without an integrated GNSS system <sup>[1]</sup>, and must run the DJI flight control app such as DJI Fly in the foreground and always allow the DJI flight control app to obtain its accurate location information. The connected external device must minimally be one of the following:
  - 1) FCC Certified personal wireless device that uses GPS with SBAS (WAAS) for location services; or
  - 2) FCC Certified personal wireless device with integrated GNSS.Also, the external device must be operated in a way that does not interfere with the location reported and its correlation to the operator location.
- The aircraft automatically initiates a pre-flight self-test (PFST) of the Remote ID system before takeoff and cannot take off if it does not pass the PFST <sup>[2]</sup>. The results of the PFST of the Remote ID system can be viewed in either a DJI flight control app such as DJI Fly or DJI goggles.
- The aircraft monitors the Remote ID system functionality from pre-flight to shut down. If the Remote ID system malfunctions or has a failure, an alarm will be displayed in either a DJI flight control app such as DJI Fly or DJI goggles.

### Footnotes

- [1] DJI mobile devices without an integrated GNSS system such as DJI RC-N1, DJI FPV Goggles V2, and DJI Goggles 2.
- [2] The pass criterion for PFST is that the hardware and software of the Remote ID required-data source and transmitter radio in the Remote ID system are functioning properly.



Contact  
DJI SUPPORT

<https://www.dji.com/support>

This content is subject to change.

**Download the latest version from**  
<https://www.dji.com/avata>

If you have any questions about this document, please contact  
DJI by sending a message to **DocSupport@dji.com**.

DJI and DJI AVATA are trademarks of DJI.  
Copyright © 2023 DJI All Rights Reserved.