

EN More Information

FR Informations supplémentaires

IT Ulteriori informazioni

DE Weitere Informationen

ES Más información

PT Mais informações



www.xerox.com/office/VLC500support
www.xerox.com/office/VLC600support
www.xerox.com/msds (U.S./Canada)
www.xerox.com/environment_europe
www.xerox.com/office/VLC500supplies
www.xerox.com/office/VLC600supplies
www.xerox.com/office/businessresourcecenter

EN Before operating your printer, read the safety and regulatory chapters in the *User Guide* available on Xerox.com, or the *Safety, Regulatory, Recycling, and Disposal Reference Guide* on the *Software and Documentation* disc.

Material Safety Data Sheets (US/Canada) and environmental information (Europe) are available online.

FR Avant d'utiliser votre imprimante, lisez les chapitres relatifs à la sécurité et aux réglementations du *Guide de l'utilisateur* disponible sur Xerox.com ou le *Guide de référence sur la sécurité, la réglementation, le recyclage et la mise au rebut* sur le CD-ROM *Software and Documentation* (Logiciel et documentation).

La *Fiche de données de sécurité du matériel* (États-Unis/Canada) et les informations de protection de l'environnement (Europe) sont disponibles en ligne.

IT Prima di utilizzare la stampante, leggere i capitoli relativi alla normativa e alla sicurezza nella *Guida per l'utente* disponibile su Xerox.com oppure la *Guida relativa a sicurezza, normativa, riciclaggio e smaltimento* sul disco *Software and Documentation* (Software e documentazione).

Material Safety Data Sheets (USA/Canada) e informazioni ambientali (Europa) sono disponibili online.

DE Vor der Inbetriebnahme des Druckers die Kapitel zu Sicherheit und gesetzlichen Bestimmungen im *Benutzerhandbuch* unter Xerox.com bzw. die *Referenzhandbuch zu Sicherheit, gesetzlichen Bestimmungen, Recycling und Entsorgung* auf der *Software and Documentation* disc (Datenträger mit Software und Dokumentation) lesen.

Material Safety Data Sheets (USA/Kanada) und Umweltinformationen (Europa) sind online verfügbar.

ES Antes de utilizar la impresora, lea los capítulos sobre seguridad y normativas en la *Guía del usuario* disponible en Xerox.com, o bien, la *Guía de referencia de seguridad, normativa, reciclaje y eliminación de productos* en el disco de *Software and Documentation* (Software y documentación).

Las *Material Safety Data Sheets* (EE.UU./Canadá) y la información medioambiental (Europa) están disponibles online.

PT Antes de operar a impressora, leia os capítulos sobre segurança e regulamentação no *Guia do usuário* disponível em Xerox.com ou o *Guia de referência sobre segurança, regulamentação, reciclagem e descarte* no *Software and Documentation* disc (CD de software e documentação). (Software e Documentação).

As *Material Safety Data Sheets* (EUA/Canadá) e informações ambientais (Europa) estão disponíveis on-line.

www.xerox.com/office/VLC500supplies
www.xerox.com/office/VLC600supplies

- EN** Printer supplies
- FR** Consommables pour l'imprimante
- IT** Materiali di consumo della stampante
- DE** Druckerverbrauchsmaterial
- ES** Suministros de la impresora
- PT** Suprimentos da impressora

www.xerox.com/office/businessresourcecenter

- EN** Templates, tips, and tutorials
- FR** Modèles, conseils et didacticiels
- IT** Modelli, suggerimenti ed esercitazioni
- DE** Profile, Tipps und Lehrgänge
- ES** Plantillas, consejos y lecciones prácticas
- PT** Modelos, dicas e tutoriais

Xerox® VersaLink® C500/C600

Color Printer • Imprimante couleur • Stampante a colori • Farbdrucker • Impresora de color • Impressora em cores •

Quick Use Guide Guide d'utilisation rapide

- IT** Italiano Guida rapida per l'utente
- DE** Deutsch Kurzübersicht
- ES** Español Guía de uso rápido
- PT** Português Guia de utilização rápida



EN Printer Tour

FR Tour d'horizon de l'imprimante

IT Panoramica della stampante

DE Drucker im Überblick

ES Recorrido por la impresora

PT Roteiro da impressora

EN Bypass Tray
FR Départ manuel
IT Vassoio bypass
DE Zusatzzufuhr
ES Bandeja especial
PT Bandeja manual

EN Trays 1-5
FR Magasins 1-5
IT Vassoi 1-5
DE Behälter 1-5
ES Bandejas 1-5
PT Bandejas 1 e 5

EN Toner Cartridges
FR Cartouches de toner
IT Cartucce toner
DE Tonerpatronen
ES Cartuchos de tóner
PT Cartuchos de toner

EN Drum Cartridges
FR Modules photorécepteurs
IT Cartucce fotoricettore
DE Trommeleinheiten
ES Cartuchos de cilindro
PT Cartuchos do fotorreceptor

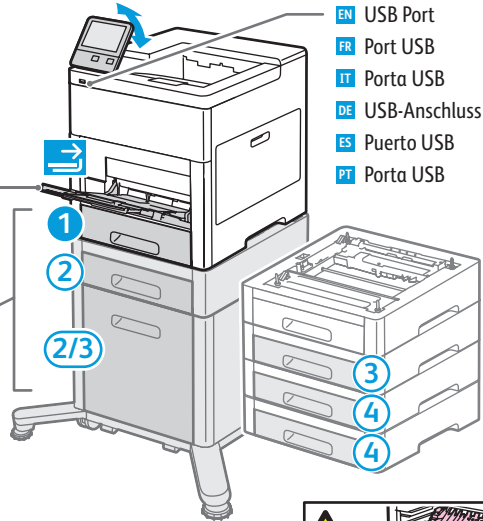

EN USB Port
FR Port USB
IT Porta USB
DE USB-Anschluss
ES Puerto USB
PT Porta USB

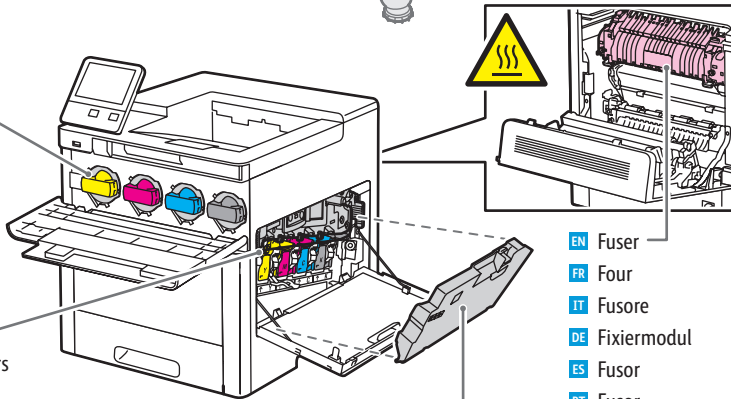

EN Fuser
FR Four
IT Fusore
DE Fixiermodul
ES Fusor
PT Fusor

EN Waste Cartridge
FR Bac de récupération
IT Contenitore residui
DE Sammelbehälter
ES Cartucho de residuos
PT Cartucho de resíduos

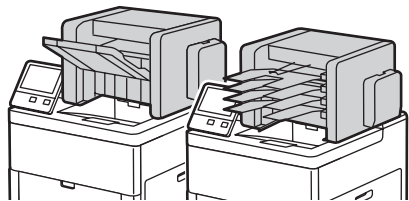

EN Finisher and Mailbox available for VersaLink® C600 Color Printer only.
FR Module de finition et Boîte aux lettres disponibles pour l'imprimante couleur VersaLink® C600 uniquement.
IT Stazione di finitura e mailbox disponibili solo per la stampante a colori VersaLink® C600.
DE Finisher und Mailbox nur für VersaLink® C600 Farbdrucker verfügbar.
ES Acabadora y buzón disponibles para impresora de color VersaLink® C600 solamente.
PT Somente Módulo de acabamento e Caixa postal disponíveis para Impressora em cores VersaLink® C600.

www.xerox.com/office/VLC500support
www.xerox.com/office/VLC600support

EN Control Panel

FR Panneau de commande

IT Pannello comandi

DE Steuerpult

ES Panel de control

PT Painel de controle



1
EN Log in for special access.
FR Connexion pour accès spécial.
IT Login per accesso speciale.
DE Für Sonderzugriff anmelden.
ES Conexión para acceso especial.
PT Faça login para acesso especial.

3
EN Home returns to the main app screen.
FR Page d'accueil pour revenir à l'écran principal de l'application.
IT Home page riporta alla schermata principale dell'app.
DE Mit „Home“ wird das App-Hauptfenster angezeigt.
ES Principal vuelve a la pantalla principal de aplicaciones.
PT Retornar à tela principal do aplicativo.

5
EN The Device app provides access to printer information and settings.
FR L'application du périphérique donne accès aux paramètres et informations de l'imprimante.
IT Annulla la cancellazione delle impostazioni per tutte le app.
DE Geräte-App bietet Zugriff auf Druckerdaten und -einstellungen.
ES La aplicación Dispositivo proporciona acceso a la información y los ajustes de la impresora.
PT O aplicativo Dispositivo fornece acesso às informações e configurações da impressora.

6
EN NFC allows pairing with a mobile device to print from an app.
FR NFC permet de coupler un appareil mobile pour imprimer à partir d'une appli.
IT NFC consente l'associazione a un dispositivo mobile per effettuare stampe da un'app.
DE NFC ermöglicht Kopplung mit einem Mobilgerät zum Drucken aus einer App.
ES NFC permite el emparejamiento con dispositivos móviles para imprimir desde una aplicación.
PT O NFC permite o emparelhamento com um dispositivo móvel para impressão a partir de um aplicativo.

7
EN Status LED indicates printer status.
FR Le voyant d'état indique l'état de l'imprimante.
IT Il LED di stato indica lo stato della stampante.
DE Status-LED gibt Druckerstatus an.
ES El LED de estado indica el estado de la impresora.
PT O LED de status indica o status da impressora.

2
EN Reset clears settings.
FR Réinitialiser pour effacer les paramètres.
IT L'opzione Ripristina azzerà le impostazioni.
DE „Zurücksetzen“ löscht Einstellungen.
ES Restaurar borra los ajustes.
PT Reinicializar limpa as configurações.

4
EN Power/Wake
FR Mise sous tension/Réveil
IT Alimentazione/Riattivazione
DE Betrieb/Aktivieren
ES Encendido/activación
PT Energia/Despertar

EN Supported Paper
FR Papier pris en charge
IT Carta supportata
DE Unterstütztes Material
ES Papeles admitidos
PT Papel compatível

- EN** Bypass Tray
- FR** Départ manuel
- IT** Vassoio bypass
- DE** Zusatzzufuhr
- ES** Bandeja especial
- PT** Bandeja manual

- EN** Trays 1–5
- FR** Magasins 1-5
- IT** Vassoi 1–5
- DE** Behälter 1–5
- ES** Bandejas 1-5
- PT** Bandejas 1 e 5

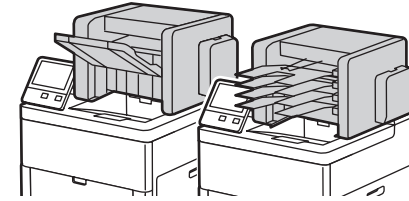
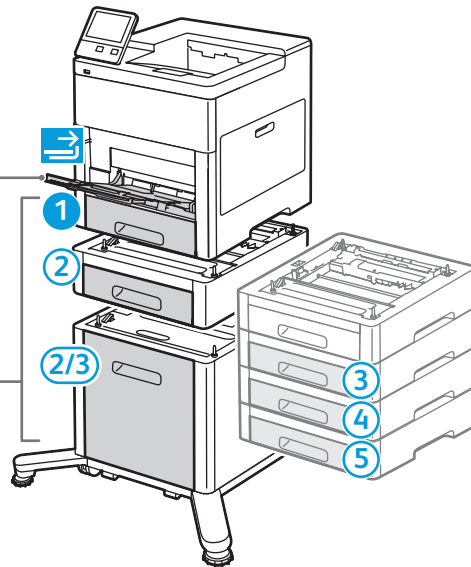

VersaLink® C600

60–80 g/m²
(16–20 lb. Bond)

- EN** Recycled
- FR** Recyclé
- IT** Riciclata
- DE** Umweltpapier
- ES** Reciclado
- PT** Reciclado



60–220 g/m²
(16 lb. Bond–80 lb. Cover)

- Executive*** 7.25 x 10.5 in.
- Letter*** 8.5 x 11 in.
- Legal*** 8.5 x 14 in.
- B5 ISO*** 176 x 250 mm
- A4*** 210 x 297 mm

60–90 g/m²
(20–24 lb. Bond)

- EN** Custom 1
- FR** Personnalisé 1
- IT** Personalizzata 1
- DE** Benutzerdefiniert 1
- ES** Personalizado 1
- PT** Personalizado 1

75–105 g/m²
(20–28 lb. Bond)

- EN** Plain
- FR** Standard
- IT** Standard
- DE** Normalpapier
- ES** Común
- PT** Comum

106–176 g/m²
(28 lb. Bond–65 lb. Cover)

- EN** Lightweight Cardstock
- FR** Support cartonné fin
- IT** Cartoncino leggero
- DE** Leichtkarton
- ES** Cartulina ligera
- PT** Cartão de baixa gramatura

177–220 g/m²
(65–80 lb. Cover)

- EN** Cardstock
- FR** Carte
- IT** Cartoncino
- DE** Karton
- ES** Cartulina para tarjeta
- PT** Cartão



60–220 g/m²
(16 lb. Bond–80 lb. Cover)

- 4 x 6** 4 x 6 in.
- 5 x 7** 5 x 7 in.
- Statement*** 5.5 x 8.5 in.
- Executive*** 7.25 x 10.5 in.
- 8 x 10*** 8 x 10 in.
- Letter*** 8.5 x 11 in.
- Folio*** 8.5 x 13 in.
- Legal*** 8.5 x 14 in.

- A6** 105 x 148 mm
- A5*** 148 x 210 mm
- A4*** 210 x 297 mm
- B5 ISO*** 176 x 250 mm
- 215 x 315*** 215 x 315 mm

- Monarch** 3.9 x 7.5 in.
- #10** 4.12 x 9.5 in.
- DL** 110 x 220 mm
- C5** 162 x 229 mm



60–220 g/m²
(16 lb. Bond–80 lb. Cover)

- Executive*** 7.25 x 10.5 in.
- Letter*** 8.5 x 11 in.
- Folio*** 8.5 x 13 in.
- Legal*** 8.5 x 14 in.

- A5*** 148 x 210 mm
- A4*** 210 x 297 mm
- B5 ISO*** 176 x 250 mm



60–176 g/m²
(16 lb. Bond–65 lb. Cover)

- Letter*** 8.5 x 11 in.
- A4*** 210 x 297 mm



***60–176 g/m²**
(16 lb. Bond–65 lb. Cover)



- EN** Custom Size
- FR** Format personnalisé
- IT** Formato personalizzato
- DE** Benutzerdefiniert
- ES** Tamaño personalizado
- PT** Tamanho Personalizado

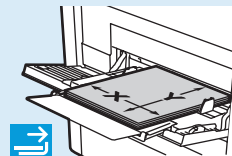

- X:** 76–216 mm (3–8.5 in.)
- Y:** 127–356 mm (5–14 in.)

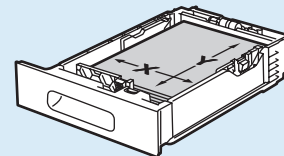

- X:** 76–216 mm (3–8.5 in.)
- Y:** 148–356 mm (7.5–14 in.)



- X:** 140–216 mm (5.5–8.5 in.)
- Y:** 203–356 mm (8–14 in.)

www.xerox.com/rmlna (U.S./Canada)
www.xerox.com/rmlcu

www.xerox.com/office/VLC500support
www.xerox.com/office/VLC600support

EN Supported Paper
FR Papier pris en charge
IT Carta supportata
DE Unterstütztes Material
ES Papeles admitidos
PT Papel compatível

- EN** Bypass Tray
- FR** Départ manuel
- IT** Vassoio bypass
- DE** Zusatzzufuhr
- ES** Bandeja especial
- PT** Bandeja manual

- EN** Trays 1–5
- FR** Magasins 1-5
- IT** Vassoi 1–5
- DE** Behälter 1–5
- ES** Bandejas 1-5
- PT** Bandejas 1 e 5

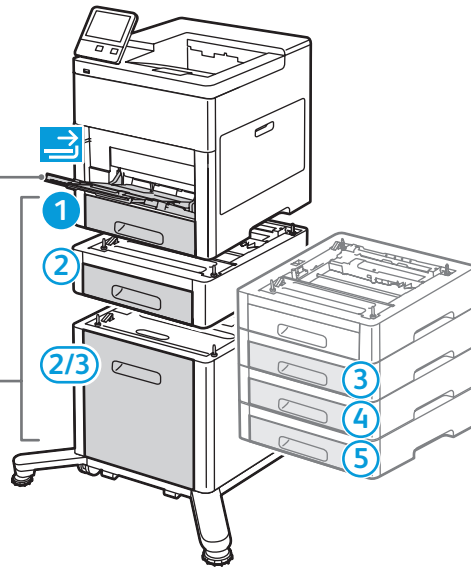

 **60–220 g/m²**
(16 lb. Bond–80 lb. Cover)





- 4 x 6 4 x 6 in.
- 5 x 7 5 x 7 in.
- Statement* 5.5 x 8.5 in.
- Executive* 7.25 x 10.5 in.
- 8 x 10* 8 x 10 in.
- Letter* 8.5 x 11 in.
- Folio* 8.5 x 13 in.
- Legal* 8.5 x 14 in.

- A6 105 x 148 mm
- A5* 148 x 210 mm
- A4* 210 x 297 mm
- B5 ISO* 176 x 250 mm
- 215 x 315* 215 x 315 mm

- Monarch 3.9 x 7.5 in.
- #10 4.12 x 9.5 in.
- DL 110 x 220 mm
- C5 162 x 229 mm



 www.xerox.com/rmlna (U.S./Canada)
www.xerox.com/rmleu

     **60–220 g/m²**
(16 lb. Bond–80 lb. Cover)

- Executive* 7.25 x 10.5 in.
- Letter* 8.5 x 11 in.
- Folio* 8.5 x 13 in.
- Legal* 8.5 x 14 in.

- A5* 148 x 210 mm
- A4* 210 x 297 mm
- B5 ISO* 176 x 250 mm

 **60–176 g/m²**
(16 lb. Bond–65 lb. Cover)

- Letter* 8.5 x 11 in.
- A4* 210 x 297 mm

 ***60–176 g/m²**
(16 lb. Bond–65 lb. Cover)

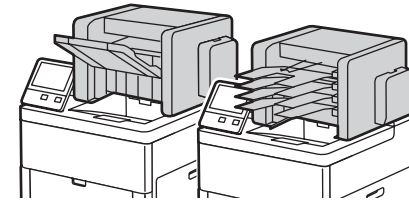

VersaLink® C600

 **60–220 g/m²**
(16 lb. Bond–80 lb. Cover)



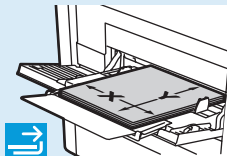

- Executive* 7.25 x 10.5 in.
- Letter* 8.5 x 11 in.
- Legal* 8.5 x 14 in.
- B5 ISO* 176 x 250 mm
- A4* 210 x 297 mm

-  **EN** Custom Size
FR Format personnalisé
IT Formato personalizzato
DE Benutzerdefiniert
ES Tamaño personalizado
PT Tamanho Personalizado

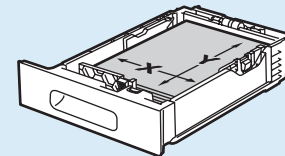

X: 76–216 mm (3–8.5 in.)
Y: 127–356 mm (5–14 in.)



     **X:** 76–216 mm (3–8.5 in.)
Y: 148–356 mm (7.5–14 in.)

 **X:** 140–216 mm (5.5–8.5 in.)
Y: 203–356 mm (8–14 in.)

60–80 g/m²
(16–20 lb. Bond)

- EN** Recycled
- FR** Recyclé
- IT** Riciclata
- DE** Umweltpapier
- ES** Reciclado
- PT** Reciclado

60–90 g/m²
(20–24 lb. Bond)

- EN** Custom 1
- FR** Personnalisé 1
- IT** Personalizzata 1
- DE** Benutzerdefiniert 1
- ES** Personalizado 1
- PT** Personalizado 1

75–105 g/m²
(20–28 lb. Bond)

- EN** Plain
- FR** Standard
- IT** Standard
- DE** Normalpapier
- ES** Común
- PT** Comum

106–176 g/m²
(28 lb. Bond–65 lb. Cover)

- EN** Lightweight Cardstock
- FR** Support cartonné fin
- IT** Cartoncino leggero
- DE** Leichtkarton
- ES** Cartulina ligera
- PT** Cartão de baixa gramatura

177–220 g/m²
(65–80 lb. Cover)

- EN** Cardstock
- FR** Carte
- IT** Cartoncino
- DE** Karton
- ES** Cartulina para tarjeta
- PT** Cartão

EN Paper Jams

FR Incidents papier

IT Inceppamenti carta

DE Materialstaus

ES Atascos de papel

PT Atolamentos de Papel

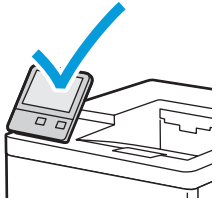

EN When a jam occurs, the control panel displays graphics showing how to clear the jam.



www.xerox.com/office/VLC500docs

www.xerox.com/office/VLC600docs

For tips on avoiding paper jams, refer to the *User Guide*.

FR Lorsqu'un incident se produit, le panneau de commande affiche un schéma indiquant comment résoudre l'incident.

Reportez-vous au *Guide de l'utilisateur* pour savoir comment éviter les incidents papier.

IT Quando si verifica un inceppamento di carta, sul pannello comandi viene visualizzata un'immagine su come eliminare l'inceppamento.

Per suggerimenti su come evitare gli inceppamenti, fare riferimento alla *Guida per l'utente*.

DE Bei einem Stau werden am Steuerpult Grafiken angezeigt, die die Staubeseitigung erläutern.

Tipps zur Vermeidung von Papierstaus siehe *Benutzerhandbuch*.

ES Cuando se produce un atasco, el panel de control muestra ilustraciones que indican cómo eliminar el atasco.

Para obtener consejos para evitar atascos de papel, consulte la *Guía del usuario*.

PT Quando ocorre um atolamento, o painel de controle exhibe gráficos mostrando como eliminar o atolamento.

Para dicas sobre como evitar atolamentos de papel, consulte o *Guia do usuário*.

EN Xerox App Gallery

FR Xerox App Gallery

IT Xerox App Gallery

DE Xerox App Gallery

ES Xerox App Gallery

PT Xerox App Gallery



www.xerox.com/appgallery

EN The Xerox® App Gallery has a growing collection of productivity apps that you can install on your printer. Find the app on your home screen and create your login directly, or go to www.xerox.com/appgallery to log in and add your device. To simplify app installation, use the same name for your app gallery login credentials that you used for the printer login.

FR Xerox® App Gallery comprend une collection croissante d'applications de productivité que vous pouvez installer sur votre imprimante. Recherchez l'appli sur votre écran d'accueil et créez directement votre connexion ou accédez à www.xerox.com/appgallery pour vous connecter et ajouter votre périphérique. Pour simplifier l'installation des applis, utilisez votre nom de connexion à l'imprimante dans vos informations de connexion à la galerie d'applis.

IT La Xerox® App Gallery contiene una sempre crescente raccolta di app per la produttività che è possibile installare sulla propria stampante. Trovare l'app sulla schermata principale e creare il proprio ID di accesso direttamente, oppure andare su www.xerox.com/appgallery per accedere e aggiungere il proprio dispositivo. Per semplificare l'installazione delle app, utilizzare lo stesso nome per le credenziali di accesso alla app gallery di quello utilizzato per accedere alla stampante.

DE Die Xerox® App Gallery umfasst eine wachsende Sammlung von Produktivitäts-Apps, die auf dem Drucker installiert werden können. Die App auf der Startseite suchen und eine Anmeldung direkt erstellen oder unter www.xerox.com/appgallery anmelden und das Gerät hinzufügen. Zum Vereinfachen der App-Installation für die Anmeldung bei der App Gallery und beim Drucker den gleichen Benutzernamen verwenden.

ES En Xerox® App Gallery encontrará una amplia colección de aplicaciones de productividad que podrá instalar en su impresora. Busque la aplicación en la pantalla principal y cree su acceso directo o vaya a www.xerox.com/appgallery para conectarse y agregar su dispositivo. Para simplificar la instalación de la aplicación, como identidad de conexión de la galería de aplicaciones utilice el mismo nombre que utilizó para conectarse a la impresora.

PT O Xerox® App Gallery possui uma crescente coleção de aplicativos de produtividade que podem ser instalados na impressora. Localize o aplicativo em sua tela inicial e crie o login diretamente ou acesse www.xerox.com/appgallery para login e adicione em seu dispositivo. Para simplificar a instalação do aplicativo, use o mesmo nome que você usou para login na impressora como suas credenciais de login na galeria do aplicativo.