

Operation Manual

Smart-UPS[™] X Uninterruptible Power Supply

Low Voltage 100-127 VA

SMX2000RMLV2U
SMX2200RMLV2U
SMX3000RMLV2U
SMX3000RMLV2UNC
SMX3000RMJ2U

High Voltage 200-240 VA

SMX2200RMHV2U
SMX3000RMHV2U
SMX3000RMHV2UNC

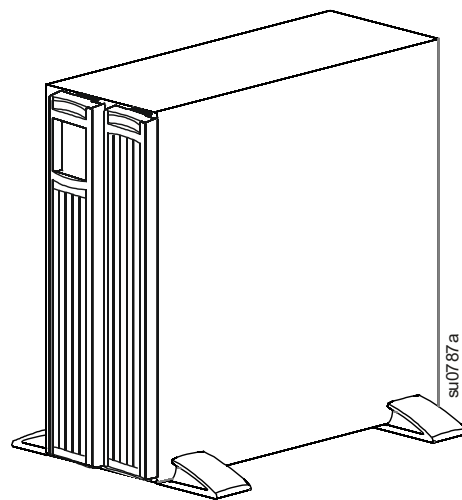

For Professional Business Applications – Not For Consumer Use

Important Safety Messages

SAVE THESE INSTRUCTIONS - This manual contains important instructions that should be followed during installation and maintenance of the Smart-UPS and batteries.

Read these instructions carefully and look at the equipment to become familiar with the device before trying to install, operate, service or maintain it. The following special messages may appear throughout this document or on the equipment to warn of potential hazards or to call attention to information that clarifies or simplifies a procedure.



The addition of this symbol either to a “Danger” or “Warning” safety label indicates that an electrical hazard exists which will result in personal injury if the instructions are not followed.



This is the safety alert symbol. It is used to alert you to potential personal injury hazards. Obey all safety messages that follow this symbol to avoid possible injury or death.

DANGER

DANGER indicates a hazardous situation which, if not avoided, will result in death or serious injury.

WARNING

WARNING indicates a hazardous situation which, if not avoided, could result in death or serious injury.

CAUTION

CAUTION indicates a hazardous situation which, if not avoided, could result in minor or moderate injury.

NOTICE

NOTICE is used to address practices not related to physical injury.

Product Handling Guidelines

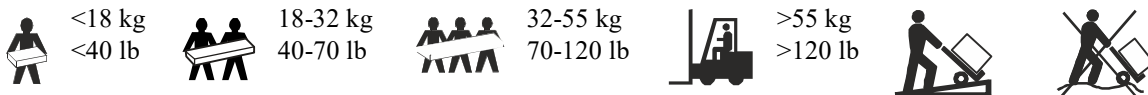

Safety and General Information

Inspect the package contents upon receipt. Notify the carrier and dealer if there is any damage.

Read the Safety Guide supplied with this unit before installing the UPS.

- Adhere to all local and national electrical codes.
- This UPS is intended for indoor use only.
- Do not operate this UPS in direct sunlight, in contact with fluids, or where there is excessive dust or humidity.
- Be sure the air vents on the UPS are not blocked. Allow adequate space for proper ventilation.

- For a UPS with a factory installed power cord, connect the UPS power cable directly to a wall outlet. Do not use surge protectors or extension cords.
- The battery typically lasts for two to five years. Environmental factors impact battery life. Elevated ambient temperatures, poor quality utility power, and frequent short duration discharges will shorten battery life.
- The batteries are heavy. Remove the batteries before installing the UPS and external battery packs (XLBPs), in a rack.
- Always install external battery packs (XLBPs) at the bottom of the rack. The UPS must be installed above the XLBPs.
- The UPS display interface will recognize as many as 10 external battery packs connected to the UPS.

Product Description

The APC by Schneider Electric Smart-UPS™ is a high performance uninterruptible power supply (UPS). The UPS provides protection for electronic equipment from utility power blackouts, brownouts, sags, and surges, small utility power fluctuations and large disturbances. The UPS also provides battery backup power for connected equipment until utility power returns to specified levels or the batteries are fully discharged.

This user manual is available on the enclosed CD and on the APC by Schneider Electric Web site, www.apc.com.

Battery

CAUTION

RISK OF HYDROGEN SULPHIDE GAS AND EXCESSIVE SMOKE

- Replace the battery at least every 5 years or at the end of its service life, whichever is earlier.
- Replace the battery immediately when the UPS indicates battery replacement is necessary.
- Replace batteries with the same number and type of batteries as originally installed in the equipment.
- Replace the battery immediately when the UPS indicates a battery overtemperature condition, or when there is evidence of electrolyte leakage. Power off the UPS, unplug it from the AC input, and disconnect the batteries. Do not operate the UPS until the batteries have been replaced.
- *Replace all battery modules (including the modules in External Battery Packs) which are older than one year, when installing additional battery packs or replacing the battery module(s).

Failure to follow these instructions could result in equipment damage and minor or moderate injury.

*Contact APC by Schneider Electric Worldwide Customer Support to determine the age of the installed battery modules.

- Servicing of batteries should be performed or supervised by personnel knowledgeable of batteries and the required precautions. Keep unauthorized personnel away from batteries.
- CAUTION – Do not dispose of battery or batteries in a fire. The battery may explode.
- CAUTION – Do not open or mutilate the battery or batteries. Released electrolyte is harmful to the skin and eyes. It may be toxic.
- CAUTION - Before replacing batteries, remove conductive jewelry such as chains, wrist watches, and rings. High energy through conductive materials could cause severe burns.
- CAUTION - Failed batteries can reach temperatures that exceed the burn thresholds for touchable surfaces.
- CAUTION – A battery can present a risk of electrical shock and high short circuit current. The following precautions should be observed when working on batteries:
 - Disconnect the charging source prior to connecting or disconnecting battery terminals.
 - Do not wear any metal objects including watches and rings.

- Do not lay tools or metal parts on top of batteries.
- Use tools with insulated handles.
- Wear rubber gloves and boots.
- Determine if battery is either intentionally or inadvertently grounded. Contact with any part of a grounded battery can result in electric shock and burns by high short-circuit current. The risk of such hazards can be reduced if grounds are removed during installation and maintenance by a skilled person.

Product Overview

Specifications

Environmental Specifications

For additional specifications, refer to the APC by Schneider Electric Web site at www.apc.com.

Temperature	Operating	0° to 40° C (32° to 104° F)
	Storage	-15° to 45° C (5° to 113° F) Charge UPS battery every six months
Maximum Elevation	Operating	3,000 m (10,000 ft)
	Storage	15,000 m (50,000 ft)
Humidity		0% to 95% relative humidity, non-condensing
International Protection Code		IP20
Pollution degree		2
Overvoltage category		II
Applicable power grid power distribution system		TN Power System
Applicable standard		IEC 62040-1

High and Low Voltage Models

Low Voltage (100-127 V)	High Voltage (200-240 V)
SMX2000RMLV2U	SMX2200RMHV2U
SMX2200RMLV2U	SMX3000RMHV2U
SMX3000RMLV2U	SMX3000RMHV2UNC
SMX3000RMLV2UNC	
SMX3000RMJ2U	

Front Panel Features

- ❶ Battery
- ❷ Battery connector
- ❸ Display interface
- ❹ Bezel

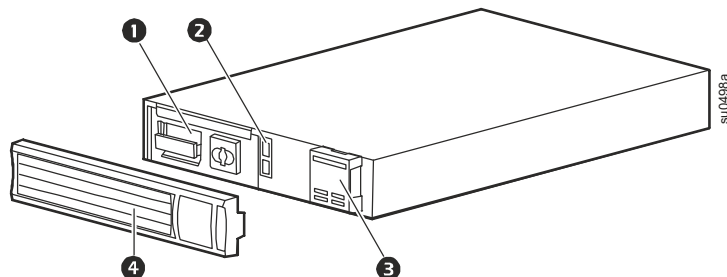

Rear Panel Features

- ❶ SmartSlot
- ❷ UPS input
- ❸ Chassis ground screw
- ❹ Controllable Outlet Group 1
- ❺ Controllable Outlet Group 2
- ❻ Controllable Outlet Group 3
- ❼ External battery pack connector
- ❽ EPO connector
- ❾ Serial port
- ❿ USB port

2200 VA Low Voltage

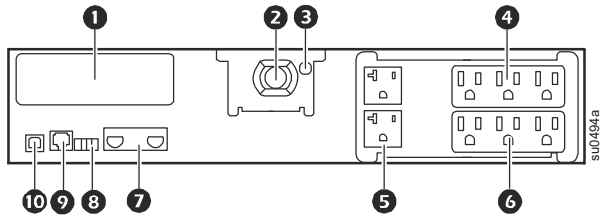

2000 VA Low Voltage

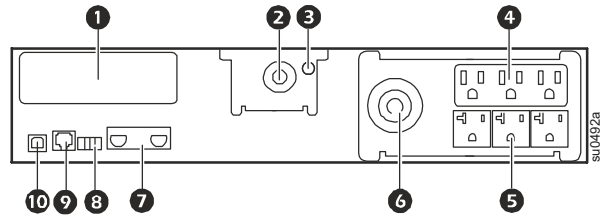

3000 VA Low Voltage

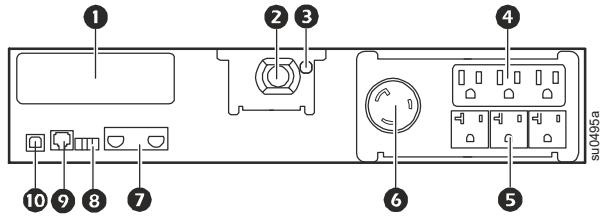

2200/3000 VA High Voltage

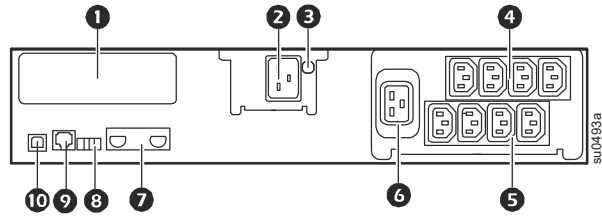

Installation

UPS

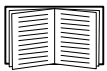

For UPS installation information, refer to the Smart-UPS X 2000-3000 VA Installation Guide that is included with the UPS. The guide is also available on the enclosed CD and the APC by Schneider Electric Web site at www.apc.com.

Network Management Card

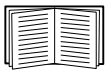

For installation information, refer to the user manual provided with the Network Management Card (NMC). The user manual is also available on the APC by Schneider Electric Web site at www.apc.com.

External Battery Pack

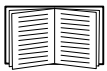

For installation information, refer to the SMX 120RMBP2U external battery pack Installation Guide that is included with the external battery pack (XLBP). The guide is also available on the enclosed CD and the APC by Schneider Electric Web site at www.apc.com.

FCC Warning

This equipment has been tested and found to comply with the limits for a Class A digital device, pursuant to part 15 of the FCC Rules. These limits are designed to provide reasonable protection against harmful interference when the equipment is operated in a commercial environment. This equipment generates, uses, and can radiate radio frequency energy and, if not installed and used in accordance with the instruction manual, may cause harmful interference to radio communications. Operation of this equipment in a residential area is likely to cause harmful interference in which case the user will be required to correct the interference at his own expense.

Radio frequency warning

WARNING: This is a category C2 UPS product. In a residential environment, this product may cause radio interference, in which case the user may be required to take additional measures.

Operation

Connect Equipment to the UPS

⚠ CAUTION

RISK OF ELECTRIC SHOCK

- Adhere to all local and national electrical codes.
- Wiring should be performed by qualified electrician.
- Always connect the UPS to a grounded outlet.

Failure to follow these instructions could result in minor or moderate injury.

Note: The UPS will charge to 90% capacity in the first three hours of normal operation. **Do not expect full battery runtime capability during this initial charge period.**

1. Connect equipment to the outlets on the rear panel of the UPS.
2. Connect the UPS to the building utility power.
Always connect the UPS to a two pole, three wire, grounded source.
3. To use the UPS as a master ON/OFF switch, turn on all the equipment that is connected to the UPS.
4. Press the ON/OFF button on the front panel of the UPS to turn on the UPS and all connected equipment.
5. See “Switched Outlet Groups” on page 11 for information on how to use the switched outlet groups.

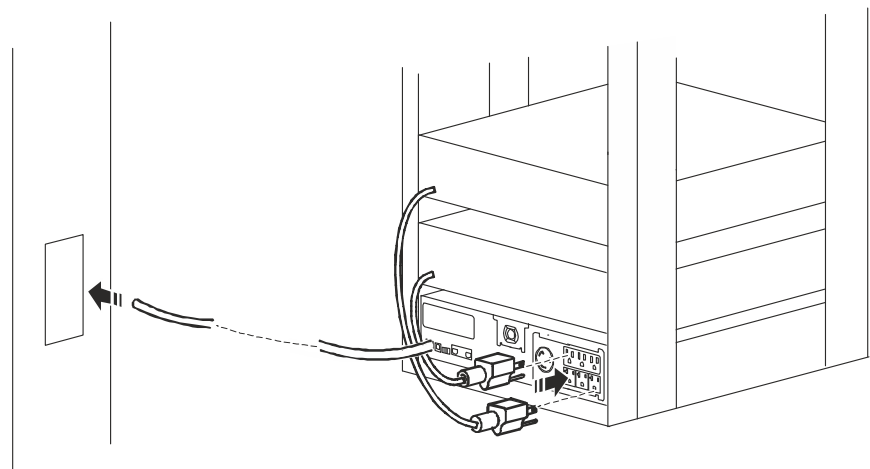

Basic Connections



Serial port: Connect to a computer to use power management software, use the serial cable included with the unit.



USB port: Connect to a computer to use power management software.
Note: Serial and USB communication can not be used simultaneously.



External Battery Pack connector: Connect external battery packs to provide extended runtime during power outages. The UPS can support up to 10 external battery packs.



Ground Screw: The UPS features a ground screw for connecting the ground leads on transient voltage devices. Prior to connecting a ground lead, disconnect the UPS from utility power.

Display Interface

Overview

- ❶ Online LED
- ❷ UPS Output ON/OFF button
- ❸ On Battery LED
- ❹ Site Wiring Fault LED
- ❺ Replace Battery LED
- ❻ Display screen
- ❼ UP/DOWN arrow buttons
- ❽ ENTER button
- ❾ ESCAPE button

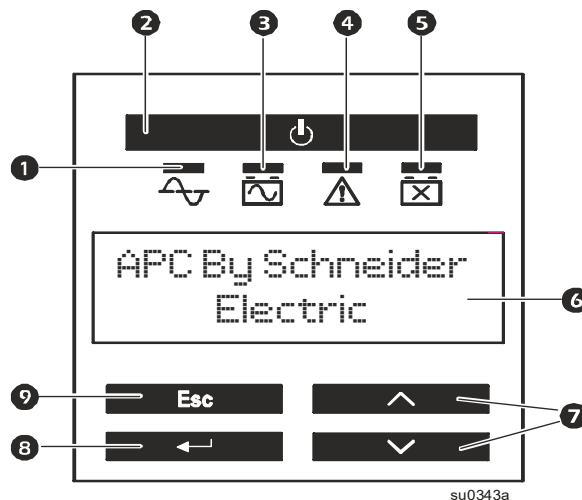

Using the display interface

Use the UP/DOWN arrow buttons to scroll through the main menu options. Press ENTER to view the submenu under each main menu option. Press ESCAPE to exit a submenu and return to a main menu.

Menu Overview

The Smart-UPS has Standard and Advanced menu screens. The Standard menu screens are the most commonly used screens. The Advanced menu screens are for more advanced users to configure additional features on the UPS.

Note: Actual menu screens may vary.

Main Menu	Overview	Standard	Advanced
Scrolling Screens	On Utility (the UPS is operating on utility power)		X
	Outlet Group Status		X
	Input and Output voltage		X
	Load meter		X
	Battery charge and runtime		X
	Alarms		X
	Load and Battery graphs	X	
Status	Operating Mode	X	X
	Efficiency in % (Green mode only)	X	X
	Input and output voltage	X	X
	Load power (W) and VA	X	X
Status	Load (A)		X
	Load meter (kWh)		X
	Last transfer to battery power information	X	X
	Battery charge and estimated run time	X	X
	Battery voltage		X
	Number of external battery packs		X
	Internal battery temperature		X
	Run time calibration test results	X	X
	Self-test results	X	X
	Status of the switched outlet group(s): On, Off, Sleep, Reboot, Turning On, Turning Off		X
	Smart Slot information (if applicable)		X
Configuration	Language	X	X
	Local power quality	X	X
	Standard or Advanced menus	X	X
	Audible alarms	X	X
	High and low transfer points		X
	Low run time alert		X
	Green mode (enable/disable)		X
	Output voltage	X	X
	Battery self-test interval	X	X
	Battery installation date	X	X
	UPS firmware update (only available when output is off)	X	X
	UPS setup wizard	X	X
	Reset to factory defaults	X	X
	Switched outlet group(s) delays and settings		X
	Smart Slot configuration (if applicable)		X
Control	Switched outlet group(s): Turn on, turn off, put to sleep, or reboot		X
Test & Diagnostics	UPS self-test.	X	X
	Runtime calibration test.	X	X
	Audible alarm and display test.	X	X

Main Menu	Overview	Standard	Advanced
Statistics	Statistics about transfers to battery power, time on battery, and total operating time		X
Logs	Transfer log		X
	Status log		X
	Event log		X
About	General information about the UPS, including: model numbers, output voltage setting, serial number, manufacture date, replacement battery cartridge information, firmware versions, and suggested battery replacement date.	X	X
	SmartSlot card information (if applicable), including IP address		X
PowerChute	PowerChute Business Edition information (if applicable)		X

Configuration

UPS Settings

Start up Settings

Use the display interface to configure these settings at initial start up. The UPS will prompt for a response to each setting, if no response is given, the default setting will be used.

Note: The unit will not turn on until all of these settings are entered.

Function	Factory Default	Options	Description
Language	English	<ul style="list-style-type: none">• English• French*• German*• Spanish*• Italian*• Portuguese*	The language for the display interface. *Language options will vary by model.
Output Voltage	Low Voltage: 120 V	<ul style="list-style-type: none">• 100• 110• 120• 127	Set the output voltage setting while the UPS is in Standby mode.
	High Voltage: 230 V	<ul style="list-style-type: none">• 200• 208• 220• 230• 240	
Input Power Quality	Good	<ul style="list-style-type: none">• Good• Fair• Poor	Select the quality of input utility power. <ul style="list-style-type: none">• If Good is selected, the unit will go on battery power more often to provide the cleanest power supply to the connected equipment.• If Poor is selected, the UPS will tolerate more fluctuations in power and will go on battery power less often. If unsure of the local power quality, select Good.
Menu Type	Standard	Standard or Advanced	The advanced menus include all parameters. The Standard menus display a limited set of menus and options.
Date	UPS manufacture date + 90 days	mm-yyyy	Enter the current date.

General Settings

Configure these settings at any time, using the display interface, PowerChute™ software, or a network management card.

Function	Factory Default	Options	Description
High Transfer Point	Low Voltage		To avoid unnecessary battery usage, set the transfer point higher if the utility voltage is chronically high and the connected equipment is known to work under this condition. The POWER QUALITY setting will automatically change this setting. Note: Use the Advanced Menus to configure this setting.
	100 V: 108 Vac	108-114 Vac	
	110 V: 116 Vac	116-125 Vac	
	120 V: 127 Vac	127-136 Vac	
	127 V: 134 Vac	134-143 Vac	
	High Voltage		
	200 V: 216 Vac	216-228 Vac	
	208 V: 220 Vac	220-235 Vac	
	220 V: 242 Vac	242-254 Vac	
	230 V: 253 Vac	253-265 Vac	
240 V: 264 Vac	264-276 Vac		
Low Transfer Point	Low Voltage		Set the transfer point lower if the utility voltage is chronically low and the connected equipment can tolerate this condition. The POWER QUALITY setting will automatically change this setting. Note: Use the Advanced Menus to configure this setting.
	100 V: 92 Vac	86-92 Vac	
	110 V: 98 Vac	89-98 Vac	
	120 V: 106 Vac	97-106 Vac	
	127 V: 112 Vac	103-112 Vac	
	High Voltage		
	200 V: 184 Vac	172-184 Vac	
	208 V: 184 Vac	169-184 Vac	
	220 V: 198 Vac	186-198 Vac	
	230 V: 207 Vac	195-207 Vac	
240 V: 216 Vac	204-216 Vac		
Green Mode	If the UPS input voltage is between the high transfer point and the lower transfer point, the unit will operate in green mode. Configure this setting using the Advanced menus.		
Transfer Sensitivity	Normal	<ul style="list-style-type: none"> • Normal • Reduced • Low 	<p>Select the level of sensitivity to power events that the UPS will tolerate.</p> <ul style="list-style-type: none"> • Normal: The UPS will go on battery power more often to provide the cleanest power supply to the connected equipment. • Reduced: The UPS will tolerate some fluctuations in power. • Low: The UPS will tolerate more fluctuations in power and will go on battery power less often. <p>If the connected load is sensitive to power disturbances, set the sensitivity to Normal using the advanced Configuration menu.</p>
Low Runtime Alert	150 sec	Set the value in seconds	The UPS will emit an audible alarm when the remaining runtime has reached this level.
Date of Last Battery Replacement	Date set at factory	Reset this date when the battery module is replaced.	
Audible Alarm	On	On/Off	The UPS will never beep if all audible alarms are set to Off or when the display buttons are pressed.

Function	Factory Default	Options	Description
Auto Self-Test Interval Setting	On start-up and every 14 days since the last test	<ul style="list-style-type: none"> • Last test + 14 days • Last test + 7 days • Turn on + 14 days • Turn on + 7 days • On startup only • Never 	The interval at which the UPS will execute a self-test. The batteries must be charged to at least 70% capacity to perform the test.
Reset to Factory Default	No	Yes/No	Restore the UPS factory default settings.

Switched Outlet Groups

Overview

The Switched Outlet Groups can be configured to independently turn off, turn on, shut down, put into sleep mode, and reboot connected equipment.

The Switched Outlet Groups can be commanded to do the following:

- Turn off: Disconnect from power immediately and restart only with a manual command
- Turn on: Connect to power immediately
- Shutdown: Disconnect power in sequence, and automatically reapply power in sequence when utility power becomes available
- Reboot: Shut down and restart
- Sleep: Reboot after a long delay

In addition, the Switched Outlet Groups can be configured to do the following:

- Turn on or off in a specified sequence
- Automatically turn off or shut down when various conditions occur

Note: Whether the Switched Outlet Groups are configured or not, all of the outlets provide battery backup power.

Using the Switched Outlet Groups

1. Connect essential equipment to a Switched Outlet Group.
2. Connect peripheral equipment to the other Switched Outlet Groups.
 - During a power outage, to conserve battery runtime, nonessential equipment can be configured to shut down after a short delay
 - If equipment has dependent peripherals that must restart or shut down in a specific order, such as an ethernet switch that must restart before a connected server, connect the devices to separate groups
 - Equipment that needs to reboot independently from other equipment should be added to a separate group
3. Use the Configuration menus to configure how the Switched Outlet Groups will react in the event of a power outage.

Customize the Switched Outlet Groups

Use the **Control** menus to customize the Switched Outlet Groups.

Function	Factory Default	Options	Description
Name String Outlet Group	Outlet Group 1, 2, 3	Edit these names using an external interface, such as the Network Management Card web interface.	
UPS Name String	APC UPS		
Turn On Delay	0 sec	Set the value in seconds	The amount of time the Switched Outlet Groups will wait between receiving the command to turn on and the actual startup.
Turn Off Delay	90 sec	Set the value in seconds	The amount of time that the Switched Outlet Groups will wait between receiving the command to turn off and the actual shut down.
Reboot Duration	8 sec	Set the value in seconds	The amount of time that the Switched Outlet Groups must remain off before it will restart.
Minimum Return Time	0 sec	Set the value in seconds	The amount of battery runtime that must be available before the Switched Outlet Groups will turn on again after a shutdown.
Load Shed On Battery	Disabled	<ul style="list-style-type: none"> • Shutdown with Delay • Shutdown immediately • Turn off immediately • Turn off with delay • Disabled 	<p>When the unit switches to battery power, the UPS can disconnect power to the Switched Outlet Groups to save runtime.</p> <p>Configure this delay time, use the LOAD SHED TIME WHEN ON BATTERY setting.</p>
Load Shed Time when On Battery	Disabled	Set the value in seconds	The amount of time the outlets will function on battery power before they will turn off.
Load Shed On Runtime	Disabled	<ul style="list-style-type: none"> • Shutdown with delay • Shutdown immediately • Turn off immediately • Turn off with delay • Disabled 	Configure this time using the LOAD SHED RUNTIME REMAINING setting.
Load Shed On Runtime Remaining	Disabled	Set the value in seconds	When the remaining runtime reaches this level, the Switched Outlet Groups will turn off.
Load Shed on Overload	Disabled	<ul style="list-style-type: none"> • Disabled • Enabled 	In the event of an overload (greater than 105% output), the Switched Outlet Groups will immediately turn off to conserve power for essential loads. The Switched Outlet Groups will only turn on again with a manual command.

Network Management Card Settings

These settings are available only on units that have a Network Management Card (NMC).

- NMC IP Address Mode
- NMC Default Gateway

Emergency Power Off

EPO Overview

The Emergency Power Off (EPO) option is a feature that will immediately disconnect all connected equipment from utility power. The UPS will immediately shut down and will not switch to battery power.

Connect each UPS to the EPO switch.

The UPS must be manually restarted to reapply power to connected equipment. Press ON/OFF on the front panel of the UPS.

Adhere to all national and local electrical codes. Wiring must be performed by a qualified electrician.

Normally open contacts

1. If the EPO switch or relay contacts are normally open, insert the wires from the switch or contacts at pins 1 and 2 of the EPO terminal block. Use 16-28 AWG wire.
2. Secure the wires by tightening the screws.

If the contacts are closed, the UPS will turn OFF and power will be removed from the load.

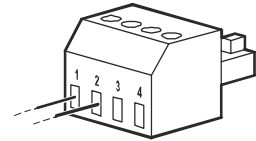

Normally closed contacts

1. If the EPO switch or relay contacts are normally closed, insert the wires from the switch or contacts at pins 2 and 3 of the EPO terminal block. Use 16-28 AWG wire.
2. Insert a wire jumper between pins 1 and 2. Secure the wires by tightening the three screws at positions 1, 2, and 3.

If the contacts are opened, the UPS will turn OFF and power will be removed from the load.

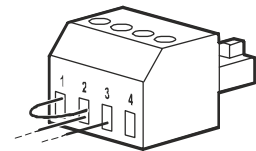

Note: Pin 1 is the power source for the EPO circuit, it provides a few milliamperes of 24 V power.

If the normally closed (NC) EPO configuration is used, the EPO switch or relay should be rated for dry circuit applications, the rating should be for low voltage and low current applications. This normally implies the contacts are gold-plated.

The EPO interface is a Safety Extra Low Voltage (SELV) circuit. Connect the EPO interface only to other SELV circuits. The EPO interface monitors circuits that have no determined voltage potential. SELV circuits are controlled by a switch or relay properly isolated from utility power. To avoid damage to the UPS, do not connect the EPO interface to any circuit other than a SELV circuit.

Use one of the following cable types to connect the UPS to the EPO switch.

- CL2: Class 2 cable for general use.
- CL2P: Plenum cable for use in ducts, plenums, and other spaces used for environmental air.
- CL2R: Riser cable for use in a vertical run in a floor-to-floor shaft.
- CLEX: Limited use cable for use in dwellings and for use in raceways.
- Installation in Canada: Use only CSA certified, type ELC, (extra-low voltage control cable).
- Installation in countries other than Canada and the USA: Use standard low-voltage cable in accordance with national and local regulations.

Troubleshooting

Problem and Possible Cause	Solution
The UPS will not turn on or there is no output	
The unit has not been turned on.	Press the ON button to turn on the UPS.
The UPS is not connected to utility power.	Ensure that the power cable is securely connected to the unit and to the utility power supply.
The UPS has detected an internal fault.	Do not attempt to use the UPS. Unplug the UPS and have it serviced immediately.
The UPS is operating on battery, while connected to utility power	
There is very high, very low, or distorted input line voltage or frequency.	<p>Move the UPS to a different outlet on a different circuit. Test the input voltage with the utility voltage display. If acceptable to the connected equipment, reduce the UPS sensitivity.</p> <p>Test the utility input power to ensure the unit is receiving input power.</p>
UPS is emits intermittent beeps	
The UPS is in normal operation.	The UPS is helping protect the connected equipment. See the display interface to view the status of the UPS.
UPS does not provide expected backup time	
The UPS battery is weak due to a recent outage or is near the end of its service life.	Charge the battery. Batteries require recharging after extended outages and wear out faster when put into service often or when operated at elevated temperatures. If the battery is near the end of its service life, consider replacing the battery even if the replace battery indicator is not yet illuminated.
The UPS is overloaded.	Check the UPS load display. Unplug unnecessary equipment, such as printers.
The LED is illuminated	
The UPS displays a message and emits a constant beeping sound	
The UPS has detected an internal fault.	Do not attempt to use the UPS. Turn the UPS off and have it serviced immediately.
The Replace Battery LED is illuminated	
The battery has a weak charge.	Allow the battery to recharge for at least four hours. Then, perform a self-test. If the problem persists after recharging, replace the battery.
The replacement battery is not properly connected.	Ensure that the battery connector is securely connected.
The display interface has a Site Wiring Fault message	
Wiring faults detected include missing ground, hot-neutral polarity reversal, and overloaded neutral circuit.	If the UPS indicates a site wiring fault, have a qualified electrician inspect the building wiring. (Applicable for Low Voltage (120 V) units only.)

Service

If the unit requires service, do not return it to the dealer. Follow these steps:

1. Review the Troubleshooting section of the manual to eliminate common problems.
2. If the problem persists, contact APC by Schneider Electric Customer Support through the APC by Schneider Electric Web site, **www.apc.com**.
 - a. Note the model number and serial number and the date of purchase. The model and serial numbers are located on the rear panel of the unit and are available through the LCD display on select models.
 - b. Call APC by Schneider Electric Customer Support and a technician will attempt to solve the problem over the phone. If this is not possible, the technician will issue a Returned Material Authorization Number (RMA#).
 - c. If the unit is under warranty, the repairs are free.
 - d. Service procedures and returns may vary internationally. Refer to the APC by Schneider Electric Web site for country specific instructions.
3. Pack the unit in the original packaging whenever possible to avoid damage in transit. Never use foam beads for packaging. Damage sustained in transit is not covered under warranty.
 - a. **Always DISCONNECT THE UPS BATTERIES before shipping. The United States Department of Transportation (DOT), and the International Air Transport Association (IATA) regulations require that UPS batteries be disconnected before shipping.** The internal batteries may remain in the UPS.
 - b. External Battery Pack products are deenergized when disconnected from the associated UPS product. It is not necessary to disconnect the internal batteries for shipping. Not all units utilize an external battery pack.
4. Write the RMA# provided by Customer Support on the outside of the package.
5. Return the unit by insured, prepaid carrier to the address provided by Customer Support.

Transport

1. Shut down and disconnect all connected equipment.
2. Disconnect the unit from mains power.
3. Disconnect all internal and external batteries (if applicable).
4. Follow the shipping instructions outlined in the *Service* section of this manual.

Limited Factory Warranty

Schneider Electric IT Corporation (SEIT), warrants its products to be free from defects in materials and workmanship for a period of two (2) years from the date of purchase. The SEIT obligation under this warranty is limited to repairing or replacing, at its own sole option, any such defective products. Repair or replacement of a defective product or part thereof does not extend the original warranty period.

This warranty applies only to the original purchaser who must have properly registered the product within 10 days of purchase. Products may be registered online at warranty.apc.com.

SEIT shall not be liable under the warranty if its testing and examination disclose that the alleged defect in the product does not exist or was caused by end user or any third person misuse, negligence, improper installation, testing, operation or use of the product contrary to SEIT recommendations of specifications. Further, SEIT shall not be liable for defects resulting from: 1) unauthorized attempts to repair or modify the product, 2) incorrect or inadequate electrical voltage or connection, 3) inappropriate on site operation conditions, 4) Acts of God, 5) exposure to the elements, or 6) theft. In no event shall SEIT have any liability under this warranty for any product where the serial number has been altered, defaced, or removed.

EXCEPT AS SET FORTH ABOVE, THERE ARE NO WARRANTIES, EXPRESS OR IMPLIED, BY OPERATION OF LAW OR OTHERWISE, APPLICABLE TO PRODUCTS SOLD, SERVICED OR FURNISHED UNDER THIS AGREEMENT OR IN CONNECTION HEREWITH.

SEIT DISCLAIMS ALL IMPLIED WARRANTIES OF MERCHANTABILITY, SATISFACTION AND FITNESS FOR A PARTICULAR PURPOSE.

SEIT EXPRESS WARRANTIES WILL NOT BE ENLARGED, DIMINISHED, OR AFFECTED BY AND NO OBLIGATION OR LIABILITY WILL ARISE OUT OF, SEIT RENDERING OF TECHNICAL OR OTHER ADVICE OR SERVICE IN CONNECTION WITH THE PRODUCTS.

THE FOREGOING WARRANTIES AND REMEDIES ARE EXCLUSIVE AND IN LIEU OF ALL OTHER WARRANTIES AND REMEDIES. THE WARRANTIES SET FORTH ABOVE CONSTITUTE SEIT'S SOLE LIABILITY AND PURCHASER EXCLUSIVE REMEDY FOR ANY BREACH OF SUCH WARRANTIES. SEIT WARRANTIES EXTEND ONLY TO ORIGINAL PURCHASER AND ARE NOT EXTENDED TO ANY THIRD PARTIES.

IN NO EVENT SHALL SEIT, ITS OFFICERS, DIRECTORS, AFFILIATES OR EMPLOYEES BE LIABLE FOR ANY FORM OF INDIRECT, SPECIAL, CONSEQUENTIAL OR PUNITIVE DAMAGES, ARISING OUT OF THE USE, SERVICE OR INSTALLATION OF THE PRODUCTS, WHETHER SUCH DAMAGES ARISE IN CONTRACT OR TORT, IRRESPECTIVE OF FAULT, NEGLIGENCE OR STRICT LIABILITY OR WHETHER SEIT HAS BEEN ADVISED IN ADVANCE OF THE POSSIBILITY OF SUCH DAMAGES. SPECIFICALLY, SEIT IS NOT LIABLE FOR ANY COSTS, SUCH AS LOST PROFITS OR REVENUE, WHETHER DIRECT OR INDIRECT, LOSS OF EQUIPMENT, LOSS OF USE OF EQUIPMENT, LOSS OF SOFTWARE, LOSS OF DATA, COSTS OF SUBSTITUANTS, CLAIMS BY THIRD PARTIES, OR OTHERWISE.

NOTHING IN THIS LIMITED WARRANTY SHALL SEEK TO EXCLUDE OR LIMIT SEIT LIABILITY FOR DEATH OR PERSONAL INJURY RESULTING FROM ITS NEGLIGENCE OR ITS FRAUDULENT MISREPRESENTATION OF TO THE EXTENT THAT IT CANNOT BE EXCLUDED OR LIMITED BY APPLICABLE LAW.

To obtain service under warranty you must obtain a Returned Material Authorization (RMA) number from customer support. Customers with warranty claims issues may access the SEIT worldwide customer support network through the APC by Schneider Electric Web site: www.apc.com. Select your country from the country selection drop down menu. Open the Support tab at the top of the web page to obtain information for customer support in your region. Products must be returned with transportation charges prepaid and must be accompanied by a brief description of the problem encountered and proof of date and place of purchase.

APC by Schneider Electric Worldwide Customer Support

Customer support for this or any other APC by Schneider Electric product is available at no charge in any of the following ways:

- Visit the APC by Schneider Electric web site, www.apc.com to access documents in the APC Knowledge Base and to submit customer support requests.
 - www.apc.com (Corporate Headquarters)
Connect to localized APC by Schneider Electric web site for specific countries, each of which provides customer support information.
 - www.apc.com/support/
Global support searching APC Knowledge Base and using e-support.
- Contact the APC by Schneider Electric Customer Support Center by telephone or e-mail.
 - Local, country specific centers: go to www.apc.com/support/contact for contact information.
 - For information on how to obtain local customer support, contact the APC by Schneider Electric representative or other distributor from whom you purchased your APC by Schneider Electric product.

© 2022 APC by Schneider Electric. APC, the APC logo, Smart-UPS and PowerChute are owned by Schneider Electric Industries S.A.S. or their affiliated companies. All other trademarks are property of their respective owners.