

SONY®



Table of
contents

Operation
Search

MENU/Settings
Search

Index

Cyber-shot

Cyber-shot Handbook

DSC-TX1

How to use this handbook

Click on a button at upper right to jump to the corresponding page.
This is convenient when searching for a function you want to view.



← Search for information by function.

← Search for information by operation.

← Search for information in a listing of MENU/Settings items.

← Search for information by keyword.

Table of contents

Operation Search

MENU/Settings Search

Index

Marks and notations used in this handbook

In this handbook, the sequence of operations is shown by arrows (→). You should touch the items on the screen in the order indicated. Marks are shown as they appear in the camera's default setting.

Red Eye Reduction

The flash strobos two or more times before shooting to reduce the red-eye phenomenon when using the flash.

- 1 Lower the lens cover to switch to shooting mode.
- 2 **MENU** → (Red Eye Reduction) → desired mode

<input checked="" type="checkbox"/> (Auto)	When the Face Detection function is activated, the flash strobos automatically to reduce the red-eye phenomenon.
<input type="checkbox"/> (On)	The flash always strobos to reduce the red-eye phenomenon.
<input type="checkbox"/> (Off)	Does not use Red Eye Reduction.

Notes

- You cannot select [Red Eye Reduction] in Sweep Panorama, Movie Mode, Anti Motion Blur, Hand-held Twilight, Smile Shutter or Easy Mode.
- To avoid blurring of images, hold the camera firmly until the shutter is released. It usually takes a second after you press the shutter button. Be also sure not to allow the subject to move during this period.
- Red Eye Reduction may not produce the desired effects. It depends on individual differences and conditions, such as distance to the subject, or if the subject looked away from the pre-strobe.
- If you do not use the Face Detection function, Red Eye Reduction does not work, even when you select [Auto].

💡What causes the red-eye phenomenon?

Pupils become dilated in dark environments. Flash light is reflected off the blood vessels at the back of the eye (retina), causing the "red-eye" phenomenon.

Other ways to reduce red-eye

- Select (High Sensitivity) mode in Scene Selection. (The flash is automatically turned to [OFF].)
- When the eyes of the subject turn out red, correct the image with [Retouch] → [Red Eye Correction] on the viewing menu or with the supplied software "PMB".

The default setting is indicated by .

Indicates cautions and limitations relevant to the correct operation of the camera.

Indicates information that is useful to know.

Notes on using the camera

Notes on the types of “Memory Stick” media that you can use (sold separately)



“Memory Stick Duo” media: You can use a “Memory Stick Duo” media with the camera.



“Memory Stick” media: You cannot use a “Memory Stick” media with the camera.

Other memory cards cannot be used.

- For details on “Memory Stick Duo” media, see page 142.

When using a “Memory Stick Duo” media with “Memory Stick” media compatible equipment

You can use the “Memory Stick Duo” media by inserting it into the “Memory Stick Duo” media Adaptor (sold separately).



“Memory Stick Duo” media Adaptor

Notes on the battery pack

- Charge the battery pack (supplied) before using the camera for the first time.
- You can charge the battery pack even if it is not completely discharged. In addition, even if the battery pack is not fully charged, you can use the partially charged capacity of the battery pack as is.
- If you do not intend to use the battery pack for a long time, use up the existing charge and remove it from the camera, then store it in a cool, dry place. This is to maintain the battery pack functions.
- For details on the usable battery pack, see page 144.

Carl Zeiss lens

The camera is equipped with a Carl Zeiss lens which is capable of reproducing sharp images with excellent contrast.

The lens for the camera has been produced under a quality assurance system certified by Carl Zeiss in accordance with the quality standards of Carl Zeiss in Germany.

Notes on the LCD screen and lens

- The LCD screen is manufactured using extremely high-precision technology so over 99.99% of the pixels are operational for effective use. However, some tiny black and/or bright dots (white, red, blue or green) may appear on the LCD screen. These dots are a normal result of the manufacturing process and do not affect the recording.

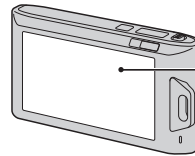

Black, white, red, blue or green dots

- If water droplets or other liquids splash on the LCD screen and make it wet, immediately wipe off the screen with a soft cloth. Leaving liquids on the LCD screen surface can harm the quality and cause a malfunction.
- Exposing the LCD screen or the lens to direct sunlight for long periods may cause malfunctions. Be careful when placing the camera near a window or outdoors.
- Do not press against the LCD screen. The screen may be discolored and that may cause a malfunction.
- Images may trail across on the LCD screen in a cold location. This is not a malfunction.
- Be careful not to bump the lens, and be careful not to apply force to it.

On moisture condensation

- If the camera is brought directly from a cold to a warm location, moisture may condense inside or outside the camera. This moisture condensation may cause a malfunction of the camera.
- If moisture condensation occurs, turn off the camera and wait about an hour for the moisture to evaporate. Note that if you attempt to shoot with moisture remaining inside the lens, you will be unable to record clear images.

The images used in this Handbook

The images used as examples in this Handbook are reproduced images, and are not actual images shot using this camera.

Table of contents

Notes on using the camera

How to use this handbook.....	2
Notes on using the camera	3
Operation Search	7
MENU/Settings Search	10
Names of parts.....	15
List of icons displayed on the screen	16
Using the touch panel	18
Using the internal memory	20

Shooting

REC Mode.....	21
Intelligent Auto Adjustment	22
Sweep Panorama.....	23
Movie Mode.....	25
Program Auto	26
Anti Motion Blur.....	27
Hand-held Twilight	28
Scene Selection	29
Zoom	31

Viewing

Viewing still images.....	32
Playback Zoom	33
Wide Zoom.....	34
Temporarily Rotated Display.....	35
Viewing movies	36

MENU (Shooting)

MENU items (Shooting)	10
-----------------------------	----

MENU (Viewing)

MENU items (Viewing)	12
----------------------------	----

Settings

Setting items	13
---------------------	----

TV

Viewing an image on a SD TV	114
Viewing an image on an HD TV	115

Computer

Using with your computer	117
Using the software	118
Connecting the camera to the computer	121
Viewing "Cyber-shot Step-up Guide"	123

Printing

Printing still images	124
-----------------------------	-----

Troubleshooting

Troubleshooting	127
Warning indicators and messages	136

Others

Image file storage destinations and file names.....	141
“Memory Stick Duo” media.....	142
Battery pack	144
Battery charger.....	145
Intelligent Pantilter.....	146

Index

Index	147
-------------	-----

Operation Search

Leaving the settings to the camera	Intelligent Auto Adjustment.....	22
	Scene Selection.....	29
	Scene Recognition.....	59
Shooting portraits	Soft Snap.....	29
	Twilight Portrait.....	29
	Smile Shutter.....	39
	Scene Recognition.....	59
	Face Detection.....	61
	Anti Blink.....	64
	Red Eye Reduction.....	65
Shooting panoramic images	Sweep Panorama.....	23
Shooting best shots of your pet	Pet.....	29
Shooting close to objects	Macro.....	50
	Close Focus On.....	50
Shooting moving objects	Hi-Speed Shutter.....	30
	Movie Mode.....	25
	Burst.....	45
Shooting without blur	High Sensitivity.....	29
	Hi-Speed Shutter.....	30
	Anti Motion Blur.....	27
	Hand-held Twilight.....	28
	2-second delay self-timer.....	43
	ISO.....	52
SteadyShot.....	66	

Table of contents

Operation Search

MENU/Settings Search

Index

Shooting with backlight	Forced Flash	41
	Scene Recognition	59
	DRO	63
Shooting in dark places	High Sensitivity	29
	Anti Motion Blur	27
	Slow Synchro	41
	ISO	52
Adjusting exposure	EV	51
Changing focus position	Using the touch panel	18
	Focus	56
	Face Detection	61
Changing image size	Image Size	47
Deleting images	Delete	74
	Format	106
Displaying enlarged images	Playback Zoom	33
	Trimming	77
Displaying full-screen images	Wide Zoom	34
	Temporarily Rotated Display	35
	Image Size	47
Editing images	Retouch	77
	Paint	76
Playing back a series of images in order	Slideshow	71
Using with easy-to-see indicators	Easy Mode	37, 68

Printing images with the date	“PMB (Picture Motion Browser)”	118
Changing date and time settings	Area Setting	112
	Date & Time Setting.....	113
Initializing settings	Initialize.....	98
Printing images	Print	124
Viewing on TVs	Viewing an image on a SD TV.....	114
	Viewing an image on an HD TV	115
Information about optional accessories	“Cyber-shot Step-up Guide”	123
	Intelligent Pantilter.....	146

Table of contents

Operation Search

MENU/Settings Search

Index



MENU/Settings Search





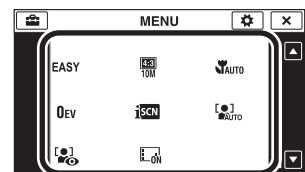





MENU items (Shooting)



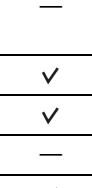
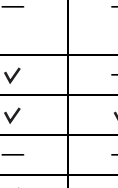
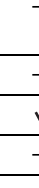
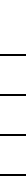

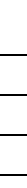

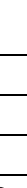
You can easily select the various shooting functions from **MENU**.

- 1 Lower the lens cover to switch to shooting mode.
- 2 Touch **MENU** to display the MENU screen.
The four menu items displayed below **MENU** do not appear in the MENU screen.
- 3 Touch the menu item → desired mode.



In the table below, ✓ indicates an available function. The icons below  and  indicate the available modes.

REC Mode Menu items				P			SCN
Easy Mode	✓	✓	—	✓	✓	✓	✓
Movie shooting mode	—	—	✓	—	—	—	—
Smile Shutter	✓	—	—	✓	—	—	
Flash	✓	—	—	✓	—	—	
Self-Timer	✓	—	✓	✓	✓	✓	✓
Burst	✓	—	—	✓	—	—	
Shooting Direction	—	✓	—	—	—	—	—
Image Size	✓	✓	✓	✓	✓	✓	✓
Macro	✓	—	—	✓	—	—	
EV	✓	✓	✓	✓	✓	✓	✓
ISO	—	—	—	✓	—	—	
White Balance	—	✓		✓	✓	✓	
Underwater White Balance	—	—		—	—	—	
Focus	—	✓	—	✓	—	—	—
Metering Mode	—	✓	✓	✓	✓	✓	—
Scene Recognition	✓	—	—	—	—	—	—
Face Detection	✓	—	—	✓	✓	✓	
DRO	—	—	—	✓	—	—	—
Anti Blink	—	—	—	—	—	—	

REC Mode Menu items				P			SCN
Red Eye Reduction	✓	—	—	✓	—	—	
SteadyShot	—	—	✓	✓	✓	✓	
Shooting Display Settings	✓	✓	✓	✓	✓	✓	✓

Notes

- Only the items that are available for each mode are displayed on the screen.
- The four menu items displayed below **MENU** differ according to each recording mode.

MENU items (Viewing)

You can easily select the various viewing functions from **MENU**.

1 Press the  (Playback) button to switch to playback mode.







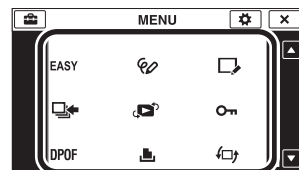











2 Touch **MENU** to display the MENU screen.

The four menu items displayed below **MENU** do not appear in the MENU screen.

3 Touch the menu item → desired mode.



In the table below, ✓ indicates an available function.

View Mode \ Menu items	"Memory Stick Duo" media		Internal Memory
	 Date View	 Folder View	 Folder View
EASY (Easy Mode)	✓	✓	✓
 (Calendar)	✓	—	—
 (Image Index)	✓	✓	✓
 (Slideshow)	✓	✓	✓
 (Delete)	✓	✓	✓
 (Paint)	✓	✓	✓
 (Retouch)	✓	✓	✓
 (Display Burst Group)	✓	—	—
 (View Mode)	✓	✓	—
 (Protect)	✓	✓	✓
DPOF	✓	✓	—
 (Print)	✓	✓	✓
 (Rotate)	✓	✓	✓
 (Volume Settings)	✓	✓	✓
 (Playback Display Settings)	✓	✓	✓
 (Exposure data)	✓	✓	✓
 (Image index settings)	✓	✓	✓
 (Select Folder)	—	✓	—

Note

- Only the items that are available for each mode are displayed on the screen.

Setting items





You can change the settings on the  (Settings) screen.

1 Touch **MENU** to display the MENU screen.

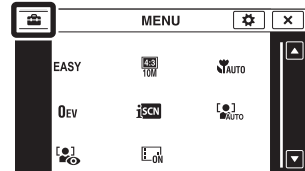

2 Touch  (Settings) → desired category → desired item → desired setting.



Categories	Items
 Shooting Settings	AF Illuminator
	Grid Line
	Digital Zoom
	Auto Orientation
	Scene Recog. Guide
	Blink Alert
 Main Settings	Beep
	LCD Brightness
	Language Setting
	Demo Mode
	Initialize
	COMPONENT
	Video Out
	Housing
	USB Connect
	Download Music
	Format Music
	Calibration
	 "Memory Stick" Tool
Create REC.Folder	
Change REC.Folder	
Delete REC.Folder	
Copy	
File Number	
 Internal Memory Tool	Format
	File Number
 Clock Settings	Area Setting
	Date & Time Setting

Notes

- [Shooting Settings] appears only when settings have been entered from shooting mode.
- ["Memory Stick" Tool] appears only when a "Memory Stick Duo" media is inserted in the camera, while [Internal Memory Tool] appears only when a "Memory Stick Duo" media is not inserted.

Names of parts

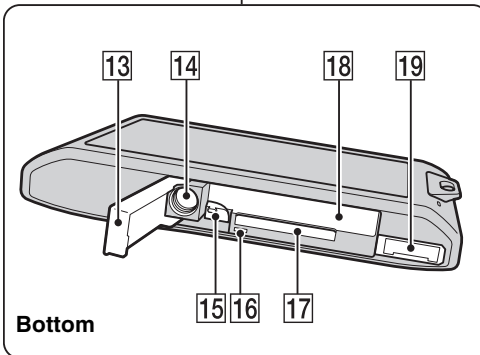
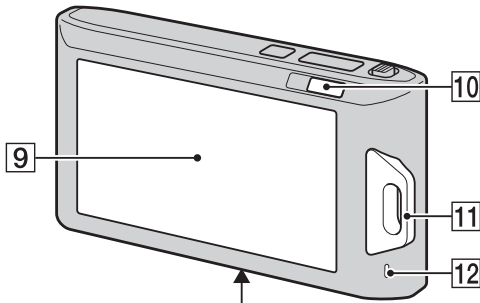
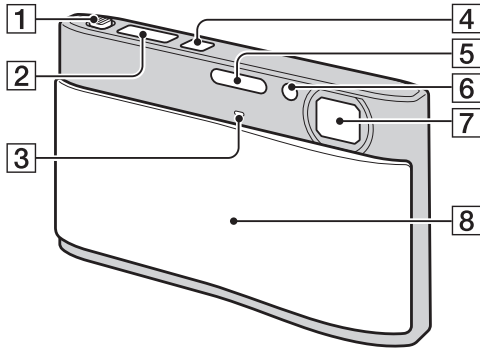

Bottom

- 1 Zoom (W/T) lever (31, 33)
- 2 Shutter button
- 3 Microphone
- 4 ON/OFF (Power) button
- 5 Flash
- 6 Self-timer lamp/Smile Shutter lamp/AF illuminator
- 7 Lens
- 8 Lens cover
- 9 LCD screen/Touch panel
- 10 (Playback) button (32)
- 11 Hook for wrist strap*/Grip
- 12 Speaker
- 13 Battery/"Memory Stick Duo" media cover
- 14 Tripod receptacle
- 15 Battery eject lever
- 16 Access lamp
- 17 "Memory Stick Duo" media slot
- 18 Battery insertion slot
- 19 Multi Connector

* Using the wrist strap

The wrist strap is already attached to the camera at the factory.

Place your hand through the loop to prevent the camera from damage by being dropped.

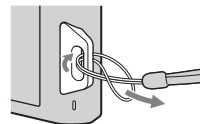

* Using the paint pen

The paint pen is used when operating the touch panel. It attaches to the wrist strap. Do not carry the camera by holding the paint pen. The camera may fall off.

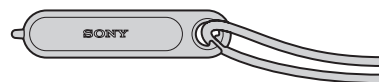

List of icons displayed on the screen

Icons are displayed on the screen to indicate the camera status. The displayed icon positions may differ according to the shooting mode.

When shooting still images

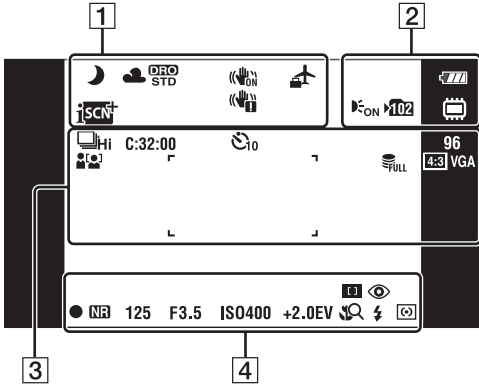

When shooting movies

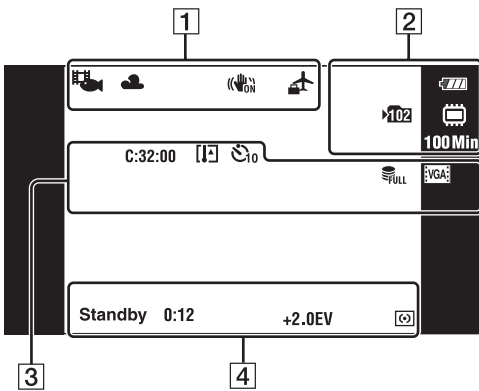

When playing back

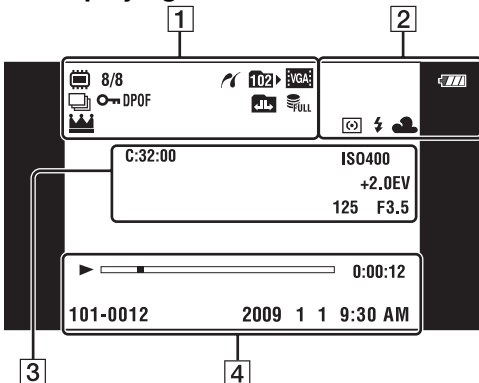

1

Display	Indication
	Scene Recognition icon
	White balance
	DRO
	SteadyShot
	Destination
	Scene Recognition
	Vibration warning
	Movie shooting mode
	Playback zoom
	Recording/Playback Media ("Memory Stick Duo" media, internal memory)
	Image number/Number of images recorded in selected folder
	PictBridge connecting
	Playback folder
	Burst shooting images
	Protect
	Print order (DPOF) mark
	Changing folder
	Database file full
	Main image in the burst group

2

Display	Indication
	Battery remaining
	Low battery warning
	AF illuminator
	Recording folder
	Recording/Playback Media ("Memory Stick Duo" media, internal memory)
100 Min	Recordable time
 x1.3 S Q P Q	Zoom scaling
	Metering Mode
	Flash
 AWB WB 1 WB 2	White balance

3

Display	Indication
	Burst mode
C:32:00	Self-diagnosis display
	Temperature increase warning
	Self-timer
	Database file full
96	Number of recordable images
	Face Detection
	AF range finder frame
+	Spot metering cross hair
 4:3 10M 4:3 5M 4:3 3M 4:3 VGA 3:2 6M 16:9 7M 16:9 2M STD WIDE 720 FINE 720 STD VGA	Image size
ISO400	ISO number
+2.0EV	Exposure Value
125	Shutter speed
F3.5	Aperture value

4

Display	Indication
	Focus
	Red-eye reduction
	Playback
	Playback bar
35° 37' 32" N 139° 44' 31" E	Latitude and Longitude display
0:00:12	Counter
	AE/AF lock
NR	NR slow shutter
125	Shutter speed
F3.5	Aperture value
ISO400	ISO number
+2.0EV	Exposure Value
	Close focus
	Flash mode
	Flash charging
	Metering mode
REC Standby	Recording a movie/Standby a movie
0:12	Recording time (m:s)
101-0012	Folder-file number
2009 1 1 9:30 AM	Recorded date/time of the playback image

Using the touch panel

The camera allows you to perform operations and make settings by touching the buttons or dragging the LCD screen with your finger.

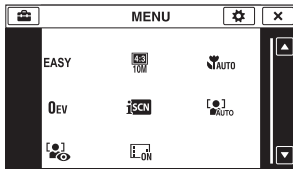

	Displays the hidden items so that the items you want to set are shown on the screen.
	Returns to the previous screen.
	Describes the shooting functions when the shooting menu is displayed.

Notes

- To operate the touch panel, press it lightly with your finger or the supplied paint pen. Pressing hard or using a pointed object other than the supplied paint pen could damage the touch panel.
- If you touch the top right of the screen during shooting, the buttons and icons will momentarily disappear. The buttons and icons will reappear when you take your finger off the screen.

Operating by dragging the LCD screen

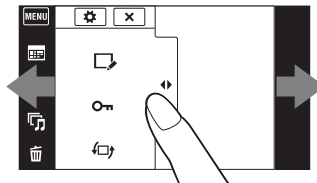
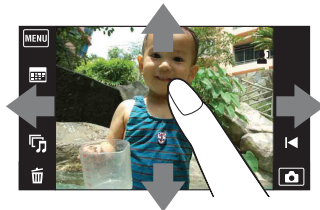



Displays/hides the MENU screen

	Adjustability	Operation method
During shooting/ playback	Displays the MENU screen	Touch the left side of the LCD screen and drag right
	Hides the MENU screen	Touch the right side of the LCD screen and drag left
	Hides the operation buttons	Touch the left side of the LCD screen and drag left
	Displays the operation buttons	Touch the left side of the LCD screen and drag right
During playback	Displays the next/previous image	Drag right or left
	Continuously changes the image (next/previous image)	Drag right or left, and continue pressing
	Displays the image index screen during playback	Drag up
	Displays the next/previous page in index mode	Drag down or up
	Displays the calendar during playback in Date View mode	Drag down



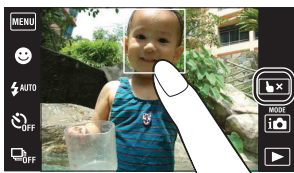

Touching the screen to set the focus

Touching the subject on the touch panel displays a frame, and then pressing the shutter button halfway down brings the frame into focus. If there is a face in the frame, in addition to the focus, the brightness and hue are also automatically optimized.



Button/Operation method	Action
Touch the subject	Adjusts the focus.
 X	Cancels the function.

Notes

- You cannot use this function when using the Digital Zoom, shooting in close focus mode or in Easy Mode.
- You cannot use this function when  (Landscape),  (Twilight),  (Gourmet),  (Fireworks) or  (Underwater) mode is selected in the Scene Selection.

Customizing the desired MENU items

During shooting/playback, the four MENU items appear on the left side of the LCD screen. You can customize these four buttons to the desired MENU items and layout, letting you conveniently locate frequently used buttons.

These buttons can be customized and the settings saved for each recording mode during shooting, and for internal memory and “Memory Stick Duo” media during playback.

1 Touch **MENU** to display the MENU screen.



2  (Customize) → [OK]

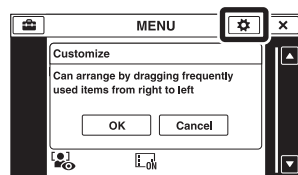

3 Select a MENU item and drag it to the desired position on the left side of the LCD screen.

4 To cancel, touch  .

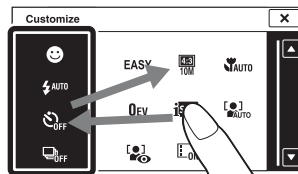

Note

- This function cannot be used when [Housing] is set to [On] or when shooting in Easy Mode.

Using the internal memory

The camera has approximately 11 MB of internal memory. This memory is not removable. Even when there is no “Memory Stick Duo” media inserted in the camera, you can record images using this internal memory.

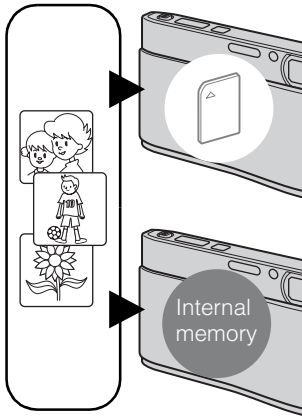

When a “Memory Stick Duo” media is inserted

[Recording]: Images are recorded on the “Memory Stick Duo” media.

[Playback]: Images on the “Memory Stick Duo” media are played back.

[Menu, Settings, etc.]: Various functions can be performed on images on the “Memory Stick Duo” media.

When there is no “Memory Stick Duo” media inserted

[Recording]: Images are recorded using the internal memory.

[Playback]: Images stored in the internal memory are played back.

[Menu, Settings, etc.]: Various functions can be performed on images in the internal memory.

On image data stored in the internal memory

We recommend that you copy (back up) data without error using one of the following methods.

To copy (back up) data on a hard disk of your computer

Perform the procedure on page 121 without a “Memory Stick Duo” media inserted in the camera.

To copy (back up) data on a “Memory Stick Duo” media

Prepare a “Memory Stick Duo” media with sufficient free capacity, then perform the procedure explained in [Copy] (page 110).

Notes





- You cannot import image data on a “Memory Stick Duo” media to the internal memory.
- By making a USB connection between the camera and a computer with a cable, you can import data stored in the internal memory to a computer. However you cannot export data on a computer to the internal memory.

REC Mode

You can select the shooting mode based on condition and objective.



- 1 Lower the lens cover to switch to shooting mode.
- 2 Touch  (REC Mode) → desired mode



 (Intelligent Auto Adjustment)	Allows you to shoot still images with the setting adjusted automatically.
 (Sweep Panorama)	Allows you to shoot a panoramic image after composing images.
 (Movie Mode)	Allows you to record movies with audio.
P (Program Auto)	Allows you to shoot with the exposure adjusted automatically (both the shutter speed and the aperture value). Also you can select various settings using the menu.
 (Anti Motion Blur)	Allows you to shoot with reduced blur without using the flash when composing burst shots taken in high-speed.
 (Hand-held Twilight)	Allows you to shoot with reduced blur in low light scenes without tripod when composing burst shots taken in high-speed.
SCN (Scene Selection)	Allows you to shoot with preset settings according to the scene.

Intelligent Auto Adjustment

Allows you to shoot still images with the setting adjusted automatically.

- 1 Lower the lens cover to switch to shooting mode.
- 2  (REC Mode) →  (Intelligent Auto Adjustment)
- 3 Press the shutter button fully down.



Note







- Flash mode is set to [Auto] or [Off].

On Scene Recognition

Scene Recognition operates in Intelligent Auto Adjustment mode. This function lets the camera automatically recognize the shooting conditions and shoot the image.



Scene Recognition icon (Guide)

- The camera recognizes  (Twilight),  (Twilight Portrait),  (Twilight using a tripod),  (Backlight),  (Backlight Portrait),  (Landscape),  (Macro), (Close Focus) or (Portrait), and displays the corresponding icon and guide on the screen when the scene is recognized.

For details, see page 59.

If you shoot a still image of a subject that is difficult to focus on

- The shortest shooting distance is approximately 8 cm (3 1/4 inches) (1 cm (13/32 inches) in Intelligent Auto Adjustment or Easy Mode) (W), 50 cm (19 3/4 inches) (T) (from the lens). Shoot in the Close focus mode when you shoot a subject closer than the shooting distance.
- When the camera cannot focus on the subject automatically, the AE/AF lock indicator changes to flash slowly and the beep does not sound. Either recompose the shot or change the focus setting (page 56).
- Focusing may be difficult in the following situations:
 - It is dark and the subject is distant.
 - The contrast between the subject and the background is poor.
 - The subject is seen through glass.
 - The subject is moving quickly.
 - There is reflective light or shiny surfaces.
 - The subject is backlit or there is a flashing light.

Sweep Panorama

Allows you to create a panoramic image from composed images.

1 Lower the lens cover to switch to shooting mode.

2  (REC Mode) →  (Sweep Panorama)



3 Hold the camera at the position where you can see the LCD screen clearly, then press the shutter button fully down.



This part will not be taken

4 Pan the camera to the end of the guide, following the indication on the LCD screen.

Guidance bar



Notes

- If you cannot pan the camera across the entire subject within the given time, a gray area occurs in the composed image. If this happens, move the camera fast to record a full panoramic image.
- Since several images are stitched together, the stitched part will not be recorded smoothly.
- Under low light conditions, panoramic images may be blurred.
- Under lights that flicker such as fluorescent light, the brightness or color of the combined image is not always the same.
- When the whole angle of panoramic shooting and the locked angle are extremely different in brightness, color and focus, the shooting will not be successful. If this happens, change lock angle and shoot again.
- Sweep Panorama is not suitable for the following situations:
 - Objects are moving
 - Objects are too close to the camera
 - Image with a repeating pattern such as tiles and image with little contrast such as sky, sandy beach, or lawn
 - Image with constant change such as waves or water falls
- You cannot create panoramic images in the following situations:
 - You pan the camera too fast or too slow
 - There is too much camera shake



Changing the shooting direction or image size of a panoramic image

Shooting Direction:  (Shooting Direction) → [Right], [Left], [Up] or [Down]

Image Size:  (Image Size) → [Standard] or [Wide]

- When the buttons are not displayed on the left side of the LCD screen, touch **MENU**.

💡 Tips for shooting a panoramic image

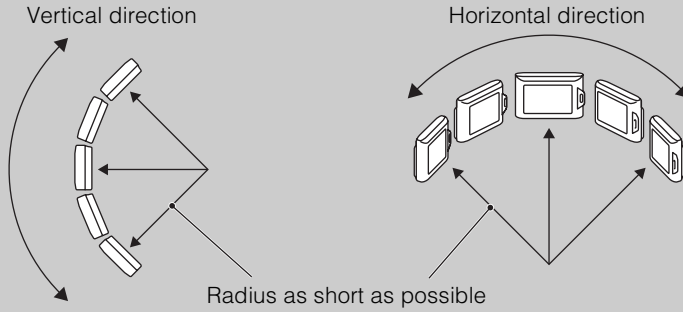

- Pan the camera in an arc with a constant velocity.
- Pan the camera in the same direction as the indication on the LCD screen.
- Determine the scene and press the shutter button halfway, so that you can lock the exposure and white balance.
- Adjust the frame composition so that a portion with greatly varied scenery is in the center of the image.

💡 Scrolling the panoramic images for display

Scroll panoramic images by touching while panoramic images are being displayed. Touch the LCD screen during playback to display the operation buttons.





Shows the displayed area of the whole panoramic image

Operation button/ Operation method	Adjustability
Touch or the LCD screen	Playback scrolling images/pause
 Drag up/down/right/left	Scrolling images.

- Panoramic images can also be played back using the supplied software “PMB” (page 118).

Movie Mode

Allows you to record movies with audio.

- 1 Lower the lens cover to switch to shooting mode.
- 2  (REC Mode) →  (Movie Mode)
- 3 Press the shutter button fully down.
- 4 To stop shooting, press the shutter button fully down again.

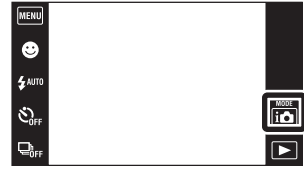

Program Auto



Allows you to shoot with the exposure adjusted automatically (both the shutter speed and the aperture value). Also you can select various settings using the menu.

- 1 Lower the lens cover to switch to shooting mode.
- 2 **i** (REC Mode) → **P** (Program Auto)
- 3 Press the shutter button fully down.



Anti Motion Blur

This is suitable for indoor shots without using the flash to reduce the subject blur.

- 1 Lower the lens cover to switch to shooting mode.
- 2  (REC Mode) →  (Anti Motion Blur)
- 3 Press the shutter button fully down.

A burst of shots are taken, and image processing is applied to reduce subject blur and noise.





Notes

- The shutter beeps 6 times, however just one image is recorded.
- Noise is not effectively reduced in the following situations:
 - Image with large-scale movement
 - Image with a main subject too close to the camera
 - Image with little contrast such as sky, sandy beach, or lawn
 - Image with constant change such as waves or water falls
- Smile Shutter cannot be used.
- When using a light source that flickers, such as fluorescent lighting, block noise may occur. In such cases, set Scene Selection to  (High Sensitivity).

Hand-held Twilight

Although night scenes tend to blur by camera shake, this mode allows you to shoot night scenes with less noise without using a tripod.

- 1 Lower the lens cover to switch to shooting mode.
- 2  (REC Mode) →  (Hand-held Twilight)
- 3 Press the shutter button fully down.

A burst of shots are taken, and image processing is applied to reduce subject blur and noise.



Notes

- The shutter beeps 6 times, however just one image is recorded.
- Noise is not effectively reduced in the following situations:
 - Image with large-scale movement
 - Image with a main subject too close to the camera
 - Image with little contrast such as sky, sandy beach, or lawn
 - Image with constant change such as waves or water falls
- Smile Shutter cannot be used.
- When using a light source that flickers, such as fluorescent lighting, block noise may occur. In these cases, set Scene Selection to  (High Sensitivity).







Scene Selection

Allows you to shoot with preset settings according to the scene.



- 1 Lower the lens cover to switch to shooting mode.
- 2  (REC Mode) → **SCN** (Scene Selection) → desired mode



 (High Sensitivity)	Allows you to shoot images without a flash under low light conditions, reducing blur.	
 (Soft Snap)	Allows you to shoot images with a softer atmosphere for portraits and flowers, etc.	
 (Landscape)	Allows easy shooting of distant scenes by focusing in the distance. Shoots the clear sky and trees and flowers in vivid colors.	
 (Twilight Portrait)	Allows you to shoot sharp images of people with the night view in the background without compromising the atmosphere.	
 (Twilight)	Allows you to shoot night scenes at far distance without losing the dark atmosphere of the surroundings.	
 (Gourmet)	Selects Macro mode, allowing you to shoot food arrangements in delicious and bright colors.	
 (Pet)	Allows you to shoot images of your pet with the best settings.	
 (Beach)	Allows you to shoot the blue of the water clearly when shooting seaside or lakeside scenes.	
 (Snow)	Allows you to record clear images preventing sunken colors in snowy scenes or other places where the whole screen appears white.	

 (Fireworks)	Allows you to record fireworks in all their splendor.	
 (Underwater)	Allows you to shoot underwater in natural colors in housing (such as Marine Pack).	
 (Hi-Speed Shutter)	Allows you to capture fast moving subjects outdoors or in other bright places. <ul style="list-style-type: none"> The shutter speed becomes faster, so images shot in dark places become darker. 	

Note

- When you shoot images using  (Twilight Portrait),  (Twilight) or  (Fireworks) mode, the shutter speed is slower and the images tend to blur. To prevent blurring, the use of a tripod is recommended.

Functions you can use in Scene Selection

For shooting an image appropriately according to the scene condition, a combination of functions is determined by the camera. ✓ indicates an available function.

The icons indicated under “Flash” indicate modes that are available.

Some functions are not available, depending on the Scene Selection mode.

	Close Focus	Flash	Face Detection/ Smile Shutter	Burst	White Balance	Red Eye Reduction	Anti Blink	Steady-Shot
	—		✓	—	✓* ¹	—	—	✓
	—	✓	✓* ²	✓	—	✓	✓	✓
	—	 	—	✓	—	✓	—	✓
	—	 SL	✓	—	—	✓	—	✓
	—		—	—	—	—	—	✓
	✓	 	—	—	✓	—	—	—
	✓	 	—	—	✓	—	—	✓
	—	 	✓	✓	—	✓	—	✓
	—	 	✓	✓	—	✓	—	✓
	—		—	—	—	—	—	✓
	✓	 	—	✓	✓* ³	—	—	✓
	—	 	✓	✓	—	✓	—	✓

*¹ [Flash] for [White Balance] cannot be selected.

*² [When touched] for [Face Detection] cannot be selected.

*³ You can use [Underwater White Balance] instead of [White Balance].

Zoom

You can enlarge the image when shooting. The camera's optical zoom function can enlarge images up to 4x.

- 1 Lower the lens cover to switch to shooting mode.
- 2 Move the zoom (W/T) lever.

Move the zoom (W/T) lever to the T side to zoom in and move to the W side to zoom out.

- When the zoom scale exceeds 4x, see page 90.

T side





W side



Notes

- The camera zooms slowly while shooting a movie.
- Zoom is locked to the W side when shooting in Sweep Panorama mode.

Viewing still images

- 1 Press the  (Playback) button to switch to playback mode.
- 2 Select an image with .



Tips for dragging operations

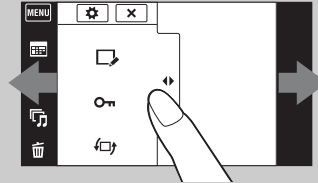
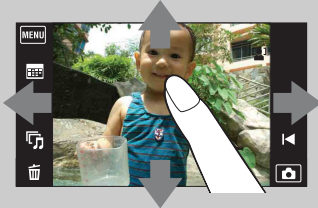

Displays/hides the MENU screen

Adjustability	Operation method
Displays the MENU screen	Touch the left side of the LCD screen and drag right
Hides the MENU screen	Touch the right side of the LCD screen and drag left
Hides the operation buttons	Touch the left side of the LCD screen and drag left
Displays the operation buttons	Touch the left side of the LCD screen and drag right
Displays the next/previous image	Drag right or left
Continuously changes the image (next/previous image)	Drag right or left, and continue pressing
Displays the image index screen during playback	Drag up
Displays the next/previous page in index mode	Drag down or up
Displays the calendar during playback in Date View mode	Drag down

Viewing images taken with a different camera

If you insert into this camera a “Memory Stick Duo” media containing images taken both with this camera and another camera, a screen for selecting the playback method appears.

“Playback only registered images”: Images are played back in the selected View Mode. Some images taken with other cameras may not be played back.

“Playback all images with folder view”: View Mode is switched to Folder View and all images are played back.

Playback Zoom

Plays back the enlarged image.

1 Press the  (Playback) button to switch to playback mode.

2 Touch the area you want to enlarge.



The image is enlarged to twice the previous size, with the area you touched at the center. You can also enlarge the image by moving the zoom (W/T) lever to the T side.

3 Adjust the zoom scale and position.

The image is further enlarged each time you touch the screen.



Shows the displayed area of the whole image

Button/Operation method	Action
Drag up/down/right/left	Changes the zoom position.
	Changes the zoom scale.
	Cancels playback zoom.



To save enlarged images

You can save an enlarged image by using the Trimming function (**MENU** → [Retouch] → [Trimming]).

Wide Zoom

In single-image mode, still images at a 4:3 or 3:2 aspect ratio are played over the entire LCD screen. In this case the top and bottom of the image will be slightly cropped.



- 1 Press the  (Playback) button to switch to playback mode.
- 2 Touch  (Wide Zoom).
- 3 To cancel Wide Zoom, touch  (Wide Zoom) again.







Note

- Wide Zoom is not available for movies, panoramic images, images displayed in a burst group, and 16:9 images.

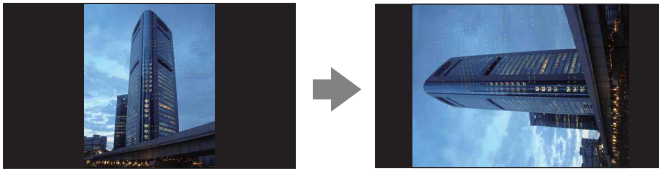
Temporarily Rotated Display

This is used in the single-image mode to temporarily rotate an image and enlarge it on the screen.







- 1 Press the  (Playback) button to switch to playback mode.
- 2 Select the vertical orientation image → touch  (Temporarily Rotated Display).
- 3 To cancel the display, touch  (Temporarily Rotated Display) again.



Notes





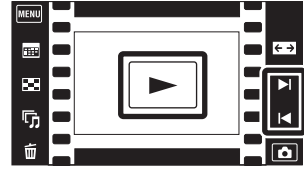

- Temporarily rotated display is not available for movies, panoramic images or horizontal orientation images.
- Touching  cancels temporarily rotated display.

Viewing movies

- 1 Press the  (Playback) button to switch to playback mode.
- 2 Select a movie with /|/|.
- 3 Touch  on the LCD screen.

When you touch the LCD screen during playback, operation buttons are displayed.



Button/Operation method	Available functions
	Jump to the start of the movie
	Fast rewind
Touch  or the LCD screen	Normal playback/Pause
	Fast forward
	Volume control Adjust the volume with  / /  .

Note

- You may not be able to play back some images shot using other cameras.

Easy Mode

Allows you shoot still images using the minimum necessary functions.
The text size increases and indicators become easier to see.

- 1 Lower the lens cover to switch to shooting mode.
- 2 **MENU** → **EASY** (Easy Mode) → [OK]



Notes

- The battery charge is used up more quickly because the screen brightness increases automatically.
- The playback mode also changes to [Easy Mode].

💡 Functions available in Easy Mode (Shooting)

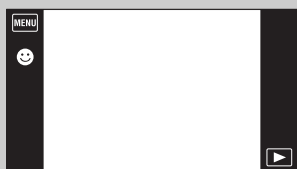

Smile Shutter: Touch ☺ (Smile).

Image Size: **MENU** → [Image Size] → Select [Large] or [Small]

Flash: **MENU** → [Flash] → Select [Auto] or [Off]

Self-Timer: **MENU** → [Self-Timer] → Select [On] or [Off]

Exit Easy Mode: **MENU** → [Exit Easy Mode] → [OK]

💡 On Scene Recognition

Scene Recognition operates in Easy Mode. This function lets the camera automatically recognize the shooting conditions and shoot the image.





Scene Recognition icon

- The camera recognizes ☾ (Twilight), 🌆 (Twilight Portrait), 🌃 (Twilight using a tripod), 🌅 (Backlight), 🌆 (Backlight Portrait), 🏞️ (Landscape), 🌿 (Macro), 🔍 (Close Focus) or 🧑 (Portrait), and displays an icon on the LCD screen when the scene is recognized.
For details, see page 59.

Movie shooting mode

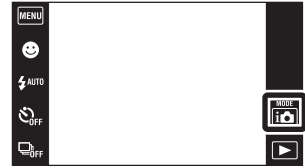

Allows you to shoot with preset settings according to the scene when the camera is in Movie Mode.

- 1 Lower the lens cover to switch to shooting mode.
- 2  (REC Mode) →  (Movie Mode)



- 3  (Movie shooting mode) → desired mode
When the buttons are not displayed on the left side of the LCD screen, touch **MENU**.



✓	 (Auto)	Adjusts the setting automatically.
	 (Underwater)	Allows you to shoot a movie underwater in natural colors using the housing (such as Marine Pack).

Smile Shutter

When the camera detects a smile, the shutter is released automatically.

1 Lower the lens cover to switch to shooting mode.

2 Touch 😊 (Smile).

When the buttons are not displayed on the left side of the LCD screen, touch **MENU**.

3 Wait detecting a smile.

When the smile level exceeds the ▼ point on the indicator, the camera records images automatically.

If you press the shutter button during Smile Shutter, the camera shoots the image, and then returns to Smile Shutter mode.

4 To end the Smile Shutter, touch 😊 (Smile) again.



Smile Detection Sensitivity indicator

Face Detection frame

Notes

- Shooting using the Smile Shutter ends automatically when either the “Memory Stick Duo” media or internal memory becomes full.
- Smiles may not be detected correctly depending on the conditions.
- You cannot use the Digital Zoom function.
- If Sweep Panorama, Movie Mode, Anti Motion Blur or Hand-held Twilight is selected, you cannot use the Smile Shutter function.

💡 Setting the Smile Detection Sensitivity

In Smile Shutter mode, a button that sets the Smile Detection Sensitivity is displayed.



😊 (Big Smile): Detects a big smile.

😊 (Normal Smile): Detects a normal smile.

😊 (Slight Smile): Detects even a slight smile.

- The Smile Detection Sensitivity is fixed to [Normal Smile] in Easy Mode.
- When [Shooting Display Settings] is set to [Off], the Smile Detection Sensitivity is not displayed.

💡 Hints for better capturing of smiles

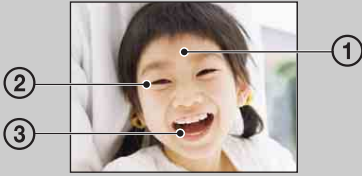

- ① Do not cover the eyes with the bangs.
Do not obscure the face by hat, masks, sunglasses, etc.
- ② Try to orient the face in front of the camera and be as level as possible. Keep the eyes narrowed.
- ③ Give a clear smile with an open mouth. The smile is easier to detect when the teeth are showing.

- The shutter operates when any person whose face is being detected smiles.
- You can select or register the selected subject for face detection with [Face Detection]. When the selected face is registered in the camera memory, Smile Detection is performed only for that face. To perform smile detection for a different face, touch that face (page 61).
- If the camera does not detect a smile, set the Smile Detection Sensitivity.

Flash

1 Lower the lens cover to switch to shooting mode.

2 AUTO (Flash) → desired mode

When the buttons are not displayed on the left side of the LCD screen, touch **MENU**.



✓	AUTO (Auto)	Flashes when shooting in low light or backlight conditions.
	(On)	Flash always operates.
	SL (Slow Synchro)	Flash always operates. The shutter speed is slow in a dark place to clearly shoot the background that is out of flash light.
	(Off)	Flash does not operate.

Notes

- The flash strobes twice. The first flash adjusts the light quantity.
- While charging the flash, is displayed.
- You cannot use the flash during burst shooting.
- [On] or [Slow Synchro] is not available when the camera is in Intelligent Auto Adjustment mode.
- In Sweep Panorama, Anti Motion Blur or Hand-held Twilight, flash is set to [Off].

When the “White circular spots” appears in flash photos

This is caused by particles (dust, pollen, etc.) floating close to the lens. When they are accentuated by the camera’s flash, they appear as white circular spots.

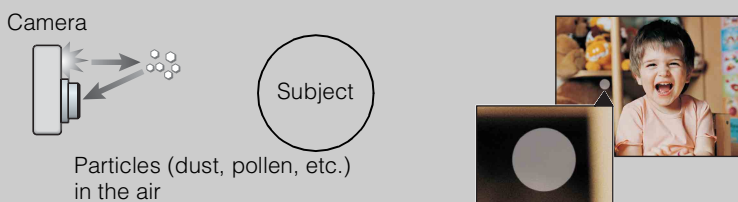

How can the “White circular spots” be reduced?

- Light the room and shoot the subject without a flash.
- Select (High Sensitivity) mode in Scene Selection. (The flash is set to [Off].)

Flash

In Easy Mode, select the Flash setting from **MENU**.

- 1 Lower the lens cover to switch to shooting mode.
- 2 **MENU** → **EASY** (Easy Mode) → [OK]
- 3 **MENU** → [Flash] → desired mode

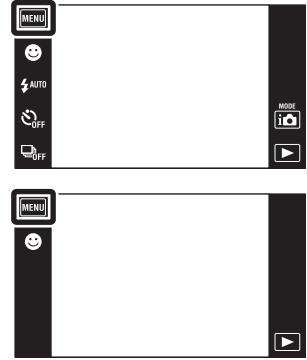





✓	Auto	Flashes when shooting in low light or backlight conditions.
	Off	Flash does not operate.

Self-Timer

- 1 Lower the lens cover to switch to shooting mode.
- 2  (Self-Timer) → desired mode

When the buttons are not displayed on the left side of the LCD screen, touch **MENU**.



✓	 OFF (Off)	Not using the self-timer
	 10 (10sec)	Setting the 10-second delay self-timer When you press the shutter button, the self-timer lamp flashes and a beep sounds until the shutter operates. To cancel, touch  .
	 2 (2sec)	Setting the 2-second delay self-timer

Note

- The self-timer is not valid when shooting in Sweep Panorama mode.



Reducing blurring with the two-second self-timer

Use the 2-second delay self-timer to prevent blur of an image. The shutter is released 2 seconds after you press the shutter button, which reduces camera shake when the shutter button is pressed.

Self-Timer

In Easy Mode, select the Self-Timer setting from **MENU**.

- 1 Lower the lens cover to switch to shooting mode.
- 2 **MENU** → **EASY** (Easy Mode) → [OK]
- 3 **MENU** → [Self-Timer] → desired mode

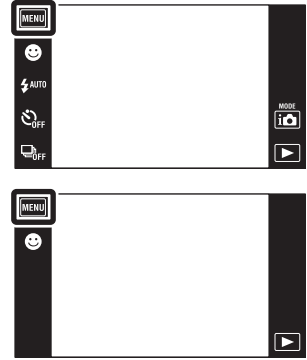

	On	Setting the 10-second delay self-timer When you press the shutter button, the self-timer lamp flashes and a beep sounds until the shutter operates. To cancel, touch  .
✓	Off	Not using the self-timer

Burst





The camera shoots up to 10 continuous frames in one burst when you hold down the shutter button.

1 Lower the lens cover to switch to shooting mode.

2  OFF (Burst) → desired mode

When the buttons are not displayed on the left side of the LCD screen, touch **MENU**.



✓	 OFF (Off)	Records a single image.
	 Hi (High)	Shoots up to 10 images in succession.
	 Mid (Mid)	Shoots up to 5 images in succession.
	 Lo (Low)	Shoots up to 2 images in succession.

Notes



- Burst mode is not available for Sweep Panorama, Movie Mode, Anti Motion Blur, Hand-held Twilight, Smile Shutter or Easy Mode.
- The flash is set to [Off].
- When recording with the self-timer, a series of a maximum of five images is recorded.
- In slow shutter speed conditions, the burst of shots per second may be decreased.
- The recording interval becomes longer, depending on the setting for the image size.
- [VGA] image size will be set while recording on internal memory.
- When the battery level is low, or when the internal memory or a “Memory Stick Duo” media is full, the burst stops.
- The focus, white balance, and exposure are adjusted for the first image, and these settings are also used for the other images.

About the recording of burst shooting images

After shooting burst images, the shot images are displayed in frames on the LCD screen. When all the images are fitted in the frames, recording is completed. You can stop the recording by touching [Cancel recording] → [OK]. When stopped, the image displayed in index and images in the image processing are recorded.

Shooting Direction

Set the direction to pan the camera when you shoot a Sweep Panorama images.

- 1 Lower the lens cover to switch to shooting mode.
- 2  (REC Mode) →  (Sweep Panorama)
- 3  (Shooting Direction) → desired direction

When the buttons are not displayed on the left side of the LCD screen, touch **MENU**.







✓	 (Right)	Pan from left to right.
	 (Left)	Pan from right to left.
	 (Up)	Pan from down to up.
	 (Down)	Pan from up to down.









Image Size

The image size determines the size of the image file that is recorded when you take a image. The larger the image size, the more detail will be reproduced when the image is printed on large-format paper. The smaller the image size, the more images can be recorded.

- 1 Lower the lens cover to switch to shooting mode.
- 2 **MENU** →  (Image Size) → desired mode



When shooting still images

	Image size	Usage guidelines	LCD screen
✓	 (3648×2736)	For prints up to A3+ size	 <p>Images are displayed in 4:3 or 3:2 aspect ratio.</p>
	 (2592×1944)	For prints up to A4 size	
	 (2048×1536)	For prints up to L/2L size	
	 (640×480)	For e-mail attachments	
	 (3648×2432)	3:2 aspect ratio as in photo prints and postcards	 <p>Images will fill the entire screen.</p>
	 (3648×2056)	For viewing on a high-definition TV and printing up to A4 size	
	 (1920×1080)	For viewing on a high-definition TV	

Note



- When you print images recorded with 16:9 aspect ratio, both edges may be cut off.

In Easy Mode

✓	Large	Shoots images in [10M] size.
	Small	Shoots images in [3M] size.

When shooting Sweep Panorama images



- 1  (Image Size) → desired mode
When the buttons are not displayed on the left side of the LCD screen, touch **MENU**.

✓	 (Standard) (Vertical direction: 3424×1920) (Horizontal direction: 4912×1080)	Shoots the images using standard size.
	 (Wide) (Vertical direction: 4912×1920) (Horizontal direction: 7152×1080)	Shoots the images using wide size.

When shooting movies

The larger the size of the movie image, the higher the image quality. The higher the amount of data used per second (average bit rate), the smoother the playback image.
The movies shot with this camera will be recorded in MPEG-4, Approx. 30 fps, Progressive, AAC, mp4 format.

- 1  (Image Size) → desired mode
When the buttons are not displayed on the left side of the LCD screen, touch **MENU**.

	Movie image size	Average bit rate	Usage guidelines
✓	 1280×720(Fine)	9 Mbps	Shoots highest quality movies for display on High Definition TV.
	 1280×720(Standard)	6 Mbps	Shoots standard quality movies for display on High Definition TV.
	 VGA	3 Mbps	Shoots an image size suitable for WEB upload.

Notes

- A telephoto image is produced when the [VGA] image size is selected for movies.
- Movies with the size set to [1280×720] can only be recorded on a “Memory Stick PRO Duo” media.
When using recording media other than a “Memory Stick PRO Duo” media, set the movie image size to [VGA].

💡 On “image quality” and “image size”

A digital image is made up of a collection of small dots called pixels. If it contains a large number of pixels, the image becomes large, it takes up more memory, and the image is displayed in fine detail. “Image size” is shown by the number of pixels. Although you cannot see the differences on the screen of the camera, the fine detail and data processing time differ when the image is printed or displayed on a computer screen.

Description of the pixels and the image size

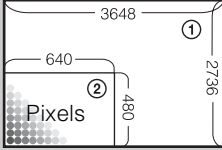

- ① Image size: 10M
 $3648 \text{ pixels} \times 2736 \text{ pixels} = 9,980,928 \text{ pixels}$
- ② Image size: VGA
 $640 \text{ pixels} \times 480 \text{ pixels} = 307,200 \text{ pixels}$

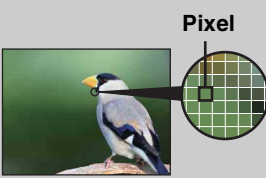

Pixel



Many pixels

(Fine image quality and large file size)



Few pixels

(Rough image quality but small file size)



Macro

Use this setting to capture beautiful close-up images of small subjects such as insects or flowers.

1 Lower the lens cover to switch to shooting mode.

2 **MENU** →  **AUTO** (Macro) → desired mode



✓	 AUTO (Auto)	The camera adjusts the focus automatically from distant subjects to close-up.
	 (Close Focus On)	Use this mode to shoot at close distances. Locked to the W side: Approximately 1 to 20 cm (13/32 to 7 7/8 inches)

Notes

- In Sweep Panorama, Movie Mode, Anti Motion Blur, Hand-held Twilight, Smile Shutter or Easy Mode, Macro mode is fixed to [Auto].
- Note the following points when using the Close focus mode.
 - You cannot use the Scene Recognition or Face Detection functions.
 - This mode is cancelled if you turn off the power or switch the shooting mode to another one.
 - The flash mode settings you can use in this mode are [On] or [Off] only.
 - The focus speed becomes slower.

EV

You can adjust the exposure manually in 1/3 EV steps in a range of -2.0 EV to +2.0 EV.

1 Lower the lens cover to switch to shooting mode.

2 **MENU** → 0_{EV} (EV)

3 Touch **+**/**-** to adjust exposure → [OK].

You can also adjust the exposure by touching ● of the adjustment bar and dragging to the right or left.

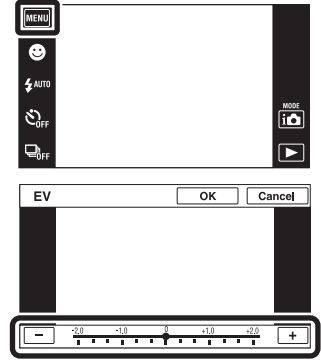

Notes

- [EV] is not available in Easy Mode.
- If you shoot a subject in extremely bright or dark conditions, or when you use the flash, the exposure adjustment may not be effective.

💡 Adjusting the exposure for better looking images



Overexposure = too much light
Whitish image



Lower EV setting -



Correct exposure



Higher EV setting +



Underexposure = too little light
Darker image

ISO

Sets the luminous sensitivity when the camera is in Program Auto mode or when Scene Selection is set to  (Underwater).

- 1 Lower the lens cover to switch to shooting mode.
- 2 **MENU** → **ISO AUTO** (ISO) → desired number

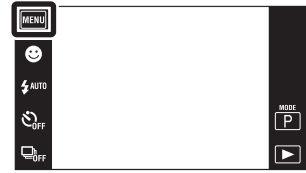

✓	ISO AUTO (Auto)	Sets the ISO sensitivity automatically.
	ISO / ISO / ISO / 125 / 200 / 400 / ISO / ISO / ISO 800 / 1600 / 3200	You can reduce image blurring in dark locations or moving subjects by increasing ISO sensitivity (select a larger number).

Note

- You can select only from [ISO AUTO], [ISO 125] to [ISO 800] when the shooting mode is set to burst mode, or when [DRO] is set to [DRO plus].

Adjusting ISO Sensitivity (Recommended Exposure Index)

ISO sensitivity is a speed rating for recording media that incorporates an image sensor that receives light. Even when the exposure is the same, images differ depending on the ISO sensitivity.



High ISO sensitivity

Records a bright image even in dark locations while increasing shutter speed to reduce blur. However, the image tends to become noisy.



Low ISO sensitivity

Records a smoother image. However, when the exposure is insufficient, the image may become darker.

White Balance

Adjusts color tones according to the surrounding light conditions. Use this function if image color appears unnatural.

1 Lower the lens cover to switch to shooting mode.

2 **MENU** → **WB AUTO** (White Balance)

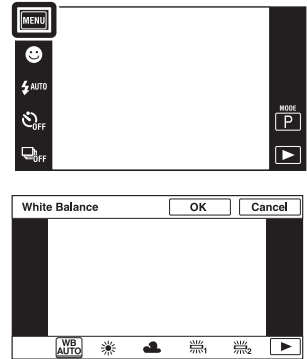

3 Touch the desired mode → [OK]

✓	WB AUTO (Auto)	Adjusts the white balance automatically so that the colors appear natural.
	☀ (Daylight)	Adjusts for outdoors conditions on a fine day, evening views, night scenes, neon signs, fireworks, etc.
	☁ (Cloudy)	Adjusts for a cloudy sky or a shady location.
	☼₁ (Fluorescent White Balance 1)	[Fluorescent White Balance 1]: Adjusts for white fluorescent lighting.
	☼₂ (Fluorescent White Balance 2)	[Fluorescent White Balance 2]: Adjusts for natural white fluorescent lighting.
	☼₃ (Fluorescent White Balance 3)	[Fluorescent White Balance 3]: Adjusts for day white fluorescent lighting.
	💡 (Incandescent)	Adjusts for places under incandescent lamp, or under bright lighting, such as in a photo studio.
	⚡^{WB} (Flash)	Adjusts for the flash conditions.
	📷 (One Push)	Adjusts the white balance depending on the light source. The white color memorized in [One Push Set] mode becomes the basic white color. Use this mode when [Auto] or other modes cannot be set the color properly.
	📷^{SET} (One Push Set)	Memorizes the basic white color which will be used in [One Push] mode.

Notes

- You cannot select [White Balance] in Intelligent Auto Adjustment, Easy Mode.
- You cannot adjust [Flash] in [White Balance] in Sweep Panorama, Movie Mode, Anti Motion Blur, Hand-held Twilight, or when Scene Selection is set to **ISO** (High Sensitivity) mode.
- Under fluorescent lights that flicker, the white balance function may not work correctly even though you select [Fluorescent White Balance 1], [Fluorescent White Balance 2] or [Fluorescent White Balance 3].
- When shooting with a flash in other than [Flash] mode, [White Balance] is set to [Auto].
- When flash is [On] or [Slow Synchro], the white balance can only be adjusted to [Auto], [Flash], [One Push], or [One Push Set].
- [One Push Set] is unable to be selected while charging the flash.

To capture the basic white color in [One Push Set] mode





- 1 Frame a white object such as a piece of paper filling the screen under the same lighting conditions as you will shoot the subject.
- 2 **MENU** → $\frac{WB}{AUTO}$ (White Balance) → [One Push Set] → [Capture]
- 3 The screen momentarily turns black, and when the white balance has been adjusted and stored in the memory, the recording screen is displayed again.

Notes



- If the  indicator flashes while shooting, the white balance is either not set or cannot be set. Use automatic white balance.
- Do not shake or strike the camera while [One Push Set] is in progress.
- When flash mode is set to [On] or [Slow Synchro], the white balance is adjusted to the condition with the flash emitting.
- The white references loaded using [White Balance] and [Underwater White Balance] are stored separately.

Effects of lighting conditions

The apparent color of the subject is affected by the lighting conditions. The color tones are adjusted automatically, but you can adjust color tones manually using the White Balance function.







Weather/lighting	Daylight	Cloudy	Fluorescent	Incandescent
Characteristics of light	White (standard) 	Bluish 	Green-tinged 	Reddish 

Underwater White Balance

Adjusts the color tone when the camera is set to  (Underwater) mode in Scene Selection or  (Underwater) mode in Movie Mode.

- 1 Lower the lens cover to switch to shooting mode.
- 2 **MENU** →  (Underwater White Balance) → desired mode → [OK]



	 (Auto)	Automatically adjusts the color tones for underwater conditions to make the colors appear natural.
	 (Underwater 1)	Adjusts for underwater conditions where blue is strong.
	 (Underwater 2)	Adjusts for underwater conditions where green is strong.
	 (One Push)	Adjusts the white balance depending on the light source. The white color memorized in [One Push Set] mode becomes the basic white color. Use this mode when [Auto] or other modes cannot be set the color properly.
	 (One Push Set)	Memorizes the basic white color which will be used in [One Push] mode (page 54).

Notes

- Depending on the color of the water, the Underwater White Balance may not work correctly even though you select [Underwater 1] or [Underwater 2].
- When flash is [On], the underwater white balance can only be adjusted to [Auto], [One Push], or [One Push Set].
- [One Push Set] is unable to be selected while charging the flash.
- The white references loaded using [White Balance] and [Underwater White Balance] are stored separately.

Focus







You can change the focus method. Use the menu when it is difficult to get the proper focus in auto focus mode.

AF stands for “Auto Focus,” a function that adjusts the focus automatically.

1 Lower the lens cover to switch to shooting mode.

2 **MENU** →  (Focus) → desired mode



✓	 (Multi AF)	<p>Focuses on a subject in all ranges of the finder frame automatically.</p> <p>When you press the shutter button halfway down in still image shooting mode, a green frame is displayed round the area that is in focus.</p> <ul style="list-style-type: none"> • When the Face Detection function is active, AF operates with priority on faces. • When Scene Selection is set to  (Underwater), focus operation is adjusted to underwater shooting. When focus is achieved by half-pressing the shutter button, a large frame is displayed in green. 	 <p>AF range finder frame (Only for still image)</p>
	 (Center AF)	<p>Focuses on a subject in the center of the finder frame automatically. Using the AF lock function together, you can compose the image the way you want.</p>	 <p>AF range finder frame</p>
	 (Spot AF)	<p>Focuses on an extremely small subject or a narrow area automatically. Using the AF lock function together, you can compose the image the way you want. Hold the camera steady so as not to misalign the subject and the AF range finder frame.</p>	 <p>AF range finder frame</p>

Notes

- When you use [Digital Zoom] or [AF Illuminator], the AF range finder frame setting is disabled and AF range finder frame is displayed as a dotted line instead. In this case, the camera works to focus on the subjects at the center of the screen.
- If you set the focus mode to other than [Multi AF], [Face Detection] is fixed to [When touched].
- The focus setting is set to [Multi AF] when shooting movies, or in Anti Motion Blur, Hand-held Twilight, Smile Shutter or Easy Mode.

💡 Quickly choosing the priority subject



Touching the screen displays a frame, and then pressing the shutter button halfway down brings the frame into focus.

Table of contents

Operation Search

MENU/Settings Search





Index

Metering Mode

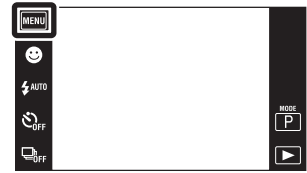
Selects the metering mode that sets which part of the subject to measure to determine the exposure.

- 1 Lower the lens cover to switch to shooting mode.
- 2 **MENU** →  (Metering Mode) → desired mode



✓	 (Multi)	Divides into multiple regions and measures each region. The camera determines a well-balanced exposure (Multi-pattern metering).
	 (Center)	Measures the center of the image, and determines the exposure based on the brightness of the subject there (Center-weighted metering).
	 (Spot)	Measures only a part of the subject (Spot metering). This function is useful when the subject is backlit or when there is strong contrast between the subject and the background. <div style="text-align: right; margin-top: 10px;">  <p>Spot metering cross hairs Positions on the subject</p> </div>

Notes

- In Movie Mode, [Spot] cannot be selected.
- Metering mode is set to [Multi] when you touch the screen to select a point to bring into focus, and when shooting in Smile Shutter or in Easy Mode.
- If you set Metering mode to other than [Multi], [Face Detection] is fixed to [When touched].

Scene Recognition

The camera automatically detects shooting conditions, and then takes the shot.









When a motion is detected, the ISO sensitivity is increased according to the movement to reduce subject blur (Motion Detection).





Example of an image when  (Backlight) is activated.

Scene Recognition icon (Guide)

The camera recognizes the following types of scenes. When the camera determines the optimal scene, it displays the corresponding icon and the guide.

-  (Twilight),  (Twilight Portrait),
-  (Twilight using a tripod),  (Backlight),
-  (Backlight Portrait),  (Landscape),
-  (Macro),  (Close Focus),  (Portrait)



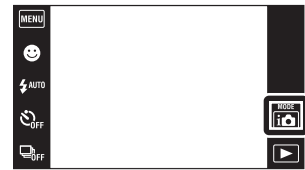

1 Lower the lens cover to switch to shooting mode.

2  (REC Mode) →  (Intelligent Auto Adjustment)

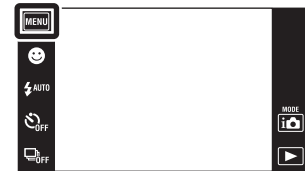

3 **MENU** → **iSCN** (Scene Recognition) → desired mode



✓	iSCN (Auto)	When the camera recognizes the scene, it switches to the optimal settings and shoots the image.
	iSCN (Advanced)	<p>When the camera recognizes the scene, it switches to the optimal settings. When the camera recognizes  (Twilight),  (Twilight Portrait),  (Twilight using a tripod),  (Backlight) or  (Backlight Portrait), it automatically changes the settings and shoots another image.</p> <ul style="list-style-type: none"> • When you shoot two images consecutively, the + mark on the iSCN icon will turn green. • When two frames are shot, the two images are displayed side by side immediately after shooting. • When [Anti Blink] is displayed, 2 images are taken automatically and the image with eyes are open is selected automatically. For details on the Anti Blink function, see “What is the Anti Blink function?”.

Notes

- The Scene Recognition function does not operate when you shoot images using Digital Zoom.
- When the shooting mode is set to burst, or when the Smile Shutter function is activated, Scene Recognition is fixed to [Auto].
- The available flash settings are [Auto] and [Off].
- 🌙 (Twilight using a tripod) scenes sometimes cannot be recognized in an environment where vibrations are transferred to the camera even though it is fixed on a tripod.
- Sometimes a slow shutter results when a scene is recognized as a 🌙 (Twilight using a tripod). Keep the camera still during shooting.
- The Scene Recognition icon appears regardless of the [Shooting Display Settings].
- These scenes may not be recognized depending on the situation.

💡 Images you can shoot with [Advanced]

In [Advanced] mode, the camera shoots two images consecutively with the settings differing as follows when it recognizes 🌙 (Twilight), 🌙 (Twilight Portrait), 🌙 (Twilight using a tripod), 📷 (Backlight) or 📷 (Backlight Portrait) scenes, which tends to blur. You can select the desired image from the two images shot.

	First Image*	Second Image
🌙	Shoot in Slow Synchro	Shoots with sensitivity increased and shake reduced
🌙	Shoot in Slow Synchro with the face which the flash strobes on as guide	Shoots with sensitivity increased with the face as guide and shake reduced
🌙	Shoot in Slow Synchro	Shoots with even slower shutter speed without increasing sensitivity
📷	Shoots with the flash	Shoots with the brightness and contrast of the background adjusted (DRO plus)
📷	Shoots with the face which the flash strobes on as guide	Shoots with the brightness and contrast of the face and the background adjusted (DRO plus)

* When flash is set to [Auto].

💡 What is the Anti Blink function?

When set to [Advanced], the camera automatically shoots two images consecutively* when it recognizes 🧑 (Portrait). The camera will select, display, and record the image which the eyes are not blinked automatically. If the eyes are closed in both images, the message “Blinked eye detected” is displayed.

* except when the flash strobes/when the shutter speed is slow

Face Detection

Detects the faces of your subjects and adjusts the focus, flash, exposure, white balance and red-eye reduction settings automatically.







Face Detection frame (Orange)

When the camera detects more than one subject, the camera will judge which is the main subject and set focus by priority. The Face Detection frame for the main subject will turn orange. The frame for which the focus is set will turn green when the shutter button is pressed halfway down.

Face Detection frame (White)

- 1 Lower the lens cover to switch to shooting mode.
- 2 **MENU** →  (Face Detection) → desired mode



	(When touched)	Detects the face when an area with a face is touched on the screen.
✓	 (Auto)	Selects the face the camera is to automatically focus on.
	 (Child Priority)	Detects and shoots with priority on child's face.
	 (Adult Priority)	Detects and shoots with priority on adult's face.



Notes

- [Face Detection] is not available in Sweep Panorama, Movie Mode or Easy Mode.
- You can select [Face Detection] only when the Focus mode is set to [Multi AF] or the Metering Mode is set to [Multi].
- The Face Detection function does not work when using the Digital Zoom.
- Up to 8 faces of your subjects can be detected.
- Adults and children may not be recognized correctly depending on the conditions.
- During Smile Shutter shooting, [Face Detection] is automatically set to [Auto] even if it is set to [When touched].

💡 Registering the priority face (Selected-face Memory)

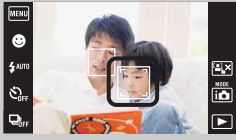
Normally the camera automatically selects the face to focus on according to the [Face Detection] setting, but you can also select and register a face to be given priority.



- ① Touch a face you want to register as the priority face during Face Detection.
The selected face is registered as the priority face, and the frame changes to an orange-colored .
 - ② Each time you touch a different face, that face is registered as the priority face.
 - ③ To cancel face registration, touch .
- When you remove the battery from the camera, the face registration is reset.
 - When the registered face disappears from the LCD screen, the camera returns to the setting selected by [Face Detection]. When the registered face is shown on the LCD screen again, the camera focuses on the registered face.
 - It may not be possible to detect the registered face correctly depending on the surrounding brightness, the subject's hairstyle, etc. In this case, register the face again under the conditions where the image will be shot.
 - When the Smile Shutter function is used with the Face Detection frame registered, Smile Detection is performed only on the registered face.
 - In Easy Mode, the priority face cannot be registered.

DRO

The camera analyzes the shooting scene and automatically corrects the brightness and contrast to improve the image quality.

DRO stands for “Dynamic Range Optimizer”, a function that automatically optimizes the difference between the light and dark parts of an image.

1 Lower the lens cover to switch to shooting mode.

2  (REC Mode) → **P** (Program Auto)



3 **MENU** →  (DRO) → desired mode







	DRO OFF (Off)	Does not adjust.
✓	DRO STD (DRO standard)	Adjusts the brightness and contrast of the images automatically.
	DRO Plus (DRO plus)	Adjusts image brightness and contrast automatically and strongly.

Notes



- Depending on shooting conditions, it may not be possible to obtain correction effects.
- Only [ISO AUTO] or values from [ISO 125] to [ISO 800] can be set for the ISO value when [DRO plus] is set.

Anti Blink

When Scene Selection is set to  (Soft Snap) while you are shooting an image, the camera automatically shoots two images consecutively. The camera will select, display and record the image which the eyes are not blinked automatically.

- 1 Lower the lens cover to switch to shooting mode.
- 2  (REC Mode) → SCN (Scene Selection) →  (Soft Snap)
- 3 **MENU** →  (Anti Blink) → desired mode



✓	 (Auto)	When Face Detection is active, the Anti Blink function operates so that images with the subject's eyes open are recorded.
	 (Off)	Does not use the Anti Blink function.

Notes



- Anti Blink does not function in the following situations.
 - When using the flash
 - During burst shooting
 - When the Face Detection function does not work
 - When the Smile Shutter function is activated
- Sometimes Anti Blink function does not work depending on the situation.
- When the Anti Blink function is set to [Auto] but only images with the subject's eyes closed are recorded, the message "Blinked eye detected" is displayed on the LCD screen. Shoot again as necessary.

Red Eye Reduction

The flash strobescs two or more times before shooting to reduce the red-eye phenomenon when using the flash.

- 1 Lower the lens cover to switch to shooting mode.
- 2 **MENU** →  (Red Eye Reduction) → desired mode



✓	 (Auto)	When the Face Detection function is activated, the flash strobescs automatically to reduce the red-eye phenomenon.
	 (On)	The flash always strobescs to reduce the red-eye phenomenon.
	 (Off)	Does not use Red Eye Reduction.

Notes

- You cannot select [Red Eye Reduction] in Sweep Panorama, Movie Mode, Anti Motion Blur, Hand-held Twilight, Smile Shutter or Easy Mode.
- To avoid blurring of images, hold the camera firmly until the shutter is released. It usually takes a second after you press the shutter button. Be also sure not to allow the subject to move during this period.
- Red Eye Reduction may not produce the desired effects. It depends on individual differences and conditions, such as distance to the subject, or if the subject looked away from the pre-strobe.
- If you do not use the Face Detection function, Red Eye Reduction does not work, even when you select [Auto].

What causes the red-eye phenomenon?

Pupils become dilated in dark environments. Flash light is reflected off the blood vessels at the back of the eye (retina), causing the “red-eye” phenomenon.

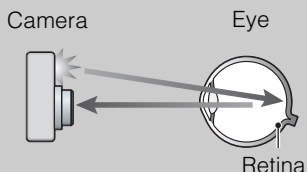

Other ways to reduce red-eye



- Select  (High Sensitivity) mode in Scene Selection. (The flash is automatically turned to [Off].)
- When the eyes of the subject turn out red, correct the image with [Retouch] → [Red Eye Correction] on the viewing menu or with the supplied software “PMB”.

SteadyShot

Selects the anti-blur mode.

- 1 Lower the lens cover to switch to shooting mode.
- 2 **MENU** →  (SteadyShot) → desired mode





✓	 (Shooting)	Activates the anti-blur function when pressing the shutter button halfway down.
	 (Continuous)	Always activates the anti-blur function. You can stabilize images even when zooming up a far subject.
	 (Off)	Does not use anti-blur mode.

Notes

- In Intelligent Auto Adjustment mode, Easy Mode or Scene Selection is set to  (Gourmet) mode, [SteadyShot] is set to [Shooting].
- [SteadyShot] is fixed to [Continuous] in Sweep Panorama, or Smile Shutter function is activated.
- For movies, you can set [Continuous] or [Off] only. The default setting for movies is set to [Continuous].
- The battery charge is used up more quickly in [Continuous] mode than in [Shooting] mode.

Hints for preventing blur

The camera moved accidentally when you took the image. This is called “Camera shake.” On the other hand, if the subject moved when you took the image, it is called “subject blur.” Besides, camera shake and subject blur occur frequently under low-light or slow shutter speed conditions, such as those encountered in  (Twilight Portrait) or  (Twilight) mode. In such case, shoot with the below tips in mind.

Camera shake

Your hands or body shake while you hold the camera and press the shutter button, and the entire screen is blurred.

- Use a tripod or place the camera on a flat surface to hold the camera steady.
- Shoot with a 2-second delay self-timer and stabilize the camera by holding your arms firmly at your side after pressing the shutter button.
- Use [Hand-held Twilight] mode.

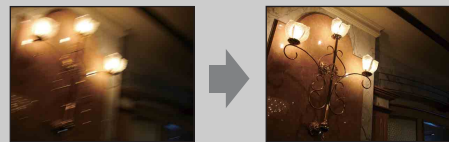

Subject blur

Even though the camera is steady, the subject moves during the exposure so the subject looks blurred when the shutter button is pressed. Camera shake is reduced automatically using the anti-blur function. However, the function does not effectively reduce subject blur.

- Shoot in Anti Motion Blur or  (High Sensitivity) mode in Scene Selection.
- Select a higher ISO sensitivity to make the shutter speed faster, and press the shutter button before the subject moves.

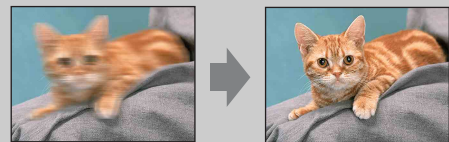



Shooting Display Settings

Sets whether to display the operation buttons on the LCD screen in shooting mode.

- 1 Lower the lens cover to switch to shooting mode.
- 2 **MENU** →  (Shooting Display Settings) → desired mode



✓	 (On)	Displays the operation buttons.	
	 (Off)	Does not display the operation buttons.	

 To display the operation buttons when [Shooting Display Settings] is set to [Off]

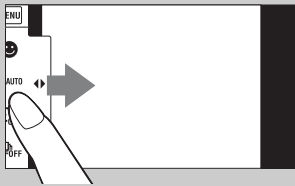

Touch the left side of the LCD screen and drag right.

Easy Mode

When viewing still images in Easy Mode, the playback screen text becomes larger, indicators become easier to see, and fewer functions can be used.

- 1 Press the  (Playback) button to switch to playback mode.
- 2 **MENU** → **EASY** (Easy Mode) → [OK]





Notes



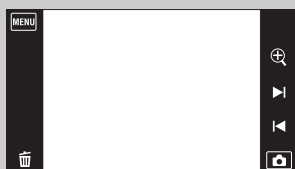



- The battery charge is used up more quickly because the screen brightness increases automatically.
- The shooting mode also changes to [Easy Mode].

Functions available in Easy Mode (Viewing)



 (Delete) : Deletes the currently displayed image.

 (Zoom) : Enlarges the displayed image.

- Drag up, down, right or left, or touch  to change the zoom position. Touch  to change the zoom magnification.



MENU : Touch [Delete Single Image] to delete the currently displayed image.

: Touch [Delete All Images] to delete all images in that folder.

: Touch [Exit Easy Mode] to exit Easy Mode.



Calendar

This feature selects the date to be played back on the calendar when using Date View. Step 2 is unnecessary when [Date View] is already set.

- 1 Press the  (Playback) button to switch to playback mode.
- 2 **MENU** →  (View Mode) →  (Date View)

- 3 Touch  (Calendar).

When the buttons are not displayed on the left side of the LCD screen, touch **MENU**.

- 4 Select the month you want to display with /, then touch the desired date.

Drag the thumbnails of images for the selected date up or down to change the page. Touch an image to return to the single-image screen for that image.

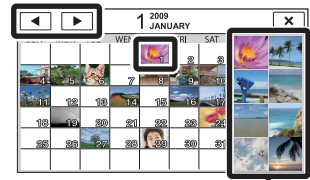
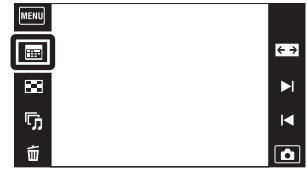
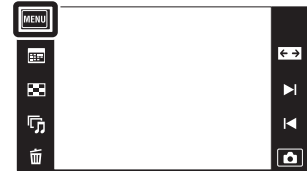

Images for the selected date

Note

- This item is not displayed when the internal memory is used to record images.

Image Index

Displays multiple images at the same time.



- 1 Press the  (Playback) button to switch to playback mode.
- 2 Touch  (Image Index).
When the buttons are not displayed on the left side of the LCD screen, touch **MENU**.
- 3 Touch the screen and drag up or down to change the page.
Touch an image on the index screen to return to the single-image screen for that image.



Table of contents



Operation Search

MENU/Settings Search



Index

Slideshow

Images are automatically played back in succession.

- 1 Press the  (Playback) button to switch to playback mode.
- 2 Touch  (Slideshow) → desired mode.
When the buttons are not displayed on the left side of the LCD screen, touch **MENU**.



 (Continuous Playback)	Plays back all the images in succession.
 (Slideshow with music)	Plays back still images in succession along with effects and music.

Continuous Playback

- 1 Select the image to start playback.
- 2 Touch  (Slideshow) → [Continuous Playback].
- 3 To end continuous playback, touch the LCD screen, and then touch [Exit Continuous Playback].
 - Touch \llcorner/\lrcorner on the LCD screen to adjust the movie volume.

Viewing panoramic images during continuous playback

The whole panoramic image is displayed for 3 seconds.
You can scroll a panoramic image by touching .

Note



- When [Display Burst Group] is [Display Main Image Only], only the main image is displayed.

Slideshow with music

- 1 Touch  (Slideshow) → [Slideshow with music].
- 2 Touch desired mode → [Start].
- 3 To exit slideshow, touch the screen, then select from [Exit Slideshow].

Note

- [Slideshow with music] is not available for panoramic images and movies.



Image		
Selects the group of images to be shown. This setting is fixed to [Folder] when the internal memory is used to record images.		
<input checked="" type="checkbox"/>	All	Plays a slideshow of all the still images in order.
<input type="checkbox"/>	This Date	Plays a slideshow of still images with the currently selected date range when View Mode is  (Date View).
<input type="checkbox"/>	Folder	Plays a slideshow of still images in the currently selected folder when View Mode is  (Folder View).

Effects		
Selects the playback speed and mood for slideshows.		
<input checked="" type="checkbox"/>	Simple	A simple slideshow switching still images at a preset interval. The playback interval is adjustable in [Interval] and you can thoroughly enjoy your images.
<input type="checkbox"/>	Nostalgic	A moody slideshow reproducing the atmosphere of a movie scene.
<input type="checkbox"/>	Stylish	A stylish slideshow proceeding at a middle tempo.
<input type="checkbox"/>	Active	A high-tempo slideshow suitable for active scenes.

Note

- When [Display Burst Group] is set to [Display Main Image Only], the burst images are displayed as follows.
 - When [Effects] is set to [Simple], only the main image is displayed.
 - When [Effects] is set to other than [Simple] and there are two or fewer burst images, only the main image is displayed.
 - When [Effects] is set to other than [Simple] and there are three or more burst images, three images including the main image are displayed.

Music

Specifies the music to be played during slideshows. You can select more than one background music track. Touch  to listen to each BGM. Touch / at the bottom of the LCD screen to adjust the BGM volume.

	Mute	Does not use BGM.
✓	Music1	The default setting for a [Simple] slideshow.
	Music2	The default setting for a [Nostalgic] slideshow.
	Music3	The default setting for a [Stylish] slideshow.
	Music4	The default setting for a [Active] slideshow.

Interval

Sets the screen switching interval. The setting is fixed to [Auto] when [Simple] is not selected as the [Effects].

	1 sec	Sets the display interval of images for a [Simple] slideshow.
✓	3 sec	
	5 sec	
	10 sec	
	Auto	The interval is set to suit the selected [Effects] item.

Repeat

Turns slideshow repeat on or off.

✓	On	Plays back images in a continuous loop.
	Off	After all the images have been played back, the slideshow ends.

Selecting background music

You can transfer a desired music file from your CDs or MP3 files to the camera to play back during slideshow. To transfer music, install the “Music Transfer” software (supplied) to your computer. For details, see pages 118 and 119.

- You can record up to four pieces of music on the camera (The 4 preset pieces (Music1 – Music4) can be replaced with the ones you transferred).
- A maximum length of each music file for music playback of the camera is about 5 minutes.
- If you cannot play back a music file due to damage or other malfunctions of the file, execute [Format Music] (page 104) and transfer the music again.

Delete







Allows you to select unwanted images for deletion.

1 Press the  (Playback) button to switch to playback mode.

2  (Delete) → desired mode

When the buttons are not displayed on the left side of the LCD screen, touch **MENU**.



 (This Image)	Deletes the currently displayed image in single-image mode.
 (Multiple Images)	Allows you to select and delete multiple images. Do as the following after step 2. ① Touch the image you want to delete. Repeat the above steps until there are no more images to be deleted. Touch an image with a ✓ mark again to release the ✓ mark. ② Touch [OK] → [OK].
 (All in This Folder)  (All in Date Range)  (All In This Group)	Deletes all images in the selected folder, date range or burst group at once. After step 2, touch [OK].
 (All but this image)	Deletes burst group images other than the selected image in Display Burst Group mode. After step 2, touch [OK].

Note



- When the internal memory is used to record images, View Mode is set to [Folder View].

In Easy Mode

Delete Single Image	Deletes the currently displayed image.
Delete All Images	Deletes all images in that folder.

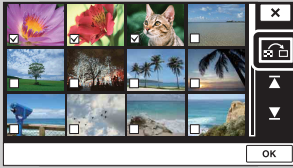
 You can switch between index and single-image mode when selecting images



Touch  to return to the single-image screen, and touch  on the single-image screen to return to the index screen.

- You can also switch between index and single-image mode in [Protect], [DPOF] or [Print].

Paint

Paints or adds stamps to a still image and records it as a new file.



- 1 Press the (Playback) button to switch to playback mode.

When using the internal memory, touch (Paint) on the left side of the LCD screen.

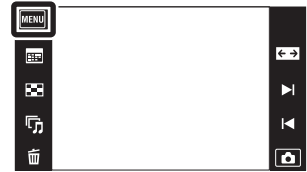

- 2 **MENU** → (Paint)
- 3 Draw on the image using the paint pen (supplied).
- 4 Touch the button → select the saved image size

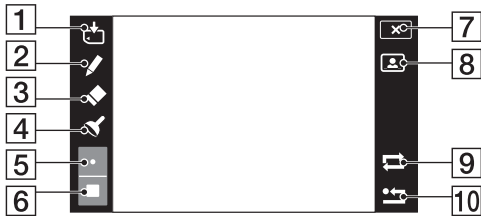



	Button	Action
1		Save Saves the image in VGA or 3M format in the internal memory or on a “Memory Stick Duo” media.
2		Pen Paint characters or graphics.
3		Eraser Make corrections.
4		Stamp Apply a stamp to the image.
5		Thickness/Stamps Select the pen or eraser thickness, or the stamp.
6		Color Select the color.
7		Exit Exit paint mode.
8		Frame Add a frame. Select the desired frame with / .
9		Revert Undo the last action.
10		Clear all Erase all painting.

Note











- You cannot paint or put stamps on panoramic images, images displayed in a burst group and movies.

Retouch

Adds effects or makes corrections to a recorded image and records it as a new file. The original image is retained.

- 1 Press the  (Playback) button to switch to playback mode.
- 2 **MENU** →  (Retouch) → desired mode
- 3 Perform retouching according to the operation method in each mode.





 (Trimming)	<p>Records the zoomed playback image.</p> <p>Touch / → set the point with /// → NEXT → select an image size to save with / → NEXT → [OK]</p> <ul style="list-style-type: none"> • The quality of trimmed images may deteriorate. • The image size that you can trim may vary depending on the image. 	
 (Red Eye Correction)	<p>Corrects the red-eye phenomenon caused by flash.</p> <p>After red eye correction is completed, touch [OK].</p> <ul style="list-style-type: none"> • You may not be able to correct the red-eye phenomenon depending on the image. 	
 (Unsharp masking)	<p>Sharpens the image within a chosen frame.</p> <p>Touch the area (frame) of the desired image to retouch → NEXT → [OK]</p> <ul style="list-style-type: none"> • Depending on the image, sufficient correction may not be applied and the image quality may deteriorate. 	

Note



- You cannot retouch panoramic images, images displayed in a burst group, and movies.

Display Burst Group

You can select to display burst images in groups or display all images during playback.

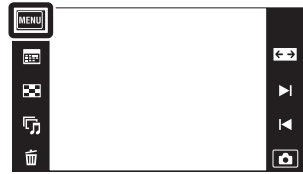
- 1 Press the  (Playback) button to switch to playback mode.
- 2 **MENU** →  (Display Burst Group) → desired mode



✓	 (Display Main Image Only)	Groups burst images, then plays back the main images only. <ul style="list-style-type: none"> • When Face Detection is performed in burst mode, the camera determines and displays the optimum image as the main image. When Face Detection is not performed, the first image in the burst group is displayed as the main image.
	 (Display All)	Plays back all burst images one at a time.

Note

- When View Mode is set to [Folder View], [Display Burst Group] is fixed to [Display All].

Displaying burst images side by side



In [Display Main Image Only] mode, the images in a burst group can be displayed side by side.





- ① Display the main image in playback mode.
- ② Touch an image.
The images in that burst group are displayed side by side at the bottom of the LCD screen.
- ③ Touch  to display the desired image.
You can also display the image by touching the thumbnail image at the bottom of the LCD screen. Thumbnail image display at the bottom of the LCD screen can be turned on/off by touching the screen.

View Mode

Allows you to select the display format for viewing images.

- 1 Press the  (Playback) button to switch to playback mode.
- 2 **MENU** →  (View Mode) → desired mode



<input checked="" type="checkbox"/>	 (Date View)	Displays images by the date.
<input type="checkbox"/>	 (Folder View)	Displays images organized by folders.

Notes

- When using the internal memory, the View Mode is set to [Folder View].
- Event View is not available on this camera.

Viewing images taken with a different camera



If you insert into this camera a “Memory Stick Duo” media containing images taken both with this camera and another camera, a screen for selecting the playback method appears.

Playback only registered images: Images are played back in the selected View Mode. Some images taken with other cameras may not be played back.









Playback all images with folder view: The View Mode is switched to Folder View and all images are played back.

Protect

Protects recorded images against accidental erasure.
The  mark is displayed for registered images.

- 1 Press the  (Playback) button to switch to playback mode.
- 2 **MENU** →  (Protect) → desired mode



 (This Image)	Protects the currently displayed image in single-image mode.
 (Multiple Images)	You can select and protect multiple images. After step 2, perform the following. ① Select an image to be protected, then touch it. Repeat the above steps until there are no more images to be protected. Touch an image with a  mark again to release the  mark. ② Touch [OK] → [OK].
 (Set All in This Folder)	Protects/unlocks all images in the folder when the View Mode is [Folder View]. Touch [OK] after step 2.
 (Remove All in This Folder)	
 (Set All in Date Range)	Protects/unlocks all images in the date range when the View Mode is [Date View]. Touch [OK] after step 2.
 (Remove All in Date Range)	

Note







- When using the internal memory, the View Mode is set to [Folder View].

DPOF

DPOF (Digital Print Order Format) is a function that allows you to specify the images of “Memory Stick Duo” media that you want to print out later. The **DPOF** (Print order) mark is displayed for registered images.

- 1 Press the  (Playback) button to switch to playback mode.
- 2 **MENU** → **DPOF** → desired mode



DPOF  (This Image)	Orders printing the currently displayed image in single-image mode.
DPOF  (Multiple Images)	You can select and order printing multiple images. After step 2, perform the following. ① Select an image to be printed, then touch it. Repeat the above steps until there are no more images to be printed. Touch an image with a ✓ mark again to release the ✓ mark. ② Touch [OK] → [OK]
DPOF  ON (Set All in This Folder)	Sets/cancels print order for all images in the folder when the View Mode is [Folder View]. Touch [OK] after step 2.
DPOF  OFF (Remove All in This Folder)	
DPOF  ON (Set All in Date Range)	Sets/cancels print order for all images in the date range when the View Mode is [Date View]. Touch [OK] after step 2.
DPOF  OFF (Remove All in Date Range)	



Notes

- The **DPOF** (Print order) mark cannot be added to movies or to images in the internal memory.
- You can add a **DPOF** (Print order) mark to a maximum 999 images.

Rotate

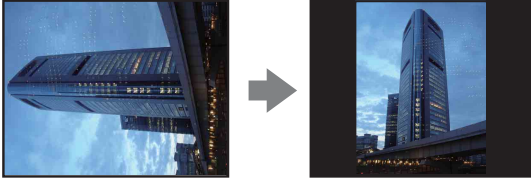
Rotates a still image. Use this function to display a horizontal orientation image in vertical orientation.



- 1 Press the  (Playback) button to switch to playback mode.
- 2 **MENU** →  (Rotate)
- 3  → [OK]







Notes

- You cannot rotate movies, images displayed in a burst group, and protected still images.
- You may not be able to rotate images shot with other cameras.
- When viewing images on a computer, the image rotation information may not be reflected depending on the software.



Volume Settings

Adjusts the volume for slideshow and movie playback.

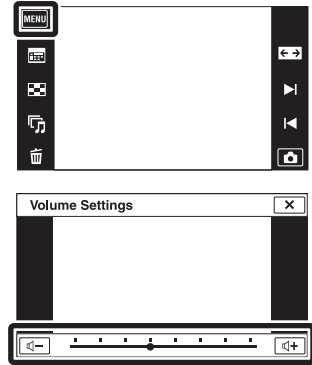
- 1 Press the  (Playback) button to switch to playback mode.
- 2 **MENU** →  (Volume Settings)
- 3 Adjust the volume by touching  → 
You can also adjust the volume by touching  in the volume adjustment bar and dragging to the right or left.





Adjusting the volume during playback of a movie or slideshow

Movie playback: Touch the LCD screen to display the operation buttons, then touch  and then  to adjust the volume. Touch  to turn off the volume control screen.



Slideshow: Touch the screen to display the volume control screen, then touch the  buttons to adjust the volume.

Playback Display Settings

Sets whether to display the operation buttons on the LCD screen in viewing mode.

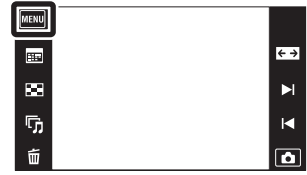
- 1 Press the  (Playback) button to switch to playback mode.
- 2 **MENU** →  (Playback Display Settings) → desired mode

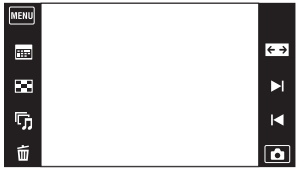

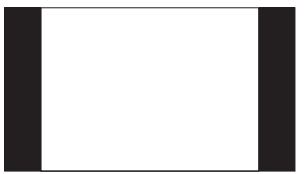
<input checked="" type="checkbox"/>	 (On)	Displays the operation buttons.	
<input type="checkbox"/>	 (Off)	Does not display the operation buttons.	

 To display the operation buttons when [Playback Display Settings] is set to [Off]

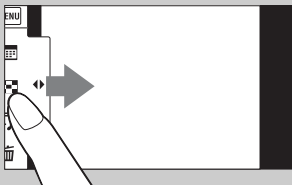



Touch the left side of the LCD screen and drag right.

Exposure data

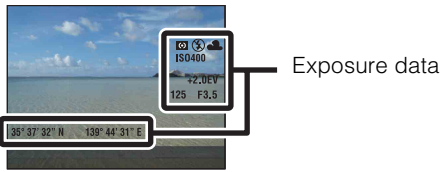
This sets whether or not to display the shooting data of the currently displayed file.



- 1 Press the  (Playback) button to switch to playback mode.
- 2 **MENU** →  (Exposure data) → desired mode









 (On)	Displays the shooting data on the LCD screen.
<input checked="" type="checkbox"/>  (Off)	Does not display the shooting data.

Image index settings

Sets the number of images displayed in the index screen.

- 1 Press the  (Playback) button to switch to playback mode.
- 2 **MENU** →  (Image index settings) → desired mode









	 (12-up)	Displays 12-up images.
✓	 (28-up)	Displays 28-up images.

Select Folder

When multiple folders are created on a “Memory Stick Duo” media, this function selects the folder containing the image you want to play back.

Step 2 is unnecessary when [Folder View] is already set.

- 1 Press the  (Playback) button to switch to playback mode.
- 2 **MENU** →  (View Mode) →  (Folder View)
- 3 **MENU** →  (Select Folder) → select the folder with / → [OK]





Note

- This item is not displayed when the internal memory is used to record images.





Viewing images across multiple folders

When multiple folders are created and the first or last image in the folder is displayed, the following indicators appear.

- : Moves to the previous folder
- : Moves to the next folder
- : Moves to either the previous or next folders

AF Illuminator





The AF illuminator supplies fill light to focus more easily on a subject in dark surroundings. The AF illuminator emits red light allowing the camera to focus easily when the shutter button is pressed halfway, until the focus is locked. The **AF-ON** indicator appears at this time.

- 1 **MENU** →  (Settings) →  (Shooting Settings) → [AF Illuminator] → desired mode





✓	Auto	Uses the AF illuminator.
	Off	Does not use AF illuminator.

Notes

- Focus is achieved as long as the AF illuminator light reaches the subject, regardless of whether light fails to reach the center of the subject.
- You cannot use the AF illuminator when:
 - Shooting in Sweep Panorama mode
 -  (Landscape),  (Twilight),  (Pet),  (Fireworks) or  (Hi-Speed Shutter) mode is selected in Scene Selection.
 - [Housing] is set to [On].
- When you use AF illuminator, the normal AF range finder frame is disabled and a new AF range finder frame is displayed by a dotted line. AF operates with priority on subjects located near the center of the frame.
- The AF illuminator emits very bright light. Although there is no health hazard, do not look directly into the AF illuminator emitter at close range.

Grid Line

With reference to the grid lines, you can easily set a subject in a horizontal/vertical position.



- 1 **MENU** →  (Settings) →  (Shooting Settings) → [Grid Line] → desired mode



	On	Displays the grid lines. The grid lines are not recorded.
✓	Off	Does not display the grid lines.

Digital Zoom

Selects the Digital Zoom mode. The camera enlarges the image using optical zoom (up to 4×). When the zoom scale is exceeded, the camera uses either smart or precision Digital Zoom.

- 1 **MENU** →  (Settings) →  (Shooting Settings) → [Digital Zoom] → desired mode

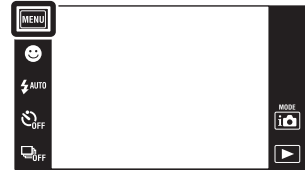

✓	Smart (sQ)	Enlarges the image digitally within the range where the image will not be distorted, according to the image size. (Smart zoom)
	Precision (pQ)	Enlarges all image sizes by the total zoom scale of approximately 8×, including the optical zoom 4×. However, note that the image quality deteriorates when the optical zoom scale is exceeded. (Precision digital zoom)
	Off	Does not use the Digital Zoom.

Notes

- The Digital Zoom function does not operate in Sweep Panorama, Movie Mode or when the Smile Shutter function is activated.
- The smart zoom is not available when the image size is set to [10M], [3:2(8M)] or [16:9(7M)].
- The Face Detection function does not work when using the Digital Zoom.



Total zoom scale when using Smart zoom (including optical zoom 4×)

The supported zoom ratio differs depending on the image size.

Size	Total zoom scale
5M	Approx. 5.6×
3M	Approx. 7.1×
VGA	Approx. 22×
16:9(2M)	Approx. 7.6×

Auto Orientation

When the camera is rotated to shoot a portrait (vertical) image, the camera records its position change and displays the image in the portrait position.

- 1 **MENU** →  (Settings) →  (Shooting Settings) → [Auto Orientation] → desired mode



<input checked="" type="checkbox"/>	On	Records the image with the correct orientation.
<input type="checkbox"/>	Off	Does not use Auto Orientation.

Notes

- Black is displayed to the left and right of vertical orientation images.
- Depending on the shooting angle of the camera, the orientation of the image may not be recorded correctly.
- You cannot use [Auto Orientation] when  (Underwater) is selected in the Scene Selection or when shooting movies.
- Sometimes the Auto Orientation function does not operate when you use the AC Adaptor (sold separately) and the USB/AV/DC IN Cable for multi-use terminal (sold separately).

Rotating images after recording



If the orientation of an image is incorrect, you can use the [Rotate] on the MENU screen to display the image in portrait position.

Scene Recog. Guide

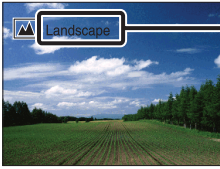
You can select whether or not the guide is displayed next to the Scene Recognition icon when Scene Recognition is activated.



Scene Recognition Guide



- 1 **MENU** →  (Settings) →  (Shooting Settings) → [Scene Recog. Guide] → desired mode



✓	On	Displays the Scene Recognition Guide.
	Off	Does not display the Scene Recognition Guide.

Blink Alert

When an image with the subject's eyes closed is recorded while Face Detection is activated, the message "Blinked eye detected" is displayed on the LCD screen.



- 1 **MENU** →  (Settings) →  (Shooting Settings) → [Blink Alert] → desired mode



✓	Auto	Displays the "Blinked eye detected" message.
	Off	Does not display the message.

Beep

Selects or turns off the sound produced when you operate the camera.

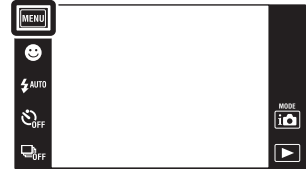

- 1 **MENU** →  (Settings) →  (Main Settings) →
[Beep] → desired mode



	Shutter	Turns on the shutter sound when you press the shutter button.
✓	High	Turns on the beep/shutter sound when you operate the touch panel/ press the shutter button.
	Low	If you want to lower the volume, select [Low].
	Off	Turns off the beep/shutter sound.

LCD Brightness

This sets the brightness of the LCD screen.

- 1 **MENU** →  (Settings) →  (Main Settings) → [LCD Brightness] → desired mode

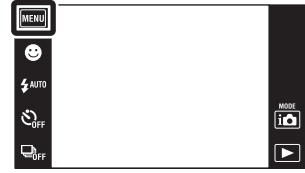



✓	Normal	Sets the LCD screen to normal brightness.
	Bright	Sets the LCD screen to high brightness. <ul style="list-style-type: none">• This function is useful when viewing images in bright outside light.

Notes

- In [Bright] mode, the battery power may decrease faster.
- If the camera is running on and you do not operate the camera for about one minute, the LCD screen becomes dark.

Language Setting



Selects the language to be used in the menu items, warnings and messages.

- 1 **MENU** →  (Settings) →  (Main Settings) → [Language Setting] → desired mode





Demo Mode

You can set whether to use a demonstration of the Scene Recognition and Smile Shutter. When there is no need to view a demonstration, set to [Off].

- 1 **MENU** →  (Settings) →  (Main Settings) → [Demo Mode] → desired mode



- 2  (REC Mode) →  (Intelligent Auto Adjustment)



	Demo Mode1	Demonstrates Scene Recognition mode.
	Demo Mode2	Automatically starts the Smile Shutter demonstration when no operation is performed for 15 seconds.
✓	Off	Does not perform a demonstration.



Note

- Pressing the shutter button during the Smile Shutter demonstration operates the shutter, but no image is recorded.

Initialize

Initializes the setting to the default setting.

Even if you execute this function, the images are retained.

- 1 **MENU** →  (Settings) →  (Main Settings) → [Initialize] → [OK]

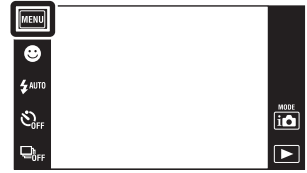



Note

- Be sure not to turn off the camera while initializing.

COMPONENT

Selects the video signal output type from either SD or HD (1080i) in accordance with the type of TV you connect to the camera using an HD Output Adaptor Cable (sold separately). Use a Type1a-compliant HD Output Adaptor Cable (sold separately).

- 1 **MENU** →  (Settings) →  (Main Settings) → [COMPONENT] → desired mode

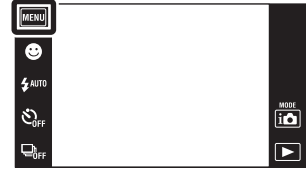



✓	HD(1080i)	Select this item to connect the camera to a 1080i-capable High Definition TV.
	SD	Select this item to connect the camera to a TV that is not compatible with an HD(1080i) signal.

Note

- When you shoot movies in the condition where the camera and a TV are connected using an HD Output Adaptor Cable (sold separately), the image being shot is not displayed at the TV side.

Video Out

Sets the video signal output according to the TV color system of the connected video equipment. The TV color systems differ depending on the country and region. To view images on a TV screen, check the TV color system of the country or region of use (page 116).



- 1 **MENU** →  (Settings) →  (Main Settings) → [Video Out] → desired mode



NTSC	Sets the video output signal to NTSC mode (e.g., for the USA, Japan).
PAL	Sets the video output signal to PAL mode (e.g., for Europe, China).

Housing

Displays the dedicated operation buttons when the camera is installed in the Housing (Marine Pack). Refer also to the operating instructions supplied with the Housing.

- 1 **MENU** →  (Settings) →  (Main Settings) → [Housing] → desired mode

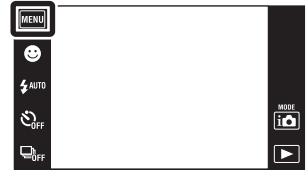



	On	Changes the function of the buttons.
✓	Off	Does not change any functions.

Notes

- Objects cannot be brought into focus by touching the screen.
- Some functions are limited, and the icon positions on the LCD screen change.

USB Connect

Sets the mode when the camera is connected to a computer or a PictBridge-compliant printer using the cable for multi-use terminal.

- 1 **MENU** →  (Settings) →  (Main Settings) → [USB Connect] → desired mode

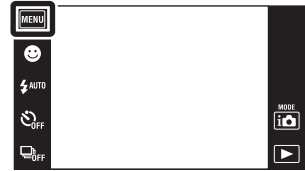



✓	Auto	The camera recognizes automatically and sets up communication with a computer or PictBridge-compliant printer.
	PictBridge	Connects the camera to a PictBridge-compliant printer.
	PTP/MTP	When you connect the camera to a computer, the AutoPlay Wizard appears, and the still images in the recording folder on the camera are imported to the computer. (with Windows Vista/XP, Mac OS X)
	Mass Storage	Establishes a Mass Storage connection between the camera and a computer or other USB device.

Notes

- If you cannot connect the camera to a PictBridge-compliant printer with the [Auto] setting, select [PictBridge].
- If you cannot connect the camera to a computer or a USB device with the [Auto] setting, select [Mass Storage].
- You cannot import movies when [PTP/MTP] is selected. To import movies to the computer, select [Auto] or [Mass Storage].

Download Music

You can use “Music Transfer” in the CD-ROM (supplied) to change background music tracks.

- 1 **MENU** →  (Settings) →  (Main Settings) → [Download Music]



The message “Change slideshow music Connect to PC” is displayed.

- 2 Make a USB connection between the camera and a computer, then start “Music Transfer”.
- 3 Follow the instructions on the screen to change music files.



Format Music

You can delete all the background music files stored in the camera. It can be used in cases such as when the background music files are damaged and cannot be played.

- 1 **MENU** →  (Settings) →  (Main Settings) → [Format Music] → [OK]

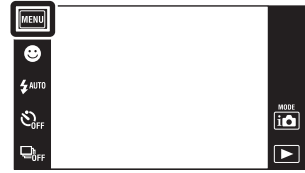



Restoring the music preset at the factory to the camera

You can use “Music Transfer” in the CD-ROM (supplied) to reset music files to the preset ones.

- ① Execute [Download Music], then make a USB connection between the camera and a computer.
- ② Start “Music Transfer”, then restore the default music.
 - For details on using “Music Transfer”, see the help in “Music Transfer”.

Calibration

Enables you to perform calibration when the touch panel buttons do not react at the appropriate points where you touch.

1 **MENU** →  (Settings) →  (Main Settings) → [Calibration]

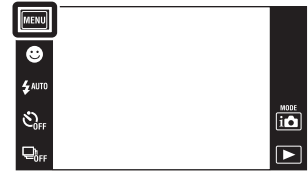

2 Using the paint pen, touch the center of the × mark displayed on the screen in order.

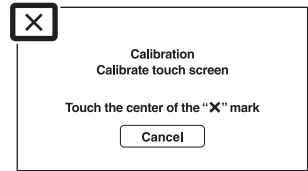



Notes

- To stop the calibration process mid-way, touch [Cancel]. The adjustments made up to that point are not effected.
- If you fail to touch the right spot, the calibration is not performed. Touch the center of the × mark again.

Format

Formats the “Memory Stick Duo” media or the internal memory. A commercially available “Memory Stick Duo” media is already formatted, and can be used immediately.

- 1 **MENU** →  (Settings) →  (“Memory Stick” Tool) or  (Internal Memory Tool) → [Format] → [OK]

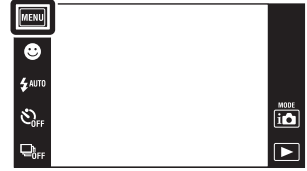



Note

- Note that formatting permanently erases all data including even protected images.

Create REC.Folder

Creates a folder in the “Memory Stick Duo” media for recording images.

Images are recorded in the newly created folder until you create another folder or select another recording folder.

- 1 **MENU** →  (Settings) →  ("Memory Stick" Tool) → [Create REC.Folder] → [OK]



Notes

- This item is not displayed when the internal memory is used to record images.
- When you insert a “Memory Stick Duo” media that was used with other equipment into the camera and shoot images, a new folder is automatically created.
- Up to 4,000 images can be stored in one folder. When the folder capacity is exceeded, a new folder is automatically created.





On the folders

- After a new folder is created, you can change the storage destination folder (page 108) and select the folder for viewing images (page 87).

Change REC.Folder

Changes the folder in the “Memory Stick Duo” media that is currently used for recording images.

1 **MENU** →  (Settings) →  (“Memory Stick” Tool) → [Change REC.Folder]

2 Select the folder you want to record → [OK].

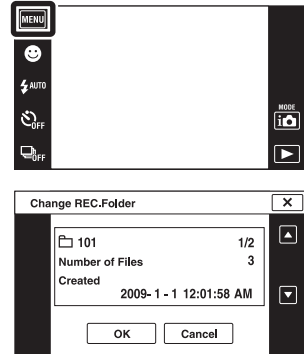

Notes

- This item is not displayed when the internal memory is used to record images.
- You cannot select the following folder as a recording folder.
 - “100” folder
 - A folder with a number that has either “□□□MSDCF” or “□□□MNV01” only.
- You cannot move recorded images to another folder.

Delete REC.Folder

Deletes a folder in the “Memory Stick Duo” media that is currently used for recording images.

- 1 **MENU** →  (Settings) →  (“Memory Stick” Tool) → [Delete REC.Folder]

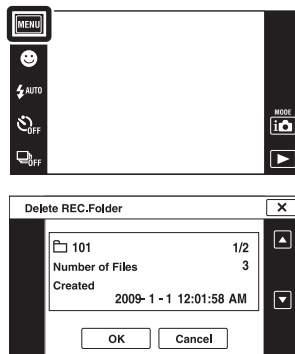

- 2 Select the folder you want to delete → [OK].



Notes

- This item is not displayed when the internal memory is used to record images.
- If you delete the folder set as the recording folder using [Delete REC.Folder], the folder that has the largest folder number is selected as the next recording folder.
- You can delete only empty folders. If a folder contains images, or even files that cannot be played back by the camera, first delete these images and files, and then delete the folder.

Copy

Copies all images in the internal memory to a “Memory Stick Duo” media.

1 Insert a “Memory Stick Duo” media with sufficient free space into the camera.

2 **MENU** →  (Settings) →  (“Memory Stick” Tool) → [Copy] → [OK]





Notes

- Use a fully charged battery pack. If you attempt to copy image files using a battery pack with little remaining charge, the battery pack may run out, causing copying to fail or possibly corrupting the data.
- You cannot copy images individually.
- The original images in the internal memory are retained even after copying. To delete the contents of the internal memory, remove the “Memory Stick Duo” media after copying, then format the internal memory ([Format] in [Internal Memory Tool]).
- A new folder is created on the “Memory Stick Duo” media and all the data will be copied to it. You cannot choose a specific folder and copy images to it.

File Number

Selects the method used to assign file numbers to images.

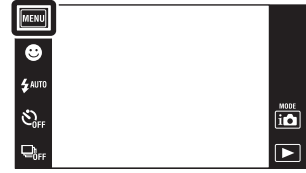

- 1 **MENU** →  (Settings) →  ("Memory Stick" Tool) or  (Internal Memory Tool) → [File Number] → desired mode



✓	Series	Assigns numbers to files in sequence even if the recording folder or the "Memory Stick Duo" media is changed. (When the replaced the "Memory Stick Duo" media contains a file with a number higher than the last assigned number, a number one higher than the largest number is assigned.)
	Reset	Starts from 0001 each time the folder is changed. (When the recording folder contains a file, a number one higher than the largest number is assigned.)

Area Setting

Adjusts the time to the local time of a selected area.

- 1 **MENU** →  (Settings) →  (Clock Settings) → [Area Setting] → desired mode

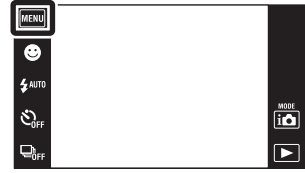



✓	Home	You use the camera in your area. When the currently set area differs from your home area, you must make the Area Setting.
	Destination	You use the camera set to the time at your destination. Set the destination area.

Changing Area Setting

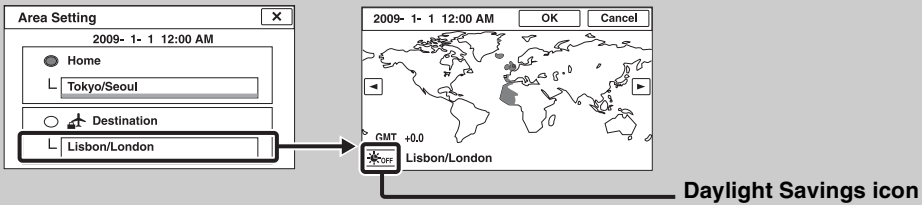

Setting a frequently visited destination lets you easily adjust the time when you visit that destination.



- ① Touch the “Destination” area, and then select the area using /  and touch [OK].
- ② Touch Daylight Savings icon, then select Daylight Savings On/Off.

Date & Time Setting

Sets the date and time again.

- 1 **MENU** →  (Settings) →  (Clock Settings)
→ [Date & Time Setting] → desired mode

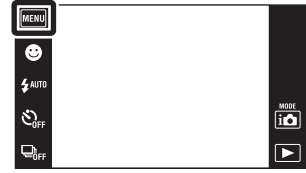

Date & Time Format	You can select the date and time display format.
Daylight Savings	You can select Daylight Savings [On]/[Off].
Date & Time	You can set the date and time.

Note

- The camera does not have a feature for superimposing dates on images. By using “PMB” in the CD-ROM (supplied), you can print or save images with the date.

Viewing an image on a SD TV

You can view images recorded on the camera in standard picture quality by connecting the camera to an SD (Standard Definition) TV. Refer also to the operating instructions supplied with the TV.

- 1 Turn off both the camera and the TV.
- 2 Connect the camera to the TV with the cable for multi-use terminal (supplied).

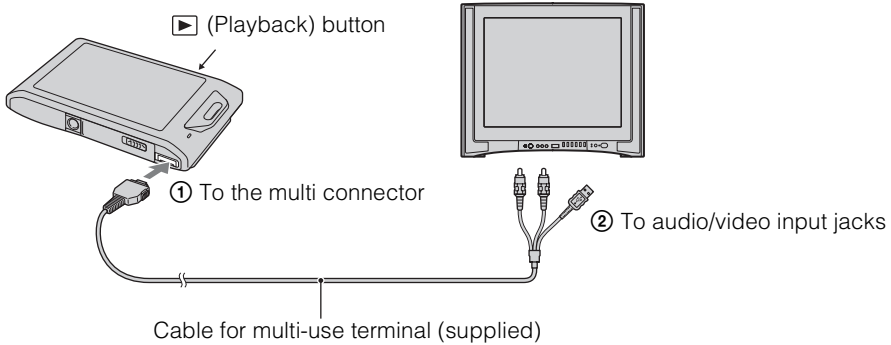

- 3 Turn on the TV and set the input.
- 4 Press ▶ (Playback) button to turn on the camera.

Images shot with the camera appear on the TV. Touch ▶/◀ displayed on the LCD screen of this camera to select the desired image.

Notes

- When you play back a single image, no icons are displayed on the TV.
- You cannot play back images in [Easy Mode] during TV output.
- When you shoot movies while the camera and a TV are connected, the image being shot is not displayed on the TV.
- When using the camera abroad, it may be necessary to switch the video signal output to match that of your TV system (page 100).

Viewing an image on an HD TV

You can view images recorded on the camera in high picture quality by connecting the camera to an HD (High Definition) TV using the HD Output Adaptor Cable (sold separately). Use a Type 1a-compliant HD Output Adaptor Cable.

Refer also to the operating instructions supplied with the TV.

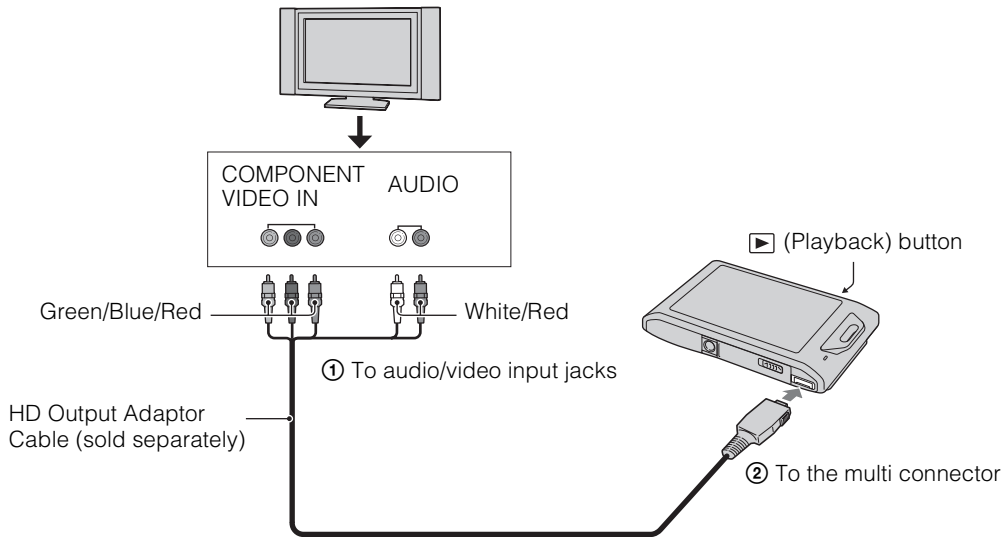

- 1 Turn off both the camera and the TV.
- 2 Connect the camera to the TV using an HD Output Adaptor Cable (sold separately).



- 3 Turn on the TV and set the input.
- 4 Press  (Playback) button to turn on the camera.

Images shot with the camera appear on the TV. Touch  displayed on the LCD screen of this camera to select the desired image.

Notes

- Before you use this function, select **MENU** →  (Settings) →  (Main Settings) to select [HD(1080i)] for [COMPONENT].
- When you play back a single image, no icons are displayed on the TV.
- Images shot in [VGA] image size cannot be played back in HD format.
- You cannot play back images in [Easy Mode] during TV output.
- When you shoot movies in the condition where the camera and a TV are connected using an HD Output Adaptor Cable (sold separately), the image being shot is not displayed at the TV side.
- When using the camera abroad, it may be necessary to switch the video signal output to match that of your TV system (page 100).

"PhotoTV HD"

This camera is compatible with the "PhotoTV HD" standard.

By connecting a Sony TV compatible with "PhotoTV HD" using an HD Output Adaptor Cable (sold separately), a whole new world of photos can be comfortably enjoyed in breathtaking Full HD quality.

- "PhotoTV HD" allows for a highly-detailed, photo-like expression of subtle textures and colors.
- For details, see the operating instructions of the TV.

On TV color systems

If you want to view images on a TV screen, you need a TV with a video input jack and the cable for multi-use terminal. The color system of the TV must match that of the digital still camera. Check the following lists for the TV color system of the country or region where the camera is used.

NTSC system

Bahama Islands, Bolivia, Canada, Central America, Chile, Colombia, Ecuador, Jamaica, Japan, Korea, Mexico, Peru, Surinam, Taiwan, the Philippines, the U.S.A., Venezuela, etc.

PAL system

Australia, Austria, Belgium, China, Croatia, Czech Republic, Denmark, Finland, Germany, Holland, Hong Kong, Hungary, Indonesia, Italy, Kuwait, Malaysia, New Zealand, Norway, Poland, Portugal, Romania, Singapore, Slovak Republic, Spain, Sweden, Switzerland, Thailand, Turkey, United Kingdom, Viet Nam, etc.

PAL-M system

Brazil

PAL-N system

Argentina, Paraguay, Uruguay

SECAM system

Bulgaria, France, Greece, Guiana, Iran, Iraq, Monaco, Russia, Ukraine, etc.

Using with your computer

“PMB” and other applications are contained on the CD-ROM (supplied) to allow more versatile use of images shot with your Cyber-shot camera.

Recommended computer environment (Windows)

	OS (pre-installed)	Others
For using “PMB” and “Music Transfer”, and when importing images	Microsoft Windows XP* ¹ SP3/Windows Vista* ² SP2	CPU: Intel Pentium III 800 MHz or faster (For playing/editing the High Definition movies: Intel Pentium 4 2.8 GHz or faster/ Intel Pentium D 2.8 GHz or faster/ Intel Core Duo 1.66 GHz or faster/ Intel Core 2 Duo 1.20 GHz or faster) Memory: 512 MB or more (For playing/editing the High Definition movies: 1 GB or more) Hard Disk: Disk space required for installation—approximately 500 MB Display: Screen resolution: 1,024 × 768 dots or more

*¹ 64-bit editions and Starter (Edition) are not supported.

Windows Image Mastering API (IMAPI) Ver.2.0 or later is required to use the function for creating discs.

*² Starter (Edition) is not supported.

Recommended computer environment (Macintosh)

	OS (pre-installed)	Others
For using “Music Transfer”, and when copying images	Mac OS X (v10.3 to v10.5)	Memory: 64 MB or more (128 MB or more is recommended) Hard Disk: Disk space required for installation—approximately 50 MB

Notes

- Operation is not assured in an environment based on an upgrade of the operating systems described above or in a multi-boot environment.
- If you connect two or more USB devices to a single computer at the same time, some devices, including the camera, may not operate, depending on the types of USB devices you are using.
- Connecting the camera using a USB interface that is compatible with Hi-Speed USB (USB 2.0 compliant) allows advanced transfer (high speed transfer), as the camera is compatible with Hi-Speed USB (USB 2.0 compliant).
- When your computer resumes activity from suspend or sleep mode, communication between the camera and your computer may not recover at the same time.

Using the software

Installing “PMB (Picture Motion Browser)” and “Music Transfer” (Windows)

- 1 Turn on your computer and insert the CD-ROM (supplied) into the CD-ROM drive.

The installation menu screen appears.

- If it does not appear, double-click [Computer] (in Windows XP, [My Computer]) →  (SONYPICTUTIL).
- If the AutoPlay screen appears, select “Run Install.exe” and follow the instructions that appear on the screen to proceed with the installation.

- 2 Click [Install].

The “Choose Setup Language” screen appears.

- 3 Select the desired language, then proceed to the following screen.

The “License Agreement” screen appears.



- 4 Carefully read the agreement, click the radio button (→) to accept the terms of the agreement, and then click [Next].

- 5 Follow the instructions on the screen to complete the installation.



- When the restarting confirmation message appears, restart the computer following the instructions on the screen.
- DirectX may be installed depending on the system environment of your computer.

- 6 Remove the CD-ROM after the installation is complete.



- 7 Start up the software.

To start up “PMB,” click  (PMB) on the desktop. For the detailed operation method, click  (PMB Guide). To start up “PMB” from the Start menu, select [Start] → [All Programs] → [Sony Picture Utility].

Notes

- Log on as Administrator.
- Before starting up “Music Transfer,” perform **MENU** →  (Settings) →  (Main Settings) → [Download Music], and connect the camera to a computer.
- When “PMB” is started up for the first time, the confirmation message of the Information tool appears on the screen. Select [Start].

Introduction to “PMB”

- “PMB” allows you to import images shot with the camera to a computer for display. Make a USB connection between the camera and your computer, and click [Import].
- Images on a computer can be exported to a “Memory Stick Duo” media, and displayed on the camera. Make a USB connection between the camera and your computer, click  at the top of the screen, and click [Export].
- You can save and print images with the date.
- You can display images stored on a computer by shooting date in a calendar display.
- You can correct (Red Eye Reduction, etc.) still images, and change the shooting date and time.
- You can create discs with CD or DVD disc-writing drive.
- You can upload images to a network service. (An internet connection environment is required.)
- For other details, see  (PMB Guide).

Introduction to “Music Transfer”

“Music Transfer” allows you to replace the Music files provided in the camera at the factory with your favorite tracks, and to delete and add Music files. You can also restore the tracks stored at the factory to your camera.

The following track types can be imported using “Music Transfer”.



- MP3 files stored on the hard disk of your computer
- Music CD tracks
- Preset-music saved on the camera

For other details, see the help in “Music Transfer”.

Installing “Music Transfer” (Macintosh)

- 1 Turn on your Macintosh computer, and insert the CD-ROM (supplied) into the CD-ROM drive.
- 2 Double-click  (SONYPICUTIL).
- 3 Double-click the [MusicTransfer.pkg] file in the [Mac] folder.
The installation of the software starts.

Notes

- “PMB” is not compatible with Macintosh computers.
- For details on using “Music Transfer,” see help in “Music Transfer”.
- Before starting up “Music Transfer,” perform **MENU** →  (Settings) →  (Main Settings) → [Download Music], and connect the camera to the computer.
- Shut down all other application software before you install “Music Transfer”.
- For installation, you need to log on as Administrator.



Introduction to “Music Transfer”

“Music Transfer” allows you to replace the Music files provided in the camera at the factory with your favorite tracks, and to delete and add Music files.

You can also restore the tracks stored at the factory to your camera.

The following track types can be imported using “Music Transfer”.

- MP3 files stored on the hard disk of your computer
- Music CD tracks
- Preset-music saved on the camera

For other details, see the help in “Music Transfer”.

Table of
contents

Operation
Search

MENU/Settings
Search

Index

Connecting the camera to the computer

1 Insert a sufficiently charged battery pack into the camera, or connect the camera to a wall outlet (wall socket) using the AC-LS5K/AC-LS5 AC Adaptor (sold separately) and the USB/AV/DC IN Cable for multi-use terminal (sold separately).

- Use a Type1a-compliant USB/AV/DC IN Cable (sold separately).

2 Turn on the computer, then press  (Playback) button.

3 Connect the camera to your computer.

- When a USB connection is established for the first time, your computer automatically runs a program to recognize the camera. Wait for a while.

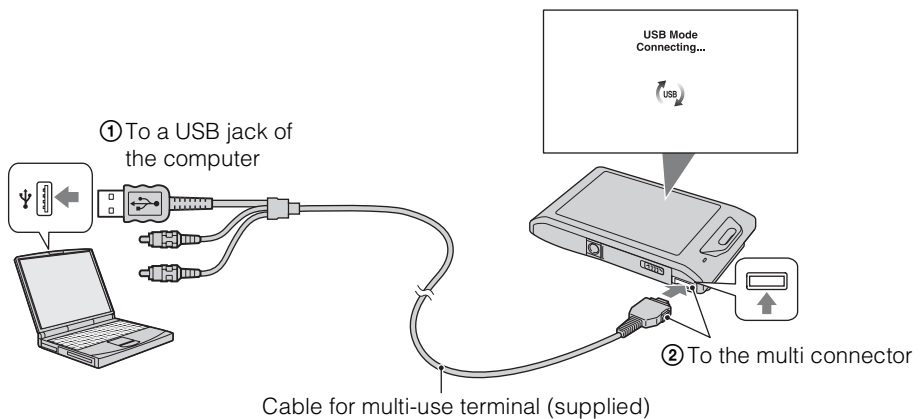

Importing images to a computer (Windows)

“PMB” allows you to easily import images.

For details on “PMB” functions, see the “PMB Guide”.

Importing images to a computer without using “PMB”

When the AutoPlay Wizard appears after making a USB connection between the camera and a computer, click [Open folder to view files] → [OK] → [DCIM] → copy the desired images to the computer.

Importing images to a computer (Macintosh)

- 1 Connect the camera to your Macintosh computer first. Double-click the newly recognized icon on the desktop → [DCIM] → the folder where the images you want to import are stored.
- 2 Drag and drop the image files to the hard disk icon.
The image files are copied to the hard disk.
 - For details on the storage location of the images and file names, see page 141.
- 3 Double-click the hard disk icon → the desired image file in the folder containing the copied files.
The image is displayed.

Deleting the USB connection

Perform the procedures from step 1 to 3 below before:

- Disconnecting the cable for multi-use terminal.
- Removing a “Memory Stick Duo” media.
- Inserting a “Memory Stick Duo” media into the camera after copying images from the internal memory.
- Turning off the camera.

- 1 Double-click the disconnect icon on the tasktray.
- 2 Click  (USB Mass Storage Device) → [Stop].
- 3 Confirm the device on the confirmation window, then click [OK].

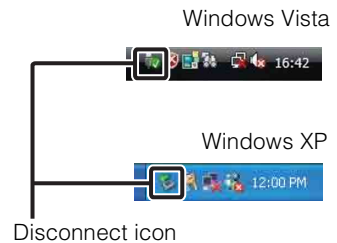

Note

- Drag and drop the icon of the “Memory Stick Duo” media or the drive icon to the “Trash” icon beforehand when you use a Macintosh computer, and the camera is disconnected from the computer.

Viewing “Cyber-shot Step-up Guide”

“Cyber-shot Step-up Guide” further introduces how to use the camera and optional accessories.

Viewing on Windows

When you install “Cyber-shot Handbook”, “Cyber-shot Step-up Guide” is also installed.

1 Double-click  (Step-up Guide) on the desktop.

To access “Step-up Guide” from the Start menu, click [Start] → [All Programs] → [Sony Picture Utility] → [Step-up Guide].

Viewing on Macintosh

- 1 Copy the [stepupguide] folder in the [stepupguide] folder to your computer.
- 2 Select [stepupguide] → [language] and then [GB] folder stored in the CD-ROM (supplied), and copy all the files in the [GB] folder to the [img] folder in the [stepupguide] folder that you copied to your computer in step 1. (Overwrite the files in the [img] folder with the files from the [GB] folder.)
- 3 After copying is complete, double-click “stepupguide.hqx” in the [stepupguide] folder to uncompress it, then double-click the generated file “stepupguide”.

Note

- If an uncompress tool for HQX file is not installed, install the Stuffit Expander.

Printing still images

You can print still images using the following methods.

- Printing directly using a PictBridge-compliant printer
- Printing directly using a “Memory Stick” media-compliant printer
For details, see the operating instructions supplied with the printer.
- Printing using a computer
You can import images to a computer using the supplied “PMB” software and print the images.
You can insert the date on the image and print it. For details, see the “PMB Guide”.
- Printing at a shop (page 126)

Notes

- When you print images shot in 16:9 mode, both edges may be cut off.
- You cannot print panoramic images depending on the printer.

Printing images directly using a PictBridge-compliant printer

Even if you do not have a computer, you can print images shot using the camera by connecting the camera directly to a PictBridge-compliant printer.

PictBridge “PictBridge” is based on the CIPA standard. (CIPA: Camera & Imaging Products Association)

- 1 Insert a sufficiently charged battery pack into the camera.
- 2 Connect the camera to the printer.

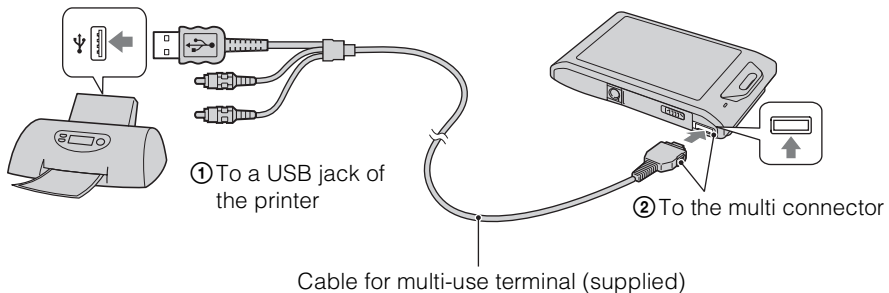

- 3 Turn on the camera and the printer.

After the connection is made, the  indicator appears on the screen.

If the  indicator flashes on the screen of the camera (error notification), check the connected printer.

4 **MENU** →  (Print) → desired mode

This Image	Prints the currently displayed image in single-image mode.
Multiple Images	<p>You can select and print multiple images. After step 4, perform the following.</p> <p>① Touch the image to be printed. Repeat the above steps until there are no more images to be printed. Touch an image with a ✓ mark again to release the ✓ mark.</p> <p>② Touch [OK] → [OK].</p>
All in This Folder All in Date Range	<p>Prints all images in the selected folder and date range at once. Touch [OK] after step 4.</p>

5 Desired setting item → [Start].

Quantity	<p>Selects the number of copies of the specified image to be printed.</p> <ul style="list-style-type: none"> The designated number of images may not all fit onto a single sheet depending on the quantity of images.
Layout	Selects the number of images you want to print side by side on a sheet.
Size	Selects the size of the printing sheet.
Date	<p>Selects [Date] or [Day&Time] to insert the date and time on images.</p> <ul style="list-style-type: none"> When you choose [Date], the date will be inserted in the order you select using [Date & Time Setting] on the camera. This function may not be available depending on the printer.

Notes

- Movies cannot be printed.
- If the camera could not be connected to the printer, be sure to set [USB Connect] under [Main Settings] to [PictBridge].
- Do not disconnect the cable for multi-use terminal while the  (PictBridge Connecting) indicator appears on the screen.

Printing at a shop

You can take a “Memory Stick Duo” media containing images shot with the camera to a photo printing service shop. As long as the shop supports photo printing services conforming to DPOF, you can make a **DPOF** (Print order) mark on images in advance in the playback mode MENU so that you do not have to reselect them when you print them out at the shop.

Notes

- You cannot print images stored in the internal memory at a print shop directly from the camera. Copy the images to a “Memory Stick Duo” media (page 110), then take the “Memory Stick Duo” media to the print shop.
- Consult your photo printing service shop as to what types of “Memory Stick Duo” media they handle.
- If “Memory Stick Duo” media are not handled by your photo service shop, copy the images you want to print to another medium such as a CD-R and take it to the shop.
- A “Memory Stick Duo” media Adaptor (sold separately) may be necessary. Consult your photo printing service shop.
- Before you take image data to a shop, always copy (back up) your data to a disk.
- You cannot set the number of prints.
- If you want to superimpose dates on images, consult your photo printing service shop.

Troubleshooting

If you experience trouble with the camera, try the following solutions.

❶ Check the items on pages 127 to 135.

If a code such as “C/E:□□:□□” appears on the screen, see page 136.

❷ Remove the battery pack, wait for about one minute, re-insert the battery pack, then turn on the power.

❸ Initialize the settings (page 98).

❹ Consult your Sony dealer or local authorized Sony service facility.

On repairing cameras with internal memory or Music files function included, data in the camera may be checked on minimum necessity to verify and improve the malfunction symptoms. Sony will not copy or save any of those data.

Additional information on this product and answers to frequently asked questions can be found at our Customer Support Website.
<http://www.sony.net/>

Battery pack and power

Cannot insert the battery pack.

- Make sure the direction of the battery is correct, and insert it until the battery eject lever is locked.

Cannot turn on the camera.

- After inserting the battery pack into the camera, it may take a few moments for the camera to power up.
- Insert the battery pack correctly.
- The battery pack is discharged. Insert a charged battery pack.
- Use a recommended battery pack.

The power turns off suddenly.

- Depending on the camera and battery temperature, the power may turn off automatically to protect the camera. In this case, a message is displayed on the LCD screen before the power turns off.
- If you do not operate the camera for about two minutes while the power is on, the camera turns off automatically to prevent wearing down the battery pack. Turn on the camera again.

The remaining charge indicator is incorrect.

- This is caused when you use the camera in an extremely hot or cold location.
- A discrepancy arose between the remaining charge indicator and the actual remaining battery charge. Fully discharge the battery pack once, then charge it to correct the indication.
- The battery pack is dead (page 144). Replace it with a new one.

Cannot charge the battery pack.

- You cannot charge the battery pack using the AC-LS5K/AC-LS5 AC Adaptor (sold separately). Use the battery charger to charge the battery.

The CHARGE lamp flashes while charging the battery.

- Remove and reinsert the battery pack, making sure it is installed correctly.
- The temperature may be inappropriate for charging. Try charging the battery pack again within the proper charging temperature range (10°C to 30°C (50°F to 86°F)).
- For details, see page 144.

Shooting still images/movies

Cannot record images.

- Check the free capacity of the internal memory or a “Memory Stick Duo” media. If it is full, do one of the following:
 - Delete unnecessary images (page 74).
 - Change the “Memory Stick Duo” media.
- You cannot record images while charging the flash.
- Movies with the size set to [1280×720] can only be recorded on a “Memory Stick PRO Duo” media. When using recording media other than a “Memory Stick PRO Duo” media, set the movie image size to [VGA].
- Set [Demo Mode] to [Off] (page 97).

Smile Shutter function does not work.

- No image is shot if a smiling face is not detected.
- Set [Demo Mode] to [Off] (page 97).



Anti-blur function does not work.

- The anti-blur function does not work when  appears on the display.
- The anti-blur function may not work properly when shooting night scenes.
- Shoot after pressing the shutter button halfway down.

Recording takes a long time.

- When the shutter speed becomes slower than a certain speed, for example, when you shoot images in dark locations, the camera automatically reduces the image noise. This function is called NR (noise reduction) slow shutter and the shooting time takes longer.
- The Anti Blink function is working. When [Anti Blink] is set to [Auto], reset to [Off] (page 64).

The image is out of focus.

- The subject is too close. When shooting, make sure to position the lens farther away from the subject than the shortest shooting distance (approximately 1 cm (13/32 inches) (W)/50 cm (19 3/4 inches) (T) from the lens in Intelligent Auto Adjustment and Easy Mode, or approximately 8 cm (3 1/4 inches) (W)/50 cm (19 3/4 inches) (T) from the lens in other recording modes). Or set to Close focus mode and shoot about 1 to 20 cm (13/32 to 7 7/8 inches) from the W side distance.
-  (Landscape) mode or  (Twilight) mode or  (Fireworks) mode is selected in the Scene Selection when shooting still images.











Zoom does not work.

- You cannot use the optical zoom during Sweep Panorama shooting or in Close focus mode.
- You cannot use the Smart zoom depending on the image size (page 90).
- You cannot use the Digital Zoom when:
 - Shooting movies.
 - The Smile Shutter is working.

Cannot select the Face Detection function.

- You can select Face Detection only when the focus mode is set to [Multi AF] or the Metering Mode is set to [Multi].
- You cannot select Face Detection when the Close focus mode is activated.



The flash does not work.

- You cannot use the flash when:
 - Shooting burst images (page 45).
 -  (High Sensitivity) mode or  (Twilight) mode or  (Fireworks) mode is selected in the Scene Selection.
 - Shooting in Sweep Panorama, Movie Mode, Anti Motion Blur or Hand-held Twilight mode.
- Set the flash to [On] (page 41) in Close focus mode or when the Scene Selection mode is set to  (Landscape),  (Gourmet),  (Pet),  (Beach),  (Snow),  (Underwater) or  (Hi-Speed Shutter).

Fuzzy white circular spots appear in images shot using the flash.

- Particles (dust, pollen, etc.) in the air reflected the flash light and appeared in the image. This is not a malfunction.

The close-up shoot function (Macro/Focus On) does not work.

-  (Landscape) mode or  (Twilight) mode or  (Fireworks) mode is selected in the Scene Selection.
- When Close focus mode is selected, the shooting distance is approximately 1 to 20 cm (13/32 to 7 7/8 inches).
- Macro mode is set to [Auto] when shooting in Sweep Panorama mode, shooting movies, shooting in Anti Motion Blur mode, shooting in Hand-held Twilight mode, shooting in Easy Mode, or when the Smile Shutter function is activated.

Macro shooting cannot be turned off.

- There is no function for forcibly turning off macro shooting. In [Auto] mode, you can even shoot a distant subject.

The date and time are not displayed on the LCD screen.

- While shooting, the date and time are not displayed. They are displayed only during playback.

Cannot insert dates on images.

- This camera does not have a feature for superimposing dates on images. By using “PMB”, you can print or save images with the date (page 118).

The F value and shutter speed flash when you press and hold the shutter button halfway down.

- The exposure is incorrect. Correct the exposure (page 51).

The image colors are not correct.

- Adjust the [White Balance] (page 53).

Noise appears in the image when you view the screen in a dark place.

- The camera is attempting to increase the visibility of the screen by temporarily brightening the image under conditions of low illumination. There is no effect on the recorded image.

The eyes of the subject come out red.

- Set [Red Eye Reduction] to [Auto] or [On] (page 65).
- Shoot the subject at a distance closer than the flash range using the flash.
- Light the room and shoot the subject.
- Retouch the image using [Retouch] → [Red Eye Correction] in the playback mode MENU, or correct using “PMB”.

Dots appear and remain on the screen.

- This is not a malfunction. These dots are not recorded.

Cannot shoot images in succession.

- You cannot shoot images in succession while the Smile Shutter function is activated.
- The internal memory or a “Memory Stick Duo” media is full. Delete unnecessary images (page 74).
- The battery level is low. Insert charged battery pack.

The same image is shot several times.

- Set [Burst] to [Off] (page 45).
- [Scene Recognition] is set to [Advanced] (page 59).

Viewing images

Cannot play back images.

- The folder/file name has been changed on your computer.
- No guarantees are made for playing back, on this camera, files containing images which were processed on a computer or images which were shot using other cameras.
- The camera is in USB mode. Delete the USB connection (page 122).
- You may not be able to play back some images stored on the “Memory Stick Duo” media shot using other cameras. Play such images in Folder View (page 79).
- This is caused by copying images on your computer to the “Memory Stick Duo” media without using the “PMB”. Play such images in Folder View (page 79).

The date and time are not displayed.

- [Playback Display Settings] is set to [Off].

The image appears rough right after playback starts.

- This may happen due to image processing. This is not a malfunction.

Left and right sides of the screen are shown in black.

- [Auto Orientation] is set to [On] (page 91).

The buttons and icons no longer appear.

- If you touch the top right of the screen during shooting, the buttons and icons will momentarily disappear. The buttons and icons will reappear when you take your finger off the screen.
- [Shooting Display Settings] and [Playback Display Settings] are set to [Off]. Touch the left side of the LCD screen and drag to the right (pages 67, 84).

Cannot hear music during slideshow.

- Transfer music files to the camera with “Music Transfer” (pages 118, 119).
- Confirm that the volume setting and slideshow setting are correct (pages 72, 83).
- Slideshow is played back with [Continuous Playback]. Select [Slideshow with music] and play back.

The image does not appear on the TV.

- Check [Video Out] to see if the video output signal of the camera is set to the color system of your TV (page 100).
- Check whether the connection is correct (pages 114, 115).
- If the cable for multi-use terminal is connected to the USB terminal, disconnect the cable (page 122).
- When you shoot movies where the camera and a TV are connected, the image being shot is not displayed on the TV.

Deleting

Cannot delete an image.

- Cancel the protection (page 80).

A “Memory Stick PRO Duo” media is not recognized by a computer with a “Memory Stick” media slot.

- Check that the computer and the “Memory Stick” media Reader/Writer support a “Memory Stick PRO Duo” media. Users of computers and the “Memory Stick” media Readers/Writers made by manufacturers other than Sony should contact those manufacturers.
- If a “Memory Stick PRO Duo” media is not supported, connect the camera to the computer (pages 121, 122). The computer recognizes the “Memory Stick PRO Duo” media.

Your computer does not recognize the camera.

- When the battery level is low, insert the charged battery pack or use the AC adaptor (sold separately).
- Set [USB Connect] to [Auto] or [Mass Storage] (page 102).
- Use the cable for multi-use terminal for connection between the computer and the camera.
- Disconnect the cable for multi-use terminal from both the computer and the camera, and firmly connect it again.
- Disconnect all equipment other than the camera, the keyboard and the mouse from the USB connectors of your computer.
- Connect the camera directly to your computer without passing through a USB hub or other device.

Cannot import images.

- Connect the camera and your computer correctly making a USB connection (page 121).
- When you shoot images with a “Memory Stick Duo” media formatted by a computer, you may not be able to import the images to a computer. Shoot using a “Memory Stick Duo” media formatted by the camera (page 106).

After making a USB connection, “PMB” does not start automatically.

- Make the USB connection after the computer is turned on.

Cannot play back images on your computer.

- If you are using “PMB”, refer to “PMB Guide” (page 118).
- Consult the computer or software manufacturer.

The image and sound are interrupted by noise when you view a movie on a computer.

- You are playing back the movie directly from the internal memory or the “Memory Stick Duo” media. Import the movie to the hard disk of your computer, then play back the movie from the hard disk (page 121).

Images once exported to a computer cannot be viewed on the camera.

- Export them to a folder recognized by the camera, such as “101MSDCF” (page 141).
- When using software other than “PMB”, the information may not be updated correctly, so images may turn blue or otherwise not be displayed correctly. This is not a malfunction.
- When blue images appear, view them in the Folder View mode or delete them with the camera.
- Event View is not available on this camera.

“Memory Stick Duo” media

Cannot insert a “Memory Stick Duo” media.

- Insert it in the correct direction.

You have formatted a “Memory Stick Duo” media by mistake.

- All the data on the “Memory Stick Duo” media is deleted by formatting. You cannot restore it.

Internal memory

Cannot playback or record images using the internal memory.

- There is a “Memory Stick Duo” media inserted in the camera. Remove it.

Cannot copy the data stored in the internal memory to a “Memory Stick Duo” media.

- The “Memory Stick Duo” media is full. Copy to a “Memory Stick Duo” media with sufficient capacity.

Cannot copy the data on the “Memory Stick Duo” media or the computer to the internal memory.

- This feature is not available.

Printing

See “PictBridge-compliant printer” together with the following items.

Cannot print an image.

- Refer to the operation manual of the printer.

Images are printed with both edges cut off.

- Depending on your printer, all the edges of the image may be cut off. Especially when you print an image shot with the image size set to [16:9], the lateral end of the image may be cut off.
- When printing images using your printer, cancel the trimming or borderless settings. Consult the printer manufacturer as to whether the printer provides these functions or not.
- When having images printed at a digital print shop, ask the shop whether they can print the images without cutting off both edges.

Cannot print images with the date.

- Using “PMB”, you can print images with date (page 118).
- The camera does not have a feature for superimposing dates on images. However, because the images shot with the camera include information on the recording date, you can print images with the date superimposed if the printer or the software can recognize Exif information. For compatibility with Exif information, consult the manufacturer of the printer or the software.
- If you use a photo printing service, ask them to superimpose the dates on images.

A connection cannot be established.

- The camera cannot be connected directly to a printer that is not compliant with the PictBridge standard. Consult the printer manufacturer as to whether the printer is compliant with PictBridge or not.
- Check that the printer is turned on and can be connected to the camera.
- Set [USB Connect] to [PictBridge] (page 102).
- Disconnect the cable for multi-use terminal and connect it again. If an error message is indicated on the printer, refer to the operating instructions supplied with the printer.

Cannot print images.

- Check that the camera and the printer are properly connected using Cable for multi-use terminal.
- Turn on the printer. For details, refer to the operating instructions supplied with the printer.
- If you select [Exit] during printing, images may not be printed. Disconnect the cable for multi-use terminal and connect it again. If you still cannot print your images, disconnect the cable for multi-use terminal once more, turn the printer off and then turn it on, and connect the cable again.
- Movies cannot be printed.
- Images shot using other cameras, or images modified with a computer may not be printed.
- Panoramic images may not be printed depending on the printer or may print in cut off panoramic image.

Printing is canceled.

- The cable for multi-use terminal has been disconnected before the  (PictBridge Connecting) indicator was turned off.

Cannot insert the date or print images in the index mode.

- The printer does not provide these functions. Consult the printer manufacturer as to whether the printer provides these functions or not.
- The date may not be inserted in the index mode depending on the printer. Consult the printer manufacturer.

“---- -- --” is printed on the date-inserted part of the image.

- The image does not have the recording data so the date cannot be inserted. Set [Date] to [Off] and print the image again (page 124).

Cannot print the image at the size selected.

- When you replace the printer paper with paper of a different size after connecting the printer to the camera, disconnect the cable for multi-use terminal connected to the printer and then reconnect the printer.
- The print setting of the camera differs from that of the printer. Change the setting of either the camera (page 124) or the printer.
- Consult the printer manufacturer as to whether the printer can provide the desired size.

Cannot operate the camera after canceling printing.

- Wait for a while as the printer is carrying out the cancellation. It may take some time depending on the printer.

Touch panel

Cannot operate the touch panel buttons correctly or fully.

- Perform [Calibration] (page 105).
- [Housing] is set to [On] (page 101).

The paint pen operation reacts at inappropriate points.

- Perform [Calibration] (page 105).

Others

The lens gets fogged.

- Moisture condensation has occurred. Turn off the camera and leave it for about an hour before using it.



The camera becomes warm when you use it for a long time.

- This is not a malfunction.

The Clock Set screen appears when you turn on the camera.

- Set the date and time again (page 113).
- The internal rechargeable backup battery has discharged. Insert a charged battery, and set aside for 24 hours or more with the power left off.

The date or time is incorrect.

- The Area Setting is set to a different location than your current location. Change the setting by **MENU** →  (Settings) →  (Clock Settings) → [Area Setting].

Warning indicators and messages

Self-diagnosis display

If a code starting with a letter of the alphabet appears, the self-diagnosis function on the camera is working. The last two digits (indicated by □□) will differ depending on the state of the camera.

If you cannot solve the problem even after trying the following corrective actions a few times, the camera may need repair.

Contact your Sony dealer or local authorized Sony service facility.

C:32:□□

- There is trouble with the camera's hardware. Turn the power off and on again.

C:13:□□

- The camera cannot read or write data on the "Memory Stick Duo" media. Try turning off and on the camera again, or taking out and inserting the "Memory Stick Duo" media several times.
- The internal memory has experienced a format error, or an unformatted "Memory Stick Duo" media is inserted. Format the internal memory or the "Memory Stick Duo" media (page 106).
- The inserted "Memory Stick Duo" media cannot be used with the camera, or the data is damaged. Insert a new "Memory Stick Duo" media.

E:61:□□

E:62:□□

E:91:□□

- A camera malfunction has occurred. Initialize the camera (page 98), then turn the power on again.

Messages

If the following messages appear, follow the instructions.



- The battery level is low. Charge the battery pack immediately. Depending on the conditions of use or the type of battery pack, the indicator may flash even though there are still 5 to 10 minutes of remaining battery time left.

For use with compatible battery only

- The battery inserted is not an NP-BD1 (supplied)/NP-FD1 (sold separately) battery pack.

System error

- Turn the power off and then on again.

Camera overheating

Allow it to cool

- The camera temperature has risen. The power may turn off automatically, or you may be unable to record movies. Leave the camera in a cool location until the temperature goes down.

Internal memory error

- Turn the power off and then on again.

Reinsert the "Memory Stick"

- The inserted "Memory Stick Duo" media cannot be used in the camera (page 142).
- The terminal section of the "Memory Stick Duo" media is dirty.
- The "Memory Stick Duo" media is damaged.

"Memory Stick" type error

- The inserted "Memory Stick Duo" media cannot be used in the camera (page 142).

This "Memory Stick" may not record or play

- The inserted "Memory Stick Duo" media cannot be used in the camera (page 142).

Error formatting internal memory

Error formatting "Memory Stick"

- Format the media again (page 106).

"Memory Stick" locked

- You are using the "Memory Stick Duo" media with the write-protect switch, and the switch is set to the LOCK position. Set the switch to the recording position.

Read only "Memory Stick"

- The camera cannot record or delete images on this "Memory Stick Duo" media.

No images

- No images that can be played back have been recorded in the internal memory.
- No images that can be played back have been recorded in the "Memory Stick Duo" media.
- When images recorded with other cameras cannot be played back on this camera, view the images in Folder View mode (page 79).

No still images

- The selected folder or date does not contain a file that can be played back in a slideshow.

File found which was not recognized

- You tried to delete a folder containing a file that cannot be played on this camera. Delete the file on a computer and then delete the folder.

Folder error

- A folder with the same first three digit number already exists on the “Memory Stick Duo” media (for example: 123MSDCF and 123ABCDE). Select another folder, or create a new folder (pages 107, 108).

Cannot create more folders

- The folder with a name beginning with “999” exists on the “Memory Stick Duo” media. You cannot create any folders if this is the case.

Empty folder contents

- You tried to delete a folder containing one or more files. Delete all of the files and then delete the folder.

Folder protected

- You tried to delete a folder that is protected as read only on a computer.

File error

- An error occurred while the image was playing back.
No guarantees are made for playing back, on this camera, files containing images which were processed on a computer or images which were shot using other cameras.

Read only folder

- You have selected a folder that cannot be set as a recording folder on the camera. Select another folder (page 108).

File protected

- Release the protection (page 80).

Image size over limit

- You are playing back an image with size that cannot be played back on the camera.

Unable to detect face for retouch

- You may not be able to retouch the image depending on the image.

(Vibration warning indicator)

- Camera shake may occur due to insufficient light. Use the flash, turn on the anti-blur function, or mount the camera on a tripod to secure the camera.

1280×720 (Fine) is not available

1280×720 (Standard) is not available

- Only “Memory Stick PRO Duo” media is compatible of recording movies with an image size of [1280×720]. Use “Memory Stick PRO Duo” media or set the movie image size to [VGA].

Maximum number of images already selected

- Up to 100 files can be selected when using [Multiple Images].
- Up to 999 files can be selected when using [All in Date Range] or [All in This Folder] for DPOF, Protect or Print.
- You can add **DPOF** (Print order) marks to up to 999 files. Cancel the selection.



- The data transmission to the printer may not be completed yet. Do not disconnect the cable for multi-use terminal.

Processing...

- The printer is canceling the current print job. You cannot print until it is finished. This may take time, depending on the printer.

Error Playing Music

- Delete the Music file, or replace it with a normal Music file.
- Execute [Format Music], then download a new Music files.

Error Formatting Music

- Execute [Format Music].

Operation cannot be executed in unsupported files

- Processing and other editing functions of the camera cannot be performed on image files that have been processed using a computer or images that were recorded with other cameras.

Recovering Image Database File ...

- The camera restores the date information etc. in cases where images have been deleted on a PC, etc.



- The number of images exceeds that for which date management in a database file by the camera is possible. Delete images from Date View.

Image Database File error Cannot recover

- Import all of the images to the computer with “PMB”, and format the “Memory Stick Duo” media or the internal memory (page 106).
When you cannot import all of the images to the computer with “PMB”, import all of the images to the computer without using “PMB” (page 121).
To view the images again with the camera, export the imported images to the camera with “PMB”.

Recording function unavailable due to high internal temperature

- The camera temperature has risen. You cannot record images until the temperature has gone down.

Recording has stopped due to increased camera temperature

- Recording has stopped due to a rise in temperature while recording a movie. Please wait until the temperature goes down.



- When you record movies for a long time, the camera temperature rises. In this case, stop recording movies.

Image file storage destinations and file names

The image files recorded with the camera are grouped as folders on the “Memory Stick Duo” media or the internal memory.

- A** Folder containing image data recorded using a camera not equipped with the folder creating function.
- B** Folder containing still image data recorded using the camera.
- C** Folder containing movie data recorded using the camera.

Example: viewing folders on Windows Vista

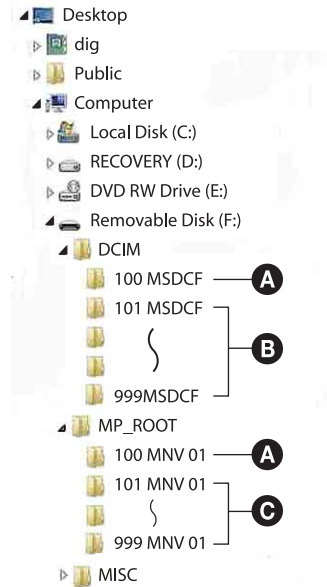

Notes

- You cannot record any images to the “100MSDCF” or “100MNV01” folders. The images in these folders are available only for viewing.
 - You cannot record/play back any images to the “MISC” folder.
 - Image files are named as follows:
 - Still image files: DSC0□□□□.JPG
 - Movie files
 - 1280×720: M4H0□□□□.MP4
 - VGA: M4V0□□□□.MP4
 - Index image files that are recorded when you record movies
 - 1280×720: M4H0□□□□.THM
 - VGA: M4V0□□□□.THM
- stands for any number within the range from 0001 to 9999. The numerical portions of the name of a movie file recorded in Movie Mode and its corresponding index image file are the same.

“Memory Stick Duo” media

A “Memory Stick Duo” media is a compact, portable IC recording medium. The types of “Memory Stick Duo” media that can be used with the camera are listed in the table below. However, proper operation cannot be guaranteed for all “Memory Stick Duo” media functions.

“Memory Stick” media type	Recording/Playback
Memory Stick Duo (without MagicGate)	○*1
Memory Stick Duo (with MagicGate)	○*2
MagicGate Memory Stick Duo	○*1*2
Memory Stick PRO Duo	○*2*3
Memory Stick PRO-HG Duo	○*2*3*4

*1 High-speed data transfer using a parallel interface is not supported.

*2 “Memory Stick Duo” media, “MagicGate Memory Stick Duo” media and “Memory Stick PRO Duo” media are equipped with MagicGate functions. MagicGate is copyright protection technology that uses encryption technology. Data recording/playback that requires MagicGate functions cannot be performed with the camera.

*3 [1280×720] size movies can be recorded.

*4 This camera does not support 8-bit parallel data transfer. It performs the same 4-bit parallel data transfer as the “Memory Stick PRO Duo” media.

Notes

- This product is compatible with “Memory Stick Micro” media (“M2”). “M2” is an abbreviation for “Memory Stick Micro” media.
- A “Memory Stick Duo” media formatted with a computer is not guaranteed to operate with the camera.
- Data read/write speeds differ depending on the combination of the “Memory Stick Duo” media and the equipment used.
- Do not remove the “Memory Stick Duo” media while reading or writing data.
- Data may be corrupted in the following cases:
 - When the “Memory Stick Duo” media is removed or the camera is turned off during a read or write operation
 - When the “Memory Stick Duo” media is used in locations subject to static electricity or electrical noise
- We recommend backing up important data.
- Do not press down hard when you write down on the memo area.
- Do not attach a label on the “Memory Stick Duo” media itself nor on a “Memory Stick Duo” media Adaptor.
- When you carry or store the “Memory Stick Duo” media, put it in the case supplied with it.
- Do not touch the terminal section of the “Memory Stick Duo” media with your hand or a metal object.
- Do not strike, bend or drop the “Memory Stick Duo” media.
- Do not disassemble or modify the “Memory Stick Duo” media.
- Do not expose the “Memory Stick Duo” media to water.
- Do not leave the “Memory Stick Duo” media within the reach of small children. They might accidentally swallow it.
- Do not insert anything other than a “Memory Stick Duo” media into the “Memory Stick Duo” media slot. Doing so will cause a malfunction.
- Do not use or store the “Memory Stick Duo” media under the following conditions:
 - High temperature locations such as the hot interior of a car parked in direct sunlight
 - Locations exposed to direct sunlight
 - Humid locations or locations with corrosive substances present

Notes on using the “Memory Stick Duo” media Adaptor (sold separately)

- To use a “Memory Stick Duo” media with a “Memory Stick” media compliant device, be sure to insert the “Memory Stick Duo” media into a “Memory Stick Duo” media Adaptor. If you insert a “Memory Stick Duo” media into a “Memory Stick” media compliant device without a “Memory Stick Duo” media Adaptor, you might not be able to remove it from the device.
- When inserting a “Memory Stick Duo” media into a “Memory Stick Duo” media Adaptor, make sure the “Memory Stick Duo” media is inserted facing in the correct direction, then insert it all the way in. Incorrect insertion may result in a malfunction.
- When using a “Memory Stick Duo” media inserted into a “Memory Stick Duo” media Adaptor with a “Memory Stick” media compliant device, make sure that the “Memory Stick Duo” media Adaptor is inserted facing the correct direction. Note that improper use may damage the equipment.
- Do not insert a “Memory Stick Duo” media Adaptor into a “Memory Stick” media compliant device without a “Memory Stick Duo” media attached. Doing so may result in malfunction of the unit.

Notes on using a “Memory Stick PRO Duo” media (sold separately)

- A “Memory Stick PRO Duo” media with a capacity up to 16 GB have been confirmed to operate properly with the camera.

Notes on using a “Memory Stick Micro” media (sold separately)

- To use a “Memory Stick Micro” media with the camera, be sure to insert the “Memory Stick Micro” media into an “M2” Adaptor as large as of Duo size. If you insert a “Memory Stick Micro” media into the camera without an “M2” Adaptor as large as of Duo size, you might not be able to remove it from the camera.
- Do not leave the “Memory Stick Micro” media within the reach of small children. They might accidentally swallow it.

Battery pack

On charging the battery pack

- We recommend charging the battery pack in an ambient temperature of between 10°C to 30°C (50°F to 86°F). The battery pack may not be fully charged in temperatures outside this range.

Effective use of the battery pack

- Battery performance decreases in low temperature surroundings. So in cold places, the operational time of the battery pack is shorter. We recommend the following to ensure longer battery pack use:
 - Put the battery pack in a pocket close to your body to warm it up, and insert it in the camera immediately before you start shooting.
- The battery pack will run out quickly if you use the flash or zoom frequently.
- We recommend having spare battery packs handy for two or three times the expected shooting time, and making trial shots before taking the actual shots.
- Do not expose the battery pack to water. The battery pack is not water-resistant.
- Do not leave the battery pack in extremely hot places, such as in a car or under direct sunlight.

How to store the battery pack

- Fully discharge the battery pack before storing and store it in a cool, dry place. To maintain the battery pack's function, fully charge the battery pack and then fully discharge it on the camera at least once a year while storing.
- To use the battery pack up, leave the camera in slideshow (page 71) playback mode until the power goes off.
- To prevent staining the terminal, short-circuiting, etc., be sure to use a supplied battery case when carrying and storing.

On battery life

- The battery life is limited. Battery capacity decreases over time and through repeated use. If decreased usage time between charges becomes significant, it is probably time to replace it with a new one.
- The battery life varies according to how it is stored and the operating conditions and environment in which each battery pack is used.

Compatible battery pack

- The NP-BD1 battery pack (supplied) can be used only in D type compatible Cyber-shot models. It cannot be used in Cyber-shot models compatible with the T type and other battery types.
- If you use the NP-FD1 battery pack (sold separately), the minutes also appear after the battery remaining indicator ( 60 Min).

Battery charger

- Only D-type, T-type, R-type and E-type battery packs (and no others) can be charged in the battery charger (supplied). Batteries other than the specified kind may leak, overheat, or explode if you attempt to charge them, posing a risk of injury from electrocution and burns.
- The batteries that are compatible with this camera are D type batteries. The supplied battery is NP-BD1 (D type).
- Remove the charged battery pack from the battery charger. If you leave the charged battery pack in the charger, battery life may be shortened.
- When the CHARGE lamp flashes, remove the battery pack being charged, and then inserting the same battery pack into the battery charger again until it clicks. When the CHARGE lamp flashes again, this may indicate a battery error or that a battery pack other than the specified type has been inserted. Check that the battery pack is the specified type. If the battery pack is the specified type, remove the battery pack, replace it with new one or another one and check if the battery charger operates correctly. If the battery charger operates correctly, a battery error may have occurred.

Intelligent Pantilter

Intelligent Pantilter (sold separately) allows you to take pictures, by having the camera detect people's faces.

For details, see the operating instructions supplied with Intelligent Pantilter.

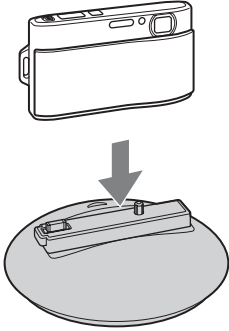

Table of contents

Operation Search

MENU/Settings Search

Index

Index

A

AF Illuminator	88
AF range finder frame	56
Anti Blink	64
Anti Motion Blur	27
Area Setting	112
Auto Orientation	91

B

Battery charger	145
Battery pack	144
Beach	29
Beep	94
Blink Alert	93
Burst	45

C

Calendar	69
Calibration	105
Center AF	56
Center-weighted metering	58
Change REC.Folder	108
Clock Settings	113
Close Focus	50
COMPONENT	99
Computer	
Importing images	121, 122
Macintosh computer	117
Recommended environment	117
Windows computer	117

Connecting

Computer	121
Printer	124
TV	114

Copy	110
------------	-----

Create REC.Folder	107
-------------------------	-----

D

Date	125
Date & Time Setting	113
Delete	74
Delete REC.Folder	109
Demo Mode	97

Digital Zoom	90
Display Burst Group	78
Download Music	103
DPOF	81
DRO	63

E

Easy Mode	
Shooting	37
Viewing	68
EV	51
Exposure	51
Exposure data	85
Extension	141

F

Face Detection	61
File names	141
File Number	111
File storage destinations	141
Fireworks	30
Flash	41, 42
Focus	56
Folder	
Changing	108
Creating	107
Deleting	109
Selecting	87
Format Music	104
Format	106

G

Gourmet	29
Grid Line	89

H

Hand-held Twilight	28
HD(1080i)	99
High Sensitivity	29
Hi-Speed Shutter	30
Housing	101

I	
Image Index	70
Image index settings.....	86
Image Size	47
Initialize.....	98
Intelligent Auto Adjustment	22
Intelligent Pantiler	146
Internal memory.....	20
ISO.....	52
L	
Landscape	29
Language Setting.....	96
LCD Brightness.....	95
M	
Macintosh computer.....	117
Macro	50
Mass Storage	102
“Memory Stick Duo” media	142
MENU screen.....	10, 12
Metering Mode.....	58
Movie Mode	
Shooting	25
Viewing	36
Movie shooting mode	38
MTP.....	102
Multi AF.....	56
Multi connector	114, 121, 124
Multi-pattern metering	58
Music Transfer.....	118
N	
Names of parts	15
NTSC	100
O	
Optical zoom	31, 90
OS.....	117
P	
Paint.....	76
PAL.....	100
PC.....	117
Pet.....	29
PictBridge	102, 124
Pixel.....	49
Playback	
Movies.....	36
Still images.....	32
Playback Display Settings	84
Playback Zoom.....	33
PMB	118
Precision digital zoom.....	90
Print	81, 124
Print order mark	126
Program Auto.....	26
Protect.....	80
PTP	102
R	
REC Mode.....	21
Red Eye Correction	77
Red Eye Reduction	65
Retouch.....	77
Rotate.....	82
S	
Scene Recog. Guide	92
Scene Recognition.....	59
Scene Selection.....	29
SD.....	99
Select Folder.....	87
Selected-face Memory.....	62
Self-diagnosis display.....	136
Self-Timer.....	43, 44
Settings.....	13
Shooting	
Movies.....	25
Still images.....	22
Shooting Direction.....	46
Shooting Display Settings.....	67
Slideshow.....	71
Slow Synchro	41
Smart zoom	90
Smile Shutter	39
Snow.....	29
Soft Snap.....	29
Software.....	118
Spot AF.....	56
Spot metering	58
SteadyShot.....	66

Sweep Panorama.....23

T

Temporarily Rotated Display.....35
Touch panel.....18
Trimming.....77
Troubleshooting.....127
TV.....114
Twilight.....29
Twilight Portrait.....29

U

Underwater.....30
Underwater White Balance.....55
Unsharp masking.....77
USB Connect.....102

V

VGA.....47
Video Out.....100
View Mode.....79
Volume Settings.....83

W

Warning indicators and messages.....136
White Balance.....53
Wide Zoom.....34
Windows computer.....117

Z

Zoom.....31

Table of contents

Operation Search

MENU/Settings Search

Index

Notes on the License

“C Library”, “Expat” and “zlib” software are provided in the camera. We provide this software based on license agreements with their owners of copyright. Based on requests by the owners of copyright of these software applications, we have an obligation to inform you of the following. Please read the following sections.

Read “license1.pdf” in the “License” folder on the CD-ROM. You will find licenses (in English) of “C Library”, “Expat”, “zlib”, “dtoa”, “pcrc” and “libjpeg” software.

THIS PRODUCT IS LICENSED UNDER THE MPEG-4 VISUAL PATENT PORTFOLIO LICENSE FOR THE PERSONAL AND NON-COMMERCIAL USE OF A CONSUMER FOR (i) ENCODING VIDEO IN COMPLIANCE WITH THE MPEG-4 VISUAL STANDARD ("MPEG-4 VIDEO")

AND/OR

(ii) DECODING MPEG-4 VIDEO THAT WAS ENCODED BY A CONSUMER ENGAGED IN A PERSONAL AND NON-COMMERCIAL ACTIVITY AND/OR WAS OBTAINED FROM A VIDEO PROVIDER LICENSED BY MPEG LA TO PROVIDE MPEG-4 VIDEO. NO LICENSE IS GRANTED OR SHALL BE IMPLIED FOR ANY OTHER USE.

ADDITIONAL INFORMATION INCLUDING THAT RELATING TO PROMOTIONAL, INTERNAL AND COMMERCIAL USES AND LICENSING MAY BE OBTAINED FROM MPEG LA, LLC. SEE

[HTTP://WWW.MPEGLA.COM](http://www.mpegla.com)

On GNU GPL/LGPL applied software

The software that is eligible for the following GNU General Public License (hereinafter referred to as “GPL”) or GNU Lesser General Public License (hereinafter referred to as “LGPL”) are included in the camera.

This informs you that you have a right to have access to, modify, and redistribute source code for these software programs under the conditions of the supplied GPL/LGPL.

Source code is provided on the web. Use the following URL to download it.

<http://www.sony.net/Products/Linux/>

We would prefer you do not contact us about the contents of source code.

Read “license2.pdf” in the “License” folder on the CD-ROM. You will find licenses (in English) of “GPL”, and “LGPL” software.

To view the PDF, Adobe Reader is needed. If it is not installed on your computer, you can download it from the Adobe Systems web page:

<http://www.adobe.com/>

On the license of “Music Transfer” in the CD-ROM (supplied)

MPEG Layer-3 audio coding technology and patents licensed from Fraunhofer IIS and Thomson.