

# Premium Double VESA Wedge and Outlet / PoE Cover for Tablets (Black/White)

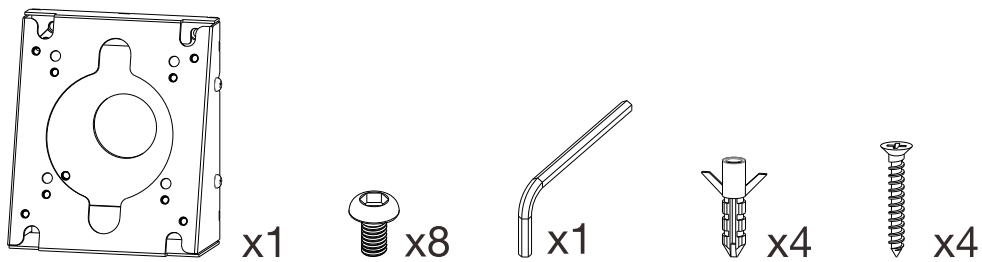

## INSTRUCTION MANUAL ADD-VESAWB/ADD-VESAWW

### Component Checklist



### 1. To work on wall

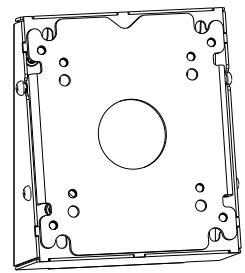
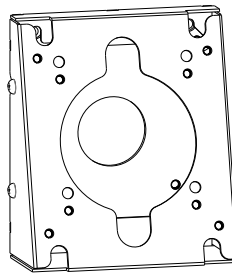
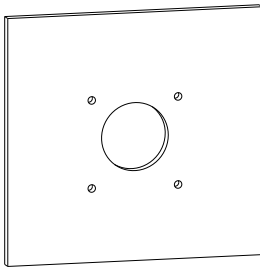

\* Can fit enclosures by VESA holes double sides

### ① To fit enclosures

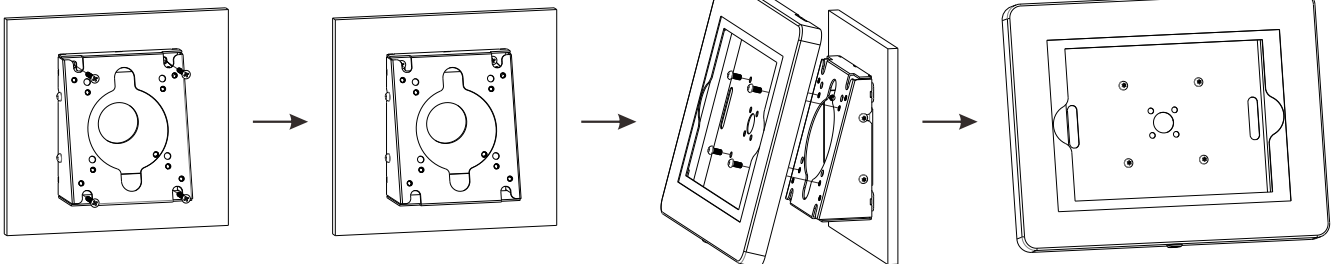

## ② To fit Monitor Screen or Enclosure which with thread holes

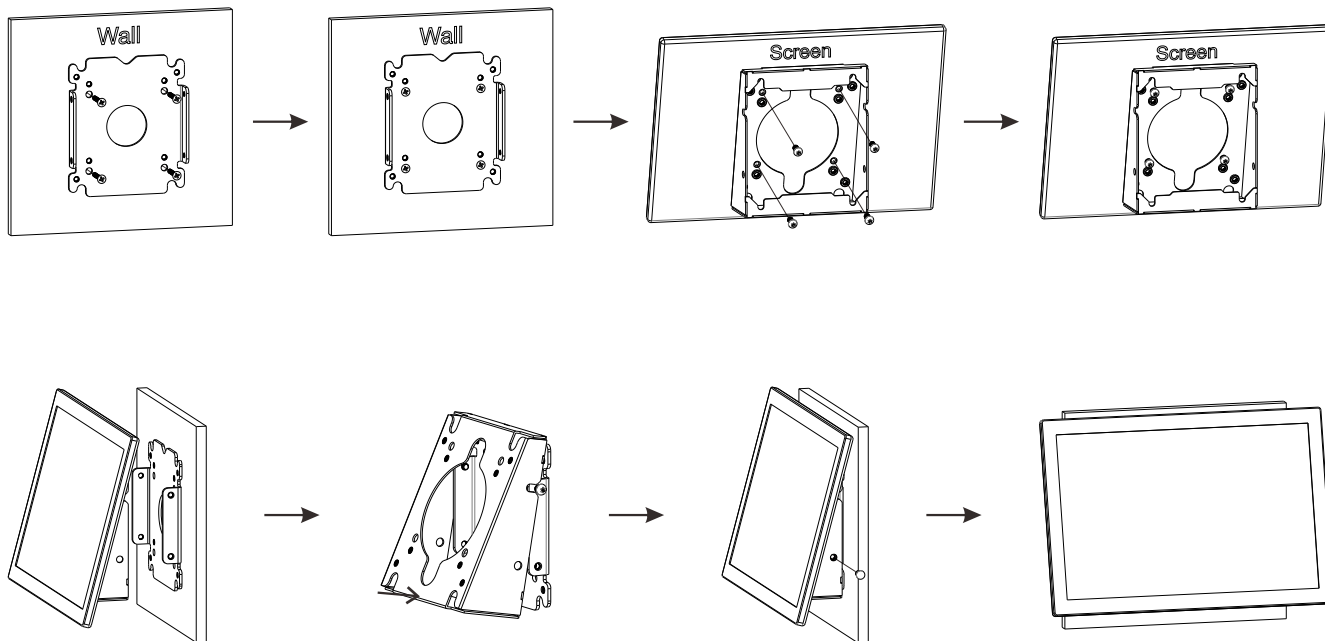

## 2. To work on outlets

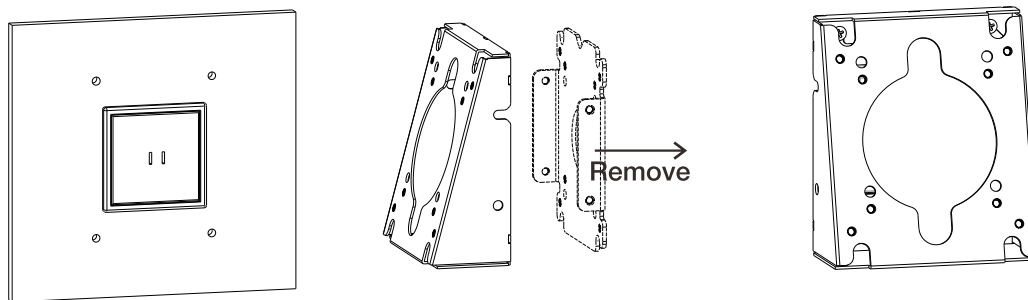

\* Can fit enclosures by VESA holes single side

