

SAMSUNG

USER MANUAL

Table of Contents

Getting started

- 4 Device layout and functions
- 10 Turning the computer on and off
- 11 Unlocking the screen
- 12 Windows

Basics

- 13 Using the computer as a tablet
- 14 Using the S Pen
- 17 Touch screen
- 21 Keyboard
- 23 Touchpad
- 25 SIM or USIM card tray (5G models only)
- 27 Cellular data (5G models only)
- 28 Wireless LAN
- 31 Bluetooth
- 32 Fingerprint recognition
- 34 Memory card slot
- 36 Thunderbolt™ 4
- 37 External display

Apps and features

- 40 Using apps
- 40 Samsung Account

- 41 Samsung Settings
- 42 Samsung Notes
- 46 Samsung Flow
- 46 Samsung Studio Plus
- 47 Samsung Gallery
- 47 Samsung Care+
- 48 Samsung Device Care
- 49 Samsung Pass
- 50 Bixby
- 51 Galaxy Book Smart Switch
- 51 Galaxy Book Experience
- 52 Online Support(S Service)
- 53 Studio mode
- 53 Screen Recorder
- 54 Quick Search
- 55 SmartThings
- 55 Quick Share
- 56 Second Screen
- 56 Private Share

Settings & Upgrade

- 57 Display brightness
- 59 Volume
- 59 Accessibility
- 60 BIOS (Setup utility)
- 64 Battery

Troubleshooting

- 69 Windows recovery function
- 69 Q&A

Usage notices

- 72 Precautions for using the device
- 76 Ergonomic tips
- 79 Safety precautions

Appendix

- 88 Product specifications
- 89 Important safety information
- 91 Replacement parts and accessories
- 93 Regulatory compliance statements
- 99 WEEE symbol information
- 101 Samsung package Take-Back program (USA only)

Getting started

Device layout and functions

⚠ Leaving the screen idle for extended periods may result in afterimages (screen burn-in) or ghosting. Turn off the screen, or turn on the screen saver or power saving mode when you are not using the computer.

- 📝
- Features or options may differ depending on the model.
 - The items marked as optional may not be provided or may be provided in different locations.
 - Since some space on the storage device is reserved for system recovery and operations, the available space on the storage device may be less than the actual capacity.

Front view

► For Wi-Fi models

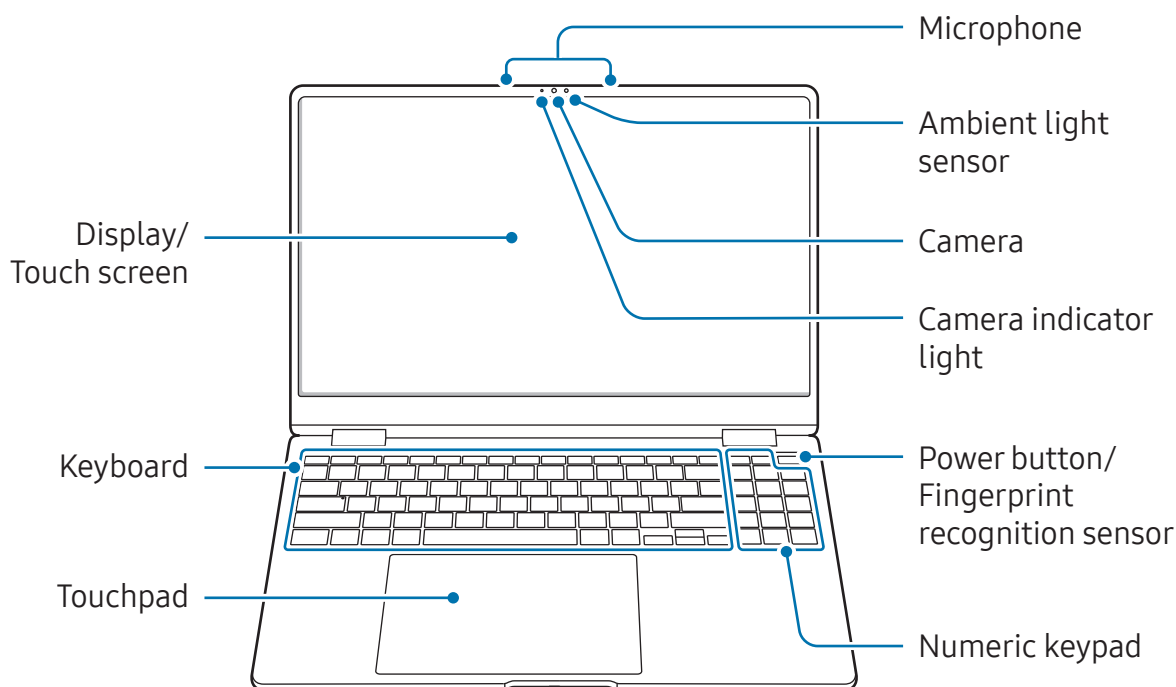

► For 5G models

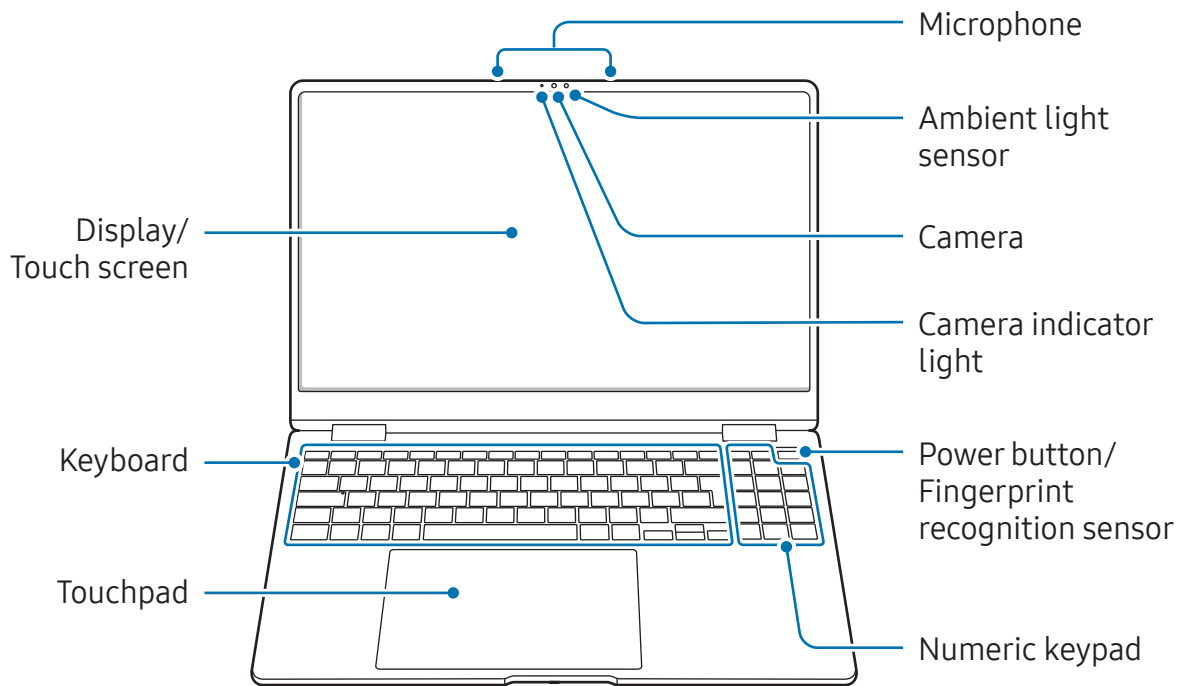

<Device layout and functions: Front view>

Name	Description
Microphone	You can use the built-in microphone.
Ambient light sensor	<ul style="list-style-type: none"> Recognizes the brightness of the environment where you use the computer. When the surroundings become dark, the keyboard backlight turns on. When the surroundings become bright, the keyboard backlight turns off. <p> Do not cover the ambient light sensor.</p>
Camera	Using this camera, you can take still pictures and record video.
Camera indicator light	This indicates the camera operating status.
Display/Touch screen	<ul style="list-style-type: none"> The screen's images are displayed here. Recognizes touch interactions.

Name	Description
Power button/ Fingerprint recognition sensor	<ul style="list-style-type: none"> • Turns the computer on and off. • The fingerprint recognition sensor recognizes fingerprints. Scans a fingerprint to sign in to Windows, apps, and services.
Numeric keypad	Enter numbers.
Keyboard	Enter text or control computer functions.
Touchpad	<ul style="list-style-type: none"> • Moves the cursor and selects options. • Functions as a mouse.

Right view

► For Wi-Fi models

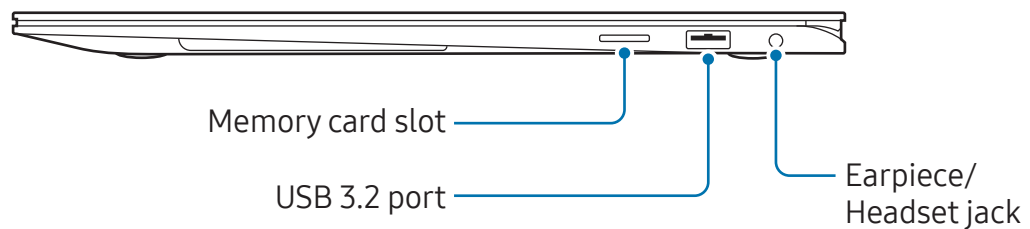

► For 5G models

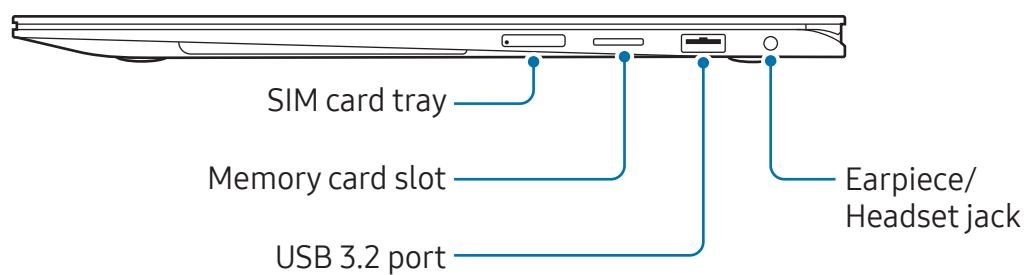

<Device layout and functions: Right view>

Name	Description
SIM card tray (5G models only)	Insert the SIM or USIM card (nano-SIM card).
Memory card slot	Insert a memory card into the slot.
USB 3.2 port	Connect various accessories, such as a mouse, camera, or keyboard.
Earpiece/Headset jack	Connect an earpiece or a headset to the computer to listen to audio.

Left view

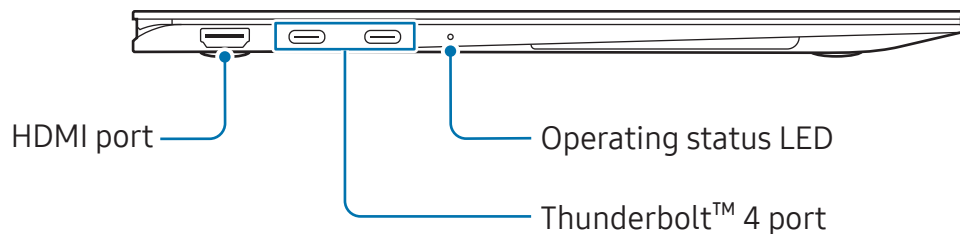

<Device layout and functions: Left view>

Name	Description
HDMI port HDMI	Used to connect an HDMI cable to an external device.
Thunderbolt™ 4 port ⚡	<ul style="list-style-type: none"> Connect the supplied adapter to charge the computer. Connect and charge a USB Type-C device and Thunderbolt™ device, or connect to an external display device. <p> Some features may not be supported depending on your device's specifications.</p>
Operating status LED	Shows the operating status of the computer. <ul style="list-style-type: none"> Red: Charging Green: Fully charged Blue: Turned on

The charging feature of the Thunderbolt™ 4 port

Charging the computer

Connect an external power supply (sold separately) to the Thunderbolt™ 4 port to use it as the auxiliary power or charge the computer.

Use an external power supply (sold separately) with a rating level higher than 10 W (5 V, 2 A) that supports USB Type-C or USB BC 1.2.

Charging a USB Type-C device or Thunderbolt™ device

Connect and charge your USB Type-C or Thunderbolt™ device by connecting it to the computer.

- ✎ It may take longer to charge the battery when charging a connected device.
- The battery power level may be reduced when charging a connected device while the computer is powered by the battery.
- The charging status of the connected device is not displayed on the computer.
- This charging feature may not be available on some devices.
- To charge another device when the computer is in hibernation mode or is turned off, connect to the Thunderbolt™ 4 port.

Bottom view

► For Wi-Fi models

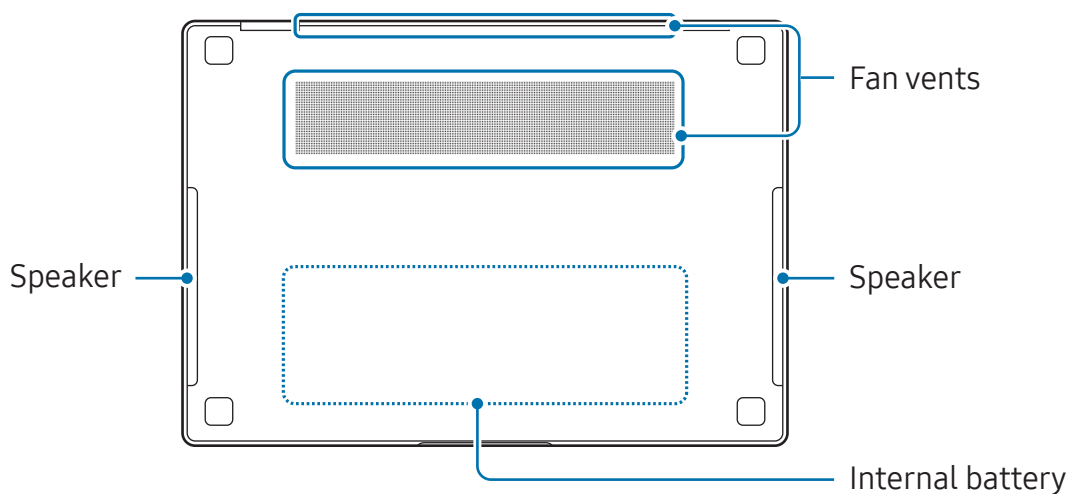

► For 5G models

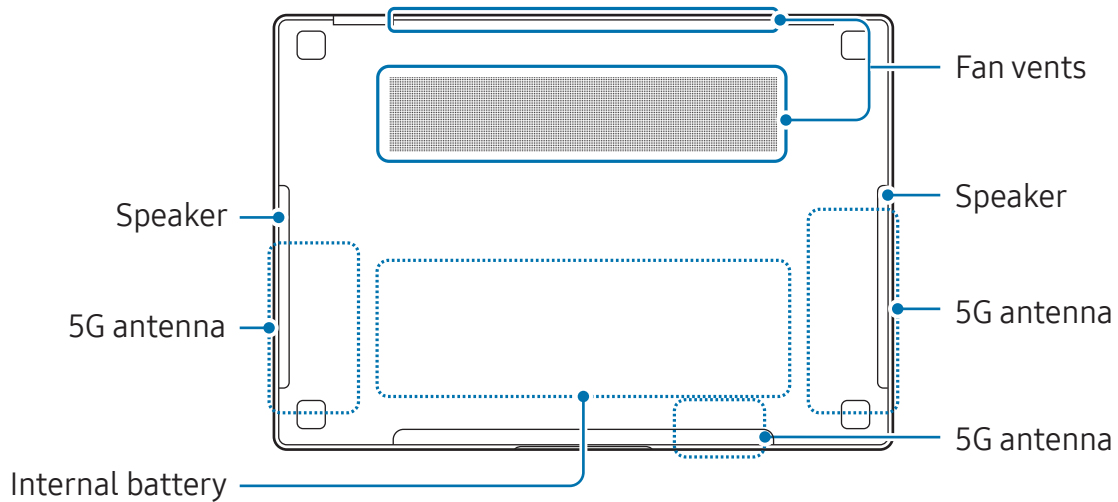

<Device layout and functions: Bottom view>

Name	Description
Fan vents	<ul style="list-style-type: none"> Sucks in outside air and discharges heat generated inside the computer through these holes. If the vents are blocked the computer may overheat. Avoid blocking the vents as this may be dangerous.
Internal battery	Provides power to the computer when not connected to an adapter.
Speaker	Sound is emitted from the speakers.
5G antenna (5G models only)	Transmits and receives radio waves.

-  If the case at the bottom of the device is replaced, the laser-carved model name, serial number, and various logos will not be displayed anymore. For more information, contact a Samsung Service Center.
- Remove all of the protective papers from the rubber feet at the bottom of the computer before use.

Turning the computer on and off

- ⚠ Fully charge the battery using the supplied adapter before using the computer **for the first time**.

Turning the computer on

- 1 Before turning on the computer, check that the battery is charged and charge it if necessary.
- 2 Open the display panel. The computer automatically turns on.
If the computer does not turn on automatically, press the Power button.

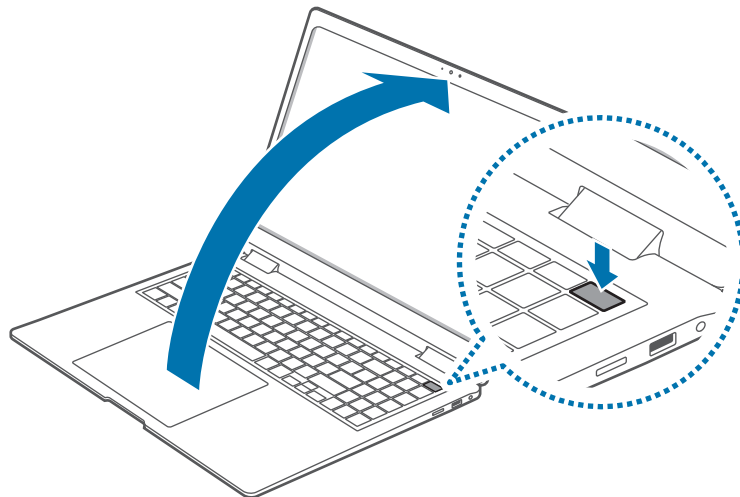

- 📝 Set the computer to not turn on automatically when the display panel is opened.
 - 1 Select the Start icon (🟦) → **All** → **Samsung Settings**.
 - 2 Select **Advanced features** and select the **Auto booting** switch to deactivate it.



About Windows Activation

When you turn the computer on for the first time, the Windows Activation screen appears.

Follow the activation procedures according to the instructions on the screen to use the computer.

The computer's date and time may be incorrect when you turn it on for the first time. They may also be incorrect if the battery has been fully discharged or removed. To set the date and time, go to the desktop taskbar and right-click the date and clock area. Then, select **Adjust date and time** and set the current date and time.

Turning the computer off

- 1 Select the Start icon (.
 - 2 Select the Power icon () → **Shut down**.
-  Save all data before turning off the computer.

Unlocking the screen

To unlock the lock screen, do one of the following:

- **Touch screen:** Swipe upwards from the bottom of the screen.
- **Mouse:** Click the lock screen.
- **Keyboard:** Press any key.
- **Touchpad:** Tap the touchpad.

If the account has a password, enter the password to log in after unlocking the screen.

Windows

Microsoft Windows is an operating system that is used to control a computer.



-  • Images and available features may differ depending on the model and operating system.
- This manual is designed for Windows 11 and content may differ depending on the OS version.
- The image displayed on the desktop screen may differ between models and OS versions.

Configuring the Windows Settings

You can configure the basic system settings, such as installing or uninstalling apps and managing accounts, from the Windows Settings.

Select the Start icon () → **Settings**.

Then, select an option you want to change after the **Settings** window appears.

-  You can also configure the settings from the Control Panel like previous OS versions. Select the Start icon () → **All** → **Windows Tools** → **Control Panel**.

Basics

Using the computer as a tablet

You can use the computer as a tablet by folding the display panel behind the keyboard. Open the display panel and rotate it away from the keyboard until it touches the bottom side of the computer.

- ❗ When storing the computer in a bag or carrying it, close the display panel to protect the computer.
- 📝 • **When the display panel is tilted past the transition point**
 - The keyboard and touchpad will automatically be locked and will not function. But, during processes that start before Windows operation, such as the BIOS setup or DOS, the keyboard and touchpad will not be locked.
 - The display will rotate automatically depending on the computer's orientation.
- When the screen is turned off while using the computer as a tablet, touch the screen to unlock it. When the computer is in sleep mode, press the Power button to unlock the screen.

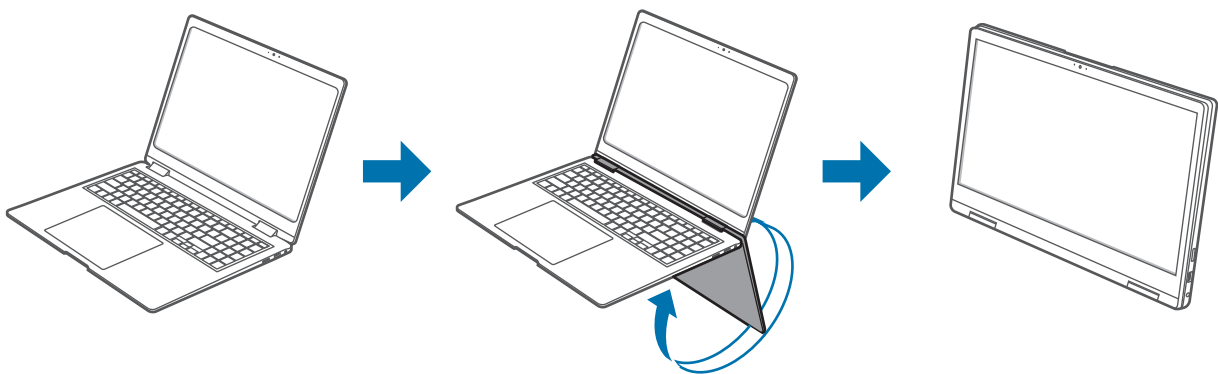

Using the S Pen

S Pen

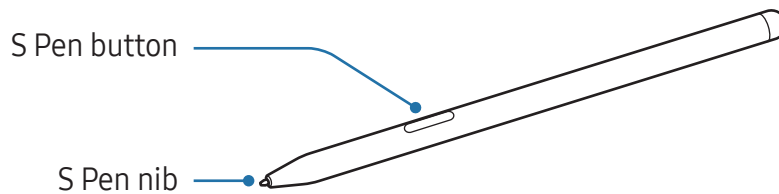

<S Pen functions>

Name	Functions
S Pen nib	Use the S Pen to write, draw, or perform touch actions on the screen. Hover the S Pen over items on the screen to access additional S Pen features, such as the Air view feature.
S Pen button	Hover the S Pen over the screen and press the S Pen button to display the Air command features.

- ⚠ Do not bend or apply excessive pressure with the S Pen while using it. The S Pen may be damaged or the nib may be deformed.
- ✍
 - If a magnet is near the computer, some S Pen actions, such as tapping the touch screen, may not work.
 - If you use the S Pen at sharp angles on the screen, the device may not recognize the S Pen actions.
 - For more information about the S Pen, visit the Samsung website.
 - If the S Pen is not working properly, take it to a Samsung Service Center.

Air command

Introduction

Air command is a menu that provides S Pen features quickly.

To open the Air command panel, hover the S Pen over the screen and press the S Pen button.

Alternatively, select the Start icon () → **All** → **Air Command**.



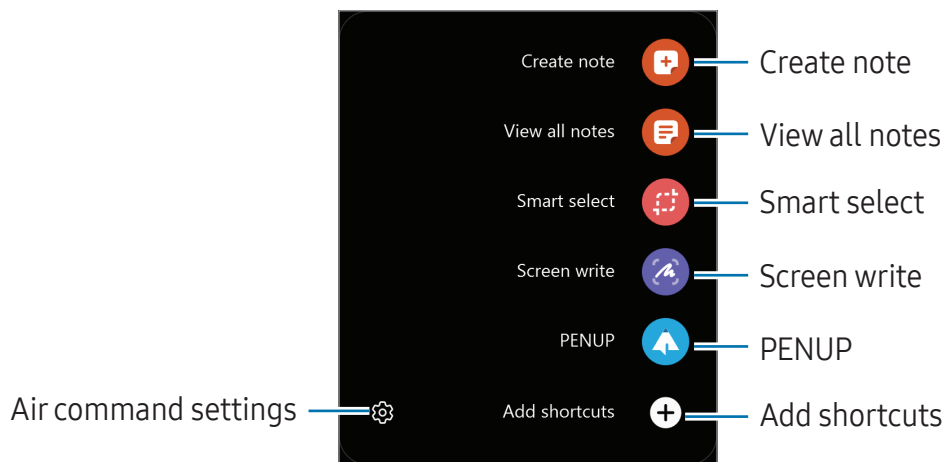



 Images and features may differ depending on the model and the app version.



- **Create note**: Launch the Samsung Notes app and create a new note.
- **View all notes**: Launch the Samsung Notes app and check all saved notes.
- **Smart select**: Use the S Pen to select an area and perform actions, such as sharing or saving.
- **Screen write**: Capture screenshots to write or draw on them or crop an area from the captured image. Also you can capture content that continues across multiple screens at once.
- **PENUP**: Post your artwork, view others' artwork, and get useful drawing tips.
- **Add shortcuts**: Add shortcuts to frequently used apps to the Air command panel.

Smart select

Use the S Pen to select an area and perform actions, such as sharing or saving. You can also select an area from a video and capture it as a GIF animation.

- 1 When there is content you want to capture, open the Air command panel and select **Smart select**.
- 2 Select a desired shape icon on the toolbar and drag the S Pen across the content you want to select.
- 3 Select an option to use with the selected area.
 - **Pin/Insert:** Pin the selected area to the screen.
 - : Automatically changes the appearance of the selected area.
 - : Write or draw on the selected area.
 - : Extract text from the selected area.
 - : Share the selected area with others.
 - : Save the selected area as an image to the clipboard.
 - : Save the selected area in **Pictures**.

Screen write

Capture screenshots to write or draw on them or crop an area from the captured image.

- 1 When there is content you want to capture, open the Air command panel and select **Screen write**.

The current screen will be automatically captured.
- 2 Select the Draw icon () and write a memo on the screenshot.
- 3 Share or save the screenshot.

You can view the screenshots in the File Explorer icon () → **This PC** → **Pictures**.

 It is not possible to capture a screenshot while using some app or some features.

Touch screen

Use your fingers on the touch screen to perform actions.

Touch screen gestures

- **Tapping:** Tap the screen.
 - **Double tapping:** Double tap the screen.
 - **Touching and holding (right-clicking):** To use additional options of an item, touch and hold it on the screen.
 - **Dragging:** Touch and hold an item and drag it to the target position.
 - **Scrolling:** To scroll up, down, left, or right, swipe on the screen.
 - **Spreading and pinching:** To zoom in, spread two fingers apart on an image or text. Pinch to zoom out.
-  • Do not subject the touch screen to severe impacts or press it with sharp objects. Doing so may damage the touch screen.
- Do not allow the touch screen to come into contact with other electrical devices. Electrostatic discharges can cause the touch screen to malfunction.
 - Do not expose the touch screen to water. The touch screen may malfunction in humid conditions or when exposed to water.
 - Do not spray liquid cleansing solutions directly onto the touch screen. The solution may enter the touch screen or cause undesired operation. To clean the screen, dampen a cloth with solution and gently wipe the screen. Do not use solutions or cloths that contain abrasive materials, as they may damage the touch screen.
 - Do not damage the edges of the touch screen. Doing so may damage the touch screen.
 - Make sure your hands are clean and dry before using the touch screen. Remove any moisture from your hands before using the touch screen.
 - Do not expose the computer to foreign substances. Doing so may cause the touch screen to malfunction.

-  Very light touches on the touch screen may not be recognized.
- Precisely tap items on the touch screen for the best results.
- When used under some 3-wavelength lamps, the touch screen could malfunction.
- The touch screen sensors are located on the edges of the touch screen. Therefore, do not cover the edges of the touch screen with protective covers or accessories.
- Touch screen gestures are available for touch screen models running Windows and work only with some apps.

Entering text

Use the on-screen keyboard to enter text.

To open the on-screen keyboard, tap the Touch keyboard icon () on the taskbar.

-  Some languages are not supported by the virtual keyboard. To enter text, change the input language to one of the supported languages.
- When using the computer for extended periods, it is recommended to enter text with the physical keyboard.
- When using the computer as a tablet, the on-screen keyboard icon will appear on the taskbar.

Changing the keyboard layout

To change the keyboard layout, tap the Keyboard settings icon () and select one of the following:

- **Keyboard layout** → **Default**: Simplified QWERTY keyboard
- **Keyboard layout** → **Small**: Floating keyboard
- **Keyboard layout** → **Split**: Split QWERTY keyboard for entering text with two hands
- **Keyboard layout** → **Traditional**: Standard QWERTY keyboard

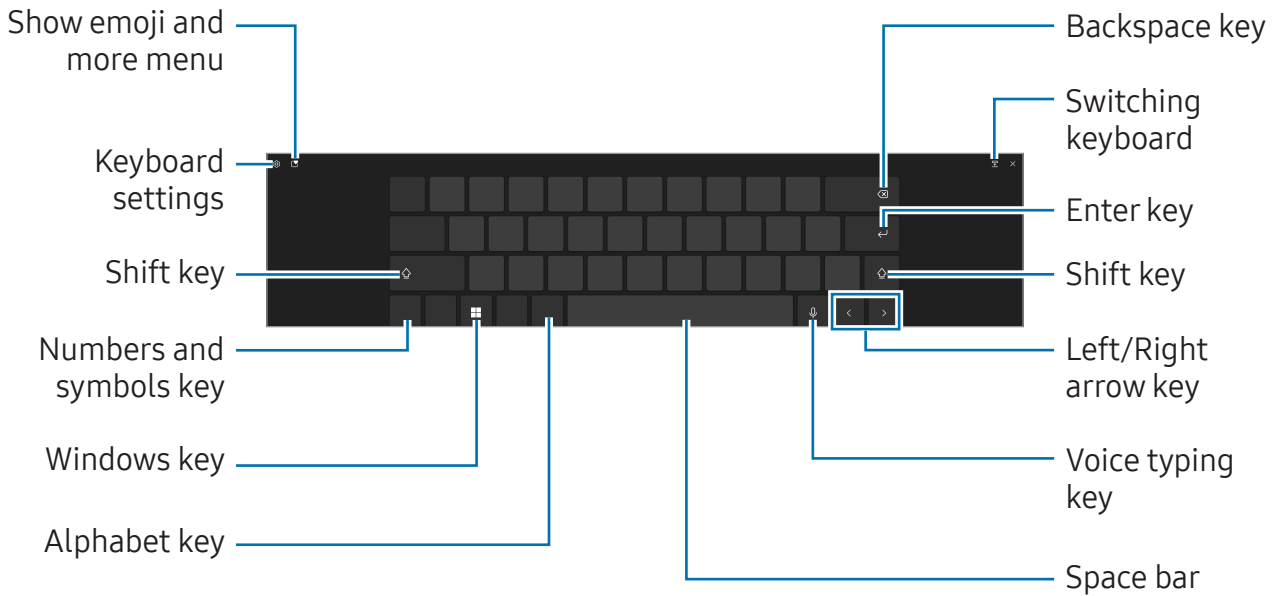

<Touch keyboard functions>

Name	Description
Switching keyboard	Switch to a floating keyboard.
Backspace key	Delete a preceding character.
Enter key	Move to the next line.
Shift key	Create an uppercase character. For all caps, tap it twice.
Left/Right arrow key	Move the cursor.
Voice typing key	Activate the dictation feature to convert spoken words into text.
Space bar	Enter a space.
Alphabet key	Change the keyboard language.
Windows key	<ul style="list-style-type: none"> • Tap it to use keyboard shortcuts. • Tap it twice to open the Start menu.
Numbers and symbols key	Enter numerals and punctuation marks.
Keyboard settings	Change the keyboard settings.
Show emoji and more menu	Enter emojis, animated GIFs, and special characters. You can also add items from the clipboard.

Handwriting

Tap the Keyboard settings icon (⚙️) → **Handwriting**, and then write a word in the on-screen text input field.

 Handwriting is not supported for some languages.

Applying a keyboard theme and resizing the keyboard

To resize the keyboard and apply various themes, tap the Keyboard settings icon (⚙️) → **Size and theme**.

Sending feedback

Tap the Keyboard settings icon (⚙️) → **Give feedback** to ask questions or view frequently asked questions.

Configuring keyboard settings

To configure various settings for the keyboard, tap the Keyboard settings icon (⚙️) → **More settings** and select options.

- **Typing:** Change the settings available when typing.
- **Language:** Add the languages you can use when typing, and set the display language of the computer.
- **Learn more:** View the quick tips for using the keyboard.

Entering uppercase

Tap the Shift key (⇧) before entering a character. For all caps, tap it twice.

Copying and pasting

- 1 Touch and hold over text.
- 2 Drag the Left text selection icon (🔵) or the Right text selection icon (🔵) to select the desired text, or tap **Select all text** to select all text.
- 3 Tap **Copy** or **Cut**.
The selected text is copied to the clipboard.
- 4 Touch and hold where the text is to be inserted and tap **Paste**.
To paste text that you have previously copied, tap the Show emoji and more menu icon (👉) → the Clipboard history icon (📄) and select the text.

Keyboard

Enter text or access computer functions with the keyboard.



- 👉 • Images and available features may differ depending on the model and operating system.
- The keyboard layout may differ depending on the country. The hot keys will be mainly explained in this manual.

Using hot keys

To use keyboard hot keys, do one of the following:

- Press and hold the **Fn** key and press a hot key.

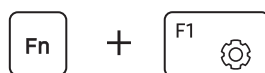













- Press and hold the **Fn** key and press the **F12** key. When the Fn Lock feature turns on, press a hot key.

- 👉 When the Fn Lock feature is on, hot keys are activated without pressing the **Fn** key.

Hot key functions

<Hot key functions>

Key	Description
F1 	Samsung Settings: Launch the Samsung Settings app.
F2 	Screen brightness control: Decrease the brightness of the display.
F3 	Screen brightness control: Increase the brightness of the display.
F4 	Display/External monitor: Switch between the display and an external display device when an external display device is connected to the computer.
F5 	Touchpad: Turn the touchpad function on or off.
F6 	Mute: Mute or unmute the audio.
F7 	Volume control: Decrease the volume.
F8 	Volume control: Increase the volume.
F9 	Keyboard backlight brightness: Turn the keyboard backlight on or off and adjust its brightness.
F10 	Block camera and mic: Limit the use of the camera and the microphone to prevent recording.
F11 	Resource monitor: Monitor the use of the computer's resources in real time.
F12 	Fn Lock: Lock the Fn key so that hot keys can be used without pressing the Fn key.



If the hot keys do not work properly, install the **Samsung Settings** app.

Touchpad

Use the touchpad to move the cursor or select an item. The left and right buttons of the touchpad act the same as the left and right buttons of a mouse.

- Use the touchpad only with fingers. The touchpad will not recognize actions of other objects.
- Images and the touchpad layout may differ depending on the model.

Basic touchpad functions

- **Moving:** To move the cursor, move a finger on the touchpad.
- **Clicking:** Tap the touchpad or press the left touchpad button.

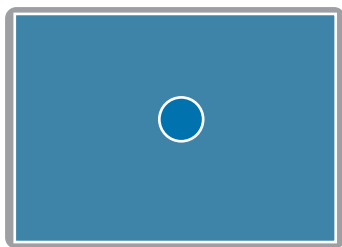

Tap



Click

- **Double-clicking:** Double tap the touchpad or press the left touchpad button twice.

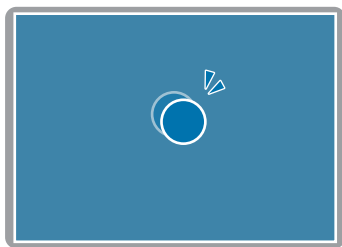

Tap-tap

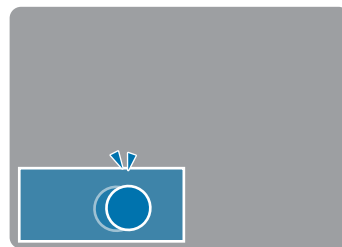

Click-click

- **Right-clicking:** Press the touchpad with two fingers simultaneously or press the right touchpad button.

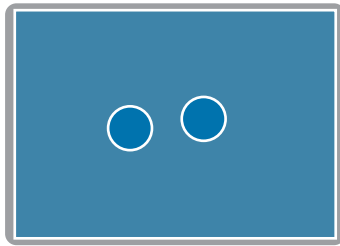

Tap



Click

- **Dragging:** To move an icon or an app to a desired location, press and hold it and then drag it to the target position with the left touchpad button pressed.

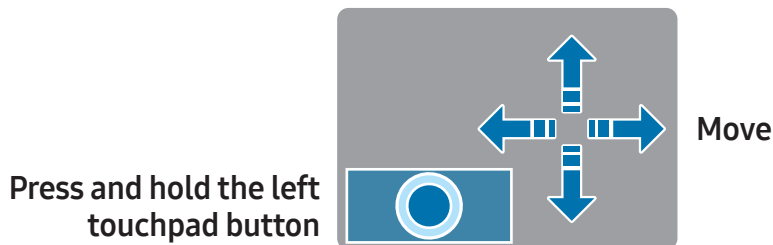

Gesture functions

- **Swiping:** To scroll up, down, left or right to a desired location, swipe with two fingers on the touchpad.
- **Pinching:** To zoom in, spread two fingers apart on the touchpad. Pinch to zoom out.

Configuring touchpad gestures

Configure touchpad gestures to use the touchpad more efficiently.

Select the Start icon () → **Settings** → **Bluetooth & devices** → **Touchpad** and select the desired options.

 Some options in the touchpad settings may not be available depending on the model.

Touchpad lock

Press and hold the **Fn** key and press the **F5** key to lock the touchpad.

SIM or USIM card tray (5G models only)

Insert the SIM or USIM card (nano-SIM card).

- ⚠ • Use only a nano-SIM card (sold separately).
- Use caution not to lose or let others use the SIM or USIM card. Samsung is not responsible for any damages or inconveniences caused by lost or stolen cards.
- ✍ • It is only for data network. The calling feature is not supported.
- Some services that require a network connection may not be available depending on the service provider.

Installing the SIM or USIM card

- 1 Insert the ejection pin into the hole on the tray to loosen the tray.
 - ⚠ Ensure that the ejection pin is perpendicular to the hole. Otherwise, the device may be damaged.
- 2 Pull out the tray gently from the tray slot.
 - ⚠ Be careful to not hurt your fingertip while pulling out the tray.
- 3 Place the SIM or USIM card on the tray with the gold-colored contacts facing downwards.

- 4 Gently press the SIM or USIM card into the tray to secure it and insert the tray back into the tray slot.

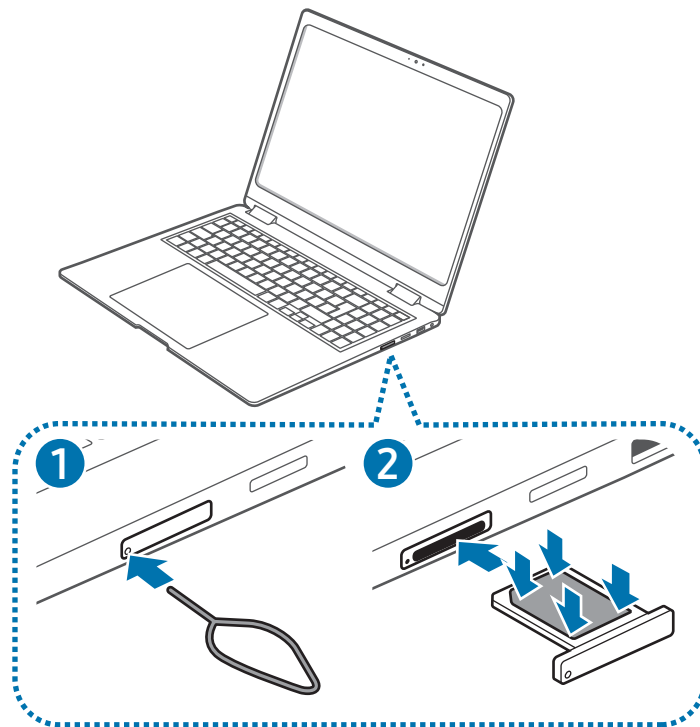

Cellular data (5G models only)

You can insert the SIM or USIM card so you can access the internet using your cellular data connection.

 You may incur additional charges when using a mobile network.

Turning the cellular data on

Select the status icons on the taskbar and select the Cellular data icon (📶). Cellular data will be connected.

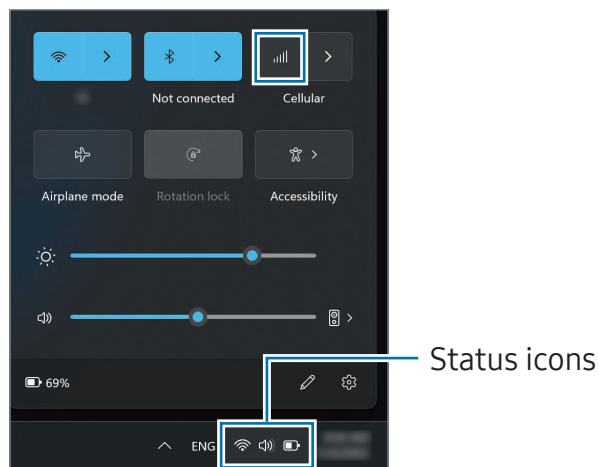

Turning the cellular data off

To save battery power, turn off the cellular data when not in use.

Select the status icons on the taskbar and select the Cellular data icon (📶).

Cellular data will be disconnected.

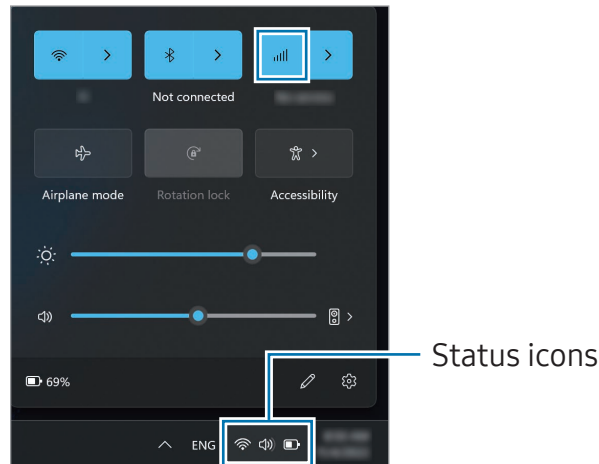

Wireless LAN

Connect the computer to a wireless network to use the internet.

 The descriptions below are for computer models with a Wireless LAN card or device. A Wireless LAN device is optional. The pictures in this manual may differ from the actual product depending on the wireless LAN device model.

About Access Point (AP)

An Access Point (AP) is a network device that bridges wired and wireless LANs and corresponds to a wireless hub in a wired network. Multiple devices can be connected to an AP.

Connecting to a Wi-Fi network

- 1 Select the status icons on the taskbar and select the Manage Wi-Fi connections icon (➤) on the **Wi-Fi** option.

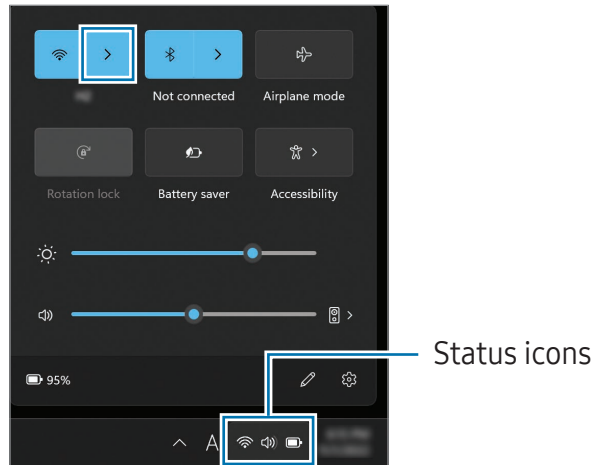

- 2 Select a network from the list of detected wireless networks and select **Connect automatically** → **Connect**.
- 3 Enter a password, if necessary, and select **Next**.
Once the computer has been connected to a wireless network, it will attempt to connect to it automatically when it is available. If you require a network password, contact the system administrator.

Deactivating the Wi-Fi feature

When you are not using the Wi-Fi feature, turn it off to save battery power.

Select the status icons on the taskbar and select the Wi-Fi icon (📶).

The Wi-Fi feature is deactivated.

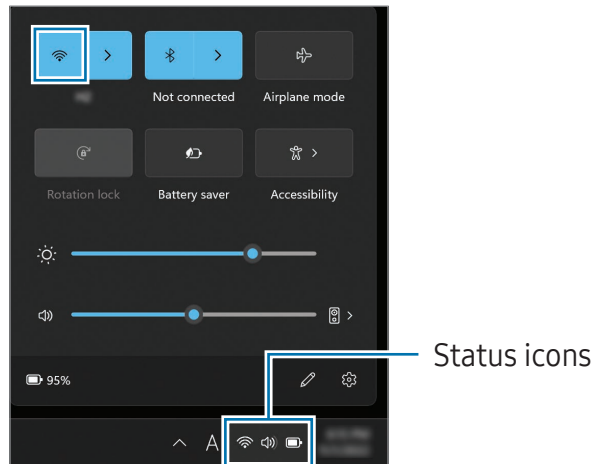

Airplane mode

This disables all wireless functions on your computer. You can use only non-network services.

To activate **Airplane mode**, select the status icons on the taskbar and select the Airplane mode icon (✈️).

Bluetooth

Use Bluetooth to listen to music or exchange data or media files with other Bluetooth-enabled devices.

- ❗ • Samsung is not responsible for the loss, interception, or misuse of data sent or received through Bluetooth.
- Always ensure that you share and receive data with devices that are trusted and properly secured. If there are obstacles between the devices, the operating distance may be reduced.
- Some devices, especially those that are not tested or approved by the Bluetooth SIG, may be incompatible with your device.
- Do not use the Bluetooth feature for illegal purposes (for example, pirating copies of files or illegally tapping communications for commercial purposes). Samsung is not responsible for the repercussion of illegal use of the Bluetooth feature.

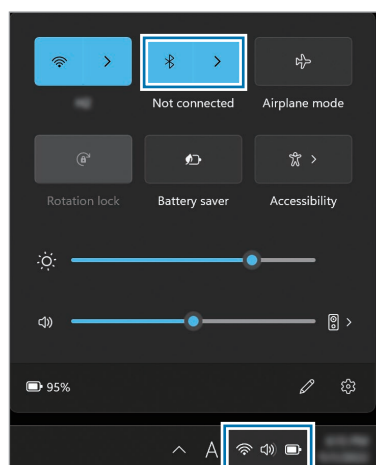

Pairing with other Bluetooth devices

- 1 Select the status icons on the taskbar to ensure that Bluetooth is activated.



- 2 Select the Start icon () → **Settings** → **Bluetooth & devices** → **Add device**.
- 3 Select **Bluetooth** to select a device you want to add and finish pairing.

Unpairing Bluetooth devices

- 1 Select the Start icon () → **Settings** → **Bluetooth & devices**.
Your computer will display the paired devices.
- 2 On the device you want to unpair from your computer, select the More options icon () → **Remove device** → **Yes**.
The connection to the Bluetooth device will be disconnected.

Fingerprint recognition

You can sign in to Windows, apps, and services by teaching Windows to recognize your fingerprint.

-  Remove the sticker from the fingerprint recognition sensor before using it.

Registering your fingerprint

Create a password and PIN first to use the fingerprint scan feature.

- 1 Select the Start icon () → **Settings** → **Accounts** → **Sign-in options**.
- 2 Select **Fingerprint recognition (Windows Hello)** → **Set up** to start the fingerprint registration.
- 3 Select **Get started** on the **Windows Hello setup** window.
- 4 Enter the PIN number you set.

- 5 Repeatedly lift and rest your finger on the fingerprint recognition sensor until setup is complete.

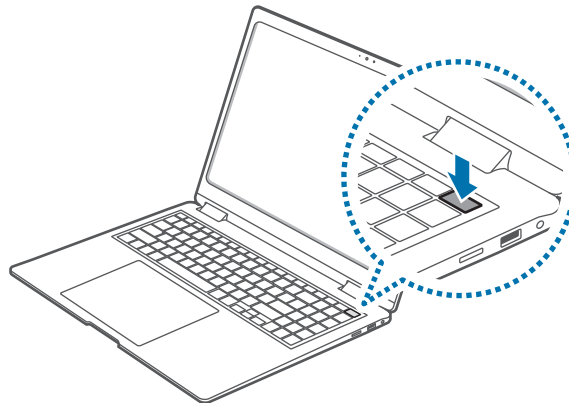
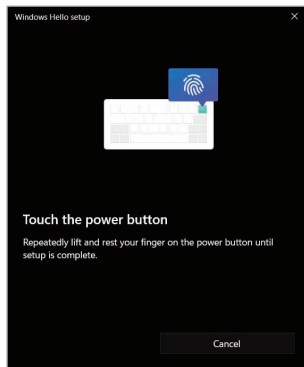

 The fingerprint recognition sensor's location may vary depending on the model.

- 6 Fingerprint registration is complete.
If you want to add another fingerprint, select **Add a finger**.

Removing a fingerprint

- 1 Select the Start icon () → **Settings** → **Accounts** → **Sign-in options**.
- 2 Select **Fingerprint recognition (Windows Hello)** → **Remove**.
The fingerprint will be removed.

Unlocking the screen with a fingerprint

You can unlock the screen by resting your fingerprint on the fingerprint recognition sensor.

Place a registered finger on the fingerprint recognition sensor.

The screen will be unlocked if the fingerprint is scanned correctly.

For better fingerprint recognition

- Prevent the fingerprint recognition sensor from being scratched or damaged by metal objects, such as coins, keys, and necklaces.
- Ensure that the fingerprint recognition sensor and your fingers are clean and dry.
- The fingerprint recognition sensor may not recognize fingerprints that are affected by wrinkles or scars.
- The fingerprint recognition sensor may not recognize fingerprints from small or thin fingers.
- If you bend your finger or use your fingertips, the fingerprint recognition sensor may not recognize your fingerprints. Make sure to cover the entire fingerprint recognition sensor with your finger.
- To improve recognition performance, register the fingerprints of the hand you use most often to perform tasks.
- In dry environments, static electricity can build up in the computer. Avoid using this feature in dry environments or before using the feature, discharge static electricity by touching a metal object.

Memory card slot

Use a memory card to transfer data to other devices. You can use data stored on your device, such as digital cameras, phones, or tablets, on your computer, or you can take your saved data to another device.

Memory cards are sold separately.

This computer supports the following types of memory cards.

<Supported memory card type>

Abbreviation	Description
micro SD	micro Secure Digital
micro SDHC	micro Secure Digital High Capacity
micro SDXC	micro Secure Digital eXtended Capacity

- ❗ • Some memory cards may not be fully compatible with the computer. Using an incompatible card may damage the computer or the memory card, or corrupt the data stored in it.
- Use caution to insert the memory card in the indicated direction.
- Store the card separately to prevent losing the card when moving the computer.
- Memory card speeds vary.

Inserting a memory card

If a memory card adapter or an unnecessary card is inserted in the memory card slot, remove it. Then insert a memory card into the slot in the indicated direction.

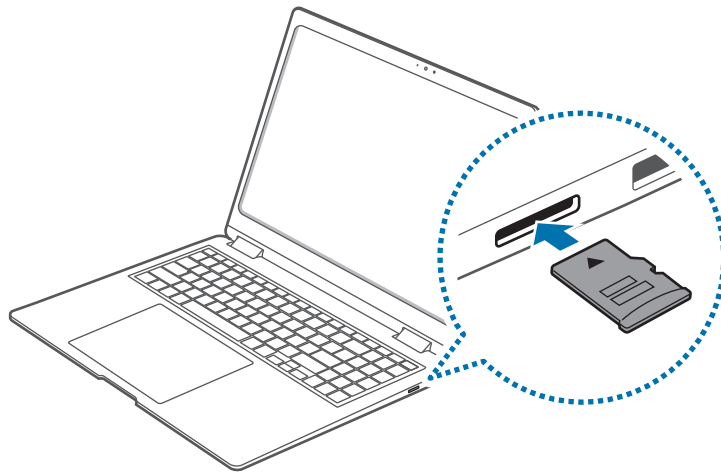

Removing a memory card

When you push the card, it clicks and disengages from the memory card slot. Grasp the end of the card and pull it out of the slot.

Formatting a memory card

Format the memory card to remove all data or before using it for the first time.

- ❗ • Formatting a memory card deletes all data saved on the card. If necessary, back up important data before formatting the card.

- 1 On the taskbar, select the File Explorer icon (📁).
- 2 Right-click the memory card drive, and then select **Format**.

3 Select **Start**.



- To use a memory card to exchange data with a digital device, such as a digital camera, formatting the data with the digital device is recommended.
- When trying to use a formatted memory card in another digital device, format the memory card again in the device.
- Data protected by copyright laws cannot be reviewed or modified.
- Inserting and removing a memory card repeatedly may damage the memory card.
- Secure Digital Input Output (SDIO) is not supported.
- If the write-protect tab is in the locked position, you cannot format, write, or delete data on the card.

Thunderbolt™ 4

You can use Thunderbolt™ devices or share files and printers by connecting two computers that support Thunderbolt™.

Using Thunderbolt™ devices

Connect the Thunderbolt™ device to the Thunderbolt™ 4 port.

Connecting two computers that support Thunderbolt™

- 1 Use a Thunderbolt™ cable (sold separately) to connect the computers through their Thunderbolt™ 4 ports.
- 2 Select the Start icon () → **Settings** → **Network & internet** → **Advanced network settings** → **Advanced sharing settings**.
- 3 Select the switches of network profile sharing options to activate them.

4 On the main computer's Desktop, select the icon for the connected computer to access the folder being shared.

 **If the computer does not properly scan your Thunderbolt™ device after connecting it**

After removing a Thunderbolt™ device, you can connect a new Thunderbolt™ device after a few seconds. Your computer may fail to recognize a device connected immediately after removing the previous device.

External display

Connecting the computer to an external display device can be useful for presentations or when watching a movie. The cables and adapters required to connect an external display are sold separately. The computer supports HDMI cables and Thunderbolt™ display cables.

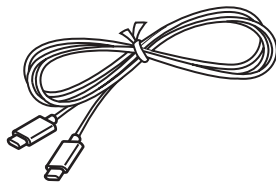

Thunderbolt™ display cable

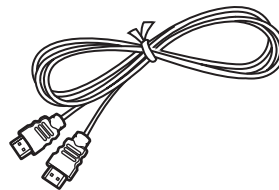

HDMI cable

 Check the available ports on the display device to ensure that it is compatible with the computer.

Connecting to a display

- 1 Connect the cable to the HDMI port or Thunderbolt™ 4 port of the computer.
- 2 Connect the other end of the cable to the external display.
 - When using a Thunderbolt™ display cable

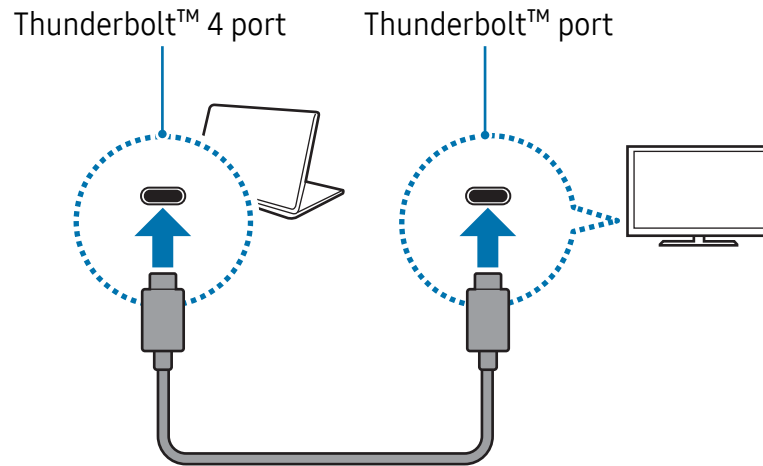

- When using an HDMI cable

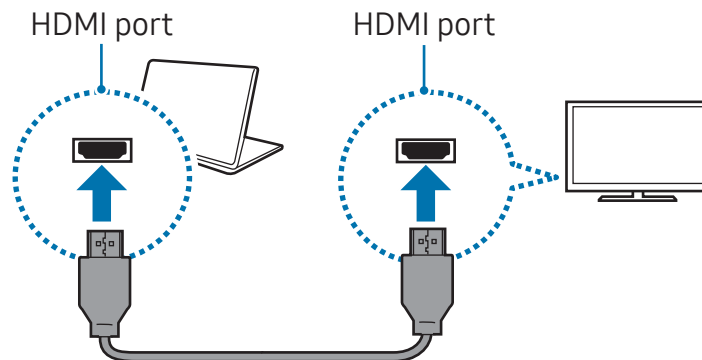

- 3 Connect the power cord to the external display.
- 4 Turn on the display and change its display mode to one that supports an external input.
- 5 Press and hold the **Fn** key and press the **F4** key.

6 Select a mode.

- **PC screen only:** Show the screen on the computer monitor only.
- **Duplicate:** Show the screen on both the computer and the external display.
- **Extend:** Extend the screen to the external display.
- **Second screen only:** Show the screen on the external display only.



You can also select the display mode in Windows settings.

Select the Start icon () → **Settings** → **System** → **Display** → **Multiple displays** and select **Detect** next to **Detect other displays**.

Apps and features

Using apps



- Images and features may differ depending on the model and the app version.
- Some apps may not be supported depending on the model.
- Apps that are provided by Samsung can be installed from **Microsoft Store**.
- **Third-party software related services**

For descriptions about and service requests for third-party apps, please contact the relevant manufacturer. Some troubleshooting actions in response to service requests may not work depending on the app manufacturer.

Samsung Account

Your Samsung account is an integrated account service that allows you to use a variety of Samsung services provided by computers, mobile devices, TVs, and the Samsung website.

To check the list of services that can be used with your Samsung account, visit account.samsung.com.



To use this feature, the computer must be connected to the internet.

- 1 Select the Start icon () → **All** → **Samsung Account**.
- 2 Select **Get started** and sign in to your Samsung account. If you do not have a Samsung account, select **Create account**.

Finding your ID and resetting your password

If you forget your Samsung account ID or password, select **Find ID** or **Forgot password?** on the Samsung account sign-in screen. You can find your ID or reset your password after you enter the required information.

Signing out of your Samsung account

When you sign out of your Samsung account, your data which is related to your Samsung account will also be removed from your computer.

Select the Start icon () → **All** → **Samsung Account** → **Sign out**.

Samsung Settings

Samsung Settings, a Samsung-integrated settings app, offers various settings functions.

 Images and features may differ depending on the model and the app version.

- 1 Select the Start icon () → **All** → **Samsung Settings**.
- 2 Select an option to configure the corresponding function.

<Samsung settings functions>





Menu	Description
Connections	Set connection settings, such as the Bluetooth connection.
Connected devices	Change settings for computer connections.
Sound	Change settings for sounds.
Display	Change the display settings.
Security and privacy	Set the security and privacy status.
Advanced features	Activate advanced features and change the settings that control them.
Battery and performance	Set the battery settings.
Keyboard	Set keyboard backlight settings.
About	View computer and the Samsung Settings app information.

Samsung Notes

Introduction

Create notes by entering text from the keyboard or by handwriting or drawing on the screen. You can also insert images or voice recordings into your notes.

Creating notes

- 1 Select the Start icon () → **All** → **Samsung Notes** → the Create note icon () and create a note.
Select an input method from the toolbar on the right side of the screen.
- 2 When you are finished composing the note, select the Back icon () to save it.
If you want to save the note in another file format, select the More options icon () → **Save as file**.

Deleting notes

Right-click the note you want to delete on the note list and select **Delete**.

Composing notes with handwriting

On the note composer screen, select a tool on the right side of the screen to write or draw with the S Pen.

You can enter your handwriting more easily if you magnify the screen by spreading two fingers on it.

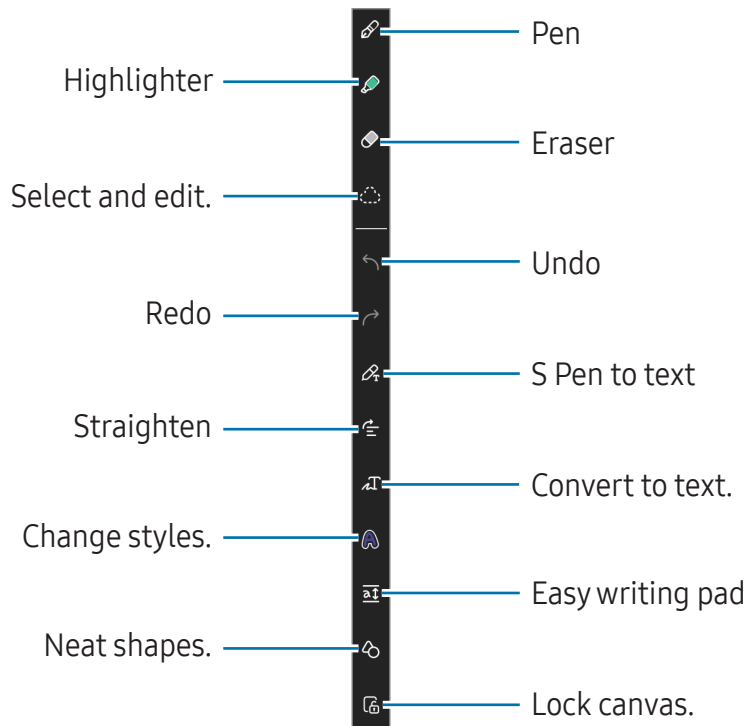

Using the eraser

When you want to erase handwriting from a note, select the Eraser mode icon (🧽) and select an area to erase. Alternatively, select an area while pressing and holding the S Pen button.

- **Stroke eraser:** Erase the line you select.
- **Area eraser:** Erase only the area you select. You can adjust the size of the eraser by dragging the size adjustment bar.
- **Eraser highlighter only:** Erase only the area you draw with the highlighter.
- **Erase all handwriting:** Erase all the handwriting from the saved notes and note composer screen.

 Even with a smaller eraser, you may still not be able to precisely erase the intended part.



Editing handwritten notes

Edit handwritten notes using various editing options, such as cutting, moving, or resizing.

- 1 When there is handwriting on the note, select the Selection mode icon ()
You can also change the shape of the selection.
- 2 Select the input or draw a line around the input to select.
 - To move the input to another location, select the input, and then drag it to a new location.
 - To change the size of the selection, select the input and drag a corner of the frame that appears.
 - To edit the input, right-click the input and select an option you want.

Converting handwriting to text

Select the S Pen to text icon () and write on the screen with the S Pen. The handwriting will be replaced with text right away.

After writing on the screen, select the Convert to text icon () . Options will appear in the preview window. If you drag the Upper text selection icon () or the Lower text selection icon () , you can select the handwriting you want. To replace the handwriting with the text, select **Convert**.



Straightening content horizontally

You can horizontally straighten your handwriting and drawings.

After writing or drawing on the screen, select the Straighten icon () .

Changing styles

You can change the style of your handwriting and drawings.

After writing or drawing on the screen, select the Change style icon () and select a color or line thickness you want. Then, point the S Pen toward where you want to apply the style. When the Arrow icon () appears, select where you want to change the style.

Using the easy writing pad

Use the easy writing pad to enter your handwriting more easily.

Select the Easy writing pad icon () . The input field will be magnified and appear as the easy writing pad.

Automatically fixing shapes

Select the Auto-fix shapes icon () and draw a shape. The shape will be fixed.

Recording voice to notes

Make a recording of your voice while creating a note, and then the content will be synchronized with the recording.

On the note composer screen, select the Attach icon () → **Voice recordings** and create a note.



Select a note from the list and select the Play icon () to play the recording. Then the content you created while recording will be displayed on the screen along with the recording.

Adding memos to PDF files

On the note composer screen, select the PDF file icon () , and then select a PDF file. You can add memos to the PDF file.

Samsung Flow

Samsung Flow allows you to easily connect your mobile device to your computer to complete tasks, such as checking notifications or sharing content, more conveniently.

- 1 Select the Start icon () → **All** → **Samsung Flow**.
 - 2 On your mobile device, launch the Samsung Flow app.
If Samsung Flow is not installed, download it from the Galaxy Store or Play Store.
 - 3 Select **Start**.
 - 4 Select your mobile device from the detected devices list.
If the connection method selection pop-up window appears, select the method you want.
 - 5 Confirm the passkey on both devices and select **Ok**.
The devices will be connected.
-  • This feature is only available on some Samsung Android devices.
 - Refer to the mobile device's user manual for more information about how to use Samsung Flow.

Samsung Studio Plus

Create and edit videos easily using photos and videos in your computer.

- 1 Select the Start icon () → **All** → **Samsung Studio Plus**.
- 2 Select **New project**.
- 3 Select **Files, Folder**, or **Samsung Gallery** to add files and select **OK**.
- 4 Edit the video by inserting music or text.
- 5 When you are finished editing the video, select **Export** to save the video.

Samsung Gallery



View images and videos stored in your computer.

Viewing images and videos



Select the Start icon () → **All** → **Samsung Gallery**.

The images and videos stored on your computer will appear.

Editing images or videos

- 1 Select the Start icon () → **All** → **Samsung Gallery**.
- 2 Select the images and videos you want to edit and select the Edit icon ().

Deleting images or videos

- 1 Select the Start icon () → **All** → **Samsung Gallery**.
- 2 Select the images and videos you want to delete and select the Delete icon ().
The deleted images and videos will move to the Windows Recycle Bin.

Samsung Care+

The guaranteed services provided by **Samsung Care+** will cover certain problems that may arise while using the product, such as damaged or lost computers.

Select the Start icon () → **All** → **Samsung Care+**.

The website will appear. Refer to the website for more information.

-  • To use this feature, the computer must be connected to the internet.
- This feature may not be available depending on your model or region.

Samsung Device Care

You can create a system restore point and restore back to that point. You can also check and clean up computer's storage or memory. When someone else is using your computer, such as when you send it for repairs, you can turn on maintenance mode to protect your privacy.

Creating a restore point

1 Select the Start icon () → **All** → **Samsung Device Care**.

2 Select **Backups** → **Back up now**.

 If you do not want to use the auto backup feature, select **Settings** and select the **Back up automatically and monitor app installations** switch to turn it off.

Restoring to an earlier restore point

1 Select the Start icon () → **All** → **Samsung Device Care**.

2 Select **Backups** and select the date that you backed up the system.

3 Select **Restore**.

Managing the storage

1 Select the Start icon () → **All** → **Samsung Device Care**.

2 Select **Storage**.

3 Check the status of the used and available storage.

To delete files that you do not use anymore, select a category, select an item, and then select **Delete**.

Optimizing the memory

1 Select the Start icon () → **All** → **Samsung Device Care**.

2 Select **Optimize memory**.

Check the memory usage and clean up the unused memory.

Using maintenance mode

- 1 Select the Start icon () → **All** → **Samsung Device Care**.
- 2 Select **Settings** → **Maintenance mode**.
- 3 Select **Turn on Maintenance mode** and follow the on-screen instructions. The computer will enter maintenance mode.

Samsung Pass

On your computer, use the login or personal information saved in Samsung Pass on your phone or tablet. When entering your Samsung account, ID, password, or personal information, such as your address, use Samsung Pass to easily sign in or enter information.

-  • To use this feature, you must complete the Samsung Pass setup on your phone or tablet and also register your information first. Refer to the device's user manual for more information.
- To use this feature, you must sign in your Samsung account. Use the same Samsung account that was set up with Samsung Pass on your phone or tablet.
- To use this feature, the computer must be connected to the internet.

- 1 Select the Start icon () → **All** → **Samsung Pass**.
- 2 Select **Sign in** and follow the on-screen instructions to complete the setup.
- 3 On the sign-in page of the website or app, easily log in or enter the personal information with Samsung Pass.

Bixby

Bixby is a user interface that helps you use your device more conveniently.

You can talk to Bixby or type text. Bixby will launch a function you request or show the information you want. Visit www.samsung.com/bixby for more information.

-  • Bixby is only available in some languages, and it may not be available depending on the region.
- To use this feature, the computer must be connected to the internet.

Starting Bixby

Select the Start icon () → **All** → **Bixby**. The Bixby intro page will appear. After you select the language to use with Bixby, sign in to your Samsung account, and complete the setup by following the on-screen instructions, the Bixby screen will appear.

Using Bixby

Say “Hi, Bixby” and say what you want. Alternatively, press the **Ctrl**, **Shift**, and **B** keys at the same time and tell Bixby what you want.



For example, say “Hi, Bixby” and say “How’s the weather today?” The weather information will appear on the screen.

If you want to know the weather tomorrow, say “Hi, Bixby” and just say “Tomorrow?”

If Bixby asks you a question during a conversation, say “Hi, Bixby” and answer Bixby. Or select the Talk to Bixby icon () and answer Bixby.

Waking up Bixby using your voice

You can start a conversation with Bixby by saying “Hi, Bixby”.

- 1 Select the Start icon () → **All** → **Bixby**.
- 2 Select the More options icon () → **Settings** and select the **Wake with “Hi, Bixby”** switch to activate it.

Now you can say “Hi, Bixby” and start a conversation.

Galaxy Book Smart Switch

Galaxy Book Smart Switch allows you to transfer data from your previous computer to your new computer.



- To use this feature, both your computer and previous computer must be connected to the same Wi-Fi network.
- This feature may not be supported on some computers.
- Samsung takes copyright seriously. Only transfer content that you own or have the right to transfer.

- 1 On the previous computer, launch the **Galaxy Book Smart Switch** app.
If you do not have the app, download it from **Microsoft Store**.
- 2 On your computer, select the Start icon () → **All** → **Galaxy Book Smart Switch**.
- 3 Place the computers near each other.
- 4 On the previous computer, select **Send data**.
- 5 On your computer, select **Receive data**.
- 6 On the previous computer, select **Allow**.
- 7 On your computer, select an item to bring and select **Transfer**.



Transferring data increases the battery power consumption of your computer. Ensure that your computer is sufficiently charged before transferring data. If the battery power is low, data transfer may be interrupted.

Galaxy Book Experience



Galaxy Book Experience allows you to check the information for various apps or features provided by Samsung and use them.

- 1 Select the Start icon () → **All** → **Galaxy Book Experience**.
- 2 Select the card you want.
- 3 Check the information of the app or feature, and select **Open** to launch it.

Online Support(S Service)

A service associate can resolve any problems you have with your computer using the online chat and remote control program. You can receive the help when you are having trouble using Samsung software.

You can access the online service for free for a certain period of time after purchasing your computer.

-  • **Online Support(S Service)** may not be offered or its version may be different depending on the model or region.
- If **Online Support(S Service)** is not installed, select the Start icon () → **Microsoft Store** () and, search for **S Service** to download it.

1 Select the Start icon () → **All** → **Online Support(S Service)**.

2 Read and agree to the terms and conditions.

 This step appears only when the app runs for the first time.

3 Select **Online Talk** on the main page.

Select **Please enter the details of your inquiry.**, enter your inquiry, and then select **Request**.

4 You can speak to a service associate to resolve your computer's problems.

 Waiting times may vary depending on the network and number of waiting customers.











Studio mode

You can use various features when taking a picture or recording a video with the camera. Select the Start icon () → **All** → **Camera**. The **Studio mode** pop-up window will appear.

- **Face effects:** Apply various filter effects.
- **Background effect:** Apply various background effects.
- **Auto framing:** Track and automatically focus on a subject and zoom in when recording videos. On the preview screen, the computer's camera will focus on the subject, even if the subject is moving or you change the computer's position.
- **Eye contact:** Make it look like you are focusing on the computer's camera, even if you are looking at the display when recording a video.
- **HDR:** Record videos with rich colors and reproduce details even in bright and dark areas.

Screen Recorder

Record the screen while using your computer.

- 1 Select the Start icon () → **All** → **Screen Recorder**.
The screen recorder toolbar will appear on the top of the screen.
- 2 Select the Start recording icon () to start recording.
After a countdown, recording will start.
 - To adjust the position and size of the recording area, select the Record part of the screen icon () before starting recording.
 - To capture the screen, select the Screenshot icon ()
 - To record the screen with a video overlay of yourself, select the Webcam icon ()
The web cam window will appear.
 - To change the screen recorder settings, select the Settings icon () before starting recording.
 - To write or draw on the screen, select the Pen tools icon ()
 - To add a text box on the screen, select the Text tools icon ()
- 3 When you are finished recording the screen, select the Stop recording icon ()
You can view the file in the File Explorer icon () → **This PC** → **Videos** or **Pictures**.

4 Select the Close Screen Recorder icon (✕) to finish the screen recorder toolbar.



- Select the Minimize toolbar icon (➤) to expand or collapse the screen recorder toolbar.
- If your computer enters sleep mode while recording the screen, the recording will be paused.
- If your computer turns off abnormally while recording the screen, the recorded file will not play normally.
- Some apps or programs may not support the screen record or screen capture features.

Setting the video resolution

1 Select the Start icon (☰) → **All** → **Screen Recorder**.

The screen recorder toolbar will appear on the top of the screen.

2 Select the Settings icon (⚙️).

The **Screen Recorder settings** window will appear.

3 Select **Video** and select the resolution you want under **Video resolution**.



You can set the video resolution only when recording in full screen mode.

Quick Search

Search for content on the computer quickly.

1 Select the Start icon (☰) → **All** → **Quick Search**.

2 Select **Start Quick Search**.



This step appears only when the app runs for the first time.

3 Select the search field to enter a keyword.

Content on your computer will be searched.

SmartThings

Control and manage smart appliances and SmartThings compatible products.

Select the Start icon () → **All** → **SmartThings**.

- **Home camera streaming:** You can check the connected home camera's live-streamed video.
- **Ring your phone or tablet:** You can find the Galaxy phone or tablet signed in to your Samsung account by ringing them.
- **Device control:** You can control the frequently used devices or routines directly on the main screen.
- **Settings:** Configure settings for the SmartThings app.



- To use this feature, you must sign in to your Samsung account.
- You can connect devices through the SmartThings app on your phone or tablet.
- Connected devices' own problems or defects are not covered by the Samsung warranty. When problems or defects occur on the connected devices, contact the device's manufacturer.
- To use this feature, the computer must be connected to the internet.
- When the network is connected, it enables SmartThings features.

Quick Share

Send content to nearby devices using Wi-Fi Direct or Bluetooth.

- 1 Select the Start icon () → **All** → **Quick Share**.
- 2 Select a device to transfer the image to.
- 3 Select the image.
- 4 Accept the file transfer request on the other device.

Second Screen

Connect your computer and tablet to use the tablet as an additional display for the computer.

-  • Only Samsung tablets can be connected using this feature. To see models that support the Second Screen feature, visit the Samsung website.
- This feature is only available on tablets running One UI version 3.1 or higher software.
- To use this feature, you must connect the computer and tablet to the Wi-Fi network. It is not necessary to connect both devices to the same Wi-Fi network, but it is recommended to connect them to the same Wi-Fi network for a stable connection.



- 1 On your tablet, activate the Second Screen feature.
- 2 Select the Start icon () → **All** → **Second Screen**.
- 3 Select your tablet from the detected devices list.
Your computer's screen will appear on the connected tablet.

-  If the computer has previously connected to a tablet, it will automatically reconnect to that tablet.

Private Share

Share files with others securely using blockchain technology.

-  Others cannot download or capture the files shared using Private Share.

- 1 Select the Start icon () → **All** → **Private Share**.
- 2 Select **Share files** or the Add icon (+), and then select the files you want to share.
- 3 Enter the phone number or private number of the other device and select the Add icon (+).
- 4 Set the expiration date and select **Send**.
The files will be shared when the other person accepts the sharing request.
 - To modify the expiration date of files, select the file and select the More settings icon () → **Change expiration date**.
 - To stop sharing files, select the More settings icon () → **Revoke shared files**.

Settings & Upgrade

Display brightness

Adjust the display brightness to reduce eye strain and save power.

Controlling brightness using the keyboard

- To dim the display screen, press and hold the **Fn** key and press the **F2** key.
- To brighten the display screen, press and hold the **Fn** key and press the **F3** key.

Controlling brightness using the taskbar

- 1 Select the status icons on the taskbar.
- 2 Drag the adjustment bar to the desired brightness.

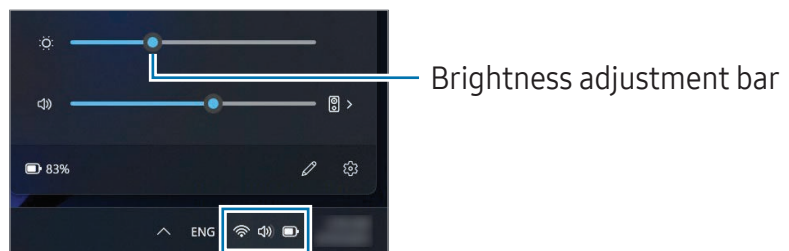

-  The display screen is automatically set to the brightest level when the adapter is connected. The display screen automatically becomes dimmer when the adapter is disconnected.
- The computer has an automatic screen brightness adjustment to extend the battery usage time. When necessary, the screen brightness is gradually adjusted.

Changing display mode

Select the optimal screen settings based on your activity.

 Some options may not be available depending on the model.

- 1 Select the Start icon () → **All** → **Samsung Settings**.
- 2 Select **Display** → **Auto mode**, and then select an option.
 - **Auto mode**: Optimizes the screen automatically for the currently running program.
 - **Vivid (AMOLED native)**: Makes scenes more vivid and clear using AMOLED color space.
 - **Natural (sRGB)**: Make videos natural using sRGB color space.
 - **Photo editing (Adobe RGB)**: Optimizes photo editing using Adobe RGB color space.
 - **Movie (DCI-P3)**: Optimizes for movies using DCI-P3 color space.

Optimizing the full screen color balance

Optimize the screen color by adjusting the color tones to your preference.

- 1 Select the Start icon () → **All** → **Samsung Settings**.
- 2 Select **Display** → **Advanced color settings**.
- 3 Drag the color adjustment bar to the desired color tone.

Volume

Adjust the system volume or sound volume when playing music or video.

Controlling volume using the keyboard

- To turn down the volume, press and hold the **Fn** key and press the **F7** key.
- To turn up the volume, press and hold the **Fn** key and press the **F8** key.
- To mute or unmute the volume, press and hold the **Fn** key and press the **F6** key.

Controlling volume using the taskbar

- 1 Select the status icons on the taskbar.
- 2 Drag the adjustment bar to the desired volume.

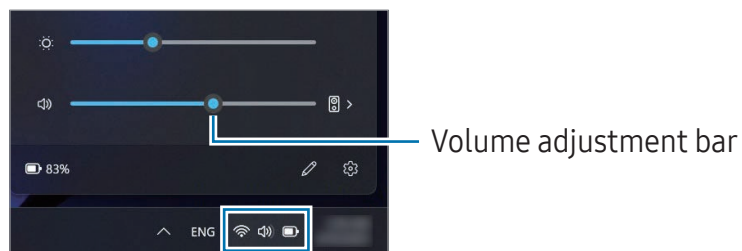

Accessibility

Configure various settings to improve accessibility to the computer.

Select the Start icon () → **Settings** → **Accessibility** and select a feature you want.

Refer to www.microsoft.com/en-us/windows/accessibility-features for more information.

BIOS (Setup utility)

Define a boot password, change the boot priority, or configure the installed chipsets.

- ✍ • Incorrect settings may cause the system to malfunction or crash.
- The BIOS setup screens, menus, and items may appear differently depending on the model and BIOS version.
- BIOS setup functions are subject to upgrades.

Entering the BIOS screen

- 1 Turn on the computer.
- 2 Before the Samsung logo appears, press the **F2** key several times.
 - If the computer is password-protected, press the **F2** key several times before the password screen appears.
 - If the password screen or the Windows start screen appears, restart the computer and try again.

The BIOS screen

The BIOS setup screen appears as shown below.

You can change BIOS settings using the keyboard or mouse.

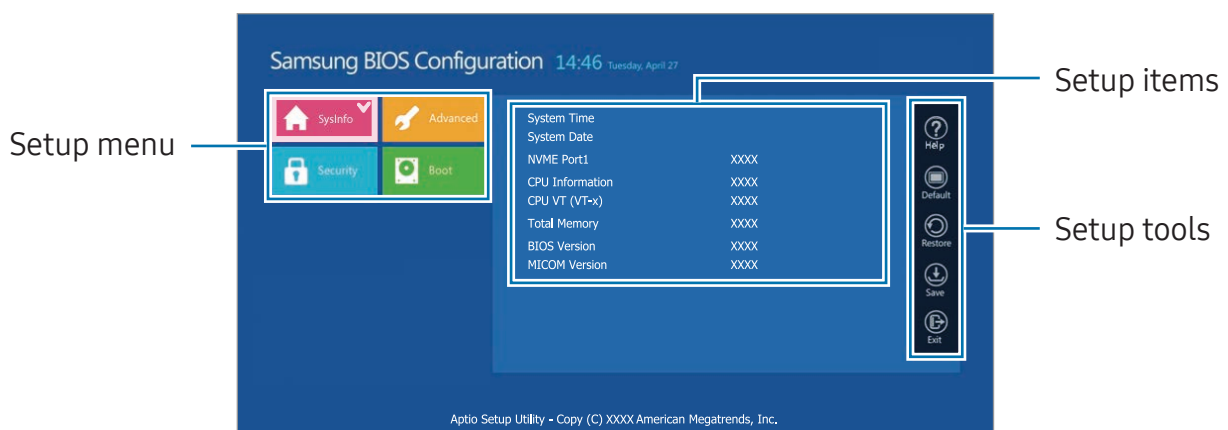

<BIOS screen functions>

Name	Description
Setup tools	<ul style="list-style-type: none"> • Help: View the help for BIOS set up. • Default: Return to the default settings. • Restore: Cancel changes. • Save: Save settings. • Exit: Exit BIOS setup.
Setup menu	<ul style="list-style-type: none"> • SysInfo: View the basic specifications of the computer. • Advanced: Configure the chipsets and additional functions. • Security: Configure security functions. • Boot: Configure accessories and boot-related settings.

 The BIOS setup screen appears only in English.

Boot password

Setting a password with the BIOS enhances protection against viruses and hacking attacks.

-  Do not forget your password or expose it to others.
- If you forget the **Supervisor Password** or **HDD Password**, request assistance from the Samsung Service Center. In this case, a service fee will be charged.
- If you forget the **User Password**, disable the **Supervisor Password**, and the **User Password** will also be automatically disabled.

Setting passwords

You can set passwords following the instructions below on the BIOS setup screen.

- **Supervisor Password** (low security level): This password is required when turning on the computer or entering the BIOS setup.
- **User Password** (low security level): This password is required to enter the BIOS setup. This password will be deactivated automatically if the **Supervisor Password** is disabled.
- **HDD Password** (high security level): This password is required to access the hard disk drive (HDD) from another computer. This password may not be supported, depending on the model or storage device.

Setting a boot password

- 1 Turn on the computer.
- 2 Before the Samsung logo appears, press the **F2** key several times.
- 3 Access the **Security** menu on the BIOS setup screen.
- 4 Select a password type (**Set Supervisor Password**, **Set User Password**, or **Set HDD Password**).
If you cannot select an item or the **HDD Password Frozen** message appears, turn off the computer and turn it on again. Then, press the **F2** key several times before the Samsung logo appears to enter the BIOS setup screen.
- 5 Enter a password and select **Ok**.
The password should be 8-20 characters and contain both uppercase and lowercase letters and numbers.
- 6 Select **Save** → **Ok** to save and restart.
 -  • To enable the **Password On Boot** option, set a **Supervisor Password** and enter the password when starting up the computer.
 - For some models, if the password entered message appears in the **Setup Notice** window, select **Ok** to complete the setup.

Removing a password

- 1 Turn on the computer.
- 2 Before the Samsung logo appears, press the **F2** key several times.
- 3 Access the **Security** menu on the BIOS setup screen.
- 4 Select a password type (**Set Supervisor Password**, **Set User Password**, or **Set HDD Password**).
- 5 Enter the current password next to **Enter Current Password**.
- 6 Do not enter any characters next to **Create New Password**, **Confirm New Password** and select **Ok** → **Ok**.
- 7 Select **Save** → **Ok** to save and restart.
 -  For some models, to cancel the password, select **Cancel** in the **Setup Notice** window.

Changing the boot priority

Change the boot priority from the BIOS setup.

- 1 Turn on the computer.
- 2 Before the Samsung logo appears, press the **F2** key several times.
- 3 Access the **Boot** menu on the BIOS setup screen.
- 4 Select **Boot Device Priority**.
- 5 Select an option menu to open the list.
- 6 Select an option.
- 7 Select **Save** → **Ok** to save and restart.
Select **Exit** → **Ok** to restart without saving the changes.

Using the Battery Calibration function

When charging/discharging the battery repeatedly for a short time only, the battery usage time may be reduced by the difference between the actual battery charge and the remaining charge display.

You can make the actual battery charge and the remaining charge display the same by discharging the battery completely using the Battery Calibration function, and then recharging it again.

 The terms may differ from the actual product depending on the computer model and driver version.

- 1 Turn off the computer and then disconnect the adapter.
- 2 Turn the computer back on and press the **F2** key before the Samsung logo appears to enter the BIOS setup screen.
- 3 Select **Advanced** → **Smart Battery Calibration**.
- 4 The Battery Calibration function is activated and the battery is forcefully discharged. To stop the operation, press the **Esc** key.
This operation requires 3–5 hours depending on the battery capacity and the remaining battery charge.

Using the Smart Battery Power Off function

Storing your computer in a discharged state for an extended period of time can shorten battery life quickly. If you are not going to use your computer for a long period, more than 3 months, you can use the Smart Battery Power Off function to prevent the battery life from quickly shortening.

-  • After shutting down the computer, store it in a cool, dry environment to maintain stable battery performance.
- The battery must be charged at least 30 % before using this function.
- To use this feature, use the supplied adapter.

- 1 Turn off the computer and then disconnect the adapter.
- 2 Turn the computer back on and press the **F2** key before the Samsung logo appears to enter the BIOS setup screen.
- 3 Select **Advanced** → **Smart Battery Power Off**.
- 4 Select **Yes**.
The computer will turn off automatically.
- 5 After connecting the adapter, turn on the computer again.

Battery

Fully charge the battery using the adapter before using the computer for the first time.

-  • Use only Samsung-approved adapters, batteries, and cables. Unapproved adapters or cables can cause the battery to explode or damage the computer.
- Incorrectly connecting the adapter may cause serious damage to the computer.
- To safely remove or replace the battery, it is recommended to take the computer to a Samsung Service Center. You will be charged for this service if the repair is not covered under warranty.
- You can use the computer while it is charging, but the battery charging time may increase. If the battery temperature rises too much, the charging may stop as a safety measure.



- To restore the battery power after cutting it, connect the adapter.
- When you connect the adapter to a multiport adapter to charge the computer, the charging speed message may appear, but the computer will be charged normally.
- If many devices are connected to the multiport adapter, the computer may not be charged or the charging time may increase. In this case, connect the adapter directly to the computer.
- When the adapter is directly connected to the computer, the charging speed message will not appear.
- If the computer will not be used for an extended period, longer than 3 months, you can use the Smart Battery Power Off function to prevent the battery life from quickly shortening. Refer to **Using the Smart Battery Power Off function** for more information.

Charging the battery

- 1 Connect the adapter to the Thunderbolt™ 4 port of the computer.

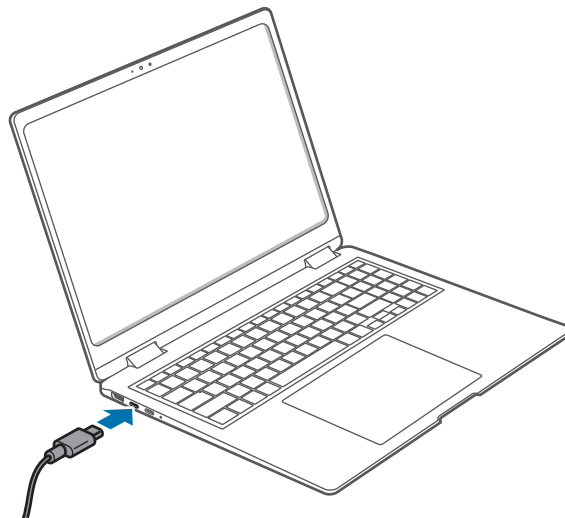

- 2 Plug the adapter into an electric socket.

- When the battery is fully charged, the operating status LED turns green. Disconnect the adapter from the computer.

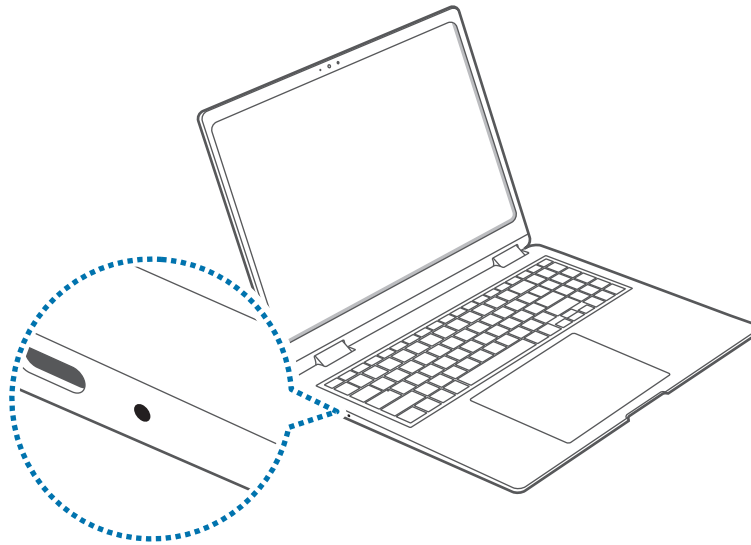

<Status of operating status LED>

Operating status LED	Status
Red	Charging
Green	Fully charged
Blue	Turned on

- Unplug the adapter from the electric socket.

 Do not allow the adapter to make contact with your skin for a long time. A low-temperature burn may result.

Battery status

When the adapter is removed, move the cursor over the battery icon on the taskbar to view the current battery charge.

 The current battery charge may differ depending on the model.

Viewing the current battery charge when the computer is turned off

Connect or disconnect the adapter from the computer to view the current battery charge when the computer is turned off.

Saving battery power

Right-click the battery icon on the taskbar and select **Power and sleep settings** → **Battery saver** → **Turn on now**.

Battery saver mode is activated.

 Battery saver mode is disabled when the adapter is connected.

Extending battery life

When charging your computer by connecting the adapter, activate the Protect battery feature. You can extend the battery life by charging it up to 85 % of its maximum charge capacity.

- 1 Select the Start icon () → **All** → **Samsung Settings**.
- 2 Select **Battery and Performance** and tap the **Protect battery** switch to activate it.

Battery usage time

Batteries are replaceable items and over time the battery's capacity to hold a charge and its power level is reduced. If a battery can only hold its charge for half of the time that it could when new, it is recommended to purchase a new, replacement battery.

Checking battery life instruction messages

When the battery has expired, an instruction message may appear on the screen. To prevent the computer from losing data and to use the computer safely, follow the on-screen instructions.

When battery expiration is imminent

Batteries are consumable parts and the remaining battery life is currently low. Continued use may result in charge or discharge failures. Whether or not batteries can be used is determined based on safety evaluations. Please replace it with a new battery (genuine) to prevent data loss and ensure safe usage.

When the battery has expired

Batteries are consumable parts and the current battery cannot be used as the battery life has expired. Please replace it with a new battery (genuine) to prevent data loss and ensure safe usage. Whether or not batteries can be used is determined based on safety evaluations. To prevent data loss while replacing batteries, please be sure to save your work first.







Instruction messages related to battery life are displayed properly when the **Samsung Settings** app is installed on your computer. The messages may vary depending on the model and software version.

Troubleshooting

Windows recovery function

If there are performance issues with the computer, reinstall Windows using the recovery function of Windows.



-  Reinstalling Windows will erase all data saved on the computer. Back up apps and personal data to an external storage device before reinstalling Windows.
- 1 Select the Start icon () → **Settings** → **System** → **Recovery**.
- 2 Select **Reset PC**.
- 3 Select **Keep my files** or **Remove everything**.
-  After the system is recovered, select the Start icon () → **All** → **Microsoft Store** to install the required Samsung apps.

Q&A

When experiencing problems with the computer, try these solutions.

Windows

How can I uninstall an app?

- 1 Select the Start icon () → **Settings** → **Apps** → **Installed apps**.
- 2 On the list, select the More options icon () next to the app you want to delete, and then select **Uninstall**.

Samsung Device Care

What is a Recovery Area?

The computer has an additional partition for restoring data or saving backup files (only for models with the **Samsung Device Care** app). This partition is called a Recovery Area and it includes a recovery image comprised of the operating system and apps.

Why is the capacity representation of the hard disk drive (HDD) in Windows different from the product specifications?

The capacity of the storage device (HDD or SSD) of the manufacturer is calculated assuming that 1 KB = 1,000 Bytes. However, the operating system (Windows) calculates the storage device capacity assuming that 1 KB = 1,024 Bytes, and therefore the capacity representation of the HDD in Windows is smaller than the actual capacity. The capacity representation in Windows may be smaller than the actual capacity because some apps occupy a certain area of the HDD outside of Windows.

For models with the **Samsung Device Care** app, the HDD capacity representation in Windows may be smaller than the actual capacity because the **Samsung Device Care** app uses a hidden area of 5–20 GB of the HDD to save the recovery image, and that hidden area is not counted towards the total size available to Windows. The size of the **Samsung Device Care** app varies by model.

What is a recovery image?

This refers to the operating system, drivers, and software that are converted to a data image. It is required to recover the computer and is embedded in the computer's HDD. However, this is not provided for storage devices where the capacity is less than 64 GB.

How can I restore a computer that does not have the Samsung Device Care app?

Restore the computer with the recovery function provided by Windows. Refer to the Recover Functionality item in the help for more details.

Miscellaneous

The camera and the microphone are not working. How do I turn them on again?

When recording protect mode is activated, the camera and microphone will not work.

Select the Start icon () → **All** → **Samsung Settings** → **Security and privacy** and select the **Block camera and mic** switch to set it **Off**.

The computer does not turn on automatically when the display panel is opened.

To turn on the computer, the display panel should be opened greater than a certain angle.

The angle may differ depending on the model.



If the computer LED does not turn on automatically, press the Power button.

Usage notices

Precautions for using the device

- This user manual is specially designed to detail the computer's functions and features.
- The user manual supplied with the computer may vary depending on the model.
- Please read this manual when using the computer to ensure safe and proper use.
- Optional accessories, some devices, and software referred to in this manual may not be provided or may not be subject to upgrades. Note that the computer environment referred to in the user manual may not be the same as your environment.
- Descriptions are based on the computer's default settings and the Windows 11 operating system. Available features and additional services may vary depending on the computer or operating system.
- This user manual describes procedures for using the touchpad, mouse and touch screen. Instructions for using the touch screen are for models with the touch screen feature.
- Images and screenshots are those of the representative model of the series and may differ in appearance from the actual product.
- Content may differ from the final product and is subject to change without prior notice. For the latest version of the manual, refer to the Samsung website, www.samsung.com.

Instructional icons and expressions

-  **Warning:** situations that could cause injury to yourself or others
-  **Caution:** situations that could cause damage to the computer or other equipment
-  **Note:** notes, usage tips, or additional information

Copyright

Copyright © 2025 Samsung Electronics Co., Ltd.

This manual is protected under international copyright laws.

No part of this manual may be reproduced, distributed, translated, or transmitted in any form or by any means, electronic or mechanical, including photocopying, recording, or storing in any information storage and retrieval system.

Computer specifications or the contents of this manual may be changed without prior notice if the computer's functions are upgraded.

Trademarks

- Samsung and the Samsung logo are trademarks or registered trademarks of Samsung Electronics Co., Ltd.
- Intel and Core are trademarks or registered trademarks of the Intel Corporation.
- Microsoft, MS-DOS, and Windows are trademarks or registered trademarks of the Microsoft Corporation.
- Bluetooth® is a registered trademark of Bluetooth SIG, Inc. worldwide.



- Wi-Fi®, Wi-Fi Direct™, Wi-Fi CERTIFIED™, and the Wi-Fi logo are registered trademarks of the Wi-Fi Alliance.
- HDMI, the HDMI logo, and the term High Definition Multimedia Interface are trademarks or registered trademarks of HDMI Licensing LLC.



- Thunderbolt and the Thunderbolt logo are trademarks of Intel Corporation in the U.S. and/or other countries.
- Manufactured under license from Dolby Laboratories. Dolby, Dolby Atmos, and the double-D symbol are trademarks of Dolby Laboratories.
- All other trademarks and copyrights are the property of their respective owners.

Energy Star (USA only)



As an ENERGY STAR® Partner, Samsung has determined that this Product meets the ENERGY STAR Guidelines for energy efficiency. The ENERGY STAR Program has reduced greenhouse gas emissions and saved energy through voluntary labeling. Samsung is a proud ENERGY STAR Partner and commits to meet the guidelines for this product to be ENERGY STAR certified. By selecting an ENERGY STAR certified product, you reduce greenhouse emissions, save energy, and can lower operating cost. For more information, see <http://www.energystar.gov/>.

- The Power Management setting of this product has been enabled by default and has various timing settings (of up to 300 minutes for energy saving. In case you don't want the power management setting enabled, select "Never").
- To change this in Settings, go to the System menu > Power & sleep menu > Screen/ Sleep timeout option.

This product can be awakened from sleep mode by pressing the Power button.

Data precautions

Samsung shall not be liable for any data loss. Please take care to avoid losing any important data and back up your data to prevent any such data loss.

Operating system and software support

If you change the product's factory OS (Operating System) to another OS or if you install software which is not supported by the product's original factory OS, you will not receive any technical support, product exchange or refund, and a fee will be charged when requesting a service.

Please use your computer with the original factory OS. If you install an OS other than the factory OS, data may be deleted or the computer may not start.

 Please use Windows 11 for this model.

Product capacity representation

Storage capacity representation

The capacity of the storage device (HDD, SSD) of the manufacturer is calculated assuming that 1 KB = 1,000 Bytes.

However, the operating system (Windows) calculates the storage device capacity assuming that 1 KB = 1,024 Bytes. Therefore, the available capacity of the HDD in Windows is smaller than the actual capacity because of the difference in capacity calculation. For example, for an 80 GB HDD, Windows calculates the capacity as 74.5 GB, $(80 \times 1,000 \times 1,000 \times 1,000) \text{ Bytes} / (1,024 \times 1,024 \times 1,024) \text{ Bytes} = 74.505 \text{ GB}$.

In addition, the capacity representation in Windows may be even smaller because some programs, such as Samsung Device Care, may reside in a hidden area of the HDD.

Memory capacity representation

The available memory capacity in Windows is less than the actual capacity of memory. This is because some memory is required for regular system operations.

For example, for 1 GB (= 1,024 MB) memory installed, Windows may report the capacity as 1,022 MB or less.

Ergonomic tips

Maintaining proper posture during computer use is very important to prevent physical injury. Improper or prolonged keyboard use may result in repetitive strain injury. Viewing the monitor screen for extended periods of time may result in eye strain. Therefore, please follow these guidelines carefully when setting up and using the computer.

Back and neck

- Use an adjustable chair with firm, comfortable support.
- Adjust the height of your chair so that thighs are horizontal to the floor and feet are flat on the floor.
- The back of the chair should support the lower back. Adjust the backrest to fit your body properly.
- Sit back fully in your chair and straighten the back and neck. Avoid leaning forward or craning your neck toward the computer screen.
- Avoid using the computer while lying down or on your lap. If the computer's temperature increases, there is a danger of burn injury.



- The instructions in this manual have been prepared so that they can be applied to the range of needs of general users. If the user is not included in the range, the recommendations should be applied according to the user's needs.
- Images may differ from actual products.

Arms and hands

- When using the keyboard and touchpad, the shoulders should be relaxed. The upper arm and forearm should form an angle that is slightly greater than a right angle, with the wrist and hand in almost a straight line.
- Use a light touch when typing or using the touchpad and keep the hands and fingers relaxed. Avoid rolling the thumbs under your palms or supporting the wrists on the desk while typing.
- Use an external keyboard and mouse when using the computer for long periods. When using an external keyboard and mouse, position the devices at the same height as the computer and within comfortable reach.

Eye position and display illumination

- Position the screen at least 50 cm away from your eyes.
- Adjust the height of the screen so that its top edge is equal to or just below the level of your eyes.
- Avoid setting the screen's brightness settings excessively high.
- Keep the screen clean.
- If wearing glasses, clean them before using the computer.
- When referring to printed content while typing, use a static paper holder to hold the paper at about the same height as the monitor.

Hearing and volume control

- Ensure that the volume is not too loud before using a headset or earphones. Excessive exposure to loud sounds can cause hearing damage.
- Always turn the volume down before plugging the earphones into an audio source and use only the minimum volume setting necessary to hear your conversation or music.
- Avoid using earphones for long periods of time.
- Default audio settings can be changed by software and driver updates without your knowledge. Always recheck equalizer and volume settings before listening to audio.
- To prevent possible hearing damage, do not listen at high volume levels for long periods.



Operating conditions

- Take at least a 10 minute break every hour.
- Avoid using the computer in dark locations. Use the computer with as much ambient light as you would when reading a book.
- Indirect illumination is recommended. Use a curtain to prevent reflections and glare on the screen.
- While operating a computer and talking on a phone, use a headset. Using the computer while holding a phone on your shoulder or with your neck may lead to muscle strain or injury.
- Keep frequently used items within reach.
- Only use the computer within the temperature and humidity ranges specified in this manual.

Use caution when exposed to flashing lights.

- While using your computer, leave some lights on in the room and do not hold the screen too close to your eyes.
- Seizures or blackouts can occur when you are exposed to flashing lights while watching videos or playing Flash-based games for extended periods. If you feel any discomfort, stop using the computer immediately.
- If anyone related to you has experienced seizures or blackouts while using a similar product, consult a physician before using the computer.
- If you feel discomfort, such as a muscle spasm, or disoriented, stop using the computer immediately and consult a physician.
- To prevent eye strain, take frequent breaks while using the computer.

Reduce the risk of repetitive motion injuries.

When you repetitively perform actions, such as pressing keys, drawing characters on a touch screen with your fingers, or playing games, you may experience occasional discomfort in your hands, neck, shoulders, or other parts of your body. When using your computer for extended periods, hold the computer with a relaxed grip, press the keys lightly, and take frequent breaks. If you continue to have discomfort during or after such use, stop using the computer and consult a physician.

Safety precautions

For your safety and security and to prevent damage, carefully read the following safety instructions. This 'Safety precautions' relate to computer use. Some of the content may not be applicable to your computer.

-  • Since this is commonly applied to Samsung computers, some pictures may differ from actual products.
- The product mentioned in this guide refers to all items supplied with the computer including the battery, the adapter, and all other Samsung-provided accessories.

Warning

Failure to follow the instructions marked with this symbol may result in physical injury or fatality.

Power related

Handle the power cord with care.

- Do not touch with wet hands.
- Do not use a damaged power cord.
- Do not overload a multi-outlet or an extension cord beyond the specified voltage/current capacity.
- Correctly insert the plug into the outlet.
- Do not unplug the power cord by pulling on the cable.
- Unplug the wall-mount adapter (integrated plug and power adapter) from the wall outlet while holding the body and pulling it in the direction of the arrow.

Failure to do so may result in electric shock or fire.

Connect the power cord to the adapter firmly.

An improper connection may result in a fire.

Use the approved adapter or cable included in the product box.

If you use the unapproved adapter or cable, it cause the damage or malfunction of the computer.

Use only properly earthed electric sockets or extension cords.

Unearthed electric sockets or extension cords may cause electric shock. Any connection to unearthed electric sockets or extension cords may produce an electric field from a current leak.

If water or other substances enter the product, disconnect the power cord and contact a Samsung Service Center. For notebook computers that are supplied with an optional removable battery, disconnect the battery.

Failure to do so may result in electric shock or fire caused by a computer malfunction.

Do not let dust accumulate on the power cord or the electric socket. Regularly wipe the power cord and the electric socket with a dry cloth.

Failure to do so may result in electric shock or fire.

Do not bend or damage the power cord or the adapter with a heavy or sharp-edged object.

A damaged cable or cord may result in electric shock or fire.

Keep the battery, adapter, and power cord away from infants, children, and pets.

Failure to do so may result in electric shock or damage.

Battery usage related

Use manufacturer-approved batteries, adapters, accessories, and supplies.

- Using generic batteries or adapters may shorten the life of your product or cause the computer to malfunction. They may also cause a fire or cause the battery to explode.
- Use only Samsung-approved battery and adapter specifically designed for your device. Incompatible battery and adapter can cause serious injuries or damage to your device.
- Samsung cannot be responsible for the user's safety when using accessories or supplies that are not approved by Samsung.

Take care to not allow metal objects such as a key or clip to touch the battery terminals (metal parts).

This may cause excessive current and result in fire, burns, or damage to the battery.

If the computer or the computer battery leaks, emits strange odors, or swells, immediately stop using the computer and contact a Samsung Service Center.

Failure to do so may result in an explosion or fire.

Replace a run-down battery with a new, Samsung-approved battery.

Dispose of worn-out batteries properly.

- There is a danger of fire or explosion.
- The battery disposal method may differ depending on your country and region. Dispose of the used battery in an appropriate way.

When removing the real time clock (RTC) battery, keep it away from infants and children.

If a child swallows the battery, the child may suffocate. If this happens, immediately contact a doctor.

Do not throw or disassemble the battery and do not put it into water.

There is a danger of injury, fire or explosion.

Charge the battery according to the instructions in the manual.

Failure to do so may cause an explosion or fire.

Usage related

Do not use the computer on heated floors or electric pads, or on beds, blankets, or cushions that block the ventilation of the computer.

A blocked vent causes the computer to overheat, resulting in an explosion, fire, burns, or computer malfunction.

Do not use the computer in hot or humid locations, such as a bathroom, sauna, or inside a car during summer.

Failure to do so may result in computer malfunction or electric shock.

The computer can be used in locations with an ambient temperature of 10 °C to 35 °C and a relative humidity of 20 % to 80 %RH.

To avoid suffocation, keep the plastic bag away from infants and children.

Putting a plastic bag over the head may result in suffocation.

Never heat the computer (or the battery) or put the computer (or the battery) into a fire or microwave.

Failure to do so may result in an explosion or fire.

Before cleaning the computer, disconnect all the cables that are connected to the computer. For notebook computers that are supplied with an optional removable battery, disconnect the battery.

Failure to do so may result in electric shock or fire.

Keep the computer away from water or liquid.

Water or liquid entering the computer may short-circuit the computer, resulting in electric shock or fire.

If the computer is dropped or broken, disconnect the power cord and contact a Samsung Service Center. For notebook computers that are supplied with an optional removable battery, disconnect the battery.

Using a broken computer may result in electric shock or fire.

Do not touch the computer's surface or the vents for extended periods while the computer is on.

Contact with the vent or the surface for extended periods may result in low-temperature burns, such as redness on the skin.

Do not carry your device in your back pockets.

- The device may be damaged, explode, or result in a fire if too much pressure is applied to it.
- You may be injured if you are bumped or fall.

Caution

Failure to follow instructions marked with this symbol may result in minor physical injury or damage to the computer.

Installation related

Do not block the ports (holes), vents, etc., of the product and do not insert objects.

Damage to a component within the computer may cause electric shock or fire.

When using the computer on its side, ensure the vents are clear and facing upwards.

Failure to do so, may cause the internal temperature of the computer to rise and the computer to malfunction or halt.

Keep the computer's vents at least 15 cm away from walls and other objects.

Failure to do so may result in physical injury.

Do not place or use the computer on slanted or vibrating surfaces.

Failure to do so may result in computer malfunction or damage.

Do not place heavy objects on the product.

This may cause a problem with the computer. In addition, the object may fall and cause injury or damage the computer.

Properly shut down, disconnect and secure the computer cables before moving it.

Failure to do so may damage the computer or cause someone to trip over a loose cable.

Usage related

Do not use the pen for unintended purposes, such as poking the body, like eyes or ears, and do not put it in your mouth.

Doing so may result in physical injury.

Do not place a candle, lit cigar, etc., over or on the product.

There is a danger of fire.

Make sure to have the product tested by a safety service engineer after repairing the product.

Using a repaired product without testing it for safety may cause an electric shock or fire.

In case of lightning, immediately turn the system off, then disconnect the power cord from the wall outlet and phone line from modem.

There is a danger of electric shock or fire.

Connect only permitted devices to the connectors or ports of the computer.

Failure to do so may result in an electric shock or fire.

Close the display panel only after checking if the notebook computer is turned off.

The temperature may rise and it may cause deformation of the product.

Do not drop or hit the computer against anything.

Failure to do so may result in physical injury or computer malfunction.

When handling computer parts, follow the instructions on the manual supplied with the parts.

Failure to do so may result in damage to the product.

If the product emits smoke or there is a burning smell, disconnect the adapter from the wall outlet and contact a Samsung Service Center immediately. For notebook computers that are supplied with an optional removable battery, disconnect the battery.

There is a danger of fire.

Do not store your device near or in heaters, microwaves, hot cooking equipment, or high pressure containers.

- The battery may leak.
- Your device may overheat and cause a fire.

Do not insert your fingers into the ports (holes), card slot, or vents.

There is a danger of injury or electric shock.

Use recommended computer cleansing solutions when cleaning the product and only use the computer when it is completely dry.

Failure to do so may result in electric shock or fire.

Do not use the product if it is cracked or broken.

Broken glass or acrylic could cause injury to your hands and face. Take the device to a Samsung Service Center to have it repaired.

When using wireless communication (LAN, Bluetooth, etc.) always follow applicable instructions. For example, airlines and hospitals have strict requirements.

Avoid exposing a drive to magnetic fields. Security devices with magnetic fields include airport walk-through devices and security wands. The airport security devices that check carry-on luggage use X-rays instead of magnetism and will not damage a drive.

Keep the computer away from magnetic material.

- Magnetic materials may cause computer malfunction or cause the battery to discharge.
- To avoid damaging the computer or magnetic stripe cards, such as credit cards, keep magnetic stripe cards away from the computer.

Do not use your computer in a hospital or on an aircraft that can be interfered with by radio frequency.

- Avoid using your computer within a 15 cm range of a pacemaker, if possible, as your computer can interfere with the pacemaker.
- To minimize possible interference with a pacemaker, use your computer only on the side of your body that is opposite the pacemaker.
- If you use medical equipment, contact the equipment manufacturer before using your computer to determine whether or not the equipment will be affected by radio frequencies emitted by the computer.
- When in a hospital, turn off your computer and follow all hospital regulations. Radio frequencies emitted from the computer may affect medical equipment.

Upgrade Related

Do not attempt to upgrade the computer, unless you are qualified. Otherwise, contact a Samsung Service Center or an authorized technician.

When you upgrade permitted devices, according to the manual, follow the specified instructions in the manual to upgrade them. Do not disassemble any other parts by yourself.

Failure to do so may result in computer malfunction, electric shock, or fire.

Take care when touching the product or parts.

The computer may be damaged or you may be injured.

Do not disassemble the power supply unit in any circumstances.

Failure to do so may result in electric shock, fire, or an explosion.

Shut down the computer and disconnect all cables before disassembling the computer. For notebook computers that are supplied with an optional removable battery, disconnect the battery.

Failure to do so may cause electric shock.

Make sure to close the computer cover before connecting the power after a reassembly.

There is a danger of electric shock if your body touches an internal part.

Never disassemble or repair the product by yourself.

There is danger of an accident. Use an authorized Samsung Service Center.

To connect a device that is not manufactured or authorized by Samsung, enquire at a Samsung Service Center before connecting the device.

There is a danger of damaging the product.

Storage and movement related

Do not store the computer in an enclosed space, such as a computer bag, while it is running.

Failure to do so may result in fire. Completely shut down the computer before putting the computer into an enclosed space.

When carrying the notebook computer with other items, such as the adapter, mouse, books etc., take care not to press anything against the notebook computer.

If a heavy object is pressed against the notebook computer, a white spot or stain may appear on the display.

Do not operate or look at the computer while driving a vehicle.

There is a danger of a traffic accident. Please concentrate on driving.

For long periods of inactivity or storage, discharge the battery and separate it from the computer (for external or removable battery types).

Cautions on preventing data loss (storage device (such as HDD, SSD, eMMC) management)

Take care not to damage the data on a storage device (such as HDD, SSD, eMMC).

- Subjecting the device to physical impacts may result in data loss.
- Data may be lost when the computer is turned off or reset by a power failure while the storage device (such as HDD, SSD, eMMC) is operating.
- Data may be lost and irrecoverable because of a computer virus.
- Data may be lost if the power is turned off while running an app.
- Samsung is not liable for any loss of data on a storage device (such as HDD, SSD, eMMC).

To prevent data loss caused by damage to a storage device (such as HDD, SSD, eMMC), please back up the data frequently.

Make sure to store the Microsoft account and password you used during Windows activation.

If you forget your Microsoft account or password, you might not be able to access or use your data.

Display bad pixels

Samsung observes strict specifications regarding the quality and reliability of the display. However, there is a small chance that a few pixels may be bad. A large number of bad pixels can cause problems with the display, but a small number of bad pixels does not generally affect computer performance.

Samsung's quality standards for bad pixels are as follows:

- **Bright dot:** 2 or fewer
- **Black dot:** 4 or fewer
- **Combination (bright and dark):** 4 or fewer

Clean the display screen with a soft cloth dampened with computer cleansing detergent.

Do not use excessive force. Doing so may damage the display screen.

(NP UM Rev 5.0)

Appendix

Product specifications

The system specifications may differ depending on the derived model. For detailed system specifications, refer to the product catalog.

<Product specifications>

Item	Specification
Operating environment	<ul style="list-style-type: none">• Temperature: -5–40 °C for storage, 10–35 °C when operating• Humidity: 5–90 % for storage, 20–80 % when operating
AC/DC rating	<ul style="list-style-type: none">• Input: 100–240 VAC, 50–60 Hz• Output: (PDO) 5 V, 3 A / 9 V, 3 A / 15 V, 3 A / 20 V, 3.25 A (PPS) 5-20 V, 3.25 A
PC rating	20 VDC, 3.25 A (65 W)

-  • Optional components may not be provided or different components may be provided depending on the model.
- The system specifications are subject to change without notice.
- The Storage device capacity of a computer in which **Samsung Device Care** is installed is smaller than the product specification.
- For some models, it is not possible to add storage or add or replace memory because of the computer's design. To replace the storage, contact the Samsung Service Center. You will be charged for this service.
- The amount of memory that Windows can use may be smaller than the actual amount of memory available.

Important safety information

Safety instructions

The system is designed and tested to meet the latest standards for safety of information technology equipment. However, to ensure safe use of this product, it is important that the safety instructions marked on the product and in the documentation are followed.

- ⚠ Always follow these instructions to help guard against personal injury and damage to the system.

Setting up the system

- Read and follow all instructions marked on the product and in the documentation before operating the system. Retain all safety and operating instructions for future use.
- Do not use this product near water or a heat source such as a radiator.
- Set up the system on a stable work surface.
- The product should be operated only with the type of power source indicated on the rating label.
- Ensure that the electrical outlet to power the equipment is easily accessible in case of fire or short circuit.
- If the computer has a voltage selector switch, make sure that the switch is in the proper position for your area.
- Openings in the computer case are provided for ventilation. Do not block or cover these openings. Make sure you provide adequate space, at least 6 inches (15 cm), around the system for ventilation when setting up your work area. Never insert objects of any kind into the computer ventilation openings.
- Ensure that the fan vents at the bottom of the casing are clear at all times. Do not place the computer on a soft surface, doing so will block the bottom vents.
- When using an extension cord with this system, make sure that the total power rating on the products plugged into the extension cord does not exceed the extension cord power rating.
- For computers with glossy display bezels the user should consider the placement of the computer as the bezel may cause reflections from surrounding light and bright surfaces.

Care during use

- Do not walk on the power cord or allow anything to rest on it.
- Do not spill anything on the computer or its components. The best way to avoid spills is to not eat or drink near the computer or its components.
- Some products have a replaceable CMOS battery on the system board. There is a danger of explosion if the CMOS battery is replaced incorrectly. Replace the battery with the same or equivalent type recommended by the manufacturer.

Dispose of batteries according to the manufacturers instructions. If the CMOS battery requires replacement ensure that a qualified technician performs the task.

- When the computer is turned off, a small amount of electrical current still flows through the computer.

To avoid electrical shock, always unplug all cables, remove the battery and modem cables from the wall outlets before cleaning the system.

- Unplug the system from the wall outlet and contact a Samsung Service Center if:
 - The power cord or plug is damaged.
 - Liquid has been spilled into the computer.
 - The computer does not operate properly when the operating instructions are followed.
 - The computer was dropped or the casing is damaged.
 - The computer performance changes.



Operating instructions

- 1 When installing and operating devices please refer to safety requirements in the user manual.
- 2 Devices can be used only with the equipment specified in the technical specifications of the devices.
- 3 If any smell of burning or smoke is detected from the computer the unit should be switched off and the battery removed. The unit should be checked by a qualified technician before reuse.

- 4 Service and repair of devices should be carried out by authorized service centers.
- 5 Do not allow the portable computer to operate with the base resting directly on exposed skin for extended periods of time. The surface temperature of the base will rise during normal operation (particularly when AC Power is present). Allowing sustained contact with exposed skin can cause discomfort or eventually a burn.

Replacement parts and accessories

Use only replacement parts and accessories recommended by manufacturer.

-  To reduce the risk of fire, use only No. 26 AWG or larger telecommunications line cord.
-  Do not use this product in areas classified as hazardous. Such areas include patient care areas of medical and dental facilities, oxygen rich environments, or industrial areas.

Battery disposal

-  Do not put rechargeable batteries or products powered by non-removable rechargeable batteries in the garbage.

Contact the Samsung Service Center for information on how to dispose of batteries that you cannot use or recharge any longer. Follow all local regulations when disposing of old batteries.

-  THERE IS RISK OF EXPLOSION IF BATTERY IS REPLACED BY AN INCORRECT TYPE. DISPOSE OF USED BATTERIES ACCORDING TO THE INSTRUCTIONS.

Laser safety

All systems equipped with CD or DVD drives comply with the appropriate safety standards, including IEC 60825-1. The laser devices in these components are classified as “Class 1 Laser Products” under a US Department of Health and Human Services (DHHS) Radiation Performance Standard. Should the unit ever need servicing, contact an authorized service location.

- ❗ • **Laser Safety Note:** Use of controls or adjustments or performance of procedures other than those specified in this manual may result in hazardous radiation exposure. To prevent exposure to laser beams, do not try to open the enclosure of a CD or DVD drive.
- Class 1M laser radiation when operating part is open. Do not view directly with optical instruments.
- Class 3B invisible laser radiation when open.
Avoid exposure to the beam.

Connecting and disconnecting the adapter

The socket-outlet shall be installed near the equipment and shall be easily accessible. **Do not unplug the power cord by pulling the cable only.**

Power cord requirements

The power cord set (all plugs, cable and adapter plugs) you received with your computer meets the requirements for use in the country where you purchased your equipment. Power cord sets for use in other countries must meet the requirements of the country where you use the computer. For more information on power cord set requirements, contact your authorized dealer, reseller, or service provider.

India only

The power cord set must have a minimum current capacity and a nominal voltage rating, as required by country's power system.

General requirements

The requirements listed below are applicable to all countries:

- All power cord sets must be approved by an acceptable accredited agency responsible for evaluation in the country where the power cord set will be used.
- The power cord set must have a minimum current capacity of 7 A and a nominal voltage rating of 125 or 250 volts AC, as required by each country's power system (USA only).
- The appliance coupler must meet the mechanical configuration of an EN 60 320/ IEC 320 Standard Sheet C7 (or C5) connector, for mating with appliance inlet on the computer.

Regulatory compliance statements

Wireless guidance

(If fitted with 2.4 G band, 5 G band or 6 G band)

Low power, Radio LAN type devices (radio frequency (RF) wireless communication devices), operating in the 2.4 GHz/5 GHz/6 GHz Band, may be present (embedded) in the notebook system. The following section is a general overview of considerations while operating a wireless device.

Additional limitations, cautions, and concerns for specific countries are listed in the specific country sections (or country group sections). The wireless devices in the system are only qualified for use in the countries identified by the Radio Approval Marks on the system rating label. If the country you will be using the wireless device in, is not listed, please contact your local Radio Approval agency for requirements. Wireless devices are closely regulated and use may not be allowed.

The RF field strength of the wireless device or devices that may be embedded in the notebook are well below all international RF exposure limits as known at this time. Because the wireless devices (which may be embedded into the notebook) emit less energy than is allowed in radio frequency safety standards and recommendations, manufacturer believes these devices are safe for use. Regardless of the power levels, care should be taken to minimize human contact during normal operation.

Some circumstances require restrictions on wireless devices.

Examples of common restrictions are listed on the next page:

- ❗ • Radio frequency wireless communication can interfere with equipment on commercial aircraft. Current aviation regulations require wireless devices to be turned off while traveling in an airplane.
802.11 (also known as wireless Ethernet or Wi-Fi) and Bluetooth communication devices are examples of devices that provide wireless communication.
- In environments where the risk of interference to other devices or services is harmful or perceived as harmful, the option to use a wireless device may be restricted or eliminated. Airports, hospitals, and oxygen or flammable gas laden atmospheres are limited examples where use of wireless devices may be restricted or eliminated. When in environments where you are uncertain of the sanction to use wireless devices, ask the applicable authority for authorization prior to use or turning on the wireless device.
- Every country has different restrictions on the use of wireless devices. Since your system is equipped with a wireless device, when traveling between countries with your system, check with the local Radio Approval authorities prior to any move or trip for any restrictions on the use of a wireless device in the destination country.
- If the system came equipped with an internal embedded wireless device, do not operate the wireless device unless all covers and shields are in place and the system is fully assembled.
- Wireless devices are not user serviceable. Do not modify them in any way. Modification to a wireless device will void the authorization to use it. Please contact the manufacturer for service.
- Only use drivers approved for country in which the device will be used. See the manufacturer System Restoration Kit, or contact the manufacturer's technical support for additional information.

Explosive Device Proximity Warning

Do not operate a portable transmitter (such as a wireless network device) near unshielded blasting caps or in an explosive environment unless the device has been modified to be qualified for such use.

United States of America and Canada

USA and Canada Safety Requirements and Notices

Do not touch or move antenna while the unit is transmitting or receiving.

Do not hold any component containing the radio such that the antenna is very close to touching any exposed parts of the body, especially the face or eyes, while transmitting.

Do not operate the radio or attempt to transmit data unless the antenna is connected; if not, the radio may be damaged.

Use in specific environments:

The use of wireless devices in hazardous locations is limited by the constraints posed by the safety directors of such environments.

The use of wireless devices on airplanes is governed by the Federal Aviation Administration (FAA) in the USA and Transport Canada Civil Aviation (TCCA) in Canada.

The use of wireless devices in hospitals is restricted to the limits set forth by each hospital.

Explosive Device Proximity Warning

Do not operate a portable transmitter (such as a wireless network device) near unshielded blasting caps or in an explosive environment unless the device has been modified to be qualified for such use.

Use On Aircraft Caution

FCC, FAA, and TCCA regulations prohibit airborne operation of radio-frequency wireless devices because their signals could interfere with critical aircraft instruments.

Other wireless devices

Safety notices for other devices in the wireless network:

Refer to the documentation supplied with wireless Ethernet adapters or other devices in the wireless network.

-  The Part 15 radio device operates on a non-interference basis with other devices operating at this frequency. Any changes or modification to said product not expressly approved by Intel could void the user's authority to operate this device.

FCC Part 15 Information and Notices

Responsible Party – U.S. Contact Information

Samsung Electronics America, Inc.

85 Challenger Road.

Ridgefield Park, NJ 07660

Phone: 1-800-SAMSUNG (726-7864)

This device complies with Part 15 of the FCC Rules. Operation is subject to the following two conditions: (1) this device may not cause harmful interference, and (2) this device must accept any interference received, including interference that may cause undesired operation.

 This equipment has been tested and found to comply with the limits for a Class B digital device pursuant to Part 15 of the FCC Rules. These limits are designed to provide reasonable protection against harmful interference in a residential installation. This equipment generates, uses, and can radiate radio frequency energy. If not installed and used in accordance with the instructions, it may cause harmful interference. If this equipment does cause harmful interference to radio or television reception, which can be determined by turning the equipment off and on, the user is encouraged to try to correct the interference by one or more of the following measures:

- Reorient or relocate the receiving antenna.
- Increase the separation between the equipment and receiver.
- Connect the equipment into an outlet on a circuit different from that to which the receiver is connected.
- Consult the dealer or an experienced radio/TV technician for help.

If necessary, the user should consult the dealer or an experienced radio/television technician for additional suggestions. The user may find the following booklet helpful: "Something About Interference."

This is available at FCC local regional offices. Our company is not responsible for any radio or television interference caused by unauthorized modifications of this equipment or the substitution or attachment of connecting cables and equipment other than those specified by our company. The correction will be the responsibility of the user. Use only shielded data cables with this system.

Health and safety information

Exposure to Radio Frequency (RF) Signals Certification Information

This product can contain an embedded radio transmitter and receiver. It is designed and manufactured not to exceed the exposure limits for radio frequency (RF) energy set by the Federal Communications Commission (FCC) of the U.S. government. These FCC exposure limits are derived from the recommendations of two expert organizations, the National Council on Radiation Protection and Measurement (NCRP) and the Institute of Electrical and Electronics Engineers (IEEE). In both cases, the recommendations were developed by scientific and engineering experts drawn from industry, government, and academia after extensive reviews of the scientific literature related to the biological effects of RF energy.

Before a new model is available for sale to the public, it must be certified to the FCC that it does not exceed the exposure limit established by the FCC. Evaluation per each model is performed in positions and locations (such as at the bottom on the body) as required by the FCC.

For body worn operation, this model meets the FCC RF exposure guidelines when used with Samsung accessory designated for this product. Non-compliance with the above restrictions may result in violation of FCC RF exposure guidelines.

RF exposure or SAR information can be viewed on-line at www.fcc.gov/oet/ea/fccid/. This site uses this product FCC ID number on the outside of the product. Sometimes it may be necessary to remove the battery pack to find number. Once you have the FCC ID number for a particular product, follow the instructions on the website and it should provide RF exposure information or values for typical or maximum SAR for particular product.

For corresponding model only

The Specific Absorption Rate (SAR) is a measure of the rate of absorption of RF energy by the human body expressed in units of watts per kilogram (W/kg). The FCC wireless devices to comply with a safety limit of 1.6 watts per kilogram (1.6 W/kg).

SAR level of this device while operating can be well below the maximum value. This is because the device is designed to operate at multiple power levels so as to use only the power required to reach the network. In general, the closer you are to a wireless base station antenna, the lower the power output.

Manufacturer information

Samsung Electronics Co., Ltd.

129, Samsung-Ro, Yeongtong-Gu, Suwon-City, Gyeonggi-Do, 443-742, Korea

Samsung Electronics Vietnam Co., Ltd.

Khu Công nghiệp Yên Phong 1, Yên Trung, Yên Phong, Bắc Ninh, Viet Nam

Tel: +84-222-369-6875

For the web or the phone number of the Samsung Service Center, see the Warranty or contact the retailer where you purchased your product.

RTC caution

CAUTION: Danger of explosion if battery is incorrectly replaced. Replace only with the same or equivalent type recommended by the manufacturer. Discard used batteries according to the Manufacturer's instruction.

Canada

Innovation, Science and Economic Development Statement:

This device contains licence-exempt transmitter(s)/receiver(s) that comply with Innovation, Science and Economic Development Canada's licence-exempt RSS(s). Operation is subject to the following two conditions:

- 1 This device may not cause interference.
- 2 This device must accept any interference, including interference that may cause undesired operation of the device.

Industry Canada Caution

The device for operation in the band 5150-5250 MHz is only for indoor use to reduce the potential for harmful interference to co-channel mobile satellite systems.

Innovation, Sciences et Développement économique Canada

L'émetteur/récepteur exempt de licence contenu dans le présent appareil est conforme aux CNR d'Innovation, Sciences et Développement économique Canada applicables aux appareils radio exempts de licence. L'exploitation est autorisée aux deux conditions suivantes :

- 1 L'appareil ne doit pas produire de brouillage.
- 2 L'appareil doit accepter tout brouillage radioélectrique subi, même si le brouillage est susceptible d'en compromettre le fonctionnement.

Avertissement:

Les dispositifs fonctionnant dans la bande 5 150-5 250 MHz sont réservés uniquement pour une utilisation à l'intérieur afin de réduire les risques de brouillage préjudiciable aux systèmes de satellites mobiles utilisant les mêmes canaux.

WEEE symbol information



**Correct disposal of this product (Waste Electrical & Electronic Equipment)
(Applicable in countries with separate collection systems)**

This marking on the product, accessories or literature indicates that the product and its electronic accessories (for example, charger, headset, USB cable) should not be disposed of with other household waste at the end of their working life.

To prevent possible harm to the environment or human health from uncontrolled waste disposal, please separate these items from other types of waste and recycle them responsibly to promote the sustainable reuse of material resources.

Household users should contact either the retailer where they purchased this product, or their local government office, for details of where and how they can take these items for environmentally safe recycling.

Business users should contact their supplier and check the terms and conditions of the purchase contract. This product and its electronic accessories should not be mixed with other commercial wastes for disposal.

For information on Samsung's environmental commitments and product regulatory obligations, such as REACH, visit our sustainability page available at www.samsung.com.

India only

For more information on safe disposal and recycling visit our website www.samsung.com/in or contact our Helpline numbers - 18002668282, 180030008282.

This product is RoHS compliant.



Correct disposal of batteries in this product

(Applicable in countries with separate collection systems)

This marking on the battery, manual or packaging indicates that the batteries in this product should not be disposed of with other household waste at the end of their working life. Where marked, the chemical symbols Hg, Cd or Pb indicate that the battery contains mercury, cadmium or lead above the reference levels in EC Directive 2006/66. If batteries are not properly disposed of, these substances can cause harm to human health or the environment.

To protect natural resources and to promote material re-use, please separate batteries from other types of waste and recycle them through your local, free battery return system.

PO BOX 12987, DUBLIN. IE

Removing the battery (Europe only)

- To remove the battery, contact an authorised service centre. To obtain battery removal instructions, please visit www.samsung.com/global/ecodesign_energy.
- For your safety, you **must not attempt to remove** the battery. If the battery is not properly removed, it may lead to damage to the battery and device, cause personal injury, and result in the device being unsafe.
- Samsung does not accept liability for any damage or loss (whether in contract or tort, including negligence) which may arise from failure to precisely follow these warnings and instructions, other than death or personal injury caused by Samsung's negligence.

USA only

This Perchlorate warning applies only to primary CR (Manganese Dioxide) Lithium coin cells in the product sold or distributed ONLY in California USA.

“Perchlorate Material- special handling may apply, see www.dtsc.ca.gov/hazardouswaste/perchlorate.”

WARNING! Never dispose of batteries in a fire because they may explode. Do not disassemble, crush, puncture, heat, burn or reuse batteries. For more information, visit call2recycle.org or call 1-800-822-8837. Alternatively, visit: www.samsung.com/recycling or call 1-800-SAMSUNG.

Samsung package Take-Back program (USA only)

In partnering with select recyclers, Samsung offers packaging take-back at no cost to you.

Simply call the following number for the locations nearest you.

CRT Processing, LLC

(877) 278-0799

Kathy Severson – Logistics contact

For more recycling information, go to our website: www.samsung.com/recycling or call 1-800-SAMSUNG.

Some content may differ from the computer depending on the region, service provider, software version, or computer model, and is subject to change without prior notice.

SAMSUNG