

SONY®



Table of contents

Operation Search

MENU/Settings Search

Index

Cyber-shot

Cyber-shot Handbook

DSC-H20

How to use this handbook

Click on a button at upper right to jump to the corresponding page.
This is convenient when searching for a function you want to view.



← Search for information by function.

← Search for information by operation.

← Search for information in a listing of MENU/Settings items.

← Search for information by keyword.

Table of contents

Operation Search

MENU/Settings Search

Index

Marks and notations used in this handbook

Red Eye Reduction

The flash strobes two or more times before shooting to reduce the red-eye phenomenon when using the flash.

1 MENU → (Red Eye Reduction) → desired mode

<input checked="" type="checkbox"/>	(Auto)	When the Face Detection function is activated, the flash strobes automatically to reduce the red-eye phenomenon.
<input type="checkbox"/>	(On)	The flash always strobes to reduce the red-eye phenomenon.
<input type="checkbox"/>	(Off)	Does not use Red Eye Reduction.

Notes

- [Red Eye Reduction] cannot be selected during Easy Shooting, Movie Mode, or Smile Shutter.
- To avoid blurring of images, hold the camera firmly until the shutter is released. It usually takes a second after you press the shutter button. Be also sure not to allow the subject to move during this period.
- Red Eye Reduction may not produce the desired effects. It depends on individual differences and conditions, such as distance to the subject, or if the subject looked away from the pre-strobe.
- If you do not use the Face Detection function, Red Eye Reduction does not work, even when you select [Auto].

What causes the red-eye phenomenon?

Pupils become dilated in dark environments. Flash light is reflected off the blood vessels at the back of the eye (retina), causing the "red-eye" phenomenon.

In this handbook, the sequence of operations is shown by arrows (→). Operate the camera in the order indicated. Marks are shown as they appear in the camera's default setting.

The default setting is indicated by .

Indicates cautions and limitations relevant to the correct operation of the camera.

Indicates information that is useful to know.

Notes on using the camera

Notes on the types of “Memory Stick” media that you can use (sold separately)



“Memory Stick Duo” media: You can use a “Memory Stick Duo” media with the camera.



“Memory Stick” media: You cannot use a “Memory Stick” media with the camera.

Other memory cards cannot be used.

- For details on “Memory Stick Duo” media, see page 142.

When using a “Memory Stick Duo” media with “Memory Stick” media compatible equipment

You can use the “Memory Stick Duo” media by inserting it into the “Memory Stick Duo” media Adaptor (sold separately).



“Memory Stick Duo” media Adaptor

Notes on the battery pack

- Charge the battery pack (supplied) before using the camera for the first time.
- You can charge the battery pack even if it is not completely discharged. In addition, even if the battery pack is not fully charged, you can use the partially charged capacity of the battery pack as is.
- If you do not intend to use the battery pack for a long time, use up the existing charge and remove it from the camera, then store it in a cool, dry place. This is to maintain the battery pack functions.
- For details on the usable battery pack, see page 144.

Carl Zeiss lens

The camera is equipped with a Carl Zeiss lens which is capable of reproducing sharp images with excellent contrast.

The lens for the camera has been produced under a quality assurance system certified by Carl Zeiss in accordance with the quality standards of Carl Zeiss in Germany.

Notes on the LCD screen and lens

- The LCD screen is manufactured using extremely high-precision technology so over 99.99% of the pixels are operational for effective use. However, some tiny black and/or bright dots (white, red, blue or green) may appear on the LCD screen. These dots are a normal result of the manufacturing process and do not affect the recording.

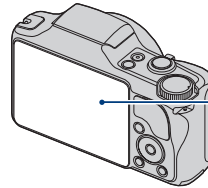

Black, white, red, blue or green dots

- Exposing the LCD screen or the lens to direct sunlight for long periods may cause malfunctions. Be careful when placing the camera near a window or outdoors.
- Do not press against the LCD screen. The screen may be discolored and that may cause a malfunction.
- Images may trail across on the LCD screen in a cold location. This is not a malfunction.
- Be careful not to bump the movable lens, and be careful not to apply force to it.

The images used in this Handbook

The images used as examples in this Handbook are reproduced images, and are not actual images shot using this camera.

Table of contents

Notes on using the camera

How to use this handbook	2
Notes on using the camera	3
Operation Search	7
MENU/Settings Search	10
Identifying parts	15
Using the mode dial	16
Changing the DISP (screen display) setting	17
Using the internal memory	19

Shooting

Intelligent Auto Adjustment	20
Scene Selection	21
Easy Shooting	23
Program Auto	25
Manual Exposure Shooting	26
Movie Mode	27
Smile Shutter	28
Zoom	29
Self-Timer	30
Macro	31
Flash	32

Viewing

Viewing still images	33
Playback zoom	34
Image Index	35
Delete	36
Viewing movies	37

MENU (Shooting)

MENU items (Shooting)	10
-----------------------------	----

MENU (Viewing)

MENU items (Viewing)	12
----------------------------	----

Settings

Setting items	13
---------------------	----

TV

Viewing images on a TV	105
------------------------------	-----

Computer

Enjoying your Windows computer	108
Installing the software (supplied)	110
On “PMB (Picture Motion Browser)” (supplied)	111
Enjoying images on your computer	112
Using the “Music Transfer” (supplied)	116
Using your Macintosh computer	117
Viewing “Cyber-shot Step-up Guide”	120

Printing

Printing still images	121
Printing images directly using a PictBridge compliant printer	122
Printing at a shop	124

Troubleshooting

Troubleshooting	125
Warning indicators and messages	135

Others

Using the camera abroad — Power sources	141
On the “Memory Stick Duo” media	142
On the battery pack	144
On the battery charger	145

Index

Index	146
-------------	-----

Operation Search

Table of
contents

Operation
Search

MENU/Settings
Search

Index

Leaving the settings to the camera	Intelligent Auto Adjustment.....	20
	Scene Selection.....	21
	Scene Recognition.....	51
Shooting portraits	Soft Snap.....	21
	Twilight Portrait.....	21
	Smile Shutter.....	28
	Scene Recognition.....	51
	Face Detection.....	54
	Anti Blink.....	57
	Red Eye Reduction.....	58
Shooting in manual mode	Manual Exposure Shooting.....	26
Shooting food arrangements	Gourmet.....	21
Shooting close to objects	Macro.....	31
Shooting moving objects	Advanced Sports Shooting.....	21
	Movie Mode.....	27
	Burst.....	42
Shooting without blur	High Sensitivity.....	21
	2-second delay self-timer.....	30
	ISO.....	45
	SteadyShot.....	63
Shooting with backlight	Forced Flash.....	32
	Scene Recognition.....	51

Shooting in dark places	High Sensitivity.....	21
	Slow Synchro (Flash On)	32
	ISO.....	45
Adjusting exposure	Histogram	18
	EV	44
Changing focus position	Focus	48
	Face Detection	54
Changing image size	Image Size.....	39
Deleting images	Delete.....	36, 75
	Format	97
Displaying enlarged images	Playback zoom.....	34
	Trimming	72
Editing images	Retouch	72
	Multi-Purpose Resize	74
Playing back a series of images in order	Slideshow	64
Shooting/Viewing with easy-to-see indicators	Easy Shooting	23
Printing images with the date	Using the “PMB (Picture Motion Browser)”	111
Changing date and time settings	Area Setting	103
	Date & Time Setting.....	104
Initializing settings	Initialize.....	89
Printing images	Print	121

Viewing on TVs	Viewing images on a TV.....	105
Information about optional accessories	“Cyber-shot Step-up Guide”	120

Table of contents

Operation Search

MENU/Settings Search

Index

MENU/Settings Search

MENU items (Shooting)

You can select the various shooting functions easily from the MENU button.

- 1 Press the MENU button to display the Menu screen.
- 2 Select the desired menu item with ▲/▼/◀/▶ on the control button.
- 3 Press the MENU button to turn off the Menu screen.

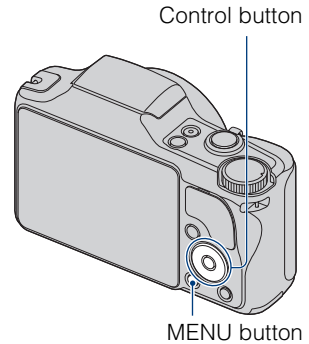

In the table below, ✓ indicates a function is available and — that it is unavailable. The icons below [SCN] and [] indicate the available modes.

Menu items	Mode dial	i	EASY	SCN	M	P	[]
Scene Selection	—	—	—	✓	—	—	—
Movie shooting mode	—	—	—	—	—	—	✓
Image Size	✓	✓	✓	✓	✓	✓	✓
Flash	—	✓	—	—	—	—	—
REC Mode	✓	—	—	[]	✓	✓	—
EV	✓	—	—	✓	—	✓	✓
ISO	—	—	—	[]	✓	✓	—
White Balance	—	—	—	[]	✓	✓	✓
Focus	—	—	—	—	✓	✓	✓
Metering Mode	—	—	—	—	✓	✓	✓
Scene Recognition	✓	—	—	—	—	—	—
Smile Detection Sensitivity	✓	—	—	[]	✓	✓	—
Face Detection	✓	—	—	[]	✓	✓	—
Flash Level	—	—	—	—	✓	✓	—
Anti Blink	—	—	—	[]	—	—	—
Red Eye Reduction	✓	—	—	[]	✓	✓	—
DRO	—	—	—	—	✓	✓	—
Color Mode	—	—	—	—	✓	✓	✓
Contrast	—	—	—	—	✓	✓	—
Sharpness	—	—	—	—	✓	✓	—
SteadyShot	—	—	—	[]	✓	✓	✓
[] (Settings)	✓	—	—	✓	✓	✓	✓

Note

- Only the items that are available for each mode are displayed on the screen.

Table of contents







Operation Search

MENU/Settings Search

Index







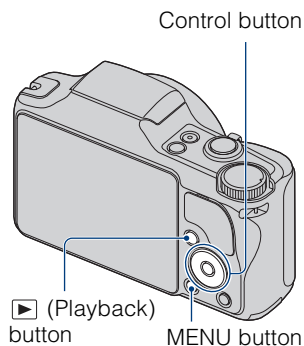











MENU items (Viewing)

You can select the various viewing functions easily from the MENU button.

- 1 Press the  (Playback) button to switch to playback mode.
- 2 Press the MENU button to display the Menu screen.
- 3 Select the desired menu item with /// on the control button.
- 4 Press  on the center of the control button.



In the table below, ✓ indicates a function is available and — that it is unavailable.









View Mode Menu items	"Memory Stick Duo" media				Internal Memory
	 Date View	 Event View	 Favorites	 Folder View	 Folder View
 (Slideshow)	✓	✓	✓	✓	✓
 (Date List)	✓	—	—	—	—
 (Event List)	—	✓	—	—	—
 (View Mode)	✓	✓	✓	✓	—
 (Filter by Faces)	✓	✓	✓	—	—
 (Add / Remove Favorites)	✓	✓	✓	—	—
 (Retouch)	✓	✓	✓	✓	✓
 (Multi-Purpose Resize)	✓	✓	✓	✓	✓
 (Delete)	✓	✓	—	✓	✓
 (Protect)	✓	✓	✓	✓	✓
DPOF	✓	✓	✓	✓	—
 (Print)	✓	✓	✓	✓	✓
 (Rotate)	✓	✓	✓	✓	✓
 (Select Folder)	—	—	—	✓	—
 (Settings)	✓	✓	✓	✓	✓

Notes





- Only the items that are available for each mode are displayed on the screen.
- When the mode dial is set to **EASY** (Easy Shooting), if you press MENU, the Delete screen appears. You can select between [Delete Single Image] or [Delete All Images].

Setting items

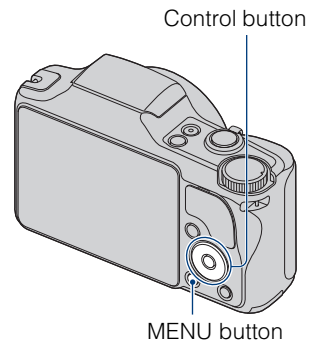
You can change the settings on the  (Settings) screen.

- 1 Press the MENU button to display the Menu screen.
- 2 Select  (Settings) with  on the control button, then press  on the center of the control button to display the setup screen.
- 3 Select the desired category with /, then press  to select each item, then .
- 4 Select the desired setting, then press .



Categories	Items
 Shooting Settings	AF Illuminator
	Grid Line
	Digital Zoom
	Conversion Lens
	Auto Orientation
	Auto Review
 Main Settings	Beep
	Language Setting
	Function Guide
	Initialize
	Demo Mode
	COMPONENT
	Video Out
	Wide Zoom Display
	USB Connect
	Download Music
	Format Music
 “Memory Stick” Tool	Format
	Create REC.Folder
	Change REC.Folder
	Delete REC.Folder
	Copy
	File Number
 Internal Memory Tool	Format
	File Number
 Clock Settings	Area Setting
	Date & Time Setting

Notes

- [Shooting Settings] appears only when settings have been entered from shooting mode.
- [“Memory Stick” Tool] appears only when a “Memory Stick Duo” media is inserted in the camera, while [Internal Memory Tool] appears only when a “Memory Stick Duo” media is not inserted.

Identifying parts

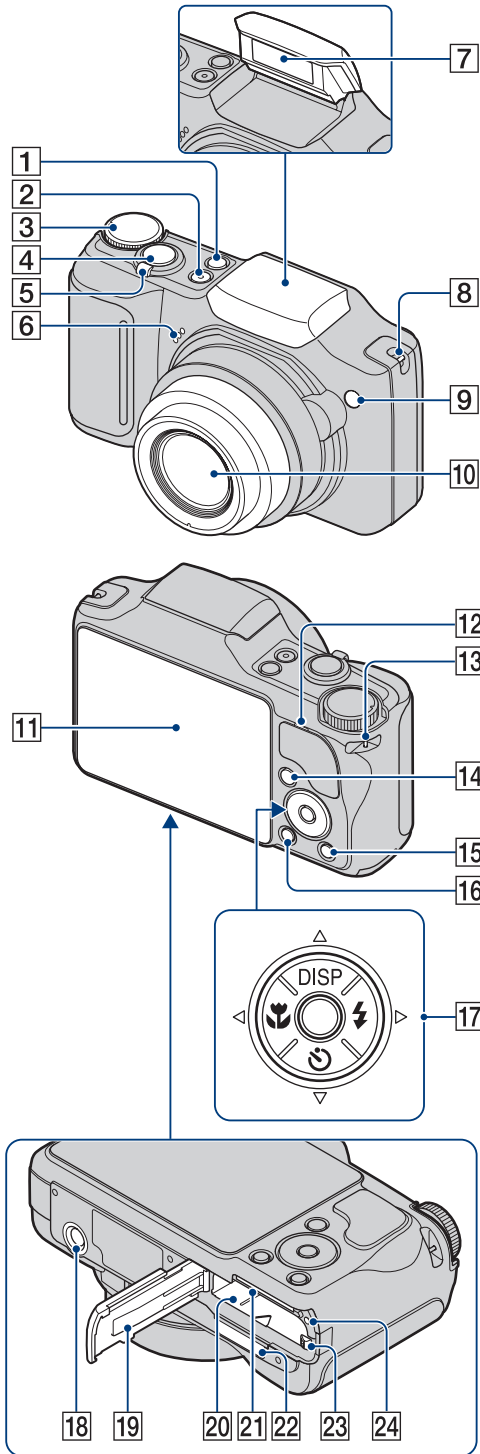



- 1 ☺ (Smile) button (28)
- 2 ON/OFF (Power) button
- 3 Mode dial (16)
- 4 Shutter button
- 5 For shooting: W/T (zoom) lever (29)
For viewing: Q (Playback zoom) lever/☒ (Index) lever (34, 35)
- 6 Microphone
- 7 Flash
- 8 Hook for lens cap strap
- 9 Self-timer lamp/Smile Shutter lamp/AF illuminator
- 10 Lens
- 11 LCD screen
- 12 Speaker
- 13 Hook for wrist strap
- 14 ▶ (Playback) button (33)
- 15 ☒ (Delete) button (36)
- 16 MENU button (10)
- 17 Control button
Menu on: ▲/▼/◀/▶/●
Menu off: DISP/☺/☒/⚡
- 18 Tripod receptacle
- 19 Battery/"Memory Stick Duo" media cover
- 20 Battery insertion slot
- 21 "Memory Stick Duo" media slot
- 22 Multi connector
- 23 Battery eject lever
- 24 Access lamp

- Table of contents
- Operation Search
- MENU/Settings Search
- Index

Using the mode dial

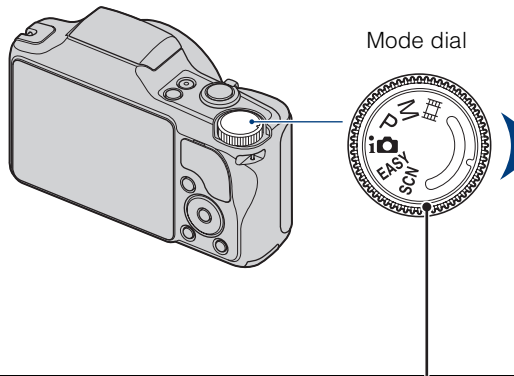





Set the mode dial to the desired function.

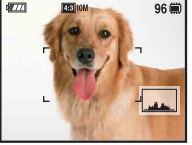

 (Movie Mode)	Allows you to record movies with audio (page 27).
M (Manual Exposure Shooting)	Allows you to adjust the exposure manually (both the shutter speed and the aperture value) (page 26). You can set various functions using the menu.
P (Program Auto)	Allows you to shoot with the exposure adjusted automatically (both the shutter speed and the aperture value) (page 25). You can set various functions using the menu.
 (Intelligent Auto Adjustment)	Allows you to shoot with the settings adjusted automatically (page 20).
EASY (Easy Shooting)	Allows you to shoot/view still images with easy-to-see indicators (page 23).
SCN (Scene Selection)	Allows you to shoot with preset settings according to the scene (page 21).

Changing the DISP (screen display) setting

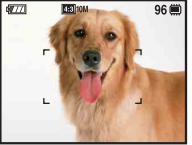
- 1 Press DISP (screen display) on the control button.
- 2 Select the desired mode with the control button.

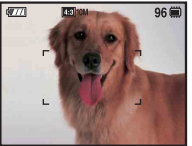
	 (Bright + Image Only)	Sets screen brighter and displays only images.	
	 (Bright + Histogram)	Sets screen brighter and displays a graph of the image brightness. Image information is also displayed during playback.	
	 (Bright)	Sets screen brighter and displays the information.	
<input checked="" type="checkbox"/>	 (Normal)	Sets screen to standard brightness and displays the information.	

Note

- If you view images in bright outside light, adjust the screen brightness up. However, the battery power may decrease faster under such condition.

Histogram

A histogram is a graph showing the brightness of an image. The graph display indicates a bright image when skewed to the right side, and a dark image when skewed to the left side.

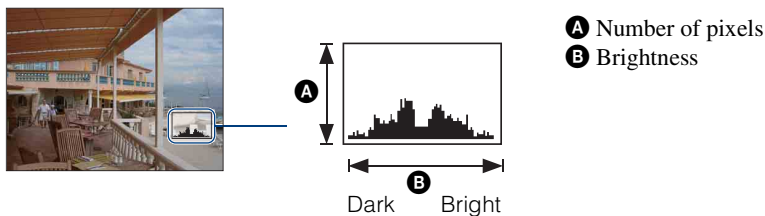

1 Press DISP (screen display) on the control button, then select [Bright + Histogram].

Notes

- The histogram also appears when playing back a single image, but you cannot adjust the exposure.
- The histogram does not appear while recording movies, playing back movies, viewing vertical orientation images or rotated still images.
- A large difference in the histogram displayed during shooting and playback may occur when:
 - The flash strobos.
 - The shutter speed is slow or fast.
- The histogram may not appear for images recorded using other cameras.

Using the internal memory

The camera has approximately 11 MB of internal memory. This memory is not removable. Even when there is no “Memory Stick Duo” media inserted in the camera, you can record images using this internal memory.

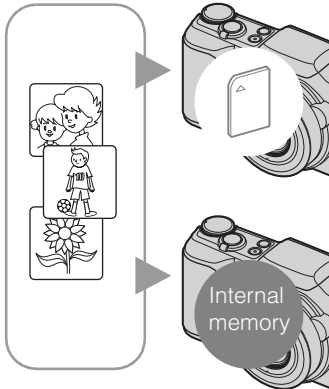

When a “Memory Stick Duo” media is inserted

[Recording]: Images are recorded on the “Memory Stick Duo” media.

[Playback]: Images on the “Memory Stick Duo” media are played back.

[Menu, Settings, etc.]: Various functions can be performed on images on the “Memory Stick Duo” media.

When there is no “Memory Stick Duo” media inserted

[Recording]: Images are recorded using the internal memory.

[Playback]: Images stored in the internal memory are played back.

[Menu, Settings, etc.]: Various functions can be performed on images in the internal memory.

On image data stored in the internal memory

We recommend that you copy (back up) data without error using one of the following methods.

To copy (back up) data on a hard disk of your computer

Perform the procedure on pages 112 to 113 without a “Memory Stick Duo” media inserted in the camera.

To copy (back up) data on a “Memory Stick Duo” media

Prepare a “Memory Stick Duo” media with sufficient free capacity, then perform the procedure explained in [Copy] (page 101).

Notes

- You cannot transfer image data on a “Memory Stick Duo” media to the internal memory.
- By making a USB connection between the camera and a computer with a cable for multi-use terminal, you can transfer data stored in the internal memory to a computer. However you cannot transfer data on a computer to the internal memory.

Intelligent Auto Adjustment

Allows you to shoot still images with the setting adjusted automatically.

- 1 Set the mode dial to **i**  (Intelligent Auto Adjustment).
- 2 Shoot with the shutter button.

Note









- Flash mode is set to [Flash Auto] or [Flash Off].

On Scene Recognition

Scene Recognition operates in Intelligent Auto Adjustment mode. This function lets the camera automatically recognize the shooting conditions and shoot the image.



Scene Recognition icon

The camera recognizes  (Twilight),  (Twilight Portrait),  (Twilight using a tripod),  (Backlight),  (Backlight Portrait),  (Landscape),  (Macro) or  (Portrait), and displays an icon on the LCD screen when the scene is recognized.

For details, see page 51.

If you shoot a still image of a subject that is difficult to focus on

- The shortest shooting distance is approximately 2 cm (13/16 inches) (W), 90 cm (2 feet 11 1/2 inches) (T) (from the lens).
- When the camera cannot focus on the subject automatically, the AE/AF lock indicator changes to flash slowly and the beep does not sound. Either recompose the shot or change the focus setting (page 48).









Focusing may be difficult in the following situations:

- It is dark and the subject is distant.
- The contrast between the subject and the background is poor.
- The subject is seen through glass.
- The subject is moving quickly.
- There is reflective light or shiny surfaces.
- The subject is backlit or there is a flashing light.



Scene Selection

Allows you to shoot with preset settings according to the scene.

- 1 Set the mode dial to **SCN** (Scene Selection).
- 2 Select the desired mode → ● on the control button.
If you want to switch to another scene, press the MENU button.

 (High Sensitivity)	Allows you to shoot images without a flash under low light conditions, reducing blur.	
 (Soft Snap)	Allows you to shoot images with a softer atmosphere for portraits and flowers, etc.	
 (Advanced Sports Shooting)	Allows you to shoot fast movements such as in sports. While the shutter button is pressed halfway, subject motion is predicted and focus is adjusted.	
 (Landscape)	Allows easy shooting of distant scenes by focusing in the distance. Shoots vivid blue sky and flora colors.	
 (Twilight Portrait)	Allows you to shoot sharp images of people with the night view in the background without compromising the atmosphere.	
 (Twilight)	Allows you to shoot night scenes at far distance without losing the dark atmosphere of the surroundings.	
 (Gourmet)	Shifts to Macro mode, allowing you to shoot food arrangements in delicious and bright color.	
 (Beach)	Allows you to record the blue of the water clearly when shooting seaside or lakeside scenes.	
 (Snow)	Allows you to record clear images preventing sunken colors in snowy scenes or other places where the whole screen appears white.	
 (Fireworks)	Allows you to record fireworks in all their splendor.	























Note

- When you shoot images using  (Twilight Portrait),  (Twilight) or  (Fireworks) mode, the shutter speed is slower and the images tend to blur. To prevent blurring, the use of a tripod is recommended.

Functions you can use in Scene Selection

For shooting an image appropriately according to the scene condition, a combination of functions is determined by the camera. ✓ indicates a function is available, and — that it is unavailable. The icons below [Flash] indicate the available flash modes.

Some functions are not available, depending on the Scene Selection mode.

	Macro On	Flash	Face Detection/ Smile Shutter	Burst/ Bracket	White Balance	Red Eye Reduction	Anti Blink	Steady-Shot
 ISO	✓		✓	—	✓* ¹	—	—	✓
	✓	✓	✓* ²	✓	—	✓	✓	✓
	—		—	✓	—	—	—	✓
	—	 	—	✓	—	✓	—	✓
	✓	 SL	✓	—	—	✓	—	✓
	—		—	—	—	—	—	✓
	✓	 	—	—	✓	—	—	—
	✓	 	✓	✓	—	✓	—	✓
	✓	 	✓	✓	—	✓	—	✓
	—		—	—	—	—	—	✓

*¹ [Flash] for [White Balance] cannot be selected.

*² [Off] for [Face Detection] cannot be selected.

Easy Shooting

Allows you shoot still images using the minimum necessary functions. The settings you can change are [Image Size], [Self-Timer] and [Flash]. The text size increases and indicators become easier to see.

1 Set the mode dial to **EASY** (Easy Shooting).

2 Shoot with the shutter button.

Note

- The battery charge is used up more quickly because the screen brightness increases automatically.

Changing Image Size, Flash and Self-Timer settings

Image Size: MENU → [Image Size] → ● on the control button → desired mode → ●

Select between [Large] or [Small] size.

Self-Timer:  on the control button → desired mode

Select between [Self-Timer 10sec] or [Self-Timer Off] mode.

Flash:  on the control button → desired mode

Select between [Flash Auto] or [Flash Off] mode.

MENU → [Flash] → ● on the control button → desired mode → ●







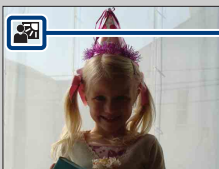

Select between [Auto] or [Off] mode.

On Scene Recognition

Scene Recognition operates in Easy Shooting mode. This function lets the camera automatically recognize the shooting conditions and shoot the image.





Scene Recognition icon

The camera recognizes  (Twilight),  (Twilight Portrait),  (Twilight using a tripod),  (Backlight),  (Backlight Portrait),  (Landscape),  (Macro) or  (Portrait), and displays an icon on the LCD screen when the scene is recognized.

For details, see page 51.

On Easy Viewing mode

When you press the  (Playback) button with the mode dial set to **EASY** (Easy Shooting), the playback screen text becomes larger and easier to see. And the functions that can be used are limited to the minimum.

 **(Delete) button** You can delete the currently displayed image.
Select [OK] → ●.

MENU button You can delete the currently displayed image with [Delete Single Image], delete all images in a folder with [Delete All Images].

- View Mode is set to [Folder View]. If you set the mode dial to a mode other than **EASY** (Easy Shooting), then playback images, the images are displayed in the preselected View Mode.

Program Auto

Allows you to shoot with the exposure adjusted automatically (both the shutter speed and the aperture value). Also you can select various settings using the menu.

- 1 Set the mode dial to P (Program Auto).
- 2 Shoot with the shutter button.

Manual Exposure Shooting

You can shoot at your favorite exposure by manually setting the shutter speed and aperture value.

- 1 Set the mode dial to M (Manual Exposure Shooting).
- 2 Press ● on the control button.
- 3 Select the shutter speed and aperture value using control button.

Control button	Feature
▲▼	Aperture value
◀▶	Shutter speed
●	Return

- Select a shutter speed from 1/2000 to 30 second.
- When the zoom is fully set to W side, you can select an aperture F3.5 or F8.0.
When the zoom is fully set to T side, you can select an aperture F4.4 or F10.

- 4 Press the shutter button to shoot the image.

Notes

- If proper exposure is not obtained by your settings, the setting value indicators on the screen will flash when the shutter button is pressed halfway down. You can shoot in this condition, but exposure readjustment is recommended.
- The flash is set to [Flash On] or [Flash Off].

💡 Setting the shutter speed and aperture value

The difference between the settings and proper exposure judged by the camera appears as an EV value on screen.



Shutter speed/aperture value

Exposure value

0EV is the value judged as the most suitable by the camera.

- When the shutter speed is one second or slower, the shutter speed is indicated by ["], for example, [1"].
- When you set the shutter speed slower, using a tripod is recommended to prevent the effects of vibration.
- When the shutter speed becomes slower than a certain speed, the NR slow shutter function is activated automatically to reduce image noise, and [NR] appears on the screen.
- If you select slow shutter speeds, it takes time to process the data.

Movie Mode

Allows you to record movies with audio.

- 1 Set the mode dial to  (Movie Mode).
- 2 Press the shutter button fully down.
- 3 To stop recording, press the shutter button fully down again.

Smile Shutter

When the camera detects a smile, the shutter is released automatically.

1 Press 😊 (Smile) button.

2 Wait detecting a smile.

When the smile level exceeds the ◀ point on the indicator, the camera records images automatically.

If you press the shutter button during Smile Shutter, the camera shoots the image, then returns to Smile Shutter mode.

3 To stop shooting, press 😊 (Smile) button again.

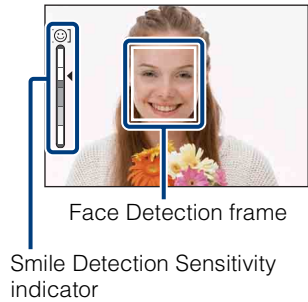

Notes

- Shooting using the Smile Shutter ends automatically when either the “Memory Stick Duo” media or internal memory becomes full.
- Smiles may not be detected correctly depending on the conditions.
- You cannot use the digital zoom function.
- When 🏆 (Advanced Sports Shooting), 🏞️ (Landscape), 🌙 (Twilight), 🍷 (Gourmet) or 🎆 (Fireworks) mode is selected in Scene Selection, you cannot use the Smile Shutter function.

💡 Hints for better capturing of smiles

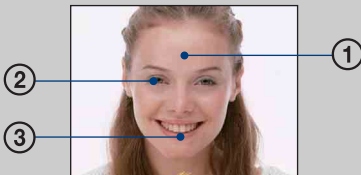

- ① Do not cover the eyes with the bangs.
Do not obscure the face by hat, masks, sunglasses, etc.
- ② Try to orient the face in front of the camera and be as level as possible. Keep the eyes narrowed.
- ③ Give a clear smile with an open mouth. The smile is easier to detect when the teeth are showing.

- The shutter operates when any person whose face is being detected smiles.
- You can select or register the priority subject for face detection with [Face Detection]. When the selected-face is registered in the camera memory, Smile Detection is performed only for that face. To perform smile detection for a different face, change the priority face with ● on the control button (page 54).
- If a smile is not detected, set the [Smile Detection Sensitivity] in setting menu.

Zoom

You can enlarge the image when shooting. The camera's optical zoom function can enlarge images up to 10×.

1 Move the W/T (Zoom) lever.

When the lever is moved towards T, the camera zooms in.

When the lever is moved towards W, the camera zooms out.

Moving the lever slightly zooms slowly and moving the lever fully zooms fast.

- When the zoom scale exceeds 10×, see page 82.

T side



W side







Notes

- The operating sound of the lens or beep sound of buttons might be recorded while shooting a movie.
- Even if you turn the lever fully, the camera zooms slowly while shooting a movie.

Self-Timer

- 1 Press  (Self-Timer) on the control button.
- 2 Select the desired mode with the control button.

✓	 (Self-Timer Off)	Does not use the self-timer.
	 (Self-Timer 10sec)	Sets the 10-second delay self-timer. When you press the shutter button, the self-timer lamp flashes and a beep sounds until the shutter operates. To cancel, press  again.
	 (Self-Timer 2sec)	Sets the 2-second delay self-timer.

Notes

- In Easy Shooting mode, you can select only [On] (10 sec) or [Off].
- In  Advanced Sports Shooting mode, the Self-Timer cannot be used.







Reducing blurring with the two-second self-timer

- Use the 2-second delay self-timer to prevent blur of an image. The shutter is released 2 seconds after you press the shutter button, which reduces camera shake when the shutter button is pressed.

Macro

Use this setting to capture beautiful close-up images of small subjects such as insects or flowers.

- 1 Press  (Macro) on the control button.
- 2 Select the desired mode with the control button.





	 AUTO (Auto)	Adjusts the focus automatically from distant subjects to close-up. <ul style="list-style-type: none">• Normally, put the camera in this mode.
	 (Macro On)	Adjusts the focus with priority on close-up subjects. Set Macro On when shooting close subjects. <ul style="list-style-type: none">• Setting the zoom all the way to the W side is recommended.

Notes

- The Auto Focus speed becomes slower when you shoot images in the Macro mode.
- Macro mode is fixed to [Auto] when the camera is in Intelligent Auto Adjustment mode or in Movie Mode.

Flash

- 1 Press  (Flash) on the control button.
- 2 Select the desired mode with the control button.

✓	 AUTO (Flash Auto)	Flashes when there is insufficient light or backlight.
	 (Flash On)	Flash always operates.
	 SL (Slow Synchro (Flash On))	Flash always operates. The shutter speed is slow in a dark place to clearly shoot the background that is out of flash light.
	 (Flash Off)	Flash does not operate.

Notes



- The flash strobos twice. The first flash adjusts the light quantity.
- While charging the flash,  is displayed.
- You cannot use the flash during burst or bracket shooting.
- [Flash On] and [Slow Synchro (Flash On)] are not available when the camera is in Intelligent Auto Adjustment mode.
- In Easy Shooting mode, you can select only [Flash Auto] or [Flash Off].
- In Manual Exposure Shooting mode, you can select only [Flash On] or [Flash Off].

When the “White circular spots” appears in flash photos

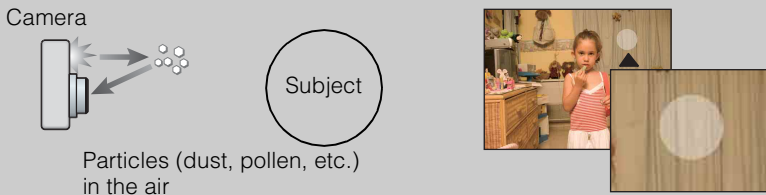
This is caused by particles (dust, pollen, etc.) floating close to the lens. When they are accentuated by the camera’s flash, they appear as white circular spots.



How can the “White circular spots” be reduced?

- Light the room and shoot the subject without a flash.
- Select  (High Sensitivity) mode in Scene Selection. ([Flash Off] is automatically selected.)
- Even though you selected  (High Sensitivity) mode in Scene Selection, the shutter speed might be slower under low-light conditions, or in a dark place. In that case, use a tripod or hold your arms firmly at your side after pressing the shutter button.

Viewing still images

- 1 Press the  (Playback) button to switch to playback mode.
- 2 Select an image with the control button.

Notes

- You may not be able to play back some images shot using other cameras. Play such images in Folder View (MENU → [View Mode] → [Folder View]).
- When the mode dial is set to **EASY** (Easy Shooting), the images are played back in Folder View, and the available function are limited. If you want to use all viewing functions, set the mode dial to a mode other than **EASY**.



Viewing images taken with a different camera

The screen to choose a viewing method is displayed if you plug into this camera a “Memory Stick Duo” media containing both images taken with this camera and images taken with another camera.

“Playback only registered images”/“Playback all images with folder view”

If you select “Playback only registered images”, images are played in the selected View Mode. Some images taken with other cameras may not be played at this time.

If you select “Playback all images with folder view”, the camera switches to Folder View and plays all images.

Playback zoom

Plays back the enlarged image.

- 1 Move the lever towards **Q** (Playback zoom) while viewing still image playback.

The image is enlarged to twice the previous size, at the center of the image.

- 2 Adjust the position with the control button.
- 3 Adjust the magnification using the **W/T** (Zoom) lever.

Move the lever towards **Q** (**T**) to zoom in further, or towards **W** to zoom out.

Press **●** on the control button to cancel playback zoom.



Shows the displayed area of the whole image



To save enlarged images

You can save an enlarged image by using the trimming function.

Press **MENU** → [Retouch] → [Trimming].

Image Index

Displays multiple images at the same time.



- 1 Press the  (Playback) button to switch to playback mode.
- 2 Move the  (Index) lever to display the image index screen.
Move the lever again to display an index screen with even more images.
- 3 To return to the single-image screen, select an image with the control button, then press .

Note

- When the mode dial is set to **EASY** (Easy Shooting), you cannot view images in index mode.



 Displaying images of the desired date/event/folder



Select the left side bar with the control button, then select the desired date/event/folder with /.

Delete

Allows you to select unwanted images for deletion. You can also delete images from the MENU button (page 75).

- 1 Press the  (Playback) button to switch to playback mode.
- 2  (Delete) button → desired mode → ● on the control button

This Image	Deletes the currently displayed image in single-image mode.
Multiple Images	Allows you to select and delete multiple images. Do as the following after step 2. ① Select an image then press ●. Repeat the above steps until there are no more images to be deleted. Select an image with a ✓ mark again to release the ✓ mark. ② MENU → [OK] → ●
All in This Folder All in Date Range All in Event	Deletes all images in the selected folder, date range or event group at once. Press [OK] → ● after step 2.
Exit	Cancels the deletion.

Notes

- When the mode dial is set to **EASY** (Easy Shooting), you can delete only the currently displayed image.
- When [View Mode] is set to [Favorites], you cannot delete images.

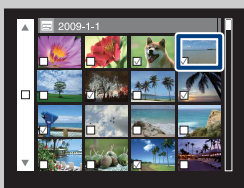

 You can switch between index and single-image mode when selecting images









Move the W/T (zoom) lever towards **Q** (T) in index mode to return to single-image mode, and move the lever towards **W** (W) in single-image mode to return to index mode.

- You can also switch between index and single-image mode in [Add / Remove Favorites], [Protect] or [DPOF].

Viewing movies



- 1 Press the  (Playback) button to switch to playback mode.
 - 2 Select a movie with the control button.
 - 3 Press .
- Movie playback starts.

Control button	Playback feature
	Pause
	Fast forward
	Fast rewind
	Displays the volume control screen. Adjust the volume with  /  .



Note

- You may not be able to play back some images shot using other cameras.

On the movie viewing screen

Select the image you want to display using / on the control button, and press . The Playback bar appears, and the current position of the movie is displayed.





  or  appears on the movie viewing screen. The icon displayed may vary depending on image size and quality.

Playback bar

Movie shooting mode

Allows you to shoot movies with preset settings according to the scene.

- 1 Set the mode dial to  (Movie Mode).
- 2 MENU →  (Movie shooting mode) → desired mode













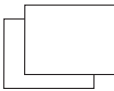

✓	 (Auto)	Adjusts the setting automatically.
	 (High Sensitivity)	Shoots movies with high sensitivity under low light conditions.

Image Size

The image size determines the size of the image file that is recorded when you take a image. The larger the image size, the more detail will be reproduced when the image is printed on large-format paper. The smaller the image size, the more images can be recorded. Select the image size that matches the way you will view your images.

1 MENU →  (Image Size) → desired size

When shooting still images

	Image size	Usage guidelines	No. of images	Printing
✓	 (3648×2736) 10M	For prints up to A3+ size	Less 	Fine 
	 (2592×1944) 5M	For prints up to A4 size	↑ ↓	↑ ↓
	 (2048×1536) 3M	For prints up to L/2L size		
	 (640×480) VGA	For e-mail attachments	More 	Rough 
	 (3648×2432) 8M	3:2 aspect ratio as in photo prints and postcards	Less	Fine
	 (3648×2056) 7M	For viewing on a high-definition TV	Less ↑ ↓	Fine ↑ ↓
	 (1920×1080) 2M		More ↓ ↑	Rough ↓ ↑

Note

- When you print images recorded with 16:9 aspect ratio, both edges may be cut off.

In Easy Shooting mode

✓	Large	Shoots images in [10M] size.
	Small	Shoots images in [3M] size.

When shooting movies

The larger the image size, the higher the image quality. The higher the amount of data used per second (average bit rate), the smoother the playback image.

The movies shot with this camera will be recorded in MPEG-4, Approx. 30fps, Progressive, AAC, mp4 format.

	Movie image size	Average bit rate	Usage guidelines
✓	[720] 1280×720(Fine) FINE	9 Mbps	Shoot highest quality movie for display on HDTV
	[720] 1280×720(Standard) STD	6 Mbps	Shoot standard quality movie for display on HDTV
	[VGA] VGA	3 Mbps	Shoot at an image size suitable for WEB upload

Notes

- A telephoto image results when the [VGA] image size is selected for movies.
- You can record movies with an image size of [1280×720] on “Memory Stick PRO Duo” media. When using recording media other than “Memory Stick PRO Duo” media, set the movie image size to [VGA].

💡 On “image quality” and “image size”

A digital image is made up of a collection of small dots called pixels.

If it contains a large number of pixels, the image becomes large, it takes up more memory, and the image is displayed in fine detail. “Image size” is shown by the number of pixels. Although you cannot see the differences on the screen of the camera, the fine detail and data processing time differ when the image is printed or displayed on a computer screen.

Description of the pixels and the image size

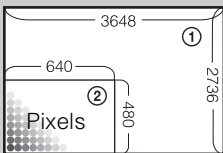

- ① Image size: 10M
3648 pixels × 2736 pixels = 9,980,928 pixels
- ② Image size: VGA
640 pixels × 480 pixels = 307,200 pixels

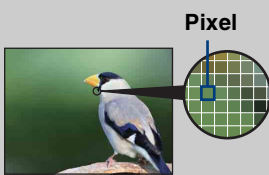

Pixel



Many pixels

(Fine image quality and large file size)



Few pixels

(Rough image quality but small file size)

Flash

In Easy Shooting mode, you can select the Flash setting also from the MENU button.



- 1 Set the mode dial to **EASY** (Easy Shooting).
- 2 MENU → [Flash] → ● on the control button
- 3 Select the desired mode → ●.

✓	Auto	Flash strobos when there is insufficient light or backlight.
	Off	Does not use the flash.

REC Mode

You can select Normal (single-image), Burst or Exposure Bracket as the shooting mode.

1 MENU →  (REC Mode) → desired mode

✓	 (Normal)	Records a single image.
	 (Burst)	<p>Records up to 100 images in succession when you press and hold down the shutter button.</p>  <p>Notes</p> <ul style="list-style-type: none"> • Burst shooting is not available during Easy Shooting, Movie Mode or Smile Shutter. • The flash is set to [Flash Off]. • When recording with the self timer, a series of a maximum of five images is recorded. • You cannot select the shutter speed of 1/3 second or slower when you perform burst shooting with the mode dial set to “M”. • The recording interval becomes longer, depending on the setting for the image size. • When the battery level is low, or when the internal memory or “Memory Stick Duo” media is full, the Burst stops. • The focus, white balance, and exposure are adjusted for the first image, and these settings are also used for the other images.

BRK±0.3EV
BRK±0.7EV
BRK±1.0EV

Records a series of three images with the exposure values automatically shifted (Exposure Bracket). When you cannot decide the correct exposure, shoot in the Exposure Bracket mode, shifting the exposure value. You can select the image with the best exposure afterward.
The larger the bracket step value, the larger the shift of the exposure value.



Notes

- Exposure Bracket mode is not available during Intelligent Auto Adjustment, Easy Shooting, Movie Mode, or Smile Shutter.
- The flash is set to [Flash Off].
- The focus and white balance are adjusted for the first image, and these settings are also used for the other images.
- You cannot select the shutter speed of 1/3 second or slower when you perform burst shooting with the mode dial set to "M".
- When you adjust the exposure manually, the exposure is shifted based on the adjusted brightness.
- The recording interval becomes longer depending on the shooting conditions.
- If the subject is too bright or too dark, you may not be able to shoot properly with the selected bracket step value.
- [VGA] image size will be set while recording on internal memory.

EV

You can adjust the exposure manually in 1/3 EV steps in a range of -2.0 EV to +2.0 EV.

1 MENU → 0EV (EV) → desired EV setting

Notes

- In Easy Shooting mode, the EV setting cannot be adjusted.
- If you shoot a subject in extremely bright or dark conditions, or when you use the flash, the exposure adjustment may not be effective.

💡 Adjusting the exposure for better looking images

You can create various images by adjusting the exposure and the ISO sensitivity. Exposure is the amount of light that the camera will receive when you release the shutter.

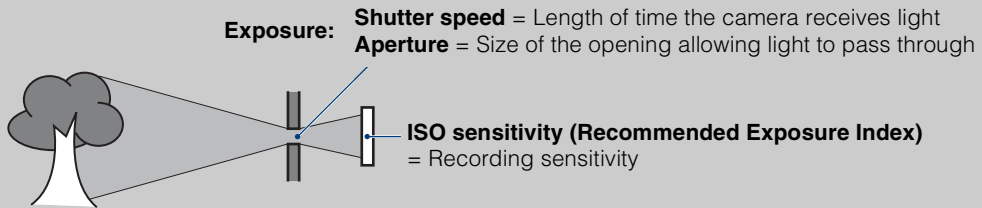

Overexposure = too much light
Whitish image

Lower EV setting -



Correct exposure

Higher EV setting +



Underexposure = too little light
Darker image

ISO

Adjusts the luminous sensitivity.

- 1 Set the mode dial to M (Manual Exposure Shooting) or P (Program Auto).
- 2 MENU → ISO_{AUTO} (ISO) → desired mode

✓	ISO AUTO (Auto)	Sets the ISO sensitivity automatically.
	ISO / ISO / ISO / ISO / 80 / 100 / 200 / 400 / ISO / ISO / ISO 800 / 1600 / 3200	You can reduce image blurring in dark locations or moving subjects by increasing ISO sensitivity (select a larger number).

Note

- ISO settings other than [ISO AUTO], [ISO 80] to [ISO 800] cannot be selected when the recording mode is set to Burst or Exposure Bracket mode, or when [DRO] is set to [DRO plus].

💡 Adjusting ISO Sensitivity (Recommended Exposure Index)

ISO sensitivity is a speed rating for recording media that incorporates an image sensor that receives light. Even when the exposure is the same, images differ depending on the ISO sensitivity.



High ISO sensitivity

Records a bright image even in dark locations while increasing shutter speed to reduce blur. However, the image tends to become noisy.







Low ISO sensitivity

Records a smoother image. However, when the exposure is insufficient, the image may become darker.

White Balance

Adjusts color tones according to the surrounding light conditions. Use this function if image color appears unnatural.

1 MENU → $\frac{WB}{AUTO}$ (White Balance) → desired mode

✓	$\frac{WB}{AUTO}$ (Auto)	Adjusts the white balance automatically so that the colors appear natural.	
	☀ (Daylight)	Adjusts for outdoors conditions on a fine day, evening views, night scenes, neon signs, fireworks, etc.	
	☁ (Cloudy)	Adjusts for a cloudy sky or a shady location.	
	☼ ₁ (Fluorescent Light 1) ☼ ₂ (Fluorescent Light 2) ☼ ₃ (Fluorescent Light 3)	[Fluorescent Light 1]: Adjusts for white fluorescent lighting. [Fluorescent Light 2]: Adjusts for natural white fluorescent lighting. [Fluorescent Light 3]: Adjusts for day white fluorescent lighting.	
	💡 (Incandescent)	Adjusts for places under incandescent lamp, or under bright lighting, such as in a photo studio.	
	⚡ ^{WB} (Flash)	Adjusts for the flash conditions.	
	📷 (One Push)	Adjusts the white balance depending on the light source. The white color memorized in [One Push Set] mode is the white reference. Use this mode if [Auto] or other modes cannot render the color properly.	
	📷 ^{SET} (One Push Set)	Captures a reference white in [One Push] mode	





Notes

- [White Balance] cannot be adjusted in Intelligent Auto Adjustment, or Easy Shooting mode.
- In Scene Selection mode, you can change the white balance setting only in iSo (High Sensitivity) or H (Gourmet) mode.
- When shooting movies or when Scene Selection is set to iSo (High Sensitivity) mode, [Flash] in [White Balance] cannot be selected.
- Under fluorescent lights that flicker, the white balance function may not work correctly even though you select [Fluorescent Light 1], [Fluorescent Light 2] or [Fluorescent Light 3].
- When shooting with a flash in other than [Flash] mode, [White Balance] is set to [Auto].
- SET [One Push Set] cannot be selected while charging the flash.

Effects of lighting conditions

The apparent color of the subject is affected by the lighting conditions.

The color tones are adjusted automatically in the Intelligent Auto Adjustment mode, but you can adjust color tones manually using the White Balance function.

Weather/lighting	Daylight	Cloudy	Fluorescent	Incandescent
Characteristics of light	White (standard) 	Bluish 	Green-tinged 	Reddish 

To capture a reference white in [One Push Set] mode

- 1 Frame a white object such as a piece of paper filling the screen under the same lighting conditions as you will shoot the subject.
- 2 MENU → [White Balance] → [One Push Set] → ● on the control button.
- 3 The screen momentarily turns black, and when white balance has been adjusted and stored in memory, the recording screen is displayed again.

Notes



- If the WB indicator flashes during shooting, white balance is not yet set, or cannot to be set. If white balance cannot be set, shoot in [Auto] setting.
- Do not shake or strike the camera while [One Push Set] is in progress.
- When flash mode is set to ON [Flash On] or SL [Slow Synchro (Flash On)], white balance is adjusted under flash condition.

Focus

You can change the focus method. Use the menu when it is difficult to get the proper focus in auto focus mode.

AF stands for “Auto Focus,” a function that adjusts the focus automatically.

- 1 Set the mode dial to **M** (Manual Exposure Shooting), **P** (Program Auto) or **[]** (Movie Mode).
- 2 MENU → **[]** (Focus) → desired mode

✓	[] (Multi AF)	<p>Focuses on a subject in all ranges of the finder frame automatically.</p> <p>When you press the shutter button halfway down in still image shooting mode, a green frame is displayed around the area that is in focus.</p> <ul style="list-style-type: none"> • When the Face Detection function is active, AF operates with priority on faces. 	 <p>AF range finder frame (Only for still image)</p>
	[] (Center AF)	<p>Focuses on a subject in the center of the finder frame automatically. Using the AF lock function together, you can compose the image the way you want.</p>	 <p>AF range finder frame</p>
	[] (Spot AF)	<p>Focuses on an extremely small subject or a narrow area automatically. Using the AF lock function together, you can compose the image the way you want. Hold the camera steady so as not to misalign the subject and the AF range finder frame.</p>	 <p>AF range finder frame</p>
	1.0 m/ 3.0 m/7.0 m/ ∞ (unlimited distance)	<p>Automatically focuses quickly on the area around a previously set distance (Semi-manual). This mode is useful when repeatedly shooting a subject at the same distance. Use “Semi-manual” when it is difficult to get sharp focus with automatic focusing, such as when shooting a subject through a net or window.</p> <ul style="list-style-type: none"> • Focuses on a subject in all ranges of the finder frame in Semi-manual mode. 	

Notes

- When using the digital zoom or [AF Illuminator], the AF range finder frame is disabled and appears in a dotted line. In this case, the camera works to focus on the subjects at the center of the screen.
- When the focus mode is set to other than [Multi AF], you cannot use the Face Detection function.
- Only [Multi AF] or ∞ (unlimited distance) is available for movies.
- The focus mode is fixed to [Multi AF] while the Smile Shutter function is activated.
- The Semi-manual distance setting contains some errors, and this error increases when the zoom is set to the T side or the lens is tilted upward or downward.

Focusing on subjects near the edge of the screen

If the subject is out of focus, do as follows:

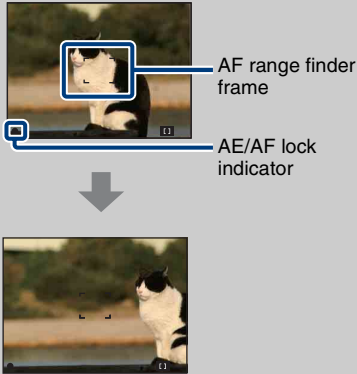

- ① Recompose the shot so that the subject is centered in the AF range finder, and press the shutter button halfway to focus on the subject (AF lock).
 - ② When the AE/AF lock indicator stops flashing and remains on, return to the fully composed shot, and press the shutter button fully down.
- As long as you do not press the shutter button fully down, you can retry the procedure as many times as necessary.

Metering Mode

Selects the metering mode that sets which part of the subject to measure to determine the exposure.

- 1 Set the mode dial to **M** (Manual Exposure Shooting), **P** (Program Auto) or **[Movie Mode]** (Movie Mode).
- 2 MENU → **[Metering Mode]** → desired mode

✓	[Multi]	Divides into multiple regions and measures each region. The camera determines a well-balanced exposure (Multi-pattern metering).	
	[Center]	Measures the center of the image, and determines the exposure based on the brightness of the subject there (Center-weighted metering).	
	[Spot]	Measures only a part of the subject (Spot metering). This function is useful when the subject is backlit or when there is strong contrast between the subject and the background.	 <p>Spot metering cross hairs Positions on the subject</p>

Notes

- In Movie Mode, [Spot] cannot be selected.
- If you set the Metering Mode to other than [Multi], the Face Detection function cannot be used.
- The Metering Mode is fixed to [Multi] while the Smile Shutter function is activated.

Scene Recognition

The camera automatically detects shooting conditions, and then takes the shot. When a face is detected, the ISO sensitivity is increased according to the face movement to reduce subject blur (Face Motion Detection).



Scene Recognition icon

The camera recognizes the following types of scenes. When the camera determines the optimal scene, it displays the corresponding icon.

☾ (Twilight), 👤 (Twilight Portrait), 📷 (Twilight using a tripod), 🌃 (Backlight), 🌃 (Backlight Portrait), 🏞️ (Landscape), 🌸 (Macro), 👤 (Portrait)

Example of an image where 🌃 (Backlight) has activated







- 1 Set the mode dial to **i** 📷 (Intelligent Auto Adjustment).
- 2 MENU → **iSCN** (Scene Recognition) → desired mode

✓	iSCN (Auto)	When the camera recognizes the scene, it switches to the optimal settings and shoots the image.
	iSCN+ (Advanced)	<p>When the camera recognizes the scene, it switches to the optimal settings. If the camera recognizes ☾ (Twilight), 👤 (Twilight Portrait), 📷 (Twilight using a tripod), 🌃 (Backlight) or 🌃 (Backlight Portrait), it automatically changes the setting and shoots another image.</p> <ul style="list-style-type: none"> • If two images are shot, + on iSCN+ turns green. • If two images are recorded, Auto Review displays them tiled vertically. • When the camera recognizes 👤 [Portrait], the camera automatically shoots an additional image. The image in which the subject's eyes are open is selected and recorded automatically.





Notes

- Scene Recognition does not function when using digital zoom.
- When the recording mode is set to Burst, or when the Smile Shutter function is activated, Scene Recognition is fixed to [Auto].
- The available flash settings are [Flash Auto] and [Flash Off].
- 📷 (Twilight using a tripod) scenes sometimes cannot be recognized in an environment where vibrations are transferred to the camera even though it is fixed on a tripod.
- Sometimes a slow shutter results when a scene is recognized as a 📷 (Twilight using a tripod). Keep the camera still during shooting.
- The current setting icon and the Scene Recognition icon appear regardless of the screen display settings.
- These scenes may not be recognized depending on the situation.

About the images shot in [Advanced]

When the camera recognizes difficult-to-shoot scenes such as  (Twilight),  (Twilight Portrait),  (Twilight using a tripod),  (Backlight) or  (Backlight Portrait), it shoots two images with the different effects set as follows.

You can select your favorite one after shooting.

	First shot*	Second shot
	Shot in Slow Synchro mode	Shot with the sensitivity increased to reduce blur
	Shot in Slow Synchro mode using the face most illuminated by the flash as the reference	Shot with the sensitivity increased using the face most illuminated by the flash as the reference to reduce blur
	Shot in Slow Synchro mode	Shot at a slower shutter speed and with the sensitivity not increased
	Shot using the flash	Shot with the background brightness and contrast adjusted (DRO plus)
	Shot using the face most illuminated by the flash as the reference	Shot with the brightness and contrast between the face and the background adjusted (DRO plus)

* Flash is used only in [Auto] mode.

What is the Anti Blink function?

When set to [Advanced] and the camera recognizes  (Portrait), the camera automatically shoots an additional image*. The image in which the subject's eyes are open is selected and recorded automatically. If eyes are closed in both images, the message "Blinked eye detected" is displayed and only the first image is recorded.

* Except when using Flash On mode or slow shutter mode.

Smile Detection Sensitivity

Sets the sensitivity of the Smile Shutter function for detecting smiles.

1 MENU → 😊 (Smile Detection Sensitivity) → desired mode

	😊 (Big Smile)	Detects a big smile.
✓	😊 (Normal Smile)	Detects a normal smile.
	😊 (Slight Smile)	Detects even a slight smile.

Notes

- Smiles may not be detected correctly depending on the conditions.
- [Smile Detection Sensitivity] cannot be adjusted in Easy Shooting mode or Movie Mode.
- You can change the Smile Detection Sensitivity setting when 📷 (High Sensitivity), 📷 (Soft Snap), 📷 (Twilight Portrait), 🏖️ (Beach) or ❄️ (Snow) mode is selected in Scene Selection mode.

Face Detection

Selects whether to use the Face Detection function or not, and also selects the priority subject for adjusting the focus when using the function.

Detects the faces of your subjects and adjusts the focus, flash, exposure, white balance and red-eye reduction settings automatically.



Face Detection frame (Orange)

When the camera detects more than one subject, the camera will judge which is the main subject and set focus by priority. The Face Detection frame for the main subject will turn orange. The frame for which the focus is set will turn green by pressing the shutter button halfway down.

Face Detection frame (White)

1 MENU → (Face Detection) → desired mode

	[OFF] (Off)	Does not use Face Detection function.
✓	[AUTO] (Auto)	Selects the face the camera is to automatically focus on.
	[Child Priority]	Detects and shoots with priority on child's face.
	[Adult Priority]	Detects and shoots with priority on adult's face.

Notes

- [Face Detection] cannot be selected in Easy Shooting or Movie Mode.
- You can select [Face Detection] only when the focus mode is set to [Multi AF] or the Metering Mode is set to [Multi].
- The Face Detection function does not work when using the digital zoom.
- Up to 8 faces of your subjects can be detected. However, only up to 4 faces of your subjects can be detected when (Soft Snap) mode is selected in the Scene Selection mode.
- Adults and children may not be recognized correctly depending on the conditions.
- During Smile Shutter shooting, [Face Detection] is automatically set to [Auto] even if it is set to [Off].

💡 Registering the priority face (Selected-face Memory)

Normally the camera automatically selects the face to focus on according to the [Face Detection] setting, but you can also select and register a face to be given priority.



Face Priority Frame Off

- ① Press ● on the control button during Face Detection. The leftmost face is registered as the priority face, and the frame changes from □ to an orange frame (□).
 - ② Each time you press ●, the priority face moves one face to the right. Press ● repeatedly until the orange frame (□) is on the face you want to register.
 - ③ To cancel the face registration (Off), move the orange frame to the rightmost face, then press ● again.
- When you remove the battery from the camera, the face registration is reset.
 - When the registered face disappears from the LCD screen, the camera returns to the setting selected by [Face Detection]. When the registered face is shown on the LCD screen again, the camera focuses on the registered face.
 - It may not be possible to detect the registered face correctly depending on the surrounding brightness, the subject's hairstyle, etc. In this case, register the face again under the conditions where the image will be shot.
 - When the Smile Shutter function is used with the Face Detection frame registered, Smile Detection is performed only on the registered face.
 - In Easy Shooting mode, the priority face cannot be registered.
 - You cannot select face priority when [Manual Exposure Shooting] is set.

💡 Making faces easier to detect



- Use an appropriate lighting level.
- Make sure the subjects' faces are not hidden by hats, masks, sunglasses, etc.
- Make sure the subjects are facing the camera.

Flash Level

Adjusts the amount of flash light. The flash level can be set in 1/3 EV steps.

1 Set the mode dial to M (Manual Exposure Shooting) or P (Program Auto).



2 MENU → 0EV (Flash Level) → desired EV setting



Notes

- Sometimes effects do not show up when the subject being shot is too bright or too dark.
- The value is not displayed on the screen. It is indicated as ↗+ or ↘-.

Anti Blink

When Scene Selection is set to  (Soft Snap) while you are shooting an image, the camera automatically shoots two images consecutively. The camera will select, display and record the image which the eyes are not blinked automatically.

- 1 Set the mode dial to **SCN** (Scene Selection).
- 2 Select  (Soft Snap).
- 3 MENU →  (Anti Blink) → desired mode

✓	 (Auto)	When Face Detection is active, the Anti Blink function operates so that images with the subject's eyes open are recorded.
	 (Off)	Does not use the Anti Blink function.

Notes

- Anti Blink does not function in the following situations.
 - When using the flash
 - During burst or bracket shooting
 - When the Face Detection function does not work
 - When the Smile Shutter function is activated
- Sometimes Anti Blink function does not work depending on the situation.
- When the Anti Blink function is set to [Auto] but only images with the subject's eyes closed are recorded, the message "Blinked eye detected" is displayed on the LCD screen. Shoot again as necessary.

Red Eye Reduction

The flash strobos two or more times before shooting to reduce the red-eye phenomenon when using the flash.

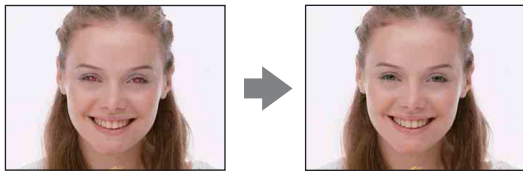

1 MENU → (Red Eye Reduction) → desired mode

✓	(Auto)	When the Face Detection function is activated, the flash strobos automatically to reduce the red-eye phenomenon.
	(On)	The flash always strobos to reduce the red-eye phenomenon.
	(Off)	Does not use Red Eye Reduction.

Notes

- [Red Eye Reduction] cannot be selected during Easy Shooting, Movie Mode, or Smile Shutter.
- To avoid blurring of images, hold the camera firmly until the shutter is released. It usually takes a second after you press the shutter button. Be also sure not to allow the subject to move during this period.
- Red Eye Reduction may not produce the desired effects. It depends on individual differences and conditions, such as distance to the subject, or if the subject looked away from the pre-strobe.
- If you do not use the Face Detection function, Red Eye Reduction does not work, even when you select [Auto].

What causes the red-eye phenomenon?

Pupils become dilated in dark environments. Flash light is reflected off the blood vessels at the back of the eye (retina), causing the “red-eye” phenomenon.

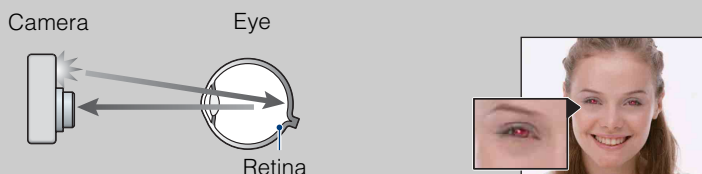

Other ways to reduce red-eye

- Select (High Sensitivity) mode in Scene Selection. (The flash is set to [Flash Off] automatically.)
- When the eyes of the subject turn out red, correct the image with [Retouch] → [Red Eye Correction] on the viewing menu or with the supplied software “PMB”.

DRO

The camera analyzes the shooting scene and automatically corrects the brightness and contrast to improve the image quality.

DRO stands for “Dynamic Range Optimizer,” a function that automatically optimizes the difference between light and dark parts of an image.

- 1 Set the mode dial to M (Manual Exposure Shooting) or P (Program Auto).
- 2 MENU → **D-R** (DRO) → desired mode



	D-R_{OFF} (Off)	Does not adjust.
✓	D-R (DRO standard)	Adjusts the brightness and contrast of the images automatically.
	D-R_{Plus} (DRO plus)	Adjusts image brightness and contrast automatically and strongly.









Notes

- Depending on shooting conditions, it may not be possible to obtain correction effects.
- Only [ISO AUTO] or values from [ISO 80] to [ISO 800] can be set for the ISO value when [DRO plus] is set.

Color Mode

You can change the brightness of the image, accompanied by effects.

- 1 Set the mode dial to M (Manual Exposure Shooting), P (Program Auto) or  (Movie Mode).
- 2 MENU →  (Color Mode) → desired mode

✓	 (Normal)	Sets the image to standard color.	
	 (Vivid)	Sets the image to bright and deep color.	
	 (Sepia)	Sets the image to sepia color.	
	 (B & W)	Sets the image to black and white.	



Note

- Only [Normal], [Sepia] or [B & W] can be selected when shooting movies.

Contrast

You can change the contrast of the shooting images.



- 1 Set the mode dial to M (Manual Exposure Shooting), or P (Program Auto).
- 2 MENU → [Contrast] → desired setting

	 (-)	Reduces the contrast.
✓	 STD (Standard)	
	 (+)	Enhances the contrast.

Sharpness

You can adjust picture sharpness.



- 1 Set the mode dial to M (Manual Exposure Shooting), or P (Program Auto).
- 2 MENU → [Sharpness] → desired setting

	 (-)	For softer images.
✓	 (Standard)	
	 (+)	For sharper images.

SteadyShot

Selects the anti-blur mode.



1 MENU →  (SteadyShot) → desired mode

✓	 (Shooting)	Activates the anti-blur function when pressing the shutter button halfway down.
	 (Continuous)	Always activates the anti-blur function. You can stabilize images even when zooming up a far subject.
	 (Off)	Does not use anti-blur mode.

Notes

- In Intelligent Auto Adjustment, Easy Shooting mode or Scene Selection is set to  (Gourmet) mode, [SteadyShot] is fixed to [Shooting].
- [SteadyShot] is fixed to [Continuous] while the Smile Shutter function is activated.
- For movies, you can set [Continuous] or [Off] only. The default setting for movies is [Continuous].
- The battery charge is used up more quickly in [Continuous] mode than in [Shooting] mode.

Hints for preventing blur

The camera moved accidentally when you took the image. This is called “Camera shake.” On the other hand, if the subject moved when you took the image, it is called “subject blur.” Besides, camera shake and subject blur occur frequently under low-light or slow shutter speed conditions, such as those encountered in  (Twilight Portrait) or  (Twilight) mode. In such case, shoot with the below tips in mind.

Camera shake

Your hands or body shake while you hold the camera and press the shutter button, and the entire screen is blurred.

- Use a tripod or place the camera on a flat surface to hold the camera steady.
- Shoot with a 2-second delay self-timer and stabilize the camera by holding your arms firmly at your side after pressing the shutter button.

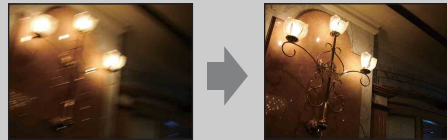

Subject blur

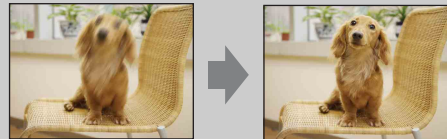

Even though the camera is steady, the subject moves during the exposure so the subject is shot blurred when the shutter button is pressed. Camera shake is reduced automatically using the anti-blur function. However, the function does not effectively reduce subject blur.

- Select  (High Sensitivity) mode in Scene Selection.
- Select a higher ISO sensitivity to make the shutter speed faster, and press the shutter button before the subject moves.



Slideshow

Images are automatically played back in succession along with effects and music.





- 1 Press the  (Playback) button to switch to playback mode.
- 2 MENU →  (Slideshow) → ● on the control button
- 3 Select a desired setting.
- 4 [Start] → ●
- 5 Press ● to end the slideshow.

Notes

- You cannot play back movies.
- Settings other than [Image] are stored until the next time they are changed.

Image

Selects the group of images to be shown.

<input checked="" type="checkbox"/>	All	Plays a slideshow of all the still images in order.
<input type="checkbox"/>	This Date	Plays a slideshow of still images with the currently selected date range when the view mode is  (Date View).
<input type="checkbox"/>	This Event	Plays a slideshow of still images in the currently selected event group when the view mode is  (Event View).
<input type="checkbox"/>	Favorites 1-6	Plays a slideshow of only the still images in the currently selected Favorites number when the view mode is  (Favorites).
<input type="checkbox"/>	Folder	Plays a slideshow of still images in the currently selected folder when the view mode is  (Folder View).

Note

- This setting is fixed to [Folder] when the internal memory is used to record images.

Effects

Selects the playback speed and mood for slideshows.

<input checked="" type="checkbox"/>	Simple	A simple slideshow switching still images at a preset interval. The playback interval is adjustable in [Interval] and you can thoroughly enjoy your images.
<input type="checkbox"/>	Nostalgic	A moody slideshow reproducing the atmosphere of a movie scene.
<input type="checkbox"/>	Stylish	A stylish slideshow proceeding at a middle tempo.
<input type="checkbox"/>	Active	A high-tempo slideshow suitable for active scenes.

Music

Specifies the music to be played during slideshows. You can select more than one background music track. Press ▼ on the control button to display the volume control screen, then press ▲/▼ to adjust the volume.

	Mute	Does not use BGM.
✓	Music1	The default setting for a [Simple] slideshow.
	Music2	The default setting for a [Nostalgic] slideshow.
	Music3	The default setting for a [Stylish] slideshow.
	Music4	The default setting for a [Active] slideshow.

Interval

Sets the screen switching interval. The setting is fixed to [Auto] when [Simple] is not selected as the [Effects].

	1 sec	Sets the display interval of images for a [Simple] slideshow.
✓	3 sec	
	5 sec	
	10 sec	
	Auto	The interval is set to suit the selected [Effects] item.

Repeat

Turns slideshow repeat on or off.

✓	On	Plays back images in a continuous loop.
	Off	After all the images have been played back, the slideshow ends.





Selecting background music

You can transfer a desired music file from your CDs or MP3 files to the camera to play back during slideshow. To transfer music, install the “Music Transfer” software (supplied) to your computer. For details, see pages 116 and 119.

- You can record up to four pieces of music on the camera (The 4 preset pieces (Music1 – Music4) can be replaced with the ones you transferred).
- A maximum length of each music file for music playback of the camera is about 5 minutes.
- If you cannot play back a music file due to damage or other malfunctions of the file, execute [Format Music] (page 96) and transfer the music again.

Date List

This feature selects the date to be played back when using Date View.
Step 2 is unnecessary when [Date View] is already set.



- 1 Press the  (Playback) button to switch to playback mode.
- 2 MENU →  (View Mode) →  (Date View) → ● on the control button
- 3 MENU →  (Date List) → ●
- 4 Select the date you want to display → ●.

Note

- This item is not displayed when the internal memory is used to record images.

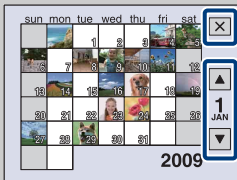



On the Date List screen



- Select the month you want to display with /.
- To exit from Date List, select  with the control button, then press ●.

Event List

This feature selects the event group to be played back when using Event View. You can enter a desired event name for each group using the “PMB” software (supplied). For details on entering the event name, see the “PMB Guide”. Step 2 is unnecessary when [Event View] is already set.



- 1 Press the  (Playback) button to switch to playback mode.
- 2 MENU →  (View Mode) →  (Event View) → ● on the control button
- 3 MENU →  (Event List) → ●
- 4 Select the event group you want to display → ●.

Note

- This item is not displayed when the internal memory is used to record images.

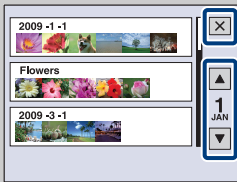

On the Event List screen







- The month indicator on the right of the screen displays the event month located at the top of the screen. Select the event month you want to display with /.
- To exit from Event List, select  with the control button, then press ●.

View Mode

Allows you to select the display format for viewing multiple images.

- 1 Press the  (Playback) button to switch to playback mode.
- 2 MENU →  (View Mode) → desired mode → ● on the control button

✓	 (Date View)	Displays images by the date. Select [Date List] from the Menu to select a specific date with a calendar display.
	 (Event View)	Analyzes the dates shots and frequency, automatically organizes the images into groups and displays them. Select [Event List] from the Menu to select the event group to view.
	 (Favorites)	Displays images registered as Favorites. Select the number of the Favorites you want to display.
	 (Folder View)	Images are displayed, organized by folders. When a recording folder is already created, select [Select Folder] from the Menu to select a folder to view.



Notes

- When using the internal memory, the View Mode is set to [Folder View].
- When images recorded with other cameras cannot be played back on this camera, view the images in [Folder View].



Viewing images taken with a different camera

The screen to choose a viewing method is displayed if you plug into this camera a “Memory Stick Duo” media containing both images taken with this camera and images taken with another camera.

“Playback only registered images”/“Playback all images with folder view”

If you select “Playback only registered images”, images are played in the selected View Mode. Some images taken with other cameras may not be played at this time.

If you select “Playback all images with folder view”, the camera switches to Folder View and plays all images.

Lightbulb On [Event View]

[Event View] is the function that the camera analyzes the dates shots and frequency, automatically organizes the images into groups and displays them. You can give convenient names to each event when using the supplied "PMB" software.

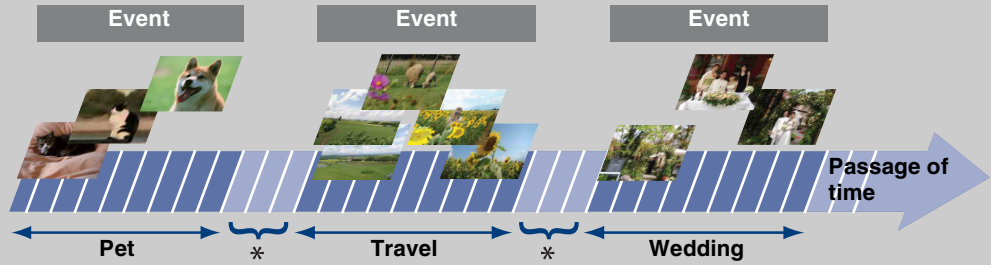
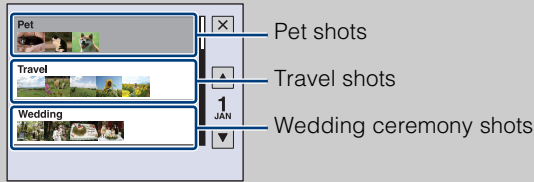







* No photo taken

- Table of contents
- Operation Search
- MENU/Settings Search
- Index

Filter by Faces

This feature filters images and displays them.

- 1 Press the  (Playback) button to switch to playback mode.
- 2 MENU →  (Filter by Faces) → desired mode → ● on the control button

 (Off)	Images are not filtered.
 (All people)	Images are filtered according to specified conditions and then displayed.
 (Children)	
 (Infants)	
 (Smiles)	







Notes

- This item is not displayed when the internal memory is used to record images.
- When the View Mode is set to [Folder View], you cannot use the Filter by Faces function.
- Sometimes images are mistakenly displayed or hidden.
- Sometimes filtering cannot be performed with images shot using other cameras.

Add / Remove Favorites

Select your favorite images and add/remove them from groups as Favorites. The ♥ mark is displayed for registered images.

- 1 Press the  (Playback) button to switch to playback mode.
- 2 MENU → ♥ (Add / Remove Favorites) → desired mode → ● on the control button
- 3 Select the Favorites group number → ●.
- 4 MENU → [OK] → ●



 (This Image)	Registers or removes the currently displayed image to/from Favorites.
 (Multiple Images)	Allows you to select and register/remove multiple images to/from Favorites. Do as the following after step 3. ① Select an image then press ●. Repeat the above steps until there are no more images to be added/removed. Select an image with a ✓ mark to release the ✓ mark. ② MENU → [OK] → ●
 (Add All in Date Range)  (Add All in Event)	Registers all images in the selected date range or event group to Favorites at once in index mode.
 (Remove All in Date Range)  (Remove All in Event)  (Remove All in Favorites)	Removes all images from Favorites at once in index mode.







Notes



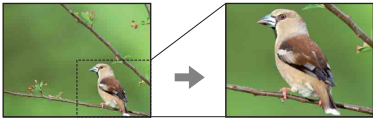

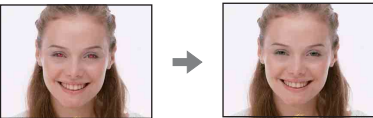

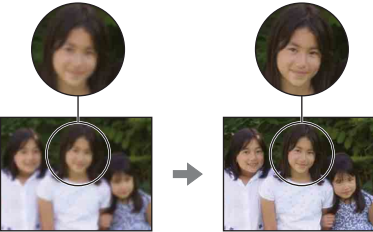

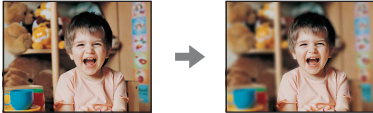









- This item is not displayed when the internal memory is used to record images.
- When the View Mode is set to [Folder View], you cannot add or remove images as Favorites.

Retouch

Adds effects or makes corrections to a recorded image and records it as a new file. The original image is retained.

- 1 Press the  (Playback) button to switch to playback mode.
- 2 MENU →  (Retouch) → desired mode → ● on the control button
- 3 Perform retouching according to the operation method in each mode.

 (Trimming)	<p>Records the zoomed playback image.</p> <ol style="list-style-type: none"> ① Move the lever towards Q (T) to zoom in, or (W) to zoom out. ② Set the zoom point with the control button. ③ MENU → select an image size to save → ● ④ [OK] → ● <ul style="list-style-type: none"> • The quality of trimmed images may deteriorate. • The image size that you can trim may vary depending on the image. 	
 (Red Eye Correction)	<p>Corrects the red-eye phenomenon caused by flash.</p> <ol style="list-style-type: none"> ① Select [OK] with the control button → ●. <ul style="list-style-type: none"> • You may not be able to correct the red-eye phenomenon depending on the image. 	
 (Unsharp masking)	<p>Sharpens the image within a chosen frame.</p> <ol style="list-style-type: none"> ① Select the area (frame) of the desired image to retouch with the control button → MENU. ② [OK] → ● <ul style="list-style-type: none"> • Depending on the image, sufficient correction may not be applied and the image quality may deteriorate. 	
 (Soft Focus)	<p>Blurs the periphery around a chosen point to signalize a subject.</p> <ol style="list-style-type: none"> ① Select the center point of the desired image to retouch with the control button → MENU. ② Select the level of retouch → ●. ③ Adjust the desired range to retouch with the W/T (zoom) lever → [OK] → ●. 	

 (Partial Color)	<p>Surrounds a chosen point in monochrome to signalize a subject.</p> <ol style="list-style-type: none"> ① Select the center point of the desired image to retouch with the control button → MENU. ② Adjust the desired range to retouch with the W/T (zoom) lever → [OK] → ●. 	 
 (Fisheye Lens)	<p>Applies a fisheye effect around a chosen point.</p> <ol style="list-style-type: none"> ① Select the center point of the desired image to retouch with the control button → MENU. ② Select the level of retouch → ●. ③ [OK] → ● 	 
 (Cross Filter)	<p>Adds starburst effects to light sources.</p> <ol style="list-style-type: none"> ① Select the level of retouch with the control button → ●. ② Adjust the desired length to retouch with the W/T (zoom) lever → [OK] → ●. 	 
 (Radial Blur)	<p>Decides the center point for expressing movement in the still image.</p> <ol style="list-style-type: none"> ① Select the center point of the desired image to retouch with the control button → MENU. ② Adjust the desired range to retouch with the W/T (zoom) lever → [OK] → ●. 	 
 (Retro)	<p>Softens the image by blurring the focus and lowering the surrounding light so that it appears as if it was taken by an old camera.</p> <ol style="list-style-type: none"> ① Select the level of retouch with the control button → ●. ② Adjust the desired range to retouch with the W/T (zoom) lever → [OK] → ●. 	 
 (Happy Faces)	<p>This feature puts a smile on a person's face.</p> <ol style="list-style-type: none"> ① Select the level of retouch with the control button → ●. ② [OK] → ● <ul style="list-style-type: none"> • Retouching may not be possible depending on the image. 	 



Note







- Movies cannot be retouched.

Multi-Purpose Resize

You can change the aspect ratio and size of the shooting images, then record them as the new files.

You can convert images to the 16:9 aspect ratio for high definition viewing and to the VGA size for blog or e-mail attachments.

- 1 Press the  (Playback) button to switch to playback mode.
- 2 MENU →  (Multi-Purpose Resize) → desired mode → ● on the control button
- 3 Zoom to the range you want to trim with the W/T (zoom) lever.
- 4 Specify the area you want to trim with the control button.
- 5 MENU → [OK] → ●



 (HDTV)	Changes the aspect ratio from 4:3/3:2 to 16:9 and saves as 2M size.		→	
 (Blog/E-mail)	Changes the aspect ratio from 16:9/3:2 to 4:3 and saves as VGA size.		→	





Notes

- You cannot resize movies.
- Images shot in VGA size cannot be resized to [HDTV] size.
- Enlarging the image and multi resizing can reduce the image quality.

Delete

Allows you to select unwanted images for deletion. You can also delete images using the  (Delete) button (page 36).

- 1 Press the  (Playback) button to switch to playback mode.
- 2 MENU →  (Delete) → desired mode → ● on the control button
- 3 [OK] → ●

 (This Image)	Deletes the currently displayed image in single-image mode.
 (Multiple Images)	You can select and delete multiple images. Do as the following after step 2. ① Select an image then press ●. Repeat the above steps until there are no more images to be deleted. Select an image with a ✓ mark to release the ✓ mark. ② MENU → [OK] → ●
 (All in This Folder)  (All in Date Range)  (All in Event)	Deletes all images in the selected folder, date range or event group at once.



Notes







- When the mode dial is set to **EASY** (Easy Shooting), you can select between [Delete Single Image] or [Delete All Images].
- When the View Mode is set to [Favorites], you cannot delete images.

Protect

Protects recorded images against accidental erasure.

The  mark is displayed for registered images.

- 1 Press the  (Playback) button to switch to playback mode.
- 2 MENU →  (Protect) → desired mode →  on the control button

 (This Image)	Protects the currently displayed image in single-image mode.
 (Multiple Images)	<p>You can select and protect multiple images. Do as the following after step 2.</p> <p>① Select an image then press .</p> <p>Repeat the above steps until there are no more images to be protected. Select an image with a  mark to release the  mark.</p> <p>② MENU → [OK] → </p>



To cancel the protection

Select the image for which you want to cancel protection, and unlock it by pressing  on the control button as the same procedure to protect it.



The  indicator disappears, and the protection is released.

DPOF

DPOF (Digital Print Order Format) is a function that allows you to specify the images of “Memory Stick Duo” media that you want to print out later.

The **DPOF** (Print order) mark is displayed for registered images.

- 1 Press the  (Playback) button to switch to playback mode.
- 2 MENU → **DPOF** → desired mode → ● on the control button

DPOF  (This Image)	Orders printing the currently displayed image in single-image mode.
DPOF  (Multiple Images)	You can select and order printing multiple images. Do as the following after step 2. ① Select an image then press ●. Repeat the above steps until there are no more images to be printed. Select an image with a ✓ mark to release the ✓ mark. ② MENU → [OK] → ●

Notes

- The **DPOF** (Print order) mark cannot be added to movies or to images in the internal memory.
- You can add a **DPOF** (Print order) mark to a maximum 999 images.



Clearing the DPOF mark





Select the image to clear the DPOF registration, then press ● on the control button in the same procedure as when making a DPOF mark.

The **DPOF** mark disappears and the DPOF registration is cleared.

Select Folder

When multiple folders are created in “Memory Stick Duo” media, this selects the folder containing the image you want to play back.

Step 2 is unnecessary when [Folder View] is already set.

- 1 Press the  (Playback) button to switch to playback mode.
- 2 MENU →  (View Mode) →  (Folder View) → ● on the control button
- 3 MENU →  (Select Folder) → ●
- 4 Select the folder with ◀/▶.
- 5 [OK] → ●



Note

- This item is not displayed when the internal memory is used to record images.



Viewing images across multiple folders





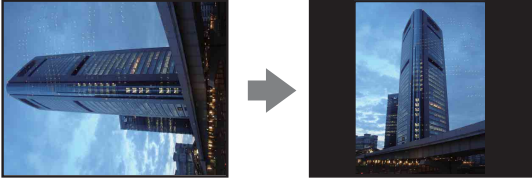

When multiple folders are created, the following indicators appear on the first and last images in the folder.

- : Moves to the previous folder
- : Moves to the next folder
- : Moves to either the previous or next folders

Rotate

Rotates a still image. Use this to display a horizontal orientation image in vertical orientation.





- 1 Press the  (Playback) button to switch to playback mode.
- 2 MENU →  (Rotate) → ● on the control button
- 3 Rotate the image with [/] → /.
- 4 [OK] → ●

Notes

- You cannot rotate movies or protected still images.
- You may not be able to rotate images shot with other cameras.
- When viewing images on a computer, the image rotation information may not be reflected depending on the software.





AF Illuminator

The AF illuminator supplies fill light to focus more easily on a subject in dark surroundings. The AF illuminator emits red light allowing the camera to focus easily when the shutter button is pressed halfway, until the focus is locked. The AF-ON indicator appears at this time.

- 1 Set the camera to shooting mode.
- 2 MENU →  (Settings) →  (Shooting Settings) → [AF Illuminator] → desired mode → ● on the control button



✓	Auto	Uses the AF illuminator.
	Off	Does not use AF illuminator.

Notes

- Focus is achieved as long as the AF illuminator light reaches the subject, regardless of whether light fails to reach the center of the subject.
- You cannot use the AF illuminator when:
 - [Focus] is set to Semi-manual mode.
 - [Conversion Lens] is set to a mode other than [Off].
 -  (Advanced Sports Shooting),  (Landscape) mode,  (Twilight) mode or  (Fireworks) mode is selected in the Scene Selection mode.
- When you use AF illuminator, the normal AF range finder frame is disabled and a new AF range finder frame is displayed by a dotted line. AF operates with priority on subjects located near the center of the frame.
- The AF illuminator emits very bright light. Although there is no health hazard, do not look directly into the AF illuminator emitter at close range.

Grid Line



With reference to the grid lines, you can easily set a subject in a horizontal/vertical position.

- 1 Set the camera to shooting mode.
- 2 MENU →  (Settings) →  (Shooting Settings) → [Grid Line] → desired mode → ● on the control button

	On	Displays the grid lines. The grid lines are not recorded.
✓	Off	Does not display the grid lines.

Digital Zoom

Selects the digital zoom mode. The camera enlarges the image using optical zoom (up to 10×). When the zoom scale is exceeded, the camera uses either smart or precision digital zoom.

- 1 Set the camera to shooting mode.
- 2 MENU →  (Settings) →  (Shooting Settings) → [Digital Zoom] → desired mode → ● on the control button

✓	Smart (SQ)	Enlarges the image digitally within the range where the image will not be distorted, according to the image size (Smart zoom).
	Precision (PQ)	Enlarges all image sizes by the total zoom scale of approximately 20×, including the optical zoom 10×. However, note that the picture quality deteriorates when the optical zoom scale is exceeded (Precision digital zoom).
	Off	Does not use the digital zoom.

Notes

- Digital zoom is not available in the following cases:
 - Shooting movies
 - The Smile Shutter is working
 -  (Advanced Sports Shooting) is selected in the Scene Selection mode
- The smart zoom is not available when the image size is set to [10M], [3:2(8M)] or [16:9(7M)].
- The Face Detection function does not work when using the digital zoom.



Total zoom scale when using Smart zoom (including optical zoom 10×)

The supported zoom ratio differs depending on the image size.

Size	Total zoom scale
5M	Approx. 14×
3M	Approx. 17×
VGA	Approx. 57×
16:9(2M)	Approx. 19×



Conversion Lens

Sets for achieving appropriate focus when attaching a conversion lens (sold separately). Attach the adaptor ring (sold separately) to the conversion lens first, then attach the conversion lens to the camera.

- 1 Set the camera to shooting mode.
- 2 MENU →  (Settings) →  (Shooting Settings) → [Conversion Lens] → desired mode → ● on the control button



	Close-up (D_c)	Attaches a close-up lens.
	Tele (D_T)	Attaches a tele conversion lens.
	Wide (D_w)	Attaches a wide conversion lens.
✓	Off	Does not attach a lens.

Notes

- When using the built-in flash, the flash light may be blocked, causing the shadow to appear.
- A reflected image of the lens may appear in images due to reflection between this lens and the conversion lens.
- The macro setting is fixed to [Auto].
- The available zoom area is limited.
- The available focusing area is limited.
- AF Illuminator does not emit light.
- You cannot select Semi-manual.
- If you shoot images with a tele conversion lens, the camera may also focus on close subjects in  (Landscape) mode and  (Twilight) mode.
- If you shoot images with a conversion lens, you may not be able to record images in  (Fireworks) mode with its optimal effect.
- Refer also to the operating instructions supplied with your conversion lens and adaptor ring.

Auto Orientation

When the camera is rotated to shoot a portrait (vertical) image, the camera records its position change and displays the image in the portrait position.

- 1 Set the camera to shooting mode.
- 2 MENU →  (Settings) →  (Shooting Settings) → [Auto Orientation] → desired mode → ● on the control button

<input checked="" type="checkbox"/>	On	Records the image with the correct orientation.
<input type="checkbox"/>	Off	Does not use Auto Orientation.

Notes

- Black is displayed to the left and right of vertical orientation images.
- Depending on the shooting angle of the camera, the orientation of the image may not be recorded correctly.
- You cannot use Auto Orientation in Movie Mode.





Rotating images after recording

- If the orientation of an image is incorrect, you can use the [Rotate] on the Menu screen to display the image in portrait position.

Auto Review

Displays the recorded image on the screen for approximately two seconds immediately after shooting a still image.

- 1 Set the camera to shooting mode.
- 2 MENU →  (Settings) →  (Shooting Settings) → [Auto Review] → desired mode → ● on the control button

✓	On	Uses the Auto Review.
	Off	Does not use Auto Review.

Shooting another image without delay



- When you press the shutter button halfway down, the display of the recorded image disappears and you can shoot another image immediately, even if Auto Review is set to [On].

Continuing to view an Auto Review image

- When you keep the shutter button pressed down after shooting, the Auto Review image remains displayed for as long as the shutter button remains pressed down.

Beep



Selects or turns off the sound produced when you operate the camera.

- 1 MENU →  (Settings) →  (Main Settings) → [Beep] → desired mode → ● on the control button

	Shutter	Turns on the shutter sound when you press the shutter button.
✓	High	Turns on the beep/shutter sound when you press the control/shutter button.
	Low	If you want to lower the volume, select [Low].
	Off	Turns off the beep/shutter sound.



Language Setting

Selects the language to be used in the menu items, warnings and messages.

- 1 MENU →  (Settings) →  (Main Settings) → [Language Setting] → desired mode → ● on the control button

Function Guide

You can select whether or not function guide is displayed when you operate the camera.

1 MENU →  (Settings) →  (Main Settings) → [Function Guide] → desired mode → ● on the control button

✓	On	Displays the function guide.
	Off	Does not display the function guide.

Table of contents

Operation Search



MENU/Settings Search

Index

Initialize

Initializes the setting to the default setting.

Even if you execute this function, the images are retained.



1 MENU →  (Settings) →  (Main Settings) → [Initialize] → [OK] → ●
on the control button

Note

- Be sure not to turn off the camera while initializing.

Demo Mode

You can set whether to use a demonstration of the Smile Shutter and Scene Recognition. When there is no need to view a demonstration, set to [Off].



- 1 MENU →  (Settings) →  (Main Settings) → [Demo Mode] → desired mode → ● on the control button
- 2 Set the mode dial to  (Intelligent Auto Adjustment).

	On	Demonstrates the Scene Recognition and Smile Shutter mode.
✓	Off	Does not perform a demonstration.

View a demonstration of Scene Recognition

- 1 Point the camera at the subject.
When Scene Recognition is performed, the icon and a description of the recognized scene appear on the screen.
- 2 Press the shutter button.
The image is recorded as a normal shooting.

View a demonstration of Smile Shutter



- 1 Press  (Smile) button.
- 2 Point the camera at the subject.
The camera automatically operates the shutter when a smiling face is detected, but no image is recorded.
- 3 Press  (Smile) button again to exit the demo mode.

Notes

- [Auto Review] is fixed to [On].
- When demonstrating the Scene Recognition mode, the setting is fixed to [Auto].
- Although you can release the shutter in Smile Shutter demo mode, no image is recorded.

COMPONENT

Selects the video signal output type from SD and HD(1080i) when you connect the camera and TV using an HD Output Adaptor Cable (sold separately), according to the TV connected. Use a Type2b-compliant HD Output Adaptor Cable.

1 MENU →  (Settings) →  (Main Settings) → [COMPONENT] → desired mode → ● on the control button

✓	HD(1080i)	Select this item to connect the camera to a 1080i-capable High Definition TV.
	SD	Select this item to connect the camera to a TV that is not compatible with an HD(1080i) signal.

Video Out

Sets the video signal output according to the TV color system of the connected video equipment. The TV color systems differ depending on the country and region.

To view images on a TV screen, check the TV color system of the country or region of use (page 107).

1 MENU →  (Settings) →  (Main Settings) → [Video Out] → desired mode → ● on the control button

NTSC	Sets the video output signal to NTSC mode (e.g., for the USA, Japan).
PAL	Sets the video output signal to PAL mode (e.g., for Europe, China).

Wide Zoom Display



During playback on High Definition TV, still images at a 4:3 and 3:2 aspect ratio are played at a 16:9 aspect ratio. In this case the top and bottom of the image will be slightly cropped.



Camera LCD screen display



TV screen with Wide Zoom Display

1 MENU →  (Settings) →  (Main Settings) → [Wide Zoom Display] → desired mode → ● on the control button



	On	Plays at a 16:9 aspect ratio.
✓	Off	Does not use Wide Zoom Display.

Notes

- Wide Zoom Display is not available for movies, 16:9 images and images displayed in the portrait (vertical) position.
- The image displayed on the LCD screen of the camera does not change.
- When connecting to a TV with the USB, A/V cable for multi-use terminal (supplied), you cannot use Wide Zoom Display.

USB Connect

Selects the USB mode when connecting the camera to a computer or a PictBridge compliant printer using the cable for multi-use terminal.

1 MENU →  (Settings) →  (Main Settings) → [USB Connect] → desired mode → ● on the control button



✓	Auto	The camera recognizes automatically and sets up communication with a computer or PictBridge compliant printer.
	PictBridge	Connects the camera to a PictBridge compliant printer.
	PTP/MTP	When you connect the camera to a computer, the AutoPlay Wizard appears, and the still images in the recording folder on the camera are imported to the computer. (with Windows Vista/XP, Mac OS X)
	Mass Storage	Establishes a Mass Storage connection between the camera and a computer or other USB device.

Notes

- If you cannot connect the camera to a PictBridge compliant printer with the [Auto] setting, select [PictBridge].
- If you cannot connect the camera to a computer or a USB device with the [Auto] setting, select [Mass Storage].
- When [USB Connect] is set to [PTP/MTP], you cannot export movies to a computer. To export movies to a computer, set [USB Connect] to [Auto] or [Mass Storage].

Download Music

You can use “Music Transfer” in the CD-ROM (supplied) to change background music tracks.

- 1 MENU →  (Settings) →  (Main Settings) → [Download Music] → ● on the control button

The message “Connect to PC” appears.

- 2 Make a USB connection between the camera and a computer, then start “Music Transfer”.
- 3 Follow the instructions on the screen to change music files.

Format Music

You can delete all the background music files stored in the camera. It can be used in cases such as when the background music files are damaged and cannot be played.

1 MENU →  (Settings) →  (Main Settings) → [Format Music] → [OK] → ● on the control button





Restoring the music preset at the factory to the camera

You can use “Music Transfer” in the CD-ROM (supplied) to reset music files to the preset ones.

- ① Make a USB connection between the camera and a computer.
- ② Start “Music Transfer”, then restore the default music.
 - For details on using “Music Transfer”, see the help in “Music Transfer”.

Format

Formats the “Memory Stick Duo” media or the internal memory. A commercially available “Memory Stick Duo” media is already formatted, and can be used immediately.

1 MENU →  (Settings) →  (“Memory Stick” Tool) or  (Internal Memory Tool) → [Format] → [OK] → ● on the control button



Note

- Note that formatting permanently erases all data including even protected images.

Create REC.Folder

Creates a folder in “Memory Stick Duo” media for recording images.

Images are recorded in the newly created folder until you create another folder or select another recording folder.

1 MENU →  (Settings) →  (“Memory Stick” Tool) → [Create REC.Folder] → [OK] → ● on the control button

Notes

- This item is not displayed when the internal memory is used to record images.
- When you insert a “Memory Stick Duo” media that was used with other equipment into the camera and shoot images, a new folder may be automatically created.
- Up to 4,000 images can be stored in one folder. When the folder capacity is exceeded, a new folder is automatically created.





On the folders

- After a new folder is created, you can change the storage destination folder (page 99) and select the folder for viewing images (page 78).

Change REC.Folder

Changes the folder in “Memory Stick Duo” media that is currently used for recording images.



- 1 MENU →  (Settings) →  (“Memory Stick” Tool) → [Change REC.Folder]
- 2 Select a folder with ◀/▶ on the control button.
- 3 [OK] → ●

Notes

- This item is not displayed when the internal memory is used to record images.
- The following folder cannot be selected as a recording folder.
 - “100” folder
 - A folder with a number that has only either “□□□MSDCF” or “□□□MNV01”.
- You cannot move recorded images to another folder.

Delete REC.Folder

Deletes a folder for recording images in “Memory Stick Duo” media.



- 1 MENU →  (Settings) →  (“Memory Stick” Tool) → [Delete REC.Folder]
- 2 Select a folder with ◀/▶ on the control button.
- 3 [OK] → ●

Notes

- This item is not displayed when the internal memory is used to record images.
- If you delete the folder set as the recording folder using [Delete REC.Folder], the folder that has the largest folder number is selected as the next recording folder.
- You can delete only empty folders. If a folder contains images, or files that cannot be played back by the camera, first delete these images and files, and then delete the folder.

Copy

Copies all images in the internal memory to a “Memory Stick Duo” media.



- 1 Insert a “Memory Stick Duo” media with sufficient free capacity into the camera.
- 2 MENU →  (Settings) →  (“Memory Stick” Tool) → [Copy] → [OK] → ● on the control button

Notes

- Use a fully charged battery pack. If you attempt to copy image files using a battery pack with little remaining charge, the battery pack may run out, causing copying to fail or possibly corrupting the data.
- Images cannot be copied individually.
- The original images in the internal memory are retained even after copying. To delete the contents of the internal memory, remove the “Memory Stick Duo” media after copying, then format the internal memory ([Format] in [Internal Memory Tool]).
- A new folder is created on the “Memory Stick Duo” media and all the data will be copied to it. You cannot choose a specific folder and copy images to it.

File Number



Selects the method used to assign file numbers to images.

- 1 MENU →  (Settings) →  (“Memory Stick” Tool) or  (Internal Memory Tool) → [File Number] → desired mode → ● on the control button

✓	Series	Assigns numbers to files in sequence even if the recording folder or the “Memory Stick Duo” media is changed. (When the replaced “Memory Stick Duo” media contains a file with a number higher than the last assigned number, a number one higher than the largest number is assigned.)
	Reset	Starts from 0001 each time the folder is changed. (When the recording folder contains a file, a number one higher than the largest number is assigned.)

Area Setting

Adjusts the time to the local time of a selected area.

1 MENU →  (Settings) →  (Clock Settings) → [Area Setting] → desired setting → ● on the control button

✓	Home	You use the camera in your area. When the currently set area differs from your home area, you must make the Area Setting.
	Destination	You use the camera set to the time at your destination. Set the destination area.

Changing Area Setting

Setting a frequently visited destination lets you easily adjust the time when you visit that destination.

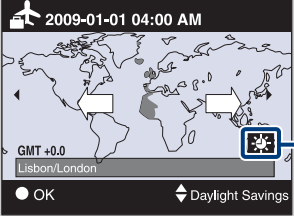
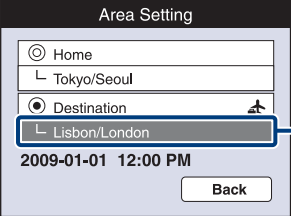



Daylight Saving icon
If [Daylight Savings] is set to [On], the icon turns white.

- ① Select the area part for [Destination], then press ● on the control button.
- ② Select an area with ◀/▶ on the control button, and select Daylight Savings time with ▲/▼.

Date & Time Setting

Sets the date and time again.

1 MENU →  (Settings) →  (Clock Settings) → [Date & Time Setting] → desired setting → ● on the control button

Date & Time Format	You can select the date and time display format.
Daylight Savings	You can select Daylight Savings On/Off.
Date & Time	You can set the date and time.

Note

- The camera does not have a feature for superimposing dates on images. By using “PMB” in the CD-ROM (supplied), you can print or save images with the date.

Viewing images on a TV

You can view images on a TV by connecting the camera to a TV.
The connection varies according to the type of TV the camera is connected to.
Refer also to the operating instructions supplied with the TV.

Viewing images by connecting the camera to a TV with the supplied cable for multi-use terminal

- 1 Turn off both the camera and the TV.
- 2 Connect the camera to the TV with the cable for multi-use terminal (supplied).

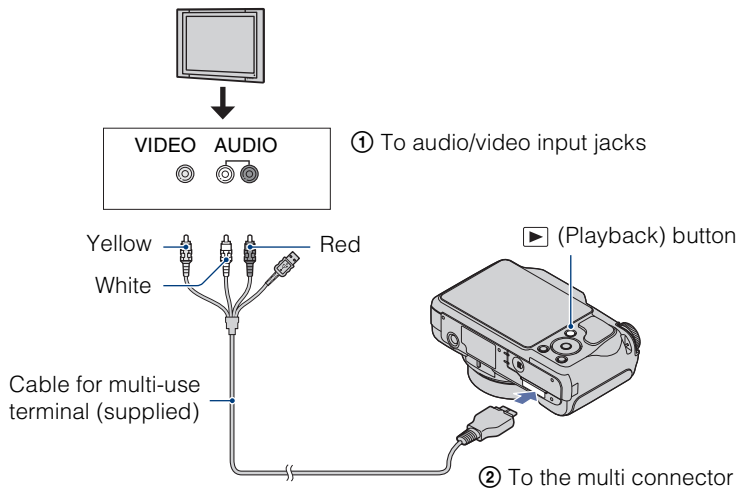

- 3 Turn on the TV and set the input.
- 4 Press  (Playback) button to turn on the camera.

Images shot with the camera appear on the TV. Select the desired image with the control button.

Notes

- When using the camera abroad, it may be necessary to switch the video signal output to match that of your TV system (page 92).
- The shooting image will not be displayed on the TV when the movie is shot under the condition of the camera and TV connected.
- When output to TV, easy viewing (page 24) is invalid.

Viewing an image by connecting the camera to an HD TV

You can view an image recorded on the camera by connecting the camera to an HD (High Definition) TV with the HD Output Adaptor Cable (sold separately). Use a Type2b-compliant HD Output Adaptor Cable.

- 1 Turn off both the camera and the TV.
- 2 Connect the camera to an HD (High Definition) TV with a HD Output Adaptor Cable (sold separately).

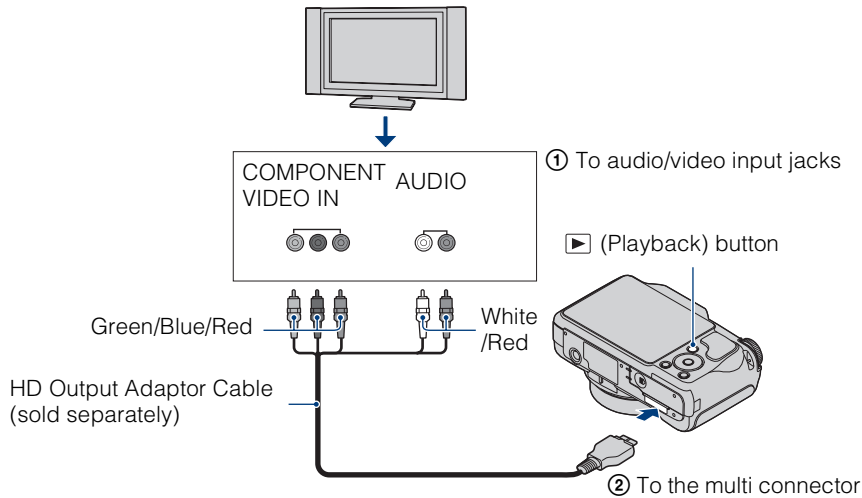

- 3 Turn on the TV and set the input.
- 4 Press **▶** (Playback) button to turn on the camera.

Images shot with the camera appear on the TV. Select the desired image with the control button.

Notes

- Set [COMPONENT] to [HD(1080i)] (page 91).
- When shooting movies in the condition with the camera and a TV connected using an HD Output Adaptor Cable (sold separately), the image being shot is not displayed in the TV side.
- Images shot in [VGA] image size cannot be played back in HD format.
- When using the camera abroad, it may be necessary to switch the video signal output to match that of your TV system (page 92).

💡 Viewing images shot with an image size other than 16:9 ($\frac{16:9}{7M}$, $\frac{16:9}{2M}$) full screen on an HD (High Definition) TV

- When you select [Multi-Purpose Resize] in the viewing menu, the aspect ratio can be converted to 16:9 and saved as a new file for viewing on an HD (High Definition) TV.
- You can play back an image with a 16:9 aspect ratio using [Wide Zoom Display] in the setting menu.

On “PhotoTV HD”

This camera is compatible with the “PhotoTV HD” standard.

By connecting Sony PhotoTV HD-compatible devices using an HD Output Adaptor Cable (sold separately), whole new world of photos can be comfortably enjoyed in breathtaking Full HD quality.

- PhotoTV HD allows for a highly-detailed, photo-like expression of subtle textures and colors.
- The settings are also required to be made on the TV. For details, refer to the operating instruction of the TV.

On TV color systems

If you want to view images on a TV screen, you need a TV with a video input jack and the cable for multi-use terminal. The color system of the TV must match that of the digital still camera. Check the following lists for the TV color system of the country or region where the camera is used.

NTSC system

Bahama Islands, Bolivia, Canada, Central America, Chile, Colombia, Ecuador, Jamaica, Japan, Korea, Mexico, Peru, Surinam, Taiwan, the Philippines, the U.S.A., Venezuela, etc.

PAL system

Australia, Austria, Belgium, China, Czech Republic, Denmark, Finland, Germany, Holland, Hong Kong, Hungary, Italy, Kuwait, Malaysia, New Zealand, Norway, Poland, Portugal, Singapore, Slovak Republic, Spain, Sweden, Switzerland, Thailand, United Kingdom, etc.

PAL-M system

Brazil

PAL-N system

Argentina, Paraguay, Uruguay

SECAM system

Bulgaria, France, Guiana, Iran, Iraq, Monaco, Russia, Ukraine, etc.

Enjoying your Windows computer

For details on using a Macintosh computer, refer to “Using your Macintosh computer” (page 117).



Install the software (supplied) first (page 110)

- Installing the software as follows:
 - “PMB”
 - “Music Transfer”



Connecting the camera to your computer (page 112)

- Enjoying images using “PMB” and “Music Transfer” as follows:
 - Importing images to your computer
 - Exporting images to the camera
 - Entering the desired event name to [Event List] on the camera
 - Editing images
 - Displaying the shooting locations of still images on maps online (this requires an Internet connection)
 - Creating a disc with the images shot (this requires CD or DVD disc writing drive)
 - Printing or saving still images with the date
 - Uploading images to a media service (this requires an Internet connection)
 - Adding/changing Music for slideshow (using “Music Transfer”)

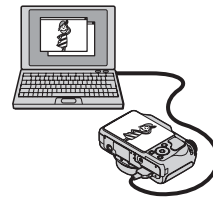

Additional information on this product and answers to frequently asked questions can be found at the Sony Customer Support Website.
<http://www.sony.net/>

Recommended computer environment

	OS (pre-installed)	Others
For using “PMB” and “Music Transfer”	Microsoft Windows XP* ¹ SP3/Windows Vista SP1* ²	<p>CPU: Intel Pentium III 800 MHz or faster (For playing/editing the High Definition movies: Intel Pentium 4 2.8 GHz or faster/ Intel Pentium D 2.8 GHz or faster/ Intel Core Duo 1.66 GHz or faster/ Intel Core 2 Duo 1.20 GHz or faster)</p> <p>Memory: 512 MB or more (For playing/editing the High Definition movies: 1 GB or more)</p> <p>Hard Disk: Disk space required for installation—approximately 500 MB</p> <p>Display: Screen resolution: 1,024 × 768 dots or more</p> <p>Video memory: 32 MB or more (Recommended: 64 MB or more)</p>
For importing images	Microsoft Windows 2000 Professional SP4, Windows XP* ¹ SP3/ Windows Vista SP1* ²	USB jack: Provided as standard

*¹ 64-bit editions and Starter (Edition) are not supported.

*² Starter (Edition) is not supported.

Notes

- The computer environment must also satisfy the operating requirements of the OS.
- Operation is not assured in an environment based on an upgrade of the operating systems described above or in a multi-boot environment.
- Operations are not guaranteed for all the recommended computer environments mentioned above.
- If you connect two or more USB devices to a single computer at the same time, some devices, including the camera, may not operate, depending on the types of USB devices you are using.
- Operations are not guaranteed when using a USB hub.
- Connecting the camera using a USB interface that is compatible with Hi-Speed USB (USB 2.0 compliant) allows advanced transfer (high speed transfer) as the camera is compatible with Hi-Speed USB (USB 2.0 compliant).
- There are four modes for a USB connection when connecting a computer, [Auto] (default setting), [Mass Storage], [PictBridge] and [PTP/MTP] modes. This section describes the [Auto] and [Mass Storage] as examples. For details on [PictBridge] and [PTP/MTP], see page 94.
- When your computer resumes from a suspend or sleep mode, communication between the camera and your computer may not recover at the same time.

Installing the software (supplied)

You can install the supplied software (PMB, Music Transfer) using the following procedure.

- 1 Turn on your computer, and insert the CD-ROM (supplied) into the CD-ROM drive.

The installation menu screen appears.

- If it does not appear, double-click [Computer] (in Windows XP, [My Computer]) →  (SONYPICUTIL).
- If the AutoPlay screen appears, select “Run Install.exe” and follow the instructions that appear on the screen to proceed with the installation.



- 2 Click [Install].

The “Choose Setup Language” screen appears.

- 3 Select the desired language, then click [Next].

The “License Agreement” screen appears.

- 4 Read the license agreement carefully. If you agree, click the radio button (changes to) then [Next].

- 5 Follow the instructions on the screen to complete the installation.

- When the restarting confirmation message appears, restart the computer following the instructions on the screen.
- DirectX may be installed depending on the system environment of your computer.

- 6 Remove the CD-ROM after the installation is complete.

The short cut icons for “ PMB” and “ PMB Guide” are created on the desktop. Double-click these icons to start the software.

Note

- Log on as Administrator.

On “PMB (Picture Motion Browser)” (supplied)

You can use still images and movies from the camera more than ever by taking advantage of the software. This section summarizes the “PMB”. For details, see the “PMB Guide”.

“PMB” overview

With the “PMB”:

- You can import images shot with the camera to the computer and display them on the computer.
- You can export images in your computer to a “Memory Stick Duo” media, and display them on the camera.
- You can enter the desired event name to [Event List] in the “Memory Stick Duo” media, and display them on the camera.
- You can organize images on the computer on a calendar by shooting date to view them.
- You can retouch (Red Eye Correction, etc.), search for faces, print, send still images as e-mail attachments, and change the shooting date.
- You can display information on the positions where you shot the images on a map. (This requires an Internet connection.)
- You can print or save the still images with the date.
- You can create a data disc using a CD burner drive or DVD burner drive.
- You can upload the image to a media service. (This requires an Internet connection.)

Starting the “PMB Guide”

1 Double-click the  (PMB Guide) icon on the desktop.

To access “PMB Guide” from the Start menu, click [Start] → [All Programs] → [Sony Picture Utility] → [Help] → [PMB Guide].

Starting and exiting the “PMB”

1 Double-click the  (PMB) icon on the desktop.

Or, from the Start menu: Click [Start] → [All Programs] → [Sony Picture Utility] → [PMB]. The confirmation message of the Information tool appears on the screen when starting the “PMB” for the first time. Select [Start].

- This function informs you of news, such as software updates. You can change the setting later.

2 Click the  button on the top right corner of the screen to exit the “PMB.”

Enjoying images on your computer

For details on the “PMB” functions, see the “PMB Guide”.

Connecting the camera to the computer

When importing images from the internal memory, step 1 is unnecessary.



- 1 Insert a “Memory Stick Duo” media with recorded images into the camera.
- 2 Insert the sufficiently charged battery pack into the camera, or connect the camera to a wall outlet (wall socket) with the AC Adaptor (sold separately) and the USB/AV/DC IN cable for multi-use terminal (sold separately).
 - Use a Type2b-compliant USB/AV/DC IN cable.
- 3 Turn on the computer, then press  (Playback) button.
- 4 Connect the camera to your computer.

“Connecting...” appears on the screen of the camera.

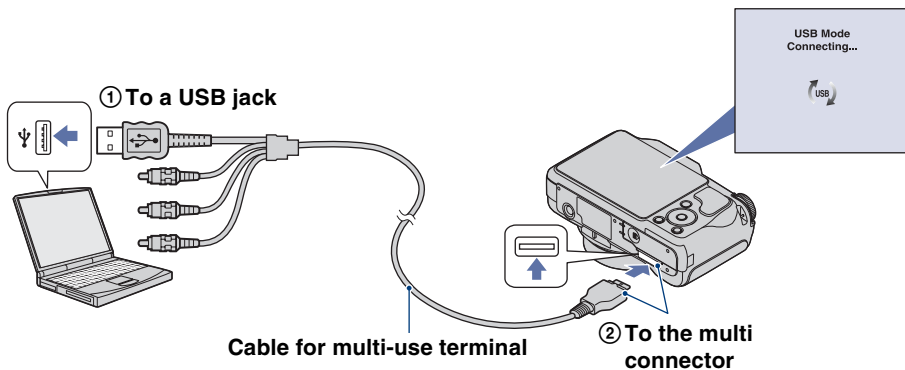
- When a USB connection is established for the first time, your computer automatically runs a program to recognize the camera. Wait for a while.



Notes

- When you import/export images from/to your computer using a battery pack with little remaining charge, transferring may fail or image data may become corrupted if the battery pack shuts down too soon.
-  is displayed on the screen during the communication session. Do not operate the computer while the indicator is displayed. When the indicator changes to , you can start using the computer again.
- If “Mass Storage” does not appear, set [USB Connect] to [Mass Storage] (page 94).

Importing images to a computer

1 Make a USB connection between the camera and a computer.

The [Import Media Files] screen of “PMB” appears automatically.

- If the AutoPlay Wizard appears, close it.

2 Click the [Import] button to import images.

The computer starts importing images.

- By default, images are imported into a folder created in “Pictures” (in Windows XP, “My Pictures”) that is named with the event name of [Event List].

3 View images on your computer.

When importing is complete, the “PMB” starts.

Thumbnails of the imported images are displayed.

- The “Pictures” (in Windows XP, “My Pictures”) folder is set as the default folder in “Viewed folders”.

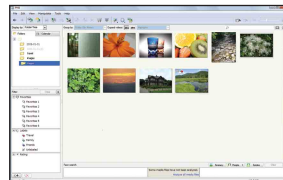

Viewing images using “PMB”

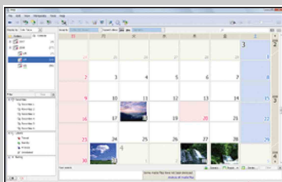

Example: Month display screen

Organize images on the computer on a calendar by shooting date to view them. For details on the “PMB”, see the “PMB Guide”.



Importing images to a computer without using “PMB”

When the AutoPlay Wizard appears in step 1, click [Open folder to view files] → [OK] → [DCIM] → copy the desired images to the computer.

Exporting images to view on the camera

You can export images in your computer to a “Memory Stick Duo” media, and view them on the camera. This section describes the procedure for automatically selecting and exporting images that have not been exported to “Memory Stick Duo” media in the camera.

The images can also be exported manually.
For details, see the “PMB Guide”.

- 1 Make a USB connection between the camera and a computer.
 - If the AutoPlay Wizard appears, close it.
- 2 Double-click  (PMB) on the desktop to start up “PMB”.
- 3 Click  on the top of the screen.
The easy export screen appears.
- 4 Click [Export].
 - When you play back exported images on this camera, the  mark is displayed on the LCD screen.

Notes

- You cannot play back some images depending on the image size.
- No guarantees are made for playing back, on this camera, files containing images which were processed on a computer or images which were shot using other cameras.
- This method cannot be used to export movies. Movies should be exported to the camera manually.

Deleting the USB connection

Perform the procedures from step 1 to 3 below before:

- Disconnecting the cable for multi-use terminal.
- Removing a “Memory Stick Duo” media.
- Inserting a “Memory Stick Duo” media into the camera after copying images from the internal memory.
- Turning off the camera.

- 1 Double-click the disconnect icon on the tasktray.
- 2 Click  (USB Mass Storage Device) → [Stop].
- 3 Confirm the device on the confirmation window, then click [OK].

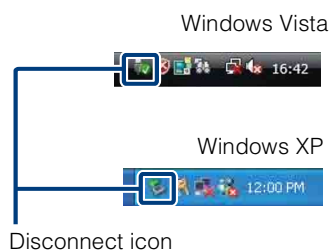
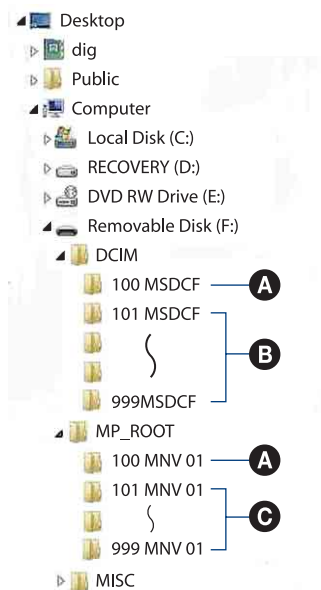

Image file storage destinations and file names

The image files recorded with the camera are grouped as folders on the “Memory Stick Duo” media or the internal memory.

Example: viewing folders on Windows Vista



- A** Folder containing image data recorded using a camera not equipped with the folder creating function.
- B** Folder containing still image data recorded using the camera.
- C** Folder containing movie data recorded using the camera.

Notes

- You cannot record any images to the “100MSDCF” or “100MNV01” folders. The images in these folders are available only for viewing.
 - You cannot record/play back any images of the “MISC” folder.
 - Image files are named as follows:
 - Still image files: DSC0□□□□.JPG
 - Movie files
 - 1280×720: M4H0□□□□.MP4
 - VGA: M4V0□□□□.MP4
 - Index image files that are recorded when you record movies
 - 1280×720: M4H0□□□□.THM
 - VGA: M4V0□□□□.THM
- stands for any number within the range from 0001 to 9999. The numerical portions of the name of a movie file recorded in Movie Mode and its corresponding index image file are the same.



Using the “Music Transfer” (supplied)

You can change the Music files that are preset at the factory to the desired Music files using “Music Transfer” in the CD-ROM (supplied). You can also delete these files whenever you want.

Changing Music using “Music Transfer”

The music formats you can transfer with “Music Transfer” are listed below:

- MP3 files stored on the hard disk drive of your computer
- Music on CDs
- Preset-music saved on the camera

- 1 MENU →  (Settings) →  (Main Settings) → [Download Music]
- 2 Press ● on the control button.
The message “Connect to PC” appears.
- 3 Make a USB connection between the camera and your computer.
- 4 Start “Music Transfer”.
- 5 Follow the instructions on the screen to change music files.



Restoring the music preset at the factory to the camera

Execute [Restore to Preset Tracks] in step 5.

All Music files return to the preset-music, and [Music] in the [Slideshow] menu is set to [Mute].

- You can reset the Music files to the preset ones using [Initialize] (page 89), however, other settings will also be reset.
- For details on using “Music Transfer”, see the help in “Music Transfer”.

Using your Macintosh computer

You can copy images to your Macintosh computer. “PMB” is not compatible with Macintosh computers.

When images is exported to the “Memory Stick Duo” media, view them in the Folder View mode (page 68).

Recommended computer environment

	OS (pre-installed)	Others
For copying images	Mac OS 9.1/9.2/ Mac OS X (v10.1 to v10.5)	USB jack: Provided as standard
For using “Music Transfer”	Mac OS X (v10.3 to v10.5)	Memory: 64 MB or more (128 MB or more is recommended) Hard Disk: Disk space required for installation—approximately 50 MB

Notes

- Operations are not guaranteed for all the recommended computer environments mentioned above.
- If you connect two or more USB devices to a single computer at the same time, some devices, including the camera, may not operate depending on the types of USB devices you are using.
- Operations are not guaranteed when using a USB hub.
- Connecting the camera using a USB interface that is compatible with Hi-Speed USB (USB 2.0 compliant) allows advanced transfer (high speed transfer) as the camera is compatible with Hi-Speed USB (USB 2.0 compliant).
- There are four modes for a USB connection when connecting a computer, [Auto] (default setting), [Mass Storage], [PictBridge] and [PTP/MTP] modes. This section describes the [Auto] and [Mass Storage] as examples. For details on [PictBridge] and [PTP/MTP], see page 94.
- When your computer resumes from the suspend or sleep mode, communication between the camera and your computer may not recover at the same time.

Additional information on this product and answers to frequently asked questions can be found at the Sony Customer Support Website.

<http://www.sony.net/>

Importing and viewing images on a computer

When importing images from the internal memory, step 1 is unnecessary.

- 1 Insert a “Memory Stick Duo” media with recorded images into the camera.
- 2 Insert the sufficiently charged battery pack into the camera, or connect the camera to a wall outlet (wall socket) with the AC Adaptor (sold separately) and the USB/AV/DC IN cable for multi-use terminal (sold separately).
- 3 Turn on the Macintosh computer, then press the  (Playback) button on the camera.
- 4 Connect the camera to your computer.

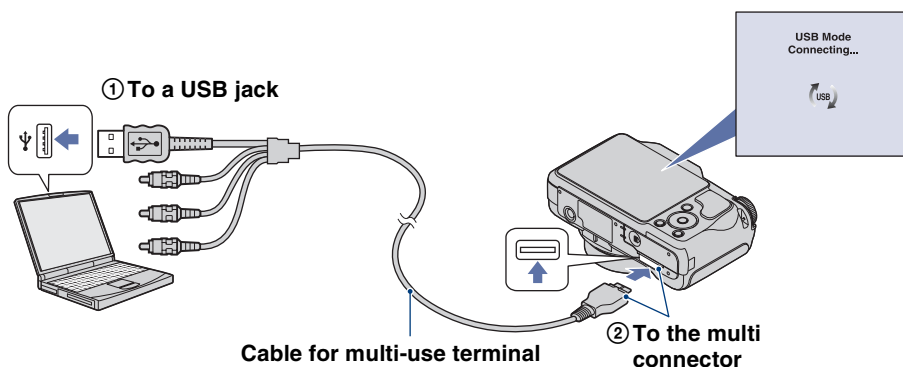

- 5 Double-click the newly recognized icon → [DCIM] → the folder where the images you want to import are stored.
- 6 Drag and drop the image files to the hard disk icon.
The image files are copied to the hard disk.
 - For details on the storage location of the images and file names, see page 115.
- 7 Double-click the hard disk icon → the desired image file in the folder containing the copied files.

Note

- Use a Type2b-compliant USB/AV/DC IN cable (sold separately).

Deleting the USB connection

Drag and drop the drive icon or the icon of the “Memory Stick Duo” media to the “Trash” icon beforehand when you perform the procedures listed below, or the camera is disconnected from the computer.



- Disconnecting the cable for multi-use terminal.
- Removing a “Memory Stick Duo” media.
- Inserting a “Memory Stick Duo” media into the camera.
- Turning off the camera.

Changing Music using “Music Transfer”

You can change the music files that are preset at the factory to the desired music files using “Music Transfer” in the CD-ROM (supplied). You can also delete these files whenever you want.

The music formats you can transfer with “Music Transfer” are listed below:

- MP3 files stored on the hard disk drive of your computer
- Music on CDs
- Preset-music saved on the camera

- 1 Turn on your Macintosh computer, and insert the CD-ROM (supplied) into the CD-ROM drive.
- 2 Double-click  (SONYPICUTUTIL).
- 3 Double-click the [MusicTransfer.pkg] file in [Mac] folder.
The installation of the software starts.
- 4 MENU →  (Settings) →  (Main Settings) → [Download Music]
- 5 Press ● on the control button.
The message “Connect to PC” appears.
- 6 Make a USB connection between the camera and Macintosh computer.
- 7 Start “Music Transfer”.
- 8 Follow the instructions on the screen to change music files.

Notes

- Shut down all other application software before you install “Music Transfer”.
- For installation, you need to log on as Administrator.



Restoring the music preset at the factory to the camera

Execute [Restore to Preset Tracks] in step 8.

All Music files return to the preset-music, and [Music] in the [Slideshow] menu is set to [Mute].

- You can reset the Music files to the preset ones using [Initialize] (page 89), however, other settings will also be reset.
- For details on using “Music Transfer”, see the help in “Music Transfer”.

Viewing “Cyber-shot Step-up Guide”

“Cyber-shot Step-up Guide” further introduces how to use the camera and optional accessories.

Viewing on Windows

When you install “Cyber-shot Handbook”, “Cyber-shot Step-up Guide” is also installed.

- 1 Double-click  (Step-up Guide) on the desktop.

To access “Step-up Guide” from the Start menu, click [Start] → [All Programs] → [Sony Picture Utility] → [Step-up Guide].

Viewing on Macintosh

- 1 Copy the [stepupguide] folder in the [stepupguide] folder to your computer.
- 2 Select [stepupguide], [language] and then [GB] folder stored in the CD-ROM (supplied), and copy all the files in the [GB] folder to the [img] folder in the [stepupguide] folder that you copied to your computer in step 1. (Overwrite the files in the [img] folder with the files from the [GB] folder.)
- 3 After copying is complete, double-click “stepupguide.hqx” in the [stepupguide] folder to uncompress it, then double-click the generated file “stepupguide”.

Note

- If an uncompress tool for HQX file is not installed, install the Stuffit Expander.

Printing still images

You can print still images by the following methods.

Printing directly using a PictBridge compliant printer (page 122)

You can print images by connecting the camera directly to a PictBridge compliant printer.

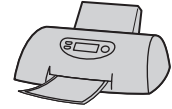

Printing directly using a “Memory Stick” media compliant printer

You can print images with a “Memory Stick” media compliant printer. For details, see the operating instructions supplied with the printer.

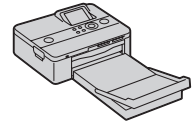

Printing using a computer

You can import images to a computer using the supplied “PMB” software and print the images.

You can insert the date on the image and print it. For details, see the “PMB Guide”.



Printing at a shop (page 124)

You can take a “Memory Stick Duo” media containing images shot with the camera to a photo printing service shop. You can make a **DPOF** (Print order) mark on the images which you want to print out in advance.



Note

- When you print images shot in [16:9] mode, both edges may be cut off.

Printing images directly using a PictBridge compliant printer

Even if you do not have a computer, you can print images shot using the camera by connecting the camera directly to a PictBridge compliant printer.

PictBridge “PictBridge” is based on the CIPA standard. (CIPA: Camera & Imaging Products Association)

Note

- You cannot print movies.

Preparing the camera

Prepare the camera for USB connection to the printer, using the cable for multi-use terminal.

- 1 Insert the sufficiently charged battery pack into the camera.
- 2 Connect the camera to the printer.

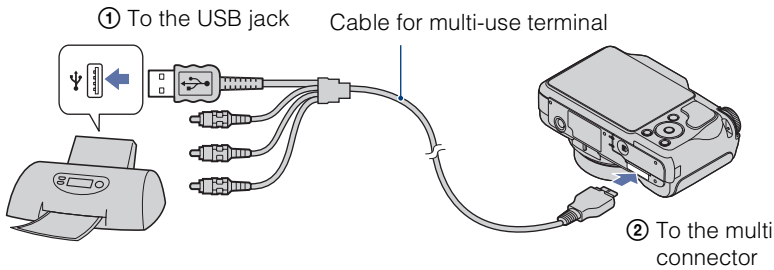

- 3 Turn on the printer.

After the connection is made, the  indicator appears on the screen.

If the  indicator flashes on the screen of the camera (error notification), check the connected printer.

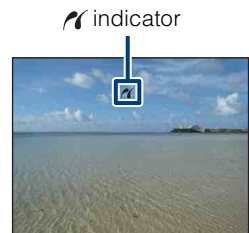

Note

- If it was impossible to connect to the printer, be sure to set [USB Connect] under  (Main Settings) to [PictBridge].

Printing

1 MENU →  (Print) → desired mode → ● on the control button

This Image	Prints the currently displayed image in single-image mode.
Multiple Images	You can select and print multiple images. Do as following after step 2. ① Select an image then press ●. Repeat the above steps until there are no more images to be printed. ② MENU → [OK] → ●

2 Desired item → [OK] → ●

Quantity	Selects the number of copies of the specified image to be printed. • The designated number of images may not all fit onto a single sheet depending on the quantity of images.
Layout	Selects the number of images you want to print side by side on a sheet.
Size	Selects the size of the printing sheet.
Date	Selects [Date] or [Day&Time] to insert the date and time on images. • When you choose [Date], the date will be inserted in the order you select by [Date & Time Setting] of the camera. This function may not be provided depending on the printer.

Note

- Do not disconnect the cable for multi-use terminal while the  (PictBridge Connecting) indicator appears on the screen.

Printing at a shop

You can take a “Memory Stick Duo” media containing images shot with the camera to a photo printing service shop. As long as the shop supports photo printing services conforming to the DPOF, you can make a **DPOF** (Print order) mark on images in advance in viewing menu.

Notes

- You cannot print images stored in the internal memory at a print shop directly from the camera. Copy the images to a “Memory Stick Duo” media, then take the “Memory Stick Duo” media to the print shop (page 101).
- Consult your photo printing service shop as to what types of “Memory Stick Duo” media they handle.
- If a “Memory Stick Duo” media is not handled by your photo printing service shop, copy the images you want to print out to another medium such as a CD-R and take it to the shop.
- The “Memory Stick Duo” media Adaptor (sold separately) may be necessary. Consult your photo printing service shop.
- Before you take image data to a shop, always copy (back up) your data to a disk.
- You cannot set the number of prints.
- When you want to superimpose dates on images, consult your photo printing service shop.

Troubleshooting

If you experience trouble with the camera, try the following solutions.

1 Check the items on pages 126 to 134.

If a code such as “C/E:□□:□□” appears on the screen, see page 135.

2 Remove the battery pack, wait for about one minute, re-insert the battery pack, then turn on the power.

3 Initialize the settings (page 89).

4 Consult your Sony dealer or local authorized Sony service facility.

On repairing cameras with internal memory or Music files function included, data in the camera may be checked on minimum necessity to verify and improve the malfunction symptoms. Sony will not copy or save any of those data.

Additional information on this product and answers to frequently asked questions can be found at our Customer Support Website.
<http://www.sony.net/>

Click one of the following items to jump to the page explaining the symptom and cause or the appropriate corrective action.

Battery pack and power	126	Internal memory	132
Shooting still images/movies	127	Printing	132
Viewing images	129	PictBridge compliant printer	133
Deleting	130	Others	134
Computers	130	Warning indicators and messages	135
“Memory Stick Duo” media	132		

Battery pack and power

Cannot insert the battery pack.

- Insert the battery pack correctly by pushing the battery eject lever.

Cannot turn on the camera.

- After inserting the battery pack into the camera, it may take a few moments for the camera to power up.
- Insert the battery pack correctly.
- The battery pack is discharged. Insert a charged battery pack.
- The battery pack is dead (page 144). Replace it with a new one.
- Use a recommended battery pack.

The power turns off suddenly.

- Depending on the camera and battery temperature, the power may turn off automatically to protect the camera. In this case, a message is displayed on the LCD screen before the power turns off.
- If you do not operate the camera for about three minutes while the power is on, the camera turns off automatically to prevent wearing down the battery pack. Turn on the camera again.
- The battery pack is dead (page 144). Replace it with a new one.

The remaining charge indicator is incorrect.

- The battery charge will quickly get used up and the actual remaining battery charge will be lower than the indicator in the following cases:
 - When you use the camera in an extremely hot or cold location.
 - When you use the flash and zoom frequently.
 - When you repeatedly turn the power on and off.
 - When you set the screen brightness higher using DISP (screen display) settings.
- A discrepancy arose between the remaining charge indicator and the actual remaining battery charge. Fully discharge the battery pack once, then charge it to correct the indication.
- The battery pack is discharged. Insert a charged battery pack.
- The battery pack is dead (page 144). Replace it with a new one.

Cannot charge the battery pack.



- You cannot charge the battery pack using the AC Adaptor (sold separately). Use the battery charger to charge the battery.

The CHARGE lamp flashes while charging the battery.

- Remove and reinsert the battery pack, making sure it is installed correctly.
- The temperature may be inappropriate for charging. Try charging the battery pack again within the proper charging temperature range (10°C to 30°C (50°F to 86°F)).
- Refer to page 145 for details.

Shooting still images/movies

Cannot record images.

- Check the free capacity of the internal memory or “Memory Stick Duo” media. If it is full, do one of the following:
 - Delete unnecessary images (page 36).
 - Change the “Memory Stick Duo” media.
- You cannot record images while charging the flash.
- When shooting a still image, set the mode dial to other than  (Movie Mode).
- Set the mode dial to  (Movie Mode) when shooting movies.
- You can record movies with an image size of [1280×720] on “Memory Stick PRO Duo” media. When using recording media other than “Memory Stick PRO Duo” media, set the movie image size to [VGA].
- The camera is in Smile Shutter demonstration mode. Set [Demo Mode] to [Off].

Smile Shutter function does not work.

- No image is shot if a smiling face is not detected.
- [Demo Mode] is set to [On]. Set [Demo Mode] to [Off] (page 90).

The subject is not visible on the screen.

- The camera is set to the playback mode. Press  (Playback) button to switch to the shooting mode.





Anti-blur function does not work.

- The anti-blur function does not work when  appears on the display.
- The anti-blur function may not work properly when shooting night scenes.
- Shoot after pressing the shutter button halfway down; do not press it fully down suddenly.
- Confirm that the [Conversion Lens] setting is correct (page 83).

Recording takes a long time.

- When the shutter speed becomes slower than a certain speed in low light conditions, the NR (Noise Reduction) slow shutter function is activated automatically to reduce the image noise. Under such conditions, recording takes a long time.
- The Anti Blink function is working. Reset [Anti Blink] to [Off] (page 57).

The image is out of focus.

- The subject is too close. When shooting, make sure to position the lens farther away from the subject than the shortest shooting distance (approximately 2 cm (13/16 inches) (W)/90 cm (2 feet 11 1/2 inches) (T) from the lens).
-  (Advanced Sports Shooting),  (Twilight),  (Landscape) or  (Fireworks) mode is selected in the Scene Selection when shooting still images. Or when  (Advanced Sports Shooting) mode is selected in the Scene Selection mode, you will not be able to adjust the focus if the subject is too close to the camera.
- The Semi-manual function is selected. Select the auto focus mode (page 48).
- Confirm that the [Conversion Lens] setting is correct (page 83).









Zoom does not work.

- You cannot use the Smart zoom depending on the image size (page 82).
- You cannot use the digital zoom when:
 - Shooting movies
 - The Smile Shutter is working
 -  (Advanced Sports Shooting) is selected in the Scene Selection mode

Cannot select the Face Detection function.

- You can select Face Detection only when the focus mode is set to [Multi AF] and the Metering Mode is set to [Multi].





The flash does not work.

- You cannot use the flash when:
 - [REC Mode] is set to [Burst] or Exposure Bracket (page 42).
 -  (High Sensitivity),  (Advanced Sports Shooting),  (Twilight) or  (Fireworks) mode is selected in the Scene Selection.
 - Shooting movies.
- Set the flash to  (Flash On) (page 32) when the mode dial is set to “M” or the Scene Selection mode is set to  (Landscape),  (Gourmet),  (Beach) or  (Snow) mode.

Fuzzy white circular spots appear in images shot using the flash.

- Particles (dust, pollen, etc.) in the air reflected the flash light and appeared in the image. This is not a malfunction.

The close-up shoot function (Macro) does not work.

-  (Advanced Sports Shooting),  (Landscape),  (Twilight) or  (Fireworks) mode is selected in the Scene Selection.
- Macro mode is set to [Auto] when the camera is in Intelligent Auto Adjustment mode or in Movie Mode.

Macro shooting cannot be turned off.

- There is no function for forcibly turning off macro shooting. In [Auto] mode, telephoto shooting is possible even in the macro shooting condition.

The date and time are not displayed on the LCD screen.

- While shooting, the date and time are not displayed. They are displayed only during playback.

Cannot insert dates on images.

- This camera does not have a feature for superimposing dates on images. By using “PMB”, you can print or save images with the date (page 111).

The F value and shutter speed flash when you press and hold the shutter button halfway down.

- The exposure is incorrect. Correct the exposure (page 44).

The LCD screen is too dark or too bright.

- Adjust the brightness of the backlight (page 17).

The image is too dark.

- You are shooting a subject with a light source behind the subject. Select the Metering Mode (page 50) or adjust the exposure (page 44).

The image is too bright.

- Adjust the exposure (page 44).

The image colors are not correct.

- Set [Color Mode] to [Normal] (page 60).
- Adjust the White Balance (page 46).

Vertical streaks such as white, black, red or purple appear on the image, or the whole image on the screen becomes reddish when you are shooting a very bright subject.

- The smear phenomenon is occurring. This phenomenon is not a malfunction.

Noise appears in the image when you view the screen in a dark place.

- The camera is attempting to increase the visibility of the screen by temporarily brightening the image under conditions of low illumination. There is no effect on the recorded image.

The eyes of the subject come out red.

- Set [Red Eye Reduction] to [Auto] or [On] (page 58).
- Shoot the subject at a distance closer than the flash range using the flash.
- Light the room and shoot the subject.
- Retouch the image using [Retouch] → [Red Eye Correction] in viewing menu (page 72), or correct using “PMB”.

Dots appear and remain on the screen.

- This is not a malfunction. These dots are not recorded.

Cannot shoot images in succession.

- The internal memory or “Memory Stick Duo” media is full. Delete unnecessary images (page 36).
- The battery level is low. Insert charged battery pack.

The same image is shot several times.

- [REC Mode] is set to [Burst] (page 42). Or, [Scene Recognition] is set to [Advanced] (page 51).

The image taken in high-zoom is distorted.

- The image may become distorted when the weather is unstable, due to haze.
This is not a malfunction. You cannot know whether haze will occur or not while shooting. It is recommended to check the taken image by using playback zoom after shooting.

Viewing images

Cannot play back images.

- Press the  (Playback) button.
- The folder/file name has been changed on your computer.

- No guarantees are made for playing back, on this camera, files containing images which were processed on a computer or images which were shot using other cameras.
- The camera is in USB mode. Delete the USB connection (page 114).
- You may not be able to play back some images stored on the “Memory Stick Duo” media shot using other cameras. Play such images in Folder View (page 68).
- This is caused by copying images on your computer to the “Memory Stick Duo” media without using the “PMB”. Play such images in Folder View (page 68).

The date and time are not displayed.

- The screen display is set to display images only. Press the DISP (screen display) button to display information (page 17).

The image appears rough right after playback starts.

- This may happen due to image processing. This is not a malfunction.

Left and right sides of the screen are shown in black.

- [Auto Orientation] is set to [On] (page 84).

Cannot display images in index mode.

- The mode dial is set to EASY (Easy Shooting). Set the mode dial to other modes to play back images.

Cannot hear music during slideshow.

- Transfer music files to the camera with “Music Transfer” (page 116).
- Confirm that the volume setting and slideshow setting are correct (page 64).

The image does not appear on the TV.

- Check [Video Out] to see if the video output signal of the camera is set to the color system of your TV (page 92).
- Check whether the connection is correct (page 105).
- If the USB connector of the cable for multi-use terminal is connected to another device, disconnect it (page 114).
- When shooting movies in the condition with the camera and a TV connected using cable, the image being shot is not displayed in the TV side.

Deleting

Cannot delete an image.

- Cancel the protection (page 76).

Computers

Computer OS compatibility with camera is unknown.

- Check “Recommended computer environment” on page 109 for Windows, and page 117 for Macintosh.

“Memory Stick PRO Duo” media is not recognized by a computer with a “Memory Stick” media slot.

- Check that the computer and the “Memory Stick” media Reader/Writer support “Memory Stick PRO Duo” media. Users of computers and “Memory Stick” media Readers/Writers made by manufacturers other than Sony should contact those manufacturers.
- If “Memory Stick PRO Duo” media is not supported, connect the camera to the computer (pages 112 and 118). The computer recognizes the “Memory Stick PRO Duo” media.

Your computer does not recognize the camera.

- When the battery level is low, insert the charged battery pack or use the AC adaptor (sold separately).
- Set [USB Connect] to [Auto] or [Mass Storage] (page 94).
- Use the cable for multi-use terminal (supplied).
- Disconnect the cable for multi-use terminal from both the computer and the camera, and connect it again firmly.
- Disconnect all equipment other than the camera, the keyboard and the mouse from the USB connectors of your computer.
- Connect the camera directly to your computer without passing through a USB hub or other device.

Cannot import images.

- Connect the camera and your computer correctly making a USB connection (page 112).
- When you shoot images with a “Memory Stick Duo” media formatted by a computer, you may not be able to import the images to a computer. Shoot using a “Memory Stick Duo” media formatted by the camera (page 97).

After making a USB connection, “PMB” does not start automatically.

- Make the USB connection after the computer is turned on.

Cannot play back images on your computer.

- If you are using “PMB”, refer to “PMB Guide” (page 111).
- Consult the computer or software manufacturer.

The image and sound are interrupted by noise when you view a movie on a computer.

- You are playing back the movie directly from the internal memory or the “Memory Stick Duo” media. Import the movie to the hard disk of your computer, then play back the movie from the hard disk (page 112).

Cannot print an image.

- Refer to the operation manual of the printer.

Images once exported to a computer cannot be viewed on the camera.

- Export them to a folder recognized by the camera, such as “101MSDCF” (page 115).
- When using software other than “PMB”, the information may not be updated correctly, so images may turn blue or otherwise not be displayed correctly. This is not a malfunction.
- When blue images appear, view them in the Folder View mode or delete them with the camera.

“Memory Stick Duo” media

Cannot insert a “Memory Stick Duo” media.

- Insert the “Memory Stick Duo” media in the correct direction.

You have formatted a “Memory Stick Duo” media by mistake.

- All the data on the “Memory Stick Duo” media is deleted by formatting. You cannot restore it.

Internal memory

Cannot playback or record images using the internal memory.

- There is a “Memory Stick Duo” media inserted in the camera. Remove it.

Cannot copy the data stored in the internal memory to a “Memory Stick Duo” media.

- The “Memory Stick Duo” media is full. Copy to a “Memory Stick Duo” media with sufficient capacity.

Cannot copy the data on the “Memory Stick Duo” media or the computer to the internal memory.

- This feature is not available.

Printing

See “PictBridge compliant printer” together with the following items.

Images are printed with both edges cut off.

- Depending on your printer, all the edges of the image may be cut off. Especially when you print an image shot with the image size set to [16:9], the lateral end of the image may be cut off.
- When printing images using your printer, cancel the trimming or borderless settings. Consult the printer manufacturer as to whether the printer provides these functions or not.
- When having images printed at a digital print shop, ask the shop whether they can print the images without cutting off both edges.

Cannot print images with the date.

- Using “PMB”, you can print images with date (page 111).
- The camera does not have a feature for superimposing dates on images. However, because the images shot with the camera include information on the recording date, you can print images with the date superimposed if the printer or the software can recognize Exif information. For compatibility with Exif information, consult the manufacturer of the printer or the software.
- If you use a photo printing service, ask them to superimpose the dates on images.

PictBridge compliant printer

A connection cannot be established.

- The camera cannot be connected directly to a printer that is not compliant with the PictBridge standard. Consult the printer manufacturer as to whether the printer is compliant with PictBridge or not.
- Check that the printer is turned on and can be connected to the camera.
- Set [USB Connect] to [PictBridge] (page 94).
- Disconnect and connect the cable for multi-use terminal again. If an error message is indicated on the printer, refer to the operating instructions supplied with the printer.

Cannot print images.

- Check that the camera and the printer are properly connected using the cable for multi-use terminal.
- Turn on the printer. For details, refer to the operating instructions supplied with the printer.
- If you select [Exit] during printing, images may not be printed. Disconnect and connect the cable for multi-use terminal again. If you still cannot print your images, disconnect the cable for multi-use terminal, turn the printer off and then on, then connect the cable for multi-use terminal again.
- Movies cannot be printed.
- Images shot using other cameras, or images modified with a computer may not be printed.

Printing is canceled.

- Confirm that you have disconnected the cable for multi-use terminal before the  (PictBridge Connecting) mark disappears.

Cannot insert the date or print images in the index mode.

- The printer does not provide these functions. Consult the printer manufacturer as to whether the printer provides these functions or not.
- The date may not be inserted in the index mode depending on the printer. Consult the printer manufacturer.

“---- -- --” is printed on the date-inserted part of the image.

- The image does not have the recording data so the date cannot be inserted. Set [Date] to [Off] and print the image again (page 123).

Cannot select the print size.

- Consult the printer manufacturer as to whether the printer can provide the desired size.

Cannot print the image at the size selected.

- When you use paper of a different size after connecting the printer to the camera, disconnect and then reconnect the cable for multi-use terminal.
- The print setting of the camera differs from that of the printer. Change the setting of either the camera (page 123) or the printer.

Cannot operate the camera after cancelling printing.

- Wait for a while as the printer is carrying out the cancellation. It may take some time depending on the printer.

Others

The lens gets fogged.

- Moisture condensation has occurred. Turn off the camera and leave it for about an hour before using it.

The camera turns off with the lens portion extended.

- The battery pack is discharged. Replace it with a charged battery pack, then turn the camera on again.
- Do not attempt to force the lens that has stopped moving.

The camera becomes warm when you use it for a long time.

- This is not a malfunction.

The Clock Set screen appears when you turn on the camera.

- Set the date and time again (page 104).
- The internal rechargeable backup battery has discharged. Insert a charged battery, and set aside for 24 hours or more with the power left off.

You want to change the date or time.

- Change the settings by MENU → [Settings] → [Clock Settings] → [Date & Time Setting].

The date or time is incorrect.

- The Area Setting is set to a different location than your current location. Change the setting by MENU → [Settings] → [Clock Settings] → [Area Setting].

Warning indicators and messages

Self-diagnosis display

If a code starting with a letter of the alphabet appears, the self-diagnosis function on the camera is working. The last two digits (indicated by □□) will differ depending on the state of the camera.

If you cannot solve the problem even after trying the following corrective actions a few times, the camera may need repair.

Contact your Sony dealer or local authorized Sony service facility.

C:32:□□

- There is trouble with the camera's hardware. Turn the power off and on again.

C:13:□□

- The camera cannot read or write data on the "Memory Stick Duo" media. Try turning off and on the camera again, or taking out and inserting the "Memory Stick Duo" media several times.
- The internal memory has experienced a format error, or an unformatted "Memory Stick Duo" media is inserted. Format the internal memory or the "Memory Stick Duo" media (page 97).
- The inserted "Memory Stick Duo" media cannot be used with the camera, or the data is damaged. Insert a new "Memory Stick Duo" media.

E:61:□□

E:62:□□

E:91:□□

- A camera malfunction has occurred. Initialize the camera (page 89), then turn the power on again.

Messages

If the following messages appear, follow the instructions.



- The battery level is low. Charge the battery pack immediately. Depending on the conditions of use or the type of battery pack, the indicator may flash even though there are still 5 to 10 minutes of remaining battery time left.

For use with compatible battery only

- The battery inserted is not an NP-BG1 (supplied)/NP-FG1 (sold separately) battery pack.

System error

- Turn the power off and then on again.

Camera overheating

Allow it to cool

- The camera temperature has risen. The power may turn off automatically, or you may be unable to record movies. Leave the camera in a cool location until the temperature drops.

Internal memory error

- Turn the power off and then on again.

Reinsert the “Memory Stick”

- Insert the “Memory Stick Duo” media correctly.
- The inserted “Memory Stick Duo” media cannot be used in the camera (page 142).
- The “Memory Stick Duo” media is damaged.
- The terminal section of the “Memory Stick Duo” media is dirty.

“Memory Stick” type error

- The inserted “Memory Stick Duo” media cannot be used in the camera (page 142).

This “Memory Stick” may not record or play

- The inserted “Memory Stick Duo” media cannot be used in the camera (page 142).

Cannot access “Memory Stick”

Access denied

- You are using the “Memory Stick Duo” media with the access controlled.

Error formatting internal memory

Error formatting “Memory Stick”

- Format the media again (page 97).

“Memory Stick” locked

- You are using the “Memory Stick Duo” media with the write-protect switch, and the switch is set to the LOCK position. Set the switch to the recording position.

No memory space on “Memory Stick”

No memory space on internal memory

- Delete unnecessary images or files (page 36).

Read only “Memory Stick”

- The camera cannot record or delete images on this “Memory Stick Duo” media.

No images

- No images that can be played back have been recorded in the internal memory.
- No images that can be played back have been recorded in this folder of the “Memory Stick Duo” media.
- When images recorded with other cameras cannot be played back on this camera, view the images in Folder View mode (page 68).

No still images

- The selected folder does not contain a file that can be played back in a slideshow.
- There are no images that can be filtered by faces.

File found which was not recognized

- You tried to delete a folder containing a file that cannot be played on this camera. Delete the file with a computer and then delete the folder.

Invalid operation

- You tried to delete an image or movie being played with the View Mode set to Favorites. Be sure to change to another View Mode as deletions are not allowed when the View Mode is set to Favorites.

Self-Timer is invalid

- The Self-Timer is unavailable under these settings.

Folder error

- A folder with the same first three digit number already exists on the “Memory Stick Duo” media (for example: 123MSDCF and 123ABCDE). Select another folder, or create a new folder (pages 98, 99).

Cannot create more folders

- The folder with a name beginning with “999” exists on the “Memory Stick Duo” media. You cannot create any folders if this is the case.

Empty folder contents

- You tried to delete a folder containing one or more files. Delete all of the files and then delete the folder.

No folder

- You tried to delete a folder that does not exist.

Folder protected

- You tried to delete a read-only folder that was made by PC or an other device.

File error

- An error occurred while the image was playing back.
No guarantees are made for playing back, on this camera, files containing images which were processed on a computer or images which were shot using other cameras.

Read only folder

- You have selected a folder that cannot be set as a recording folder on the camera. Select another folder (page 99).

File protected

- Release the protection (page 76).

Image size over limit

- You are playing back an image with size that cannot be played back on the camera.

Unable to detect face for retouch

- You may not be able to retouch the image depending on the image.

(Vibration warning indicator)

- Camera shake may occur due to insufficient light. Use the flash, turn on the anti-blur function, or mount the camera on a tripod to secure the camera.

1280×720 (Fine) is not available

1280×720 (Standard) is not available

- [1280×720] size movies can be recorded only using a “Memory Stick PRO Duo” media. Insert a “Memory Stick PRO Duo” media or set the image size to a size [VGA].

Turn the power off and on again

- The lens malfunction.

Maximum number of images already selected

- Up to 100 files can be selected when using [Multiple Images].
- Up to 999 files can be selected when using [All in Date Range], [All in Event], [All in Favorites] or [All in This Folder].
- Up to 999 files can be registered as Favorites images, and you can add **DPOF** (Print order) marks to up to 999 files. Cancel the selection.

Low battery power

- When copying a image recorded in the internal memory to the “Memory Stick Duo” media, use a fully charged battery.

Printer busy

Paper error

No paper

Ink error

Low ink

No ink

- Check the printer.

Printer error

- Check the printer.
- Check if the image you want to print is corrupted.



- The data transmission to the printer may not be completed yet. Do not disconnect the cable for multi-use terminal.

Processing...

- The printer is canceling the current print job. You cannot print until it is finished. This may take time, depending on the printer.

Error Playing Music

- Delete the Music file, or replace it with an uncorrupted Music file.
- Execute [Format Music], then download a new Music files.

Error Formatting Music

- Execute [Format Music].

Operation cannot be executed for movie files

- You have selected a function that is not available for movies.

Operation cannot be executed in unsupported files

- Processing and other editing functions of the camera cannot be performed on image files that have been processed using a computer or images that were recorded with other cameras.

Operation cannot be executed when using a PictBridge connection

- Some functions are restricted while the camera is connected to a PictBridge compliant printer.

Recovering image management file...

- The camera restores the date information etc. in cases where images have been deleted on a PC, etc.



- The number of images exceeds that for which date or event management by the camera is possible. Delete images from the Date View or Event View.

No internal memory space remaining

Delete images?

- The internal memory is full. To record to the internal memory, select [Yes] and delete unwanted images.

Image management file error

Cannot recover

- Import all of the images to the computer with “PMB”, and format the “Memory Stick Duo” media or the internal memory (page 97).

When you cannot import all of the images to the computer with “PMB”, import all of the images to the computer without using “PMB” (page 113).

To view the images again with the camera, export the imported images to the camera with “PMB”.

Recording function unavailable due to high internal temperature

- The camera temperature has risen. You cannot record images until the temperature has dropped.

Recording has stopped due to increased camera temperature

- Recording has stopped due to a rise in temperature while recording a movie. Please wait until the temperature goes down.



- When you record movies for a long time, the camera temperature rises. In this case, stop recording movies.

Using the camera abroad — Power sources

You can use the camera, the battery charger (supplied), and the AC-LS5K AC Adaptor (sold separately) in any country or region where the power supply is within 100 V to 240 V AC, 50 Hz/60 Hz.

Note

- Do not use an electronic transformer (travel converter), as this may cause a malfunction.

Table of
contents

Operation
Search

MENU/Settings
Search

Index

On the “Memory Stick Duo” media

A “Memory Stick Duo” media is a compact, portable IC recording medium. The types of “Memory Stick Duo” media that can be used with the camera are listed in the table below. However, proper operation cannot be guaranteed for all “Memory Stick Duo” media functions.

“Memory Stick” media type	Recording/Playback
Memory Stick Duo (without MagicGate)	○*1
Memory Stick Duo (with MagicGate)	○*2
MagicGate Memory Stick Duo	○*1*2
Memory Stick PRO Duo	○*2*3
Memory Stick PRO-HG Duo	○*2*3*4

*1 High-speed data transfer using a parallel interface is not supported.

*2 “Memory Stick Duo” media, “MagicGate Memory Stick Duo” media and “Memory Stick PRO Duo” media are equipped with MagicGate functions. MagicGate is copyright protection technology that uses encryption technology. Data recording/playback that requires MagicGate functions cannot be performed with the camera.

*3 [1280×720] size movies can be recorded.

*4 This camera does not support 8-bit parallel data transfer. It performs the same 4-bit parallel data transfer as the “Memory Stick PRO Duo” media.

Notes

- This product is compatible with “Memory Stick Micro” media (“M2”). “M2” is an abbreviation for “Memory Stick Micro” media.
- A “Memory Stick Duo” media formatted with a computer is not guaranteed to operate with the camera.
- Data read/write speeds differ depending on the combination of the “Memory Stick Duo” media and the equipment used.
- Do not remove the “Memory Stick Duo” media while reading or writing data.
- Data may be corrupted in the following cases:
 - When the “Memory Stick Duo” media is removed or the camera is turned off during a read or write operation
 - When the “Memory Stick Duo” media is used in locations subject to static electricity or electrical noise
- We recommend backing up important data.
- Do not press down hard when you write down on the memo area.
- Do not attach a label on the “Memory Stick Duo” media itself nor on a “Memory Stick Duo” media Adaptor.
- When you carry or store the “Memory Stick Duo” media, put it in the case supplied with it.
- Do not touch the terminal section of the “Memory Stick Duo” media with your hand or a metal object.
- Do not strike, bend or drop the “Memory Stick Duo” media.
- Do not disassemble or modify the “Memory Stick Duo” media.
- Do not expose the “Memory Stick Duo” media to water.
- Do not leave the “Memory Stick Duo” media within the reach of small children. They might accidentally swallow it.
- Do not insert anything other than a “Memory Stick Duo” media into the “Memory Stick Duo” media slot. Doing so will cause a malfunction.
- Do not use or store the “Memory Stick Duo” media under the following conditions:
 - High temperature locations such as the hot interior of a car parked in direct sunlight
 - Locations exposed to direct sunlight
 - Humid locations or locations with corrosive substances present

Notes on using the “Memory Stick Duo” media Adaptor (sold separately)

- To use a “Memory Stick Duo” media with a “Memory Stick” media compliant device, be sure to insert the “Memory Stick Duo” media into a “Memory Stick Duo” media Adaptor. If you insert a “Memory Stick Duo” media into a “Memory Stick” media compliant device without a “Memory Stick Duo” media Adaptor, you might not be able to remove it from the device.
- When inserting a “Memory Stick Duo” media into a “Memory Stick Duo” media Adaptor, make sure the “Memory Stick Duo” media is inserted facing in the correct direction, then insert it all the way in. Incorrect insertion may result in a malfunction.
- When using a “Memory Stick Duo” media inserted into a “Memory Stick Duo” media Adaptor with a “Memory Stick” media compliant device, make sure that the “Memory Stick Duo” media Adaptor is inserted facing the correct direction. Note that improper use may damage the equipment.
- Do not insert a “Memory Stick Duo” media Adaptor into a “Memory Stick” media compliant device without a “Memory Stick Duo” media attached. Doing so may result in malfunction of the unit.

Notes on using “Memory Stick PRO Duo” media (sold separately)

“Memory Stick PRO Duo” media with a capacity up to 16 GB have been confirmed to operate properly with the camera.

Notes on using “Memory Stick Micro” media (sold separately)

- To use a “Memory Stick Micro” media with the camera, be sure to insert the “Memory Stick Micro” media into an “M2” Adaptor as large as of Duo size. If you insert a “Memory Stick Micro” media into the camera without an “M2” Adaptor as large as of Duo size, you might not be able to remove it from the camera.
- Do not leave the “Memory Stick Micro” media within the reach of small children. They might accidentally swallow it.

On the battery pack

On charging the battery pack

We recommend charging the battery pack in an ambient temperature of between 10°C to 30°C (50°F to 86°F). The battery pack may not be effectively charged in temperatures outside this range.

Effective use of the battery pack

- Battery performance decreases in low temperature surroundings. So in cold places, the operational time of the battery pack is shorter. We recommend the following to ensure longer battery pack use:
 - Put the battery pack in a pocket close to your body to warm it up, and insert it in the camera immediately before you start shooting.
- The battery pack will run out quickly if you use the flash or zoom frequently.
- We recommend having spare battery packs handy for two or three times the expected shooting time, and making trial shots before taking the actual shots.
- Do not expose the battery pack to water. The battery pack is not water-resistant.
- Do not leave the battery pack in extremely hot places, such as in a car or under direct sunlight.

How to store the battery pack

- Fully discharge the battery pack before storing and store it in a cool, dry place. To maintain the battery pack's function, fully charge the battery pack and then fully discharge it on the camera at least once a year while storing.
- To use the battery pack up, leave the camera in slideshow playback mode until the power goes off.
- To prevent staining the terminal, short-circuiting, etc., be sure to use a supplied battery case when carrying and storing.

On battery life

- The battery life is limited. Battery capacity decreases over time and through repeated use. If decreased usage time between charges becomes significant, it is probably time to replace it with a new one.
- The battery life varies according to how it is stored and the operating conditions and environment in which each battery pack is used.

Compatible battery pack

- The NP-BG1 (supplied) can be used only in G type compatible Cyber-shot models.
- If you use the NP-FG1 battery pack (sold separately), the minutes also appear after the battery remaining indicator ( 60 Min).

On the battery charger

- Only NP-BG type or NP-FG type battery packs (and no others) can be charged in the battery charger (supplied). Batteries other than the specified kind may leak, overheat, or explode if you attempt to charge them, posing a risk of injury from electrocution and burns.
- Remove the charged battery pack from the battery charger. If you leave the charged battery pack in the charger, battery life may be shortened.
- The CHARGE lamp of the supplied battery charger flashes in either way:
 - Fast flashing: Turns the light on and off repeatedly at the interval of 0.15 seconds.
 - Slow flashing: Turns the light on and off repeatedly at the interval of 1.5 seconds.
- When the CHARGE lamp flashes fast, remove the battery pack being charged, and then insert the same battery pack into the battery charger securely again. When the CHARGE lamp flashes fast again, this may indicate a battery error or that a battery pack other than the specified type has been inserted. Check that the battery pack is the specified type. If the battery pack is the specified type, remove the battery pack, replace it with a new one or another one and check if the battery charger operates correctly. If the battery charger operates correctly, a battery error may have occurred.
- When the CHARGE lamp flashes slowly, it indicates that the battery charger stops charging temporarily on standby. The battery charger stops charging and enters the standby status automatically when the temperature is outside of the recommended operating temperature. When the temperature gets back within the appropriate range, the battery charger resumes charging and the CHARGE lamp lights up again. We recommend charging the battery pack in an ambient temperature of between 10°C to 30°C (50°F to 86°F).

Index

A

Add / Remove Favorites	71
Adjusting EV	44
AF Illuminator	80
AF range finder frame	48
Anti Blink	52, 57
Aperture	44
Area Setting	103
Auto Orientation	84
Auto Review	85

B

Battery charger	145
Battery pack	144
Beach	21
Beep	86
BRK	43
Burst	42

C

Center AF	48
Center-weighted metering	50
Change REC.Folder	99
Changing the display	17
Clock Settings	104
Color Mode	60
COMPONENT	91
Computer	108
Importing images	113, 118
Macintosh	117
Recommended environment	109, 117
Windows	108
Connecting	
Computer	112
Printer	122
TV	105
Contrast	61
Conversion Lens	83
Copy	101
Create REC.Folder	98
Cross Filter	73

D

Date	123
Date & Time Setting	104
Date List	66
Delete	36, 75
Delete REC.Folder	100
Demo mode	90
Digital Zoom	82
DISP	17
Download Music	95
DRO	59

E

Easy Shooting	23
Easy Viewing mode	24
Electronic transformer	141
EV	44
Event List	67
Exporting images	114
Exposure	44
Exposure Bracket	43

F

Face Detection	54
Face registration	55
File Number	102
Filter by Faces	70
Fireworks	21
Fisheye Lens	73
Flash Level	56
Flash	32, 41
Focus	48
Folder	
Changing	99
Creating	98
Deleting	100
Selecting	78
Format Music	96
Format	97
Function Guide	88

G

Gourmet	21
---------------	----

Grid Line 81

H

Happy Faces 73

HD(1080i) 91

High Sensitivity 21

Histogram 18

I

Identifying parts 15

Image Index 35

Image Size 39

Initialize 89

Install 110

Intelligent Auto Adjustment 20

Internal memory 19

ISO 44, 45

L

Landscape 21

Language Setting 87

LCD Screen 17

M

Macintosh computer 117

Macro 31

Manual Exposure Shooting 26

Mass Storage 94

“Memory Stick Duo” media 142

MENU 10

Menu screen 10

Metering Mode 50

Mode dial 16

Movie Mode 27

Movie shooting mode 38

MTP 94

Multi AF 48

Multi connector 105, 112, 118, 122

Multi-pattern metering 50

Multi-Purpose Resize 74

Music Transfer 116, 119

N

NTSC 92

O

Optical zoom 29, 82

OS 109, 117

P

PAL 92

Partial Color 73

PC 108

PictBridge 94, 122

Pixel 40

Playback 33

Playback zoom 34

PMB 111

Precision digital zoom 82

Print 77, 121

Print order mark 124

Printing directly 122

Program Auto 25

Protect 76

PTP 94

R

Radial Blur 73

REC Mode 42

Red Eye Correction 72

Red Eye Reduction 58

Retouch 72

Retro 73

Rotate 79

S

Scene Recognition 51

Scene Selection 21

Screen 17

SD 91

Select Folder 78

Self-diagnosis display 135

Self-Timer 30

Semi-manual 48

Settings 13

Sharpness 62

Shooting

 Movie 27

 Still image 20

Shutter speed 44

Slideshow 64

Slow Synchro (Flash On).....	32
Smart zoom	82
Smile Detection Sensitivity.....	53
Smile Shutter.....	28
Snow.....	21
Soft Focus	72
Soft Snap.....	21
Software.....	110, 111, 116
Spot AF.....	48
Spot metering	50
SteadyShot.....	63

T

Trimming	72
Troubleshooting	125
TV	105
Twilight.....	21
Twilight Portrait.....	21

U

Unsharp masking	72
USB Connect.....	94
Using the camera abroad.....	141

V

VGA	39
Video Out.....	92
View Mode.....	68

W

Warning indicators and messages	135
White Balance.....	46
Wide Zoom Display	93
Windows computer.....	108

Z

Zoom.....	29
-----------	----

Notes on the License

“C Library”, “Expat” and “zlib” software are provided in the camera. We provide this software based on license agreements with their owners of copyright. Based on requests by the owners of copyright of these software applications, we have an obligation to inform you of the following. Please read the following sections.

Read “license1.pdf” in the “License” folder on the CD-ROM. You will find licenses (in English) of “C Library”, “Expat” and “zlib” software.

THIS PRODUCT IS LICENSED UNDER THE MPEG-4 VISUAL PATENT PORTFOLIO LICENSE FOR THE PERSONAL AND NON-COMMERCIAL USE OF A CONSUMER FOR

(i) ENCODING VIDEO IN COMPLIANCE WITH THE MPEG-4 VISUAL STANDARD (“MPEG-4 VIDEO”)

AND/OR

(ii) DECODING MPEG-4 VIDEO THAT WAS ENCODED BY A CONSUMER ENGAGED IN A PERSONAL AND NON-COMMERCIAL ACTIVITY AND/OR WAS OBTAINED FROM A VIDEO PROVIDER LICENSED BY MPEG LA TO PROVIDE MPEG-4 VIDEO.

NO LICENSE IS GRANTED OR SHALL BE IMPLIED FOR ANY OTHER USE. ADDITIONAL INFORMATION INCLUDING THAT RELATING TO PROMOTIONAL, INTERNAL AND COMMERCIAL USES AND LICENSING MAY BE OBTAINED FROM MPEG LA, LLC. SEE [HTTP://WWW.MPEGLA.COM](http://www.mpegla.com)

On GNU GPL/LGPL applied software

The software that is eligible for the following GNU General Public License (hereinafter referred to as “GPL”) or GNU Lesser General Public License (hereinafter referred to as “LGPL”) are included in the camera.

This informs you that you have a right to have access to, modify, and redistribute source code for these software programs under the conditions of the supplied GPL/LGPL.

Source code is provided on the web. Use the following URL to download it.

<http://www.sony.net/Products/Linux/>

We would prefer you do not contact us about the contents of source code.

Read “license2.pdf” in the “License” folder on the CD-ROM. You will find licenses (in English) of “GPL”, and “LGPL” software.

To view the PDF, Adobe Reader is needed. If it is not installed on your computer, you can download it from the Adobe Systems web page:

<http://www.adobe.com/>

Regarding the license for “Music Transfer” included on the CD-ROM (supplied)

MPEG Layer-3 audio coding technology and patents licensed from Fraunhofer IIS and Thomson.