



ZQ300 Series



Mobile Printers

User Guide

Table of Contents

Proprietary Statements	4
Document Conventions	6
Introduction to the ZQ300 Series	7
Unpacking and Inspection	8
Reporting Damage	8
ZQ300 Series Technology	9
PowerPrecision+ Battery	9
Direct Thermal Printing	10
Thermal Shutdown	10
Near Field Communications (NFC)	10
QR Code	11
Made for iPhone (MFi)	11
Features Overview	12
Getting Ready to Print	13
Battery.....	13
Installing/Removing Battery & Battery Tape Insulator	13
Battery Tape Insulator.....	14
Battery Safety.....	16
Charger Safety.....	16
Charging the Battery	17
AC-to-USB Adapter	17
1-Slot Battery Charger	18
3-Slot Battery Charger	19
Charging Temperature	19
1-Bay Docking Cradle	20
5-Bay Docking Cradle	21
Vehicle Adapter	22
ZQ300 Series Media	23
Designing Labels	24
Using Pre-Printed Receipt Media	25
Loading the Media	30
Media Spacers.....	31
Operator Controls	32
Forced Download Description and LED Behavior	37
Power Save Mode	39
Draft Mode.....	39
Verify the Printer Is Working	40
Cable Communication.....	41
Wireless Communications with Bluetooth.....	44
Bluetooth Networking Overview	44
NFC Use Cases	47
WLAN Overview	48
Setting Up the Software	49
Wearing the Printer	50
Belt Clip.....	50
Adjustable Shoulder Strap.....	51
Soft Case.....	52
Preventive Maintenance	53
Extending Battery Life	53

continued

General Cleaning Instructions	53
ZQ300 Series Cleaning.....	54
Troubleshooting.....	56
Printer Status Indicators	56
Troubleshooting Topics	56
Troubleshooting Tests	58
Printing a Configuration Report.....	58
Communications Diagnostics.....	58
Calling Technical Support.....	59
Specifications.....	63
Printing Specifications	63
Memory and Communications Specifications.....	63
Media Specifications.....	63
ZPL Bar Code Specifications and Commands	64
CPCL and ZPL Font Specifications	65
Printing in Chinese Fonts	67
USB Type-C to Type-A Communications Cable.....	69
Physical, Environmental and Electrical Specifications	70
ZQ300 Series Accessories	73
Appendix A.....	74
Serial Number and PCC Number Locations.....	74
Appendix B.....	75
User Interface LED Charging Behavior.....	75
Appendix C.....	76
Battery Disposal	76
Product Disposal	76
Appendix D.....	77
Appendix E.....	78
Using Zebra.com.....	78
Product Support Contacts	80
Index.....	81

Proprietary Statements

This manual contains proprietary information of Zebra Technologies Corporation. It is intended solely for the information and use of parties operating and maintaining the equipment described herein. Such proprietary information may not be used, reproduced, or disclosed to any other parties for any other purpose without the expressed written permission of Zebra Technologies Corporation.

Product Improvements

Since continuous product improvement is a policy of Zebra Technologies Corporation, all specifications and signs are subject to change without notice.

Agency Approvals and Regulatory Information

- Design certified by TUV
- Canadian IC RSS-247
- EN60950: Safety Standard
- C-Tick (Australia)
- FCC part 15 Class B
- EN55024: European Immunity Standard
- NOM (Mexico)
- EN55032: Class B European Electromagnetic Radiation Standard

Liability Disclaimer

Inasmuch as every effort has been made to supply accurate information in this manual, Zebra Technologies Corporation is not liable for any erroneous information or omissions. Zebra Technologies Corporation reserves the right to correct any such errors and disclaims liability resulting therefrom.

No Liability for Consequential Damage

In no event shall Zebra Technologies Corporation or anyone else involved in the creation, production, or delivery of the accompanying product (including hardware and software) be liable for any damages whatsoever (including, without limitation, damages for loss of business profits, business interruption, loss of business information, or other pecuniary loss) arising out of the use of or the results of use of or inability to use such product, even if Zebra Technologies Corporation has been advised of the possibility of such damages. Because some states do not allow the exclusion of liability for consequential or incidental damages, the above limitation may not apply to you.

Copyrights

The copyrights in this manual and the label print engine described therein are owned by Zebra Technologies Corporation. Unauthorized reproduction of this manual or the software in the label print engine may result in imprisonment of up to one year and fines of up to \$10,000 (17 U.S.C.506). Copyright violators may be subject to civil liability.

This product may contain ZPL®, ZPL II®, and ZebraLink™ programs; Element Energy Equalizer® Circuit; E3®; and AGFA fonts. Software © ZIH Corp. All rights reserved worldwide.

ZebraLink and all product names and numbers are trademarks, and Zebra, the Zebra logo, ZPL, ZPL II, Element Energy Equalizer Circuit, and E3 Circuit are registered trademarks of ZIH Corp. All rights reserved worldwide.

Monotype®, Intellifont® and UFST® are trademarks of Monotype Imaging, Inc. registered in the United States Patent and Trademark Office and may be registered in certain jurisdictions.

Andy™, CG Palacio™, CG Century Schoolbook™, CG Triumvirate™, CG Times™, Monotype Kai™, Monotype Mincho™ and Monotype Sung™ are trademarks of Monotype Imaging, Inc. and may be registered in some jurisdictions.

HY Gothic Hangul™ is a trademark of Hanyang Systems, Inc.

Angsana™ is a trademark of Unity Progress Company (UPC) Limited.

Andale®, Arial®, Book Antiqua®, Corsiva®, Gill Sans®, Sorts® and Times New Roman® are trademarks of The Monotype Corporation registered in the United States Patent and Trademark Office and may be registered in certain jurisdictions.

Century Gothic™, Bookman Old Style™ and Century Schoolbook™ are trademarks of The Monotype Corporation and may be registered in certain jurisdictions.

HGPGothicB is a trademark of the Ricoh company, Ltd. and may be registered in some jurisdictions.

continued

Univers™ is a trademark of Heidelberger Druckmaschinen AG, which may be registered in certain jurisdictions, exclusively licensed through Linotype Library GmbH, a wholly owned subsidiary of Heidelberger Druckmaschinen AG.

Futura® is a trademark of Bauer Types SA registered in the United States Patent and Trademark Office and may be registered in some jurisdictions.

TrueType® is a trademark of Apple Computer, Inc. registered in the United States Patent and Trademark Office and may be registered in certain jurisdictions.

All other product names are the property of their respective owners.

© 1996–2009, QNX Software Systems GmbH & Co. KG. All rights reserved. Published under license by QNX Software Systems Co.

Bluetooth® is a registered trademark of the Bluetooth SIG

All other brand names, product names, or trademarks belong to their respective holders.
©2017 ZIH Corp.

Works with:



Certified by:



Document Conventions

The following conventions are used throughout this document to convey certain information:

If you are viewing this guide online, click the underlined text to jump to a related Web site. Click on italic text (not underlined) to jump to that location in this manual.

Cautions, Important, and Note



Caution • Warns you of the potential for electrostatic discharge.



Caution • Warns you of a potential electric shock situation.



Caution • Warns you of a situation where excessive heat could cause a burn



Caution • Advises you that failure to take or avoid a specific action could result in physical harm to you.



Caution • Advises you that failure to take or avoid a specific action could result in physical harm to the hardware.



Important • Advises you of information that is essential to complete a task.



Note • Indicates neutral or positive information that emphasizes or supplements important points of the main text.

Introduction to the ZQ300 Series

This user guide gives you the information you will need to operate the ZQ320 and ZQ310 printers. These printers feature different models for various vertical markets; one for Transportation & Logistics (T&L)/Manufacturing/Government, and one specifically for Retail. They use some of the latest technologies such as Bluetooth BR/EDR, LE 4.0, WLAN: 802.11ac, USB charging (Type-C connector), Near Field Communication (NFC), and Made for iPhone® (MFi). MFi printers provide Apple co-processor (MFi) support which allows an Apple device such as an iPhone or iPad® to authenticate and connect over Bluetooth®. They also share charging capabilities with Zebra's Mobile Computers for better synergy and a total solution package.



	ZQ320		ZQ310	
	Outdoor	Indoor	Outdoor	Indoor
Color	Black	Silver & Black	Black	Silver & Black
Connectivity	Bluetooth (BR/EDR,LE 4.0)	Dual Radio (802.11ac + BT BR/EDR LE 4.0)	Bluetooth (BR/EDR,LE 4.0)	Dual Radio (802.11ac + BT BR/EDR LE 4.0)
Output	Receipts, Linerless Labels	Receipts, Labels, Linerless Labels	Receipts, Linerless Labels	Receipts, Labels, Linerless Labels
Sensors	Media Out, Black Bar, Media Door Open	Gap, Black Bar, Media Out, Media Door Open	Media Out, Black Bar, Media Door Open	Gap, Black Bar, Media Out, Media Door Open
Programming Languages	CPCL,ZPL	CPCL,ZPL	CPCL,ZPL	CPCL,ZPL

ZQ300 Series Software Utilities:

- Zebra Net Bridge™ : printer configuration, fleet management
- Zebra Setup Utility: single printer configuration, quick setup
- Zebra Mobile Setup Utility: Android-based setup tool
- Zebra Designer Pro: label design
- Zebra Designer Drivers: Windows® driver
- OPOS Driver: Windows driver
- Multiplatform SDK
- Zebra Downloader

(These utilities can be found <https://www.zebra.com/us/en/products/software/barcode-printers/zebralink.html>)

Unpacking and Inspection

- Check all exterior surfaces for damage.
- Open the media cover (refer to “Loading the Media” in the Getting Ready to Print section) and inspect the media compartment for damage.

In case shipping is required, save the carton and all packing material.



Reporting Damage

If you discover shipping damage:

- Immediately notify and file a damage report with the shipping company. Zebra Technologies Corporation is not responsible for any damage incurred during shipment of the printer and will not cover the repair of this damage under its warranty policy.
- Keep the carton and all packing material for inspection.
- Notify your authorized Zebra re-seller.

ZQ300 Series Technology

The ZQ300 Series printers use several technologies unique to this line and/or made popular in other Zebra Mobile printer lines.

PowerPrecision+ (PP+) Battery

The ZQ300 Series printers use a 2-cell Li-Ion battery pack with integrated intelligence and data storage capability meeting PowerPrecision+ (PP+) functionality. This intelligent battery has the integrated technology required to collect the detailed real-time battery metrics needed to maximize useful battery life and ensure every battery is healthy and able to hold a full charge.

In addition, technology inside the batteries tracks and maintains the metrics required to provide real-time visibility into more meaningful battery statistics, such as total cycle usage of the battery, whether the battery is old and should be retired or how long a battery will take to fully charge.

Operating Temperature	Charging Temperature	Storage Temperature
-15° C to 65° C (5° F to 149° F)	0° C to 40° C (32° F to 113° F)	-25° C to 65° C (-13° F to 149° F)

Battery Status UI Indicators (Printer ON)

	Status	Display
Healthy	Charging	Solid Amber
	Charge Fault	Fast Blinking Red (2 blinks/second)
	Charge Complete	Solid Green
Unhealthy	Charging	Solid Red
	Charge Fault	Fast Blinking Red (2 blinks/second)
	Charge Complete	Solid Red



Note • Power down the printer before removing the battery to minimize the risk of corruption.



Important • The ZQ310 and ZQ320 printers will only function properly with genuine Zebra PowerPrecision+ battery packs.

Direct Thermal Printing

The ZQ300 Series printers use the Direct Thermal printing method to print human readable text, graphics and barcodes. It incorporates a sophisticated print engine for optimal printing under all operational conditions. Direct thermal printing uses heat to cause a chemical reaction on specially treated media. This reaction creates a dark mark wherever a heated element on the printhead comes in contact with the media. Since the printing elements are arranged very densely at 203 d.p.i. (dots per inch) horizontal and 200 d.p.i. vertical, highly legible characters and graphic elements may be created a row at a time as the media is advanced past the printhead.

This technology has the advantage of simplicity, as there is no requirement for consumable supplies such as ink or toner. However, since the media is sensitive to heat, it will gradually lose legibility over long periods of time, especially if exposed to environments with relatively high temperatures.

Thermal Shutdown

The ZQ300 Series printers have a thermal shutdown feature—whereby the printer hardware will detect a printhead over-temperature condition at 70°C (158°F). If this condition occurs, there is a chance that label data will be lost. The printer will automatically stop printing until the printhead cools down to 62°C (144°F). Printing will then recommence without a loss of label data or without any degradation of print quality.

Near Field Communication (Passive NFC)

The ZQ300 Series printers support a passive NFC tag which complies with the “Android Standard Tag format” since Android devices are the most common found on the market today. The NFC tag is programmed from the factory and supports Bluetooth pairing to enable a tablet, smartphone or terminal to automatically pair with the printer via a Bluetooth connection (within the bounds of the security profile being used).

The NFC tag also supports app launching whereby an app developed either by Zebra or a third party will launch on a NFC-enabled smartphone, tablet or terminal. Similarly, the NFC tag enables launching to a web support page via a tablet, smartphone or terminal.

QR Code

The QR barcode includes human readable text (URL) which links the user to printer information and short videos on topics such as buying supplies, features overview, loading media, printing a configuration report, cleaning instructions, and accessory information. This barcode is located on the bottom of the printer as shown below.

Figure 1 • QR Code (ZQ320 Shown).

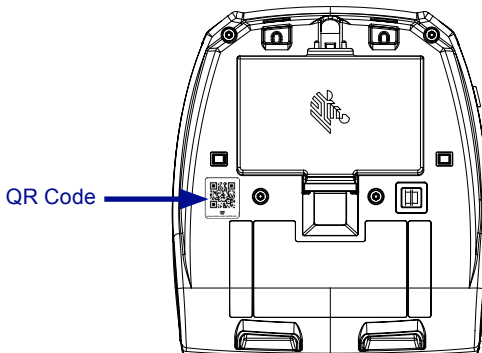

Made for iPhone (MFi)

ZQ300 Series printers support communication with Apple devices running iOS 5 or later over a standalone Bluetooth 4.0 radio and the BT3.0 radio included with the 802.11n (dual) radio.



Features Overview

Figure 2 • Overview of Features (ZQ320 Shown).

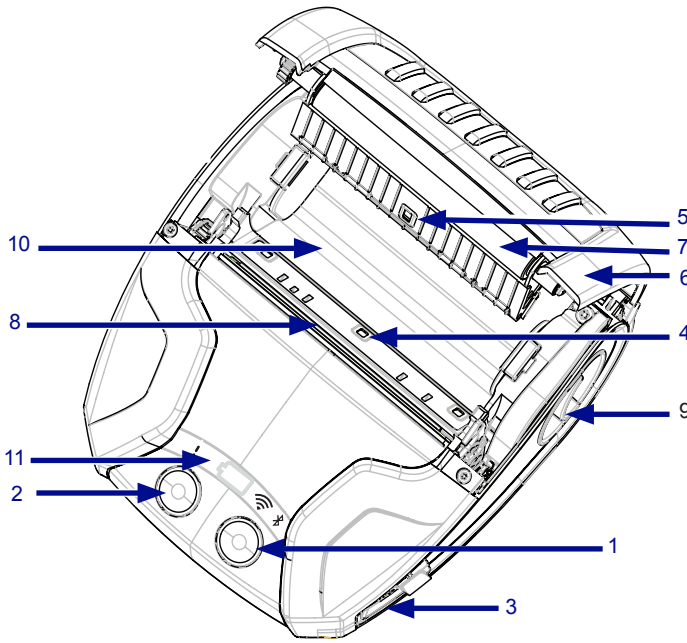

Note • Tapping the Zebra Print Touch™ icon with a Near Field Communication (NFC) enabled smartphone will provide instant access to printer-specific information. For more information about NFC and Zebra products, go to <http://www.zebra.com/nfc>. Bluetooth pairing applications via NFC is also possible. Please see Zebra Multi-platform SDK for more information.

1	Paper Feed Button
2	Power Button
3	USB Power Port
4	Media Sensor
5	Black Bar/Gap Sensor (Retail Only)
6	Media Cover
7	Platen
8	Printhead
9	Latch Release Button
10	Media Compartment
11	User Interface Indicators
12	Battery Pack
13	Print Touch (NFC) Icon
14	Belt Clip
15	QR Code

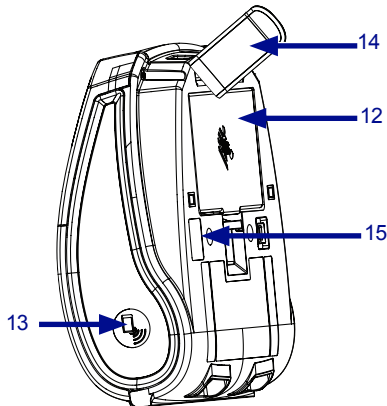

Getting Ready to Print

Battery

Installing/Removing Battery & Battery Tape Insulator

! Important • Batteries are shipped in sleep mode to preserve their maximum capacity while in storage prior to initial use. Plug in the AC-to-USB Adapter with the Type-C USB cable that ships with the printer, or insert the battery in the 1-Slot or 3-Slot battery charger to wake it up prior to using it for the first time. These are optional accessories available for purchase. See Page 73 for part numbers to be used for ordering.

Figure 3 • Removing the Battery Pack.

1. If a belt clip is present on the bottom of the printer, rotate it such that it provides clearance for the battery.

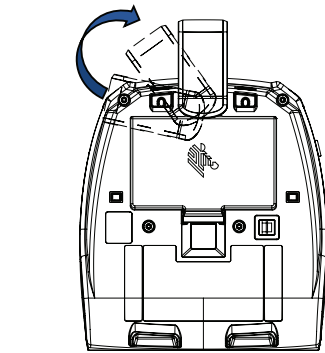
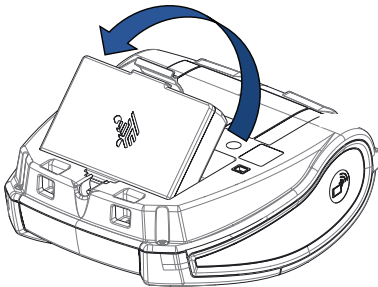

2. Depress the clip on the battery pack and rotate the battery away from the battery well.

3. Lift the battery up and out of the printer.

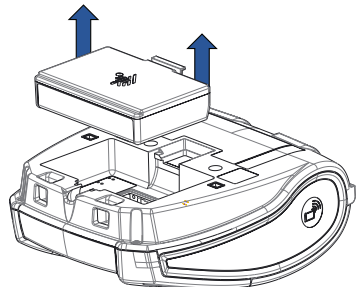

Battery Tape Insulator

The ZQ300 Series battery is installed in the printer during shipping and is protected by a battery tape insulator. The tape insulator covers the battery contacts and provides a layer of separation from the contacts located in the battery well. The tape insulator should be removed upon removal of the battery pack as shown below.

Figure 4 • Removing the Battery Tape Insulator.

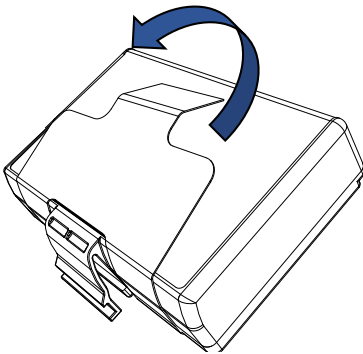
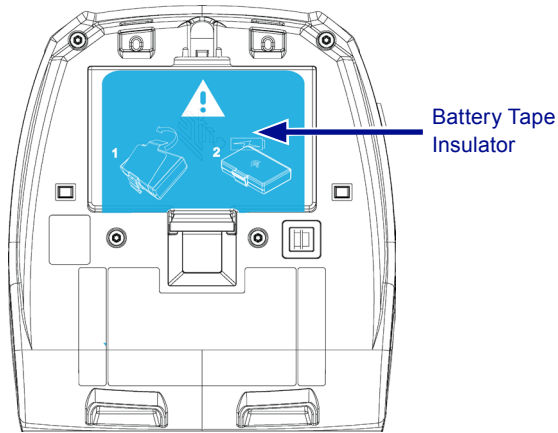

1. Pull up on the tape insulator tab located on the bottom of the battery pack.

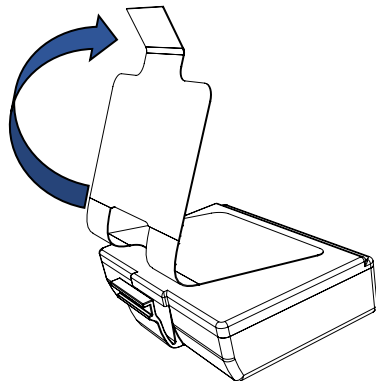

2. Peel back the tape insulator and remove it from the top of the battery pack.

Figure 5 • Installing the Battery Pack.

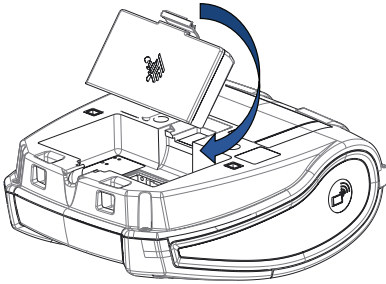

1. Angle the battery pack toward the front of the battery well. The clip on the battery pack should be facing the rear of the printer.

2. Slide the front of the battery pack into the battery well. Press down on the back of the battery pack until it clicks into place.

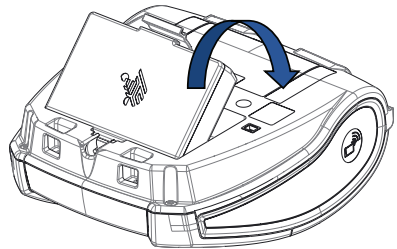

Battery Safety



Caution • Avoid accidental short circuiting of any battery. Allowing battery terminals to contact conductive material will create a short circuit which could cause burns and other injuries or could start a fire.



Important • Always refer to the Important Safety Information data sheet shipped with each printer and the Technical Bulletin shipped with each battery pack. These documents detail procedures to ensure maximum reliability and safety while using this printer.



Important • Always dispose of used batteries properly. Refer to Appendix E for more battery recycling information.



Caution • Use of any charger not approved specifically by Zebra for use with its batteries could cause damage to the battery pack or the printer and will void the warranty.



Caution • Do not incinerate, disassemble, short circuit, or expose to temperatures higher than 65°C (149°F).

Charger Safety



Do not place any charger in locations where liquids or metallic objects may be dropped into the charging bays.

Charging the Battery

When the battery is first installed, the printer power and charge indicators should indicate the battery is not fully charged (see “Charging the Battery” below and “Operator Controls”).

! Important • You must charge the battery fully before using the printer for the first time.

AC-to-USB Adapter Use Case: Home Office/Small Business

Figure 6 • AC-to-USB Adapter

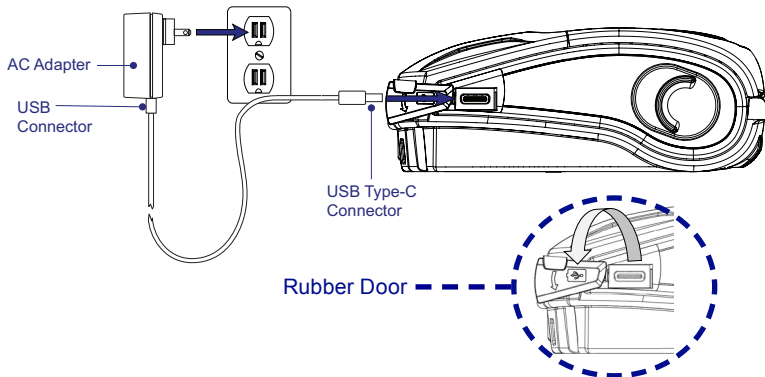

- Connect the USB connector to the AC Adapter.
- Plug the AC Adapter into an AC receptacle.
- Rotate the rubber door on the printer counterclockwise to expose the USB port.
- Plug the USB Type-C end of the cable into the USB port on the printer. The connector will plug into the port in either direction as it is not keyed.
- The printer will power up and begin charging. The printer can be left on or turned off at this point as charging will continue in either state.

! Important • While it's possible to charge the battery when using the printer, charge times will increase under this condition.

📄 Note • See Appendix B for LED Charging Behavior.

1-Slot Battery Charger

Use Case: Home Office/Small Business

The 1-Slot Battery Charger provides the user with a single, spare battery charging solution. Similar to the 3-Slot Battery Charger, the single charger will charge a battery from empty to fully charged in less than four (4) hours.

Figure 7 • 1-Slot Battery Charger



Charging Status Indicators

Both the 3-slot and 1-slot battery chargers use an LED indicator located next to each slot to indicate the charge state in either green, red, or amber as detailed below.

Mode	Charging Indication	Description
Charge Fault	● ● ● ●	Fast blinking red
Charging (Healthy)	●	Solid amber
Charge Done (Healthy)	●	Solid green
Charging (Unhealthy)	●	Solid red
Charging Done (Unhealthy)	●	Solid red
Best Battery (Charging)	● ●	Alternates between solid and bright bursts of amber
Best Battery (Charge Done)	● ●	Alternates between solid and bright bursts of green

3-Slot Battery Charger (w/ power supply and power cord)

Use Case: Settlement Room

The 3-Slot Battery Charger is a charging system for use with the 2-cell lithium-ion batteries used in the ZQ300 Series printers. The 3-slot charger is capable of charging three batteries simultaneously from empty to full in less than four (4) hours. It can either be used as a standalone charger or mounted on a 5-Bay Docking Cradle (see Page 20).

Figure 8 • 3-Slot Battery Charger



Note • For detailed information on the 1-Slot and 3-Slot Battery Charger, refer to the P1096070-101 and P1096218-101 Quick Start Guides at <https://www.zebra.com/us/en/support-downloads.html>

Charging Temperature

Charge batteries in temperatures from 0 °C to 37 °C (32 °F to 98.6 °F). The device or cradle always performs battery charging in a safe and intelligent manner. At higher temperatures (e.g. approximately +37 °C (+98 °F)) the device or cradle may for small periods of time alternately enable and disable battery charging to keep the battery at acceptable temperatures. The device and cradle indicates when charging is disabled due to abnormal temperatures via its LED.

5-Bay Docking Cradle

Use Case: Settlement Room

The ZQ300 Series 5-Bay Docking Cradle is designed to dock and charge up to five (5) ZQ310 and ZQ320 printers simultaneously. The 5-bay cradle is beneficial for use in settlement rooms where space and electrical outlets are at a premium and charging in volume is critical. The 5-bay cradle charges the printer from empty to full in less than four (4) hours. The user is allowed to operate the printer during charging, although the media compartment is not accessible while the printer is docked.

1. Ensure that the 5-bay cradle has been installed properly per its instruction manual. Ensure that the power supply is properly connected and its power indicator LED is on (see below).



2. Slide a printer into any one of the five docking bays as shown in Figure 9.



Note • If you are using a shoulder strap, ensure it is pulled away from the printer when docking on the cradle.

Figure 9 • 5-Bay Docking Cradle



Since the cups are removable from the base of the cradle, the 3-slot charger is mountable on the base by removing two cups. This configuration allows individual batteries to be charged in combination with printers and/or mobile computers.



Note • If interested in this configuration, please contact the Custom Applications Group (CAG).

1-Bay Docking Cradle

Use Case: Home Office/Small Business

The ZQ300 Series printers also have the option of being charged using a 1-bay docking cradle. This compact charging solution charges a battery from empty to full within 3.5 hours like the 5-slot docking cradle. The cradle is designed such that it can easily be docked or undocked with one hand. The printer can continue to print while charging and printer controls are still accessible. However, the media compartment cannot be accessed while the printer is docked.

Figure 10 • 1-Bay Docking Cradle

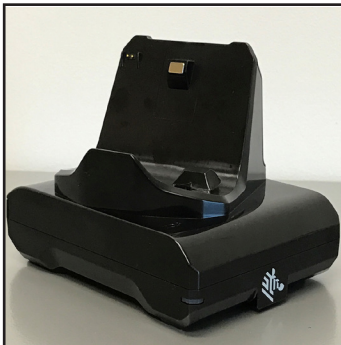

Note • For detailed information on the 5-Bay and 1-Bay docking cradles, refer to the P1096430-101 and P1096075-101 Quick Start Guides at <https://www.zebra.com/us/en/support-downloads.html>.

Vehicle Adapter

Use Case: Vehicle

The ZQ300 Series printers, along with accompanying Zebra TC51/TC56 mobile computers, can be charged in the vehicle through the use of a vehicle adapter. The vehicle adapter uses either an open-ended connection (A) or cigarette lighter adapter (B), along with a power supply.

Figure 11 • Vehicle Adapter

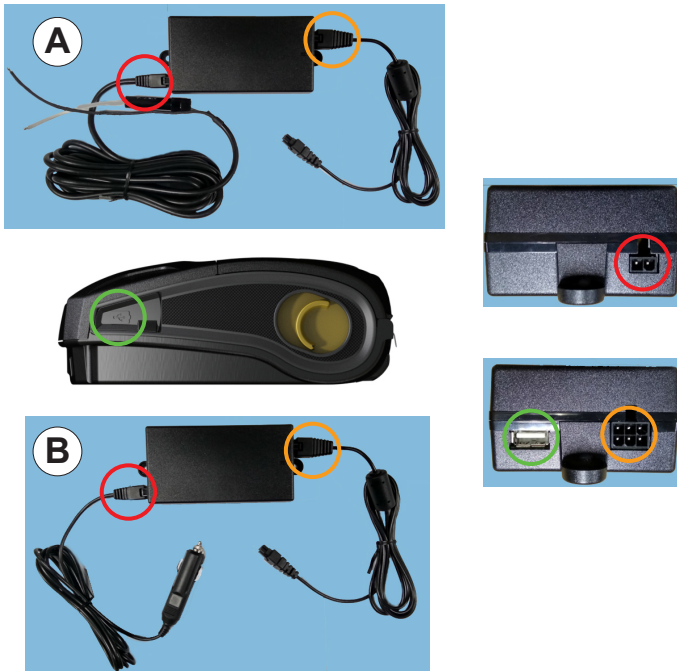

Note • For detailed information on the Vehicle Adapters, refer to the P1097394-101 Quick Start Guide at <https://www.zebra.com/us/en/support-downloads.html>.

ZQ300 Series Media

The ZQ300 Series printers are designed to print either continuous (receipt) media or label stock.

	ZQ320	ZQ310
Max Media Width	3.15" \pm 0.02" (80mm \pm 0.75 mm) Spacers available to support 3" \pm 0.02" (76 mm \pm 0.75mm)	2.28" \pm 0.02" (58mm \pm 0.75mm) Spacers available to support 2" \pm 0.02" (50.8 mm \pm 0.75mm)
Max Roll Outside Diameter	40 mm (1.57 in)	
Media Holder	Drop-in Fixed Media Width (Clamshell)	
Media Thickness	0.05842mm (0.0023") to 0.1614mm (0.0063")	
Media Types	Direct Thermal : Receipt Paper, Label, Linerless label	
Min. Receipt Length	12.5 mm (0.49")	
Max Receipt Length	Unconstrained in line mode	
Label Counter	Odometer	



Note • Scan the QR code on the bottom of the printer or go to <https://www.zebra.com/us/en/products/supplies.html> for a complete list of Zebra media and supplies.



Note • To order custom labels, go to <https://www.zebra.com/us/en/products/supplies/custom-supplies.html>

Designing Labels

The following examples provide guidelines for designing labels for the ZQ300 Series printers, specifically for Gap Media, Black Bar Media and Journal Media. The illustrations for each media type define recommended tolerances, keep-out zones and safe printing zones designed to avoid any vertical registration issues during printing. Dimensions are determined based on product registration capabilities and Zebra-recommended media tolerances.

Figure 12 • Gap Media

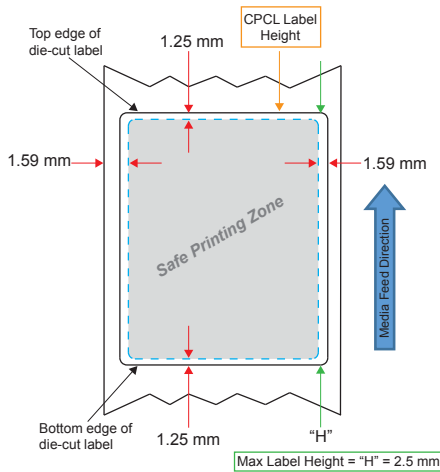

Figure 13 • Journal Media

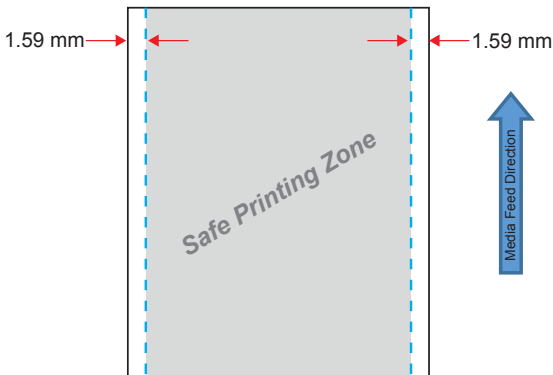
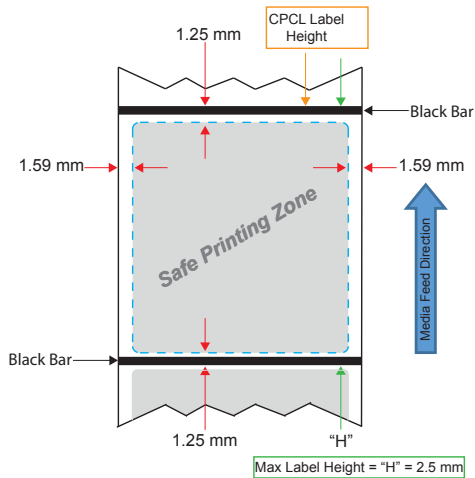

Figure 14 • Black Bar Label Media



Note • Black bars are located on the back of the media and are only shown in the above view for illustration purposes.

Using Pre-Printed Receipt Media

ZQ300 Series printers support alignment of pre-printed receipts by using the out of paper sensor located near the printhead.

Black Mark Dimensions (Receipt Media)

The reflective media black marks (or black bar/marks) should extend past the centerline of the roll on the front side of the paper.

- Minimum mark width: 0.59 in. (15 mm) perpendicular to the edge of the media, and centered within the width of the roll.
- Mark length: 0.19 - 0.24 in. (4.8 - 6.0 mm) parallel to the edge of the media.

Figure 15 • Receipt Media Black Bar Dimensions

**3.15 inch media
(80 mm)**

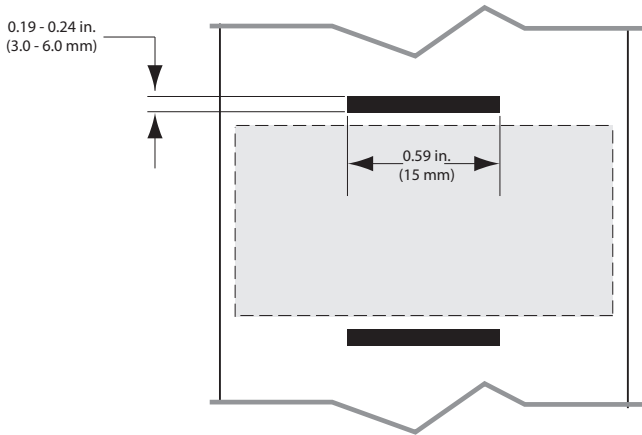

**2.28 inch media
(58 mm)**

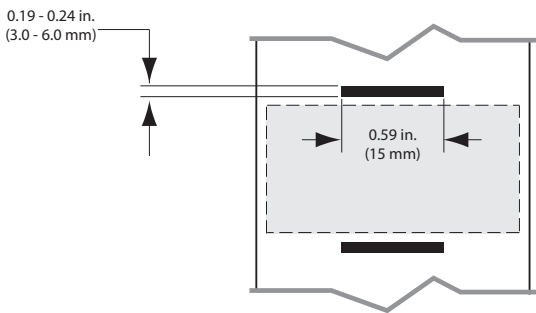

Label Areas

The media/black bar sensor detects the dark, pre-printed bar on the media, so a path in the center of the paper must be kept free of dark, pre-printed graphics.



Note • Dark, pre-printed graphics refer to any symbols, barcodes, text and/or colored areas that have been applied to the receipt paper rolls before they have ever been used in the printer.

Figure 16 • Label Areas

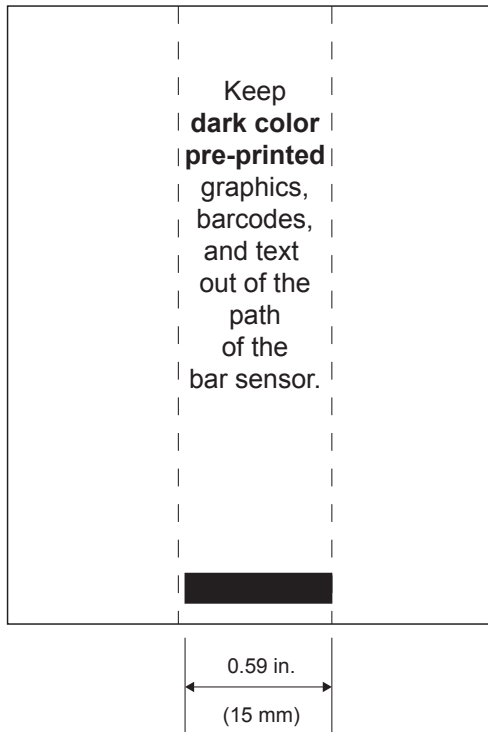

Label Design Examples

This section shows examples of labels with and without problems.

Figure 17 • Label Design Examples

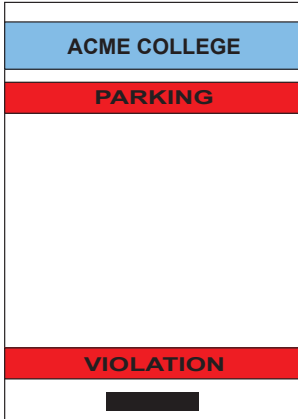

PROBLEM LABEL DESIGN

The dark color, pre-printed text and graphics are in the path of the black bar at the bottom of the receipt.

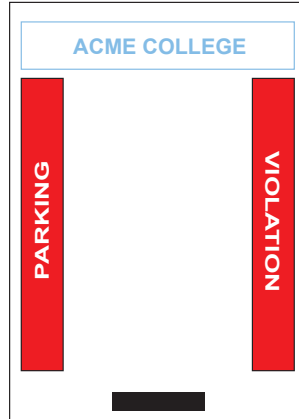

GOOD LABEL DESIGN

The center path to the black bar is free of dark color, pre-printed text and graphics.

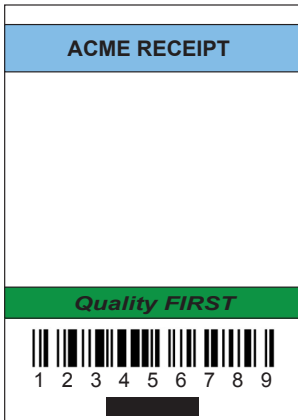

PROBLEM LABEL DESIGN

The dark color, pre-printed text and graphics are in the path of the black bar at the bottom of the receipt.



GOOD LABEL DESIGN

The center path to the black bar is free of dark color, pre-printed text and graphics.



Note • Complete information on using pre-printed receipt paper can be found in the FORM command in the CPCL Programming Guide (P1073699-001) at www.zebra.com/manuals.

Keep-Out Areas

At times, incomplete printing of text and/or graphics appear because minimum margins are not provided during label design. The recommended minimum margins, or “keep out areas” are shown in Figure 18.

Figure 18 • Keep Out Areas

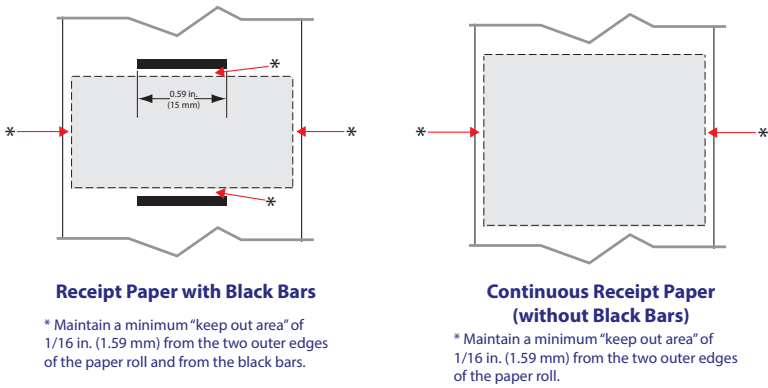

Note • The length of each “continuous” receipt is determined by the data sent to the printer.

Loading the Media

1. Press the latch release button forward to open the printer's media cover.

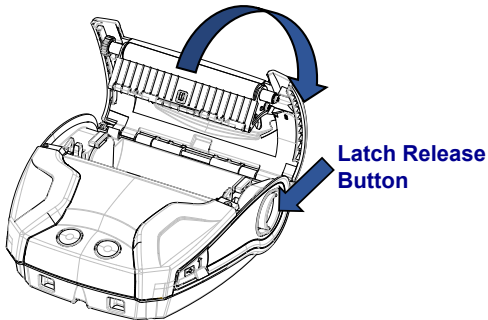

2. Insert the roll of media into the media compartment in the orientation shown.

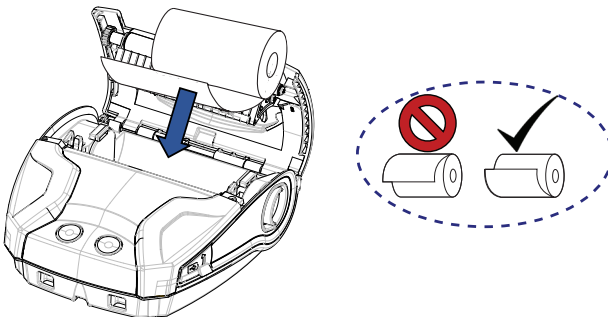

3. Close the media cover making sure to manually feed the end of the media roll outside the printer. The media cover should click into place and the media will then advance on its own.

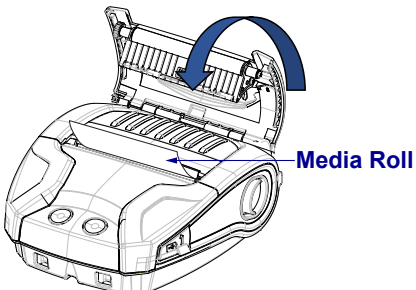

Media Spacers

Zebra provides a media spacers kit (p/n KIT-MPM-MDSPR5-01) that allows the ZQ320 printer to support 3 in. (76.2 mm) and the ZQ310 to support 2 in. (50.8 mm) wide media.

1. The media spacers slide into the media compartment in the circled areas below.

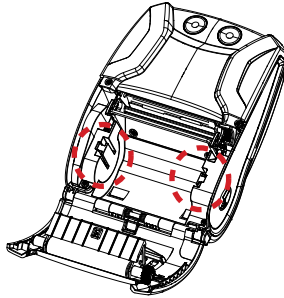

2. Slide the prongs on the back of the spacer into the grooves on each side of the media compartment (circled).

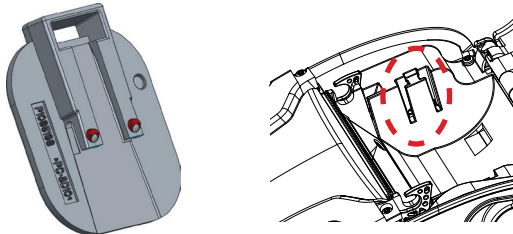



3. Use a flat head tool to insert in the slot at the top of the spacer (circled) to pull up and remove.



Operator Controls

The ZQ310 and ZQ320 printers feature a control panel with buttons for the Power On/Off and Media Feed functions, as well as a backlit user interface for providing printer status relative to faults, battery, Wifi and Bluetooth.

Figure 19 • User Interface Icons

	Power with LED Ring
	Media Feed
	Fault Status
	Battery
	WiFi
	Bluetooth

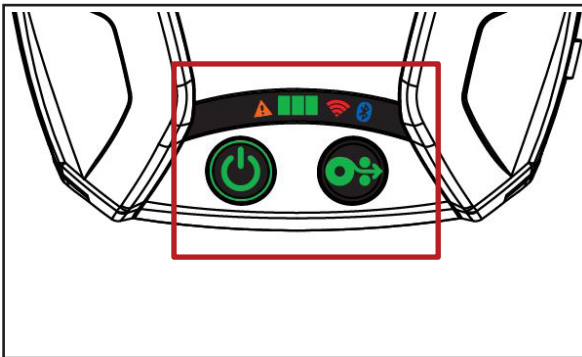

Normal Boot-up LED Behavior

1. Press Power (on/off) button and all LED indicators will illuminate until the button is released.
2. When Power button is released, the Fault LED will be steadily lit and the power ring will blink.
3. When the boot-up sequence is complete, the power ring will stop blinking and remain steadily lit. The color of the power ring depends on the charge status.
4. All other LED's (Fault, Battery, WiFi, Bluetooth) will reflect the current state of the printer.



Note • If you press the Power Button for more than five (5) seconds, the boot-up sequence will be aborted and all LED's will turn off.

Sleep Mode LED Behavior

1. During Sleep Mode, the Power LED will slowly pulse either Green, Amber or Red depending upon whether or not the printer is charging successfully.
2. All other LED's will be shut off while in sleep mode.

Shutdown Behavior

1. Press the Power Button for approximately three (3) seconds until the Fault LED turns on and the Power Ring starts blinking.
3. All LED's will turn off when the shutdown process is complete.









Firmware Download Behavior

The WiFi LED will alternately blink yellow and green while the printer is either in forced download mode or if the printer is processing a firmware download.

Power LED Ring Behavior

The Power Button is surrounded by a three-color (green, amber, red) LED ring. The Power LED Ring will:

- Blink once per 2 seconds green/amber/red during boot-up.
- Display solid green when the printer is fully charged while On or Off.
- Pulsing green to indicate Sleep Mode and not charging.
- Solid amber to indicate charging while On or Off.
- Pulsing amber to indicate charging while in sleep mode.
- Solid red to indicate an unhealthy charging or charged battery when not in sleep mode (either On or Off).
- A charge fault will flash red twice per second.
- Pulsing red to indicate unhealthy charging or charged battery when in sleep mode.

	Blink green/amber/red during boot-up
	Power On/Charged Battery
	Pulse green Sleep Mode/Not Charging
	Power On/Battery Charging
	Charging in Sleep Mode
	Charging/Charge Complete (Unhealthy)
	Charging/Charge Complete (Unhealthy/Sleep Mode)
	Charge Fault

Battery LED Behavior

The Battery icon is backlit by three (3) single color (green) LED bars, all three of which are turned off when the printer is off.

- 3 bars >= 66% State of Charge (SoC)

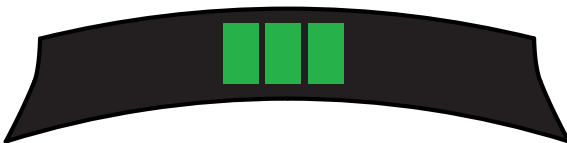

-
- 2 bars \geq 33% SoC

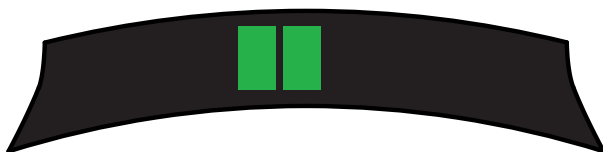

- 1 bar \geq 15% SoC

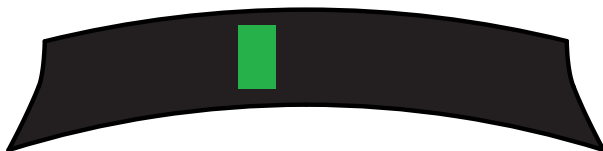

The first LED bar on the left will blink when the battery is at less than 15% SoC.

All LED's will blink twice per second when printer is powered on with no battery installed.

Fault LED Behavior

The Fault icon is backlit by a single Amber LED. If there is no fault present, the LED will be turned off. An Out of Media condition is represented by the LED on solid as shown below.

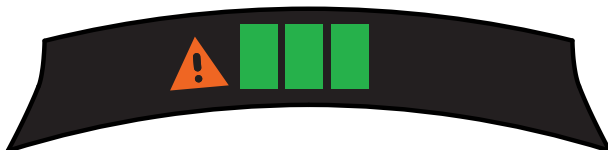

In the presence of a Media Cover Open fault, the LED will blink one time per second. If both an Out of Media and Media Cover Open condition are present, the cover open state will take precedence the blinking LED will be displayed.

When a Head Element Out and Head Over Temp condition is present, the fault LED will blink once every two seconds. This condition will take precedence over other conditions.

Bluetooth LED Behavior

The Bluetooth icon is backlit by a single Blue LED. If there is no Bluetooth connection, the LED will be turned off.

- The LED will blink once every two seconds as communication is being established.
- A solid Bluetooth icon will appear on the user interface when the printer is connected.

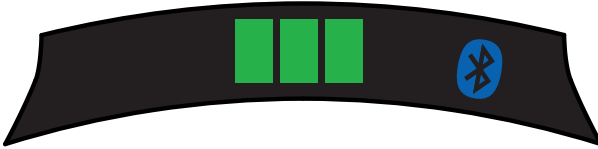

- The LED will blink two times per second when the printer is receiving data over Bluetooth.

WiFi LED Behavior

The WiFi icon is backlit by a three-color LED (green, amber and red). If there is no WiFi connection, the LED will be turned off.

- The LED will blink Red once every two seconds while printer is associating.
- The LED will blink Amber once every two seconds while printer is authenticating.
- The LED will be solid Green when the printer is associated and authenticated (if authentication is needed).

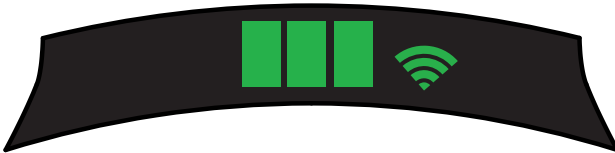

- The LED will blink Green two times per second when data is being received over WiFi. This includes all data traffic.



Note • There will be no visual indication on the user interface when data is received via USB.

Forced Download Description and LED Behavior

If for some reason the printer becomes inoperable, or the end-user wants to put the printer into forced download mode, follow the steps below.

1. Press and hold the Feed Button.



2. Press and hold the Power Button until the Power LED blinks (1/4 second).



3. Release the Power Button.
4. At this point the Fault LED will start to pulse.
5. Continue to hold the Feed button until the WiFi LED lights up (Amber).
6. Continue to hold the Feed button until the WiFi LED turns green.
7. Release the Feed button and the WiFi LED will turn off and the Fault LED will stop pulsing.
8. The WiFi LED will then alternately blink Amber and Green to indicate the printer is now in Forced Download mode.
9. Once the firmware begins downloading the WiFi LED will blink Green.
10. Once the firmware finishes downloading, the WiFi LED will remain solid on Green and eventually the printer will reset.



Note • For more information about UI LED behavior, go to Appendix B on page 75.

Printing a Configuration Report

1. Press and hold the Feed Button.
2. Press and hold the Power Button until the Power LED blinks (1/4 second).
3. Release the Power Button.
4. The Fault LED will start to pulse.
5. Continue to hold the Feed Button until the WiFi LED lights up Amber.
6. Release the Feed Button and the WiFi LED will turn off and the Fault LED will stop pulsing.
7. The printer will print the Zebra logo and “Building Two-Key Report”.
8. The printer will then print the Configuration Report.

Sleep Mode

The Sleep Mode feature is a way the printer conserves battery life whereby the printer will automatically go into a “sleep” state after twenty (20) minutes of inactivity. The printer indicates Sleep Mode when the Power LED Ring pulses (see Page 34).

If the Power Button is pressed for less than three (3) seconds, then the printer will enter Sleep Mode.

If the Power Button is pressed for more than three (3) seconds, then the printer will power down completely.

In order to “wake up” the printer, the user must press the Power Button for less than three (3) seconds.

To enable or disable Sleep Mode, send the `power.sleep.enable` command to the printer using Zebra Setup Utilities (ZSU) and set it to either “on” or “off”. (The default setting is “on”.) To set the time after which the printer will enter Sleep Mode, send the `power.sleep.timeout` (in seconds) to the printer using the ZSU.



Note • If using a Bluetooth-only printer, it will wake up on its own when communication is initiated via Bluetooth.

Power Save Mode

Power Save Mode refers to a state the printer will enter when the battery is under duress. Under normal operation with a healthy fully charged battery, the printer will load the entire printhead while printing a line of data.

As the battery's health declines (due to low voltage or cold temperature) the printer will change its printing strategy in a way that breaks up the print line into smaller segments that it can print safely without shutting down the battery. In this mode the user may experience slower printing.

The Power Save feature can be enabled/disabled via the SGD command: `print.cold _ temp _ comp.`

Draft Mode

Draft Mode printing is optimized for printing receipts comprised of text only with no reverse image, black fill or barcodes present. Draft mode is designed to operate at temperatures between ambient and the maximum thermal range of the printer. For testing/grading purposes, draft mode shall print a single Code 39 barcode, 2-dot narrow, minimum 2 characters, horizontal orientation at Temperatures = 25°C to 55°C, with no breakup or separation on receipt media only.

The Draft Mode default is set to "off". The user can configure the printer to print in Draft Mode via SGD command:

`media.draft _ mode.`



Note • For an explanation and a list of all SGD commands, please refer to the ZPL,ZBI,SGD,MIRROR,WML Programming Guide (p/n P1012728-xxx) at:

<http://www.zebra.com/us/en/support-downloads.html>



Note • For detailed information on sending SGD commands to the printer using Zebra Setup Utilities, please refer to the Wireless Configuration for 802.11n and Bluetooth Radios for Link-OS Mobile Printers (p/n P1048352-001) at:

<http://www.zebra.com/us/en/support-downloads.html>

Verify the Printer Is Working

Before you connect the ZQ300 Series printer to your computer, portable data terminal or wireless LAN, make sure that the printer is in proper working order. You can do this by printing a configuration label using the “two key reset” method described on page 38. If you can’t get this label to print, refer to “Troubleshooting”.



Note • Refer to Fig. 27 for details on configuration report content.

The unit will print a line of interlocking “x” characters to ensure all elements of the print head are working, print out the version of software loaded in the printer, and then print the report.

The report indicates model, serial number, baud rate, and more detailed information on the printer’s configuration and parameter settings. (Refer to the Troubleshooting section for sample print-outs and a further explanation on how to use the configuration label as a diagnostic tool.)

Connecting the Printer

The printer must establish communications with a host terminal which sends the data to be printed. Communications occur in four (4) basic ways:

- Via a cable using the USB 2.0 protocol. Windows drivers are available through Zebra Designer Driver. Zebra Setup Utilities can be used to configure the printer settings using a USB cable.
- By means of a wireless LAN (Local Area Network) using an optional radio per 802.11n specifications.
- By means of a Bluetooth short range radio link.
 - WinMobile®, Blackberry®, and Android® devices use standard Bluetooth® protocol.
- ZQ300 Series printers are compatible with iOS devices, therefore printing via Bluetooth to an Apple® device is possible.



Cable Communication

 **Caution** • The printer should be turned off before connecting or disconnecting the communications cable.

The standard cable connection for the ZQ300 Series printers is a USB2.0 communication and charging cable. One end of the cable has a USB Type-A connector while the other end is USB Type-C.

USB Type A-to-C Cable Assembly Wiring

USB Type-C Plug		Wire		USBStandard-A Plug	
Pin	Signal Name	Wire #	Signal Name	Pin	Signal Name
A1,B1,A12,B12	GND	1	GND_PWRr1	4	GND
A4,B4,A9,B9	VBUS	2	PWR_VBUS1	1	VBUS
A5	CC	See note below			
B5	VCONN	See note below			
A6	Dp1	3	UTP_Dp	3	D+
A7	Dn1	4	UTP_Dn	2	D-
Shell	Shield	Braid	Shield	Shell	Shield

The small Type C connector on the USB cable plugs into the printer. The connector is not keyed and therefore can be plugged in in either direction. However, do not try to force the cable if it does not plug in. The Type A end of the cable must be plugged into any USB 2.0 host port. The ZQ300 Series utilizes the USB cable to charge the printer (see Fig. 6 on page 17) and for communications between the printer and computer.

Figure 20 • USB Type A-to-C Cable
Communication with PC

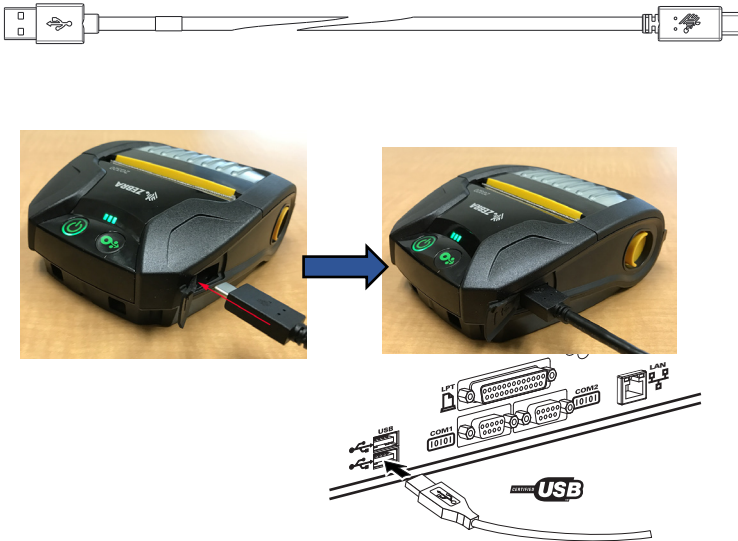

Note • USB drivers are included in the ZebraDesigner Driver which can be downloaded from the Zebra website at <https://www.zebra.com/us/en/products/software/barcode-printers/zebralink/zebra-designer.html>.

Zebra Setup Utilities

Before you start to configure your printer for use on a Local Area Network (LAN), you will need some basic information which will enable you to establish the network configuration for your printer. Zebra Setup Utilities (ZSU) provides a quick and easy way to configure your printers for a variety of purposes, including setting them up for wireless communications either on a Local Area Network (LAN) or using the international Bluetooth™ communications standard.

Once ZSU has been downloaded to your computer, attach the USB cable to the printer and computer as shown in Fig. 19. Refer to Wireless Configuration Guide (p/n P1048352-001) to follow the steps necessary for setting up and configuring your printer via ZSU. Go to <https://www.zebra.com/us/en/support-downloads.html> to download ZSU and the Wireless Configuration Guide. (See Appendix E for details on navigating zebra.com.)

Zebra Printer Setup Utility (Android-based)

The ZQ300 Series printers can also be configured using the Android-based Zebra Printer Setup Utility. The setup utility can be downloaded from Google Play to an Android device such as a smartphone or the TC51 or TC56 mobile handheld computers. The Android mobile device can be paired with the printer via NFC, Bluetooth or a USB cable and users can quickly navigate the app to perform the following tasks.

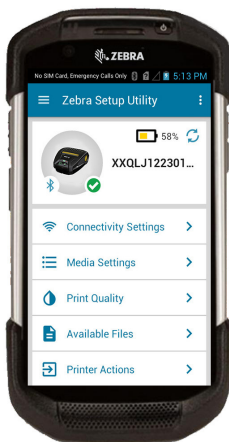

Shows currently connected printer

Displays current printer status:



= all clear

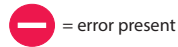

= error present

Quick access to Wizards, Printer Actions and Files

Figure 21 • Printer Setup Utility Main Screen

Wireless Communications with Bluetooth

Bluetooth is a worldwide standard for the exchange of data between two devices via radio frequencies. This form of point-to-point communication does not require access points or other infrastructure. Bluetooth radios are relatively low powered to help prevent interference with other devices running at similar radio frequencies. This limits the range of a Bluetooth device to about 10 meters (32 feet). Both the printer and the device it communicates with must follow the Bluetooth standard. Other than conditions specified elsewhere in this manual, only one of the radio options can be installed in the printer at one time and the antenna used for these transmitters must not be co-located or must not operate in conjunction with any other antenna.

Bluetooth Networking Overview

Each Bluetooth enabled ZQ300 Series printer is identified by a unique Bluetooth Device Address (BDADDR). This address resembles a MAC address whereby the first three bytes are vendor, and the last three bytes are device (e.g. 00:22:58:3C:B8:CB). This address is labeled on the back of the printer via a barcode for ease of pairing. (See Page 47.) In order to exchange data, two Bluetooth enabled devices must establish a connection.

Bluetooth software is always running in the background, ready to respond to connection requests. One device (known as the master or the client) must request/initiate a connection with another. The second device (the slave or the server) then accepts or rejects the connection. A Bluetooth enabled ZQ300 Series printer will normally act as a slave creating a miniature network with the terminal sometimes referred to as a “piconet”.

Discovery identifies Bluetooth devices that are available for pairing whereby the master device broadcasts a discovery request and devices respond. If a device is not discoverable, the master cannot pair unless it knows the BDADDR or has previously paired with the device.

Bluetooth 2.1 or higher uses Security Level 4 Secure Simple Pairing (SSP), a mandatory security architecture that features four (4) association models: Numeric Comparison, Passkey Entry, Just Works (no user confirmation), and Out of Band (pairing info transmitted OOB, e.g. via Near Field Communication).

<p>Security Mode 1</p> <p>If a BT \geq 2.1 device is pairing with a BT \leq 2.0 device, it falls back to BT 2.0 compatibility mode and behaves the same as BT 2.0. If both devices are BT \geq 2.1, Secure Simple Pairing must be used according to the BT spec.</p>	<p>Security Mode 2</p> <p>If a BT \geq 2.1 device is pairing with a BT \leq 2.0 device, it falls back to BT 2.0 compatibility mode and behaves the same as BT 2.0. If both devices are BT \geq 2.1, Secure Simple Pairing must be used according to the BT spec.</p>	<p>Security Mode 3</p> <p>If a BT \geq 2.1 device is pairing with a BT \leq 2.0 device, it falls back to BT 2.0 compatibility mode and behaves the same as BT 2.0. If both devices are BT \geq 2.1, Secure Simple Pairing must be used according to the BT spec.</p>
--	--	--

Security Mode 4: Simple Secure Pairing

Simple Secure Pairing: a new security architecture introduced supported in BT \geq 2.1. Service-level enforced, similar to mode 2. Mandatory when both devices are BT \geq 2.1. There are four association models currently supported by mode 4. Security requirements for services must be classified as one of the following: authenticated link key required, unauthenticated link key required, or no security required. SSP improves security through the addition of ECDH public key cryptography for protection against passive eavesdropping and man-in-the-middle (MITM) attacks during pairing.

Numeric Comparison	Passkey Entry	Just Works	Out of Band (OOB)
<p>Designed for situation where both devices are capable of displaying a six-digit number and allowing user to enter "yes" or "no" response. During pairing, user enters "yes" if number displayed on both devices matches to complete pairing. Differs from the use of PINs in legacy (BT \leq 2.0) pairing because the number displayed for comparison is not used for subsequent link key generation, so even if it is viewed or captured by an attacker, it could not be used to determine the resulting link or encryption key.</p>	<p>Designed for situation where one (or both) of the pairing devices has neither a display nor keyboard for entering digits (e.g. Bluetooth headset). It performs authentication step 1 in the same manner as numeric comparison, but the user cannot verify that both values match, so MITM (man-in-the-middle) protection is not provided. This is the only model in SSP that does not provide authenticated link keys.</p>	<p>Designed for situations where both devices are capable of displaying a six-digit number and allowing user to enter "yes" or "no" response. During pairing, user enters "yes" if number displayed on both devices matches to complete pairing. Differs from the use of PINs in legacy (BT \leq 2.0) pairing because the number displayed for comparison is not used for subsequent link key generation, so even if it is viewed or captured by an attacker, it could not be used to determine the resulting link or encryption key.</p>	<p>Designed for situations where both devices are capable of displaying a six-digit number and allowing user to enter "yes" or "no" response. During pairing, user enters "yes" if number displayed on both devices matches to complete pairing. Differs from the use of PINs in legacy (BT \leq 2.0) pairing because the number displayed for comparison is not used for subsequent link key generation, so even if it is viewed or captured by an attacker, it could not be used to determine the resulting link or encryption key.</p>

Each mode, except for Just Works, has Man-In-The-Middle (MITM) protection, meaning no third device can view the data being passed between the two devices involved. The SSP mode is usually negotiated automatically based on the capabilities of both the master and slave. Lower security modes can be disabled via the `bluetooth.minimum_security_mode` SGD. The `bluetooth.minimum_security_mode` SGD sets the lowest security level at which the printer will establish a Bluetooth connection. The printer will always connect at a higher security level if requested by the master device. To change the security mode and security settings in the ZQ300 printers, use Zebra Setup Utilities.

Bluetooth Minimum Security Modes	
	BT Version of Master Device (>2.1)
<code>bluetooth.minimum_security_mode=1</code>	Secure Simple Pairing Just Works/Numeric Comparison
<code>bluetooth.minimum_security_mode=2</code>	Secure Simple Pairing Just Works/Numeric Comparison
<code>bluetooth.minimum_security_mode=3</code>	Secure Simple Pairing Numeric Comparison
<code>bluetooth.minimum_security_mode=4</code>	Secure Simple Pairing Numeric Comparison
<code>bluetooth.bluetooth_PIN</code>	Not Used

 `bluetooth.minimum_security_mode` sets the lowest security level at which the printer will establish a Bluetooth connection. The printer will always connect at a higher security level if requested by the master device.

The ZQ300 Series printers also feature bonding for Bluetooth. The printer caches pairing info so devices stay paired through power cycles and disconnects. This eliminates the need to re-pair on every connection establishment.

The `bluetooth.bonding` SGD is on by default.

 **Note** • For detailed information on Bluetooth, please refer to the Bluetooth Wireless User Guide (P1068791-001) at: <http://www.zebra.com/us/en/support-downloads.html>

Near Field Communication (NFC)

In addition, the ZQ300 Series printers support passive Near Field Communication (NFC) technology. Much like Bluetooth and Wi-Fi technologies, NFC allows wireless communication and data exchange between digital devices like smartphones. Yet NFC utilizes electromagnetic radio fields while technologies such as Bluetooth and Wi-Fi focus on radio transmissions instead. NFC is an offshoot of Radio Frequency Identification (RFID), with the exception that NFC is designed for use by devices with-in close proximity to each other, i.e. a smartphone and a ZQ300 Series printer. NFC allows these devices to establish communication with each other by touching them together or bringing

them into proximity, usually no more than 7.62 centimeters (3 inches). Using the “Print Touch” feature located on the side of the printer, end-users can automatically connect via Bluetooth from a handheld device that supports NFC technology. The NFC tag has the printer’s BDADDR encoded in a URL on the tag. Simply touching the NFC handheld device to the “Print Touch” icon on the printer will connect and pair the handheld device to the printer.

Figure 22 • NFC Connectivity

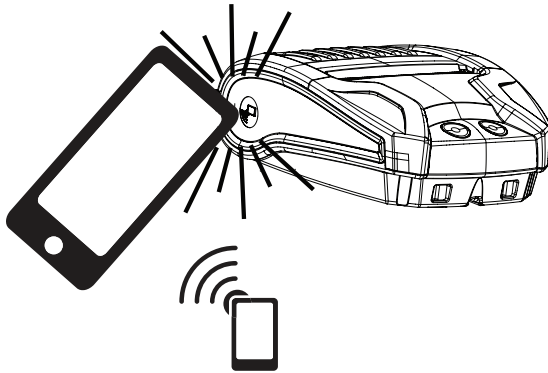

<http://www.zebra.com/nfc>

NFC Use Cases

- *Bluetooth Pairing* – used to cause a tablet, smart phone or terminal to automatically pair with the printer via a Bluetooth connection, within the bounds of the security profile being used. This shall contain the BT address and serial number of the printer.
- *App launching* – used to cause an app, developed either by Zebra or a third party to be executed on a smart phone, tablet or terminal
- *Web site launching* – used to cause a smart phone, tablet or terminal to display a web site developed by Zebra or a third party developer



Note • Tapping the Zebra Print Touch™ icon with an NFC-enabled smartphone will provide instant access to printer-specific information. For more information about NFC and Zebra products, go to <http://www.zebra.com/nfc>. Bluetooth pairing applications via NFC is also possible. Please see Zebra Multi-platform SDK for more information.

WLAN Overview

The Retail version of the ZQ320 printer are equipped with a Dual Radio option, meaning a radio that uses both the industry standard 802.11 protocols and Bluetooth 4.0. The T&L versions of the printer will ship with Bluetooth only. Both will have the FCC ID number on the serial number label on the back of the unit for identification purposes.

- ZQ300 Series Wireless Network Printers with the Zebra 802.11 WLAN radio module can be identified by the text “Wireless Network Printer” on the serial number label on the back of the printer.
- These printers allow communication as a node within a wireless local area network (WLAN). Methods of establishing communications to the printer will vary with each application.

More information and LAN configuration utilities are included in the Zebra Net Bridge™ program (version 2.8 and later). Zebra Setup Utilities (ZSU) can also be used to configure WLAN communications settings. Both Net Bridge and ZSU may be downloaded from the Zebra Web site.

Figure 23 • BT/WLAN Communications

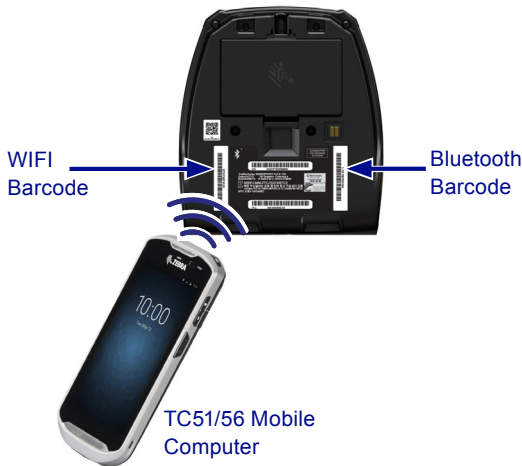

In order to obtain the Bluetooth address or the Wireless LAN address, use a mobile computer to scan the Bluetooth barcode or the WLAN barcode on the bottom of the printer where shown in Figure 23.

To enable Bluetooth for dual radio support using Zebra Setup Utilities (ZSU), please refer to the “Connectivity Setup via Bluetooth” section of the Wireless Configuration for 802.11n and Bluetooth Radios for Link-OS Mobile Printers Quick Start Guide (p/n P1048352-001).

Also refer to ZPL Programming Guide (p/n P1012728-010) for details on the Set-Get-Do (SGD) command `! U1 setvar "bluetooth.enable" "on"`. (This command is sent to the printer via the ZSU as part of the steps outlined in the Wireless Configuration Guide.)

Go to <https://www.zebra.com/us/en/support-downloads.html> and search ZQ320 and/or ZQ310 to download both manuals.

Setting Up the Software

ZQ300 Series printers use Zebra’s CPCL and ZPL Programming languages which were designed for mobile printing applications. CPCL and ZPL are fully described in the ZPL Programming Guide (p/n P1012728-010) available on-line at <https://www.zebra.com/us/en/support-downloads.html>.

You can also use Designer Pro, Zebra’s Windows® based label creation program which uses a graphical interface to create and edit labels in either language.

Refer to Appendix E for tips on downloading the Designer Pro application from Zebra’s Web site.

Wearing the Printer

Belt Clip

All ZQ300 Series printers have a belt clip shipped with the printer as a standard feature. The steps used to install the belt clip on the printer are illustrated below. Once the belt clip is hooked over your belt in a secure fashion, the belt clip will enable the printer to pivot easily to allow for freedom of movement while either standing or sitting.

Figure 24 • Belt Clip Installation



The viewing area of the printer's faceplate (which displays battery life, Bluetooth, Wifi and the error icons), is angled such that it can be seen from above while the printer hangs from the belt clip (as shown below).



continued

Adjustable Shoulder Strap

Refer to Figure 25 if you have ordered the shoulder strap option for your printer. Secure the clip on each end of the shoulder strap to the clip openings (circled below) on the front of the printer. Use the main buckle on the shoulder strap to adjust to the desired length.



NOTE: If you are using a shoulder strap, ensure it is pulled away from the printer when installing in the docking cradles. See pages 20-21.

Figure 25 • Shoulder Strap Installation

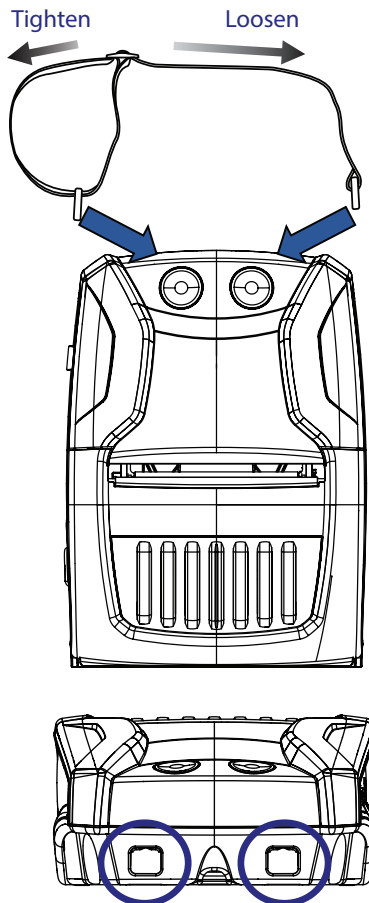

Soft Case

The ZQ300 Series printers have an environmental Soft Case option (p/n SG-MPM-SC31-01/SG-MPM-SC21-01) that helps protect the printer, while also allowing the user to carry it from their belt. The paper path is left open to maintain printing capability and the controls are visible and accessible while in the case. There is also a flap on the side of the case to allow access to the USB port. D-Ring connectors allow for attachment to the shoulder strap option.

1. Open the top flap and slide the printer into the case.



2. Close the top flap and ensure that the paper path and controls are visible through the plastic windows on the front of the case.



3. Locate the flaps that provide access to the paper path and USB port, and also the opening for the belt clip.



Preventive Maintenance

Extending Battery Life

- Never expose the battery to direct sunlight or temperatures over 40° C (140° F).
- Always use a Zebra charger designed specifically for Lithium-Ion batteries. Use of any other kind of charger may damage the battery.
- Use the correct media for your printing requirements. An authorized Zebra re-seller can help you determine the optimum media for your application.
- If you print the same text or graphic on every label, consider using a pre-printed label.
- Choose the correct print darkness, and print speed for your media.
- Use software handshaking (XON/XOFF) whenever possible
- Remove the battery if the printer won't be used for a day or more and you're not performing a maintenance charge.
- Consider purchasing an extra battery.
- Remember that any rechargeable battery will lose its ability to maintain a charge over time. It can only be recharged a finite number of times before it must be replaced. Always dispose of batteries properly. Refer to Appendix C for more information on battery disposal.

General Cleaning Instructions



Caution • To avoid possible personal injury or damage to the printer, never insert any pointed or sharp objects into the printer. Always turn the printer off before performing any cleaning procedures. Use care when working near the tear bar. The edges are very sharp.



Warning • The printhead can be very hot after prolonged printing. Allow it to cool off before attempting any cleaning procedures.



Only use a Zebra cleaning pen (not supplied with the printer) or a cotton swab with 90% medical grade alcohol for cleaning the printhead.



Caution • Use only cleaning agents specified in the following tables. Zebra Technologies Corporation will not be responsible for damage caused by any other cleaning materials used on this printer.

continued

ZQ300 Series Cleaning

Area	Method	Interval
Printhead	Use a Zebra cleaning pen to swab the thin gray line on the printhead, cleaning the print elements from the center to the outside edges of the printhead.	After every five (5) rolls of media (or more often if needed). When using linerless media, cleaning is required after every roll of media.
Platen Surface (Linered)	Rotate the platen roller and clean it thoroughly with a fiber-free swab, or lint free, clean damp cloth lightly moistened with medical-grade alcohol (90% pure or better).	After every five (5) rolls of media (or more often if needed.)
Platen Surface (Linerless)	Rotate platen roller and clean with a fiber-free swab and 1 part liquid soap (Palmolive or Dawn) and 25 parts water. Use pure water to clean after soap/water mixture.	Clean platen only if there is an issue during printing, i.e. media not releasing from the platen. (*see Note below.)
Scraper (Linerless Units Only)	Use adhesive side of media to clean scraper.	After every five (5) rolls of media (or more often if needed).
Tear Bar	Clean thoroughly with 90% medical-grade alcohol and a cotton swab.	As needed
Printer Exterior	Water-dampened cloth or 90% medical-grade alcohol wipe.	As needed
Printer Interior	Gently brush out printer. Ensure the sensor window(s) are free of dust.	As needed
Interior of Linerless Units	Clean thoroughly with 90% medical-grade alcohol and fiber-free swab.	After every five (5) rolls of media (or more often if needed).



Note • This is an emergency procedure only to remove foreign contaminants (oils, dirt) from the platen that can damage the printhead or other printer components. This procedure will shorten or even exhaust the linerless platen's useable life. If the linerless media continues to jam after cleaning and feeding 1 to 2 meters (3 to 5 feet) of media, replace the platen.



Note • Never apply cleaning liquids directly to the printer. Do not let liquid pool on any area of the printer or penetrate the internal circuitry of the printer.

Figure 26 • Preventive Maintenance

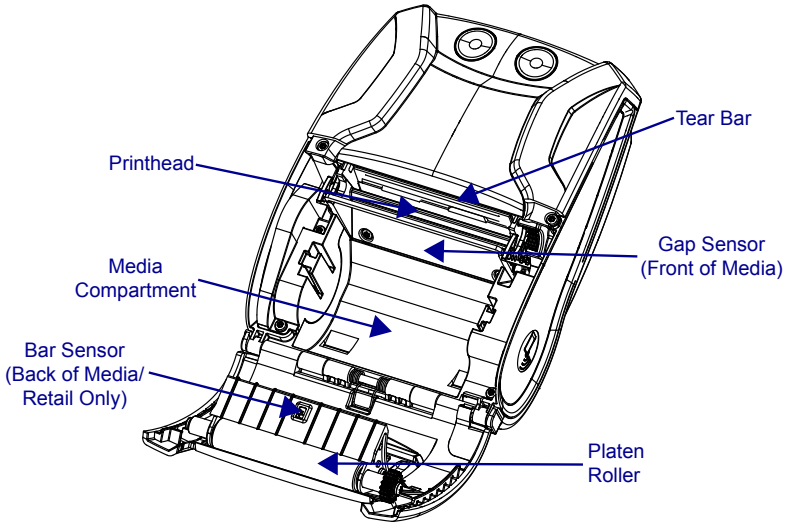

Troubleshooting

Printer Status Indicators

If the printer is not functioning or charging properly, refer to the table below to determine the state of the LED indicator ring located around the Power button.



Green	Amber	Red	Indication
Solid	Off	Off	Power On/Charged Battery
Blinking	Off	Off	Booting Up
Pulsing	Off	Off	Sleep Mode/ Charge Complete
Fast Blinking	Off	Off	Printer On/No Battery
Off	Solid	Off	Battery Charging
Off	Pulsing	Off	Charging While in Sleep Mode
Off	Slow Blinking	Off	Charging (Shutdown)
Off	Off	Solid	Charged or Charging (Unhealthy)/ On or Off
Off	Off	Pulsing	Charged or Charging/ Sleep Mode
Off	Off	Fast Blinking	Charge Fault
Off	Off	Slow Blinking	Charged or Charging (Unhealthy/Shutdown)

Troubleshooting Topics

1. No power:

- Ensure you press and hold the Power switch until the Power light comes on.
- Check that battery is installed properly.
- Recharge or replace battery as necessary.

2. Media does not feed:

- Be sure Media Cover is closed and latched.
- Check media compartment. Ensure media is not binding on the sides of the compartment.

3. Poor or faded print:

- Clean printhead.
- Check battery for possible damage. Recharge or replace as

-
- necessary.
- Check quality of media.
 - If using label media, ensure the “Tone” setting is set to 50.

4. *Partial or missing print:*

- Check media alignment.
- Clean printhead.
- Ensure Media Cover is properly closed and latched.

5. *Garbled print*

- Check baud rate.

6. *No print*

- Replace battery.
- Check cable to terminal.
- (Wireless units only) Restore wireless connection.

7. *Reduced battery life*

- Check battery date code. If battery is more than one year old, short life may be due to normal aging.
- Recharge or replace battery.

8. *Flashing Amber error indicator*

- Check that media is loaded and that printhead is closed and securely latched.
- If media is present and latch is closed, indicates that no application is present or application is corrupted. Program must be re-loaded.

9. *Communication error*

- (Wireless units only) Check that media is loaded, head is closed and WiFi or Bluetooth icon is present.
- (USB) Replace cable to terminal.

10. *Label jam*

- Open media cover.
- Apply medical-grade alcohol to printer in area of jammed label.

11. *No NFC Connectivity*

- Ensure smartphone is positioned 3 inches (7.62 cm) or closer to the Print Touch icon on the side of the printer..

Troubleshooting Tests

Printing a Configuration Report

To print out a listing of the printer's current configuration follow these steps:

1. Turn the printer off. Load the media compartment with journal media (media with no black bars printed on the back)
2. Follow the steps outlined in **Printing a Configuration Report on Page 38**.

Refer to Figure 27 for a sample configuration printout.

Communications Diagnostics

If there is a problem transferring data between the computer and the printer, try putting the printer in the Communications Diagnostics Mode (also referred to as the "DUMP" mode). The printer will print the ASCII characters and their text representation (or the period '.', if not a printable character) for any data received from the host computer

To enter Communications Diagnostics Mode:

1. Print a configuration label as described above.
2. At the end of 2nd diagnostics report, the printer will print: "Press FEED key to enter DUMP mode".
3. Press the FEED key. The printer will print: "Entering DUMP mode".



Note • If the FEED key is not pressed within 3 seconds, the printer will print "DUMP mode not entered" and will resume normal operation.

4. At this point, the printer is in DUMP mode and will print the ASCII hex codes of any data sent to it, and their text representation (or "." if not a printable character).

Additionally, a file with a ".dmp" extension containing the ASCII information will be created and stored in the printer's memory. It can be viewed, "cloned" or deleted using the Label Vista application. (Refer the Label Vista documentation for more information.)

To terminate the Communications Diagnostics Mode and return the printer to normal operations:

-
1. Turn the printer OFF.
 2. Wait 5 seconds.
 3. Turn the printer ON.

Calling Technical Support

If the printer fails to print the configuration label, or you encounter problems not covered in the Troubleshooting Guide, contact Zebra Technical Support. Technical Support addresses and phone numbers for your area can be found on Page 80 of this manual. You will need to supply the following information:

- Model number and type (e.g. ZQ320)
- Unit serial number (Found on the large label on the back of the printer, also found in the configuration label printout. (Refer to Figure 27.)
- Product Configuration Code (PCC) (15 digit number found on the label on the back of the unit)



Building Two-Key Report...

XXXXXXXXXXXXXXXXXXXXXXXXXXXXXXXXXXXX

← Print Head Test

Zebra Technologies
ZQ320

← Identifies Printer as a ZQ320

Serial Number:

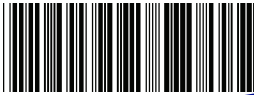

← Printer Serial Number

XXZFJ170700432

PCC: ZQ32-A0W01R0-00

Name: XXZFJ170700432

Program:

OS: 6.5.0

PLD: 15 Rev. 64

PSPT: 7 Rev. 14

EMCU: Rev. 28

Firmware: V81.20.042P36755

← Firmware Version

Checksum: 8C9C

Universal Serial Bus:

2.0 Full Speed Device

Vendor ID No: 0x0ASF

Product ID No: 0x013A

Manufacturer String: Zebra Technologies

Product String: ZTC ZQ320-203d

pi CPCL

ID string: off

Bluetooth:

iOS: supported

← MFi Supported

Version: 4.3.1p1

Date: 02/13/2015

Baud: 115200

Device: Printer

Mode: Slave

Friendly Name: XXZFJ170700432

Minimum Security Mode: 1

Discoverable: on

Bluetooth Spec: 3.0/4.0

Enabled: on

Address: AC:3F:A4:8F:42:01

← Bluetooth™ Radio Address

Figure 27 • Configuration Report



AC3FA48F4201

Wireless:

Radio: 802.11 a/b/g/n/ac
Region: usa/canada
Country: usa/canada
Enabled: on
MAC Address: ac:3f:a4:8f:42:00
IP Address: 0.0.0.0
Netmask: 255.255.255.0
Gateway: 0.0.0.0
Operating Mode: infrastructure
International Mode: off
Preamble Length: long
Security: none
Stored ESSID: 125
Associated: no
DHCP: on
DHCP CID type: 1
DHCP CID: ac3fa48f4200
Power Save: on

802.11 radio option installed.

Active Network Information:

Active Network: Unknown
IP Address: 0.0.0.0
Netmask: 255.255.255.0
Gateway: 0.0.0.0
TCP Port: 6101
Alternate TCP Port: 9100
TCP JSON Config Port: 9200
UDP Port: 6101
Remote Server:
Remote Server Port: 10013
TCP: on
UDP: on
LPD: on
DHCP: on
BOOTP: on
FTP: on
HTTP: on
SMTP: on
POP3: on
SNMP: on
TELNET: on
MIRROR: off
UDP Discovery: on
Weblink:
DHCP CID type: 1
DHCP CID: ac3fa48f4200

Network Information

Product support website:

<http://zebra.com/zq320-info>



Scan QR code to go to ZQ300 Series product support website

Power Management:

In-activity Timeout:36000 Secs
Low-battery Timeout:60 Secs
Remote (DTR) pwr-off:Disabled
Voltage :4.75
Low-bat Warning :6.02(20)
Low-bat Shut-down :6.02(13)
Power On Cycles :48
Battery Health :good
Battery Cycle Count:0

Memory:

Flash :50331648 Bytes
RAM :4194304 Bytes

Flash and
RAM Memory
Installed

Label:

Width :576 dots, 72 mm
Height:65535 dots, 8191 mm

Maximum
Label Size

Sensors: (Adj)

Front Bar [DAC:143,Thr:70,Cur:
3]
Black Bar [DAC:144,Thr:70,Cur:0
]
Gap [DAC:192,Thr:50,Cur:60]
Temperature :27C (57)
Voltage :8.2V (255)

Resident Fonts:

Font	Sizes	Chars
0	0- 6	20-FF
1	0	20-80
2	0- 1	20-59
4	0- 7	20-FF
5	0- 3	20-FF
6	0	20-44
7	0- 1	20-FF

Resident Human
Readable fonts
installed.

File Directory:

File	Size
E:2KEY.TXT	0
E:TT0003M_.TTF	169188

50162176 Bytes Free

Files Loaded in
Printer Memory
(will include Pre-
scaled or Scalable
Fonts).

Command Language:

CCL Key '\!' [21]

ZPL Configuration Information:

Rewind.....Print Mode
Continuous.....Media Type
10.0.....Darkness
+00.....Tear Off Adjust
2030.....Label Length
72mm.....Print Width
7Eh.....Control Prefix
2Ch.....Delimiter
00.....Top Position
No Motion..Media Power Up
Feed...Media Head Closed
00.....Left Margin
576.....Dots per row
End ZPL Configuration

CPCL and
ZPL pro-
gramming
languages are
supported

Print-head test: OK
End of report

Press FEED key to
enter DUMP mode

Specifications



Note • Printer specifications are subject to change without notice.

Printing Specifications

Parameter	ZQ310	ZQ320
Print Width	Up to 48 mm (1.89 in.) Max	Up to 72 mm (2.83 in.) Max
Print Speed (Linered)	Up to 101.6 mm (4.0 in.)/sec.	Up to 101.6 mm (4.0 in.)/sec.
Print Speed (Linerless)	50.8 mm (2 in.)/sec	76.2 mm (3 in.)/sec
Print Head Life	600,000 inches Mean Time to Failure of output at 18% density at 20° C using virgin media	600,000 inches Mean Time to Failure of output at 18% density at 20° C using virgin media
Print Density	8 dots/mm (203 dots/inch)	8 dots/mm (203 dots/inch)
Printhead Burn Line to Tear Edge	4.8 mm +/-0.5 mm (0.189 in. +/-0.02 in.)	4.8 mm +/-0.5 mm (0.189 in. +/-0.02 in.)

Memory and Communications Specifications

Parameter	ZQ310	ZQ320
Flash Memory	256 MB (option to expand up to 512 MB)	
RAM	128 MB (option to expand up to 256 MB)	
Standard Communications	USB 2.0 Type-C Interface	
Optional Wireless Communications	Standard Bluetooth compatible module Optional 802.11 a/b/g/n/ac SRRF module Dual radio option (802.11ac & BT 4.0)	

Media Specifications

Parameter	ZQ310	ZQ320
Width	58 mm +/-0.75 (2.28 in. +/-0.02) 76 mm +/-0.75 (3 in. +/-0.03) with spacers	80 mm +/-0.75 (3.15 in. +/-0.02) 76.2 mm +/-0.75 (3 in. +/-0.03) with spacers
Length	12.5 mm (0.49 in.) minimum	12.5 mm (0.49 in.) minimum
Black Bar Sensor to Printhead Burnline Distance	16 mm +1.0/-0.6 mm (0.62 in. +.04/-0.02 in.)	16 mm +1.0/-0.6 mm (0.62 in. +.04/-0.02 in.)
Label Thickness	0.05842 mm to 0.1614 mm (.0023 in. to .0063 in.)	0.05842 mm to 0.1614 mm (.0023 in. to .0063 in.)
Tag/Receipt Thickness	0.1397 mm (.0055 in.) max	0.1397 mm (.0055 in.) max
Max. Media Outer Diameter	40 mm (1.57 in.)	40 mm (1.57 in.)
Label Inner Core Diameter	15.875 mm to 22.22 mm (.625 in. to .875 in.)	15.875 mm to 22.22 mm (.625 in. to .875 in.)
Black Mark Location	Centered on media roll	Centered on media roll
Black Mark Dimensions	L: 2.4 mm to 11.0 mm (0.09 in. to 0.43 in.) W: 12.7 mm (0.5 in.)	L: 2.4 mm to 11.0 mm (0.09 in. to 0.43 in.) W: 12.7 mm (0.5 in.)

ZPL Bar Code Specifications and Commands

	Barcode (ZPL Command)
Linear & 2-D Bar Codes Available	Aztec (^B0)
	Codabar (^BK)
	Codablock (^BB)
	Code 11 (^B1)
	Code 39 (^B3)
	Code 49 (B4)
	Code 93 (^BA)
	Code 128 (^BC)
	DataMatrix (^BX)
	EAN-8 (^B8)
	EAN-13 (^BE)
	GS1 DataBar Omnidirectional (^BR)
	Industrial 2 of 5 (^BI)
	Interleaved 2 of 5 (^B2)
	ISBT-128 (^BC)
	LOGMARS (^BL)
	Micro-PDF417 (^BF)
	MSI (^BM)
	PDF-417 (^B7)
	Planet Code (^B5)
	Plessey (^BP)
	Postnet (^BZ)
	Standard 2 of 5 (^BJ)
	TLC39 (^BT)
	UPC/EAN extensions (^BS)
UPC-A (^BU)	
UPC-E (^B9)	
Maxi Code (^BD)	
QR Code (^BQ)	
Rotation Angles	0°, 90°, 180°, and 270°

**Contains UFS1 from Agfa Monotype Corporation*

CPCL and ZPL Font Specifications

CPCL Font Specification: 203 dpi (8 dots/mm)

Fonts	Matrix (in dots) (HxW)	Min. Char. Size (HxW)	Max. CPI
0 (Standard)	9 x 8	.044" x .039"	25.4
1 (min. width)	48 x 13	.236" x .064"	15.6
1 (max. width)	48 x 39	.236" x .192"	5.2
2 (OCR-A)	12 x 20	.059" x .099"	10.2
4 Size 0 (min. width)	47 x 11	.232" x .054"	18.5
4 Size 0 (max. width)	47 x 43	.232" x .212"	4.7
5 Size 0 (min. width)	24 x 7	.118" x .034"	29
5 Size 0 (max. width)	24 x 23	.118" x .113"	8.8
6 (MICR)	27 x 28	.133" x .138"	7.3
7	24 x 12	.118" x .059"	16.9

- Standard Fonts: 25 bitmapped, 1 smooth, scalable (CG Triumvirate Bold Condensed*)
- Optional Fonts: downloadable bitmapped/scalable fonts.
- International Character Sets (optional): Arabic, Cyrillic, Hebrew, Traditional Chinese (Scalable NotoMono), 24x24 Mkai, 16x16 New Sans MT, Vietnamese (Bitmap 16x16 Utah), Simplified Chinese (Hans.ttf, bitmapped: 24x24 Msung & 16x16 SimSun), Japanese (Scalable NotoMono), bitmapped 16x16 Square Gothic J MT, Korean (Scalable NotoMono) and Thai (Scalable, Angsana).
- Scalable text feature.
- Standard resident fonts can be rotated in 90° increments.
- Supports user defined fonts, and graphics and logos.
- Text concatenation to assign different character styles.
- Allows text magnification 1-16 times the original size.
- Proportional and fixed-width fonts.

*Contains UFST from Agfa Monotype Corporation

ZPL Font Specification: 203 dpi (8 dots/mm)

Font	Matrix (in dots) (HxW)	Type*	Min. Char. Size (HxW)	Maz. C.P.I.
A	9 x 5	U-L-D	.044" x .030"	33.3
B	11 x 7	U	.054" x .044"	22.7
C,D	18 x 10	U-L-D	.089" x .059"	16.9
E	28 x 15	OCR-B	.138" x .098"	10.2
F	26 x 13	U-L-D	.128" x .079"	12.7
G	60 x 40	U-L-D	.295" x .236"	4.2
H	21 x 13	OCR-A	.103" x .093"	10.8
GS	24 x 24	SYMBOL	.118" x .118"	8.5
P	20 x 18	U-L-D	0.098 x 0.089	N/A
Q	28 x 24	U-L-D	0.138 x 0.118	N/A
R	35 x 31	U-L-D	0.172 x 0.153	N/A
S	40 x 35	U-L-D	0.197 x 0.172	N/A
T	48 x 42	U-L-D	0.236 x 0.207	N/A
U	59 x 53	U-L-D	0.290 x 0.261	N/A
V	80 x 71	U-L-D	0.394 x 0.349	N/A
Ø	15 x 12	U-L-D	Scalable (Smooth) Font	

*U=upper case, L=lower case, D=descenders

- Character Fonts: Standard bitmapped Zebra fonts: A, B, C, D, E (OCR-B), F, G, H, (OCR-A), GS, P, Q, R, S, T, U, V & Ø Smooth font (CG Triumvirate Bold Condensed).
- Supports Unicode UTF-8, UTF-16, and several other single and multi-byte international character sets (See ZPL programming guide for more details).
- Supports user defined fonts and graphics – including custom logos.
- Bitmap fonts are expandable up to 10 times, height and width independent. Fonts E and H (OCR-B and OCR-A), however, are not considered in spec when expanded.
- Smooth scalable font Ø (CG Triumvirate Bold Condensed) is expandable dot-by-dot, height and width independent.
- Unicode Swiss 721 font available.

Printing in Chinese Fonts

The information that follows provides details on how to print using Chinese fonts on the ZQ300 Series printers.



Note: This printer ships in line print mode from the factory. It has the GB18030 encoding pre-selected at start up and has the GBUNSG24.CPF font preselected at start up. You can directly send GB18030 encoded text to the printer and it will print to the printer without any modifications to the settings. If you prefer to use the UTF-8 encoding rather than GB18030, issue the following command:

```
! U1 ENCODING UTF-8
```

There are two options to print Chinese fonts: UTF-8 or GB18030. To activate one of these modes, select the control language that you will create your label in, which in this case is CPCL only.

To create your label in CPCL, you need to add one of following two commands to your label in order to enable Chinese printing:

- For UTF-8, use ENCODING UTF-8 or COUNTRY UTF-8.
- For GB18030, use ENCODING GB18030 or COUNTRY GB18030

Next you need to select the correct font to print in Chinese. The following fonts are provided for use in Chinese as follows:

- GBUNSG24.CPF (24x24 pixel bitmapped font)
- GBUNSG16.CPF (16x16 pixel bitmapped font)

Below is a sample label sent in UTF-8 Encoding format:

```
! 0 200 200 225 1
PW 384
ENCODING UTF-8
T GBUNSG24.CPF 0 0 20 紅日已高三丈透,
T GBUNSG24.CPF 0 0 46 金爐次第添香獸,
T GBUNSG24.CPF 0 0 72 紅錦地衣隨步皺。
T GBUNSG24.CPF 0 0 98 佳人舞點金釵溜,
T GBUNSG24.CPF 0 0 124 酒惡時拈花蕊嗅,
T GBUNSG24.CPF 0 0 150 別殿遙聞簫鼓奏。
PRINT
```

Below is a sample label sent in GB18030 Encoding format:

```
! 0 200 200 225 1
PW 384
ENCODING GB18030
T GBUNSG24.CPF 0 0 20 紅日已高三丈透,
T GBUNSG24.CPF 0 0 46 金爐次第添香獸,
T GBUNSG24.CPF 0 0 72 紅錦地衣隨步皺。
T GBUNSG24.CPF 0 0 98 佳人舞點金釵溜,
T GBUNSG24.CPF 0 0 124 酒惡時拈花蕊嗅,
T GBUNSG24.CPF 0 0 150 別殿遙聞簫鼓奏。
PRINT
```



Note: The ZQ300 Series printers do not ship with built in support for printing Chinese in ZPL.



Note: Depending on the characteristics of the media being used, such as media thickness and thermal sensitivity, print darkness setting may need to be adjusted in order to improve readability of small characters. Please use print darkness control commands to increase or decrease print darkness as needed and as described in the Programming Guide (p/n P1012728-010).

USB Type-C to Type-A Communications Cable

Type-C Plug		Wire		Type-A Plug	
Pin #	Signal Name	Wire #	Signal Name	Pin #	Signal Name
A1,B1, A12,B12	GND	1	GND_PWr1	4	GND
A4,B4,A9, B9	VBUS	2	PWR_VBUS1	1	VBUS
A5	CC	See Note 1			
B5	VCONN	-			
A6	Dp1	3	UTP_Dp	3	D+
A7	Dn1	4	UTP_Dn	2	D-
	Shield	Braid	Shield	Shell	Shield

Notes:

1. Pin A5 (CC) of the USB Type-C plug shall be connected to VBUS through a resistor R_p (56 k Ω +/- 5%).
2. Contacts B6 and B7 should not be present in the USB Type-C plug.
3. All VBUS pins shall be connected together within the USB Type-C plug.
Bypass capacitors are not required for the VBUS pins in this cable.
4. All Ground return pins shall be connected together within the USB Type-C plug.
5. All USB Type-C plug pins that are not listed in this table shall be open (not connected).

Figure 28 • USB Type-C to Type-A Pinouts

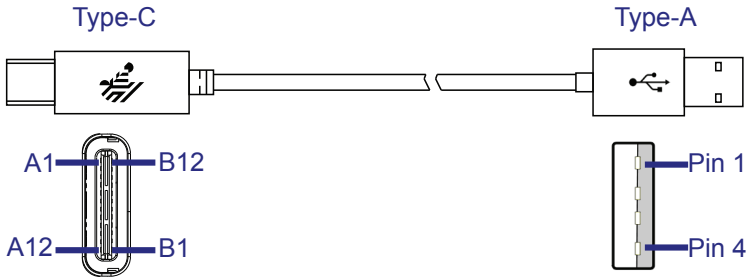

continued

Physical, Environmental and Electrical Specifications

Parameter	ZQ310	ZQ320
Weight w/ battery, excluding media	0.37 Kg (0.81 lbs.)	0.43 Kg. (0.95 lbs.)
Temperature	Operating : -15° to 50° C (5° to 122° F)	
	Charging: 0° to 40° C (32° to 104° F)	
	Storage w/o battery: -20° to 60° C (-4° to 140° F)	
	Storage w/ battery: -25° to 45°C (-4° to 113° F)	
Relative Humidity	Operating: 10% to 90% (non-condensing)	
	Storage: 10% to 90% (non-condensing)	
Battery	Lithium-Ion, 7.2 VDC (nominal); 2280 mAHr, PowerPrecision+	
Printer Input Power	12.0 VDC; 1.25A	
Ingression Protection (IP) Rating	54	

Figure 29 • ZQ320 Dimensions

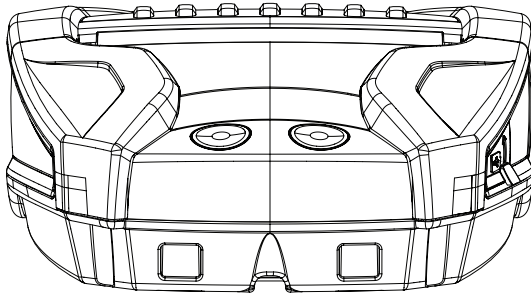

49.5 mm
(1.95 in.)

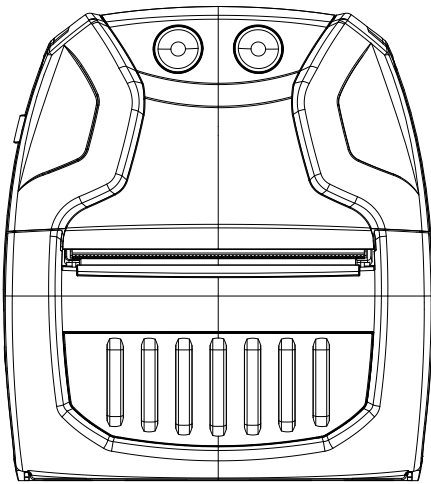

117.7 mm
(4.63 in.)

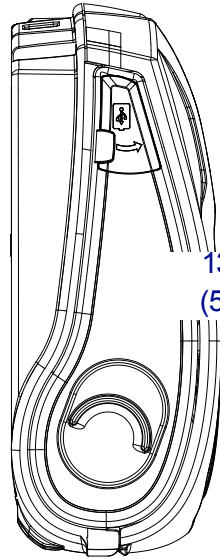

130 mm
(5.12 in.)

Figure 30 • ZQ310 Dimensions

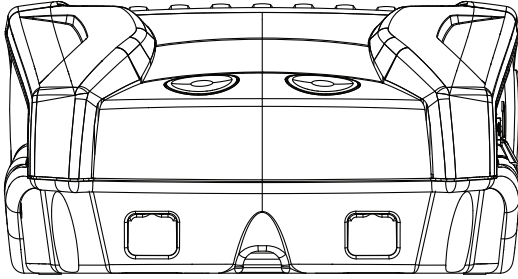

49.5 mm
(1.95 in.)

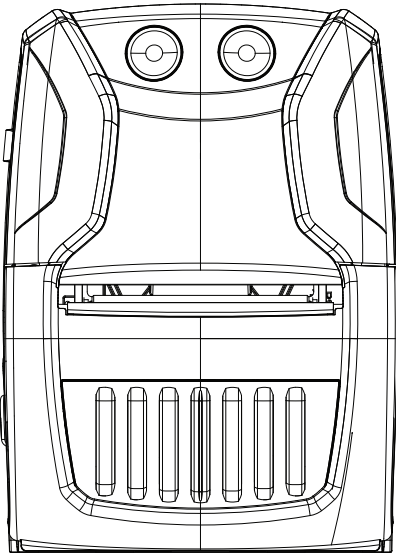

93.5 mm
(3.68 in.)

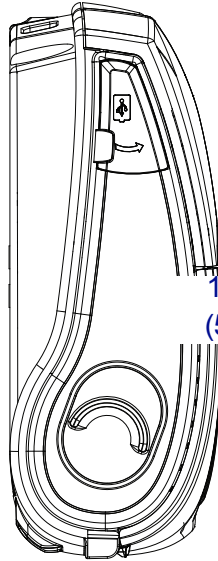

130 mm
(5.12 in.)

ZQ300 Series Accessories

Part #	Description
P1080867	BELT,CLIP,Micro ZQ3X
CRD-MPM-5SCHGUS1-01	5-Slot Docking Cradle,ZQ3 (includes PSU and US power cord)
CRD-MPM-1SCHGUS1-01	1-Slot Docking Cradle,ZQ3 (Includes Type A to Type C USB Cable and AC to USB Adapter with US power plug)
SAC-MPM-3BCHGUS1-01	3-Slot Battery Charger,ZQ3 (includes PSU and US power cord)
SAC-MPM-1BCHGUS1-01	1-Slot Battery Charger,ZQ3 (includes US power cord)
MNT-MPM-VHDRD1-01	Vehicle Holder (Dashboard),ZQ3
MNT-MPM-VHDRW1-01	Vehicle Holder (Windshield),ZQ3
PWR-WUA5V12W0US	AC to USB Adaptor,ZQ3 (US power plug)
CHG-AUTO-USB1	Cigarette to USB adaptor (12/24V to 5V); ZQ300 Series
VAM-MPM-VHCH1-01	Vehicle adapter for ZQ300 and TC51/TC56 mobile computer (includes open ended and cigarette lighter adapter cables)
CBL-MPM-USB1-01	Kit,USB Type A to Type C Cable
SG-MPM-SC31-01	Kit,Soft Case,ZQ320
SG-MPM-SC21-01	Kit,Soft Case,ZQ310
KIT-MPM-MDSPR5-01	Kit,ZQ300,Media,Spacers

Appendix A

Serial Number and PCC Number Locations

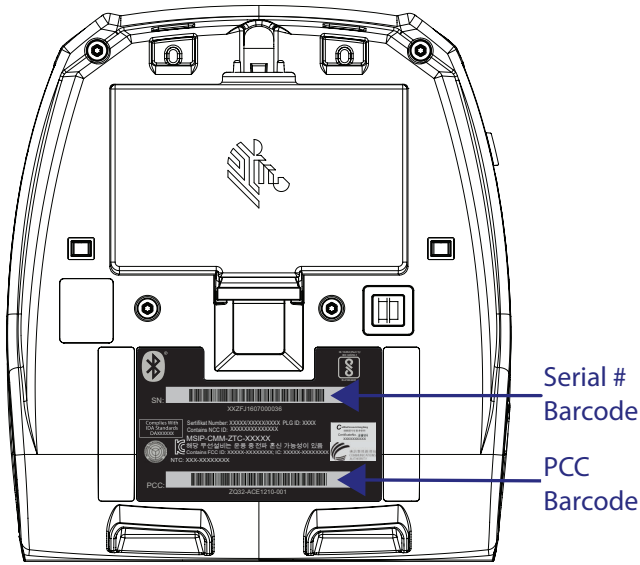

When calling with a specific problem regarding your printer, please have the following information on hand:

- Model number/type (e.g. ZQ320)
- Unit serial number
- Product Configuration Code (PCC)

For Product Support Contacts, see the table on the next page or contact your local re-seller.

Appendix B

User Interface LED Charging Behavior

Power State		Status	Description
On	Healthy	Charging	Solid Amber
		Charge Fault	Fast Blinking Red (2 blinks/second)
		Charge Complete	Solid Green
	Unhealthy	Charging	Solid Red
		Charge Fault	Fast Blinking Red (2 blinks/second)
		Charge Complete	Solid Red
	N/A	No Battery	(Battery Graph) Fast Blinking Green (2 blinks/second)
Off	Healthy	Charging	Solid Amber
		Charge Fault	Fast Blinking Red (2 blinks/second)
		Charge Complete	Solid Green
	Unhealthy	Charging	Solid Red
		Charge Fault	Fast Blinking Red (2 blinks/second)
		Charge Complete	Solid Red
	N/A	No Battery	No indication
Sleep	Healthy	Charging	Pulsing Amber
		Charge Fault	Fast Blinking Red (2 blinks/second) <other lights off>
		Charge Complete	Pulsing Green
	Unhealthy	Charging	Pulsing Red
		Charge Fault	Fast Blinking Red (2 blinks/second) <other lights off>
		Charge Complete	Pulsing Red
	N/A	No Battery	Sleep disabled when battery removed
Boot/Shutdown	Healthy	Charging	Slow Blinking Amber (1 blink/2 seconds)
		Charge Fault	Fast Blinking Red (2 blinks/second)
		Charge Complete	Slow Blinking Green (1 blink/2 seconds)
	Unhealthy	Charging	Slow Blinking Red (1 blink/2 seconds)
		Charge Fault	Fast Blinking Red (2 blinks/second)
		Charge Complete	Slow Blinking Red (1 blink/2 seconds)
	N/A	No Battery	(Battery Graph) Fast Blinking Green (2 blinks/second)

Appendix C

Battery Disposal



The EPA certified RBRC® Battery Recycling Seal on the Lithium-Ion (Li-ion) battery supplied with your printer indicates Zebra Technologies Corporation is voluntarily participating in an industry program to collect and recycle these batteries at the end of their useful life, when taken out of service in the United States or Canada. The RBRC program provides a convenient alternative to placing used Li-ion batteries into the trash or the municipal waste stream, which may be illegal in your area.



Important • When the battery is worn out, insulate the terminals with tape before disposal

Please call 1-800-8-BATTERY for information on Li-ion battery recycling and disposal bans/restrictions in your area. Zebra Technologies Corporation's involvement in this program is part of our commitment to preserving our environment and conserving our natural resources.

Outside North America, please follow local battery recycling guidelines.

Product Disposal



Do not dispose of this product in unsorted municipal waste. This product is recyclable. Please recycle according to your local standards.



Appendix D

Maintenance Supplies

In addition to using quality media provided by Zebra, it is recommended that the printer be cleaned as prescribed in the maintenance section on Page 51. The following item is available for this purpose:

- Cleaning Pen (12 pack): p/n 105950-035

Appendix E

Using Zebra.com

The following examples illustrate the search function on Zebra's website for finding specific documents and downloads.

Example 1: Find the ZQ300 Series User Guide

Go to <http://www.zebra.com/us/en/support-downloads.html>

Enter the appropriate ZQ300 printer name where indicated.

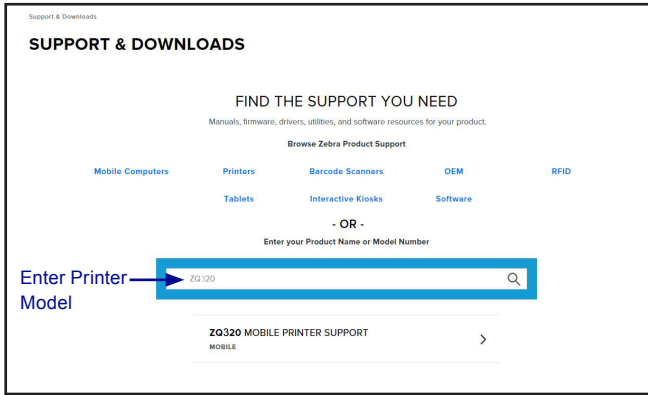

Click on the Manuals tab to navigate to all ZQ300 Series documentation.

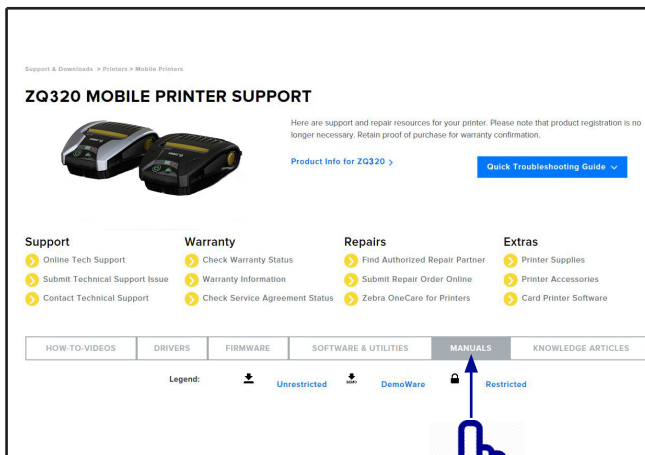

Example 2: Find ZebraNet Bridge Enterprise and Other Software Downloads

Go to <https://www.zebra.com/us/en/products/software/barcode-printers.html> and click on The ZebraLink Environment to go the Software downloads page.

Products > Software > Barcode Printer Software

BARCODE PRINTER SOFTWARE

CREATE CUSTOMIZED PRINT SOLUTIONS OR CONNECT YOUR PRINTER TO THE CLOUD WITH ZEBRA SOFTWARE SOLUTIONS

Zebra has created the Link-OS environment to answer the needs for the growing mobile world with an open platform that pairs an operating system for smart Zebra devices with powerful software apps, making the devices easy to integrate, manage and maintain from any location.

Use the ZebraLink suite of tools to quickly configure printers, create label designs and manage commonly used settings.

THE ZEBRALINK ENVIRONMENT >

The ZebraLink™ software and tools makes it simple to design, manage and adapt a barcode application tailored to meet your unique business needs.

ABOUT

- Global Local Support
- Contact Tech Support
- How to Buy
- Company Information
- Investor Relations
- Newsroom
- Careers
- Resource Library
- Preference Center

THE LINK-OS ENVIRONMENT >

Demand is growing for devices that are mobile, intelligent and connected to the cloud. This emerging need calls for new technologies and solutions. In response, Zebra has created the Link-OS environment.

WE ARE GLOBAL

FOLLOW ZEBRA

- LINKEDIN
- TWITTER
- FACEBOOK
- YOUTUBE
- ZEBRA BLOG

Click on the appropriate tab to find and access the latest versions of software.

ZEBRALINK BARCODE PRINTING SOFTWARE

The ZebraLink™ suite of software and tools makes it simple to design, manage and adapt a barcode printing application tailored to meet your unique business needs.

You'll get your Zebra printers up and running with minimal IT attention or process disruptions—enabling you to keep strategic initiatives on schedule and current operators functioning at full tilt.

Resources

- [Software Management Brochure >](#)
- [Global Printing Solution >](#)
- [APL-IO >](#)
- [Wavelink >](#)

Find a Partner
Contact Zebra

DESIGN	MANAGE	ADAPT	ENTERPRISE SOFTWARE	DISCONTINUED SOFTWARE
--------	--------	-------	---------------------	-----------------------

ZebraDesigner v2 >

ZebraDesigner v2 barcode label design software offers basic design features.

ZebraDesigner for mSAP >

With ZebraDesigner™ for mSAP® Business Suite v2 label design software, you can easily design within a user-friendly interface – and print directly from SAP's mSAP® Business Suite environment.

ZebraNet Bridge Enterprise >

Easily design, manage, and monitor your printer operations with ZebraNet Bridge Enterprise.

Zebra Setup Utility >

The Zebra Setup Utility enhances the out-of-box configuration tasks.

Multipassions SDK >

The Link-OS Multipassions SDK delivers all the tools needed for mobile custom solution development across multiple environments and infrastructures.

Customizable Front Panel >

Allows users to create their own printer skins.

ZebraDesigner Pro >

ZebraDesigner Pro v2 barcode label design software makes creating complex labels on fixed or variable data simple.

Zebra Utilities for iOS >

The Zebra Utilities enables printing from iOS devices.

Mixer >

The patent-based Mixer feature uses FIFO to manage networked printers.

ZBI Key Manager >

Manages and distributes ZBI enrollment keys to printers.

Alternative Programming Languages >

Alternative Programming Languages are a customized version of ZebraLink that allow third-party printers to use commands normally associated with other printer brands.

ZebraDesigner for XML v2 >

ZebraDesigner for XML v2 offers both the label design software features and printer configuration tools that enable printing on Zebra's XML-enabled printers.

Zebra Utilities for Android >

The Zebra Utilities enables printing from Android devices.

Scan & Print >

Simple printer printing solution for Symbol Windows Mobile/CE devices.

ZBI >

A printer-based system that allows programs to run directly on the device.

Product Support Contacts



In the Americas contact:

Regional Headquarters	Technical Support	Customer Service Dept.
Zebra Technologies Corporation 3 Overlook Point Lincolnshire, Illinois 60069 U.S.A. T: +1 847 634 6700 Toll Free: +1 866 230 9494 F: +1 847 913 8766	T: +1 877 275 9327 F: +1 847 913 2578 Hardware: ts1@zebra.com Software: ts3@zebra.com	For printers, parts, media, and ribbon, please call your distributor, or contact us. T: +1 877 275 9327 E: clientcare@zebra.com



In Europe, Africa, the Middle East, and India contact:

Regional Headquarters	Technical Support	Customer Service Dept.
Zebra Technologies Europe Limited Dukes Meadow Millboard Road Bourne End Buckinghamshire SL8 5XF, UK T: +44 (0)1628 556000 F: +44 (0)1628 556001	T: +44 (0) 1628 556039 F: +44 (0) 1628 556003 E: Tseurope@zebra.com	For printers, parts, media, and ribbon, please call your distributor, or contact us. T: +44 (0) 1628 556032 F: +44 (0) 1628 556001 E: cseurope@zebra.com



In the Asia Pacific region contact:

Regional Headquarters	Technical Support	Customer Service Dept.
Zebra Technologies Asia Pacific Pte. Ltd. 120 Robinson Road #06-01 Parakou Building Singapore 068913 T: +65 6858 0722 F: +65 6885 0838	T: +65 6858 0722 F: +65 6885 0838 E: (China) tschina@zebra.com All other areas: tsasiapacific@zebra.com	For printers, parts, media, and ribbon, please call your distributor, or contact us. T: +65 6858 0722 F: +65 6885 0836 E: (China) order-csr@zebra. com All other areas: csasiapacific@zebra.com

Index

A

- Accessories
 - 3-Slot Battery Charger 19
 - 1-Slot Battery Charger 18
 - AC-to-USB Adapter 17
 - 5-Bay Docking Cradle 20
 - 1-Bay Docking Cradle 21
 - Belt clip 50
 - list of 73
 - Shoulder Strap 51

B

- Battery, charging 17
- Battery, installing 15
- Battery, tape insulator 14
- Battery, removing 13
- Battery, safety 16
- Black Mark Dimensions 25
- Bluetooth™ Minimum Security Modes 45

C

- Cable Communication 41
- Charger Safety 16
- Cleaning
 - general instructions 53
- Communications
 - with a cable 41
- Configuration Label
 - printing 38
 - sample 60

D

- Designing Labels 24
- Draft Mode 39

F

- Font & Barcode Specs
 - ZPL 65

G

- Getting Ready to Print 13

I

- Introduction to ZQ300 Series Printer 7

K

- Keep-Out Areas 29

L

- Label Design 24

M

- Media
 - loading 30
 - spacers 31

N

- NFC Tag 47

O

- Operator Controls 32

P

- Preventive Maintenance 53
- Power Save Mode 39
- Programming language
 - ZPL/CPCL 7

S

- Safety Precautions
 - battery 16
 - charger 16
- Shoulder Strap 51
- Sleep Mode 38
- Software 7
- Soft Case 52
- Specifications
 - Media 63
 - Memory/Communications 63
 - Physical 70
 - printing 63

T

- Technical Support, contacting 80
- Troubleshooting
 - Communications Diagnostics Mode 58
 - control panel indicators 56
- Troubleshooting tests 58
 - printing a configuration label 38
 - ZQ320 configuration label example 60
- Troubleshooting Topics 56

W

- Wearing the Printer 50
- Wireless communications
 - Bluetooth™ radio 44
 - WLAN Overview 48

Z

- Zebra Setup Utilities 43
- Zebra Printer Setup Utility (Android) 43
- ZPL Font and Bar Code Specifications and Commands 64



Zebra Technologies Corporation
3 Overlook Point
Lincolnshire, IL 60069 USA
P: +1 847.634.6700 or F: +1 847.913.8766