

Dell EMC PowerEdge R740xd

Technical Specifications

Notes, cautions, and warnings

 **NOTE:** A NOTE indicates important information that helps you make better use of your product.

 **CAUTION:** A CAUTION indicates either potential damage to hardware or loss of data and tells you how to avoid the problem.

 **WARNING:** A WARNING indicates a potential for property damage, personal injury, or death.

Chapter 1: Technical specifications	4
System dimensions.....	4
Chassis weight.....	5
Processor specifications.....	5
Supported operating systems.....	6
PSU specifications.....	6
System battery specifications.....	7
Expansion bus specifications.....	7
Memory specifications.....	10
Storage controller specifications.....	10
Drive specifications.....	11
Drives.....	11
Ports and connectors specifications.....	11
USB ports.....	11
NIC ports.....	12
VGA ports.....	12
Serial connector.....	12
Internal Dual SD Module or vFlash card.....	12
Video specifications.....	12
Environmental specifications.....	13
Standard operating temperature.....	14
Expanded operating temperature.....	14
Particulate and gaseous contamination specifications.....	16

Technical specifications

The technical and environmental specifications of your system are outlined in this section.

Topics:

- [System dimensions](#)
- [Chassis weight](#)
- [Processor specifications](#)
- [Supported operating systems](#)
- [PSU specifications](#)
- [System battery specifications](#)
- [Expansion bus specifications](#)
- [Memory specifications](#)
- [Storage controller specifications](#)
- [Drive specifications](#)
- [Ports and connectors specifications](#)
- [Video specifications](#)
- [Environmental specifications](#)

System dimensions

This section describes the physical dimensions of the system.

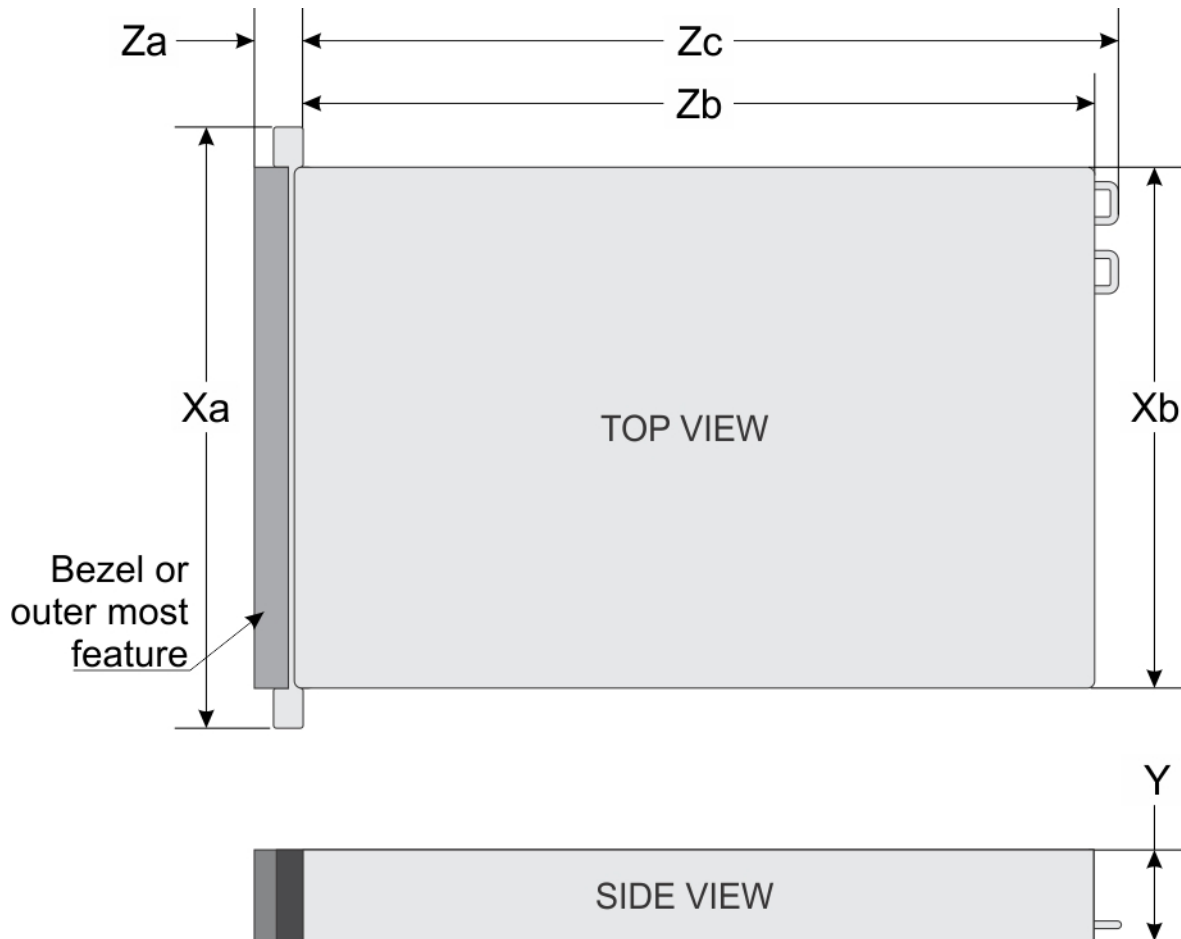

Figure 1. System dimensions of PowerEdge R740xd system

Table 1. Dimensions

System	Xa	Xb	Y	Za (with bezel)	Za (without bezel)	Zb	Zc
PowerEdge R740xd	482.0 mm (18.98 inches)	434.0 mm (17.09 inches)	86.8 mm (3.42 inches)	35.84 mm (1.41 inches)	22.0 mm (0.87 inches)	678.8 mm (26.72 inches)	715.5 mm (28.17 inches)

Chassis weight

Table 2. Chassis weight

System	Maximum weight (with all drives/SSDs)
2.5 inch drive systems	28.1 kg (61.95 lb)
3.5 inch drive systems	33.1 kg (72.91 lb)

Processor specifications

The PowerEdge R740xd system supports up to two Intel Xeon Processor Scalable Family processors, up to 28 cores per processor.

NOTE: Processor sockets are not hot pluggable.

Supported operating systems

The PowerEdge R740xd supports the following operating systems:

Canonical Ubuntu LTS

Citrix XenServer

Microsoft Windows Server with Hyper-V

Red Hat Enterprise Linux

SUSE Linux Enterprise Server

VMware ESXi

 **NOTE:** For more information, go to www.dell.com/ossupport.

PSU specifications

The PowerEdge R740xd system supports up to two AC or DC power supply units (PSUs).

Table 3. PSU specifications

PSU	Class	Heat dissipation (maximum)	Frequency	Voltage	High line 200v240 V	Low line 100– 140 V	DC	Current
495 W AC	Platinum	1908 BTU/hr	50/60 Hz	100–240 V AC, autoranging	495 W	495 W	NA	6.5 A–3 A
750 W AC	Platinum	2891 BTU/hr	50/60 Hz	100–240 V AC, autoranging	750 W	750 W	NA	10 A–5 A
750 W AC	Titanium	2843 BTU/hr	50/60 Hz	200–240 V AC, autoranging	750 W		NA	5 A
750 W Mixed Mode HVDC (for China only)	Platinum	2891 BTU/hr	50/60 Hz	100–240 V AC, autoranging	750 W	750 W	NA	10 A–5 A
	Platinum	2891 BTU/hr	N/A	240 V DC, autoranging	NA	NA	750W	4.5 A
750 W Mixed Mode	Platinum	2891 BTU/hr	50/60 Hz	100–240 V AC, autoranging	750 W	750 W	NA	10 A–5 A
	Platinum(F or China only)	2891 BTU/hr	N/A	240 V DC, autoranging	NA	NA	750 W	5 A
1100 W AC	Platinum	4100 BTU/hr	50/60 Hz	100–240 V AC, autoranging	1100 W	1050 W		12 A–6.5 A
1100 W DC	N/A	4416 BTU/hr	N/A	–(48 V to –60 V) DC, autoranging	NA	NA	1100 W	32 A
1100 W Mixed Mode HVDC (for China and Japan only)	Platinum	4100 BTU/hr	50/60 Hz	100–240 V AC, autoranging	1100 W	1050 W		12 A–6.5 A
	N/A	4100 BTU/hr	N/A	200–380 V DC, autoranging	NA	NA	1100 W	6.4 A–3.2 A
1600 W AC	Platinum	6000 BTU/hr	50/60 Hz	100–240 V AC, autoranging	1600 W	800 W	NA	10 A

Table 3. PSU specifications (continued)

PSU	Class	Heat dissipation (maximum)	Frequency	Voltage	High line 200v240 V	Low line 100– 140 V	DC	Current
2000 W AC	Platinum	7500 BTU/hr	50/60 Hz	100–240 V AC, autoranging	2000 W	1000 W	NA	11.5 A
2400 W AC	Platinum	9000 BTU/hr	50/60 Hz	100–240 V AC, autoranging	2400 W	1400 W	NA	16 A

- NOTE:** Heat dissipation is calculated using the PSU wattage rating.
- NOTE:** This system is also designed to connect to the IT power systems with a phase to phase voltage not exceeding 240 V.
- NOTE:** PSUs rated for 1100 W Mixed Mode HVDC or 1100 W AC and higher require high-line voltage (200–240 V AC) to supply their rated capacity.

System battery specifications

The PowerEdge R740xd system supports CR 2032 3.0-V lithium coin cell system battery.

Expansion bus specifications

The PowerEdge R740xd system supports up to eight PCI express (PCIe) generation 3 expansion cards that can be installed on the system board using expansion card risers. The following table provides detailed information about the expansion card riser specifications:

Table 4. Expansion card riser configurations

Expansion card riser	PCIe slots on the riser	Height	Length	Link
Riser 1A	Slot 1	Full Height	Full Length	x16
	Slot 3	Full Height	Half Length	x16
Riser 1B	Slot 1	Full Height	Full Length	x8
	Slot 2	Full Height	Full Length	x8
	Slot 3	Full Height	Half Length	x8
Riser 1D	Slot 1	Full Height	Full Length	x16
	Slot 2	Full Height	Full Length	x8
	Slot 3	Full Height	Half Length	x8
Riser 2A or 2E or 2D or 2F	Slot 4	Full Height	Full Length	x16
	Slot 5	Full Height	Full Length	x8
	Slot 6	Low Profile	Half Length	x8
Riser 2B	Slot 4	Low Profile	Half Length	x8
Riser 2C	Slot 4	Low Profile	Half Length	x16
Riser 3A or 3B	Slot 7	Full Height	Full Length	x8
	Slot 8	Full Height	Full Length	x16

Table 5. Expansion card riser specifications

Riser configuration and supported risers	Slot description	PCIe slots on riser 1 (Height and length)	Processor connection	PCIe slots on riser 2 (Height and length)	Processor connection	PCIe slots on riser 3 (Height and length)	Processor connection
Riser configuration 0 with or without rear storage (No riser)	No PCIe slots (only rear storage)	N/A	N/A	N/A	N/A	N/A	N/A
Riser configuration 1 with or without rear storage (1B+2 B)	Four x8 slots and rear storage	Slot 1: x8 full-height, full length	Processor 1	Slot 4: x8 low profile, half length	Processor 1	N/A	N/A
		Slot 2: x8 full-height, full length	Processor 1				
		Slot 3: x8 full-height, half length	Processor 1				
Riser configuration 2 with or without rear storage (1B+2C)	Three x8 and one x16 slots and rear storage	Slot 1: x8 full-height, full length	Processor 1	Slot 4: x16 low profile, half length	Processor 2	N/A	N/A
		Slot 2: x8 full-height, full length	Processor 1				
		Slot 3: x8 full-height, half length	Processor 1				
Riser configuration 3 (1A+2A)	Two x8 and three x16 slots	Slot 1: x16 full-height, full length	Processor 1	Slot 4: x16 full-height, full length	Processor 2	N/A	N/A
		N/A	N/A	Slot 5: x8 full-height, full length	Processor 2		
		Slot 3: x16 full-height, half length	Processor 1	Slot 6: x8 low profile, half length	Processor 1		
Riser configuration 4 (1A+2A+3A)	Three x8 and four x16 slots	Slot 1: x16 full-height, full length	Processor 1	Slot 4: x16 full-height, full length	Processor 2	Slot 7: x8 full-height, full length	Processor 2
		N/A	N/A	Slot 5: x8 full-height, full length	Processor 2	Slot 8: x16 full-height, full length	Processor 2
		Slot 3: x16 full-height, half length	Processor 1	Slot 6: x8 low profile, half length	Processor 1		
Riser configuration 15 (1A+2E+3B)	Three x8 and four x16 slots	Slot 1: x16 full-height, full length	Processor 1	Slot 4: x16 full-height, full length	Processor 2	Slot 7: x8 full-height, full length	Processor 2
		N/A	N/A	Slot 5: x8 full-height, full length	Processor 2	Slot 8: x16 full-height, full length	Processor 2

Table 5. Expansion card riser specifications (continued)

Riser configuration and supported risers	Slot description	PCIe slots on riser 1 (Height and length)	Processor connection	PCIe slots on riser 2 (Height and length)	Processor connection	PCIe slots on riser 3 (Height and length)	Processor connection
		Slot 3: x16 full-height, half length	Processor 1	Slot 6: x8 low profile, half length	Processor 1		
Riser configuration 5 (1B+2A+3A)	Six x8 and two x16 slots	Slot 1: x8 full-height, full length	Processor 1	Slot 4: x16 full-height, full length	Processor 2	Slot 7: x8 full-height, full length	Processor 2
		Slot 2: x8 full-height, full length	Processor 1	Slot 5: x8 full-height, full length	Processor 2	Slot 8: x16 full-height, full length	Processor 2
		Slot 3: x8 full-height, half length	Processor 1	Slot 6: x8 low profile, half length	Processor 1		
Riser configuration 6 (1D+2A+3A)	Five x8 and three x16 slots	Slot1: x16 full-height, full length	Processor 1	Slot 4: x16 full-height, full length	Processor 2	Slot 7: x8 full-height, full length	Processor 2
		Slot 2: x8 full-height, full length	Processor 1	Slot 5: x8 full-height, full length	Processor 2	Slot 8: x16 full-height, full length	Processor 2
		Slot 3: x8 full-height, half length	Processor 1	Slot 6: x8 low profile, half length	Processor 1		
Riser configuration 16 (1D+2E+3B)	Five x8 and three x16 slots	Slot1: x16 full-height, full length	Processor 1	Slot 4: x16 full-height, full length	Processor 2	Slot 7: x8 full-height, full length	Processor 2
		Slot 2: x8 full-height, full length	Processor 1	Slot 5: x8 full-height, full length	Processor 2	Slot 8: x16 full-height, full length	Processor 2
		Slot 3: x8 full-height, half length	Processor 1	Slot 6: x8 low profile, half length	Processor 1		
Riser configuration 9 (1A+2D+3A) or Riser configuration 17 (1A+2F+3B)	Three x8 and four x16 slots	Slot 1: x16 full-height, full length	Processor 1	Slot 4: x16 full-height, full length	Processor 2	Slot 7: x8 full-height, full length	Processor 2
		N/A	N/A	Slot 5: x8 full-height, full length	Processor 2	Slot 8: x16 full-height, full length	Processor 2
		Slot 3: x16 full-height, half length	Processor 1	Slot 6: x8 low profile, half length	Processor 1		

NOTE:

- Riser slots are not hot pluggable.
- Internal cable connectors are not hot pluggable.

Memory specifications

Table 6. Memory specifications

Memory module sockets	DIMM type	DIMM rank	DIMM capacity	Single processor		Dual processors	
				Minimum RAM	Maximum RAM	Minimum RAM	Maximum RAM
Twenty four 288-pins	LRDIMM	Octa rank	128 GB	128 GB	1.5 TB	256 GB	3 TB
		Quad rank	64 GB	64 GB	768 GB	128 GB	1.5 TB
	RDIMM	Single rank	8 GB	8 GB	96 GB	16 GB	192 GB
		Dual rank	16 GB	16 GB	192 GB	32 GB	384 GB
		Dual rank	32 GB	32 GB	384 GB	64 GB	768 GB
	NVDIMM -N	Single rank	16 GB	Not supported with single processor	Not supported with single processor	RDIMM: 192 GB	RDIMM: 384 GB
						NVDIMM-N: 16 GB	NVDIMM-N: 192 GB
	DCPMM	NA	128 GB	RDIMM: 192GB	RDIMM: 384 GB	RDIMM: 384 GB	LRDIMM: 1536 GB
						DCPMM: 128 GB	DCPMM: 128 GB
		NA	256 GB	NA	NA	RDIMM: 192 GB	LRDIMM: 1536 GB
						NA	NA
		NA	512 GB	NA	NA	RDIMM: 384 GB	RDIMM: 1536 GB
						NA	NA

- NOTE:** 8 GB RDIMMs and NVDIMM-N must not be mixed.
- NOTE:** 64 GB LRDIMMs, 128 GB LRDIMMs must not be mixed.
- NOTE:** Minimum of two CPUs are required for any configurations that support NVDIMM-N.
- NOTE:** DCPMM can be mixed with RDIMMs and LRDIMMs.
- NOTE:** Mixing of DDR4 DIMM Types (RDIMM, LRDIMM), within channel, integrated memory controller, socket, or across sockets is not supported.
- NOTE:** x4 and X8 DDR4 DIMM can be mixed within channel.
- NOTE:** Mix of Intel Data center persistent memory module operating modes (App Direct, Memory Mode) is not supported within socket or across sockets.
- NOTE:** Memory DIMM slots are not hot pluggable.

Storage controller specifications

The PowerEdge R740xd system supports:

- Internal storage controller cards: PowerEdge RAID Controller PERC H730P, PERC H740P, HBA330, S140, Boot Optimized Server Storage (BOSS-S1), H750 (adapter only) and HBA350i

The BOSS card is a simple RAID solution card designed specifically for booting a server's operating system. The card supports up to two 6 Gbps M.2 SATA drives. The BOSS adapter card has a x8 connector using PCIe gen 2.0 x2 lanes, available only in the low-profile and half-height form factor.

- External storage controller cards: PERC H840, 12Gbps SAS HBA, and HBA355e.

NOTE: Mini-PERC socket is not hot pluggable.

NOTE: H750 and HBA350i cards cannot be mixed with H730P, H740P, and HBA330 cards.

Drive specifications

Drives

The PowerEdge R740XD system supports SAS, SATA, Nearline SAS hard drives/SSDs, or NVMe drives.

Table 7. Supported drive options for the PowerEdge R740XD system

Configuration	Description
12 drives system	Up to 12 3.5 inch (SAS, SATA, or Nearline SAS) front accessible drives in slots 0–11
14 drives system	Up to 12 3.5 inch (SAS, SATA, or Nearline SAS) front accessible drives in slots 0–11 and up to two 3.5 inch (SAS, SATA or Nearline SAS) rear accessible drives in slots 12–13
16 drives system	Up to 12 3.5 inch (SAS, SATA, or Nearline SAS) front accessible drives in slots 0–11 and up to four 2.5 inch (SAS, SATA or Nearline SAS) rear accessible drives in slots 12–15
18 drives system	Up to 12 3.5 inch (SAS, SATA, or Nearline SAS) front accessible drives in slots 0–11, up to four 3.5 inch (SAS, SATA, or Nearline SAS) mid drives in slots 14–17, and up to two 3.5 inch (SAS, SATA or Nearline SAS) rear accessible drives in slots 12–13
20 drives system	Up to 12 3.5 inch (SAS, SATA, or Nearline SAS) front accessible drives in slots 0–11, up to four 3.5 inch (SAS, SATA, or Nearline SAS) mid drives in slots 16–19, and up to four 2.5 inch (SAS, SATA or Nearline SAS) rear accessible drives in slots 12–15
24 drives system	Up to 24 2.5 inch (SAS, SSD, or NVMe) front accessible drives in slots 0–23
24 drives system	Up to 12 2.5 inch (SAS, SSD) front accessible drives in slots 0–11 and up to 12 2.5 inch SATA/SAS/NVMe drives in 12 universal slots 12–23
24 drives system	Up to 24 2.5 inch NVMe drives in bay 1 (slots 0–11) and bay 2 (slots 0–11)
24 drives system	Up to 24 2.5 inch NVMe drives or up to eight 2.5 inch (SAS or SATA) drives in bay 1 (slots 0–7) with NVMe drives in other slots
28 drives system	Up to 24 2.5 inch (SAS, SSD, or NVMe) front accessible drives in slots 0–23 and up to four 2.5 inch (SAS, SSD, or NVMe) rear accessible drives in slots 24–27.
32 drives system	Up to 24 2.5 inch (SAS, SSD, or NVMe) front accessible drives in slots 0–23, up to four 2.5 inch (SAS, SSD, or NVMe) mid drives in slots 28–31, and up to four 2.5 inch (SAS, SSD, or NVMe) rear accessible drives in slots 24–27

NOTE: Universal slots are slots that support SAS, SATA hard drives/SSDs, or NVMe drives in the same slot.

Ports and connectors specifications

USB ports

The PowerEdge R740xd system supports:

- Two USB 2.0-compliant ports on the front of the system
- One internal USB 3.0-compliant port
- One micro USB 2.0-compliant port in the front of the system for iDRAC Direct
- Two USB 3.0-compliant ports on the back of the system

NIC ports

The PowerEdge R740xd system supports up to four Network Interface Controller (NIC) ports that are integrated on the network daughter card (NDC), and are available in the following configurations:

- Four RJ-45 ports that support 10, 100 and 1000 Mbps
- Four RJ-45 ports that support 100 M, 1 G and 10 Gbps
- Four RJ-45 ports, where two ports support maximum of 10 G and the other two ports maximum of 1 G
- Two RJ-45 ports that support up to 1 Gbps and 2 SFP+ ports that support up to 10 Gbps
- Four SFP+ ports that support up to 10 Gbps
- Two SFP28 ports that support up to 25 Gbps

 **NOTE:** You can install up to eight PCIe add-on NIC cards.

 **NOTE:** NDC slot is not hot pluggable.

VGA ports

The Video Graphic Array (VGA) port enables you to connect the system to a VGA display. The PowerEdge R740xd system supports two 15-pin VGA ports on the front and back panels.

 **NOTE:** The VGA ports are not hot pluggable.

Serial connector

The PowerEdge R740xd system supports one serial connector on the back panel, which is a 9-pin connector, Data Terminal Equipment (DTE), 16550-compliant.

 **NOTE:** The Serial port is not hot pluggable.

Internal Dual SD Module or vFlash card

The PowerEdge R740xd system supports Internal Dual SD module (IDSDM) and vFlash card. In 14th generation of PowerEdge servers, IDSDM and vFlash card are combined into a single card module, and are available in these configurations:

- vFlash or
- IDSDM or
- vFlash and IDSDM

The IDSDM/vFlash card sits in the back of the system, in a Dell-proprietary slot. IDSDM/vFlash card supports three micro SD cards (two cards for IDSDM and one card for vFlash). Micro SD cards capacity for IDSDM are 16/32/64 GB while for vFlash the microSD card capacity is 16 GB.

 **NOTE:** IDSDM and vFlash slot is not hot pluggable.

Video specifications

The PowerEdge R740xd system supports integrated Matrox G200eW3 graphics controller with 16 MB of video frame buffer.

Table 8. Supported video resolution options

Resolution	Refresh rate (Hz)	Color depth (bits)
1024 x 768	60	8, 16, 32
1280 x 800	60	8, 16, 32
1280 x 1024	60	8, 16, 32
1360 x 768	60	8, 16, 32
1440 x 900	60	8, 16, 32
1600 x 900	60	8, 16, 32
1600 x 1200	60	8, 16, 32
1680 x 1050	60	8, 16, 32
1920 x 1080	60	8, 16, 32
1920 x 1200	60	8, 16, 32

NOTE: 1920 x 1080 and 1920 x 1200 resolutions are only supported in reduced blanking mode.

Environmental specifications

NOTE: For additional information about environmental certifications, please refer to the Product Environmental Datasheet located with the Manuals & Documents on www.dell.com/poweredge/manuals.

Table 9. Temperature specifications

Temperature	Specifications
Storage	-40°C to 65°C (-40°F to 149°F)
Continuous operation (for altitude less than 950 m or 3117 ft)	10°C to 35°C (50°F to 95°F) with no direct sunlight on the equipment.
Maximum temperature gradient (operating and storage)	20°C/h (36°F/h)

Table 10. Relative humidity specifications

Relative humidity	Specifications
Storage	5% to 95% RH with 33°C (91°F) maximum dew point. Atmosphere must be non-condensing at all times.
Operating	10% to 80% relative humidity with 29°C (84.2°F) maximum dew point.

Table 11. Maximum vibration specifications

Maximum vibration	Specifications
Operating	0.26 G _{rms} at 5 Hz to 350 Hz (all three axes).
Storage	1.88 G _{rms} at 10 Hz to 500 Hz for 15 min (all six sides tested).

Table 12. Maximum shock specifications

Maximum shock	Specifications
Operating	Six consecutively executed shock pulses in the positive and negative x, y, and z axes of 6 G for up to 11 ms.

Table 12. Maximum shock specifications (continued)

Maximum shock	Specifications
Storage	Six consecutively executed shock pulses in the positive and negative x, y, and z axes (one pulse on each side of the system) of 71 G for up to 2 ms.

Table 13. Maximum altitude specifications

Maximum altitude	Specifications
Operating	3048 m (10,000 ft)
Storage	12,000 m (39,370 ft)

Table 14. Operating temperature de-rating specifications

Operating temperature de-rating	Specifications
Up to 35°C (95°F)	Maximum temperature is reduced by 1°C/300 m (1.8°F/547 ft) above 950 m (3,117 ft).
35°C to 40°C (95°F to 104°F)	Maximum temperature is reduced by 1°C/175 m (1.8°F/319 ft) above 950 m (3,117 ft).
40°C to 45°C (104°F to 113°F)	Maximum temperature is reduced by 1°C/125 m (1.8°F/228 ft) above 950 m (3,117 ft).

Standard operating temperature

Table 15. Standard operating temperature specifications

Standard operating temperature	Specifications
Continuous operation (for altitude less than 950 m or 3117 ft)	10°C to 35°C (50°F to 95°F) with no direct sunlight on the equipment.
Humidity percentage range	10% to 80% Relative Humidity with 29°C (84.2°F) maximum dew point.

Expanded operating temperature

Table 16. Expanded operating temperature specifications

Expanded operating temperature	Specifications
Continuous operation	<p>5°C to 40°C at 5% to 85% RH with 29°C dew point.</p> <p>i NOTE: Outside the standard operating temperature (10°C to 35°C), the system can operate continuously in temperatures as low as 5°C and as high as 40°C.</p> <p>For temperatures between 35°C to 40°C, de-rate maximum allowable temperature by 1°C per 175 m above 950 m (1.8°F per 319 ft).</p>
≤ 1% of annual operating hours	<p>–5°C to 45°C at 5% to 90% RH with 29°C dew point.</p> <p>i NOTE: Outside the standard operating temperature (10°C to 35°C), the system can operate down to –5°C or up to 45°C for a maximum of 1% of its annual operating hours.</p> <p>For temperatures between 40°C and 45°C, de-rate maximum allowable temperature by 1°C per 125 m above 950 m (1.8°F per 228 ft).</p>

i **NOTE:** When operating in the expanded temperature range, system performance may be impacted.

NOTE: When operating in the expanded temperature range, ambient temperature warnings may be reported in the System Event Log.

Expanded operating temperature restrictions

- 128 GB LRDIMM is not supported for FAC.
- Do not perform a cold startup below 5°C.
- The operating temperature specified is for a maximum altitude of 3050 m (10,000 ft).
- 150 W/8 core, 165 W/12 core and higher wattage processor [Thermal Design Power (TDP)>165 W] are not supported.
- Redundant power supply unit is required.
- Non-Dell qualified peripheral cards and/or peripheral cards greater than 25 W are not supported.
- PCIe SSD is not supported.
- NVDIMM-Ns are not supported.
- DCPMMs are not supported.
- Mid drive tray is not supported.
- Rear storage devices or drives are not supported.
- GPU is not supported.
- Tape backup unit is not supported.

Thermal restrictions

Following table lists the configuration required for efficient cooling.

Table 17. Thermal restrictions configuration

Configuration	Number of processors	Heatsink	Processor/DIMM blank	DIMM blanks	Type of air shroud	Fan
PowerEdge R740xd	1	One 1U standard heat sink for CPU ≤ 125 W	Required	Not required	Standard	Four standard fans and one blank to cover two fan slots
		One 2U standard heat sink for CPU > 125 W				
PowerEdge R740xd	2	Two 1U standard heat sink for CPU ≤ 125 W	Not required	Not required	Standard	Six standard fans
		Two 2U standard heat sink for CPU > 125 W				
PowerEdge R740xd with mid bay	1	One 1U high performance heat sink	Required	Required	Not required	Six high performance fans
PowerEdge R740xd with mid bay	2	Two 1U high performance heat sink	Not required	Required	Not required	Six high performance fans
PowerEdge R740xd with GPU	2	Two 1U high performance heat sink	Not required	Not required	GPU air shroud	Six high performance fans
PowerEdge R740xd with rear drive only	1	One 1U standard heat sink for CPU ≤ 125 W	Required	Not required	Standard	Six high performance fans
		One 2U standard heat sink for CPU > 125 W				
PowerEdge R740xd with rear drive only	2	Two 1U standard heat sink for CPU ≤ 125 W	Required	Not required	Standard	Six high performance fans
		Two 2U standard heat sink for CPU > 125 W				

Ambient temperature limitations

The following table lists configurations that require ambient temperature less than 35°C.

i **NOTE:** The ambient temperature limit must be adhered to ensure proper cooling and to avoid excess CPU throttling, which may impact system performance.

Table 18. Configuration based ambient temperature restrictions

System	Backplane	Processor Thermal Design Power (TDP)	Processor heat sink	Fan type	GPU	Ambient restriction
PowerEdge R740xd	12 x 3.5 inch SAS/SATA + 4 x 3.5 inch + 2 x 3.5 inch	150 W/8 core, 165 W/12 core, 200 W, 205 W	1U high performance	High performance fan	N/A	25°C
	24 x 2.5 inch SAS/SATA + 4 x 2.5 inch + 4 x 2.5 inch				N/A	25°C
	24 x 2.5 inch SAS/SATA				All	30°C
	24 x NVMe				All except V100 32 GB	30°C
	22 x NVMe				V100 32 GB	25°C

Particulate and gaseous contamination specifications

The following table defines the limitations that help avoid any equipment damage or failure from particulate and gaseous contamination. If the levels of particulate or gaseous pollution exceed the specified limitations and result in equipment damage or failure, you may need to rectify the environmental conditions. Remediation of environmental conditions is the responsibility of the customer.

Table 19. Particulate contamination specifications

Particulate contamination	Specifications
Air filtration	<p>Data center air filtration as defined by ISO Class 8 per ISO 14644-1 with a 95% upper confidence limit.</p> <p>i NOTE: The ISO Class 8 condition applies to data center environments only. This air filtration requirement does not apply to IT equipment designed to be used outside a data center, in environments such as an office or factory floor.</p> <p>i NOTE: Air entering the data center must have MERV11 or MERV13 filtration.</p>
Conductive dust	<p>Air must be free of conductive dust, zinc whiskers, or other conductive particles.</p> <p>i NOTE: This condition applies to data center and non-data center environments.</p>
Corrosive dust	<ul style="list-style-type: none"> Air must be free of corrosive dust. Residual dust present in the air must have a deliquescent point less than 60% relative humidity. <p>i NOTE: This condition applies to data center and non-data center environments.</p>

Table 20. Gaseous contamination specifications

Gaseous contamination	Specifications
Copper coupon corrosion rate	<300 Å/month per Class G1 as defined by ANSI/ISA71.04-2013.
Silver coupon corrosion rate	<200 Å/month as defined by ANSI/ISA71.04-2013.

 **NOTE:** Maximum corrosive contaminant levels measured at ≤50% relative humidity.