

Thor™ VM1

Vehicle-Mount Computer

Microsoft® Windows® Embedded Standard Operating System

User's Guide

Disclaimer

Honeywell International Inc. ("HII") reserves the right to make changes in specifications and other information contained in this document without prior notice, and the reader should in all cases consult HII to determine whether any such changes have been made. The information in this publication does not represent a commitment on the part of HII.

HII shall not be liable for technical or editorial errors or omissions contained herein; nor for incidental or consequential damages resulting from the furnishing, performance, or use of this material.

This document contains proprietary information that is protected by copyright. All rights are reserved. No part of this document may be photocopied, reproduced, or translated into another language without the prior written consent of HII.

© 2011-2013 Honeywell International Inc. All rights reserved.

Web Address: www.honeywellaidc.com

Microsoft® Windows, ActiveSync®, MSN, Outlook®, Windows Mobile®, the Windows logo, and Windows Media are registered trademarks or trademarks of Microsoft Corporation.

Intel® and Atom™ are trademarks or registered trademarks of Intel Corporation or its subsidiaries in the United States and other countries.

Summit Data Communications, the Laird Technologies Logo, the Summit logo, and "Connected. No Matter What" are trademarks of Laird Technologies, Inc.

The Bluetooth® word mark and logos are owned by the Bluetooth SIG, Inc.

Symbol® is a registered trademark of Symbol Technologies. MOTOROLA, MOTO, MOTOROLA SOLUTIONS and the Stylized M Logo are trademarks or registered trademarks of Motorola Trademark Holdings, LLC and are used under license.

RAM® and RAM Mount™ are both trademarks of National Products Inc., 1205 S. Orr Street, Seattle, WA 98108.

Freefloat, Freefloat Link*One and Freefloat Access*One are trademarks of Freefloat, Mölndalsvägen 30B, SE-412 63Gothenburg, Sweden.

Qualcomm® is a registered trademark of Qualcomm Incorporated. Gobi is a trademark of Qualcomm Incorporated.

OneClick Internet is WebToGo's patented connection manager customized for Honeywell mobile devices. OneClick Internet documentation is copyright 2010 by WebToGo and modified by Honeywell with WebToGo's express permission.

Verizon® is a registered trademark of Verizon Trademark Services LLC.

T-MOBILE® is a registered trademark of Deutsche Telekom AG.

AT&T® is a registered trademark of AT&T Intellectual Property.

PenMount, and the Pen Mount logo are registered trademarks of Salt International Corporation, Taipei, Taiwan, R.O.C.

Acrobat® Reader © 2013 with express permission from Adobe Systems Incorporated.

Other product names or marks mentioned in this document may be trademarks or registered trademarks of other companies and are the property of their respective owners.

Patents

For patent information, please refer to www.honeywellaidc.com/patents.

Limited Warranty

Refer to www.honeywellaidc.com/warranty_information for your product's warranty information.

Table of Contents

Chapter 1 - Introduction	1-1
About this Guide	1-1
Components	1-2
Front View	1-2
Back View Quick Mount Smart Dock	1-3
Access Panels	1-3
Keyboard Options	1-4
64-Key Keyboard	1-4
Secondary Key	1-5
Ctrl and Alt Key	1-5
USB Keyboard / Mouse	1-5
Chapter 2 - Set Up A New Thor VM1	2-1
Hardware Setup	2-1
Software Setup	2-1
Quick Mount Smart Dock	2-2
Preparing the Dock	2-3
Place the Thor VM1 in the Dock	2-4
Removing the Thor VM1 from the Dock	2-4
Backlights and Indicators	2-5
Display Backlight	2-5
Power Management	2-5
Backlight Brightness	2-5
Screen Blanking	2-5
Keypad Backlight	2-5
LED Functions	2-6
System LEDs	2-7
SYS (System Status) LED	2-7
UPS Status LED	2-8
External Power Present	2-8
External Power Not Present	2-8
SSD (Solid State Drive) LED	2-8
Connection LEDs	2-9
WWAN LED	2-9
WiFi LED	2-9
Bluetooth LED	2-9
Keyboard LEDs	2-10
2nd LED	2-10
Shift LEDs	2-10

Ctrl LED.....	2-10
Alt LED.....	2-11
Power Up.....	2-12
Tapping the Touch Screen with a Stylus.....	2-13
Thor VM1 Configuration Options.....	2-14
Date and Time.....	2-14
Power Management.....	2-14
Speaker Volume.....	2-14
Connect Bluetooth Devices.....	2-14
Restart/Shutdown.....	2-15
Calibrate Touch Screen.....	2-15
Touch Screen.....	2-16
Apply the Touch Screen Protective Film.....	2-16
Installation.....	2-16
Removal.....	2-17
Cleaning the Touch Screen.....	2-18
Startup Help.....	2-19
Chapter 3 - Connecting Cables to the Thor VM1.....	3-1
Connect Cable - USB Host.....	3-1
Connect Cable - Serial.....	3-2
Connect a Tethered Scanner.....	3-2
Connecting an AC/DC Power Supply.....	3-3
Connecting the Headset Cable.....	3-4
Adjust Headset / Microphone and Secure Cable.....	3-5
Connecting Vehicle Power.....	3-6
Vehicle 10-60VDC Power Connection.....	3-6
Connect Vehicle 10-60VDC.....	3-7
Ignition Control.....	3-8
Auto-On Control.....	3-9
Manual Control.....	3-10
VX6 / VX7 Adapter Cable.....	3-11
Vehicle 72-144VDC Power Connection.....	3-12
Connect Vehicle 72-144VDC.....	3-13
Wiring Diagram.....	3-14
Thor VM1 Screen Blanking.....	3-15
Screen Blanking Box.....	3-16
Screen Blanking with Switch.....	3-17
Fuse.....	3-18
Chapter 4 - Product Agency Compliance - Thor VM1.....	4-1

Lithium Battery Safety Statement	4-4
Vehicle Power Supply Connection Safety Statement	4-6
Chapter 5 - Technical Assistance	5-1



Chapter 1 - Introduction

The Honeywell Thor VM1 Vehicle Mount Computer (VMC) is a rugged, vehicle mounted computer running a Microsoft Windows® Embedded Standard operating system and capable of wireless data communications from a fork-lift truck or any properly configured vehicle.

The optional Bluetooth® module supports Honeywell Bluetooth printers and scanners. The Thor VM1 provides the power and functionality of a desktop computer in a vehicle mounted unit, with a wide range of options.

The Thor VM1 is designed for use with a vehicle Quick Mount Smart Dock. The dock installs in the vehicle and connects to vehicle power. The dock provides conditioned input power for the Thor VM1. Peripheral connections are on the dock. The Thor VM1 is designed to easily be removed from the dock with a latch on the lower rear of the Thor VM1 housing. Since the dock remains attached to the vehicle, the Thor VM1 computer can easily be moved from one vehicle equipped with a Quick Mount Smart Dock to another vehicle equipped with a Quick Mount Smart Dock.

The Thor VM1 contains a UPS battery which, when fully charged, can power the Thor VM1 for a minimum of 30 minutes. This can be when the Thor VM1 is not attached to a Quick Mount Smart Dock or when the Thor VM1 is attached to a dock but the vehicle power is interrupted, such as when the vehicle battery is being changed.

About this Guide

This Thor VM1 User's Guide provides instruction for the end-user or system administrator to follow when setting up a new Thor VM1.

This user's guide has been developed for a Thor VM1 with a Microsoft® Windows® Embedded Standard operating system.

Components

Front View

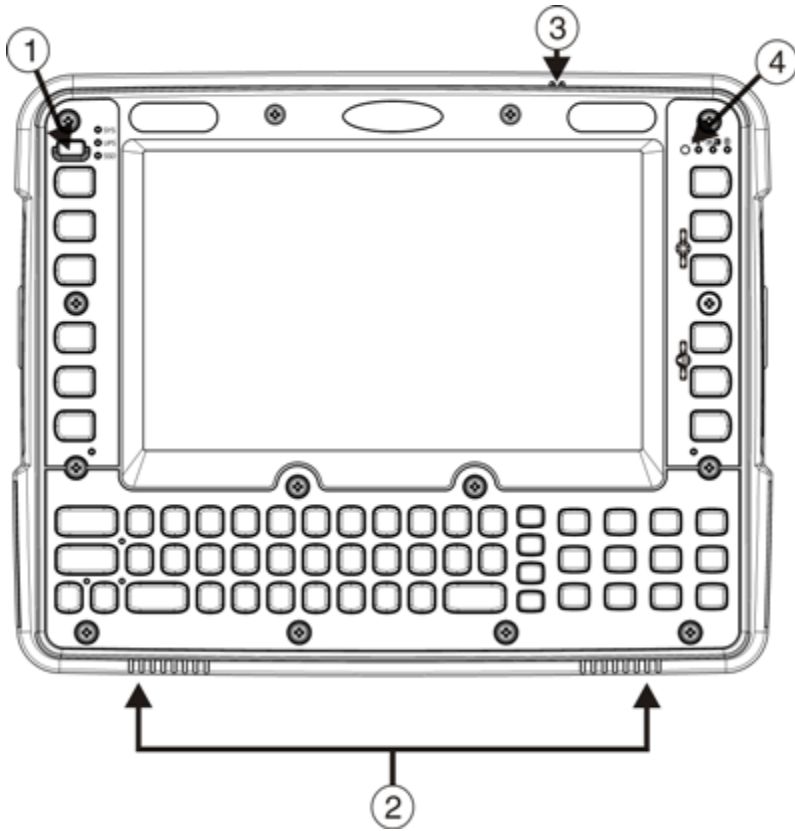

1. Power Button
2. Speakers
3. Microphone
4. Ambient Light Sensor

Back View Quick Mount Smart Dock

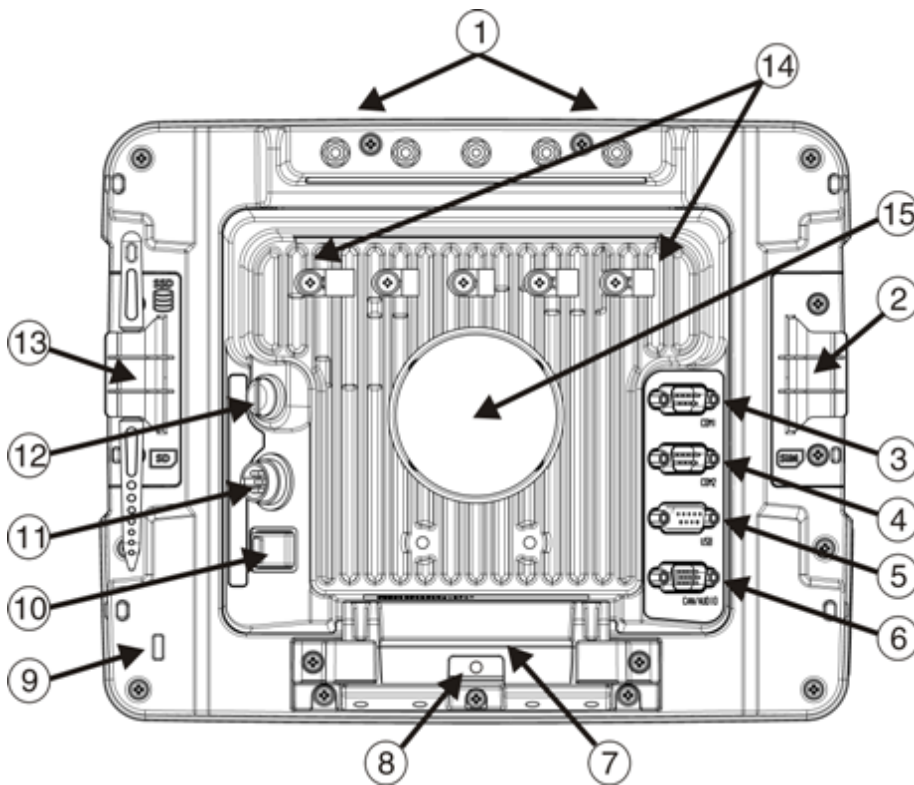

1. Antenna Connectors (on Thor VM1)
2. SIM card Access Panel (on Thor VM1)
3. COM1 Connector (on Dock)
4. COM2 Connector (on Dock)
5. USB Connector (on Dock)
6. CAN/Audio Connector (on Dock)
7. Quick Release Handle (On Thor VM1)
8. Provision for Padlock (on Thor VM1)
9. Provision for Laptop Security Cable (on Thor VM1)
10. Power Switch (on Dock)
11. Power Connector (on Dock)
12. Fuse (on Dock)
13. SD Card Access Panel (On Thor VM1)
14. Strain Relief Clamps (on Dock)
15. RAM Ball (on Dock)

Access Panels

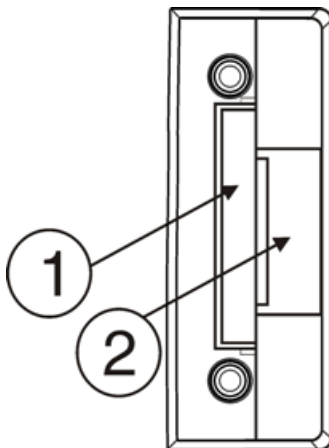

Access Panel Door is labeled with **SSD** and **SD**.

1. CompactFlash Hard Drive
2. SD (Secure Digital) Memory Card Slot

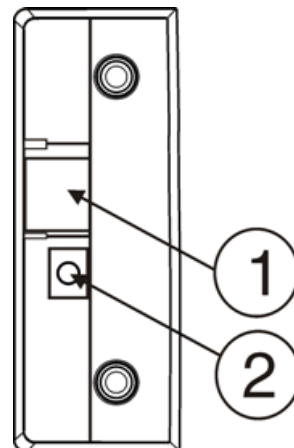

Access Panel Door is labeled with **SIM**.

1. SIM card slot for WWAN radio
2. UPS battery disconnect

Keyboard Options

The Thor VM1 has a 64-key keyboard.

64-Key Keyboard



The Thor VM1 64-key keyboard is a QWERTY keyboard, available with a standard overlay, an IBM 3270 overlay or an IBM 5250 overlay.

Note: The Thor VM1 has two Shift keys with an LED beside each key.

The Shift LEDs indicate the state of the keyboard Shift mode. If Shift is enabled the Shift LEDs beside both Shift keys (64-key only) blink green. When CapsLock is enabled, both Shift LEDs are lit solid green. When Shift and CapsLock are both off, the LEDs are off.

Press either Shift key to toggle Shift On and Off. press 2nd plus either Shift key to toggle CapsLock On or Off.

Secondary Key

The Thor VM1 keyboard is equipped with several secondary keys. These keys are identified by the superscript text found on the keyboard keys.

The secondary keys are accessible by using two (2) keystrokes: the 2nd key followed by the superscript key.

Once the 2nd state is enabled (by pressing the 2nd key) the Secondary Mode LED is illuminated and the 2nd state is enabled until another key is pressed.

The 2nd key is toggled on with a 2nd key press and then immediately off with another 2nd key press.

For example:

Press 2nd and F1 to generate F11.

Ctrl and Alt Key

When the modifier keys (Ctrl or Alt) are active, the LED located next to the key is illuminated. The modifier key remains active until:

- The modifier key is pressed again, or
- A non-modifier key is pressed.

USB Keyboard / Mouse

A standard USB keyboard or mouse can be attached to the Thor VM1 using the appropriate dongle cable.

The dongle cable attaches to the Thor VM1 and provides a USB connector. Please refer to documentation provided with the USB keyboard or mouse for more information on their operation.

Chapter 2 - Set Up A New Thor VM1

This page lists a quick outline of the steps you might take when setting up a new Thor VM1. More instruction for each step is listed later in this guide. Please refer to the *Thor VM1 Reference Guide* for additional information and instruction.

Contact [Technical Assistance](#) if you need additional help.

Note: Installing or removing accessories should be performed on a clean, well-lit surface. When necessary, protect the work surface, the Thor VM1, and components from electrostatic discharge.

<p>Caution</p> 	<p>Before shipping, the internal UPS battery must be disconnected. Please refer to the <i>Thor VM1 Reference Guide</i> for details.</p>
--	---

Hardware Setup

1. Connect accessories to the [Quick Mount Smart Dock](#).
2. [Connect cables](#).
3. Connect power cable to the dock.
4. Secure all cables to the dock with the Strain Relief Cable Clamps.
5. Secure the Thor VM1 in the dock.
6. Press the power switch on the dock.
7. Press the Power key.

Software Setup

Hardware setup should be completed before starting software setup.

1. [Set Date and Time](#)
2. [Set Power Management](#)
3. [Adjust Speaker Volume](#)
4. [Pair Bluetooth devices](#)
5. Setup Wireless client parameters - Please refer to the *Thor VM1 Reference Guide*

Please refer to the *Thor VM1 Reference Guide* for additional information and instruction.

Quick Mount Smart Dock

The Thor VM1 assembly consists of two parts, the Thor VM1 computer and the Quick Mount Smart Dock.

The Thor VM1 contains an internal UPS battery that, once fully charged, powers the Thor VM1 for a minimum of 30 minutes when the unit is not mounted in the dock.

The Dock provides:

- A mount for the Thor VM1 computer. The Dock attaches to a vehicle via a RAM or U-bracket mount.
- Conditioned power for the Thor VM1. The Dock accepts 10-60VDC power input directly or 72-144VDC power input with a DC/DC converter.
- COM1 and COM2 serial connections for a tethered scanner, printer, PC connection, etc.
- USB host and client connections via an adapter cable.
- CANbus connection via an adapter cable.
- Headset connection via an adapter cable. When a headset is not attached, the microphone and speakers on the Thor VM1 are active.
- Strain relief cable mounts.
- Mobility of the Thor VM1, since the Dock remains attached to the vehicle the Thor VM1 computer can easily be moved from one vehicle equipped with a Dock to another.

External antenna connectors may be present on the back of the Thor VM1. The connectors may include:

- 802.11 antenna connectors, used when the Thor VM1 is not equipped with internal antennas.
- External GPS antenna connector, when the Thor VM1 is equipped with GPS.
- External WWAN antenna connectors, when the Thor VM1 is equipped with WWAN.

Optional WWAN radio (available in North America, Europe, New Zealand, and Australia only).

Preparing the Dock

1. Attach RAM mount to vehicle (see *Thor VM1 Vehicle Mounting Reference Guide*).
2. [Attach accessories](#) to dock.
3. Attach power cable, [10-60VDC](#) or [72-144VDC](#).
4. If the tethered I/O port cover is in place, lift the cover to expose the I/O port on the dock. The tether allows the cover to be swung over the back of the dock.

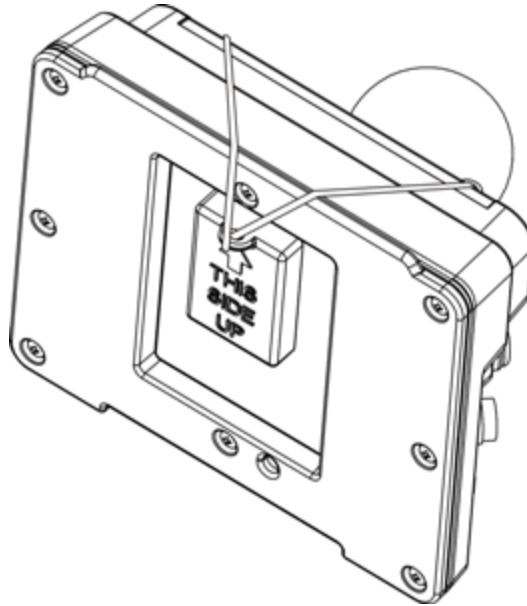

Place the Thor VM1 in the Dock

Back of Thor VM1

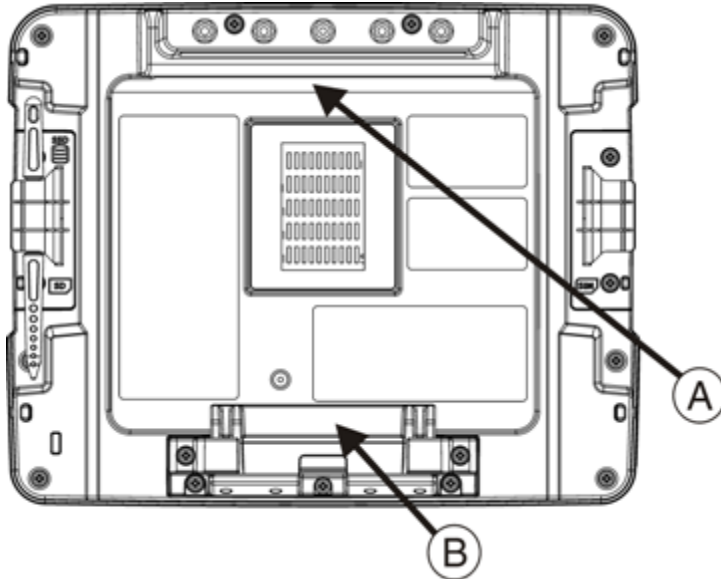

Front of Quick Mount Smart Dock

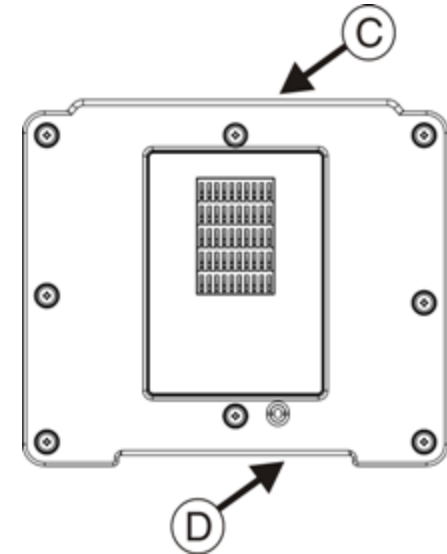

A. Notch on Thor VM1

B. Release lever

C. Upper Lip on Dock

D. Lower Lip on Dock

1. Locate the notch on the upper rear of the Thor VM1 (item A above).
2. Slide this notch over the top lip (C) of the Dock. Slide the Thor VM1 from side to side on the Dock to make sure it fully engages on the lip of the Dock. If the Thor VM1 cannot be slid side to side, the lip is engaged.
3. Pull the quick release lever (B) on the Thor VM1 down and push the Thor VM1 against the Dock.
4. Release the quick release lever. The quick release lever catches the lower lip on the Dock and secures the Thor VM1 to the Dock.
5. If necessary, adjust the viewing angle of the Thor VM1.

Removing the Thor VM1 from the Dock

The Thor VM1 may be removed from the Quick Mount for limited periods of use or the transfer from vehicle to vehicle.

The UPS battery inside the Thor VM1 powers a fully functional Thor VM1 for a minimum of 30 minutes.

To remove the Thor VM1 from the Dock:

1. Pull the quick release lever (item B) downward on the back of the Thor VM1.
2. Pull the bottom of the Thor VM1 away from the Dock.
3. Lift the Thor VM1 away from the Dock.

Backlights and Indicators

Display Backlight

There are several configuration options for the Thor VM1 display backlight:

Power Management

The display backlight is controlled by power management. When the user activity timer expires, the display backlight is turned off. Different timeouts can be set for when the Thor VM1 is operating on battery (UPS) or external power.

Please refer to the *Thor VM1 Reference Guide* for details.

The display backlight can be configured using this option:

Start > Control Panel > Power.

Backlight Brightness

Note: When automatic brightness control is enabled, the manual display brightness controls described below have no effect.

The intensity of the display backlight can be manually configured:

- Use the 2nd + F7 keypress to increase backlight brightness and the 2nd + F8 keypress to decrease backlight brightness.

If the Thor VM1 is equipped with an outdoor display, the display can be configured to automatically adjust brightness depending on the level of ambient light.

Please refer to the **Screen Control** panel in the *Thor VM1 Reference Guide* for the current display brightness level and (for an outdoor display) automatic brightness control parameters.

Screen Blanking

The Thor VM1 can be configured to blank (blackout) the display while the vehicle is in motion.

Please refer to the **Screen Control** panel in the *Thor VM1 Reference Guide* for details.

Keypad Backlight

The keypad backlight follows the display backlight. The keypad backlight cannot be disabled.

LED Functions

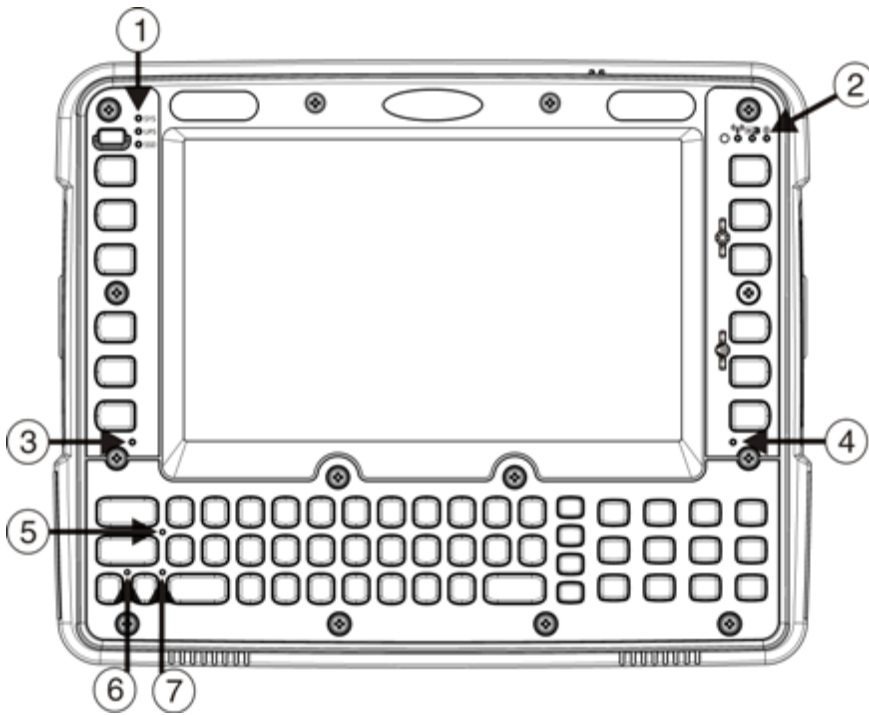

1. [System LEDs](#)
2. [Connection LEDs](#)
3. [2nd LED](#)
4. [Shift/CapsLock LED](#)
5. [Shift/CapsLock LED](#)
6. [Ctrl LED](#)
7. [Alt LED](#)

System LEDs

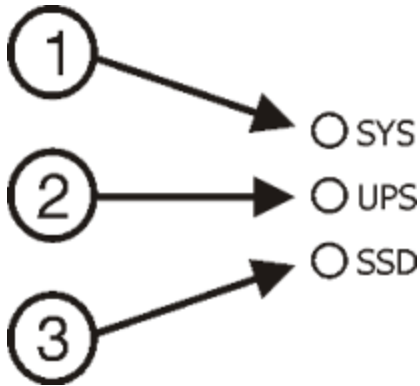

1. SYS (System Status) LED
2. UPS (Uninterruptible Power Supply) LED
3. SSD (Solid State Drive) LED

SYS (System Status) LED

LED Behavior	System State
Solid Green	<ul style="list-style-type: none"> • On • On but Display Off
Green blinking very slowly External power present (1/2 sec. on, 4 1/2 sec. off)	<ul style="list-style-type: none"> • Standby
Off External power present	<ul style="list-style-type: none"> • Off • Hibernate
Off External power not present	<ul style="list-style-type: none"> • Off, • Hibernate • Standby
Green blinking slowly External power present (1/2 sec. on, 1 1/2 sec. off)	CPU temperature less than -20°C, Heater warming CPU for 30 sec.
Green blinking slowly External power not present (1/2 sec. on, 1 1/2 sec. off)	CPU temperature less than -20°C, Need to move unit to warmer environment

UPS Status LED

The behavior of the UPS LED depends if external power is connected or not.

External Power Present

LED Behavior	Status
Off	<ul style="list-style-type: none">• No UPS charging,• UPS charged
Solid Green	UPS charging
Solid Amber	<ul style="list-style-type: none">• Any charging fault,• Out of charging temperature range,• No UPS present,• Charge timeout

External Power Not Present

LED Behavior	Status
Off	<ul style="list-style-type: none">• Unit off,• UPS not present
Solid Amber	UPS supplying power and discharging
Solid Red	Approximately 2 minutes runtime until shutdown

SSD (Solid State Drive) LED

LED Behavior	Status
Flashing Green	SSD read or write activity.
Off	No SSD read or write activity.

Connection LEDs

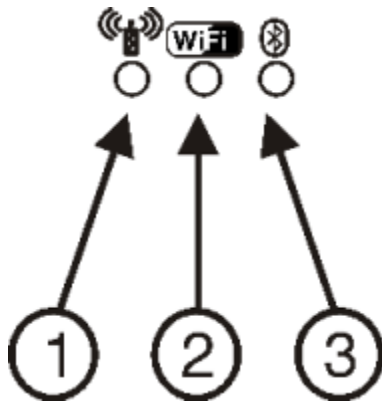

1. WWAN LED
2. WiFi LED
3. Bluetooth LED

WWAN LED

LED Behavior	Status
Solid Green	Indicates a WWAN connection to a network.
Off	Indicates no WWAN connection.

WiFi LED

LED Behavior	Status
Solid Green	Indicates a connection with an IP address to an Access Point
Off	Indicates no connection to an Access Point.

Bluetooth LED

LED Behavior	Status
Blue Blinking Slowly	Bluetooth is paired but not connected to a device.
Blue Blinking Medium	Bluetooth is paired and connected to a device.
Blue Blinking Fast	Bluetooth is discovering Bluetooth devices.
Off	Bluetooth hardware has been turned off.

Keyboard LEDs

The keyboard LEDs are located near the specified key.

2nd LED

LED Behavior	Status
Solid Green	<ul style="list-style-type: none">Indicates the 2nd modifier key is active. 2nd mode is invoked for the next keypress only.Pressing the 2nd key a second time exits this modifier mode and turns off the LED.
Off	2nd mode is not invoked.

Shift LEDs

There is one LED next to each **Shift** key. Both LEDs indicate the status of Shift or Caps Lock mode.

LED Behavior	Status
Blinking Green	<ul style="list-style-type: none">Indicates the keypad is in Shift mode. Shift mode is invoked for one keypress.Pressing the Shift key places the system in Shift mode.To exit Shift mode, press the Shift key again.
Solid Green	<ul style="list-style-type: none">When solid green, indicates the keypad is in Caps Lock mode. Caps Lock mode is invoked until canceled.Pressing the 2nd key followed by the Shift key places the system in Caps Lock mode.To exit Caps Lock mode, press 2nd + Shift again.
Off	Neither Shift or Caps Lock mode is invoked.

Ctrl LED

LED Behavior	Status
Solid Green	<ul style="list-style-type: none">Indicates the Ctrl modifier key is active. Ctrl mode is invoked for the next keypress only.Pressing the Ctrl key a second time exits this modifier mode and turns off the LED.
Off	Ctrl mode is not invoked.

Alt LED

LED Behavior	Status
Solid Green	<ul style="list-style-type: none">• Indicates the Alt modifier key is active. Alt mode is invoked for the next keypress only.• Pressing the Alt key a second time exits this modifier mode and turns off the LED.
Off	Alt mode is not invoked.

Power Up



If a USB drive, such as a thumb drive is attached to the Thor VM1, the device attempts to boot from the USB drive and cannot. Please remove the USB drive and power up the Thor VM1 again.

The Quick Mount Smart Dock has a power switch on the back.

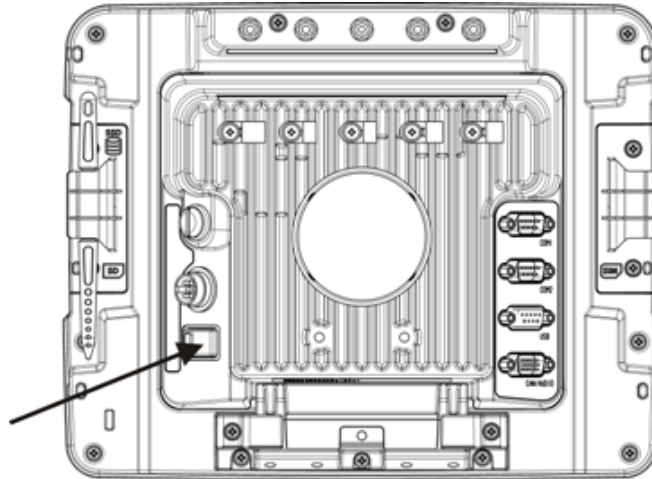

The "On" side of this rocker switch has a raised bump to allow the state of the switch to be determined when the switch may not be easily viewed, for example, after the Dock is mounted in a vehicle.

After external power has been connected and the Thor VM1 has been mounted in the Dock, press the side of the power switch with the raised bump to pass power from the Dock to the Thor VM1. Generally, once the Dock is powered On, there is no need to power if Off.

Next locate the [power button](#) on the front of the Thor VM1.

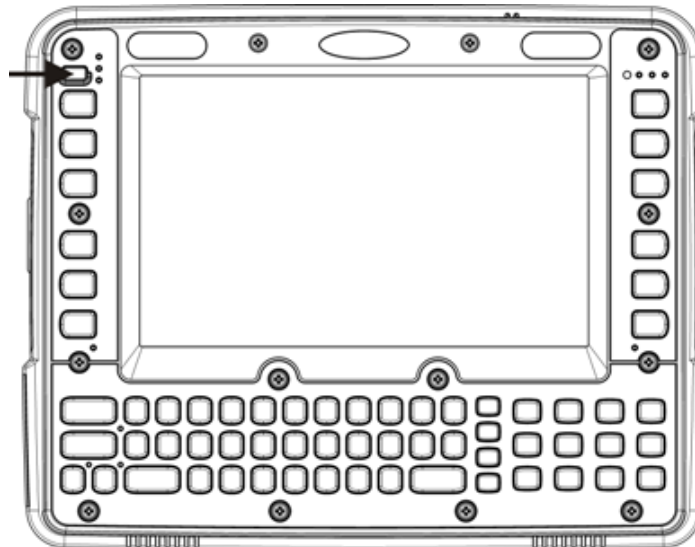

Press the power button to turn the Thor VM1 on. When the Windows desktop is displayed or an application begins, the power up sequence is complete.

Tapping the Touch Screen with a Stylus

Note: Always use the point of the stylus for tapping or making strokes on the touch screen.

Never use an actual pen, pencil, or sharp/abrasive object to write on the touch screen.

Hold the stylus as if it were a pen or pencil. Touch an element on the screen with the tip of the stylus then remove the stylus from the screen.

Firmly press the stylus into the stylus holder when the stylus is not in use.

Using a stylus is similar to moving the mouse pointer then left-clicking icons on a desktop computer screen.

Using the stylus to tap icons on the touch screen is the basic action that can:

- Open applications
- Choose menu commands
- Select options in dialog boxes or drop-down boxes
- Drag the slider in a scroll bar
- Select text by dragging the stylus across the text
- Place the cursor in a text box prior to typing in data
- Place the cursor in a text box prior to retrieving data using a scanner/imager or an input/output device connected to a serial port.

A right-click can be simulated by touching the touch screen with the stylus and holding it for a short time.



A right click is generated by tapping the mouse icon, usually located in the upper right hand corner of the screen. After tapping, the mouse icon highlights the right button. The next touch screen tap is treated as a right click. The mouse icon returns to the left button highlighted so subsequent taps are treated as left clicks.

When a dialog box is too large for the display, tap and drag the dialog box up or down or from side to side to view the remainder of the dialog box.

Note: If the mouse icon is not displayed, this feature can be enabled by tapping the PenMount icon  in the System Tray. From the menu that pops up, tap the **Right Button** to enable the mouse icon. When this option is enabled, a checkmark is displayed in the menu.

A stylus replacement kit is available.

Thor VM1 Configuration Options

Many configuration options are available via the Microsoft Windows Control panel. Refer to the *Thor VM1 Reference Guide* or For **Help and Support** on the **Start** menu for configuration details.

Date and Time

Use the Windows interface to set date, time and time zone.

- Double tap time display in System Tray
- Tap **Start > Control Panel > Date and Time** (Classic view)
- Tap **Start > Control Panel > Date, Time, Language and Regional Options > Change the Date and Time** (Category view)

Power Management

Use the Windows interface to set power management options.

- Tap **Start > Control Panel > Power Options** (Classic view)
- Tap **Start > Control Panel > Performance and Maintenance > Power Options** (Category view)

Speaker Volume

Use the Windows interface to control speaker volume.

- Double tap speaker icon in System Tray
- Tap **Start > Control Panel > Sound and Audio Devices** (Classic view)
- Tap **Start > Control Panel > Sounds, Speech and Audio Devices > Adjust the System Volume** (Category view)

Or use the Function keys to control speaker volume.

- Press the **2nd** key.
- Press **F9** to adjust volume up or **F10** to adjust volume down.

Connect Bluetooth Devices

Use the Windows interface to manage Bluetooth devices.

- Tap **Start > Control Panel > Bluetooth Devices** (Classic view)
- Tap **Start > Control Panel > Printers and Other Hardware > Bluetooth Devices** (Category view)

Restart/Shutdown

Use the Windows interface to restart or shut down the Thor VM1.

- Tap **Start > Shut Down > Restart**
- Tap **Start > Shut Down > Shut down**

Calibrate Touch Screen

To calibrate the touch screen, access the touch screen software. Select:

- Tap **Start > Programs > PenMount Universal Driver > Utility > PenMount Control Panel**. Select **PenMount 6000 USB** and then tap **Configure**. Select **Standard Calibration** or **Advance Calibration**. Advanced Calibration allows the user to select the number of calibration points. With either option, follow the on screen instructions to touch the red square, hold the touch and then lift the stylus to complete the calibration process.

Touch Screen

Apply the Touch Screen Protective Film

The Thor VM1 touch screen protective film is shipped in packs of 10. The protective film is flexible and treated with an anti-glare coating on the outer surface.

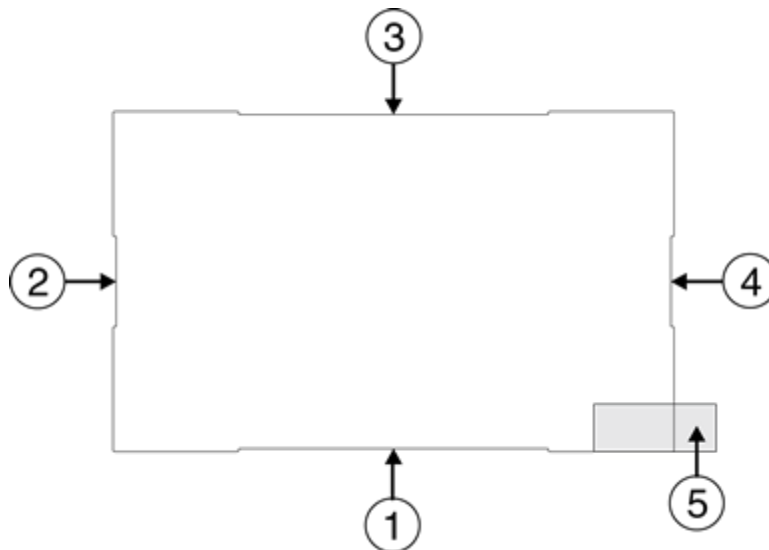

The protective film is slightly larger than the Thor VM1 touch screen, however the notches on the edge of the protective film (indicated by arrows 1 - 4 above) correspond to the display size of the Thor VM1. The protective film is not adhesive. The corner edges are designed to fit between the Thor VM1 display and the display housing to hold the protective film in place.

A protective backing is applied to the rear surface of the protective film. A pull tab (item 5 above) is attached to the protective backing for easy removal of the protective backing from the film.

Installation

1. Make sure the touch screen is clean and dry before installation. Please review [Cleaning the Display](#) for instructions on suitable cleaning agents.
2. Pull the release tab to separate the protective backing from the rear of the protective film. Avoid touching the rear side of the protective film while removing the liner.
3. Place the rear side of the protective film against the Thor VM1 display, roughly centering the protective film over the display.
4. Slide the protective film until one corner can be slid back between the touch screen and the display housing as the protective film is re-centered on the display. It may be necessary to press the edges of the protective film against the display to ensure the entire edge slides under the display housing. It is easiest to start with one of the bottom corners.
5. Slide the protective film away from the other bottom corner. The film may bulge slightly away from the User's Guide as it is being slid. Only slide the protective film enough so that the protective film can slide under the display housing on that corner when the protective film is returned to center.
6. Repeat with each of the top corners, sliding the protective film away from the corner just enough that the protective film can slide under the display housing when the protective film is returned to center.

-
7. It may be necessary to flex the protective film during the install, however use care not to flex the protective film so much that the protective film kinks.
 8. Once all corners are secure under the display housing, adjust the protective film, if necessary, so it is centered on the touch screen.

Removal

1. To remove the protective film, slide the protective film in one direction until the edge clears.
2. Lift up on the edge of the protective film so it does not slide between the touch screen and display housing when the protective film is slid back to the center.
3. Repeat until all edges are free and remove the protective film.

Contact [Technical Assistance](#) about protective film packs designed specifically for your Thor VM1 touch screen.

Cleaning the Touch Screen

Note: These instructions are for components made of glass. If there is a removable protective film sheet on the display, remove the film sheet before cleaning the screen.

Keep fingers and rough or sharp objects away from the bar code reader scanning aperture and the mobile device touch screen.

If the glass becomes soiled or smudged, clean only with a standard household cleaner such as Windex® without vinegar or use Isopropyl Alcohol. Dampen the cloth with the cleaner and then wipe the surface.

Do not use paper towels or harsh-chemical-based cleaning fluids since they may result in damage to the glass surface. Use a clean, damp, lint-free cloth.

Do not scrub optical surfaces. If possible, clean only those areas which are soiled. Lint and particulates can be removed with clean, filtered canned air.

Startup Help

Contact [Technical Assistance](#) if you need more help.

Touch screen is not accepting stylus taps or needs recalibration.	See Also: "Calibrate Touch Screen" when the touch screen needs recalibration, or Press Ctrl+Esc to force the Start Menu to appear. Use the tab, backtab and arrow keys to move the cursor from element to element.
Thor VM1 seems to lockup as soon as it is rebooted.	There may be slight delays while the wireless client connects to the network, authorization for voice-enabled applications complete, and Bluetooth relationships establish or re-establish. When an application begins, the Thor VM1 is ready for use.



Chapter 3 - Connecting Cables to the Thor VM1

A USB Client connection is not used on Thor VM1 with a Windows Embedded Standard operating system.

Connect Cable - USB Host

Note: A USB Client connection is not used on Thor VM1 with a Windows Embedded Standard operating system.

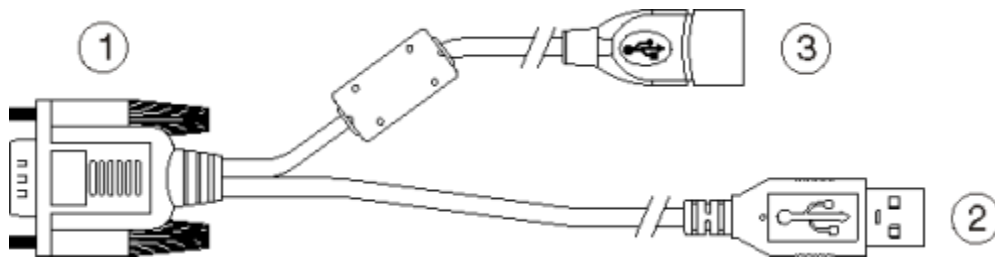

1. D9 Connector
2. USB Client Connector (not used)
3. USB Host Connector (for connecting to a USB device)

1. Seat the cable end connector (connector 1) firmly over the USB Cable Connector on the Quick Mount Smart Dock.
2. Tighten the thumbscrews in a clockwise direction. Do not over tighten.
3. Connector 3 on the cable provides a USB-Host connection. Connector 2 (USB-Client) is not used for the USB-H connection.

Connect Cable - Serial

Note: Pin 9 of the desired COM port must be configured to provide +5V or RI as needed for the connected device. See the Thor VM1 Reference Guide for details.

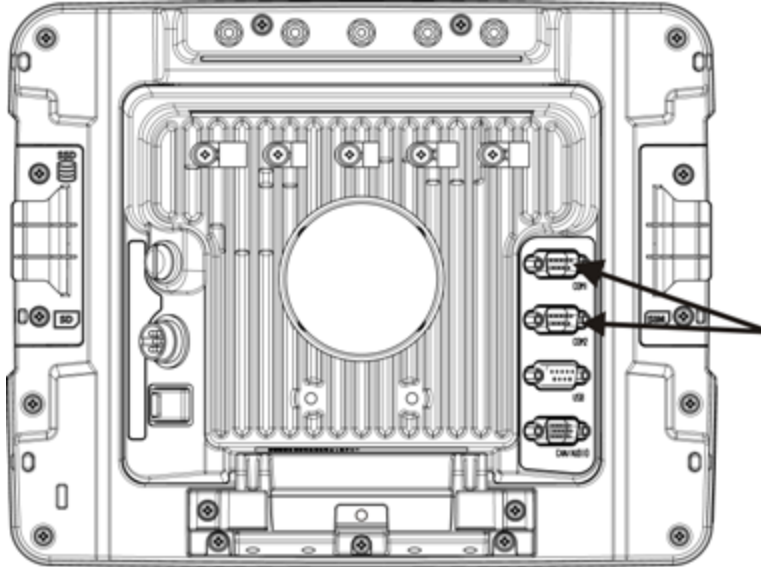

1. Seat the cable end connector firmly over the serial COM port on the Quick Mount Smart Dock.
2. Turn the thumbscrews in a clockwise direction. Do not over tighten.
3. Use a strain relief clamp to secure the cable to the Thor VM1.
4. Connect the other cable end to the desired serial device.

Connect a Tethered Scanner

1. The scanner cable is attached to either the COM1 or COM2 port on the Quick Mount Smart Dock.
2. Connect the serial cable for the scanner as directed above.
3. When the Thor VM1 is powered on, it provides power to the serial scanner.

Connecting an AC/DC Power Supply

Note: The Honeywell-approved AC Power Supply and Adapter Cable are only intended for use in a 25°C (77°F) maximum ambient temperature environment.

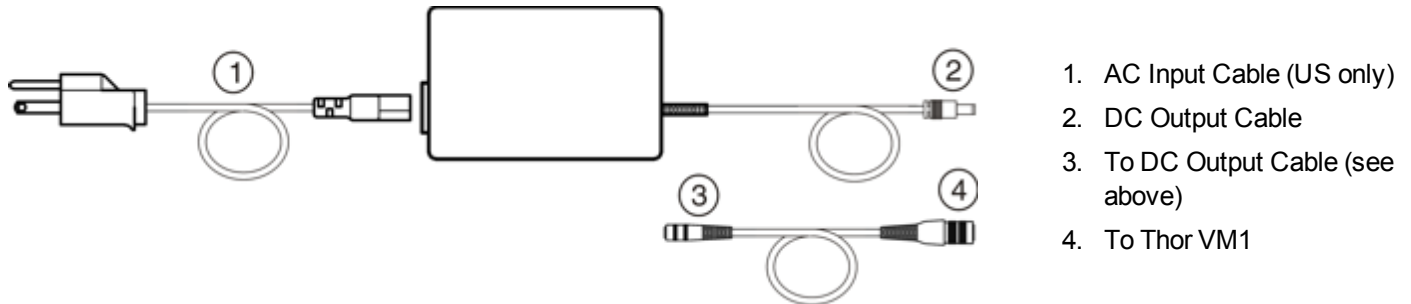

In North America, this unit is intended for use with a UL Listed ITE power supply with output rated 12 – 80VDC, minimum 60W. Outside North America, this unit is intended for use with an IEC certified ITE power supply with output rated 12 – 80VDC, minimum 60W.

The external power supply may be connected to either a 120V, 60Hz supply or, outside North America, to a 230V, 50Hz supply, using the appropriate detachable cordset. In all cases, connect to a properly grounded source of supply provided with maximum 15 Amp overcurrent protection (10 Amp for 230V circuits).

1. Turn the Thor VM1 off.
2. Connect the detachable cordset provided by Honeywell (US only, all others must provide their own cable) to the external power supply (IEC 320 connector).
3. Plug cordset into appropriate, grounded, electrical supply receptacle (AC mains).
4. Connect the DC Output Cable end to the power connector on the Thor VM1 Quick Mount.
5. Turn the Thor VM1 on.

Connecting the Headset Cable

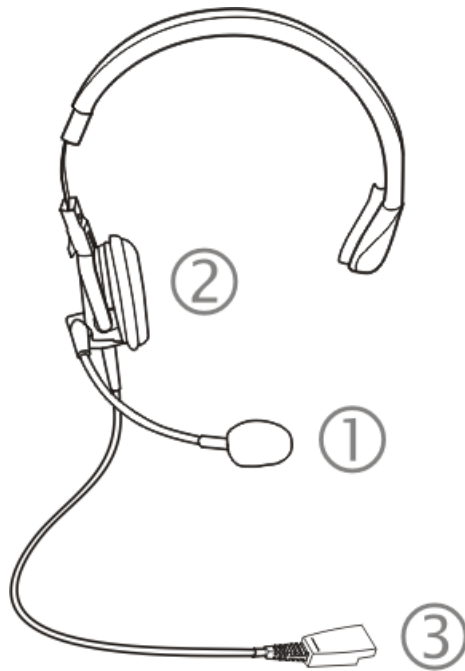

Headset

1. Microphone
2. Headphones
3. Connects to end of voice cable

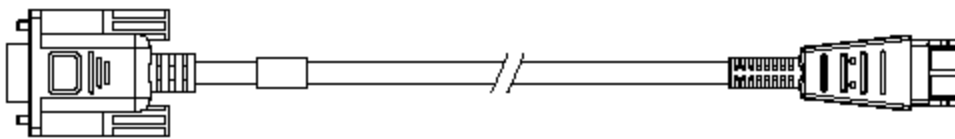

Thor VM1 **Audio Cable**

1. Seat the D15 cable end connector firmly over the CANbus/Audio Connector on the Quick Mount Smart Dock.
2. Tighten the thumbscrews in a clockwise direction. Do not over tighten.

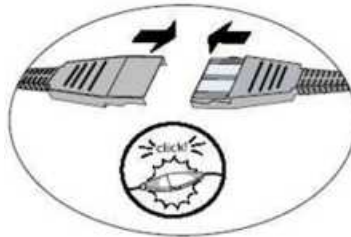

3. Slide the cable ends together until they click shut. Do not twist or bend the connectors. The Thor VM1 internal microphone and speakers are automatically disabled when the headset is connected.

The Thor VM1 is ready for voice-enabled applications.

Adjust Headset / Microphone and Secure Cable



The headset consists of an earpiece, a microphone, a clothing clip and a cable. The headset attaches to the audio cable end of the voice cable which attaches to the Thor VM1.

Align the audio connector and the headset quick connect cable end. Firmly push the cable ends together until they click and lock in place.

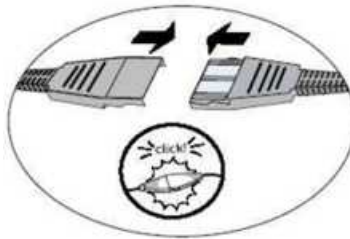

Do not twist the microphone boom when adjusting the microphone. The microphone should be adjusted to be about two finger widths from your mouth.

Make sure the microphone is pointed at your mouth. Note the small "Talk" label near the mouthpiece. Make sure the Talk label is in front of your mouth. The microphone cable can be routed over or under clothing.

Under Clothing

- Leave the cable exposed only at the top of the collar.
- Be sure to leave a small loop of cable to allow movement of your head.



Over Clothing

- Use clothing clips to hold the cable close to your body.
- Tuck the cable under the belt, but leave a small loop where it goes under the belt.
- Do not wear the cable on the front of your body. It may get in your way or get caught on protruding objects.

Connecting Vehicle Power

Complete vehicle cradle mounting and power instruction is contained in the *Thor VM1 Vehicle Mounting Reference Guide*.

Vehicle 10-60VDC Power Connection

Caution: 	For installation by trained service personnel only.
Caution: 	For proper and safe installation, the input power cable must be connected to a fused circuit on the vehicle. This fused circuit requires a 10 Amp maximum time delay (slow blow) high interrupting rating fuse. If the supply connection is made directly to the battery, the fuse should be installed in the positive lead within 5 inches of the battery positive (+) terminal. Note: For North America, a UL Listed fuse is to be used.

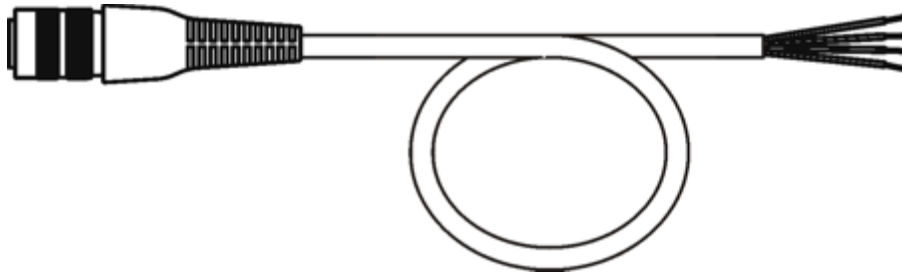

VM1054CABLE

Wire Color	Connection
Red	DC + (10-60VDC)
Black	DC -
Green	Ground
Blue	Ignition Input (optional)

Note: Correct electrical polarity is required for safe and proper installation. See the figures below for additional wire color-coding specifics.

The Thor VM1 DC input wires (Red DC+ and Black DC-) and the Blue ignition input wire are galvanically isolated. The Green ground input is used for electrostatic discharge (ESD) protection.

Connect Vehicle 10-60VDC

1. The Thor VM1 must not be mounted in the Quick Mount Smart Dock. The power switch on the Dock must be turned **Off**. The power cable must be UNPLUGGED from the Dock.
2. While observing the fuse requirements specified above, connect the power cable as close as possible to the actual battery terminals of the vehicle (if using unswitched power).
3. Wiring installation
 - Use proper electrical and mechanical fastening means for terminating the cable. Properly sized “crimp” type electrical terminals are an accepted method of termination. Please select electrical connectors sized for use with 20AWG (0.81mm²) conductors.
 - Refer to the diagrams following this section for wire colors and connections:
 - [Ignition Control](#)
 - [Auto-On Control](#)
 - [Manual Control](#)
 - [VX6/VX7 Adapter Cable](#)
5. Route the power cable:
 - Route the power cable the shortest way possible removing any left-over cable
 - The cable is rated for a maximum temperature of 105°C (221°F). Therefore, routing this cable it should be protected from physical damage and from surfaces that might exceed this temperature.
 - Cable should be protected from physical damage from moving parts
 - Do not expose the cable to chemicals or oil that may cause the wiring insulation to deteriorate
 - Always route the cable so that it does not interfere with safe operation and maintenance of the vehicle.
 - Provide mechanical support for the cable by securing it to the vehicle structure at approximately one foot intervals, taking care not to over tighten and pinch conductors or penetrate outer cable jacket.
5. Connect the DC power cable to the input connector on the back of the Dock.
6. Flip the power switch on the back of the Dock to On.
7. The Thor VM1 can be installed in the Dock.
8. If using the [optional screen blanking feature](#), install the screen blanking box or switch.

Ignition Control

Ignition wire must be connected and Auto-On must be disabled. When switched vehicle power is available the Thor VM1 ignition signal wire can be connected (less than 1mA over input voltage range) to the switched circuit to allow the Thor VM1 to power on when the vehicle is switched on and go into shut down (see note below) when the vehicle is switched off.

When the vehicle is switched off, the Thor VM1 treats this event as a power button press. The default Windows setting for a power button press is to power the device off, however additional options are available on the Advanced tab of the Power control panel.

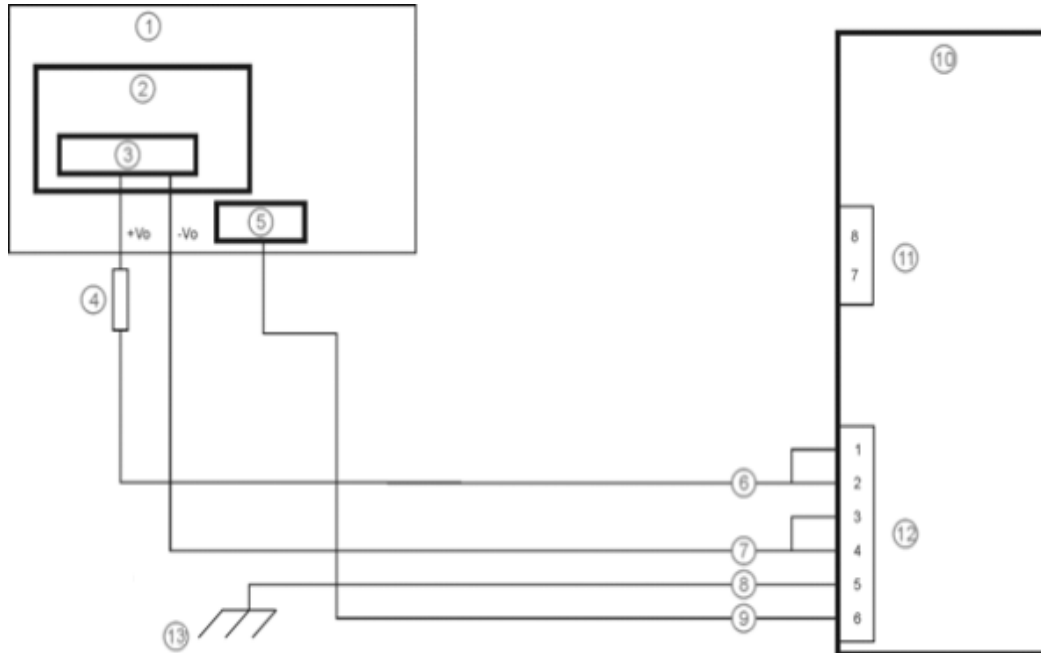

1. Existing Circuitry on Vehicle
2. Forklift Battery
3. Main Switch
4. 10A Slow blow Fuse close to power source
5. Ignition
6. Red Wire (DC +)
7. Black Wire (DC -)
8. Green Wire (Ground)
9. Blue Wire (Ignition Signal)
10. Thor VM1 Computer in Quick Mount Smart Dock
11. COM1 or COM2 Connector on Dock
12. Circular Power Connector on Dock
13. If the vehicle chassis is not a suitable ground, connect the Green wire to the negative terminal (-Vo) of the power source.

Auto-On Control

Auto-On mode must be selected. The vehicle supply connections should be made to vehicle switched power to allow the terminal to automatically power-up when vehicle power is switched on or when the power switch on the back of the Dock is placed in the On position. The Ignition wire is not used and should be left disconnected.

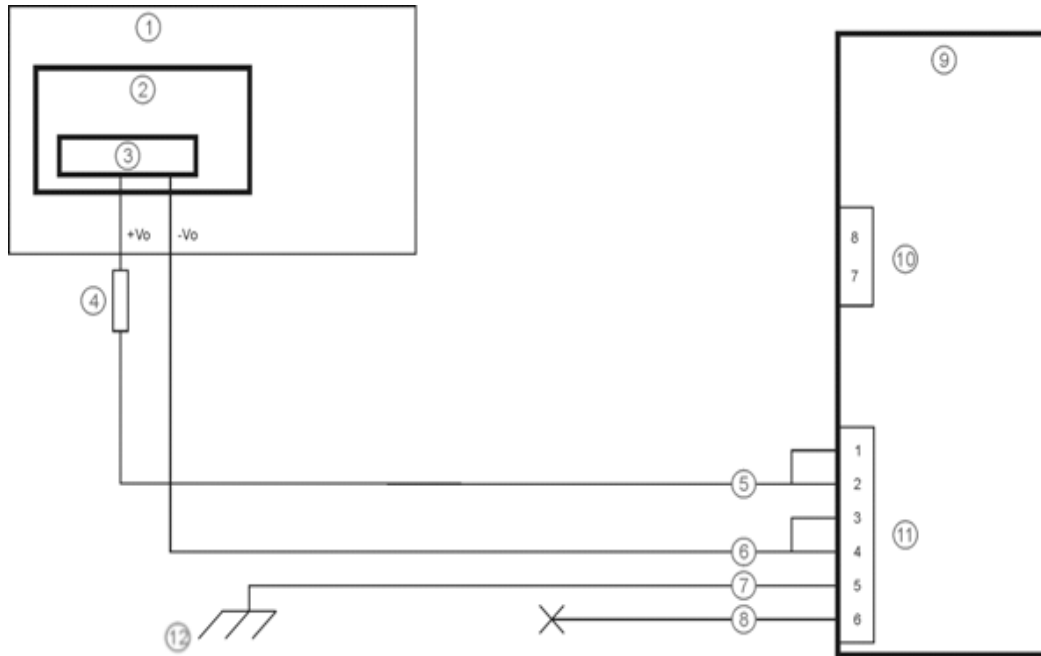

1. Existing Circuitry on Vehicle
2. Forklift Battery
3. Main Switch
4. 10A Slow blow Fuse close to power source
5. Red Wire (DC +)
6. Black Wire (DC -)
7. Green Wire (Ground)
8. Blue Wire (not connected)
9. Thor VM1 Computer in Quick Mount Smart Dock
10. COM1 or COM2 Connector on Dock
11. Circular Power Connector on Dock
12. If the vehicle chassis is not a suitable ground, connect the Green wire to the negative terminal (-Vo) of the power source.

Manual Control

Ignition wire must be left unconnected and Auto-On must be disabled.

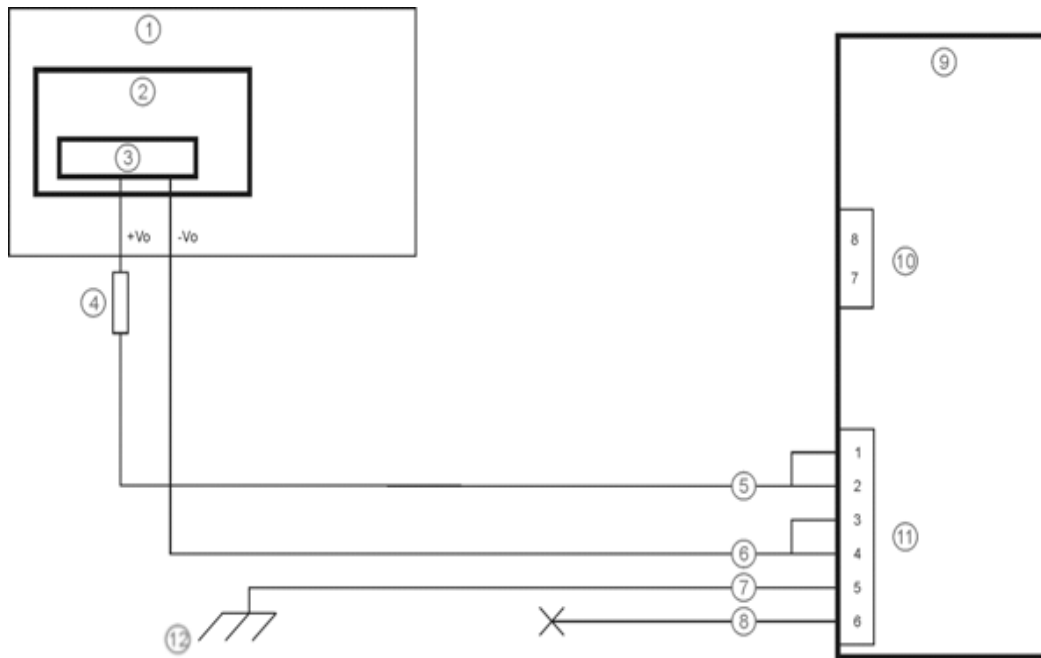

1. Existing Circuitry on Vehicle
2. Forklift Battery
3. Main Switch
4. 10A Slow blow Fuse close to power source
5. Red Wire (DC +)
6. Black Wire (DC -)
7. Green Wire (Ground)
8. Blue Wire (not connected)
9. Thor VM1 Computer in Quick Mount Smart Dock
10. COM1 or COM2 Connector on Dock
11. Circular Power Connector on Dock
12. If the vehicle chassis is not a suitable ground, connect the Green wire to the negative terminal (-Vo) of the power source.

VX6 / VX7 Adapter Cable

An adapter cable is available to attach the Thor VM1 to a vehicle previously equipped with a VX6/VX7 DC power cable. The adapter cable has a 5-pin connector to match with the VX6/VX7 power supply cable on one end and a 6-pin connector to match to the Thor VM1 on the other.

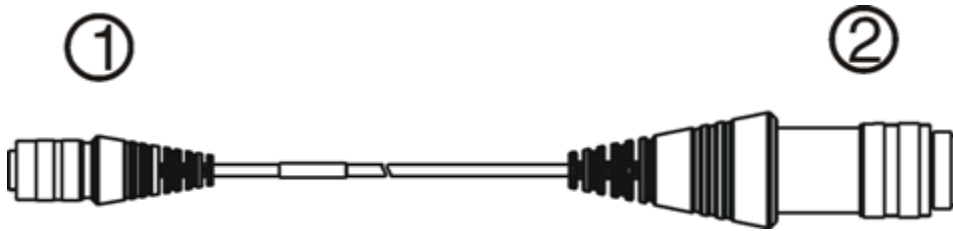

1. To Thor VM1
2. To VX6/VX7 Power Supply Cable

Caution:





Because the Thor VM1 supports 10-60VDC power input, verify input voltages before using this adapter cable with an existing VX6 or VX7 power connection installation.

When this adapter cable is used there is no provision for an ignition switch input. Therefore the vehicle ignition control function is not available when using this cable.

Vehicle 72-144VDC Power Connection

This option requires DC/DC external power supply Part no. VX89303PWRSPLY.

<p>Caution:</p> 	<p>For installation by trained service personnel only.</p>
<p>Caution:</p> 	<p>For proper and safe installation, the input power cable must be connected to a fused circuit on the vehicle. This fused circuit requires a 10 Amp maximum time delay (slow blow) high interrupting rating fuse. If the supply connection is made directly to the battery, the fuse should be installed in the positive lead within 5 inches of the battery positive (+) terminal. Note: For North America, a UL Listed fuse is to be used.</p>
<p>Caution:</p> 	<p>The VX89303PWRSPLY power supply is sealed per IPXX. Usage in areas where moisture can affect the power supply connections should be avoided. The power supply should be mounted in a dry location within the vehicle or placed in a suitable protective enclosure.</p>

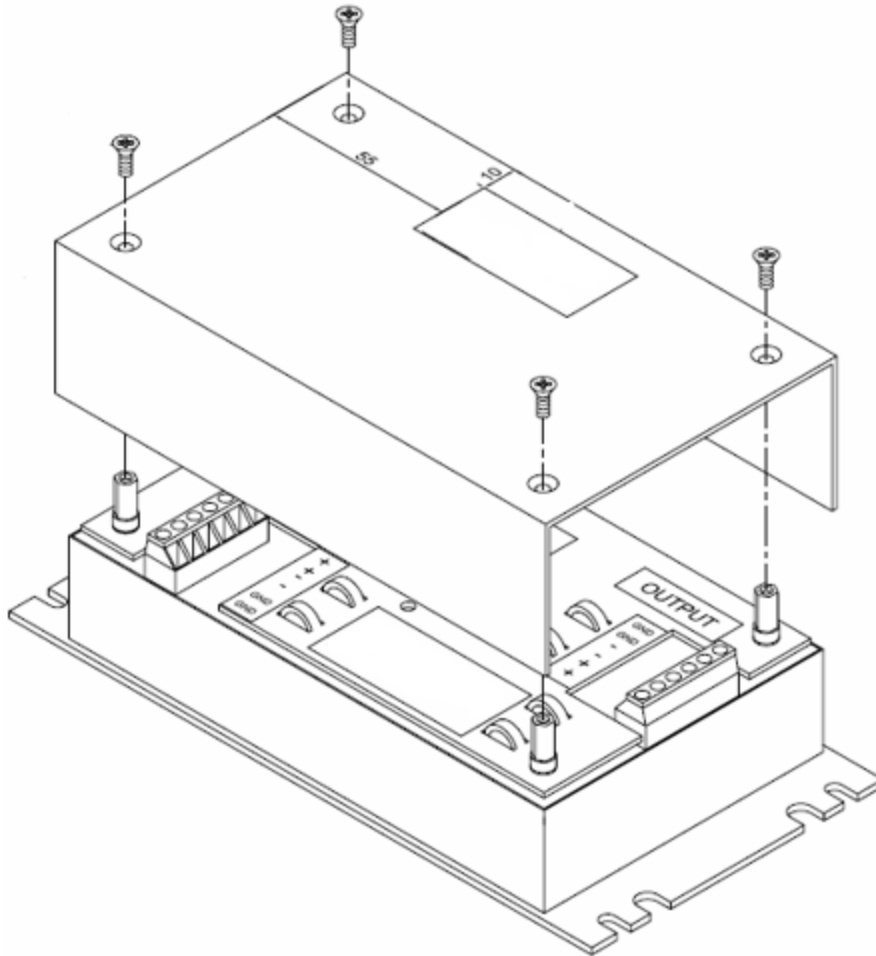

VX89303PWRSPLY

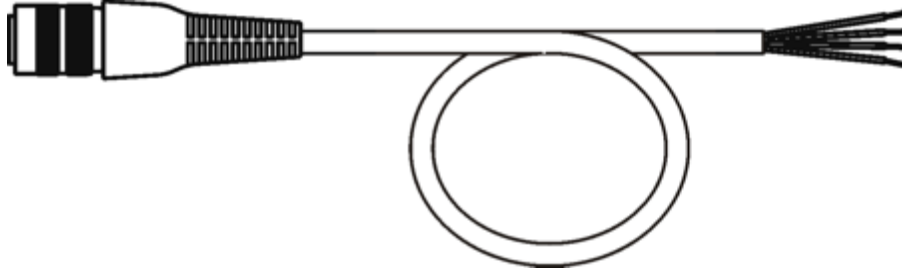

VM1054CABLE

Wire Color	Connection
Red	DC + output from DC/DC Power Supply
Black	DC - output from DC/DC Power Supply
Green	Ground output from DC/DC Power Supply
Blue	Ignition Input (not connected)

Note: Correct electrical polarity is required for safe and proper installation. See the figure below for additional wire color-coding specifics.

The Thor VM1 DC input wires (Red DC+ and Black DC-) and the Blue ignition input wire are galvanically isolated. The Green ground input is used for electrostatic discharge (ESD) protection.

Connect Vehicle 72-144VDC

1. The Thor VM1 must not be mounted in the Quick Mount Smart Dock. The power switch on the Dock must be turned **Off**. The power cable must be UNPLUGGED from the Dock.
2. While observing the fuse requirements specified above, connect the power cable as close as possible to the actual battery terminals of the vehicle.
3. Wiring installation:
 - The user must supply wiring from the vehicle to the DC/DC power supply.
 - Use proper electrical and mechanical fastening means for terminating the cable. Properly sized “crimp” type electrical terminals are an accepted method of termination. Please select electrical connectors sized for use with 20AWG (0.81mm²) conductors.
 - Remove the lid from the DC to DC converter. Attach the stripped wire ends to the output side of the DC to DC converter. Attach stripped wire ends to the input side of the DC to DC converter.
 - The input and output blocks each have two + and two – minus connectors. Either connector in the block can be used to connect the matching polarity wire.
 - Use the looms and wire ties to secure all wiring then reattach the cover with the screws.
 - Connect as shown in [wiring diagram](#).
4. Route the power cable:
 - Route the power cable the shortest way possible removing any left-over cable
 - The cable is rated for a maximum temperature of 105°C (221°F). Therefore, routing this cable it should be protected from physical damage and from surfaces that might exceed this temperature.
 - Cable should be protected from physical damage from moving parts
 - Do not expose the cable to chemicals or oil that may cause the wiring insulation to deteriorate

- Always route the cable so that it does not interfere with safe operation and maintenance of the vehicle.
 - Provide mechanical support for the cable by securing it to the vehicle structure at approximately one foot intervals, taking care not to over tighten and pinch conductors or penetrate outer cable jacket.
5. Connect the DC power cable to the input connector on the back of the Dock.
 6. Flip the power switch on the back of the Dock to On.
 7. The Thor VM1 can be installed in the Dock.
 8. If using the [optional screen blanking feature](#), install the screen blanking box or switch.

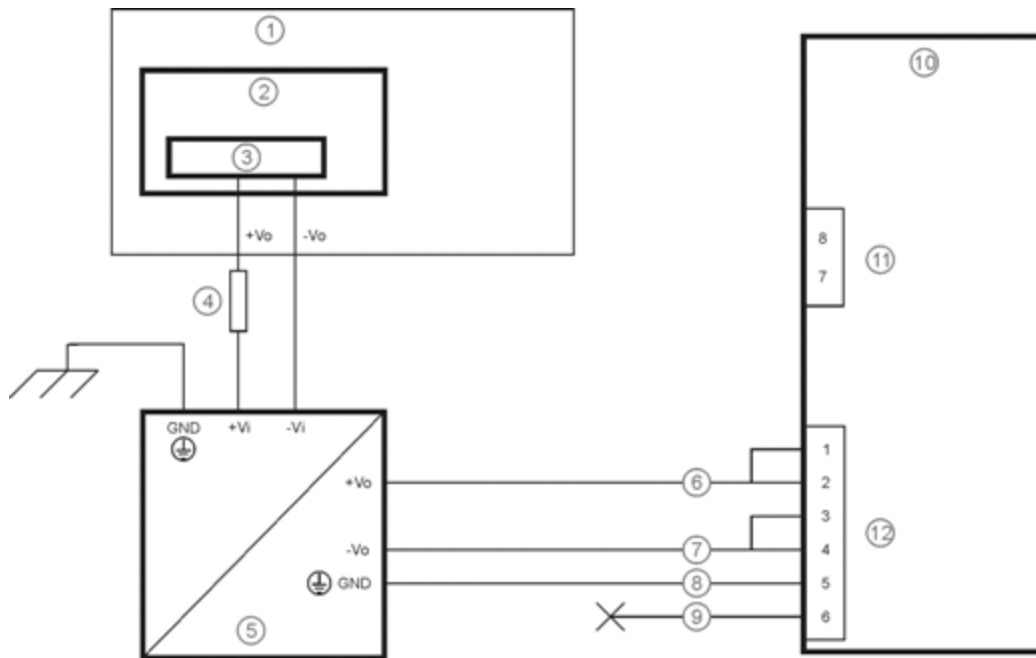

Wiring Diagram



- | | |
|--|---|
| <ol style="list-style-type: none"> 1. Existing Circuitry on Vehicle 2. Forklift Battery 3. Main Switch 4. 10A Slow blow Fuse close to power source 5. Isolated DC/DC Power Supply 6. Red Wire (DC +) | <ol style="list-style-type: none"> 7. Black Wire (DC -) 8. Green Wire (Ground) 9. Blue Wire (not connected) 10. Thor VM1 Computer in Quick Mount Smart Dock 11. COM1 or COM2 Connector on Dock 12. Circular Power Connector on Dock |
|--|---|

Thor VM1 Screen Blanking

Note: Before this process begins, the steps outlined in Power Cable Connection need to be performed for either the [10-60VDC Connection](#) or the [72-144VDC Connection](#).

Caution: 	For installation by trained service personnel only.
Caution: 	For proper and safe installation, the input power lead to the Screen Blanking Box requires a 3 Amp maximum time delay (slow blow) high interrupting rating fuse. Note: For North America, a UL Listed fuse is to be used.

When routing any additional cables for screen blanking:

- Route the cable the shortest way possible removing any left-over cable
- Fuses and cabling are user supplied. Therefore, route these cables so they are protected from physical damage and from surfaces that might exceed the cable's rated temperature threshold.
- Cable should be protected from physical damage from moving parts
- Do not expose the cable to chemicals or oil that may cause the wiring insulation to deteriorate
- Always route the cable so that it does not interfere with safe operation and maintenance of the vehicle.
- Provide mechanical support for the cable by securing it to the vehicle structure at approximately one foot intervals, taking care not to over tighten and pinch conductors or penetrate outer cable jacket.

Screen Blanking Box

Screen Blanking Box Terminal	Connection
12-xxV	Input from vehicle motion sensing circuitry. Please refer to label on Screen Blanking Box for allowable voltage input range.
GND	DC -
	These two terminals are for a user provided serial cable. The cable must be constructed so that Pin 7 (RTS) connects to switched side of the connection and Pin 8 (CTS) connects to the other terminal .

Please refer to the appropriate illustration below for Screen Blanking Box wiring diagrams.

<p>Caution:</p> 	<p>Do not exceed the maximum input voltage, either 60 or 72VDC, specified on the Screen Blanking Box label when using this configuration.</p>
---	---

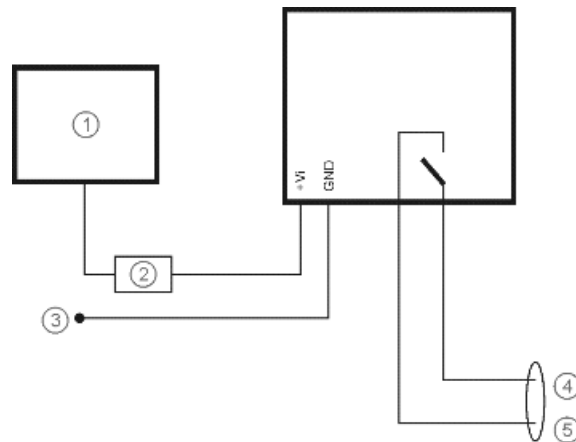

1. Motion Circuitry - The voltage at the +Vi input on the Screen Blanking Box must be between 10VDC and 60 or 72VDC (see Screen Blanking Box label) when the vehicle is in motion and less than 5VDC when the vehicle is not in motion.
2. 3 Amp Fuse
3. To -Vo on Vehicle, i.e., Negative Battery Terminal
4. To Pin 7 of COM1 or COM2 (Gray wire when using VM1080CABLE)
5. To Pin 8 of COM1 or COM2 (Black wire when using VM1080CABLE)

Screen Blanking with Switch

In applications where it is impractical to use the screen blanking box due to vehicle voltage or lack of a motion sensing signal, screen blanking can be controlled via a user supplied switch or relay that provides an electrical conductive connection on vehicle motion.

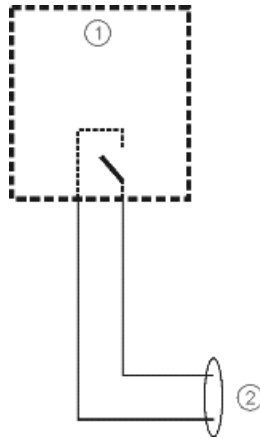

1. Switch
2. To Pins 7 and 8 of COM1 or COM2

Fuse

The Thor VM1 uses an 8A time delay (slow blow), fuse that is externally accessible and user replaceable. The fuse is located on the back of the Quick Mount Smart Dock. The fuse is accessed by unscrewing the cap as indicated below.

Should it need replacement, replace with same size, rating and type of fuse – Littelfuse 0215008.MXP or equivalent.

Fuse has voltage on it even when power is off. Always disconnect input power before changing the fuse.

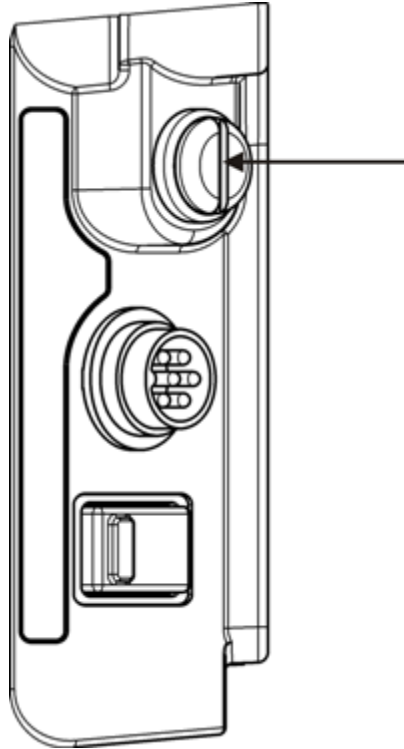

Chapter 4 - Product Agency Compliance - Thor VM1

Class A Digital Device

FCC Rules, Part 15

This device complies with FCC Rules, part 15. Operation is subject to the following two conditions:

1. This device may not cause harmful interference, and
2. This device must accept any interference received, including interference that may cause undesired operation.

NOTE: This equipment has been tested and found to comply with the limits for a Class A digital device, pursuant to Part 15 of the FCC Rules. These limits are designed to provide reasonable protection against harmful interference when the equipment is operated in a commercial environment. This equipment generates, uses, and can radiate radio frequency energy and, if not installed and used in accordance with the instruction manual, may cause harmful interference to radio communications.

Operation of this equipment in a residential area is likely to cause harmful interference in which case the user will be required to correct the interference at his own expense.

Notice

Changes or modifications made to this equipment not expressly approved by Honeywell may void the FCC authorization to operate this equipment.

EMC Directive Requirements

This is a Class A product. In a domestic environment this product may cause radio interference in which case the user may be required to take adequate measures.

Canada, Industry Canada (IC) Notices

This Class A digital apparatus complies with Canadian RSS-GEN issue 3:2010 and RSS-210 issue 8:2010.

Operation is subject to the following two conditions: (1) this device may not cause interference, and (2) this device must accept any interference, including interference that may cause undesired operation of the device.

Radio Frequency (RF) Exposure Information

The radiated output power of the Honeywell Thor VM1 is below the Industry Canada (IC) radio frequency exposure limits. The Honeywell Thor VM1 should be used in such a manner such that the potential for human contact during normal operation is minimized.

This device has been certified for use in Canada. Status of the listing in the Industry Canada's REL (Radio Equipment List) can be found at the following web address: <http://www.ic.gc.ca/app/sitt/reldtel/srch/nwRdSrch.do?lang=eng>

Additional Canadian information on RF exposure also can be found at the following web address:
<http://www.ic.gc.ca/eic/site/smt-gst.nsf/eng/sf08792.html>

Canada, avis d'Industry Canada (IC)

Cet appareil numérique de classe A est conforme aux normes canadiennes RSS-GEN numéro 3:2010 et RSS-210 numéro 8:2010.

Son fonctionnement est soumis aux deux conditions suivantes : (1) cet appareil ne doit pas causer d'interférence et (2) cet appareil doit accepter toute interférence, notamment les interférences qui peuvent affecter son fonctionnement.

Informations concernant l'exposition aux fréquences radio (RF)

La puissance de sortie émise par le Honeywell Thor VM1 est inférieure à la limite d'exposition aux fréquences radio d'Industry Canada (IC). Utilisez le Honeywell Thor VM1 de façon à minimiser les contacts humains lors du fonctionnement normal.

Ce périphérique est homologué pour l'utilisation au Canada. Pour consulter l'entrée correspondant à l'appareil dans la liste d'équipement radio (REL - Radio Equipment List) d'Industry Canada rendez-vous sur:

<http://www.ic.gc.ca/app/sitt/retel/srch/nwRdSrch.do?lang=eng>

Pour des informations supplémentaires concernant l'exposition aux RF au Canada rendez-vous sur :

<http://www.ic.gc.ca/eic/site/smt-gst.nsf/eng/sf08792.html>

ANATEL (Brazil)

Este equipamento opera em caráter secundário, isto é, não tem direito a proteção contra interferência prejudicial, mesmo de estações do mesmo tipo, e não causar interferência a sistema operando em caráter primário.

Li-Ion Battery

When disposing of the Thor VM1 UPS battery, the following precautions should be observed: The battery should be disposed of properly. The battery should not be disassembled or crushed. The battery should not be heated above 212°F (100°C) or incinerated.

RF Safety Notice



This device is intended to transmit RF energy. For protection against RF exposure to humans and in accordance with FCC rules and Industry Canada rules, this transmitter should be installed such that a minimum separation distance of at least 20 cm (7.8 in.) is maintained between the antenna and the general population. This device can only be co-located with FCC ID:TWG-SDCPE15N.

Waste Electrical and Electronic Equipment (WEEE)



Important:

This symbol is placed on the product to remind users to dispose of Waste Electrical and Electronic Equipment (WEEE) appropriately, per Directive 2002-96-EC. In most areas, this product can be recycled, reclaimed and re-used when properly discarded. Do not discard labeled units with trash. For information about proper disposal, visit www.honeywellaidc.com.

R&TTE Directive Requirements



Dealer License - Republic of Singapore

Complies with
IDA Standards
DA103458

Republic of Singapore - LXE Dealer License Number DA103458 complies with IDA Standards.

Lithium Battery Safety Statement

Caution: Lithium battery inside. Danger of explosion if battery is incorrectly replaced. Replace only with same or equivalent type recommended by battery manufacturer. (US)

Attention: Contient une pile de lithium. Risque d'explosion dans le cas où la pile ne serait pas correctement remplacée. Remplacer uniquement avec une pile semblable ou équivalente au type de pile recommandé par le fabricant. (FR)

Forsigtig: Indeholder lithiumbatterier. Risiko for eksplosion, hvis batteriet udskiftes forkert. Må kun udskiftes med samme eller tilsvarende type, som anbefalet af fabrikanten. (DK)

Varoitus: Tämä tuote käyttää laservaloa. Skannerissa on jokin seuraavista tarroista. Lue Huomio-kohta. (FI)

Vorsicht: Enthält Lithium-Batterie. Bei unsachgemäßem Ersatz besteht Explosionsgefahr. Nur durch gleichen oder vom Hersteller empfohlenen Typ ersetzen. (DE)

Attenzione: Batteria al litio. Pericolo di esplosione qualora la batteria venga sostituita in maniera scorretta. Sostituire solo con lo stesso tipo o equivalente consigliato per il fabbricante. (IT)

Atenção: Contém pilha de lítio. Há perigo de explosão no caso de uma substituição incorreta. Substitua somente pelo mesmo tipo, ou equivalente, recomendado pelo fabricante. (PT)

Varning: Innehåller litiumbatteri. Fara för explosion om batteriet är felaktigt placerat eller av fel typ. Använd endast samma eller motsvarande typ batterier rekommenderade av tillverkaren. (SE)

Advarsel: Innmontert Lithium batteri. Eksplosjonsfare ved feil montering av batteri. Benytt kun batteri anbefalt av produsent. (NO)

Cuidado: Pila de litio adentro. Peligro de explosión si la pila se reemplaza incorrectamente. Reemplace solamente con el mismo tipo o equivalente recomendado por el fabricante. (ES)

Oppassen: Bevat Lithium-batterij. Incorrecte plaatsing van batterij kan leiden tot explosiegevaar. Alleen vervangen door hetzelfde of door fabrikant aanbevolen gelijkwaardig type. (NL)

<p>Προσοχή: Υπάρχει μπαταρία από λίθιο εσωτερικά. Υπάρχει κίνδυνος έκρηξης εάν η μπαταρία αντικατασταθεί με λανθασμένο τρόπο. Αντικαταστήστε μόνο με τον ίδιο ή ισοδύναμο τύπο που συνιστάται από τον κατασκευαστή. (GR)</p>	<p>주의: 리튬 배터리 내부. 배터리가 잘못 설치되었을 경우 폭발의 위험이 있습니다. 동일한 배터리, 또는 배터리 제조업체가 권장하는 배터리로 교체하십시오. (KR)</p>
<p>注意: リチウム電池が入っています。間違った種類の電池を使用すると、破裂する恐れがあります。同じ電池、または電池製造元が推奨する同等の電池を使用してください。 (JP)</p>	<p>小心: 内装锂电池。如电池更换不当，则有发生爆炸的危险。只能用电池制造商推荐的相同或同等电池进行更换。 (CN)</p>
<p>Dikkat: İçinde lityum bataryası bulunur. Bataryanın yanlış değiştirilmesi patlama tehlikesi yaratır. Aynısıyla veya üreticinin önerdiği eşdeğer tipte değiştirin. (TR)</p>	

Legend: Chinese – CN; Danish – DK; Dutch – NL; English – US; Finnish – FI; French – FR; German – DE; Greek – GR; Italian – IT; Japanese – JP; Korean – KR; Norwegian – NO; Portuguese – PT; Spanish – ES; Swedish – SE; Turkish – TR.

Vehicle Power Supply Connection Safety Statement

Vehicle Power Supply Connection: If the supply connection is made directly to the battery, a 10A slow-blow fuse should be installed in the positive lead within 5 inches (12.7 cm.) of the battery positive (+) terminal. (US)

Raccordement de l'alimentation du véhicule Si l'alimentation est raccordée directement à la batterie, un fusible à action retardée de 10A doit être installé sur le câble positif à moins de 12,7 cm de la borne positive (+) de la batterie. (FR)

EL forsyning af køretøjet. Er forsyningsforbindelsen direkte tilknyttet til batteriet og og tilsluttet til den positive part indenfor 12,7 cm (+ delen). vil der være en langsom tændelse af 10 ampere. (DK)

Kytkentä ajoneuvon virtalähteeseen Jos virtaa otetaan suoraan akusta, 10 ampeerin hidas sulake on asennettava positiiviseen johtoon enintään 12 cm:n etäisyydelle akun positiivisesta (+) navasta. (FI)

Anschluss an Fahrzeugbatterie Bei direktem Anschluss an die Fahrzeugbatterie sollte eine träge 10A-Sicherung in die positive Leitung zwischengeschaltet werden, und zwar nicht weiter als ca. 13 cm von der positiven (+) Batterieklemme entfernt. (DE)

Σύνδεση Τροφοδοτικού Ισχύος Οχήματος Αν η σύνδεση του τροφοδοτικού γίνει κατευθείαν στη μπαταρία, μια ασφάλεια βραδείας τήξης των 10Α θα πρέπει να τοποθετηθεί στο θετικό καλώδιο εντός 5 ιντσών (12,7 εκ.) του θετικού (+) ακροδέκτη της μπαταρίας. (GR)

Collegamento dell'alimentazione del veicolo Se il collegamento dell'alimentazione viene stabilito direttamente con la batteria, è necessario installare un fusibile ad azione lenta da 10A nel conduttore positivo a meno di 5 in. (12,7 cm) dal terminale positivo (+) della batteria. (IT)

Tilkople strømforsyningen til kjøretøyet Hvis strømforsyningen koples direkte til batteriet, skal det installeres en 10A treg sikring i den positive ledningen innen 12,7 cm fra plusspolen (+) på batteriet. (NO)

Ligação do fornecimento de corrente do veículo Se a ligação de fornecimento de corrente for ligada directamente à bateria, deve instalar-se um fusível de 10A no terminal positivo, a 12,7 cm. do terminal positivo (+) da bateria. (PT)

Conexión de suministro eléctrico para el vehículo Si el suministro eléctrico se proporciona directamente a la batería, se debe instalar un fusible de retardo de 10A en el conductor positivo, como máximo a 12,7 cm (5 pulgadas) del terminal positivo (+). (ES)

Fordonets strömförsörjningskoppling Om strömkopplingen görs direkt till batteriet, måste en 10A-säkring installeras i den positivt laddade ledningen inom 12.7 cm från batteriets pluspol (+). (SE)

Taşıt Güç Kaynağı Bağlantısı Kaynak bağlantısı doğrudan aküye yapılırsa, pozitif bağlantı kablosu üzerinde akünün pozitif (+) kutbuna 12.7 cm mesafede 10A'lık yavaş atan bir sigorta monte edilmelidir. (TR)

Legend: Danish – DK; English – US; Finnish – FI; French- - FR; German – DE; Greek – GR; Italian – IT; Norwegian – NO; Portuguese – PT; Spanish – ES; Swedish – SE; Turkish – TR.

Chapter 5 - Technical Assistance

If you need assistance installing or troubleshooting your device, please contact us by using one of the methods below:

Knowledge Base: www.hsmknowledgebase.com

Our Knowledge Base provides thousands of immediate solutions. If the Knowledge Base cannot help, our Technical Support Portal (see below) provides an easy way to report your problem or ask your question.

Technical Support Portal: www.hsmsupportportal.com

The Technical Support Portal not only allows you to report your problem, but it also provides immediate solutions to your technical issues by searching our Knowledge Base. With the Portal, you can submit and track your questions online and send and receive attachments.

Web form: www.hsmcontactsupport.com

You can contact our technical support team directly by filling out our online support form. Enter your contact details and the description of the question/problem.

Telephone: www.honeywellaidc.com/locations

For our latest contact information, please check our website at the link above.

Product Service and Repair

Honeywell International Inc. provides service for all of its products through service centers throughout the world. To obtain warranty or non-warranty service, please visit www.honeywellaidc.com and select **Support > Contact Service and Repair** to see your region's instructions on how to obtain a Return Material Authorization number (RMA #). You should do this prior to returning the product.

Limited Warranty

Honeywell International Inc. ("HII") warrants its products to be free from defects in materials and workmanship and to conform to HII's published specifications applicable to the products purchased at the time of shipment. This warranty does not cover any HII product which is (i) improperly installed or used; (ii) damaged by accident or negligence, including failure to follow the proper maintenance, service, and cleaning schedule; or (iii) damaged as a result of (A) modification or alteration by the purchaser or other party, (B) excessive voltage or current supplied to or drawn from the interface connections, (C) static electricity or electro-static discharge, (D) operation under conditions beyond the specified operating parameters, or (E) repair or service of the product by anyone other than HII or its authorized representatives.

This warranty shall extend from the time of shipment for the duration published by HII for the product at the time of purchase ("Warranty Period"). Any defective product must be returned (at purchaser's expense) during the Warranty Period to HII factory or authorized service center for inspection. No product will be accepted by HII without a Return Materials Authorization, which may be obtained by contacting HII. In the event that the product is returned to HII or its authorized service center within the Warranty Period and HII determines to its satisfaction that the product is defective due to defects in materials or workmanship, HII, at its sole option, will either repair or replace the product without charge, except for return shipping to HII.

EXCEPT AS MAY BE OTHERWISE PROVIDED BY APPLICABLE LAW, THE FOREGOING WARRANTY IS IN LIEU OF ALL OTHER COVENANTS OR WARRANTIES, EITHER EXPRESSED OR IMPLIED, ORAL OR WRITTEN, INCLUDING, WITHOUT LIMITATION, ANY IMPLIED WARRANTIES OF MERCHANTABILITY OR FITNESS FOR A PARTICULAR PURPOSE, OR NON-INFRINGEMENT.

HII'S RESPONSIBILITY AND PURCHASER'S EXCLUSIVE REMEDY UNDER THIS WARRANTY IS LIMITED TO THE REPAIR OR REPLACEMENT OF THE DEFECTIVE PRODUCT WITH NEW OR REFURBISHED PARTS. IN NO EVENT

SHALL HII BE LIABLE FOR INDIRECT, INCIDENTAL, OR CONSEQUENTIAL DAMAGES, AND, IN NO EVENT, SHALL ANY LIABILITY OF HII ARISING IN CONNECTION WITH ANY PRODUCT SOLD HEREUNDER (WHETHER SUCH LIABILITY ARISES FROM A CLAIM BASED ON CONTRACT, WARRANTY, TORT, OR OTHERWISE) EXCEED THE ACTUAL AMOUNT PAID TO HII FOR THE PRODUCT. THESE LIMITATIONS ON LIABILITY SHALL REMAIN IN FULL FORCE AND EFFECT EVEN WHEN HII MAY HAVE BEEN ADVISED OF THE POSSIBILITY OF SUCH INJURIES, LOSSES, OR DAMAGES. SOME STATES, PROVINCES, OR COUNTRIES DO NOT ALLOW THE EXCLUSION OR LIMITATIONS OF INCIDENTAL OR CONSEQUENTIAL DAMAGES, SO THE ABOVE LIMITATION OR EXCLUSION MAY NOT APPLY TO YOU.

All provisions of this Limited Warranty are separate and severable, which means that if any provision is held invalid and unenforceable, such determination shall not affect the validity of enforceability of the other provisions hereof. Use of any peripherals not provided by the manufacturer may result in damage not covered by this warranty. This includes but is not limited to: cables, power supplies, cradles, and docking stations. HII extends these warranties only to the first end-users of the products. These warranties are non-transferable.

The duration of the limited warranty for the Thor VM1 is 1 year.

The duration of the limited warranty for the Thor VM1 Quick Mount Smart Dock is 1 year.

The duration of the limited warranty for the Thor VM1 Vehicle Mount Assembly is 1 year.

The duration of the limited warranty for the Thor VM1 internal UPS battery is 1 year.

The duration of the limited warranty for the Thor VM1 AC power supply and cables is 1 year.

The duration of the limited warranty for the Thor VM1 DC-DC Converter is 1 year.

The duration of the limited warranty for the Thor VM1 cables (USB, Serial, Communication, Power) is 1 year.



Honeywell Scanning & Mobility
9680 Old Bailes Road
Fort Mill, SC 29707
www.honeywellaidc.com