

LinkStation 200

## **User Manual**

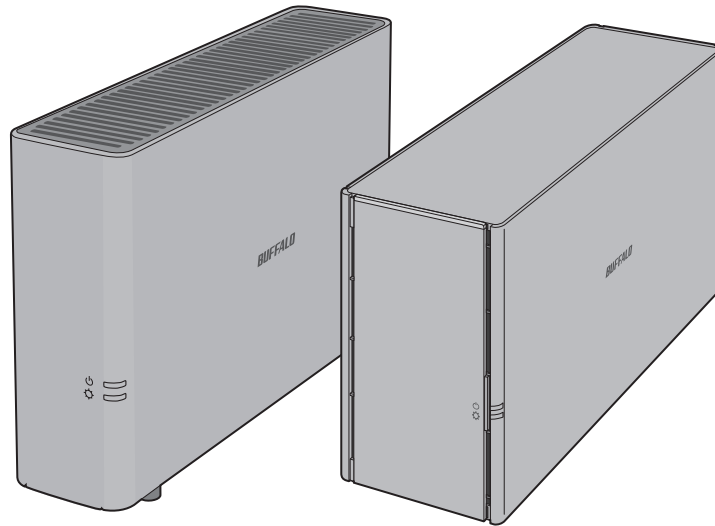

***Americas: [www.buffaloamericas.com](http://www.buffaloamericas.com)***

***Europe: [www.buffalo-technology.com](http://www.buffalo-technology.com)***

***Asia Pacific: [www.buffalo-asia.com](http://www.buffalo-asia.com)***

35020312-10  
2016.11

# Contents

<b>Chapter 1 Getting Started .....</b>	<b>6</b>
Diagrams.....	6
Changing Admin Password and Adding a Shared Folder .....	7
Installing Applications.....	9
NAS Navigator2.....	9
SmartPhone Navigator.....	10
WebAccess .....	10
Accessing Shared Folders .....	10
Accessing from a Computer .....	10
Accessing from a Mobile Device .....	10
Turning the LinkStation On and Off .....	11
<b>Chapter 2 Configuration .....</b>	<b>12</b>
Opening Settings from a Computer .....	12
Opening Settings from a Mobile Device .....	17
Settings That Can Be Changed from Your Mobile Device .....	19
<b>Chapter 3 Sharing Files .....</b>	<b>20</b>
Adding Shared Folders .....	20
Configuration from a Computer .....	20
Configuration from a Mobile Device .....	23
Adding Users .....	25
Configuration from a Computer .....	25
Configuration from a Mobile Device .....	27
Adding Groups .....	29

<b>Access Restrictions.....</b>	<b>30</b>
<b>Local Users/Groups.....</b>	<b>31</b>
<b>Active Directory .....</b>	<b>33</b>
<b>NT Domain.....</b>	<b>36</b>
<b>User Authentication with an External SMB Server.....</b>	<b>38</b>

## **Chapter 4 Managing Storage..... 42**

<b>RAID Arrays.....</b>	<b>42</b>
<b>Working with RAID Arrays .....</b>	<b>42</b>
<b>Using JBOD.....</b>	<b>42</b>
<b>Changing RAID Mode .....</b>	<b>43</b>
<b>RMM (RAID Mode Manager).....</b>	<b>45</b>
<b>RAID Scanning.....</b>	<b>46</b>
<b>Adding an External Hard Drive .....</b>	<b>47</b>
<b>Connecting an External Drive .....</b>	<b>47</b>
<b>Compatibility .....</b>	<b>47</b>
<b>Dismounting Drives .....</b>	<b>48</b>
<b>Dismounting with the Function Button .....</b>	<b>48</b>
<b>Dismounting from Settings on a Computer .....</b>	<b>48</b>
<b>Dismounting from Settings on a Mobile Device .....</b>	<b>49</b>
<b>Checking Drives .....</b>	<b>50</b>
<b>Formatting Drives .....</b>	<b>51</b>
<b>Erase Data on the LinkStation Completely .....</b>	<b>53</b>
<b>Disk Quotas .....</b>	<b>54</b>
<b>Quotas for Users.....</b>	<b>55</b>
<b>Quotas for Groups .....</b>	<b>55</b>
<b>Hard Drive Replacement .....</b>	<b>56</b>
<b>Rebuilding the RAID Array from a Computer .....</b>	<b>57</b>

Rebuilding the RAID Array from a Mobile Device .....59

**Chapter 5 Remote Access ..... 64**

WebAccess ..... 64

    Configuring from a Computer .....64

    Configuring from a Mobile Device .....67

FTP ..... 75

**Chapter 6 Backup ..... 77**

Back Up from the LinkStation ..... 77

    Preparing a Backup Destination.....77

    Configuring a Backup Job .....79

Backing Up Your Mac with Time Machine ..... 82

Copying from a USB Device ..... 87

    Configuring Direct Copy from a Computer .....88

    Configuring Direct Copy from a Mobile Device.....89

    Starting Direct Copy .....90

**Chapter 7 Multimedia ..... 92**

DLNA ..... 92

    Configuration from a Computer .....92

    Configuration from a Mobile Device .....94

    Playing Files .....95

    Connected DLNA-compatible Devices .....95

    Streaming to DLNA-compatible Devices .....96

    Disabling Playback from Specific Devices .....97

iTunes Server ..... 98

BitTorrent..... 99

Opening Download Manager .....	100
Downloading Files .....	102
<b>Connecting a Printer .....</b>	<b>103</b>
Setting Up a Printer from a Computer .....	103
Setting Up a Printer from a Mobile Device .....	104

## **Chapter 8 Advanced Features ..... 105**

Email Notification .....	105
Sleep Mode .....	106
Encrypting Data Transmission .....	108
Encrypting Settings Data .....	108
Encrypting FTP Transfer Data .....	108
SSL Encryption .....	108
Restoring Factory Defaults.....	109
Initializing from Settings .....	109
Initializing with the Function Button .....	109
Online Update .....	109
Name, Date, Time, and Language .....	110
Jumbo Frames .....	112
Changing the IP Address .....	114

## **Chapter 9 Utilities..... 116**

NAS Navigator2 for Windows.....	116
Mounting as a Network Drive .....	118
Changing the IP Address .....	119
NAS Navigator2 for macOS .....	120
Mounting as a Network Drive .....	122

Changing the IP Address .....	123
<b>NovaBACKUP .....</b>	<b>123</b>
Installing from CD .....	123
Installing from Website .....	124
<b><u>Chapter 10 Appendix .....</u></b>	<b><u>125</u></b>
When the Power LED Blinks.....	125
Default Settings .....	127
Specifications .....	127
<b><u>Chapter 11 Regulatory Compliance Information....</u></b>	<b><u>129</u></b>
For Customers in the United States .....	129
For Customers in Europe .....	129

# Chapter 1 Getting Started

## Diagrams

### LS210D

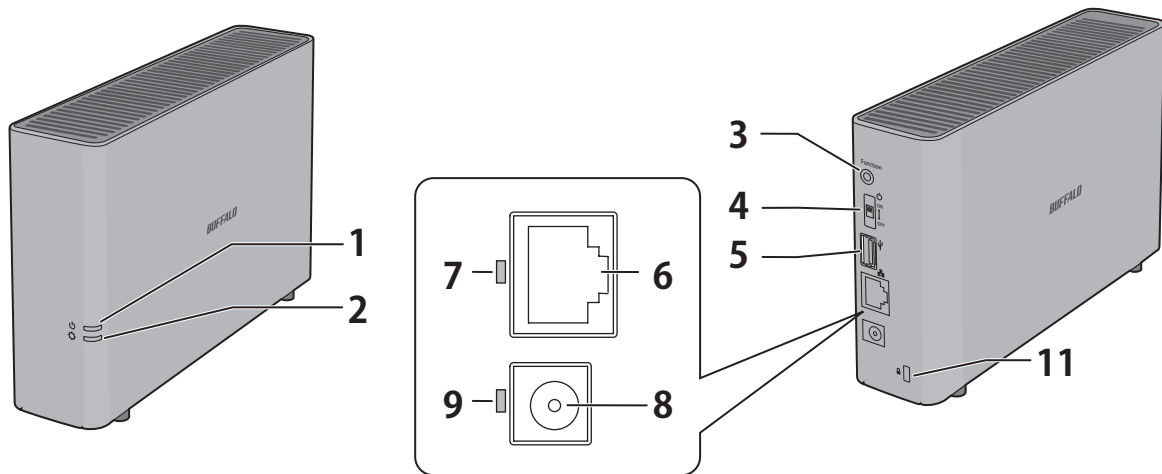

### LS220D, LS220DE

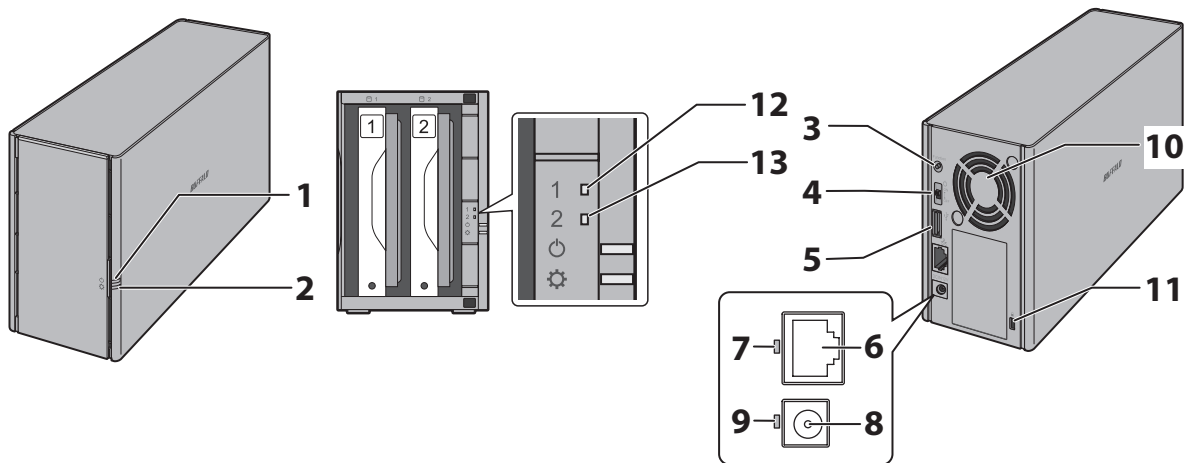

#### 1 Power LED

The white power LED will light up while the LinkStation is on.  
The white power LED blinks while booting or shutting down.  
The red power LED blinks when an error occurs.  
If there is a status message, the power LED blinks amber.  
If there is new firmware available, the power LED glows amber.

#### 2 Function LED

This LED glows white while the LinkStation is being initialized and while dismounting USB devices. It blinks white during Direct Copy.

For enclosure models, the red function LED glows when turning the LinkStation on for initial hard drive installation and blinks after pushing the function button.

### **3** Function Button

Use this button for Direct Copy, dismounting USB devices, and initializing settings.

### **4** Power Switch

Move the switch up and down to power on and off.

### **5** USB 2.0 Port

Compatible Buffalo USB hard drives, USB flash drives, digital cameras, and USB printers can be connected. USB hubs are not supported.

### **6** LAN Port

Connect to a router, hub, or switch on your Ethernet network with the included Ethernet cable.

### **7** Link and Activity LED

This LED shows network activity. It blinks green when the LinkStation is accessed over the network.

### **8** Power Connector

Use the included power cable to connect to a surge protector or outlet.

### **9** Power Status LED

The LED glows green when the power cable is connected.

### **10** Fan (LS220D and LS220DE only)

Do not block the fan.

### **11** Anti-Theft Security Slot

Use this slot to secure your LinkStation with a cable lock (not included).

### **12** Drive 1 Error LED (LS220D and LS220DE only)

If there is an error on drive 1, this LED will light.

### **13** Drive 2 Error LED (LS220D and LS220DE only)

If there is an error on drive 2, this LED will light.

---

## **Changing Admin Password and Adding a Shared Folder**

---

After initial setup, changing your password and creating other shared folders are recommended.

- 1** Double-click the  icon to start NAS Navigator2.



- 2 Right-click on your LinkStation's icon and select *Settings*. On the Mac, select the LinkStation's icon while holding down the control key, then select *Settings*.

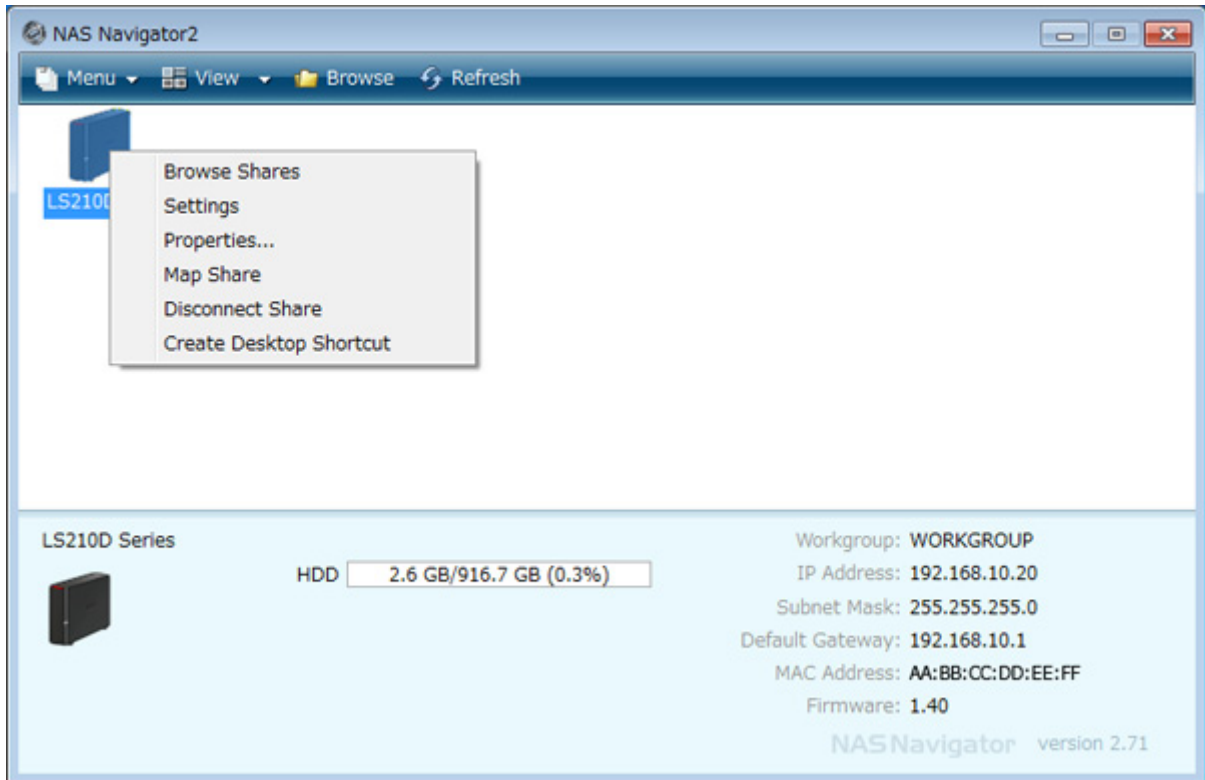

- 3 Changing the password from the default is recommended.

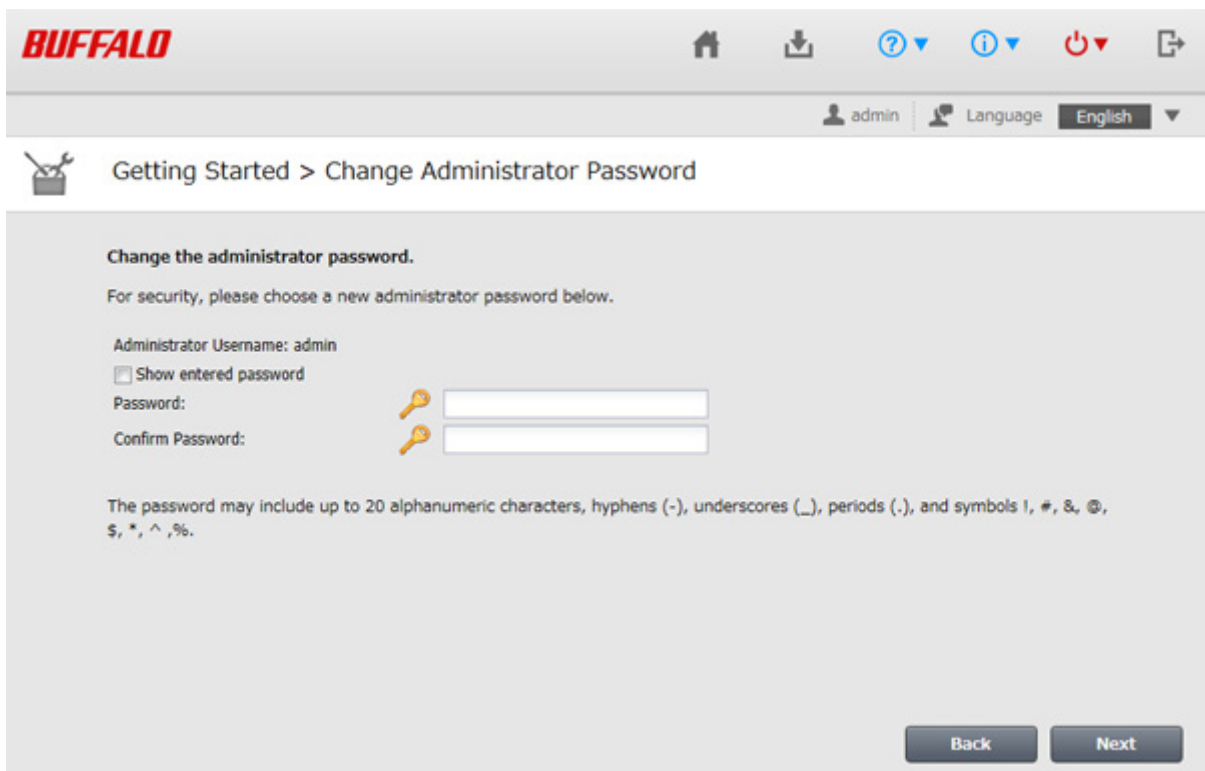

**Note:** You can open this same screen by clicking *Getting Started* from Easy Admin.

- 4 Enter the new password (twice), then click *Next*.

**Note:** The default username and password are "admin" and "password". To keep the defaults, leave both fields blank and click *Next*.

**5** Configure levels of sharing for all existing shared folders (public or private) to finish the initial setup wizard.

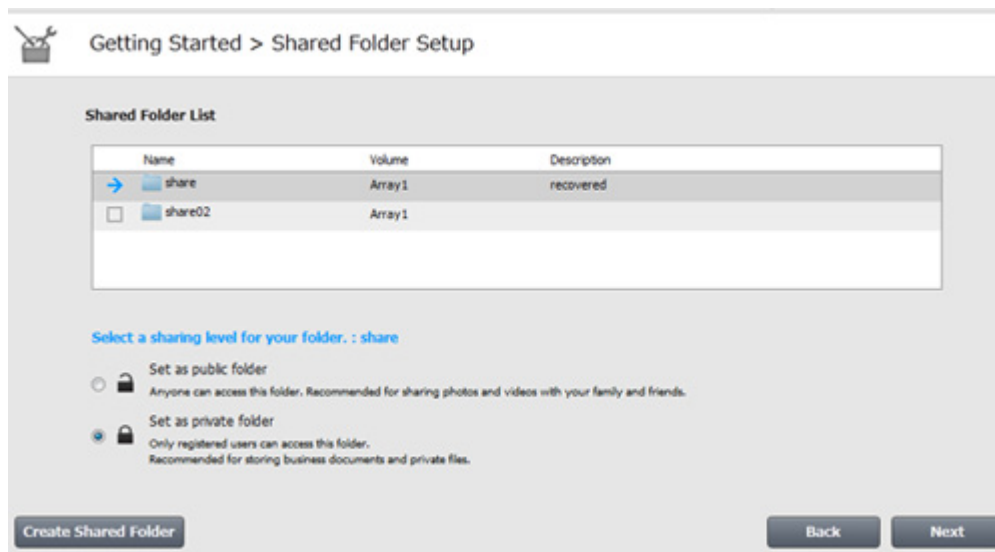

**Notes:**

- Select "Set as private folder" to restrict access to the folder to specific users.
- Click *Create Shared Folder* to create a new shared folder from the wizard. By default, SMB and AFP connections can be used to access this folder.

**6** Click *OK* when the following message is displayed.

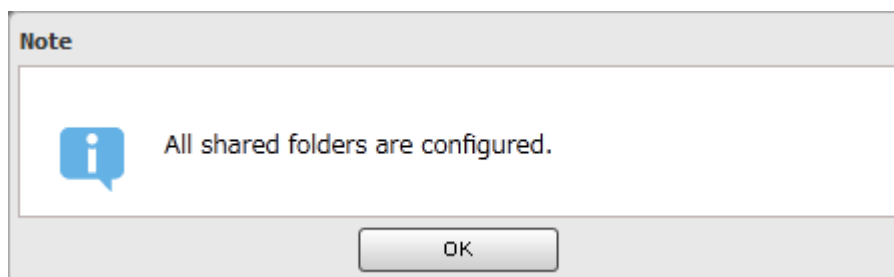

---

## Installing Applications

---

### NAS Navigator2

---

- 1** Insert the LinkNavigator CD into your computer. You can also download the latest LinkNavigator from the Buffalo website. LinkNavigator will launch.
- 2** Click *NAS Navigator2 Install*.
- 3** Follow the screen instructions to install NAS Navigator2.
- 4** When the installation finished, click *Finish*.

## SmartPhone Navigator

---

SmartPhone Navigator will allow to open LinkStation's Settings, change the IP address, and configure WebAccess settings. Follow the instructions below to install the application.

- 1 Open the App Store (iOS devices) or Google Play (Android devices).
- 2 Install "SmartPhone Navigator".

## WebAccess

---

WebAccess will allow you access files in the LinkStation. Follow the instructions below to install WebAccess application.

- 1 Open the App Store (iOS devices) or Google Play (Android devices).
- 2 Install "WebAccess".

---

## Accessing Shared Folders

---

### Accessing from a Computer

---

- 1 Double-click the  icon to start NAS Navigator2.
- 2 In NAS Navigator2, double-click your LinkStation's icon. The Explorer will open with shared folders' lists. For macOS, the LinkStation is mounted as a drive icon on the desktop or it is displayed in the sidebar of the Finder.  
**Note:** When you access a shared folder from a Windows PC, you may be asked to enter a username and password. In such a case, enter "guest" for the username and the password is blank.

### Accessing from a Mobile Device

---

To access shared folders from a mobile device with the following steps, you must configure WebAccess settings first. To configure WebAccess, see the "WebAccess" section in chapter 5.

- 1 Open SmartPhone Navigator.
- 2 Tap your LinkStation from the NAS list.
- 3 Tap *Browse*.

**Note:** Alternatively, you can access shared folders from the WebAccess app. Open the application and tap your LinkStation's hostname in the NAS list.

---

## Turning the LinkStation On and Off

---

Move the power switch on the back of the LinkStation to the "on" position to turn it on. To turn it off, move the switch to the "off" position and wait for the unit to fully shut down before unplugging it. Never unplug the AC adapter without properly shutting down the LinkStation first.

When all the LEDs on the front of the LinkStation turn off, the shutdown process is complete.

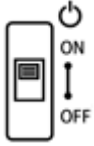

# Chapter 2 Configuration

Configure and manage your LinkStation using the Settings interface, accessible from a browser window. Open the interface using the procedure below or type the LinkStation's IP address in the URL field of your browser. Within Settings, the Easy Admin page gives you quick access to commonly used settings.

## Opening Settings from a Computer

**Note:** Internet Explorer 9, Microsoft Edge, Firefox 18, Google Chrome 24, Safari 5, and later are supported. If you have difficulty viewing Settings, check the following:

- If you have a proxy server enabled in the browser settings, disable the proxy server.

### Opening Easy Admin

The Easy Admin page makes it easy to change common settings. Follow the steps below to open Easy Admin.

- 1 Double-click the  icon to start NAS Navigator2.
- 2 Right-click on your LinkStation's icon and choose *Settings*. For macOS, click your LinkStation's icon while holding down the control key, then select *Settings*.

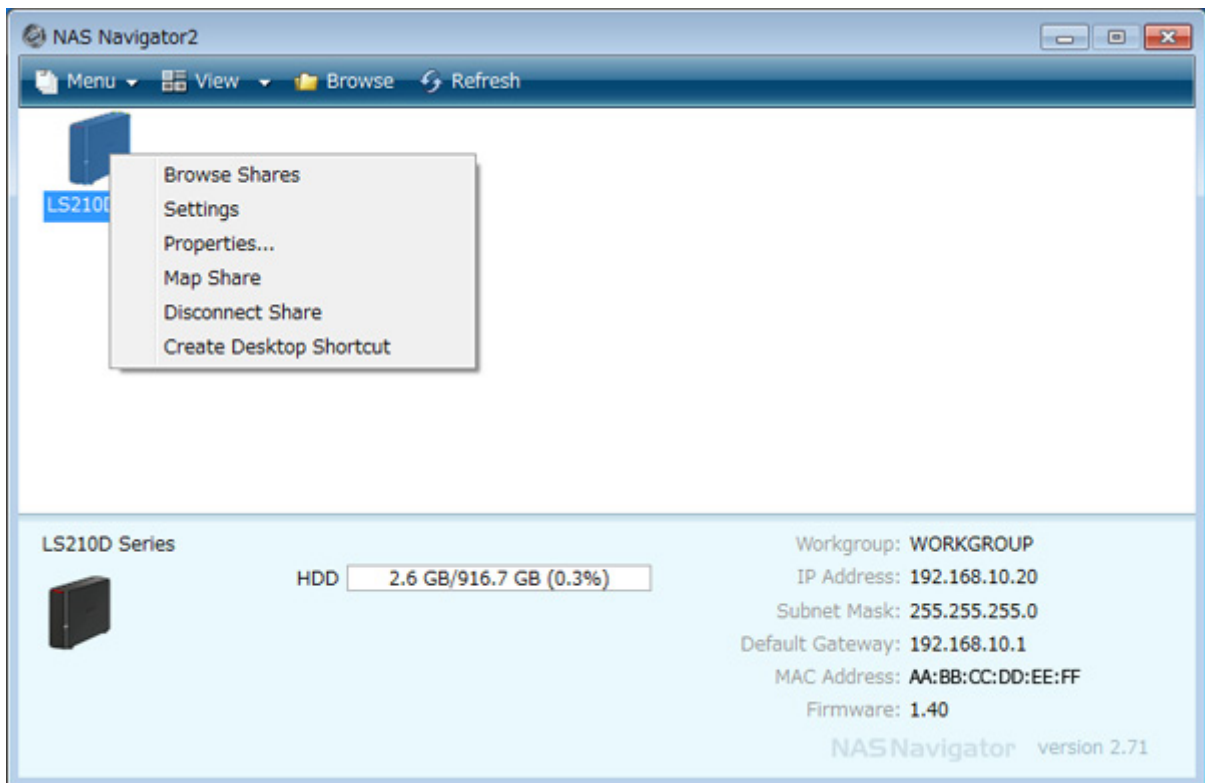

3 The Easy Admin screen will open.

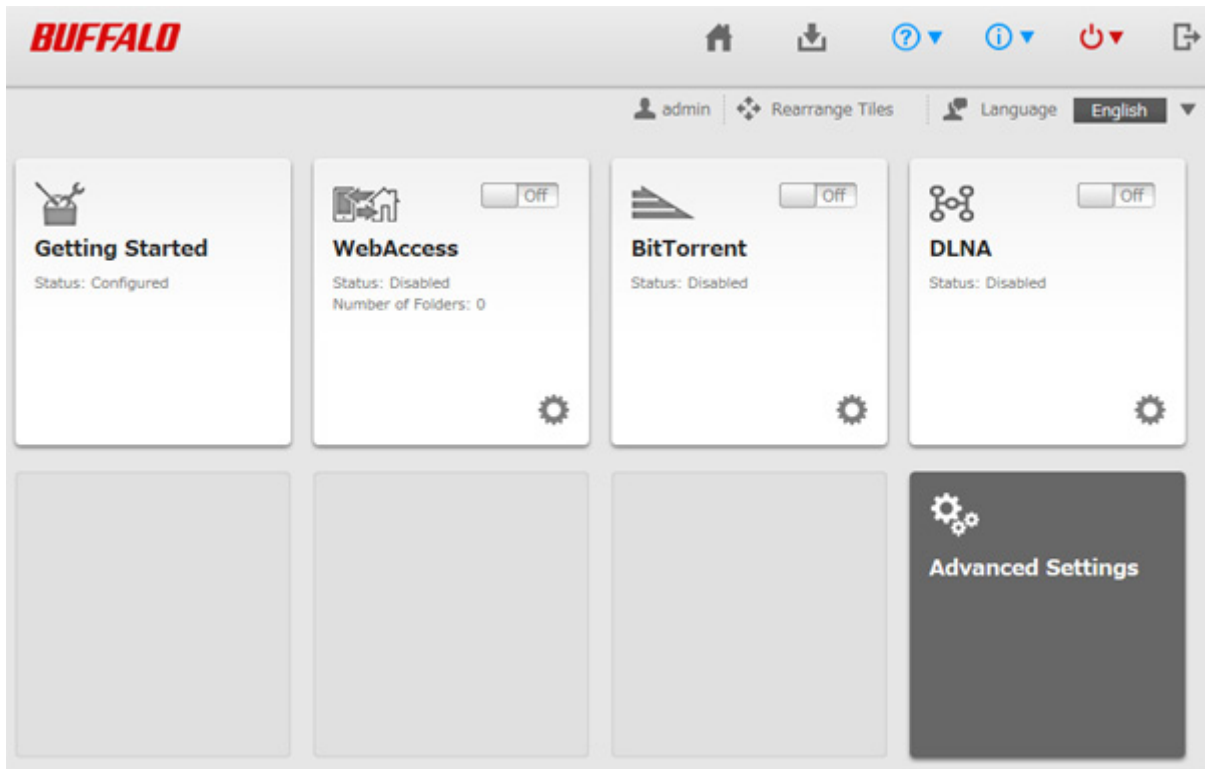

**Notes:**

- If you click any buttons, you will need to enter a username and password.

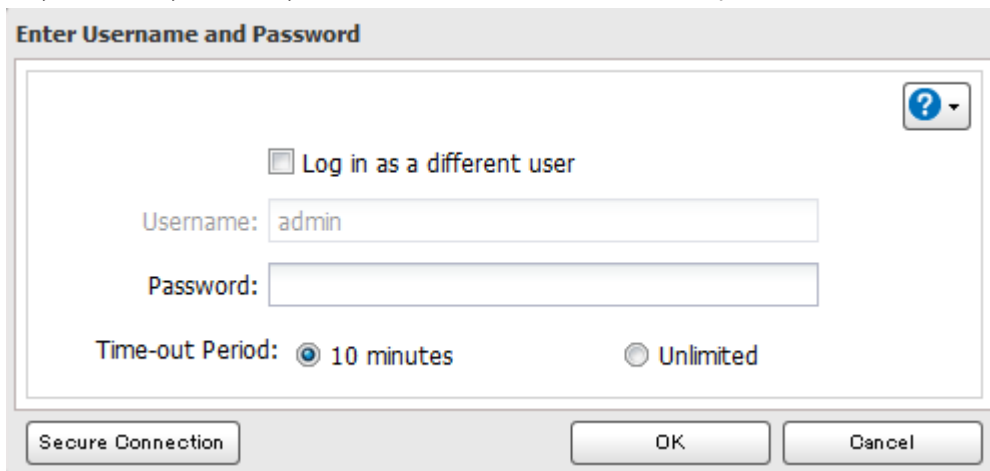

- If the time-out period is set to "10 minutes", you will be logged out of Settings after 10 minutes of inactivity. You will also be logged out when you reboot the LinkStation or close the web browser, even if you select "Unlimited".
- Click *Secure Connection* to log in with an encrypted connection.
- You can also use Bonjour to log in to Settings from macOS. In Safari, click *View - Show Bookmarks Bar*. From Bookmarks, click *Bonjour - LinkStation name*.

**Getting Started**

The wizard lets you configure the following settings:

- Changing administrator password
- Creating shared folders
- Access restrictions

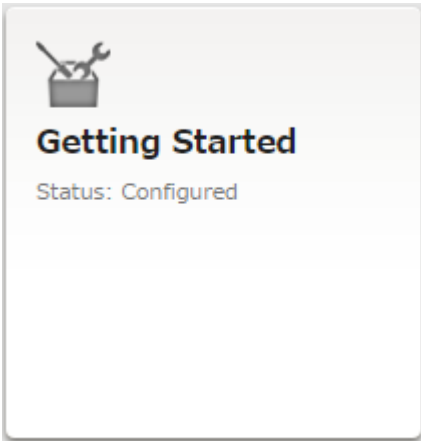

The first time you access your LinkStation, this page will open. Step through the wizard to change your administrative password.

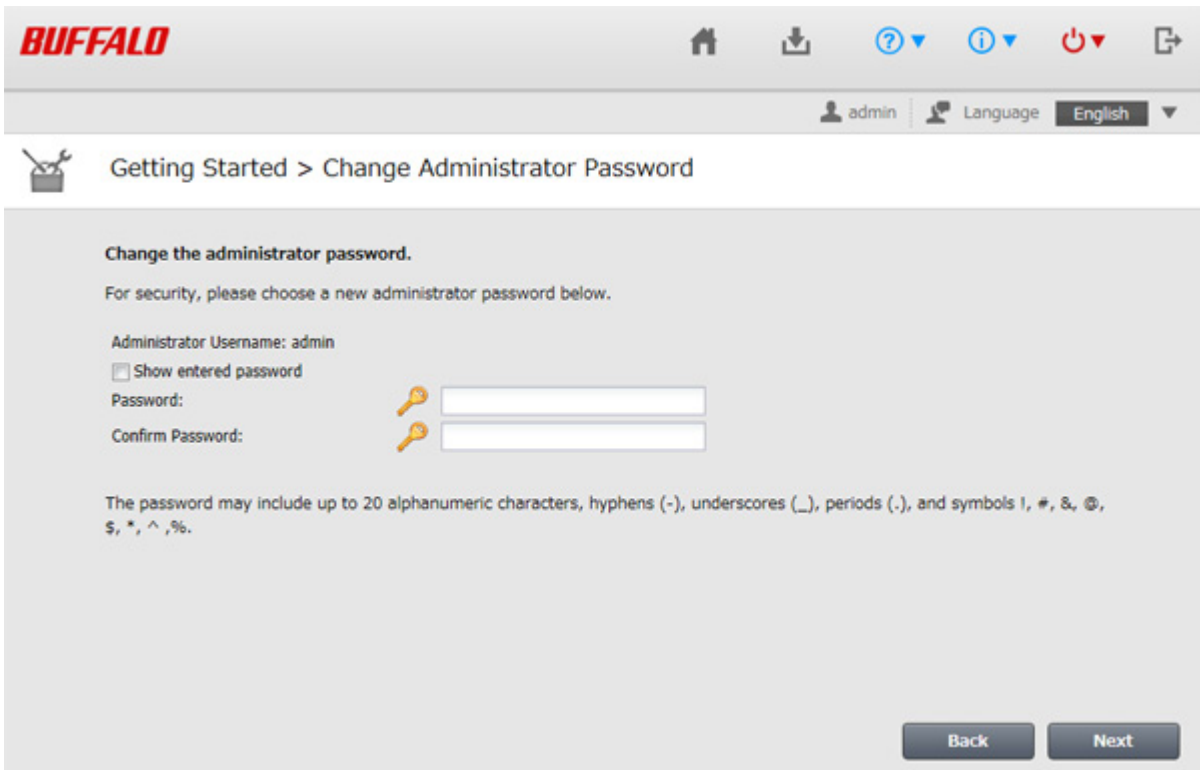

## WebAccess

Configure WebAccess to access your LinkStation remotely. Refer to the WebAccess section in chapter 5 for more information.

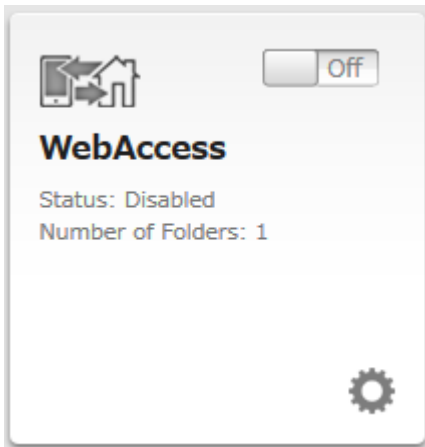

### BitTorrent

Configure BitTorrent to download large files efficiently. Refer to the BitTorrent section in chapter 7 for more information.

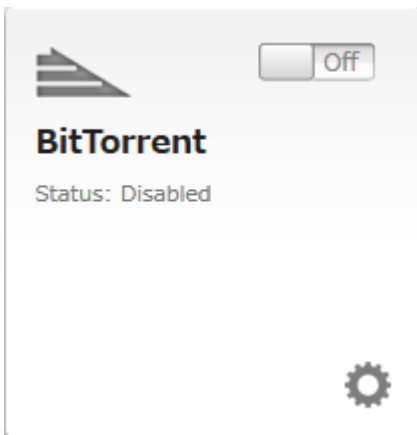

### DLNA

Configure DLNA to stream media files to DLNA-compatible devices on the LAN. Refer to the DLNA section in chapter 7 for more information.

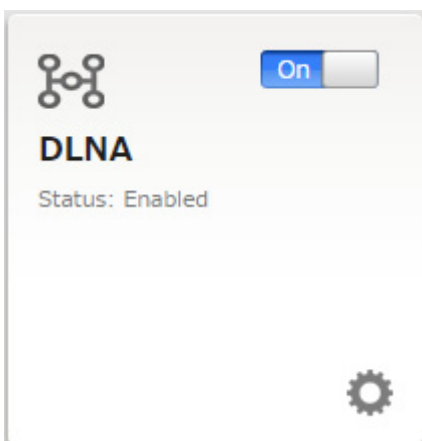



## Opening Advanced Settings

- 1 Click *Advanced Settings* in Easy Admin.

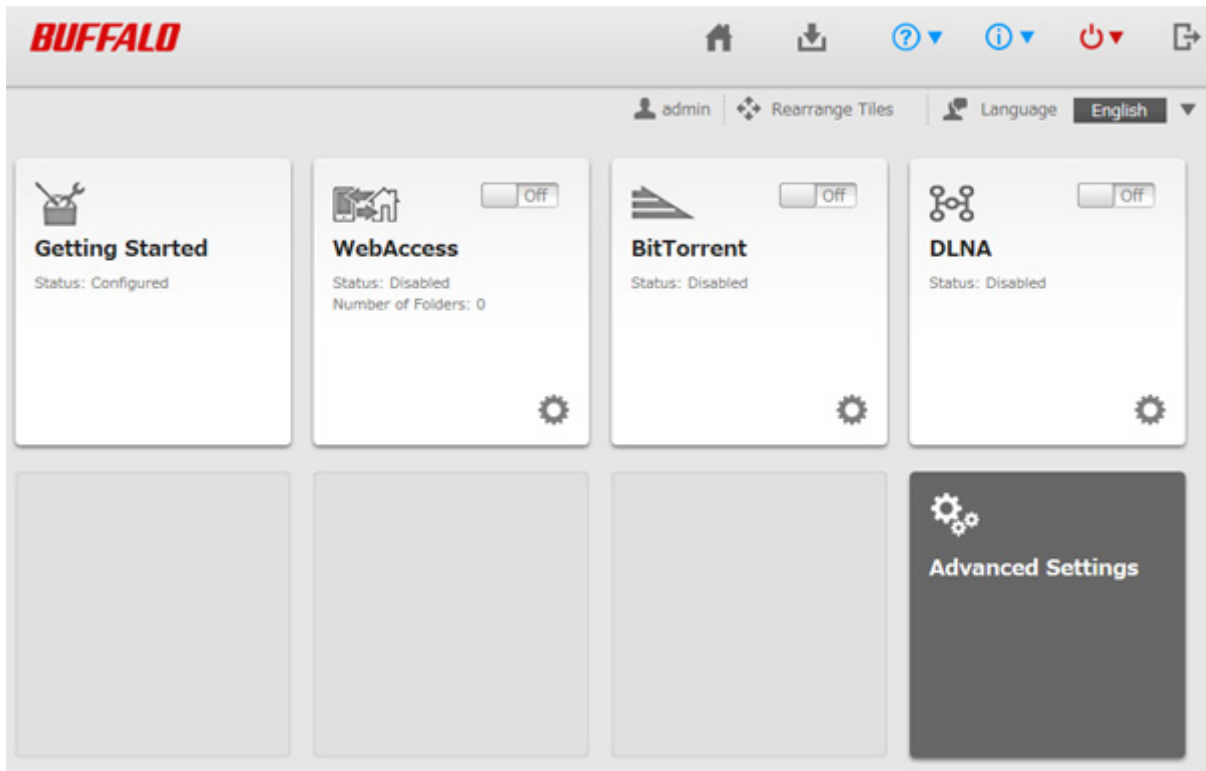

- 2 Enter the administrator username and password, then click *OK*.

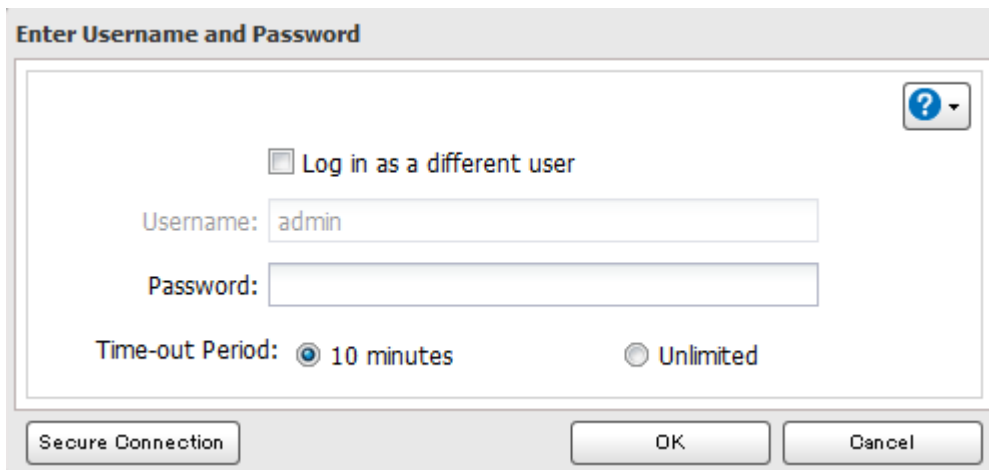
The image shows a dialog box titled 'Enter Username and Password'. It has a question mark icon in the top right corner. Inside the dialog, there is a checkbox labeled 'Log in as a different user'. Below this, there are two input fields: 'Username:' with the text 'admin' and 'Password:'. At the bottom, there are two radio buttons for 'Time-out Period': '10 minutes' (which is selected) and 'Unlimited'. At the bottom of the dialog, there are three buttons: 'Secure Connection', 'OK', and 'Cancel'.

3 The Advanced Settings screen will open.

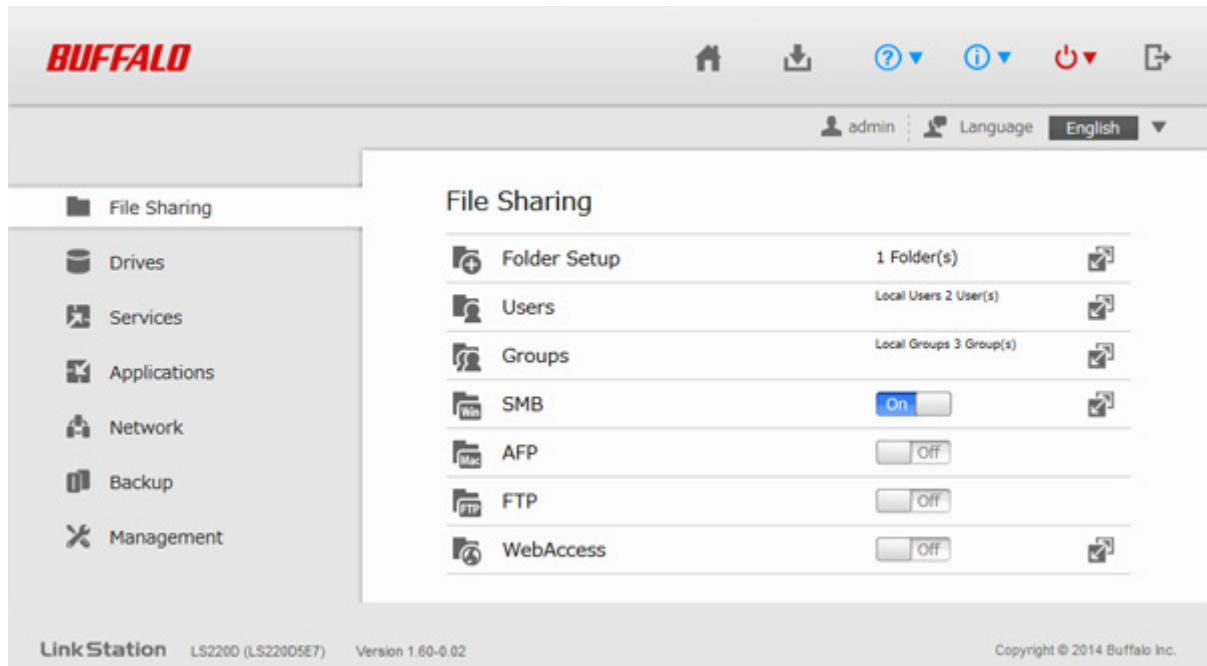

**Notes:**

- Username/Password Combinations:

Username	Password	Settings Available
admin	password	All
guest	blank	System information (read-only)
Your username	Your password	If a user is assigned as an administrator, all settings are available. If assigned as a general user, the user can only access read-only system information and change their own password. If assigned as a power user, the user can create and edit shared folders, users, and general users groups.

- To go back to Easy Admin, click the Home icon.

## Opening Settings from a Mobile Device

You can access your LinkStation's Settings from your iOS or Android device. Download and install "SmartPhone Navigator" from the App Store or Google Play.

**Notes:**

- If you have an older version of SmartPhone Navigator installed on your device, update it to the latest version. Your icons and software may be slightly different from the examples in this manual.
- You must be logged in as an administrator to change settings. To use SmartPhone Navigator, log in as a member of the administrators group.
- Mobile devices that support mobile-optimized Settings display are listed below:  
 iPhone, iPad, and iPod touch\*  
 Android smartphones and tablets\*\*  
 \* iOS 5 or later  
 \*\* Android 2.3 or later

1 Open "SP Navigator" on your iOS device or "SmartPhone Navigator" on your Android device.



2 Tap *Open Settings*.

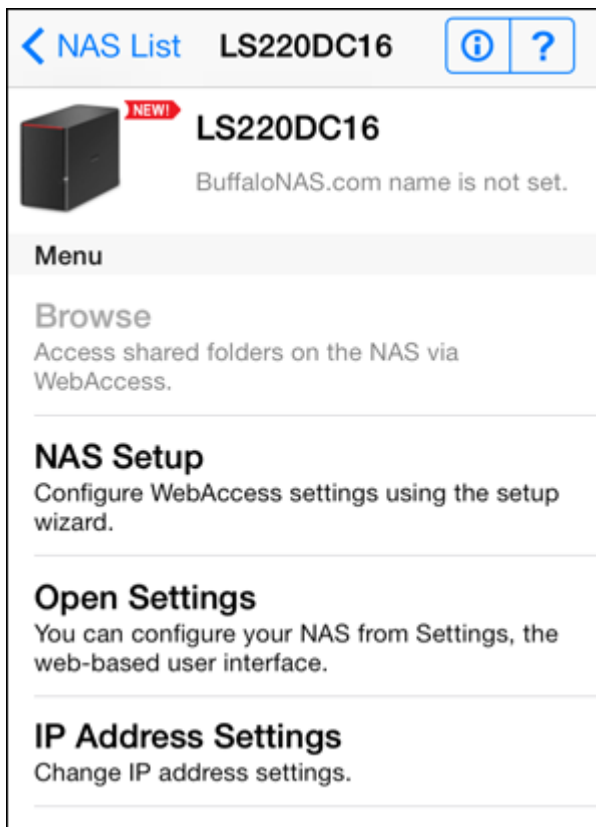

### 3 Settings will be displayed.

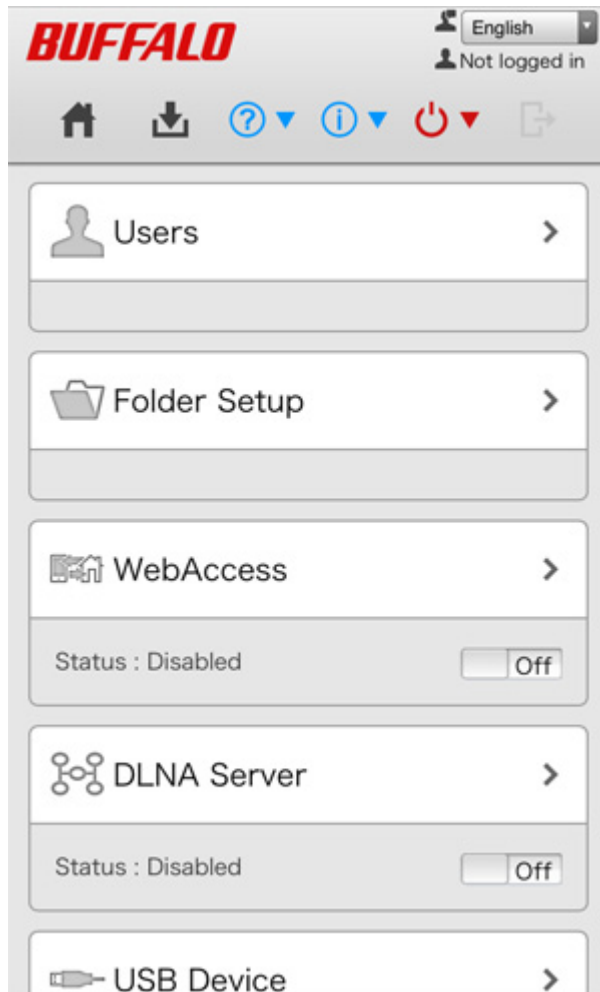

#### Notes:

- The first time you go through setup, you'll be given a chance to change the default password, correct the time zone settings, and select the RAID mode (models with 2+ drives only). Step through the wizard to change these settings.
- If you tap any buttons, you will need to enter a username and password.
- Tap *Desktop* to show Advanced Settings. This screen gives the full array of settings that could be changed from a computer, but is not optimized for mobile devices.

## Settings That Can Be Changed from Your Mobile Device

---

You can change the following settings from your mobile device:

- Create users, change usernames and passwords.
- Create shared folders.
- Configure WebAccess settings to remotely access your LinkStation.
- Configure your LinkStation to use with DLNA-compatible devices on the LAN.
- Configure and dismount USB devices connected to your NAS, including Direct Copy options and print server settings.
- Update the firmware.
- Recover the RAID array when a drive fails (models with 2+ drives only).

# Chapter 3 Sharing Files

---

## Adding Shared Folders

---

### Configuration from a Computer

---

**1** In Advanced Settings, click *File Sharing*.

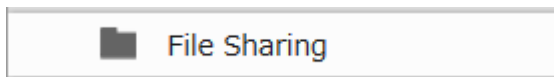

**2** Click  to the right of "Folder Setup".



**3** Click *Create Folder*.

**4** Configure the desired settings, then click *OK*.

**Shared Folder Settings**

Copy settings from:

Name \* :

Description:

Volume:

Attribute:  Read Only  Read & Write

Recycle Bin:  Enable  Disable

LAN Protocol Support:  SMB (Windows/Mac)  AFP (Mac)  
 FTP  Backup  
 DLNA  WebAccess

Folder Attributes:  Hidden Share (SMB Only)

Remote Backup Password:

WebAccess Public Mode:

Access Restrictions:  Enable  Disable

**Local Users** | Local Groups | Domain Users | Domain Groups | External Users

Filter:

Local Username	W	R	
guest	<input type="radio"/>	<input type="radio"/>	<input checked="" type="radio"/>
admin	<input type="radio"/>	<input type="radio"/>	<input checked="" type="radio"/>

\* Required

OK Cancel

**Notes:**

- Names may contain up to 27 alphanumeric characters, hyphens (-), and underscores (\_). Do not use a symbol as the first character in a name.
- The description may contain up to 75 alphanumeric characters, hyphens (-), underscores (\_), and spaces. Do not use a symbol or space as the first character.
- You may create up to 400 shared folders.
- The names of shared folders should not use characters from more than one language. For example, mixing Japanese and Korean characters in names is not supported.
- If multi-byte characters are used in shared folder names, configure the client language to match the characters in *Management - Name/Time/Language*.

## Recycle Bin

To protect your data from accidental deletion, you may configure your LinkStation to use a recycle bin instead of deleting files immediately. The recycle bin will only work with SMB connections.

## Read-only Shares

By default, new shares are set with read & write access, but you may change the attribute to "Read Only" in "Attribute". Read-only shares and HFS+ formatted USB hard drives will have "Read-only" added to the shared folder description.

## Hidden Shares

If hidden shares is enabled, shared SMB folders will not be displayed in Network, and only certain users are allowed to access them. To hide a shared SMB folder, follow the instructions below.

**1** In Advanced Settings, navigate to *File Sharing - Folder Setup* and choose a shared folder to configure hidden shares. A USB drive is not available for a hidden share.

**2** Check "Hidden Share (SMB Only)" and click *OK*.

**Note:** If protocols other than "SMB" or "Backup" under "LAN Protocol Support" are enabled, the hidden shares option will be grayed out and cannot be selected.

To access a hidden folder, open File Explorer in your computer and enter "\\LinkStation's name\Shared folder names\$" for the name. For example, if the LinkStation name is "LSXXX001" and shared folder name is "share", enter "\\LSXXX001\share\$" to open it.

## Configuration from a Mobile Device

---

1 In Settings, tap *Folder Setup*.

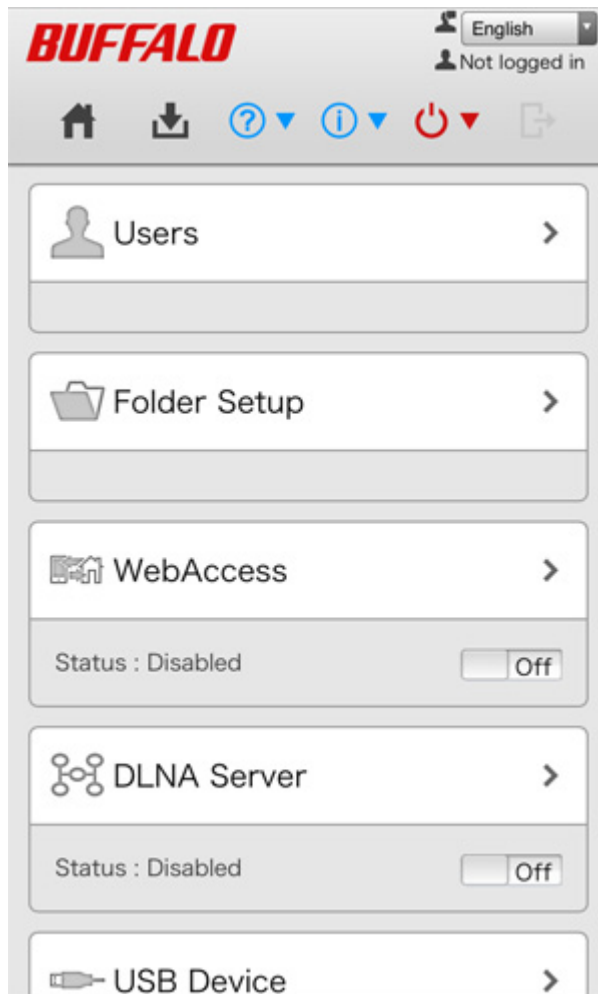



2 Tap *Create Folder*.

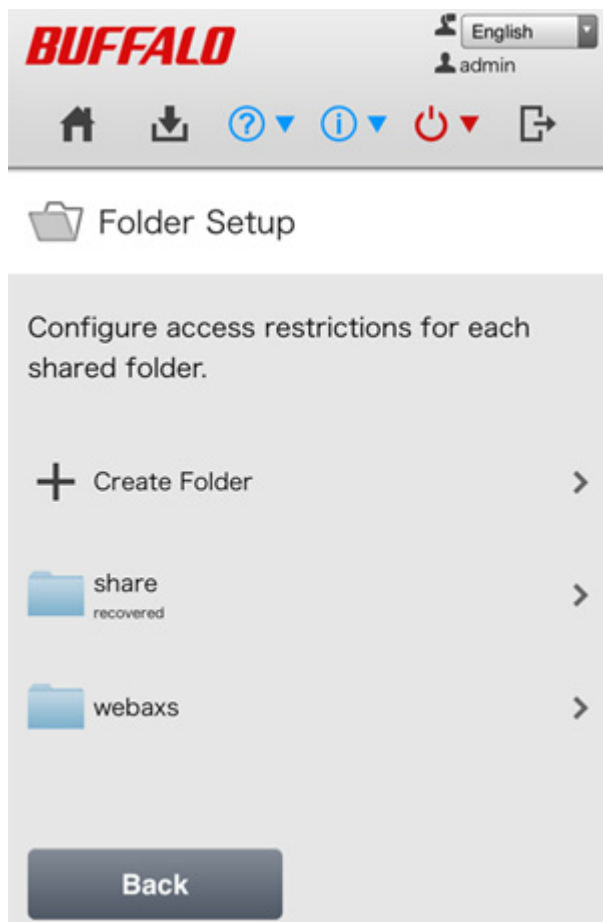

3 Enter a folder name and description and tap *Apply*.

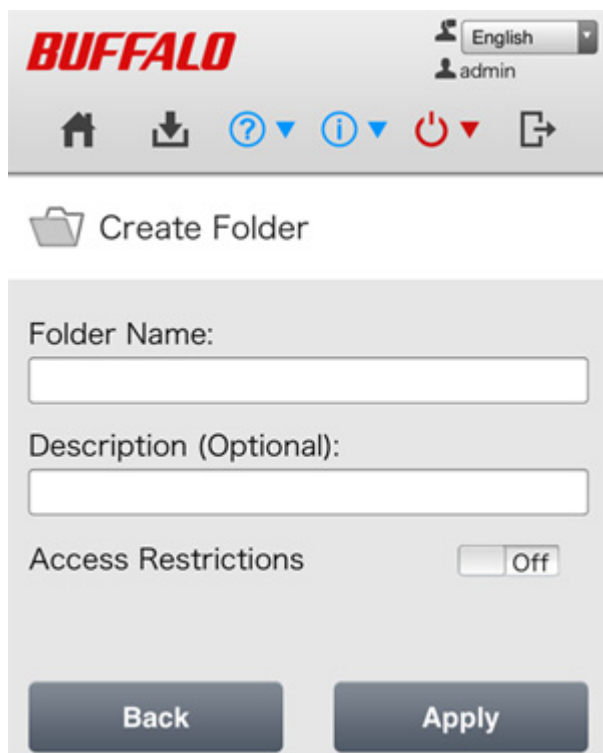

**Notes:**

- Folder names may contain up to 27 alphanumeric characters and symbols. The description may contain up to 75 alphanumeric characters.

- If you create a shared folder from a mobile device, SMB and AFP connections can be used to access this folder by default.

---

## Adding Users

---

**Note:** The LinkStation can register a maximum of 300 users, which includes the default users "admin" and "guest".

### Configuration from a Computer

---

**1** In Settings, click *File Sharing*.

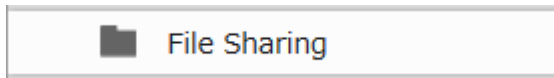

**2** Click  to the right of "Users".



**3** Click *Create User*.

**4** Enter the desired settings, then click **OK**.

**User Settings**

Username: \*  
[Text Box]

User ID:  
Enter a number from 1000 to 1999.  
[Text Box]

Email:  
[Text Box]

Password: \*  
[Text Box]

Confirm Password: \*  
[Text Box]

Description:  
[Text Area]

Quota:  
 Enable (Units: GB)  
Quota Capacity: 1 [Spin Box]  
 Disable

Filter: [Text Box]

Group

- admin
- hdusers

Select All Unselect All

Primary Group:  
hdusers [Dropdown]

\* Required

OK Cancel

**Notes:**

- Usernames may contain up to 128 characters, including hyphens (-), underscores (\_), periods (.), !, #, &, @, \$, \*, ^, and %. Do not use a symbol as the first character.
- The user ID should be a number from 1000 to 1999. Each user ID should be unique. If this field is left blank, a user ID is assigned automatically.
- When you log in to Settings as a registered user, you can see the LinkStation's name, IP address, workgroup, and disk status, and modify the password.
- Do not duplicate user IDs, group IDs, usernames, or group names. Each should be distinct and unique.
- The description may contain up to 75 alphanumeric characters, hyphens (-), underscores (\_), and spaces. Do not use a symbol or space as the first character.
- Passwords may contain up to 20 alphanumeric characters and the following characters: - \_ @ ! # \$ % & ' ( ) \* + , . / ; < > = ? " [ ] ^ { } | ~. Do not use a symbol other than an underscore (\_) as the first character.
- Use the same username and password for both Windows and the LinkStation or you may not be able to access shared folders.
- If a user belongs to multiple groups, the most strict access restrictions will apply. For example, if a user is added to a group with read and write access, and also to a read-only group, the user will effectively have read-only access.

## Configuration from a Mobile Device

---

1 In Settings, tap *Users*.

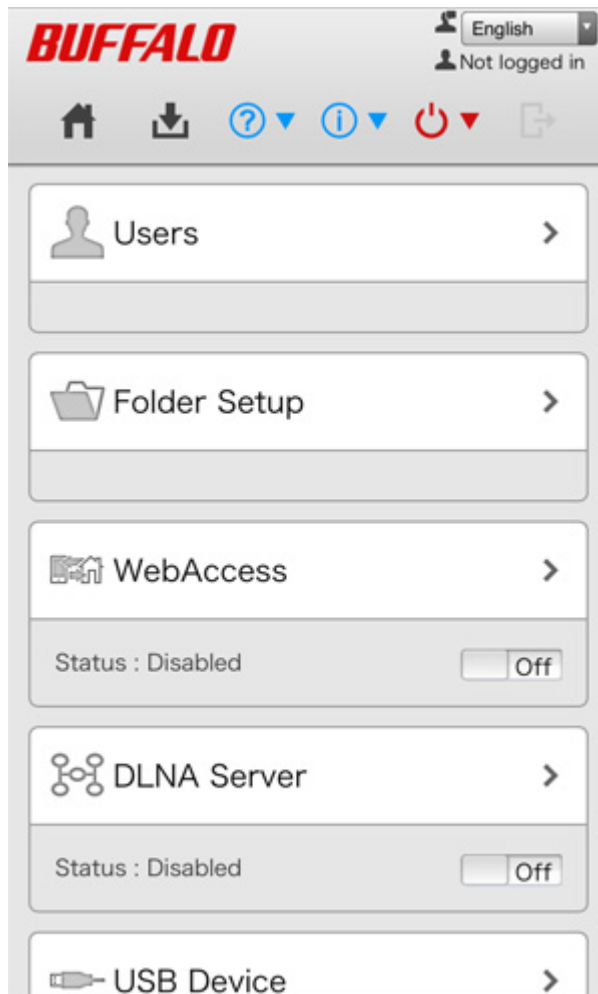

## 2 Tap *Create User*.

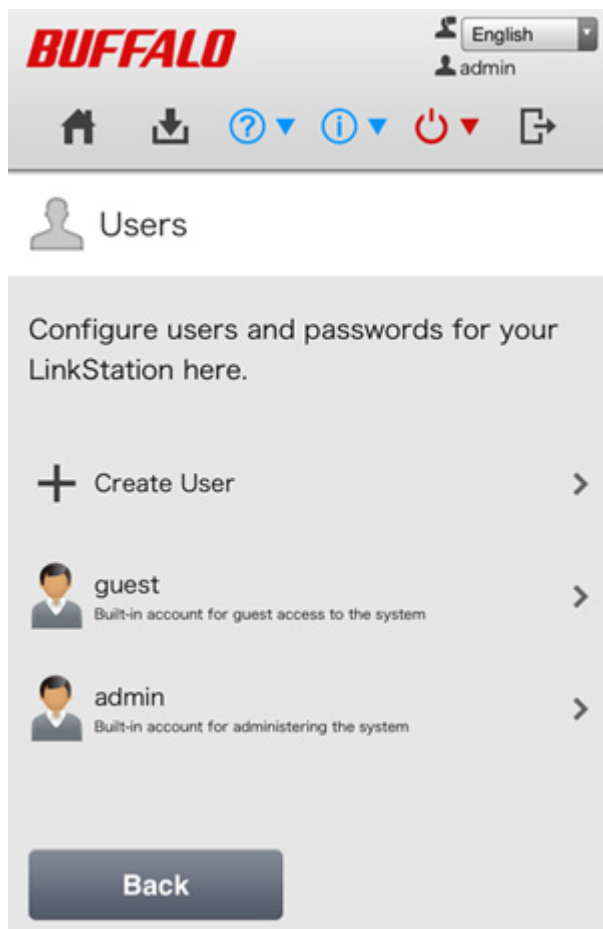

**3** Enter the desired username, password, and description, and tap *Apply*.



**Create User**

Using the same username and password that you use to log in to Windows is recommended.

Username:

Create a folder for this use

Password:

Password (Confirm):

Description (Optional):

**Back** **Apply**

**Note:** Usernames may contain up to 128 alphanumeric characters and symbols. Passwords may contain up to 20 alphanumeric characters and symbols.

---

## Adding Groups

---

**1** In Settings, click *File Sharing*.

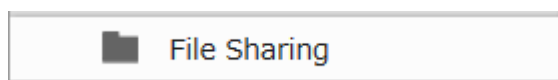

**2** Click  to the right of "Groups".



**3** Click *Add Group*.

**4** Enter the desired settings, then click *OK*.

**Group Settings**

Group Name: \*  
[Text Box]

Group ID:  
(\*Enter a number from 1000 to 1999.)  
[Text Box]

Group Privileges:  
General Users [Dropdown]

Select a recipient for group notifications:

User (with email address configured)  
Disabled [Dropdown]

Email address  
[Text Box]

Description:  
[Text Area]

Quota:

Enable(Units: GB)  
Quota Capacity: 1 [Spinner]

Disable

Filter: [Text Box] [X]

Username

<input type="checkbox"/>	admin
<input type="checkbox"/>	test

Select All Unselect All

\* Required

OK Cancel

**Notes:**

- Group names may contain up to 20 alphanumeric characters, hyphens (-), underscores (\_), and periods (.). Do not use a symbol other than an underscore (\_) as the first character.
- Group descriptions may contain up to 75 alphanumeric characters, hyphens (-), underscores (\_), and spaces. Do not use a symbol or space as the first character.
- If the group ID field is left blank, a group ID is automatically assigned. Use numbers between 1000 and 1999 to set a group ID manually. Don't use duplicate group IDs.
- You may register up to 300 groups with the LinkStation.
- If you are logged in as a member of the general users group, you can only change your own password. If you're logged in as an administrator, you can change any settings, including other users' passwords. If you are logged in as a member of the power users group, you can create and edit shared folders, users, and groups.

---

## Access Restrictions

---

You may restrict access to specific shared folders, including external USB drives.

**Notes:**

- Access restrictions can be set separately for each shared folder, but not for subfolders within the shared folders.
- Configure access restrictions through Settings. Configuring access restrictions through Windows is not supported and may cause unexpected behavior.

## Local Users/Groups

---

**1** In Settings, click *File Sharing*.

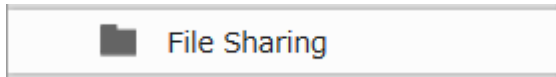

**2** Click  to the right of "Folder Setup".



**3** Click the shared folder that you want to set access restrictions for.

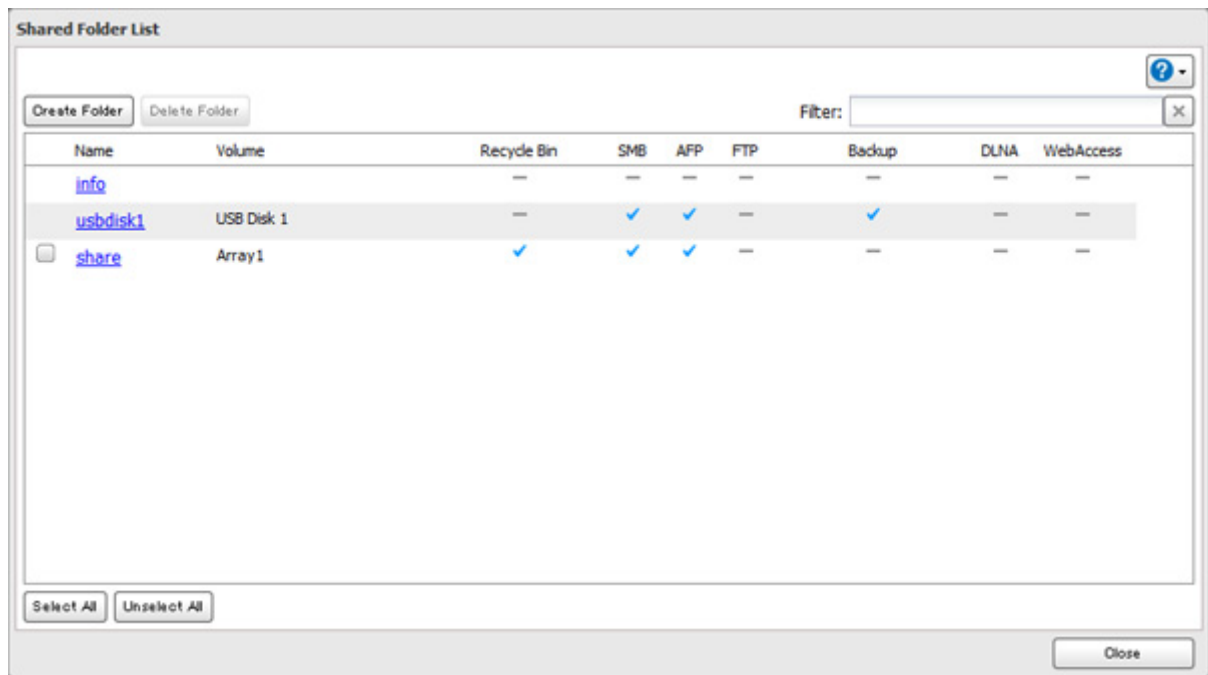

**4** Click *Edit*.

**5** Enable "Access Restrictions".



**6** Select the level of access for the user or group you added.



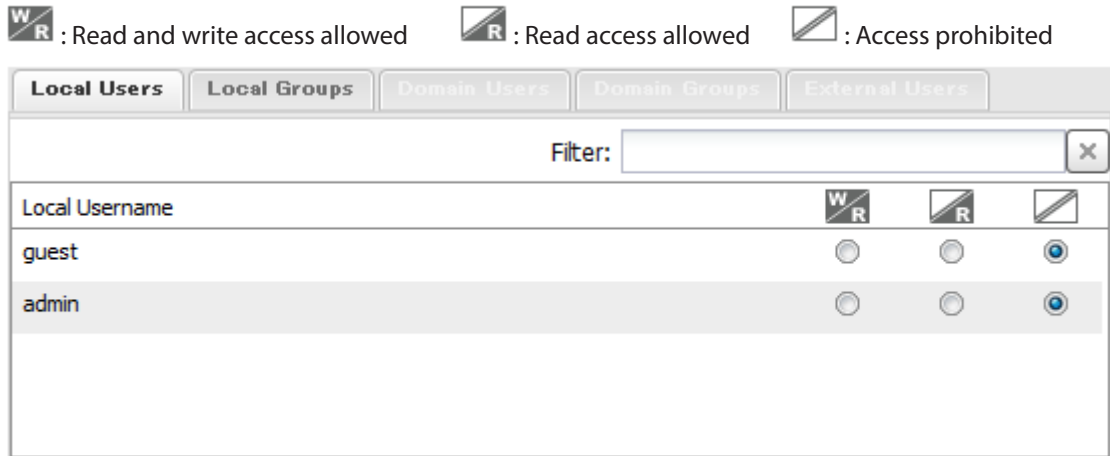

**Notes:**

- An example of access restrictions by user is shown in the screen. To apply access restrictions by group, click the *Local Groups* tab and select group permissions.
- If both read-only and read & write permissions are given to a user, the user will have read-only access.

**7** Click *OK*.

**Notes**

- The following characters are handled differently by macOS and Windows. Avoid using these characters when sharing data between macOS and Windows:  
 ~ \| - @ £ ~
- Windows does not support some characters that macOS and the LinkStation allow. If you create a filename on a Mac with any of the following characters, it will not display correctly on a Windows computer and you may have to connect to the LinkStation via AFP in order to display or copy any of the following characters on a Mac computer.  
 ? [ ] / \ = + < > ; : " , | \*
- Do not use any of the following words as a username or group name: root, bin, daemon, sys, adm, tty, disk, lp, sync, shutdown, halt, operator, nobody, mail, news, uucp, ftp, kmem, utmp, shadow, users, nogroup, all, none, hdusers, admin, guest, man, www, sshd, administrator, ftpuser, apache, mysql
- Do not use any of the following words as the name of a shared folder. These words are reserved for internal use by the LinkStation: info, spool, lost+found, global, printers, homes, lp, authtest, ram, msdfs\_root, mt-daapd, usbdisk# (where # is a number, for example: usbdisk1)



2 Click  to the right of "Workgroup/Domain".



3 Click *Edit*.

4 Select "Active Directory" and click Next.

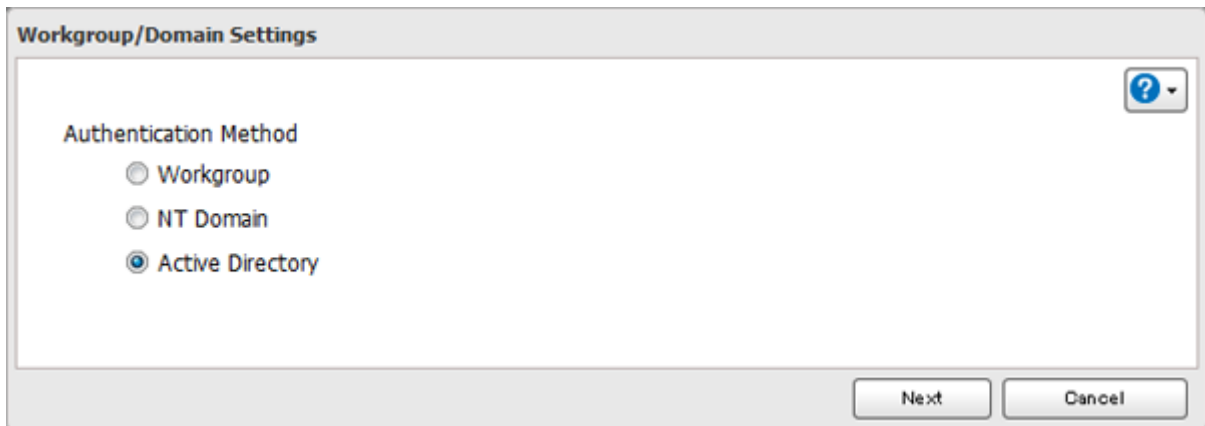

5 Click Yes.

6 Enter the desired settings, then click *OK*.

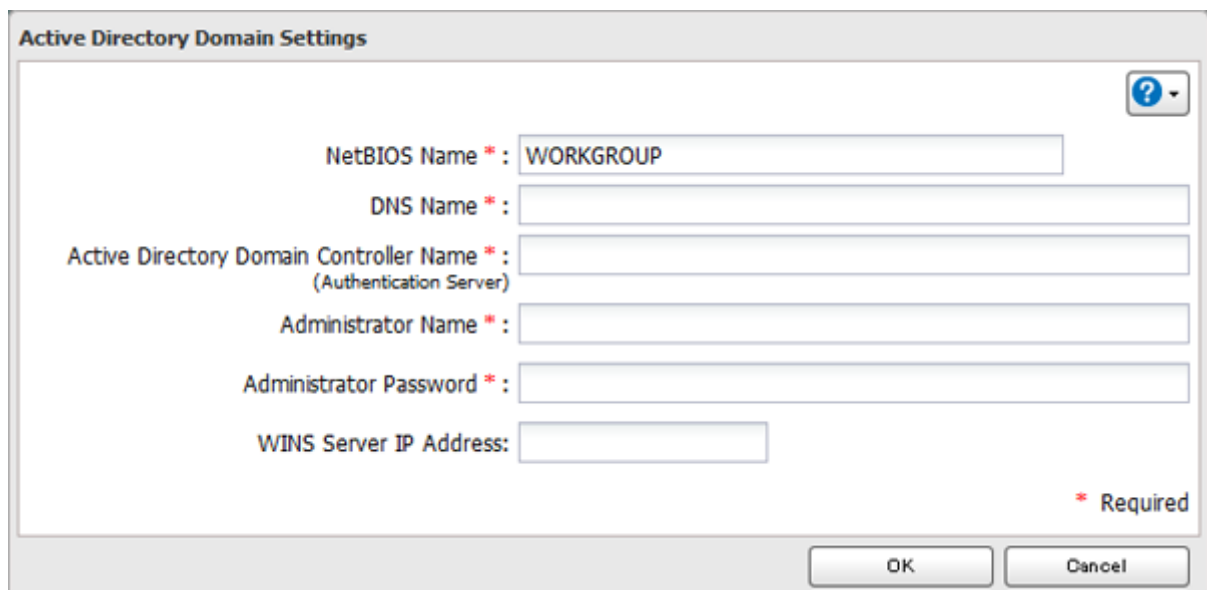

7 In Advanced Settings, navigate to *File Sharing - Folder Setup*.



**8** Click a shared folder that you want to set access restrictions for.

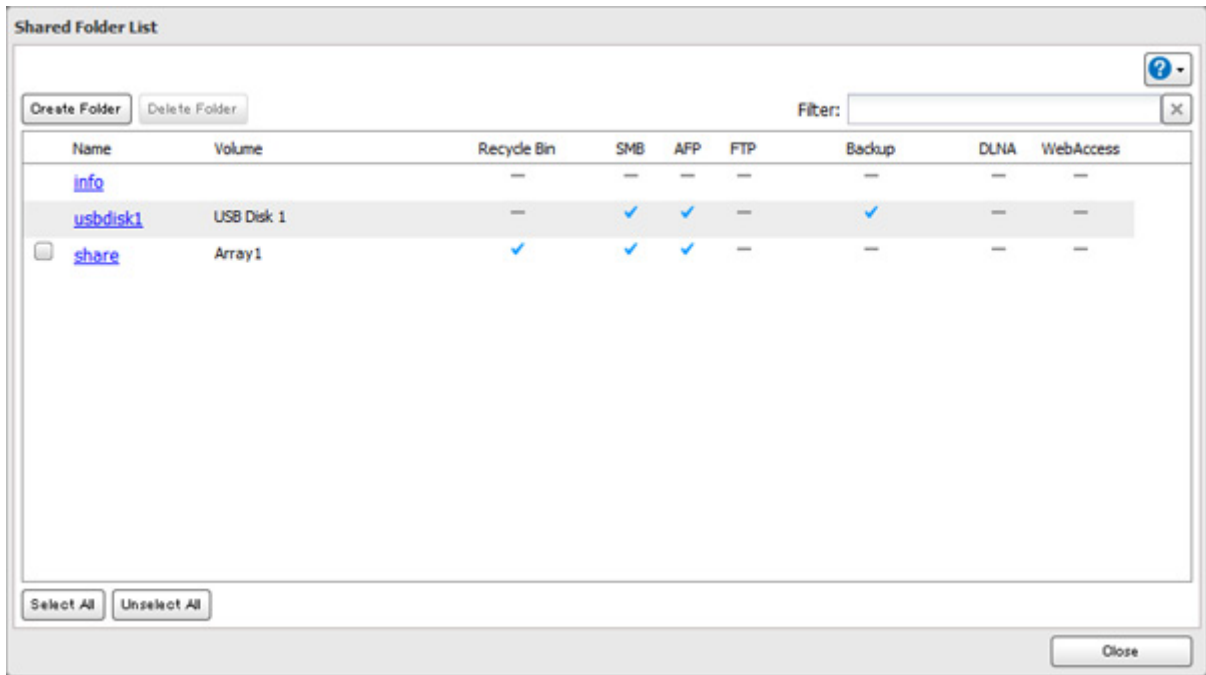



**9** Click *Edit*.

**10** Enable "Access Restrictions".

Access Restrictions:  Enable  Disable

**11** Select the level of access for the user or group:

 : Read and write access allowed  : Read access allowed  : Access prohibited

**12** Click *OK*.

**Notes:**

- If you change the LinkStation's name, you will no longer be able to use domain users and groups or access restrictions. To repair this, rejoin the domain.
- To have the LinkStation join an Active Directory domain, configure it to use a DNS server that can resolve names for the Active Directory domain.
- After building an Active Directory domain, the administrator password for joining the domain must be changed at least once, or joining the Active Directory domain will fail.
- The DNS name and NetBIOS name of Active Directory domains should be identical.
- If both read-only and read & write permissions are given, the user will have read-only access. The most restrictive access setting will apply.
- If there are more than 5 minutes difference between the LinkStation's clock and the domain controller's clock, joining the domain or authenticating domain users and groups may fail. For best results, use an NTP server to set the time for all network devices.
- To use the LinkStation as a member server in an Active Directory domain, the LinkStation should be logged in to the domain and accessed from a computer that is not a member of the domain with a valid domain account.
- If the LinkStation is a member server of an Active Directory domain, you cannot connect as a guest user via AFP.
- If your LinkStation is a member server in an Active Directory domain and you change the authentication method to "Workgroup", the account on the domain controller will not be deleted automatically.

- When the LinkStation joins an Active Directory domain, FTP is disabled. Before using FTP, move the FTP switch back to the  position.
- Don't disable the SMB protocol while Active Directory is used for access restrictions. If you do, you will need to enable SMB again and reconfigure AD from scratch.

## NT Domain

In an NT domain environment, the LinkStation uses account information from the NT domain server to set access restrictions for files and folders on the LinkStation. There's no need to perform individual account management for the LinkStation. If multiple LinkStations are installed on the network, the account information is centrally managed in the NT domain, greatly reducing the operations required for installation and management.

**Note:** The LinkStation supports a domain environment with a maximum of 1000 domain users and 1000 groups. 10,000 users and 10,000 groups can be downloaded from the domain controller but are not supported.

**1** Create an account on the domain controller for the LinkStation.

**2** In Advanced Settings, click *Network*.



**3** Click  to the right of "Workgroup/Domain".



**4** Click *Edit*.

**5** Select "NT Domain", then click *Next*.

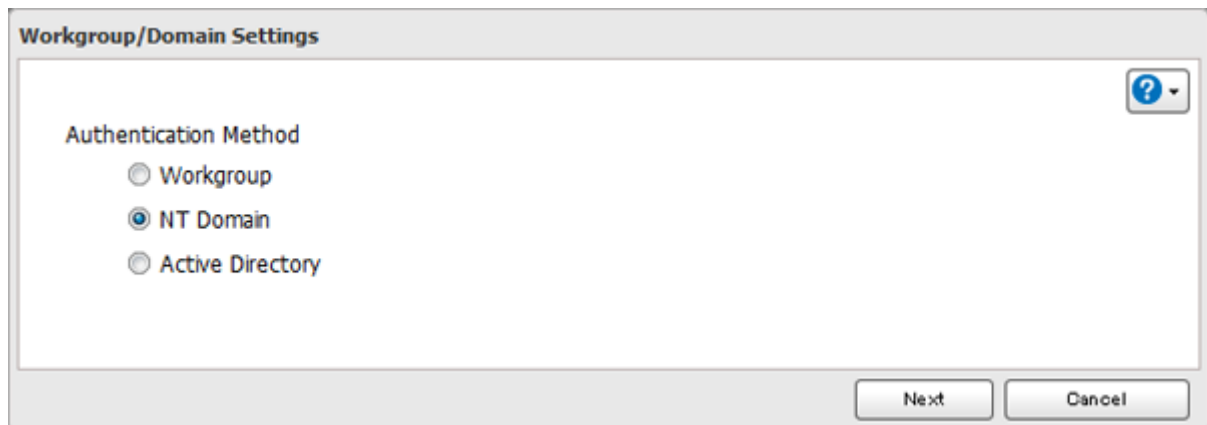

**6** Click *Yes*.

**7** Enter the desired settings, then click *OK*.

**NT Domain Settings**

NT Domain Name \* : WORKGROUP  
(NetBIOS Name)

NT Domain Controller Name \* :  
(Computer Name)

Administrator Name \* :  
Administrator Password \* :  
WINS Server IP Address:

\* Required

OK Cancel

**8** In Advanced Settings, navigate to *File Sharing - Folder Setup*.

Folder Setup 2 Folder(s)

**9** Click a shared folder for which you want to set access restrictions.

**Shared Folder List**

Create Folder Delete Folder Filter: [ ]

Name	Volume	Recycle Bin	SMB	AFP	FTP	Backup	DLNA	WebAccess
<a href="#">info</a>		-	-	-	-	-	-	-
<a href="#">usbdisk1</a>	USB Disk 1	-	✓	✓	-	✓	-	-
<input type="checkbox"/> <a href="#">share</a>	Array 1	✓	✓	✓	-	-	-	-

Select All Unselect All Close

**10** Click *Edit*.

**11** Enable "Access Restrictions".

Access Restrictions:  Enable  Disable

**12** Select the level of access for "Domain Users" or "Domain Groups" you added.

: Read and write access allowed : Read access allowed : Access prohibited

## 13 Click *OK*.

### Notes:

- If you change the LinkStation's name, you will no longer be able to use domain users and groups or access restrictions. To repair this, rejoin the domain.
- If both read-only and read & write permissions are given to a user, the user will have read-only access. The most restrictive attribute will apply.
- If a domain username is more than 20 bytes long, the LinkStation truncates it to 20 bytes.
- The LinkStation supports a domain environment with a maximum of 1000 users and 1000 groups. 10,000 users and 10,000 groups can be downloaded from the domain controller but are not supported.
- To use the LinkStation as a member server in an NT domain, the LinkStation should be logged in to the domain and accessed from a computer that is not a member of the domain with a valid domain account.
- If the LinkStation is a member server of an NT domain, you cannot connect as a guest user via AFP.
- When you change the user or group settings on the domain controller, these changes may not take effect immediately on the LinkStation until it is rebooted.
- If your LinkStation is a member server in an NT domain and you change the authentication method to "Workgroup", the account on the domain controller will not be deleted automatically.
- If the LinkStation has joined a domain network, you cannot connect to it via FTP.
- Don't disable the SMB protocol while an NT domain server is used for access restrictions. If you do, you will need to enable SMB again and reconfigure the NT domain settings from scratch.

## User Authentication with an External SMB Server

---

LinkStations on your network can be linked to an authentication server for centralized management of user accounts and passwords. The authentication server should be another TeraStation or LinkStation. Other external SMB authentication servers are not supported.

### Notes:

- Disable SMB2 before using external authentication.
- Access restrictions for local users and groups will still apply to shared folders if an external SMB server is used for authentication.
- The procedure below contains methods to automatically register external users. You can also manually add external users by converting them from local users. Refer to the "Converting Local Users into External Users" section above for more details on converting local users.

1 In Advanced Settings, click *Network*.



2 Click  to the right of "Workgroup/Domain".



3 Click *Edit*.

4 Select "Workgroup" and click *Next*.

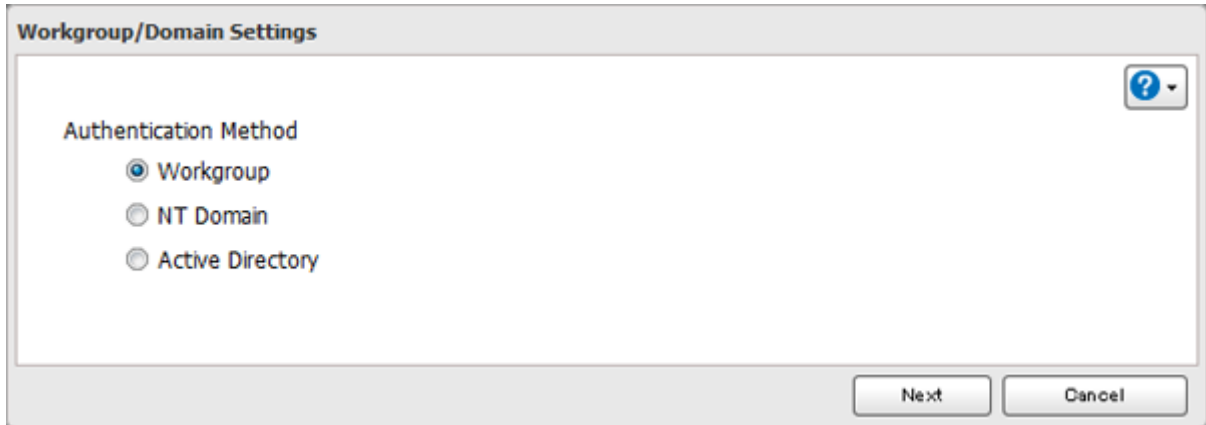

5 If a prompt appears, click *Yes*.

6 Enter a workgroup name. Select "Authenticate local and external SMB server users" and enter the SMB server's IP address. You can also specify a server from another subnet.

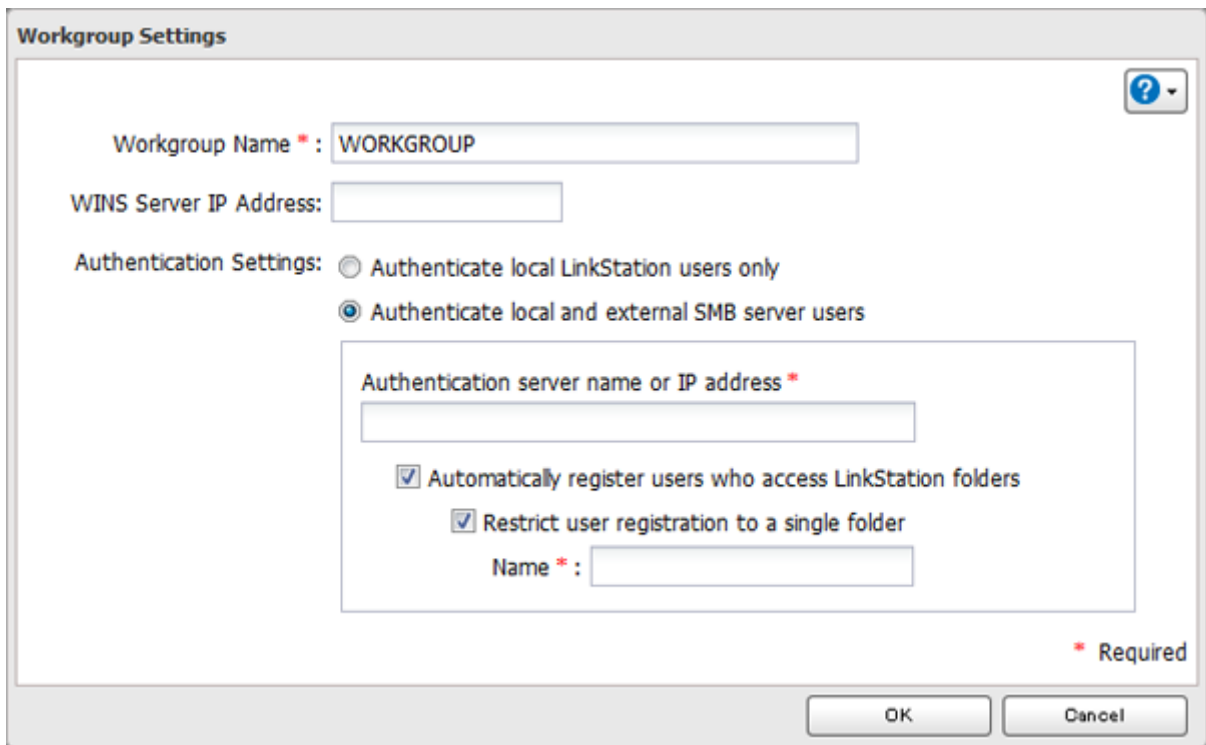

7 If "Automatically register users who access LinkStation folders" is checked, users that access any of the LinkStation's folders will be automatically registered as external users. This process only applies with folders that have access restrictions disabled. After new external users are added, disable this option to limit the number of authenticated user accounts.

8 If "Restrict user registration to a single folder" is checked, the LinkStation will automatically create a read-only shared folder. Enter the shared folder name. Users that access this specific folder will be automatically registered as external users. If this setting is de-selected at a later time, the LinkStation will automatically remove the folder.

**Note:** Connect to the authentication folder via SMB, not FTP or AFP. Automatic user registration may not work with OS X 10.8 (or later) the first time. If this occurs, try rebooting the LinkStation then access the authentication shared folder again.



9 Click *OK* to save any changes. When saving changes to the external authentication server settings, you may not to convert all current local users to external users. If a local user is converted to an external user, their user information (including passwords) will be removed from the NAS. External users cannot be reverted to local users.

10 Click  to the right of "Folder Setup".



11 Click a shared folder to set access restrictions on.

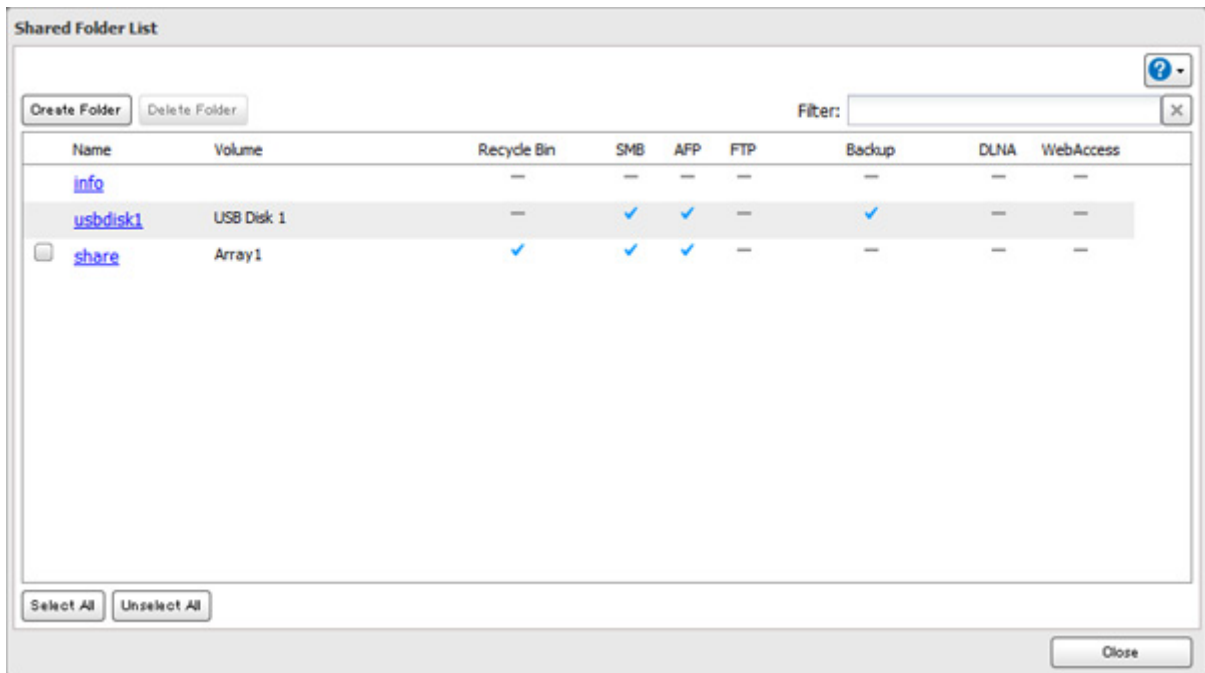

12 Click *Edit*.

13 Enable "Access Restrictions".



14 Click on the *External Users* tab and select the level of access for each external user.

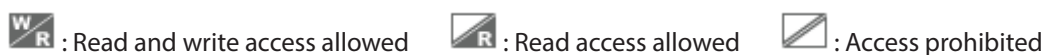

15 Click *OK*.

**Notes:**

- Users that are automatically registered belong to the "hdusers" group. They can be added to other groups from within groups settings. Added users will be listed in "Users" - "External Users". To delete a user that was registered automatically, select that user and click *Delete External User*.
- If both read-only and read & write permissions are given to a user, the user will have read-only access. The most restrictive attribute will apply.
- To access access-limited shared folders from OS X 10.7, use AFP instead of SMB, under "LAN Protocol Support", check "AFP (Mac)" on the destination folders to use AFP.
- If access restrictions are set for users and groups from the authentication server, guest and anonymous connections will not be possible with AFP connections.
- FTP connections do not support authentication with an external SMB server.

- If using a Windows PC for external authentication, the default Windows SMB security settings may need to be changed. An easy way to do this is to run the File Sharing Security Level Change Tool, available from this product's download page on the Buffalo website. This utility will let you easily change or restore your Windows security settings to work with external authentication.

## Converting Local Users into External Users

If using an external SMB server for authentication, you may convert any local users into external users. This way, the LinkStation will have a user list that matches the users in the external SMB server, and access restrictions for this LinkStation's shared folders may be assigned to the converted "external" users.

Follow the steps below to convert a local user into an external user. If a local user is converted, their user information (including passwords) will be removed from the LinkStation. External users cannot be reverted to local users.

**Note:** External authentication should be enabled before local users can be converted. For more information on external authentication, refer to the "User Authentication with an External SMB Server" section.

**1** In Advanced Settings, click *File Sharing*.

**2** Click  to the right of "Users".

**3** In the user list screen, check any users to be converted to an external user, then click *Convert to External User*.

**4** Click *OK*.

**5** Enter the confirmation number and click *OK*.

Converted users are displayed under the "External Users" tab. You can then configure access restrictions for external users.

# Chapter 4 Managing Storage

---

## RAID Arrays

---

The default RAID mode is RAID 1.

### Notes:

- If you change the RAID mode, all data on the array is deleted. This is true for every procedure in this chapter. Always back up any important data before performing actions that affect your RAID array.
- After the RAID mode is changed (except when creating a RAID 0 array or JBOD), the LinkStation performs a RAID check that will take about 10 hours per TB. File transfers are slower during this period. While the I17 message is displayed in NAS Navigator2, do not turn off the LinkStation. If you do, the RAID check will start over.

### RAID 1

Combines 2 drives into a mirrored array. The available space in the array is the capacity of a single drive. Identical data is written to each drive. If a drive is damaged, data can be recovered by replacing the damaged drive. As long as one drive in the array remains undamaged, all data in the array can be recovered.

### RAID 0

Combines 2 or more hard drives into a single array. The usable disk space is the total space of all drives used. This simple RAID mode offers faster performance than RAID modes that include parity. If a single drive in the array fails, then all data in the array is lost.

### JBOD

This mode uses the hard drives inside the LinkStation as individual drives. The disk space you can use is the total capacity of all drives in the LinkStation. If any drive is damaged, then the data on that drive is lost.

---

## Working with RAID Arrays

---

To change RAID settings, navigate to *Drives - RAID* in Advanced Settings.

### Using JBOD

---

With JBOD, each hard drive in the LinkStation is addressed separately. To put drives from an array into JBOD mode, follow the steps below.

- 1** In Advanced Settings, click *Drives*.

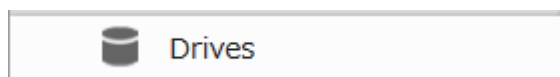

2 Click  to the right of "RAID".



3 Click the array to delete.

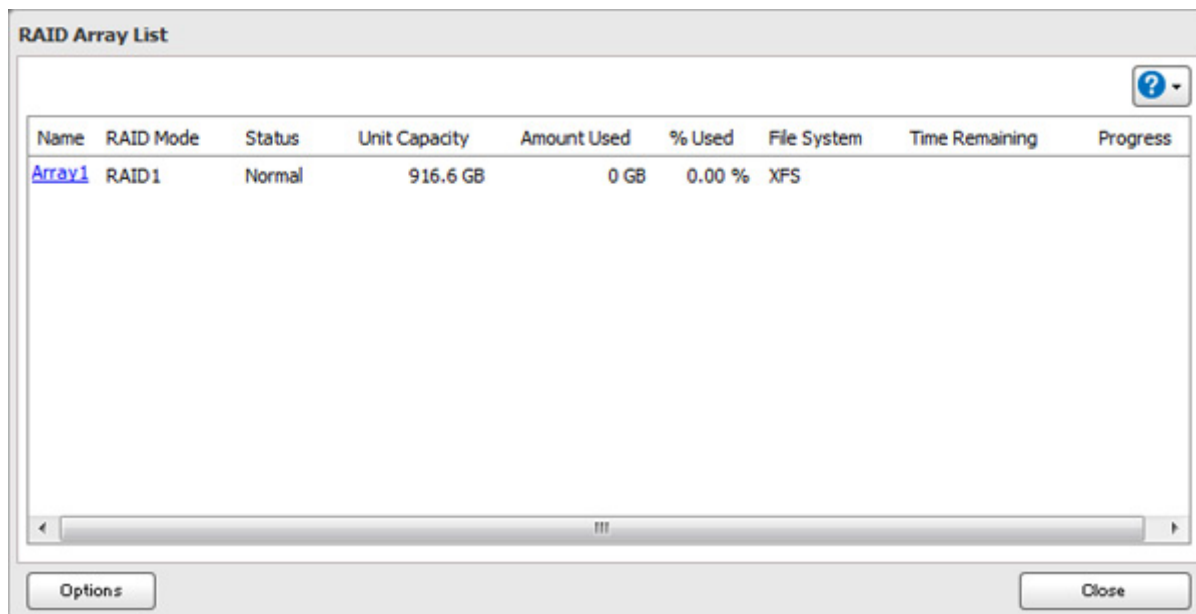

4 Click *Delete RAID Array*.

5 The "Confirm Operation" screen will open. Enter the confirmation number, then click *OK*.

Once JBOD is configured, create shared folders on each drive to use them.

## Changing RAID Mode

---

To change the RAID mode, first put the drives in JBOD.

1 In Advanced Settings, click *Drives*.

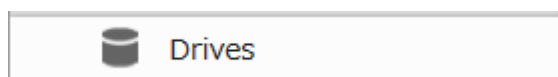

2 Click  to the right of "RAID".



**3** Click the array to delete. If the "RAID Mode" is blank, the array is already in JBOD. Proceed to step 7.

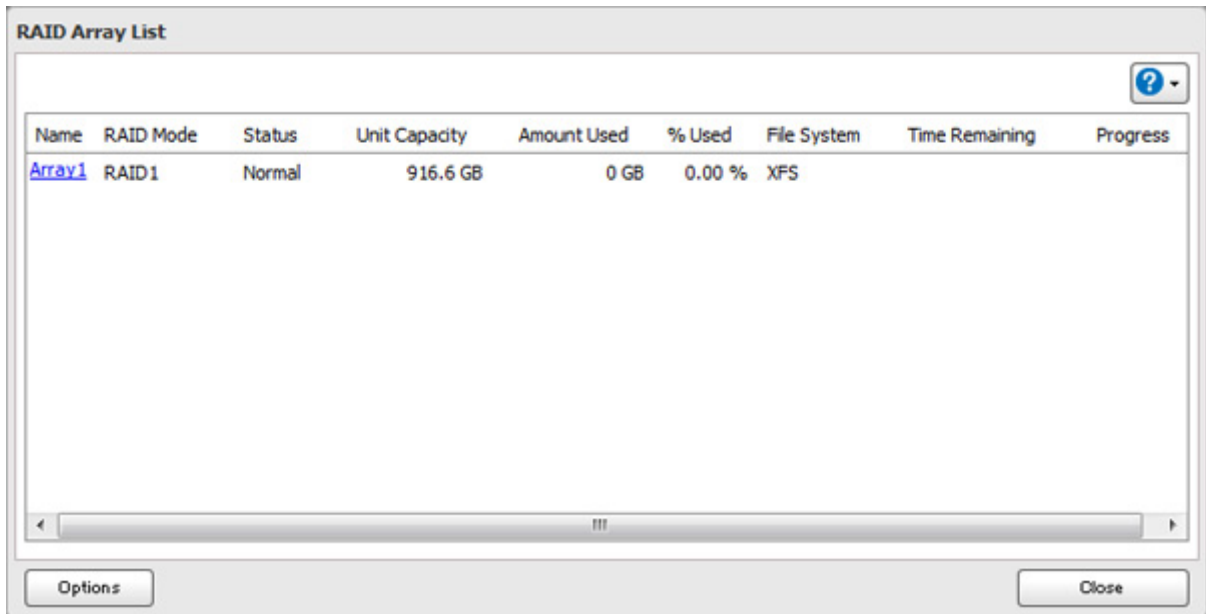

**4** Click *Delete RAID Array*.

**5** The "Confirm Operation" screen will open. Enter the confirmation number, then click *OK*.

**6** Click *OK*.

**7** Choose a RAID array.

**8** Select a RAID mode and the drives to be used, then click *Create RAID Array*.

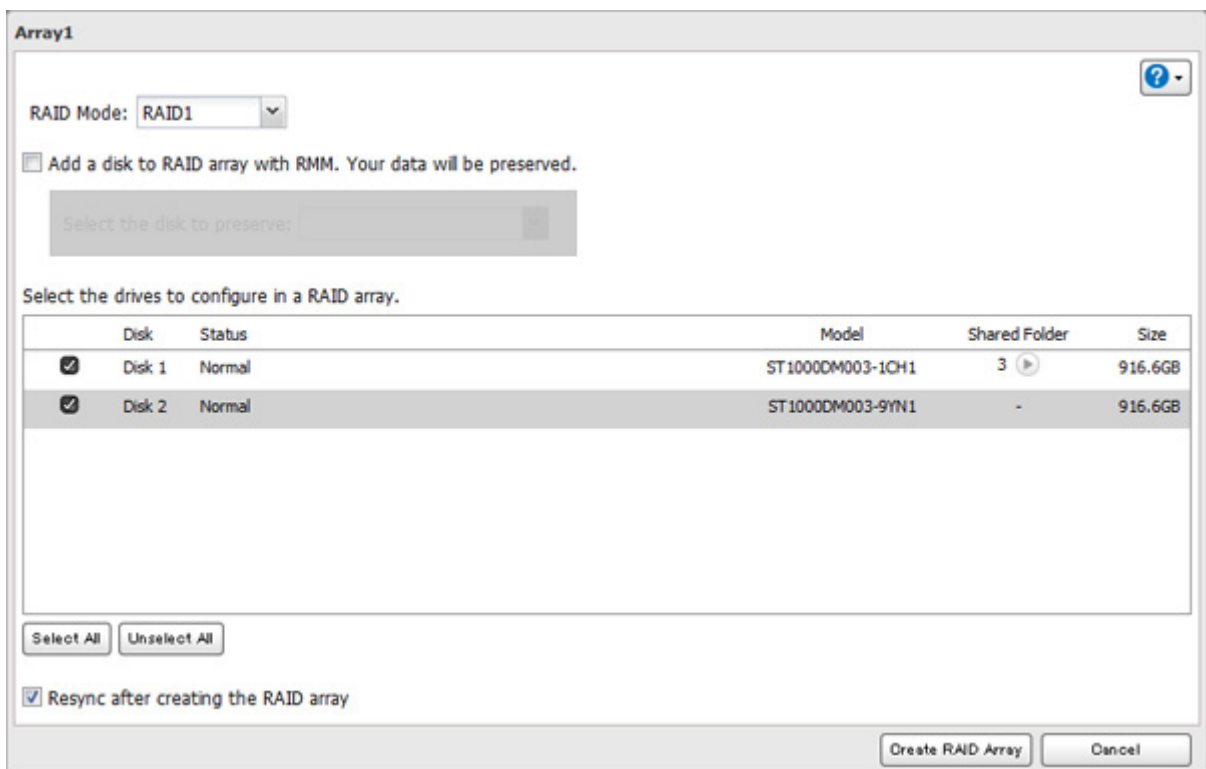

**Note:** Normally, after a RAID array is created, it is "resynced", which optimizes the array, making it more stable. The resyncing process takes about 1 hour per terabyte of space in the array. File transfers will be slower during

this period, but the array will remain fully usable. "RAID Array x Resyncing" will be shown in NAS Navigator2 during the resync. If you uncheck "Resync after creating the RAID array", the resync will be skipped. If the LinkStation is rebooted during the resyncing process, the resync will begin again from the beginning.

**9** Step through the wizard to create the array.

After changing the RAID mode, create a shared folder.

## RMM (RAID Mode Manager)

---

With RMM, you can create or expand a RAID array without erasing the data on the drives.

Hard drives that aren't in a RAID array show "Normal". You must have at least two drives available in JBOD (not in a RAID array) to build the RAID 1 array with RMM.

**1** In Advanced Settings, click *Drives*.

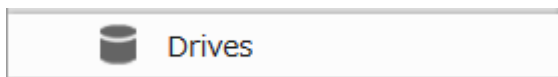

**2** Click  to the right of "RAID".



**3** Choose a RAID array.

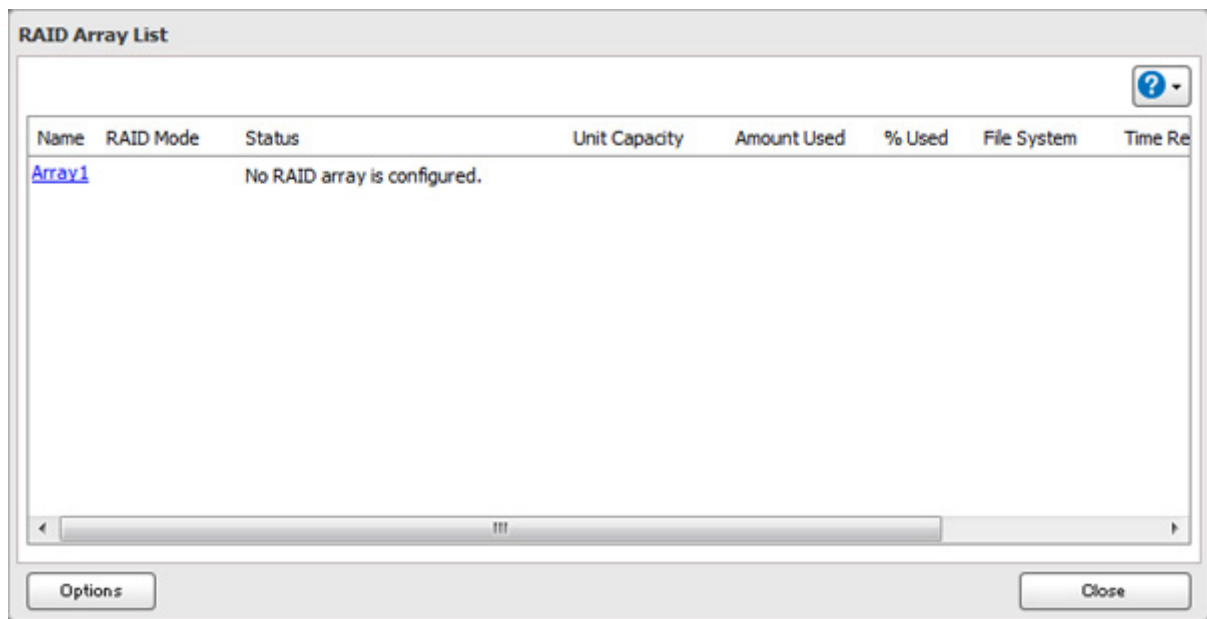

**4** Set the RAID mode to "RAID 1".

**5** Check "Add a disk to RAID array with RMM. Your data will be preserved."

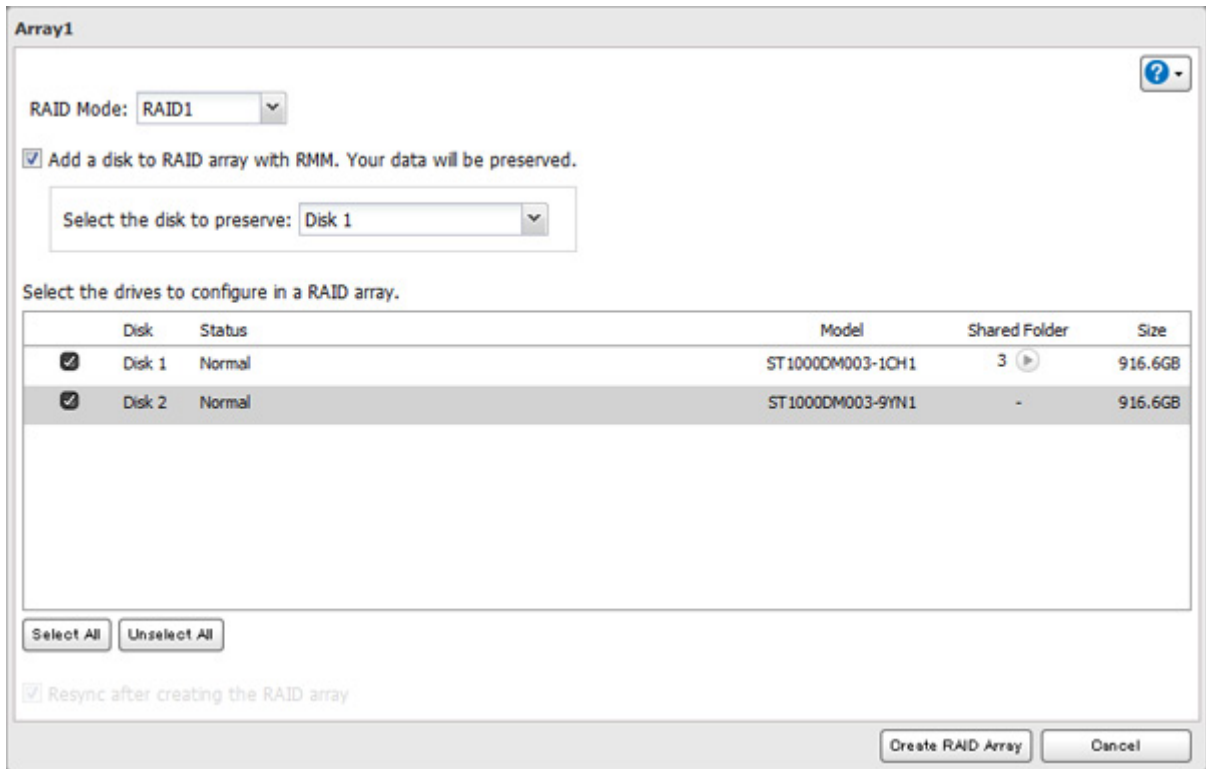

**6** Select the drive whose data will be saved from the drop-down menu.

**7** Select the drive to add to the RAID array.

**8** Click *Create RAID Array*.

**9** The "Confirm Operation" screen will open. Enter the confirmation number, then click *OK*.

## RAID Scanning

A RAID scan checks your RAID array for bad sectors and if it finds any it automatically repairs them. RAID 1 arrays are supported. For best result, run RAID scans regularly.

**1** In Advanced Settings, click *Drives*.

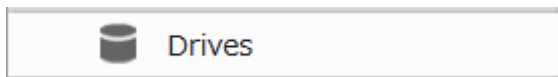

**2** Move the RAID scanning switch to the **On** position to enable RAID scanning.



**3** Click  to the right of "RAID Scanning".

**4** Click *Edit*.

- 5 Select the schedule for running RAID maintenance, then click *OK*.

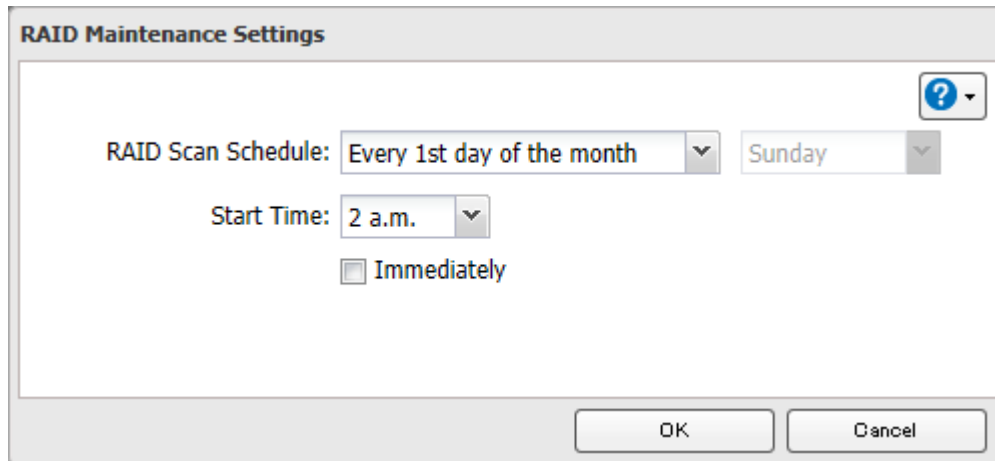

**Notes:**

- Check "Immediately" to run a RAID scan immediately.
- To stop a RAID scan, click *Cancel RAID Scan*.

---

## Adding an External Hard Drive

---

### Connecting an External Drive

---

Your LinkStation includes a USB port and you can connect an external drive to this port. It will appear as a shared folder on the LinkStation. Formatted drives are detected automatically. Unformatted drives should be formatted in Settings.

After a USB drive is recognized, Windows adds "usbdisk X" under the LinkStation in "Network", where "X" is the USB port where the hard drive is connected.

**Notes:**

- Hubs are not supported. Connect a single USB drive to the USB port.
- Backup data from macOS may include characters that cannot be written to FAT16 or FAT32 drives such as ".DS\_Store". For best results, reformat the drive before using it as a backup target.

### Compatibility

---

The following devices are supported by the LinkStation:

- USB storage devices
- Card readers (except for card readers that can recognize two or more memory cards)

Buffalo external USB drives are recommended but DUB and DIU series drives are not supported.

Supported file systems for external drives are below:

- FAT32
- Ext3
- XFS
- NTFS
- HFS Plus (read-only)

Connect only one device to a USB port of the LinkStation. Some external drives with automatic power-on don't turn on automatically when connected to the LinkStation. Use their manual switch to turn them on. Be sure to connect only one bus-powered drive at a time. If there is insufficient bus power for your USB drive, connect its AC adapter. Note that only the first partition of a connected USB hard drive is mounted. Additional partitions are not recognized.



---

# Dismounting Drives

---

If the LinkStation is powered on, dismount external drives before unplugging them. You may dismount external drives with the function button, or any drives from Settings. If the LinkStation is off, then all drives are already dismounted and may be unplugged safely.

**Note:** If you unplug your external drives without dismounting them, Settings may still show "usbdisk" in *File Sharing - Folder Setup*. Reboot your LinkStation to clear it.

## Dismounting with the Function Button

---

If the LinkStation is on, hold down the function button for 3 seconds. The white function LED will go out as all attached USB drives are dismounted. You may now unplug them safely.

## Dismounting from Settings on a Computer

---

**1** In Advanced Settings, click *Drives*.

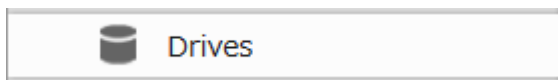

**2** Click  to the right of "USB Drives".



**3** Select the drive to dismount and click *Dismount Disk*.

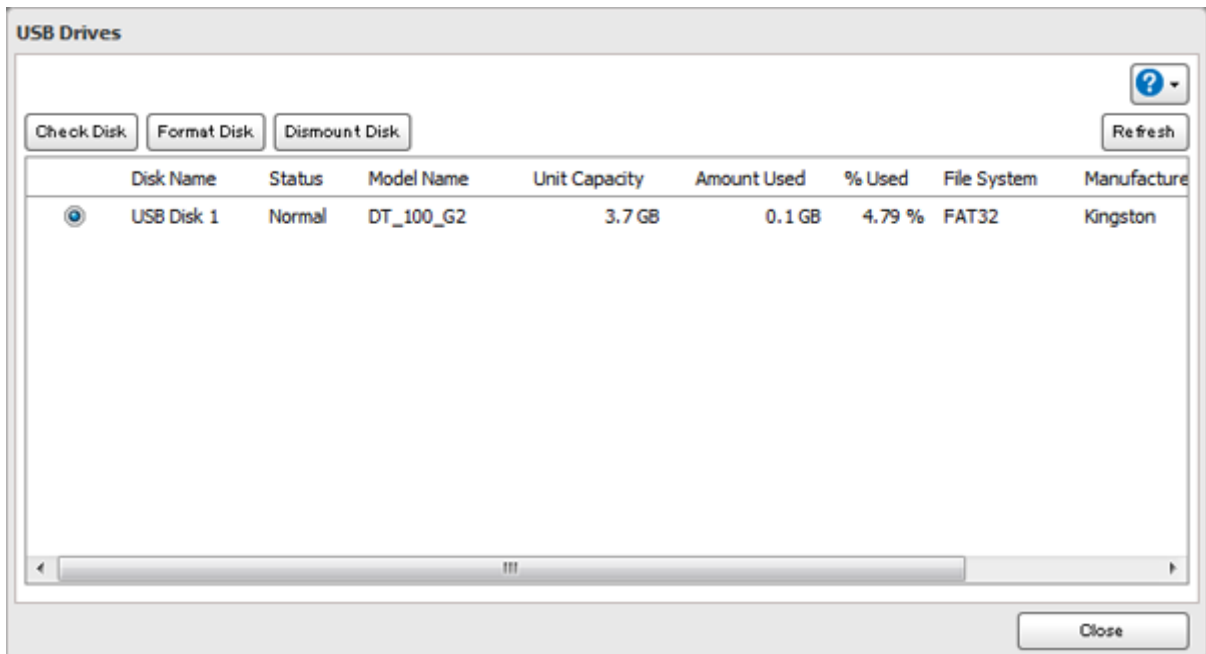

**4** The "Confirm Operation" screen will open. Enter the confirmation number and click *OK*.

**5** When the following message is displayed, it is safe to unplug the drive.

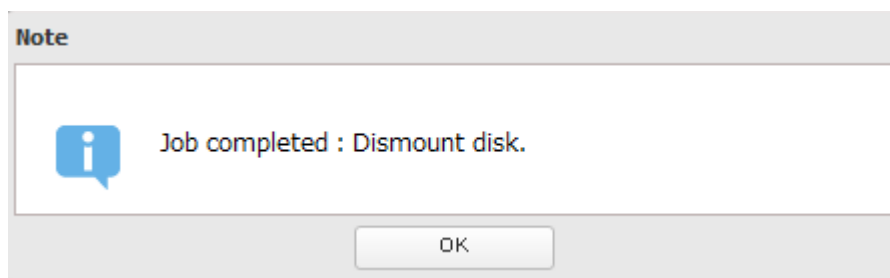

**Note:** To remount the drive, unplug it and then plug it back again.

## **Dismounting from Settings on a Mobile Device**

---

**1** In Settings, tap *USB Device*.

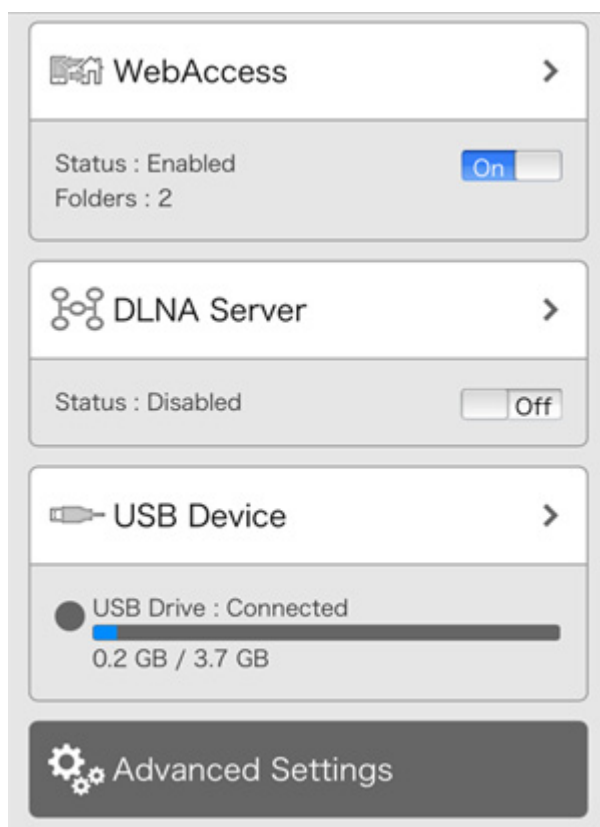

## 2 Tap *Dismount*.

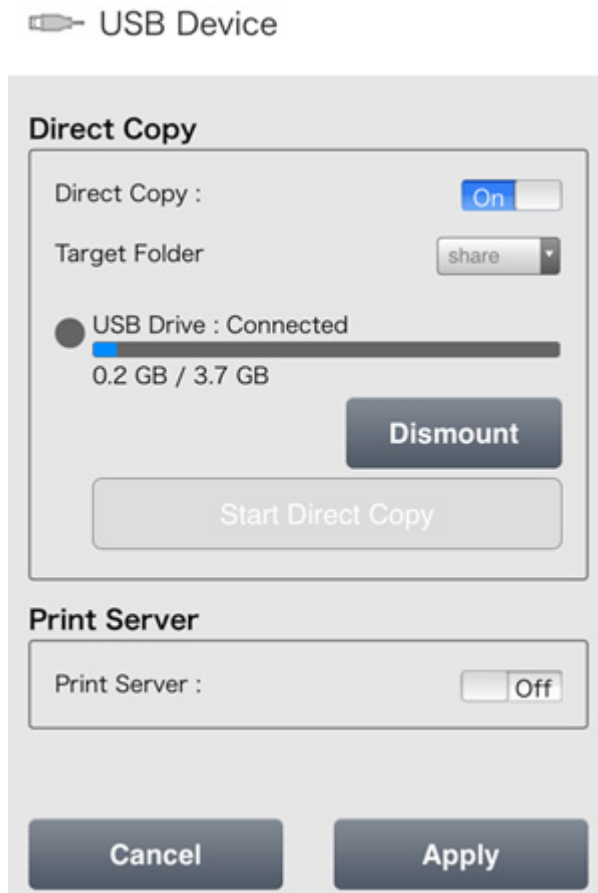

## 3 When the completion message is displayed, unplug the USB device and tap *OK*.

---

## Checking Drives

---

A disk check tests the data on a drive in the LinkStation or connected via USB for integrity. Errors are fixed automatically. With large drives, a disk check may run for many hours. Shared folders cannot be accessed during a disk check. Do not turn off the LinkStation until the disk check is finished. Follow the procedure below to run a disk check.

### 1 In Advanced Settings, click *Drives*.

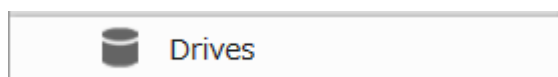

### 2 Click *Drives* to check an internal drive or *USB Drives* to check an external drive.



**3** Select the drive to test and click *Check Disk*.

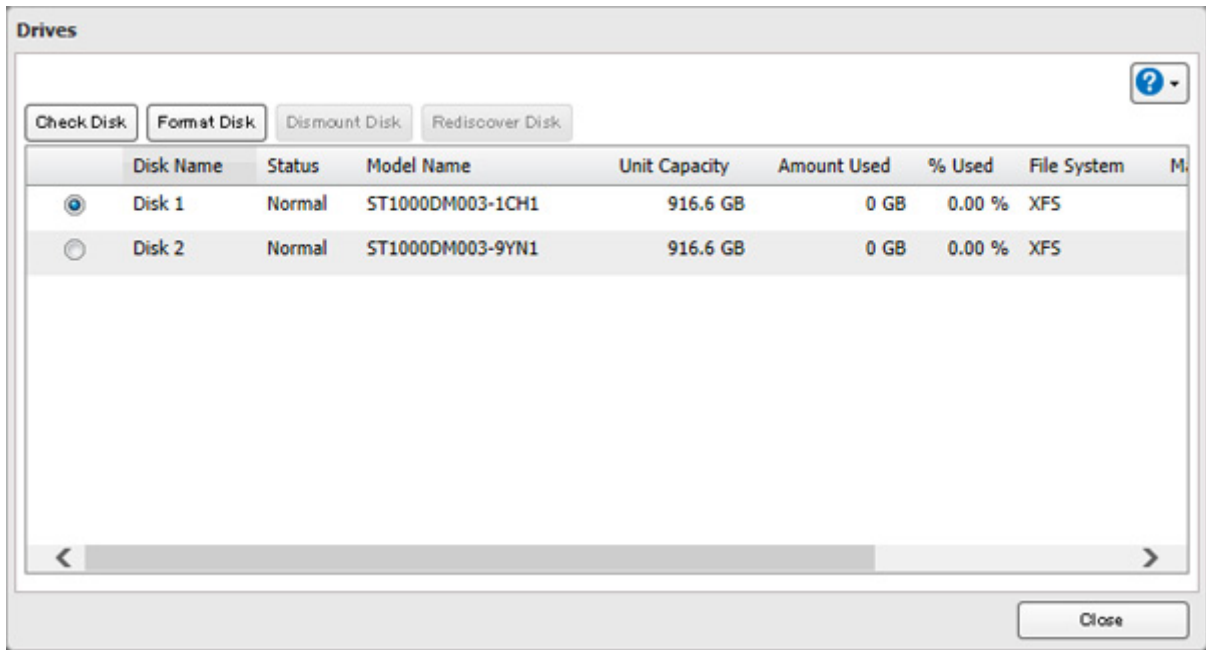

**4** Click *Check*. You have the option of deleting information files from macOS during the check if desired.

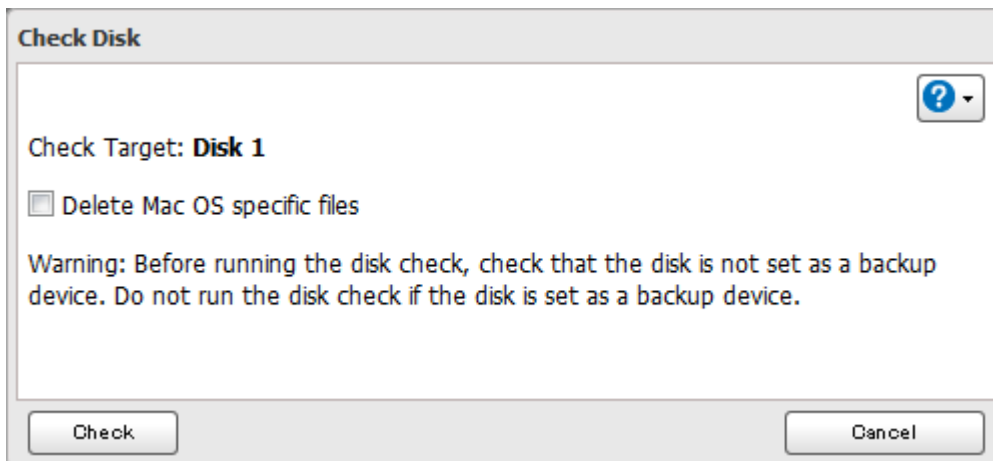

---

## Formatting Drives

---

**Note:** Under some circumstances, data deleted when a drive is formatted can be recovered. To ensure that data is "gone forever", a format might not be sufficient. See the "Erase Data on the LinkStation Completely" section below.

**1** In Advanced Settings, click *Drives*.

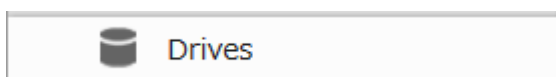

**2** Click *Drives* to format an internal drive or *USB Drives* to format an external drive.



**3** Select the drive to format, then click *Format Disk*.

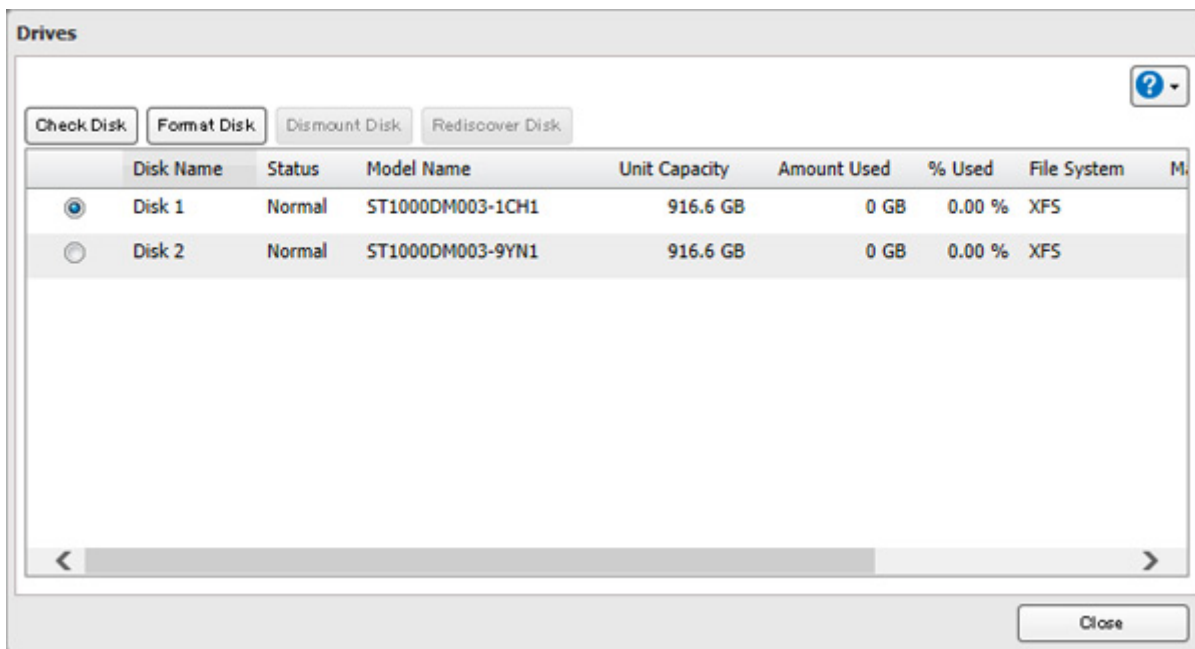

**Note:** If you connect an external drive to the LinkStation and the drive status is still shown as "Unformatted", refresh the status by clicking *Rediscover Disk*. If the status doesn't change, disconnect and reconnect the USB drive.

**4** Select a format type and click *Format*.

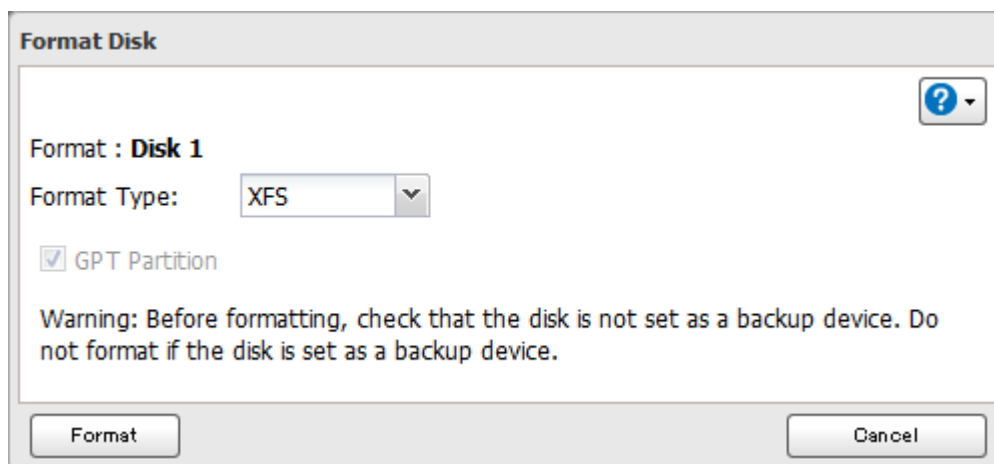

**5** The "Confirm Operation" screen will open. Enter the confirmation number and click *OK*.

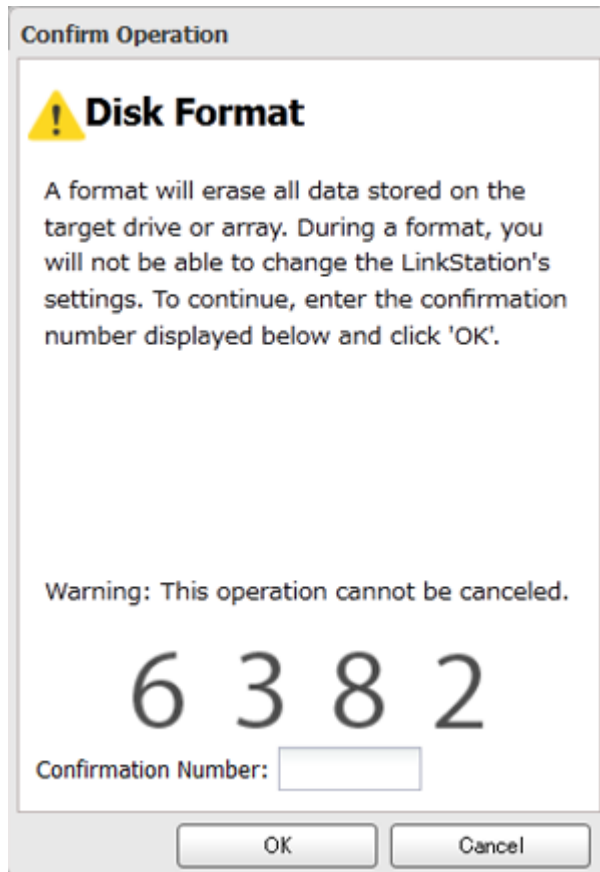

**6** Depending on the size of your drive, the format may take several minutes to several hours to complete. The power LED will flash during the format. Shared folders cannot be accessed during a format. Do not turn off the LinkStation until the disk format is finished.

**Notes:**

- Do not turn off or disconnect power to the LinkStation while formatting a hard drive.
- For drives of 2.2 TB or larger, make sure that the "GPT Partition" checkbox is selected. If you accidentally format a larger drive without GPT, disconnect and then reconnect it before reformatting with GPT.
- The following format types are supported to format from Settings: FAT32 and XFS

---

## Erase Data on the LinkStation Completely

---

Under some circumstances, data from formatted drives can be recovered. The disk erasure process in this section does a much more thorough job of erasing data. This procedure is recommended for removing all data from a drive in a way that makes it nearly impossible to recover with current tools. All data on the drives is completely erased.

The LinkStation will then be in the following state:

- Both drives in JBOD
- An empty shared folder on each drive
- All settings returned to their default values
- All logs deleted

**1** In Advanced Settings, click *Management*.

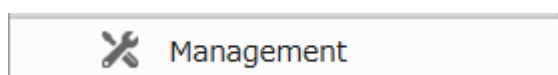

2 Click  to the right of "Restore/Erase".



3 Click *Erase LinkStation*.

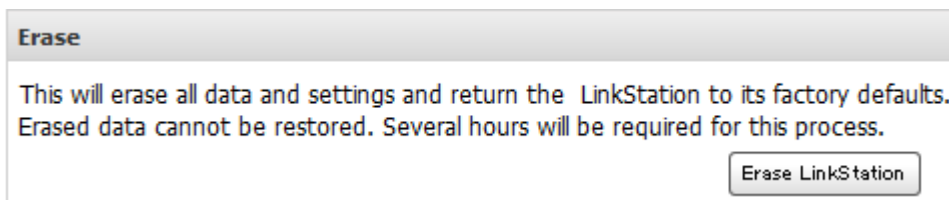

4 The "Confirm Operation" screen will open. Enter the confirmation number, then click *OK*.

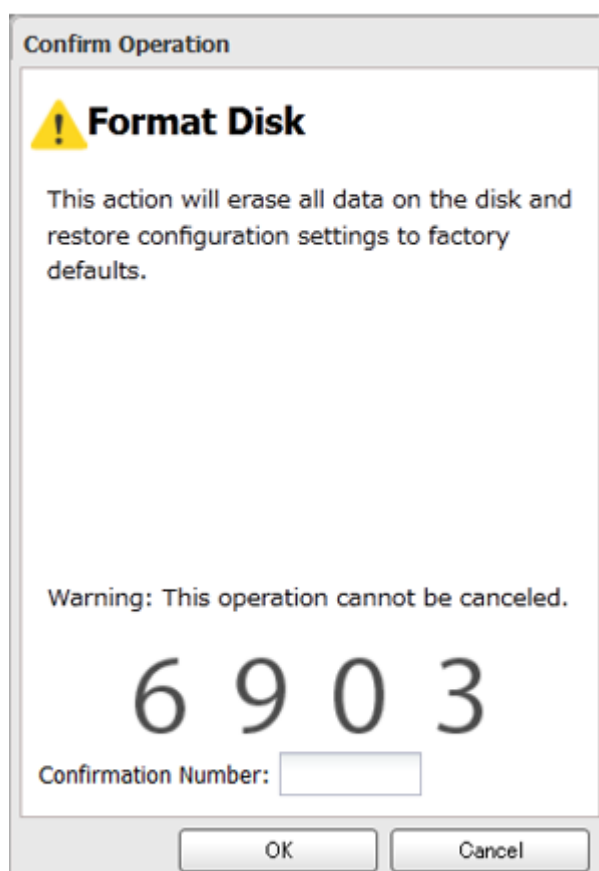

5 All data on the LinkStation will be permanently erased.

---

## Disk Quotas

---

Disk quota will limit drive space for each user or group. You can also configure alert space which will send a notification email when the drive space exceeded the alert space. To spend a notification, configure email notification referring to chapter 8, "Email Notification" section.

**Notes:**

- When using quotas, disable the recycle bin or empty the trash folder often. The limited space includes the space used for trash.
- Quotas apply per drive or per array. If a quota is set to 1 GB, each array or drive can use a maximum of 1 GB.
- Quotas cannot be set for external drives connected to the LinkStation.

- If both user and group quotas are configured for a user, the most restrictive quota will always apply.

## Quotas for Users

---

Follow this procedure to limit the shared folder disk space available for a user.

- 1 In Advanced Settings, click *File Sharing*.

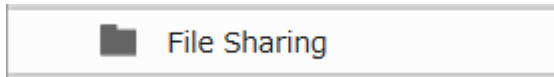

- 2 Click  to the right of "Users".



- 3 Select the user whose space will be limited.

- 4 Enable quotas, choose the maximum space the user will be allowed to use, and click *OK*.

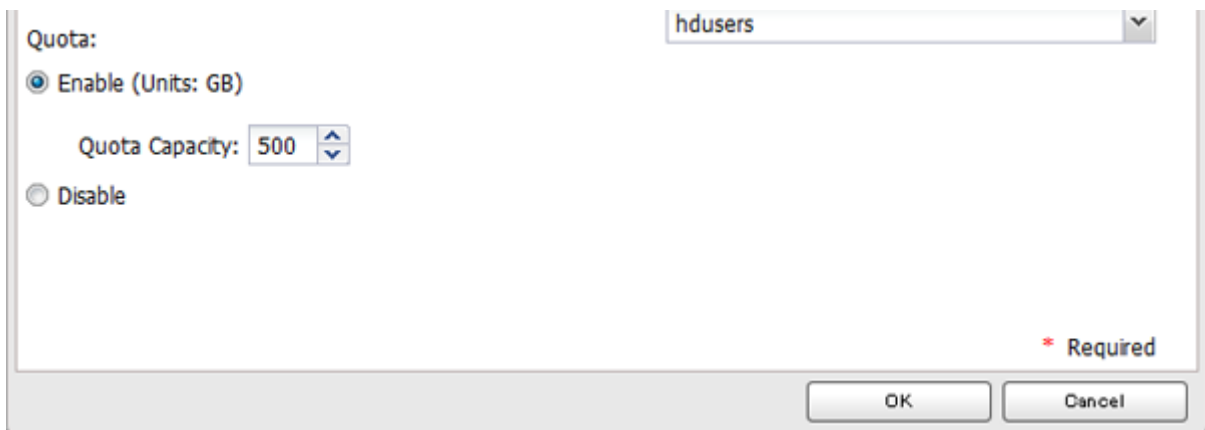

**Note:** If you change the primary group, restart the LinkStation to apply the quota settings.

- 5 Click *OK*.

- 6 Click the  icon and select *Restart* to apply the quota settings.

## Quotas for Groups

---

Follow the procedure below to limit the space for shared folders that each group can use.

- 1 In Advanced Settings, click *File Sharing*.

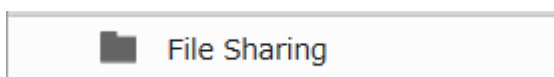

- 2 Click  to the right of "Groups".



- 3 Select the group whose space will be limited.



**4** Enable quotas, choose the maximum space the group is allowed, and click *OK*.

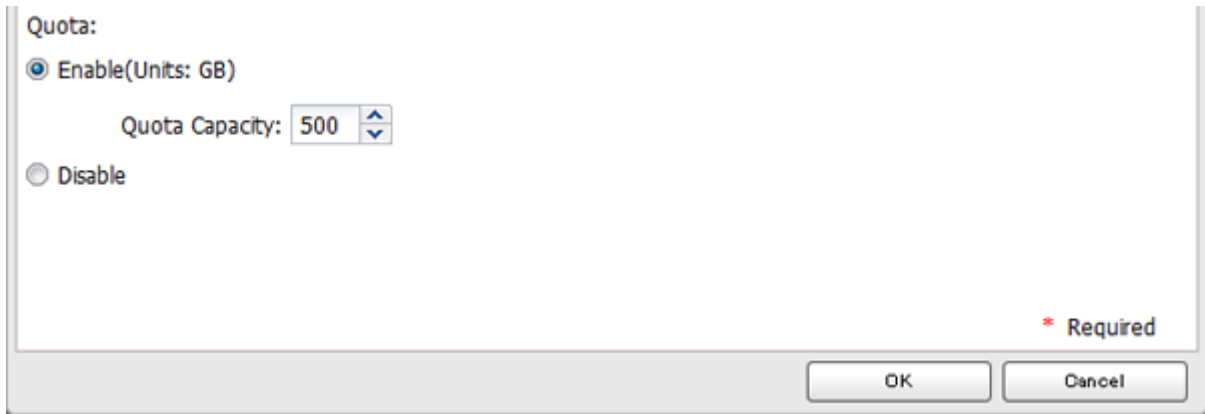

**5** Click *OK*.

**6** In Advanced Settings, click  to the right of "Users".



**7** Select the user who will inherit the group quota settings.

**8** Change the user's primary group to the group with the quota, then click *OK*.

**9** Click *OK*.

**10** Click the  icon and select *Restart* to apply the quota settings.

---

## Hard Drive Replacement

---

If a drive fails, NAS Navigator2 and Settings will show an error message.

**Notes:**

- Do not replace a running drive while the LinkStation is turned on. Power down the LinkStation before changing the drive. While the LinkStation is running, never unplug or remove drives without dismounting them first.
- For the replacement drive, use a Buffalo OP-HDBST series drive of the same size or larger. If a larger drive is used, the extra space will not be usable in a mirrored RAID array.
- If sending a defective drive to Buffalo for replacement, please keep the cartridge as Buffalo will only replace the hard drive and not the cartridge.
- To avoid damaging the LinkStation with static electricity, ground yourself by touching something made of metal before handling any sensitive electronic parts.
- After a drive is replaced, it will take about 30 minutes before normal file reading and writing are restored. Settings may not be accessible during this period.
- Do not change the order of the hard drives in the LinkStation. For example, pulling out drive 1 and replacing it with drive 2 may cause data to be corrupted or lost.
- If a new drive is not recognized after installing it, click *Rediscover Disk* in Settings.

## Rebuilding the RAID Array from a Computer

---

- 1 Turn the LinkStation off and remove all cables.
- 2 Squeeze the left side of the front panel and swing it open.

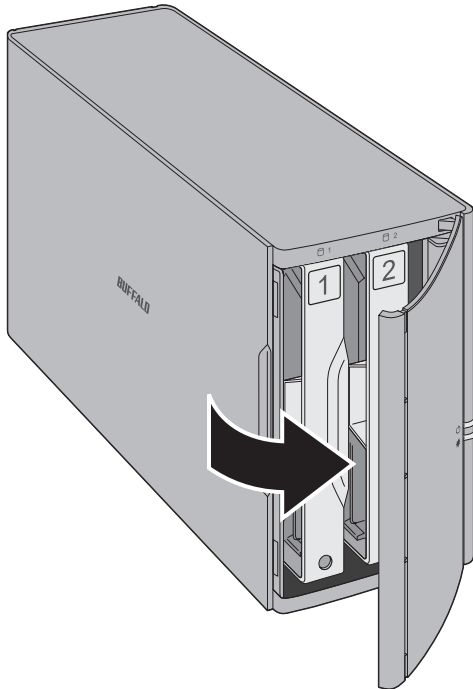

- 3 Push the failed drive's cartridge up and remove it from the LinkStation.

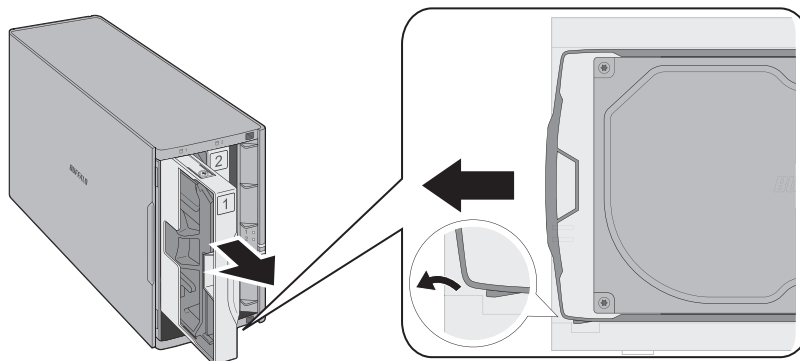

### Notes:

- Do not press hard on the top of the LinkStation.
- Pull the drive straight out the front of the chassis.

**4** Remove the drive from the cartridge.

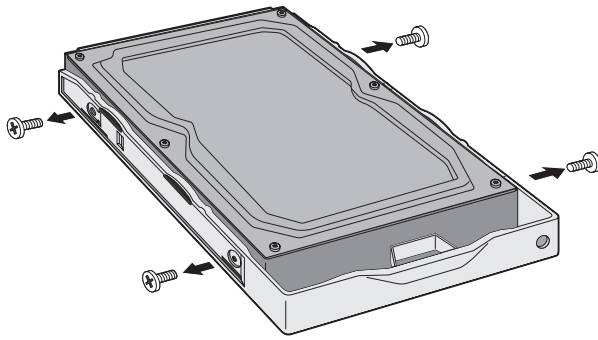

**5** Install a new drive (sold separately) into the cartridge.

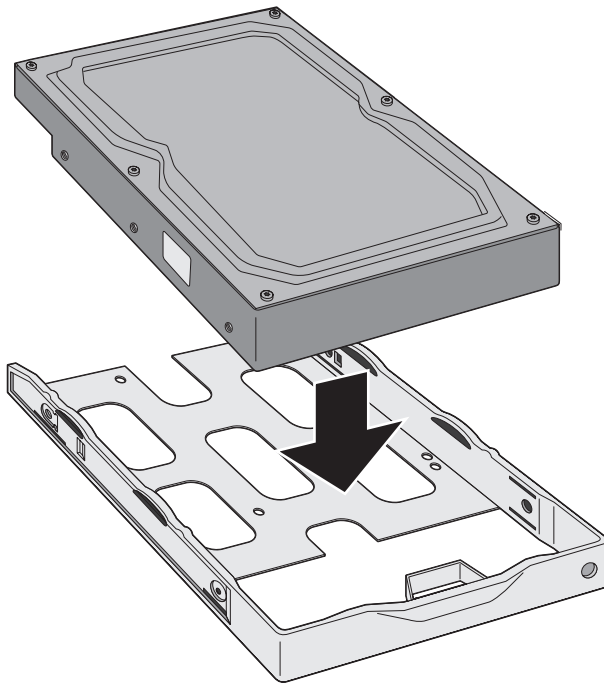

**6** Replace the four screws.

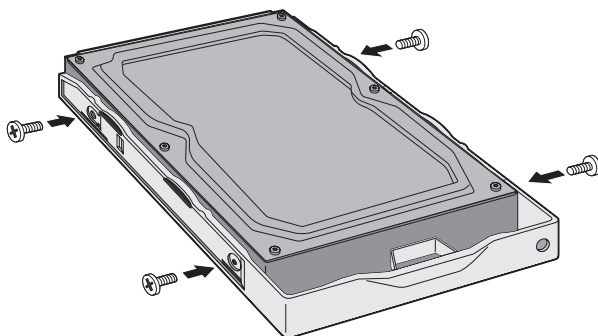

**7** Insert the new drive in the empty slot.

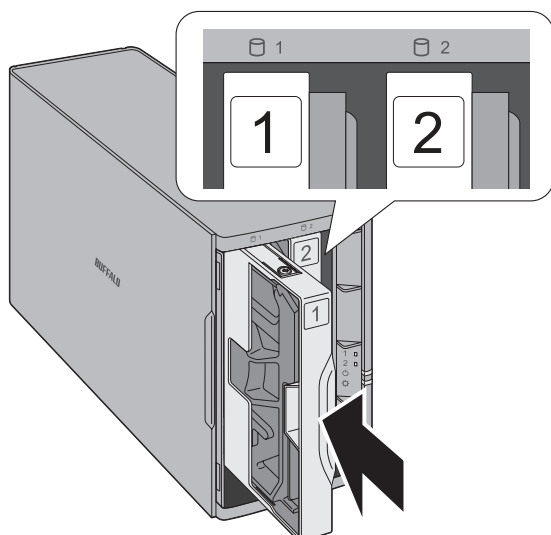

**8** Close the front panel.

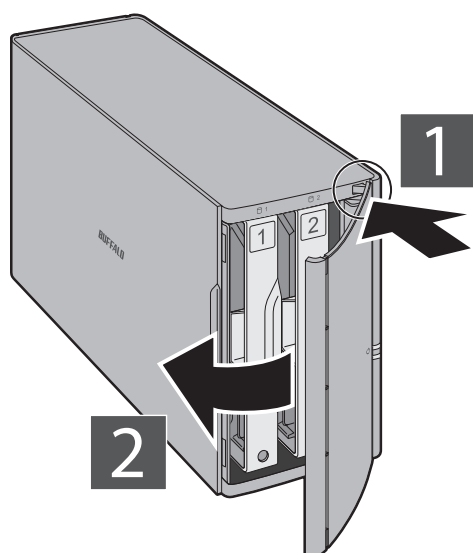

**9** Connect all cables, then turn on the LinkStation.

**10**

**For RAID 0**

Navigate to *Drives - RAID* in Advanced Settings. Select the array with the error, then click *Delete RAID Array*. Navigate to *Drives - Drives*. Choose the new drive (the unformatted one) and format the drive. After formatting the drive, change the RAID mode.

**For RAID 1**

Navigate to *Drives - RAID* in Advanced Settings. Select the array with the error, then click *Recover RAID Array*. Follow the procedure on the screen to complete the hard drive replacement.

**For JBOD**

Navigate to *Drives - Drives* in Advanced Settings. Format the new drive and create a shared folder before use.

## **Rebuilding the RAID Array from a Mobile Device**

You can also initiate the RAID rebuild from your mobile device.

1 Open Settings and tap the blinking red information icon.



## 2 Tap *Recover RAID Array*.

---

### View Status

#### **Error**

The drive has failed. Replace the drive. :

Drive 2

#### **Note**

The system is running in degraded mode because of the condition of one or more arrays.

An error occurred on RAID array 1.

**Recover RAID Array**

#### **System Information**

Name :

LS220DC16

DTCP-IP :

Firmware Version :

1.42-0.29

Serial Number :

IP Address :

LAN Port 1 192.168.10.25

MAC Address :

LAN Port 1 00:50:43:F5:2C:16

Workgroup :

WORKGROUP

---

- 3 Check the status of the drive that failed. Follow the instructions to shut down the LinkStation.

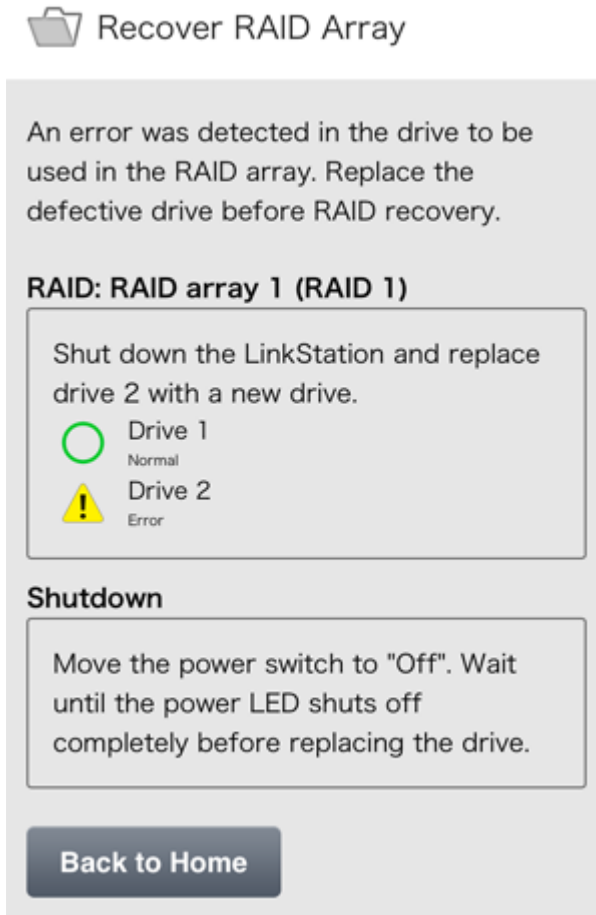

- 4 Squeeze the left side of the front panel and swing it open.
- 5 Push the failed drive's cartridge up and remove it from the LinkStation.
- 6 Remove the drive from the cartridge.
- 7 Install a new drive (sold separately) into the cartridge.
- 8 Replace the four screws.
- 9 Insert the new drive in the empty slot.
- 10 Close the front panel.
- 11 Connect all cables, then turn on the LinkStation.
- 12 In Settings, tap the blinking yellow information icon.

**13** Tap *Recover RAID Array* (twice).



**14** Click Yes.

**15** Enter the confirmation number and tap *OK*. The array will begin to rebuild.



# Chapter 5 Remote Access

## WebAccess

WebAccess is a program for accessing the files in the shared folder of your LinkStation from your computer or mobile device through the Internet. **Be careful when configuring WebAccess. Certain settings can make the files in the shared folder available to anyone on the Internet, without any access restrictions.**

### Configuring from a Computer

#### Configuration from Easy Admin

- 1 Click *WebAccess* in Easy Admin.

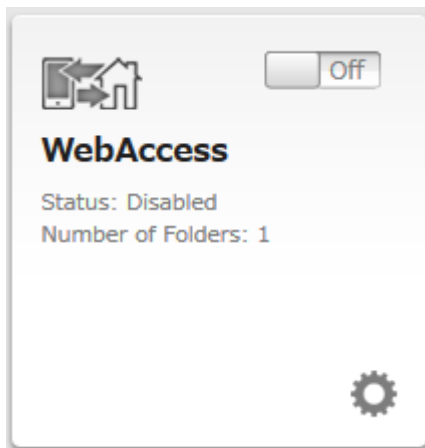

- 2 Move the WebAccess switch to the  position to enable WebAccess.



WebAccess allows you to create a secure personal cloud for easy remote access and file sharing with anyone, anywhere over the Internet while your data remains securely stored in one place on your home network.



- 3 Select the level of access for each shared folder from the drop-down list.

Target Shared Folder	Level of Access
usbdisk1	No remote access
share	No remote access
	No remote access
	Allow access to anyone
	Only registered groups and users
	Sync with shared folder settings

BuffaloNAS.com Name

**4** Enter a BuffaloNAS.com name for your BuffaloNAS account.

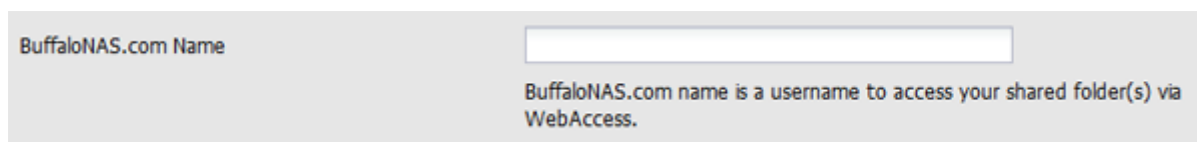

BuffaloNAS.com Name

BuffaloNAS.com name is a username to access your shared folder(s) via WebAccess.

**Note:** The BuffaloNAS.com name may contain from 3 to 20 alphanumeric characters, underscores (\_), and hyphens (-). The BuffaloNAS.com name is case-sensitive.

**5** Click *Apply*.

**6** Continue with the procedure at <http://buffalonas.com/manual/setup/en/>.

## Configuration from Advanced Settings

**1** In Advanced Settings, click *File Sharing*.

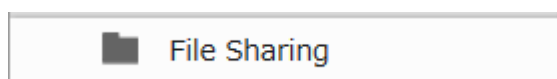

 File Sharing

**2** Click  to the right of "WebAccess".



 WebAccess  Off 

**3** Click *Edit*.

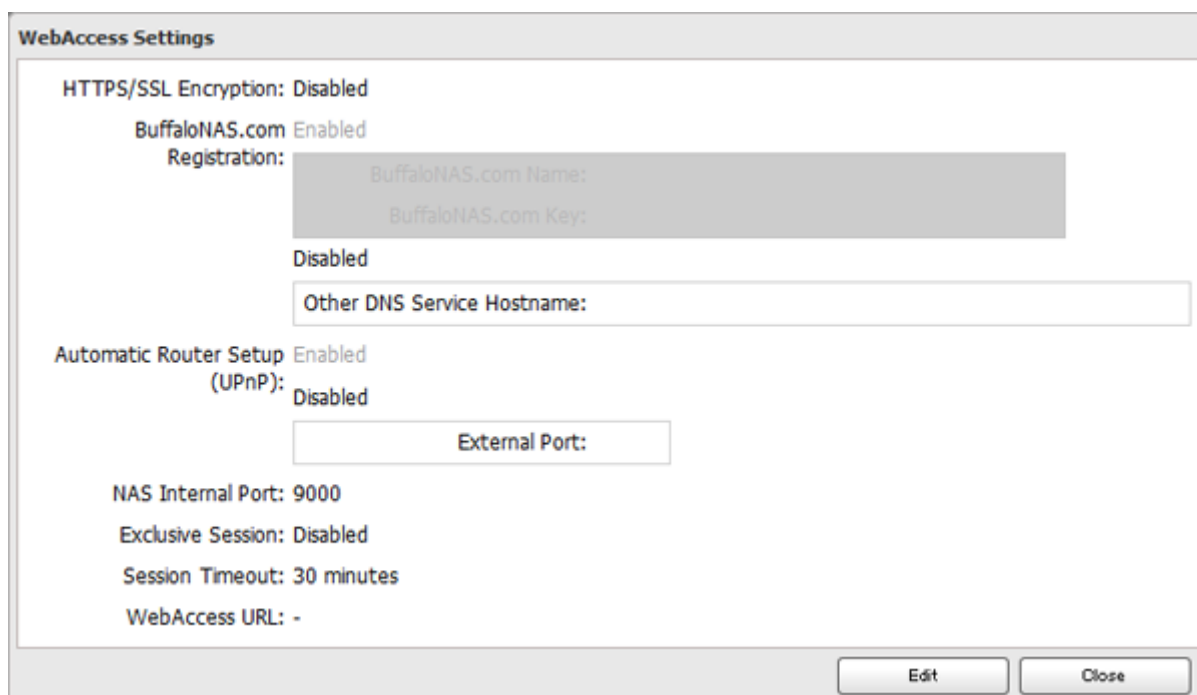

**WebAccess Settings**

HTTPS/SSL Encryption: Disabled

BuffaloNAS.com Enabled

Registration:

Disabled

Automatic Router Setup Enabled

(UPnP): Disabled

NAS Internal Port: 9000

Exclusive Session: Disabled

Session Timeout: 30 minutes

WebAccess URL: -

**4** Configure the desired settings, then click *OK*.

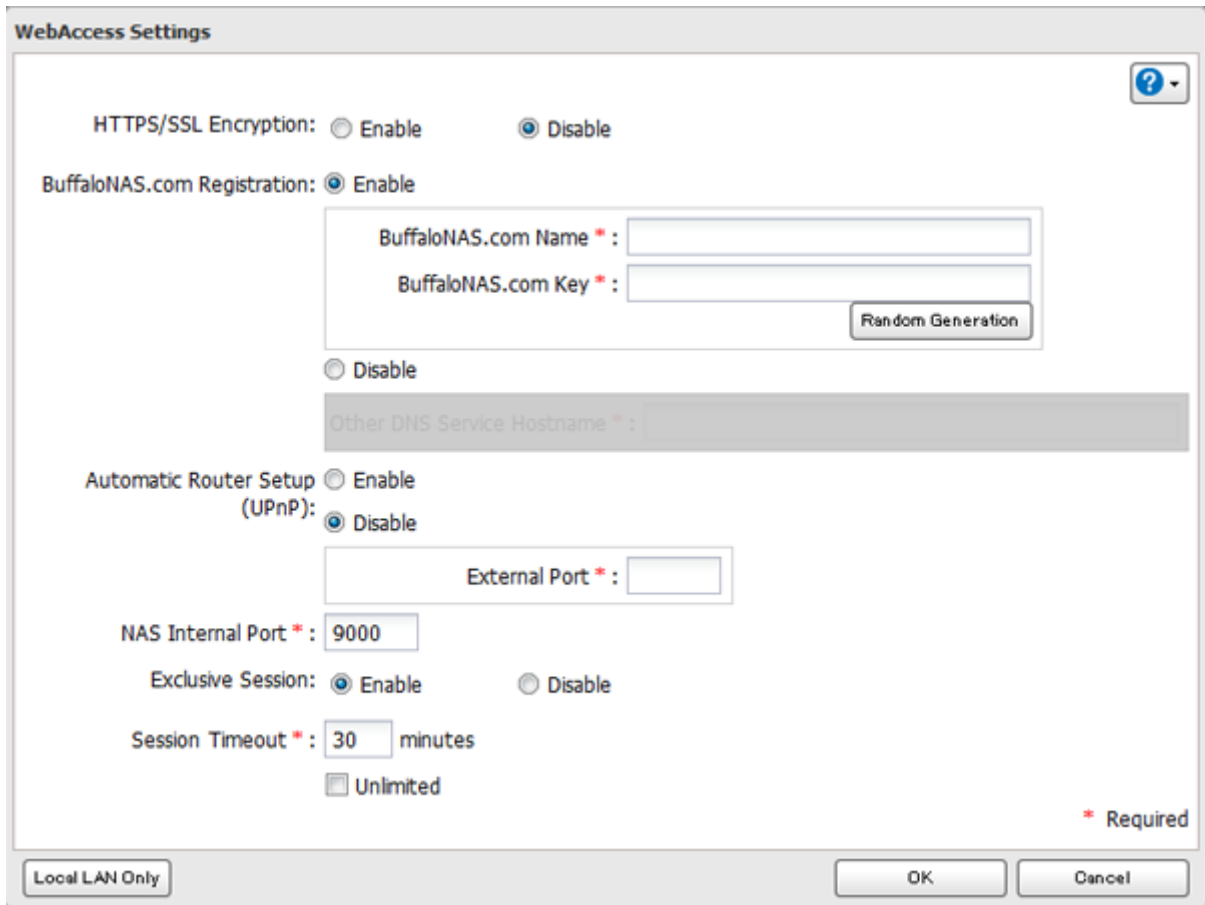

The image shows the 'WebAccess Settings' dialog box. It contains the following settings:

- HTTPS/SSL Encryption:  Enable  Disable
- BuffaloNAS.com Registration:  Enable
- BuffaloNAS.com Name \*: [text input]
- BuffaloNAS.com Key \*: [text input] [Random Generation button]
- Disable
- Other DNS Service Hostname \*: [text input]
- Automatic Router Setup (UPnP):  Enable  Disable
- External Port \*: [text input]
- NAS Internal Port \*: [text input] 9000
- Exclusive Session:  Enable  Disable
- Session Timeout \*: [text input] 30 minutes
- Unlimited

At the bottom, there is a 'Local LAN Only' button, 'OK' and 'Cancel' buttons, and a '\* Required' indicator.

- To use SSL encryption for more secure data transfers, enable "HTTPS/SSL Encryption". Some WebAccess applications may not support HTTPS/SSL encryption. Disable it if this is an issue. For more details, refer to the WebAccess Help Guide.
- You may use the default BuffaloNAS.com registration, or disable it to use a different DNS server.
- Choose a "BuffaloNAS.com Name" and "BuffaloNAS.com Key" for your WebAccess account. Names and keys may use 3 to 20 alphanumeric characters, underscores (\_), and hyphens (-).
- If "Exclusive Session" is enabled, users cannot log multiple computers in to WebAccess. Only the last login will be active.
- Enter a time in minutes (1 to 120 or "Unlimited") before inactive users are logged out of WebAccess.

**5** Click *OK*.

**6** Move the switch to the  position to enable WebAccess.

**7** Click  to the right of "Folder Setup".



The image shows a 'Folder Setup' bar with a plus icon on the left, the text 'Folder Setup', '2 Folder(s)' in the center, and a share icon on the right.

**8** Select a shared folder to publish.

**Notes:**

- For best results, create a new dedicated share for WebAccess.
- When accessing shared folders through WebAccess from a remote location, the username and password may be required for certain operations. For best results, create a user account with permissions on the WebAccess share before using WebAccess.

9 Click *Edit*.

10 Under "LAN Protocol Support", check "WebAccess" and click *OK*.

**Notes:**

- The following levels of security are available:  
"Allow Anonymous" - Anyone can access (view) shared folders.  
"Allow All Groups and Users" - All groups and users registered on the LinkStation or TeraStation can use WebAccess.  
If you added a local group or user but you cannot access a shared folder which is allowed to access all groups and users, restart WebAccess by moving the WebAccess switch to "off" then "on", and try again.  
"Use Inherited Folder Permissions" - Users and groups have the same access permissions with WebAccess that they do locally. If access restrictions are not set for the shared folder, then this option will not be shown.
- When a user or group can access a folder through WebAccess depends on a combination of WebAccess settings and the shared folder's settings.

Folder Setup	WebAccess Public Mode	Allow Anonymous		Allow All Groups and Users		Use Inherited Folder Permissions	
	Folder Attribute	Read & Write	Read Only	Read & Write	Read Only	Read & Write	Read Only
WebAccess Account	Not logged in	R	R	-	-	-	-
	User with read & write access	R/W	R	R/W	R	R/W	R
	User with read-only access	R/W	R	R/W	R	R	R
	Group with read & write access	R/W	R	R/W	R	R/W	R
	Group with read-only access	R/W	R	R/W	R	R	R
	Other users	R/W	R	R/W	R	-	-

R: Read only, R/W: Read and write, -: No access

11 Continue with the procedure at <http://buffalonas.com/manual/setup/en/>.

**Note:** If you change your BuffaloNAS.com name after WebAccess has been configured, WebAccess may no longer work properly. If this happens, disable and then re-enable WebAccess.

## Configuring from a Mobile Device

---

**Notes:**

- On your mobile device, download and install the "SmartPhone Navigator" and "WebAccess" applications from the App Store (iOS devices) or Google Play (Android devices).
- You can also configure WebAccess settings from Settings.

1 Open "SP Navigator" on your iOS device or "SmartPhone Navigator" on your Android device.



2 Select the LinkStation to configure WebAccess.

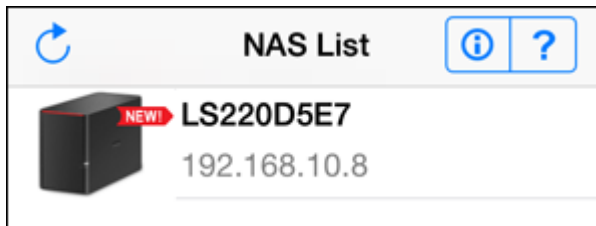

3 Tap *NAS Setup*.

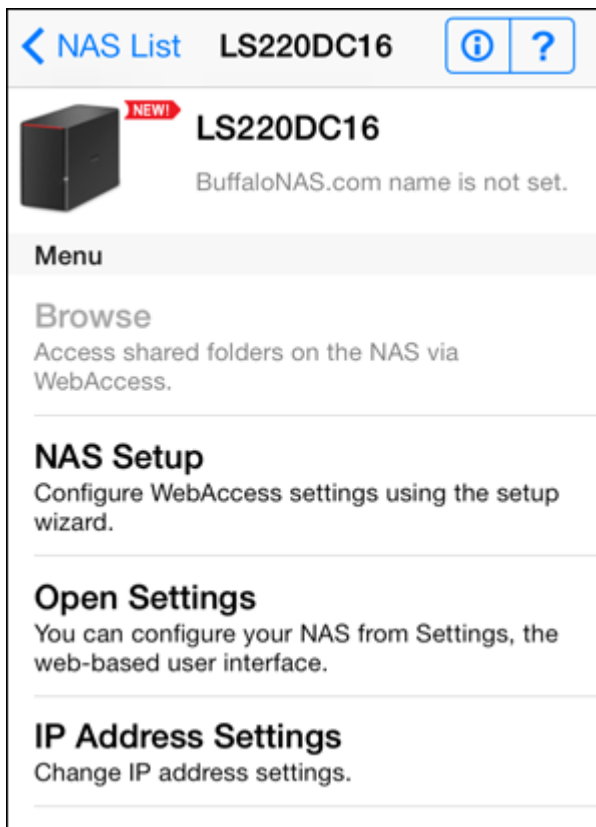

**4** Enter a username and password. This will create a new user. Tap *Next*.

The screenshot shows a mobile application screen titled "NAS Setup". At the top left is a blue back arrow and the word "Back". The title "NAS Setup" is centered at the top. Below the title, there is a blue question mark icon. The main text reads: "Enter an username and password. If the account does not already exist, a new user will be created. A shared folder will be created with the same name as the username." Below this text are two input fields: "Username" and "Password". At the bottom of the screen, there are two buttons: "Cancel" on the left and "Next" on the right.

**5** Enter the password from the previous step again and tap *Next*.

Back

Enter the password for .

Password:

Cancel Next

**Note:** If UPnP is not enabled on your network, you will only be able to access your NAS from the local network. To use WebAccess from outside your home, either enable UPnP in the router or open port 9000 for WebAccess in your router's settings.

### Setup Complete

Configuration finished. You can now access your NAS using WebAccess.

**Note: You can not access from an outside network.**

Tap "Open WebAccess" to start the WebAccess app.

Finish      Open WebAccess



6 Enter the BuffaloNAS.com name and tap *Set*.

The screenshot shows a mobile application interface for "NAS Setup". At the top left, there is a blue back arrow and the word "Back". The title "NAS Setup" is centered at the top. Below the title, there is a blue question mark icon. The main text reads: "Enter your BuffaloNAS.com name. You will use this name for opening the shared folder from outside network. The BuffaloNAS.com name may contain up to 20 alphanumeric characters." Below this text is a rectangular text input field. At the bottom left, there is a "Cancel" button, and at the bottom right, there is a "Set" button.

**7** Tap *Open WebAccess*.

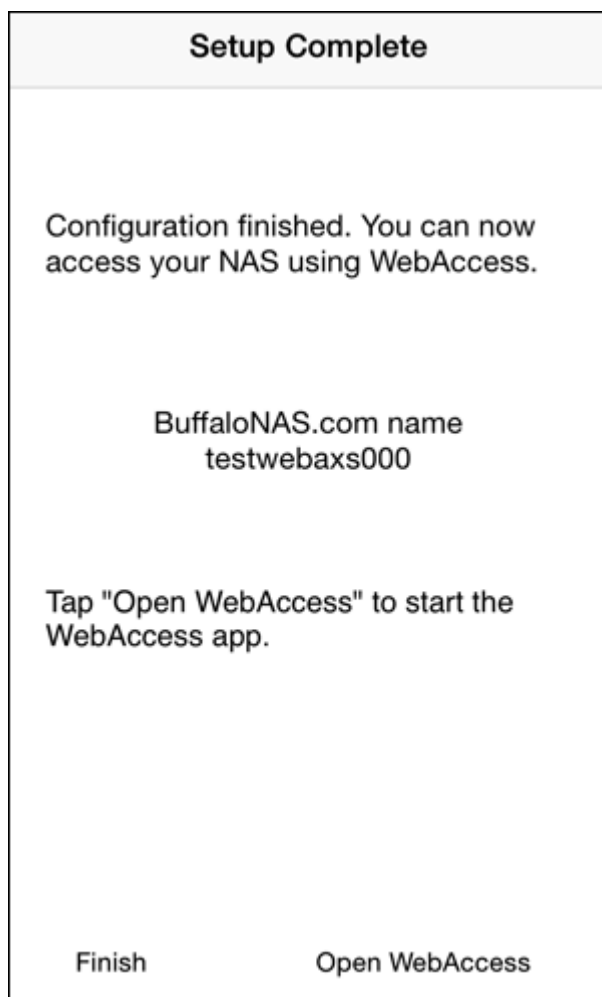

**8** WebAccess will launch.

**9** Tap *OK* if the following message is displayed.

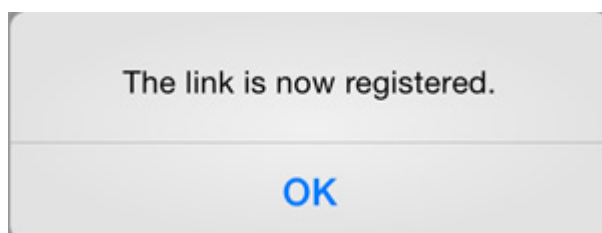

**10** Tap your LinkStation's hostname to open the shared folder.

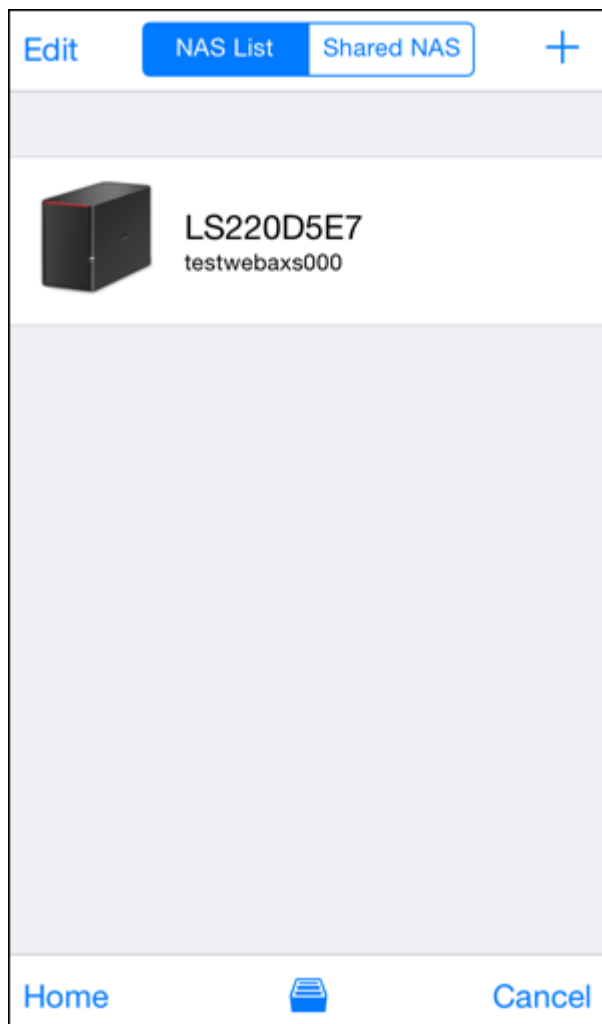

### **If Creating BuffaloNAS.com Name Failed**

If UPnP is disabled in your router, creating the BuffaloNAS.com name from SmartPhone Navigator may fail. If this happens, try the following procedure.

- 1** Tap the "SmartPhone Navigator" icon on your mobile device.
- 2** Tap *Open Settings*.

**3** Tap *WebAccess*.

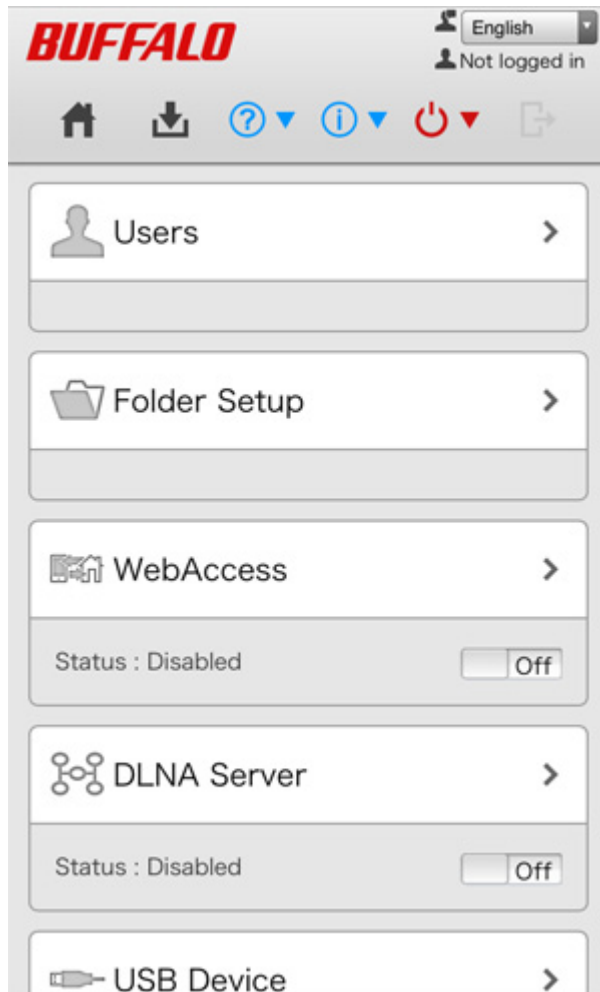

**4** Select the access level from the drop-down list and tap *Apply*.

**5** Tap *OK*.

**6** Enter the desired BuffaloNAS.com name.

**7** Select "Configure router's port settings manually", enter the router's port number, and tap *Apply*.

---

## FTP

---

By default, the LinkStation's shares are only accessible by users connected to the same network or router as the LinkStation. The optional FTP server allows users outside the local network to access the LinkStation.

**Note:** FTP is intended for users who already have FTP client software and have experience with it.

**1** In *Advanced Settings*, click *File Sharing*.

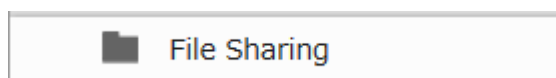

**2** Move the FTP switch to the  position to enable FTP.



**3** Click  to the right of "Folder Setup".



**4** Choose a folder to enable remote FTP access on.

**5** Click *Edit*.

**6** Select read-only or read & write for the shared folder's attribute; under "LAN Protocol Support", check "FTP" and click *OK*.

#### Accessing the LinkStation with an FTP client

- To access the LinkStation via FTP, configure your FTP client software with the following settings:  
Hostname: IP address of the LinkStation  
Username: The LinkStation's username  
Password: The LinkStation's password  
Port: 21
- Shared folders connected by FTP are available from the "/mnt" directory. The default locations are:  
/mnt/disk1/share  
/mnt/usbdisk1

#### Accessing the LinkStation with an anonymous user\*

- To allow anonymous access to your FTP share, disable access restrictions.
- To access the LinkStation via anonymous FTP, configure your FTP client software with the following settings:  
Hostname: IP address of the LinkStation  
Username: Anonymous  
Password: Any character string  
Port: 21

\*If the LinkStation joins a domain, anonymous users cannot access it.

#### Notes:

- Don't use FTP to share files and folders with multi-byte characters in their names with a Mac. Use an AFP or SMB connection instead.
- If a file was created or copied by AFP, you may not be able to delete it using an FTP connection. If this occurs, use an SMB or AFP connection instead to delete the file.
- For FTP connections, make sure that the total filename including directory path is 250 single-byte characters or less.

# Chapter 6 Backup

## Back Up from the LinkStation

You can back up LinkStation folders to:

- A different folder on the LinkStation
- Another LinkStation on the network
- Another TeraStation on the network

## Preparing a Backup Destination

First, configure a folder as a backup destination.

**1** In Advanced Settings, click *File Sharing*.

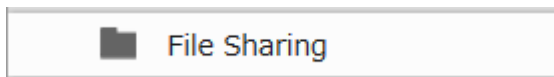

**2** Click  to the right of "Folder Setup".



**3** Choose the folder to set as a backup destination.

**4** Click *Edit*.

**5** Under "LAN Protocol Support", check "Backup" and click *OK*.

### Notes:

- To configure a password, enter it in the "Remote Backup Password" field. Leave this field blank if you don't want a password. If the target or source device is configured with a backup password, the folder will not be listed as a target or source device in the folder list unless the configured password is entered.
- A backup password is not available when a new shared folder is created by a power user.

## Backing up to a LinkStation or TeraStation on another network when connected by a VPN

You can back up to a LinkStation or TeraStation on another network as long as the two networks are connected by a VPN. Follow this procedure to enter the IP address or hostname of the target LinkStation or TeraStation.

**1** In Advanced Settings, click *Backup*.

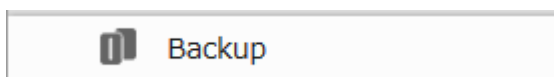

2 Click  to the right of "Backup".



3 Click *List of LinkStations and TeraStations*.

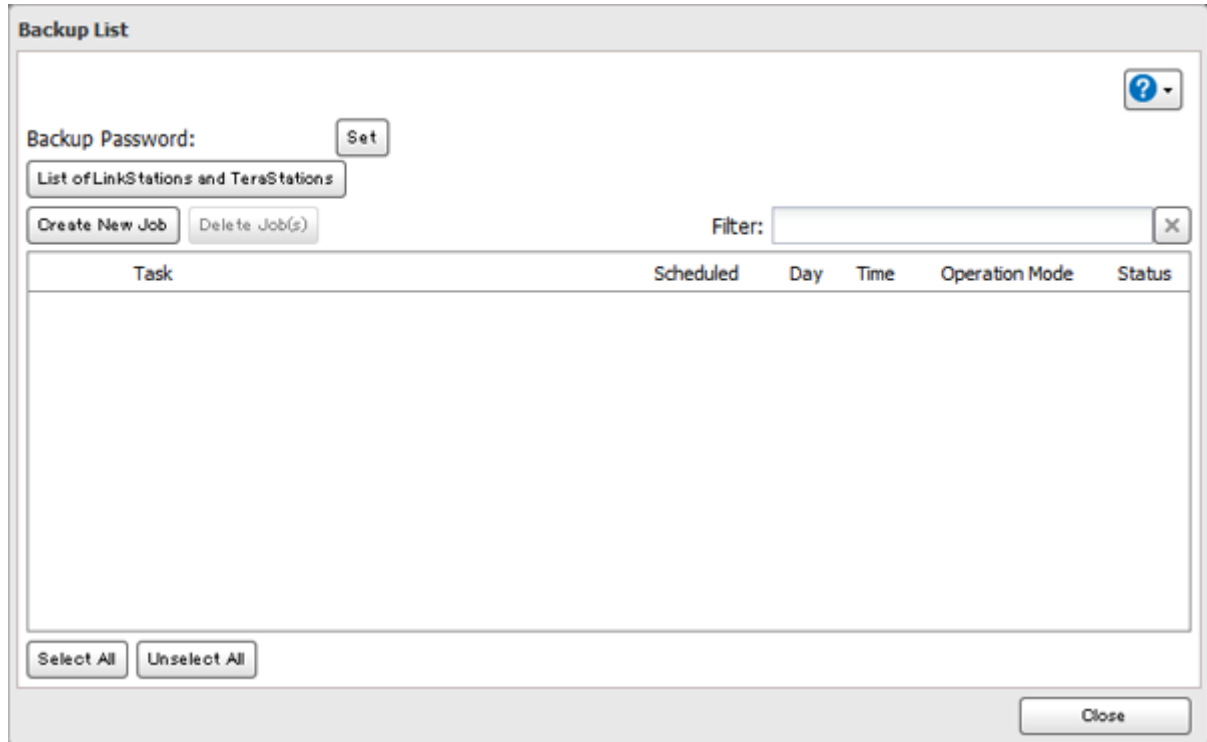

**4** Click *Add*, enter the IP address of the target LinkStation or TeraStation, and click *Close*.

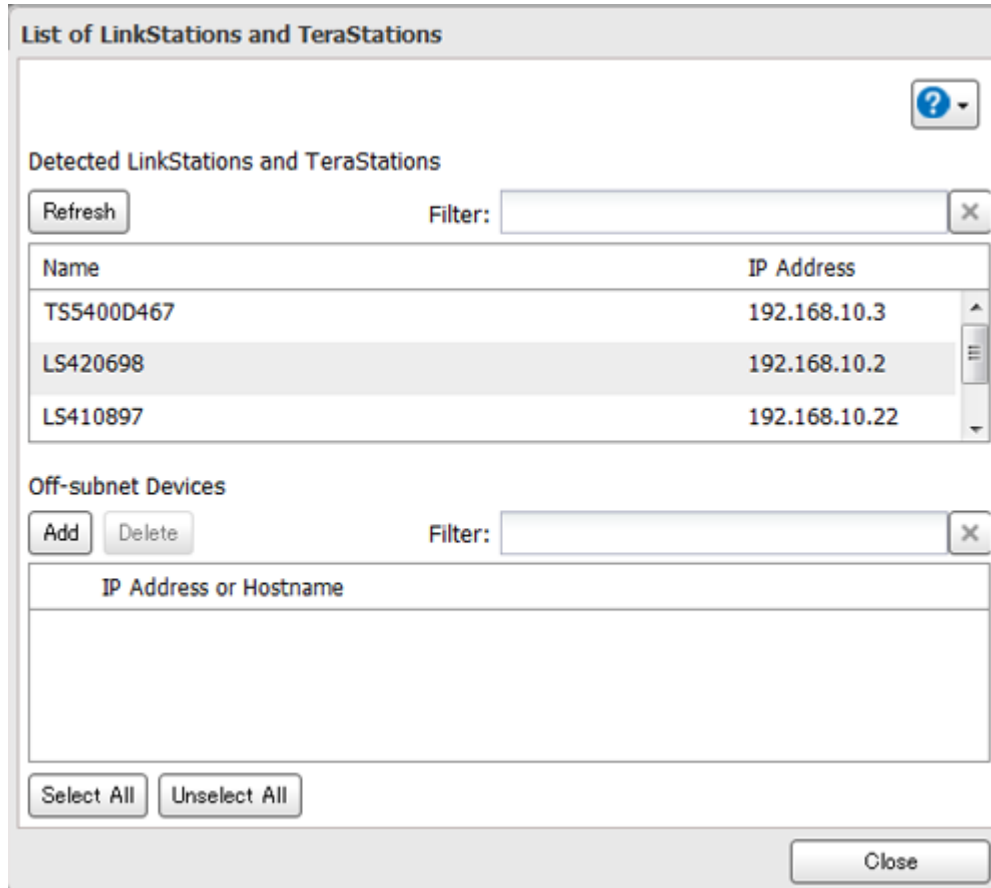

If your setup meets the requirements below, you don't have to configure these settings.

- The source and target LinkStations are on the same network.
- No backup password is set for the target LinkStation.
- No LinkStation from outside the subnet, or connected by a VPN, is used.

**Notes:**

- To back up data between LinkStations or TeraStations on a network using jumbo frames, make sure that both devices are configured to use identical (or similar) Ethernet frame sizes. If Ethernet frame sizes are significantly different, the backup job may not be properly performed. In such a case, select the default frame size (1500 bytes).
- You can also specify hostname by a fully qualified domain name (FQDN).

## Configuring a Backup Job

**1** In Advanced Settings, click *Backup*.

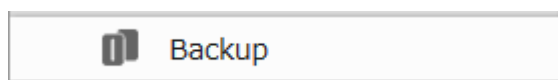

**2** Click  to the right of "Backup".



**3** If you configured a backup password, click *Set* to the right of "Backup Password". If not, skip to step 5.



4 Enter the configured backup password and click *OK*.

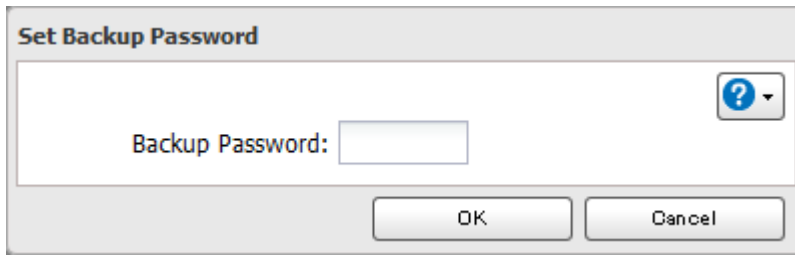

The dialog box titled "Set Backup Password" features a text input field labeled "Backup Password:" with a small blue question mark icon to its right. At the bottom, there are two buttons: "OK" and "Cancel".

5 Click *Create New Job*.

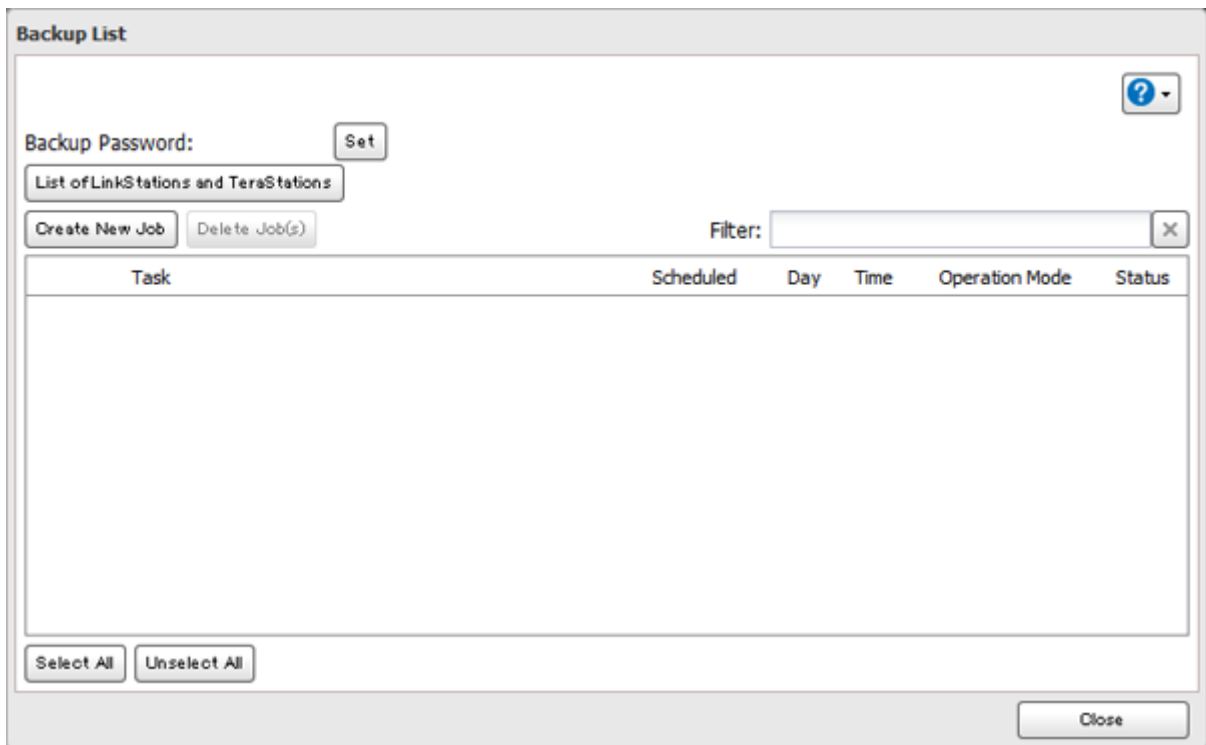

The "Backup List" dialog box contains a "Backup Password:" field with a "Set" button. Below it is a text box containing "List of LinkStations and TeraStations". There are "Create New Job" and "Delete Job(s)" buttons. A "Filter:" text box is on the right. A table with columns "Task", "Scheduled", "Day", "Time", "Operation Mode", and "Status" is in the center. At the bottom left are "Select All" and "Unselect All" buttons, and a "Close" button is at the bottom right.

Task	Scheduled	Day	Time	Operation Mode	Status
------	-----------	-----	------	----------------	--------

**Note:** Up to 8 backup jobs can be configured.

**6** Select backup settings such as date and time to run.

**Note:** The following types of backup jobs may be selected:

Type	Files Included
Normal backup	All files in the source will be backed up to the destination.
Overwrite (incremental)	The first time the backup job runs like a normal backup. In subsequent backups, files added to the source as well as files deleted from the source are kept in the backup folder.
Overwrite (differential)	The first backup job runs like a normal backup. As each additional backup job runs, files are added to and deleted from the backup folder. The backup destination folder is always the same size as the backup source folder.

**7** Click *Add*.

**8** Click *Browse* under "Backup Source Folder Name".

**9** Select the shared folder that will be the backup source, then click *OK*.

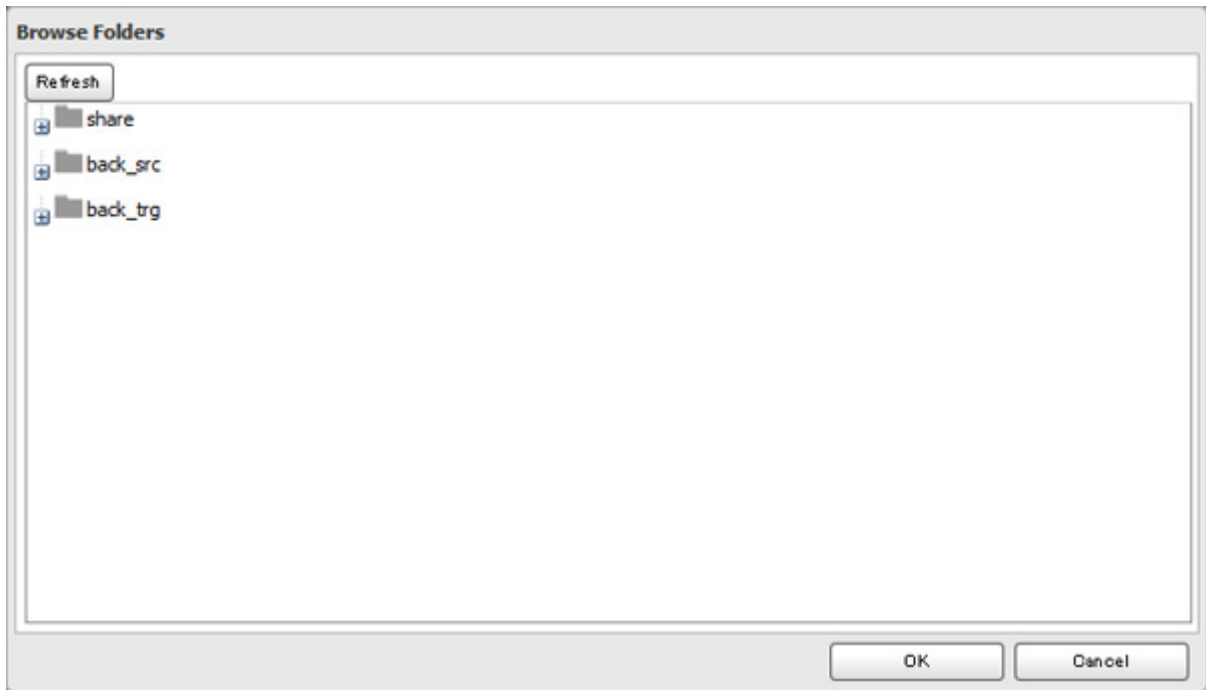

**10** Click *Browse* under "Backup Target Folder Name".

**11** Select the backup target and click *OK*.

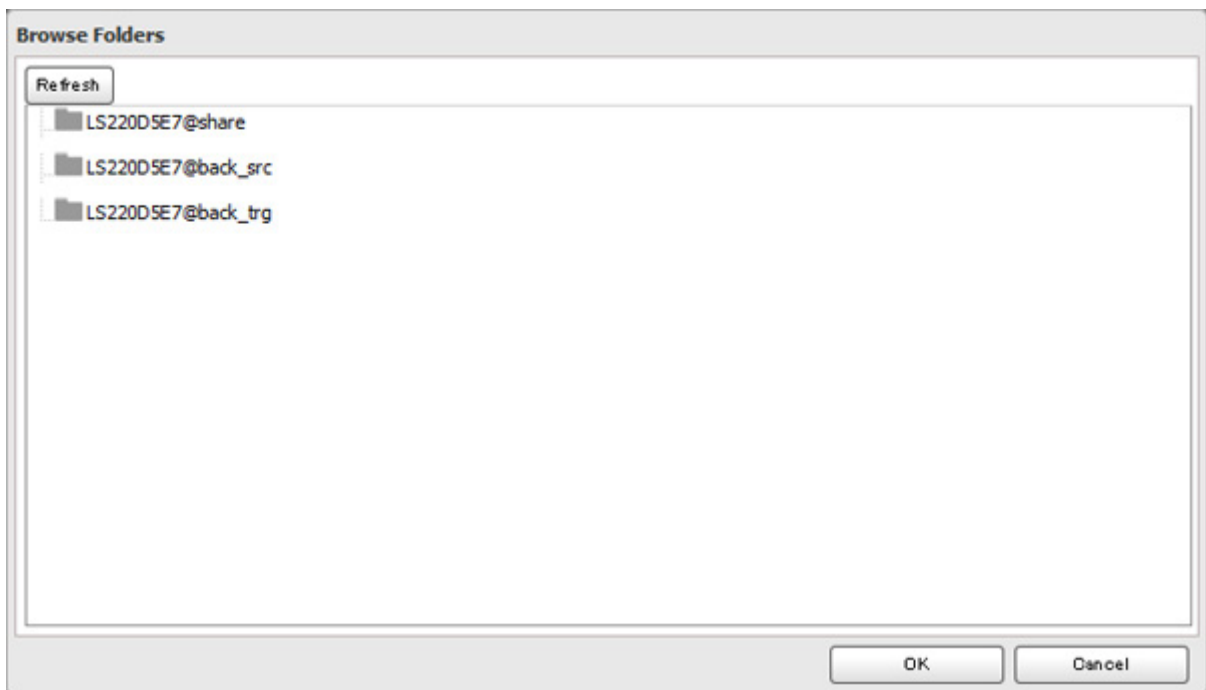

**12** Click *OK*. New backup jobs are now visible.

**13** Click *Close*.

---

## Backing Up Your Mac with Time Machine

---

Time Machine is a backup program included with macOS. To use your LinkStation as a backup destination for Time Machine, configure it as described below.

**1** Make sure that AFP is enabled in Advanced Settings. The AFP switch should be in the  position.



**2** Click  to the right of "Folder Setup".



**3** Choose a shared folder as your backup destination for Time Machine.

**4** Click *Edit*.

**5** Under "LAN Protocol Support", check "AFP (Mac)" and click *OK*.

**6** Click *OK*.

**7** Click *Close*.

**8** Click *Backup*.

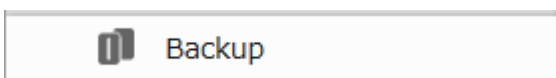

**9** Click  to the right of "Time Machine".



**10** Click *Edit*.

**11** Click *Browse*.

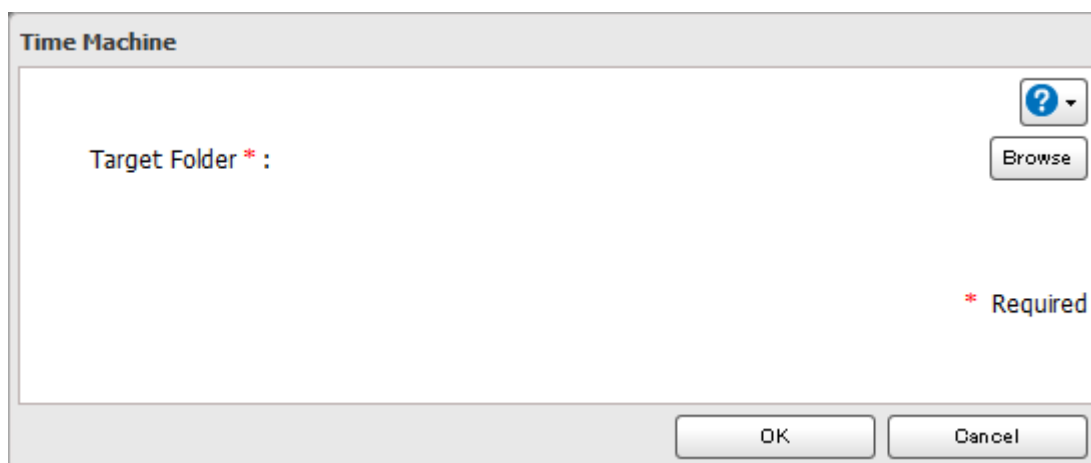

**12** Select the shared folder that you set in the previous step, then click *OK*.

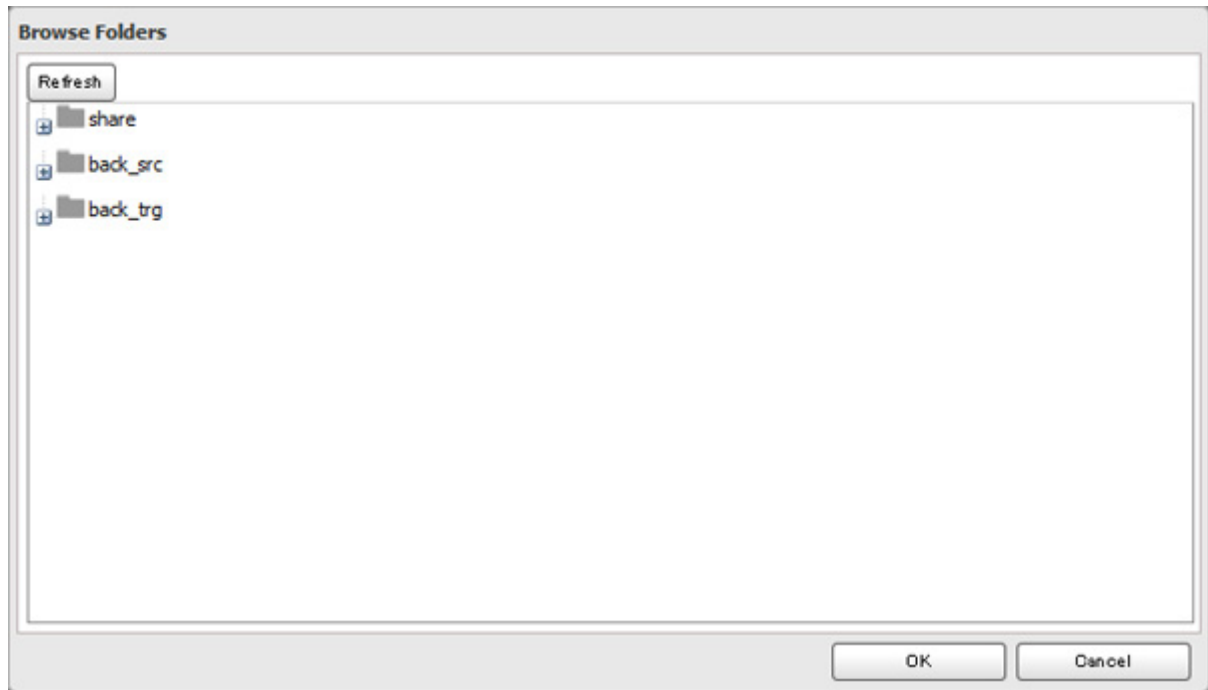

**13** Click *OK*.

**14** Click *OK*.

**15** Move the Time Machine switch to the  position to enable Time Machine.



**16** On the Mac, open *System Preferences*.

**17** Click *Time Machine*.

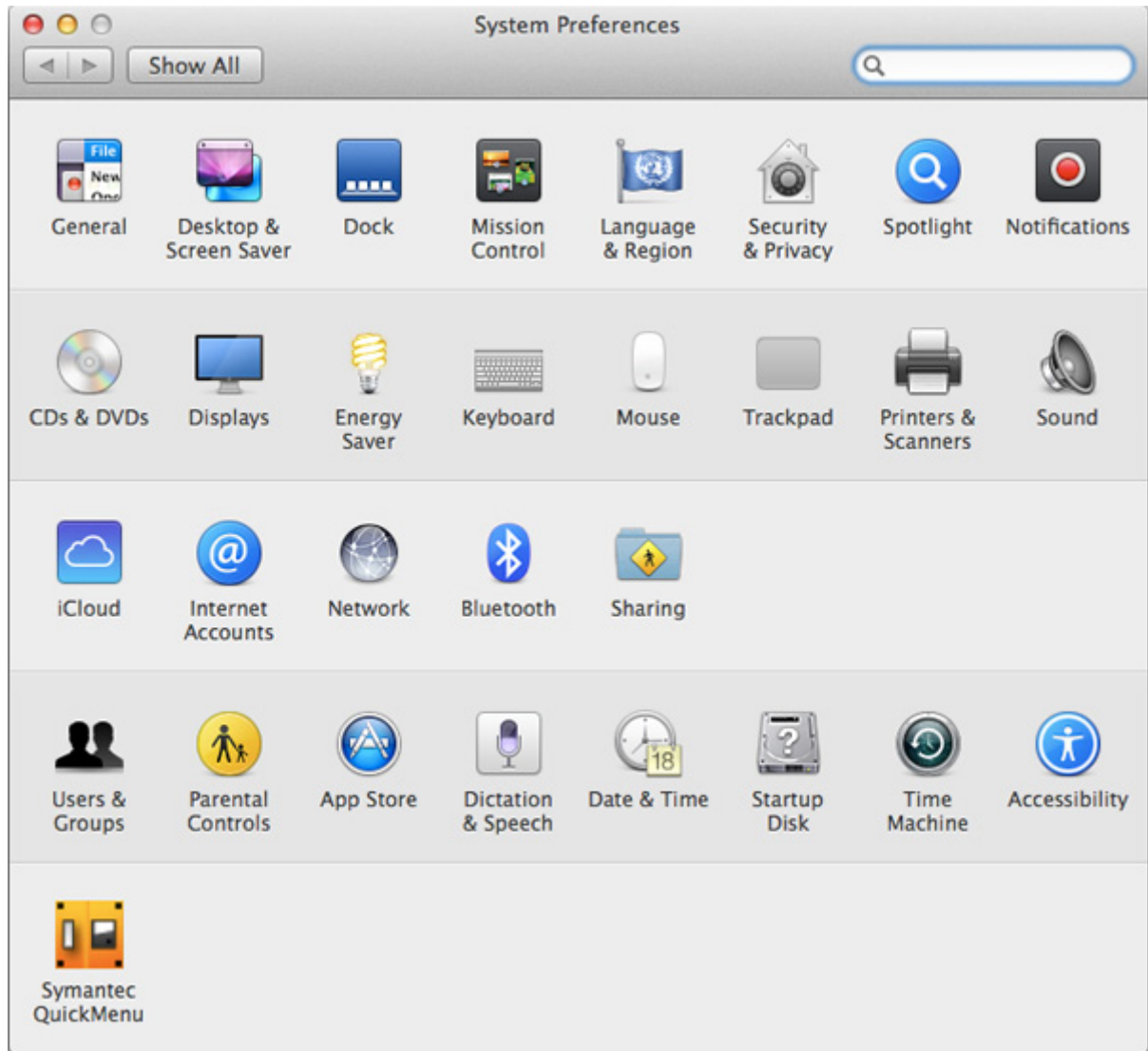

**18** Click *Select Backup Disk*.



**19** Select the LinkStation, then click *Use Disk*.

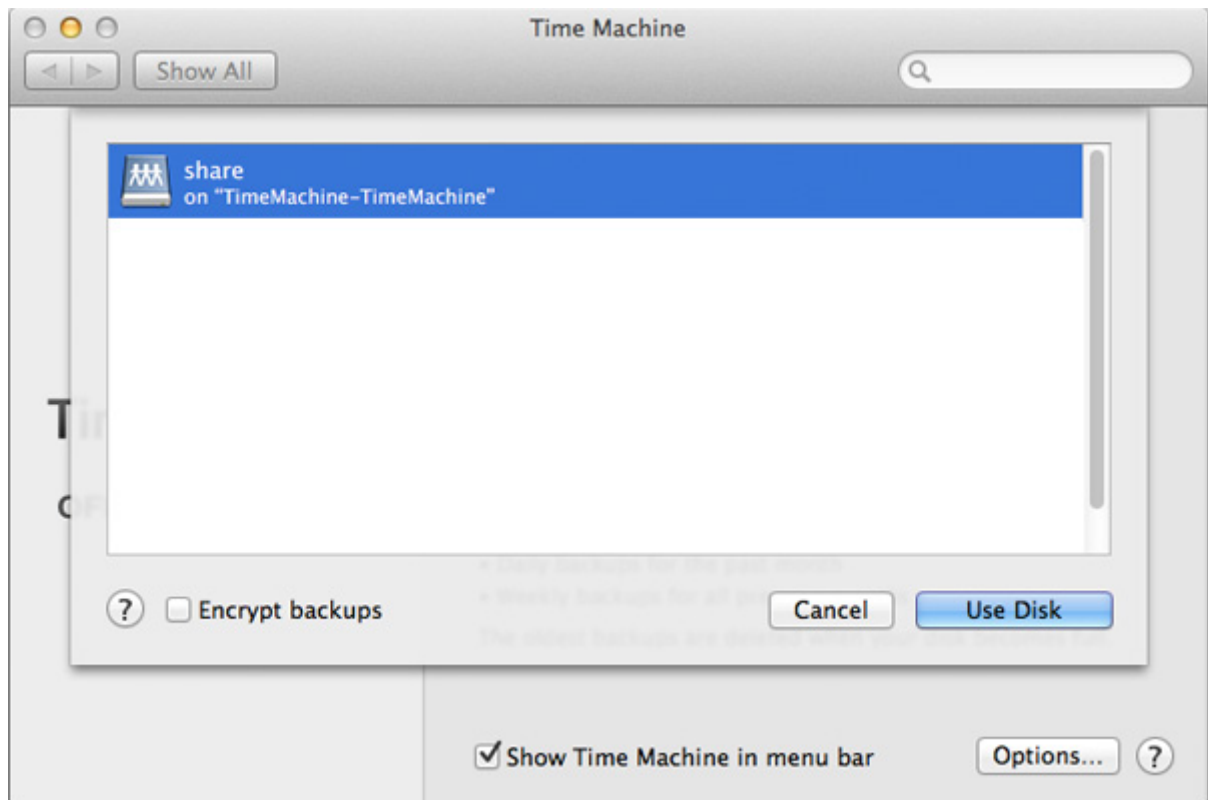

**20** Enter a username and password with the rights to access the shared folder on the LinkStation, then click *Connect*.

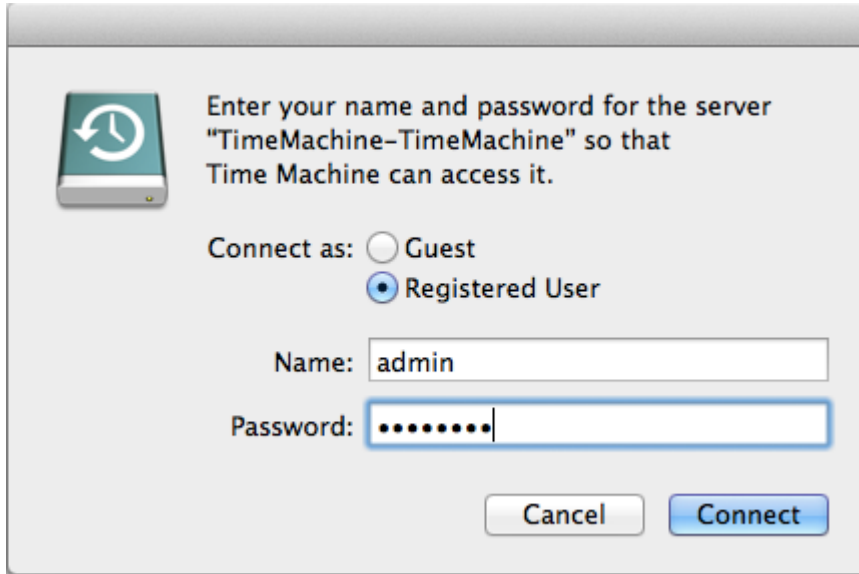

**Note:** If access restrictions are not configured on the target share, log in with the administrator account. The default username and password for the administrator account are "admin" and "password". If access restrictions are configured, log in with an account with write privileges.

**21** Time Machine will count down from 120 seconds and the backup will begin.



---

## Copying from a USB Device

---

Use Direct Copy to copy from a USB device directly to the LinkStation.

**These devices are supported:**

- USB mass storage devices



- Card readers (except for card readers that can recognize two or more memory cards)
- Digital cameras and other PTP devices

## Configuring Direct Copy from a Computer

---

**1** In Advanced Settings, click *Backup*.

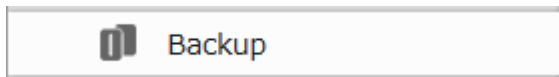

**2** Move the Direct Copy switch to the  position to enable Direct Copy.



To change the Direct Copy target folder, navigate to *Backup - Direct Copy - Edit*, select a new folder, and click *OK*.

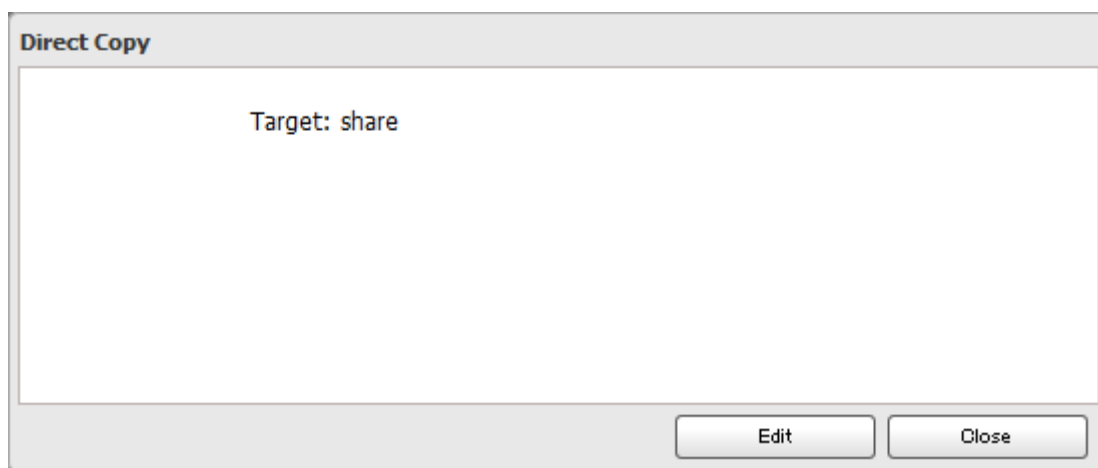

## Configuring Direct Copy from a Mobile Device

---

**1** In Settings, tap *USB Device*.



- 2** Move the Direct Copy switch to the  position to enable Direct Copy, then tap *Apply*.



The data from the USB drive will be copied to the target folder. You may change the target folder from the drop-down list if desired.

## Starting Direct Copy

---

- 1** Connect the USB device. When it mounts (about 10 seconds), the function LED will light up.

**Notes:**

- Devices that don't trigger the function LED to light up are not supported.
- When you connect PTP devices, the function LED may not light up. In such case, disconnect the PTP device from the LinkStation once, then reconnect it.

- 2** You now have 60 seconds to press the function button once. If you do, the function LED will flash as all the files on the USB device are copied to the Direct Copy folder of the LinkStation.

**Notes:**

- While the function LED is flashing, press the function button once to cancel Direct Copy.
- For digital cameras that are not in the USB mass storage class, all files from the digital camera are copied.

- 3** When the copy operation is finished, the access LED of the USB device will stop flashing. Hold down the function button for 8 seconds. The function LED will flash as all external drives are dismantled, which will take about 30 seconds. When the dismantling is finished, the function LED will stop flashing and glow steadily. You now have 60 seconds to unplug any USB drives safely.

**Note:** If accessing Settings from a mobile device, you can start Direct Copy at any time by tapping *Start Direct Copy*.

 USB Device

---

### Direct Copy

Direct Copy :  On

Target Folder

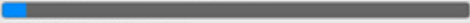
USB Drive : Connected  
  
0.2 GB / 3.7 GB

### Print Server

Print Server :  Off

# Chapter 7 Multimedia

## DLNA

DLNA is a set of guidelines for sharing digital media. The LinkStation includes a DLNA server compliant with the DLNA guidelines. Movies, photos, and music saved on the LinkStation can be played back on DLNA-compatible TVs, stereo equipment, game consoles, and other devices on the local network.

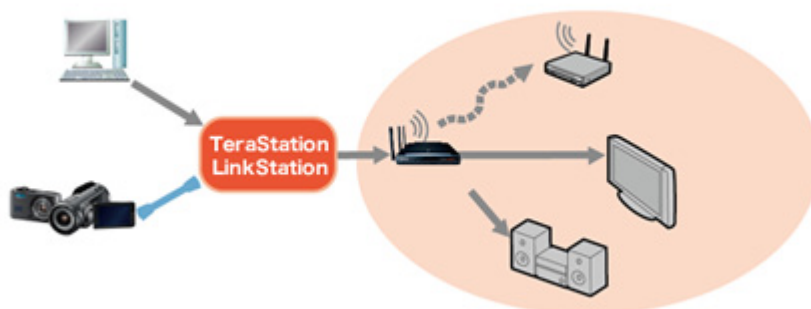

## Configuration from a Computer

### Configuration from Easy Admin

1 Click the  icon for "DLNA".

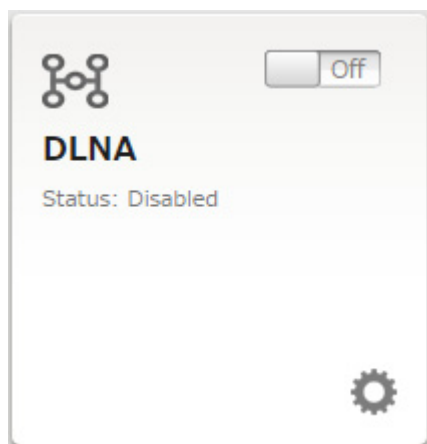

2 Move the DLNA switch to the  position to enable DLNA.



- 3** Move the switch for the folder you'll use for DLNA media to the  position as well.



- 4** Click *Apply*.

## Configuration from Advanced Settings

- 1** In Settings, click *File Sharing*.

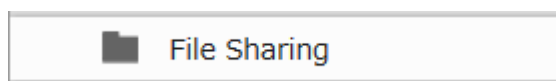

- 2** Click  to the right of "Folder Setup".



- 3** Select the folder that you want to share with media players and other DLNA-compatible devices.

- 4** Click *Edit*.

- 5** Under "LAN Protocol Support", check "DLNA" and click *OK*.

- 6** Click *Close*.

- 7** Click *Services*.

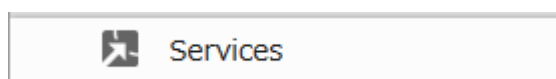

- 8** Move the DLNA switch to the  position to enable DLNA.



- 9** Click  to the right of "DLNA Server".

- 10** Click *Edit*.

- 11 Select an interval for DLNA server database updates and click *OK*.

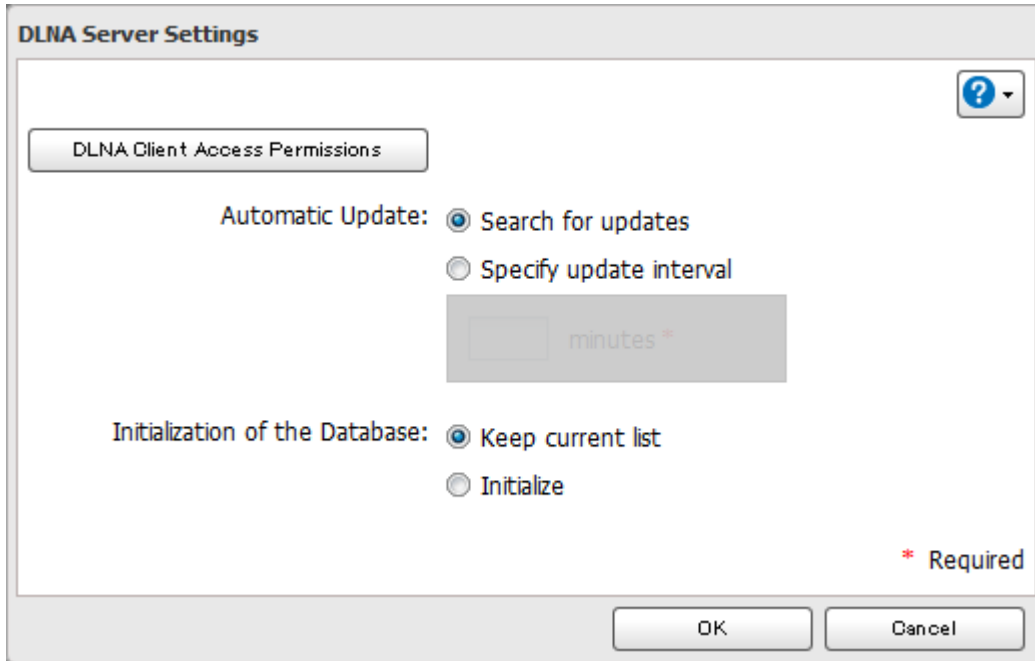

## Configuration from a Mobile Device

---

- 1 In Settings, tap *DLNA Server*.

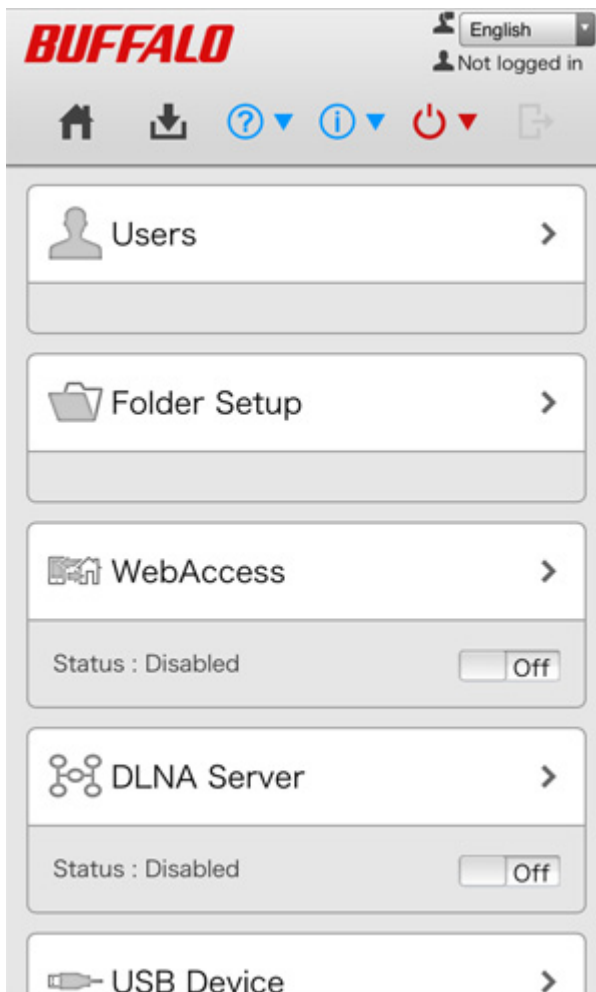

- 2 Enable the shared folder for DLNA and tap *Apply*.

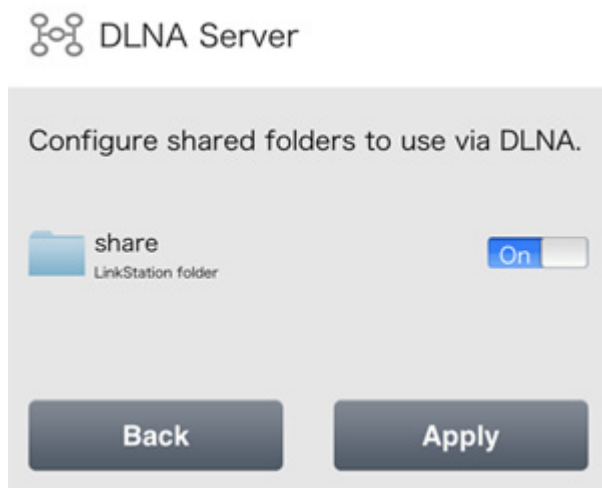

## Playing Files

---

To play back content from a DLNA-compatible device:

- 1 Connect the DLNA-compatible device to the same network as the LinkStation and turn it on.
- 2 Select the LinkStation in the software of the DLNA-compatible device.
- 3 Select the content to be played back.

**Note:** For more information on playing files, see the DLNA-compatible devices' manuals.

## Connected DLNA-compatible Devices

---

Follow the procedure below to view the DLNA-compatible devices connected to your LinkStation.

- 1 In Advanced Settings, click *Services*.



- 2 Click  to the right of "DLNA Server".

- 3 Click *DLNA Client Access Permissions*.



- 4** A list of the MAC addresses, IP addresses, and device names of the DLNA-compatible devices connected to the same network as the LinkStation is displayed. If your device is not listed, click *Refresh Database*.

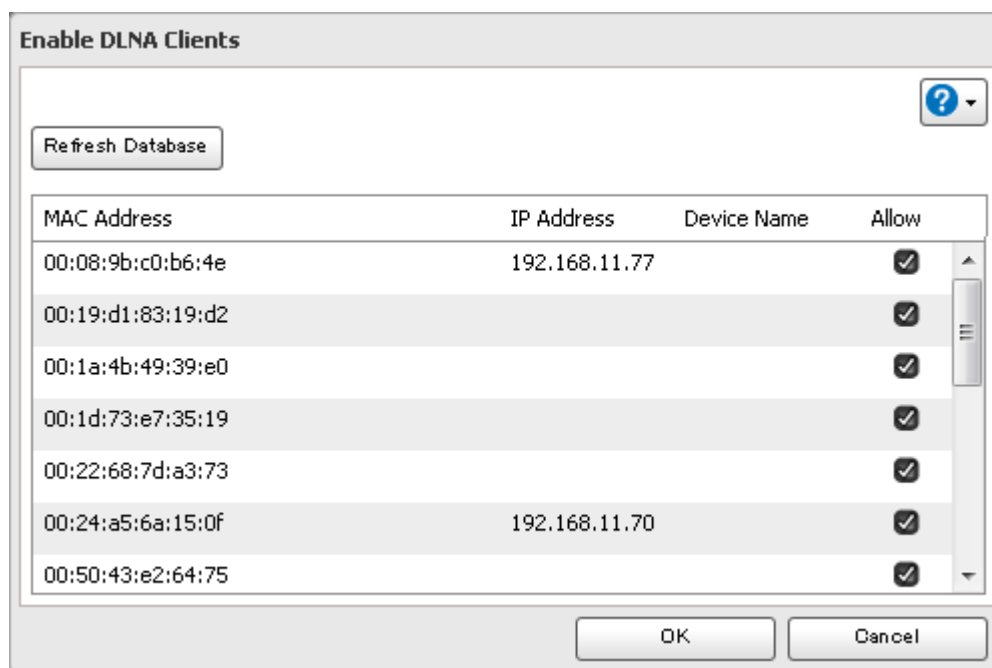



## Streaming to DLNA-compatible Devices

---

When new movies, photos, and music files are added to the LinkStation's DLNA folder, the database must be updated before the new files can be streamed. By default, the database is updated when the files are stored in the LinkStation. You can change this interval or update the database manually.

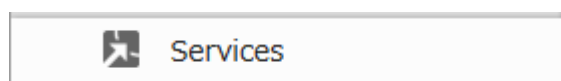
- 1** In Advanced Settings, click *Services*.



- 2** Click  to the right of "DLNA Server".

- 3** Click *Edit*.

**4** You may change the update interval, or select *Refresh Database* to update the database immediately.

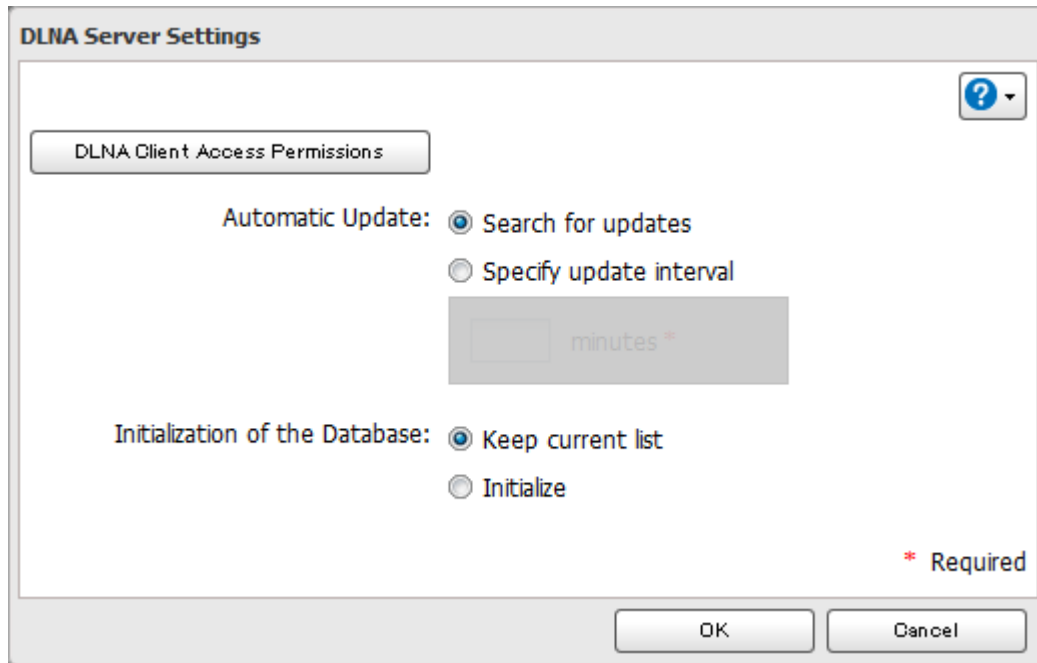

## Disabling Playback from Specific Devices

You may block specific DLNA devices from playing back media content.

**1** In Advanced Settings, click *Services*.

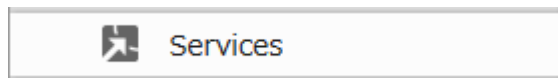

**2** Click  to the right of "DLNA Server".

**3** Click *DLNA Client Access Permissions*.

**4** Uncheck any devices you do not want to allow to play media and click *OK*.

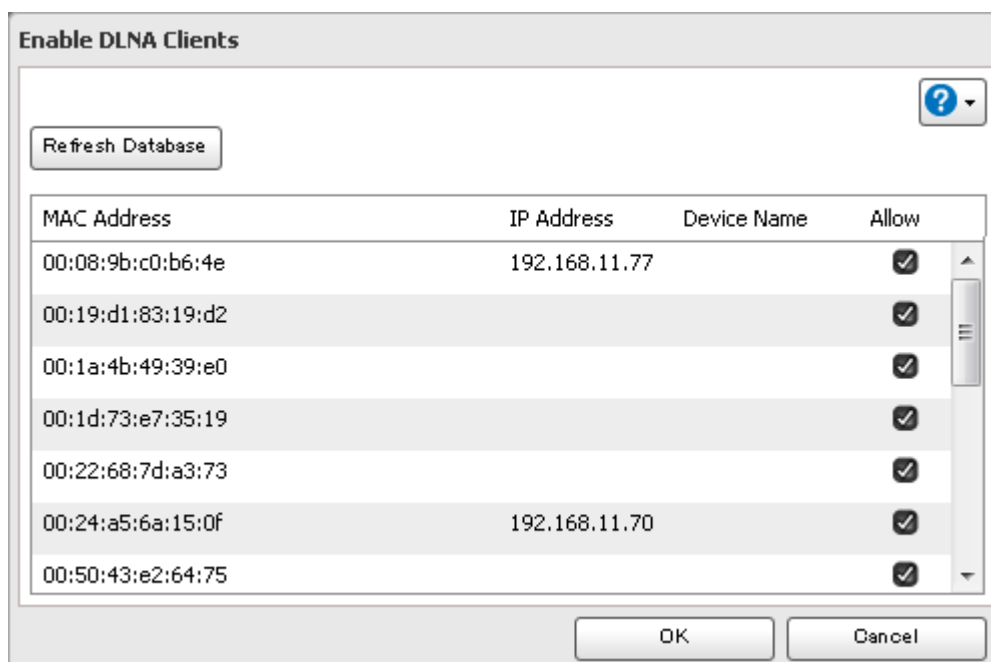

## Supported File Types

The LinkStation supports DLNA streaming of files with the extensions below.

Type	File Extensions
Video Files	mpe, mpeg, mpeg2, mpg, m2p, tts, m2ts, m2t, mts, m1v, m4v, mp4, mov, wmv, avi, divx, xvid, asf, dvr-ms, vob, 3gp, vdr, spts, tp, ts
Picture Files	jpg, jpeg, png, bmp, gif, tif, tiff, yuv
Music Files	mp3, wma, wav, lpcm, pcm, ogg, m4a, mp4, 3gp, flac, m3u, mpa, aac, apl, ac3, aif, aiff, mp2, mp1, dsf, dff

---

## iTunes Server

---

If the iTunes server is enabled, computers on your network with iTunes can play music files stored on the LinkStation and transfer them to your iOS devices. The iTunes server supports playback from up to five computers.

- 1 In Advanced Settings, click *Services*.



- 2 Click  to the right of "iTunes Server".

- 3 Click *Edit*.

- 4 Click *Browse*.

- 5 Select the shared folder that you want to make available to iTunes, then click *OK*.

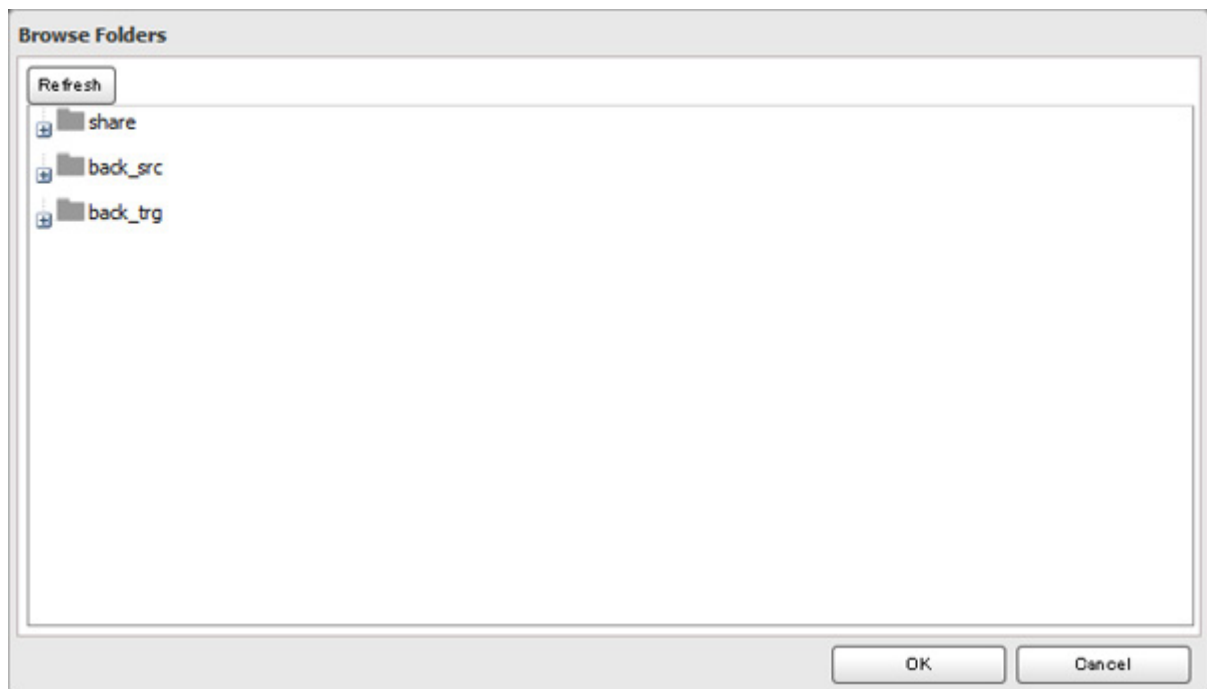

- 6 Click *OK*.

**7** Make sure that the iTunes server is enabled. The iTunes server switch should be in the  position.



---

## BitTorrent

---

BitTorrent is a protocol for distributing large amounts of data efficiently. The information in this chapter is for users who are familiar with BitTorrent.

### Configuration from Easy Admin

**1** Click *BitTorrent*.

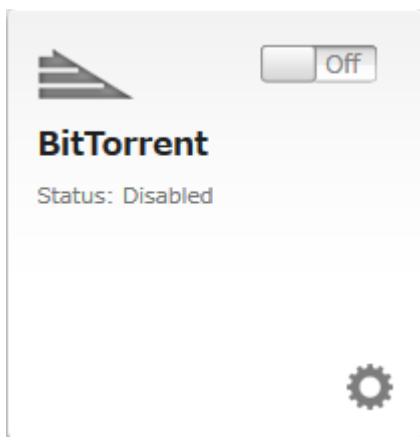

**2** Move the BitTorrent switch to the  position to enable BitTorrent.

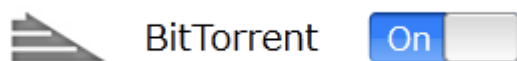

**3** Select the shared folder to save files downloaded via BitTorrent from the drop-down list, then click *Apply*.

### Configuration from Advanced Settings

**1** In Advanced Settings, click *Applications*.

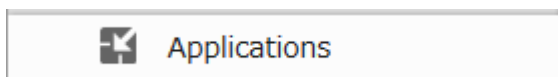

**2** Click  to the right of "BitTorrent".



**3** Click *Edit*.

**4** Click *Browse*.

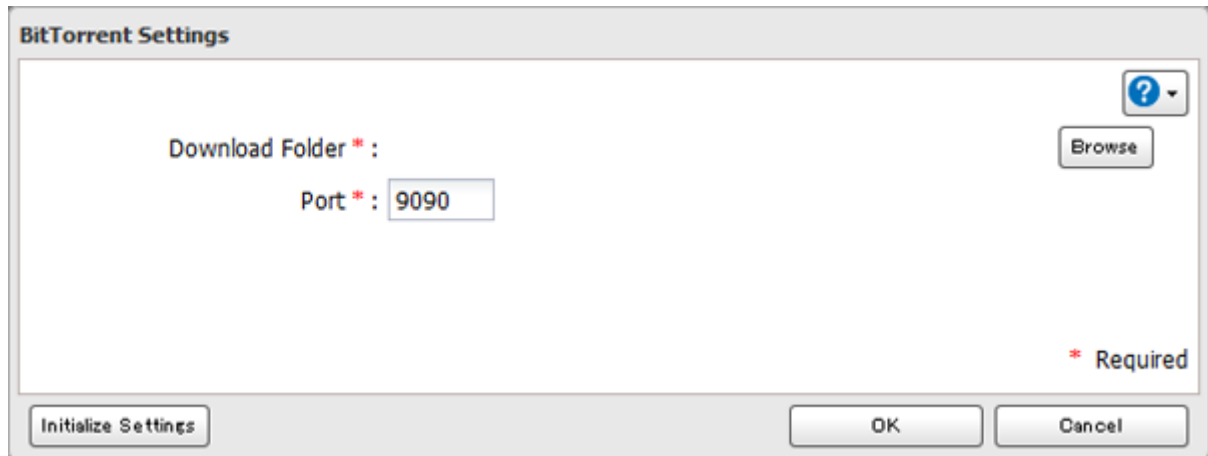

**5** Select the shared folder where the downloaded file will be saved, then click *OK*.

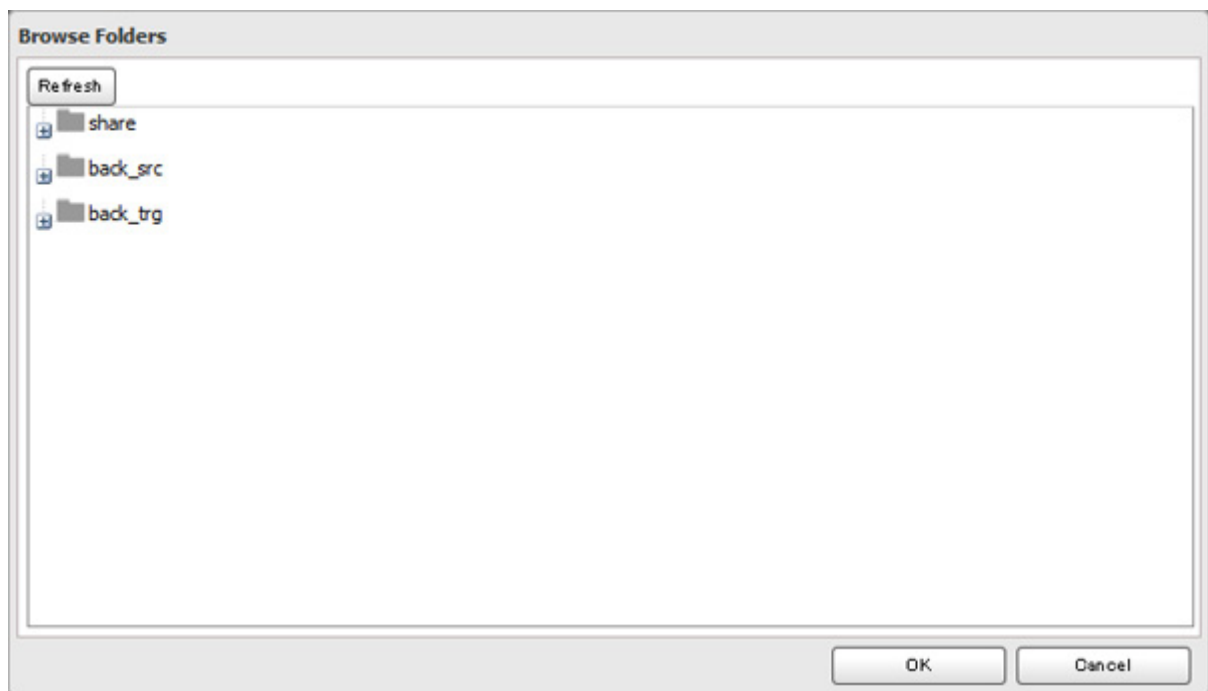

**6** Enter the port number, then click *OK*.

**7** Move the BitTorrent switch to the  *On* position to enable BitTorrent.



## **Opening Download Manager**

**Note:** The default username is "admin" and the default password is blank (no password).

## Opening from Easy Admin

1 Click *BitTorrent*.

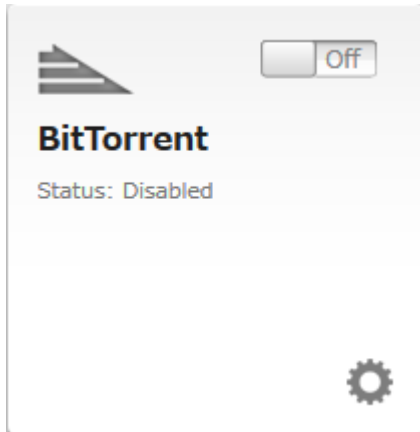

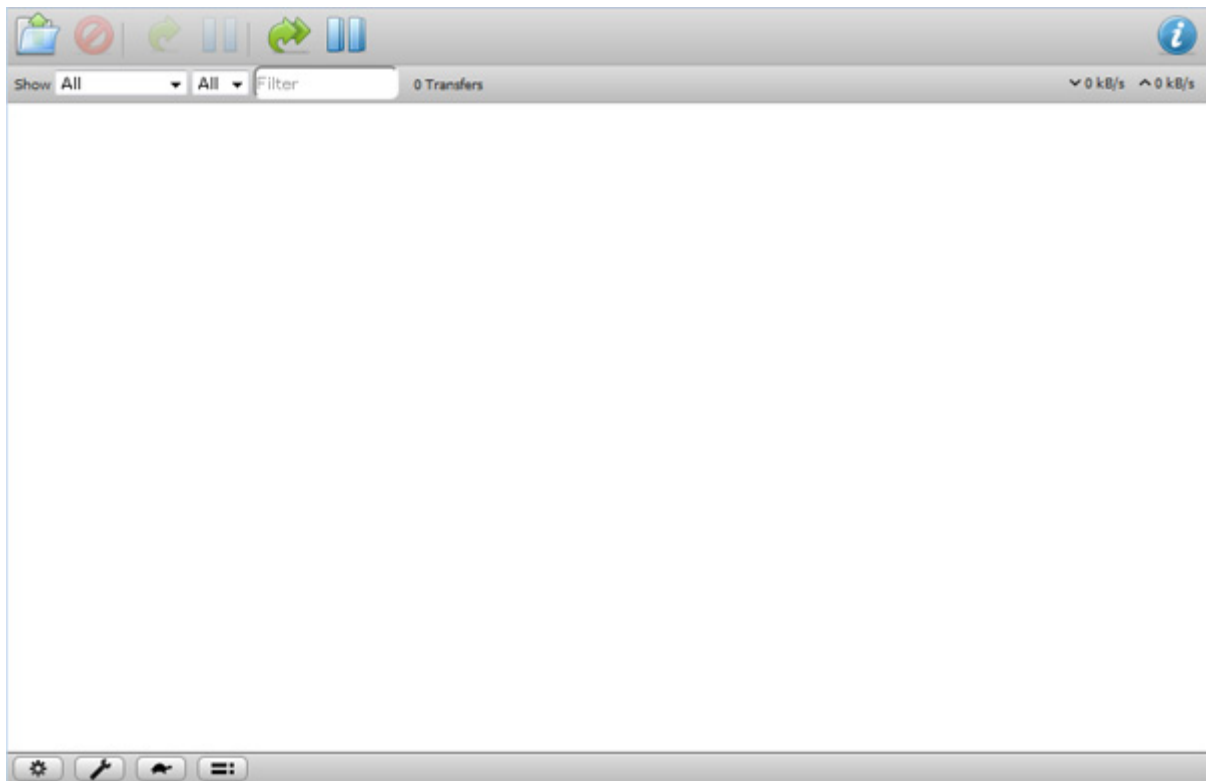

2 The download manager will open.

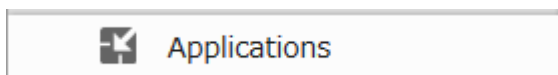

## Opening from Advanced Settings

1 In Advanced Settings, click *Applications*.



2 Click  to the right of "BitTorrent".



**3** Click *Open Download Manager*.

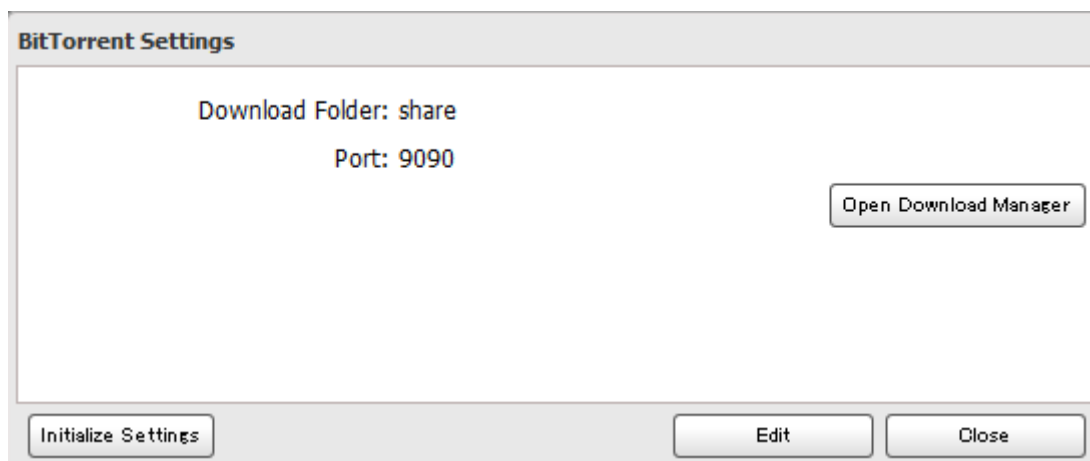

**4** The download manager will open.

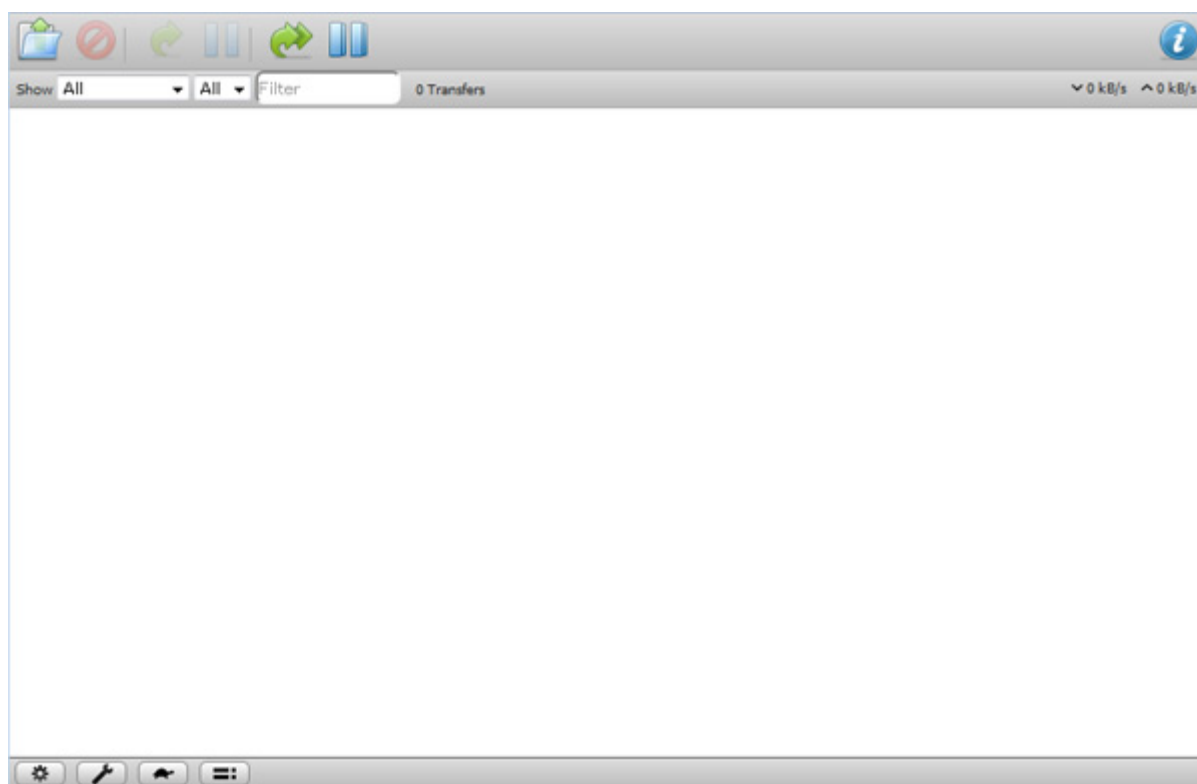

## Downloading Files

---

**1** Open the download manager.



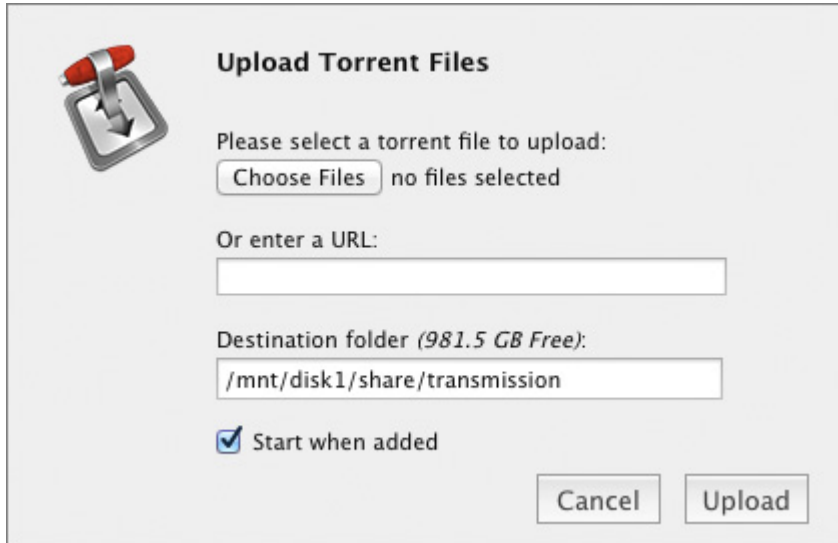

**2** Click the  icon.

- 3** Enter the URL at "Or enter a URL:" and click *Upload*. The downloaded file will be saved in the folder that is specified in the "Destination folder" field.



**Note:** Check "Start when added" to start downloading immediately after clicking *Upload*.

- 4** The download will start.

**Note:** To cancel downloading, click  and *Remote*. Click  to pause the download. Click  or  to resume.

---

## Connecting a Printer

---

You can connect a printer to the USB port on the LinkStation.

**Notes:**

- Only one USB printer can be connected to the LinkStation.
- Bidirectional communication is not supported i.e., remaining ink quantities and other printer status information is not supported.
- Don't disable the SMB protocol while the print server is enabled. If you do, you will need to enable SMB again and reconfigure the print server from scratch.

---

## Setting Up a Printer from a Computer

---

- 1** Connect a printer to the LinkStation's USB port, then turn the printer on.

- 2** In Advanced Settings, click *Services*.



- 3** Move the print server switch to the  position to enable the print server.

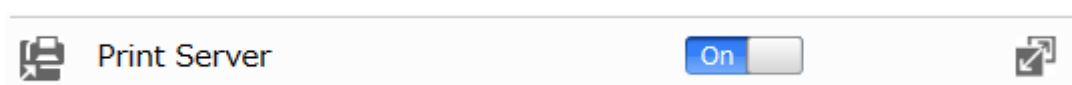

- 4** Refer to the manual supplied with the printer and install the printer drivers.



- 5 Launch NAS Navigator2. Double-click your LinkStation's icon.
- 6 Double-click the icon of the connected printer (shared name is displayed).
- 7 Click *OK*.
- 8 Select your printer, then click *OK*.
- 9 Register the printer.

## Setting Up a Printer from a Mobile Device

---

- 1 Connect a printer to the LinkStation's USB port, then turn the printer on.
- 2 In Settings, tap *USB Device*.

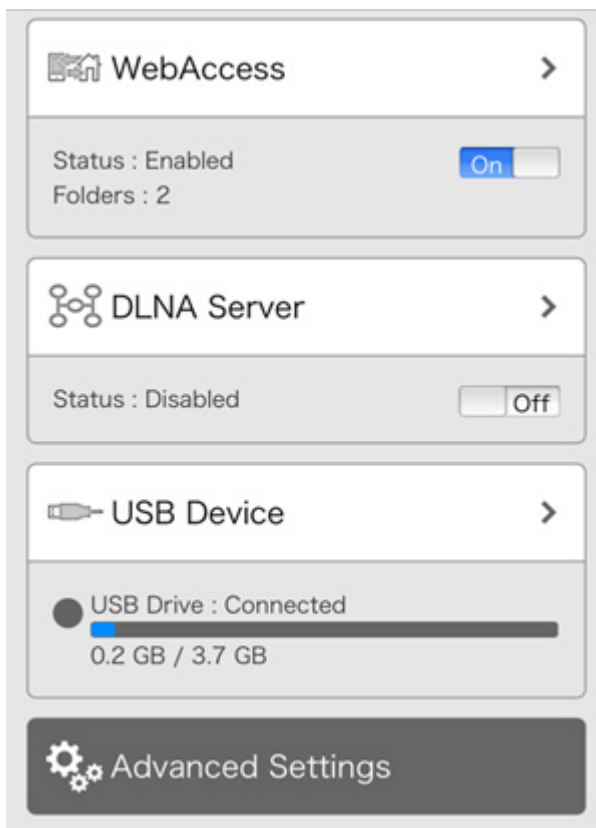

- 3 Move the print server switch to the  position to enable the print server.



- 4 Tap *Apply*, then *OK*.

# Chapter 8 Advanced Features

## Email Notification

Your LinkStation can send you email reports daily, or when settings are changed or an error occurs. Notification emails may be triggered by any of the following events:

- Scheduled hard drive status notification (includes quota exceeded notification)
- Fan error (LS220D and LS220DE only)
- Backup job completed
- Hard drive read error

**1** In Advanced Settings, click *Management*.

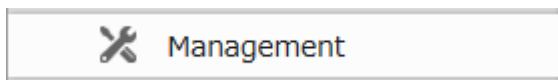

**2** Move the email notification switch to the  position to enable email notification.



**3** Click  to the right of "Email Notification".

**4** Click *Edit*.

**5** Enter your mail server settings and choose what events will trigger notification. Click *OK* to send a test email.

The screenshot shows the 'Email Notification' configuration window. It contains the following fields and options:

- SMTP Server Address \*: [Text Input]
- SMTP Port \*: 25 [Text Input]
- Authentication Type: Disable [Dropdown Menu]
- POP3 Server Address: [Text Input]
- POP3 Port: 110 [Text Input]
- SSL/TLS: Disable [Dropdown Menu]
- Username: [Text Input]
- Password: [Text Input]
- Subject \*: LinkStation Status Report [Text Input]
- Buttons: Add, Delete, Select from List
- Recipient(s) \*: [Table with columns: Name, Recipient(s), Class]
- Buttons: Select All, Unselect All
- System:  HDD status report 00 [Dropdown] Hour
- Fan error
- Disk error
- Backup complete
- \* Required
- Buttons: OK, Cancel

## Sleep Mode

To save energy, you can specify times to put the LinkStation into sleep (standby) mode, where the hard drive and LEDs are turned off.

**1** In Advanced Settings, click *Management*.

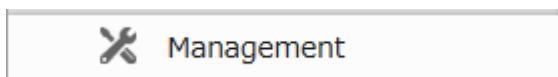

**2** Click  to the right of "Sleep Timer".



**3** Click *Edit*.

#### 4 Specify the timer interval, wake-up time, and time to go into sleep mode, then click OK.

The screenshot shows the 'Sleep Timer Settings' dialog box. It is divided into three sections for Timer 1, Timer 2, and Timer 3. Each section has a 'Schedule' dropdown menu, a set of checkboxes for days of the week, and two time pickers for 'Wake Up at' and 'Begin Sleep at'. Timer 1 is configured with a 'Weekly' schedule, all days checked, a wake-up time of 09:00, and a begin sleep time of 18:00. Timer 2 and Timer 3 are set to 'Disable' with no days selected and 00:00 for both wake-up and begin sleep times. The dialog box has 'OK' and 'Cancel' buttons at the bottom right.

#### Notes:

- Up to three timers can be set.
- The time to enter sleep mode can be set from 0:00 am to 3:45 of the next day.  
The time to wake from sleep mode can be set from 0:00 to 23:45.  
If the time to enter sleep mode is after 24:00, the wake-up time setting may be from 4:00 am to 23:45.
- The time to enter sleep mode should not be set at the same time as or before the wake-up time.
- If a backup job is scheduled during a disk check, disk format, backup job or within 5 minutes of the current time, the LinkStation will not change to standby mode when the time to enter sleep mode is reached.
- If the scheduled times in the timer overlap, operation is performed using the widest time interval.
- Examples of multiple timer settings are shown below.

#### Example 1:

If running at a current time of 10:00 Wednesday

Timer 1: Daily 12:00–24:00

Timer 2: Not used

Timer 3: Not used

No operation is performed at 12:00 and the unit goes into sleep mode at 24:00.

#### Example 2:

When running at a current time of 10:00 Wednesday

Timer 1: Daily 9:00–18:00

Timer 2: Wednesday 10:00–20:00

Timer 3: Not used

On days other than Wednesday, normal operation begins at 9:00 and the unit goes into sleep mode at 18:00.

On Wednesday, the unit goes into sleep mode at 20:00.

#### Example 3:

If running at the current time of 10:00 Wednesday

Timer 1: Daily 9:00–18:00

Timer 2: Wednesday 10:00–3:00 the next day

Timer 3: Not used

On days other than Wednesday, normal operation begins at 9:00 and the unit goes into sleep mode at 18:00.  
On Wednesday, normal operation begins at 9:00 and the unit goes into sleep mode at 1:00 the next day.

**Example 4:**

When running at a current time of 10:00 Wednesday

Timer 1: Daily 9:00–18:00

Timer 2: Wednesday 7:30–22:00

Timer 3: Not used

On days other than Wednesday, normal operation begins at 9:00 and the unit goes into sleep mode at 18:00.

On Wednesday, normal operation begins at 7:30 and the unit goes into sleep mode at 22:00.

- To turn on the LinkStation before the wake-up time when it is in sleep mode, press the function button.

---

## Encrypting Data Transmission

---

### Encrypting Settings Data

---

All communication with Settings can use SSL encryption if you access Settings through <https://>.

### Encrypting FTP Transfer Data

---

You can encrypt passwords and files using SSL/TLS for secure FTP communication. First, open a shared folder's settings and click *Edit*; under "LAN Protocol Support", check "FTP" and click *OK*. Enable SSL security in the setup screen for your FTP client. The procedure depends on the FTP client software.

### SSL Encryption

---

SSL is a cryptographic protocol for communication security and data confidentiality over the Internet. To use SSL, you will need a certificate and a key. These are available from web hosting services and many private privacy providers.

### Configuring SSL

To enter or update a server certificate and private key for SSL, following this procedure.

- 1 Navigate to *Management - SSL*.
- 2 Enter or browse to the locations of the key and certificate, then click *Import*.

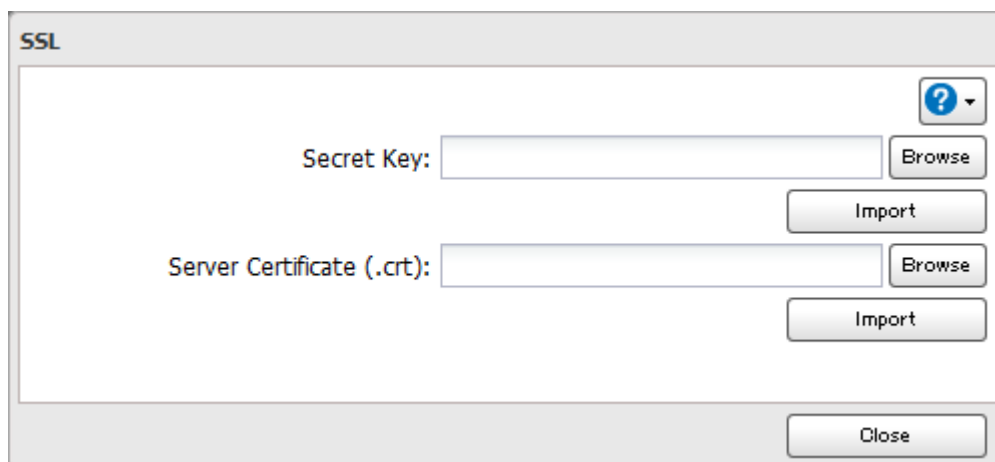

---

## Restoring Factory Defaults

---

To initialize the LinkStation to its factory default settings, follow this procedure.

### Initializing from Settings

---

- 1** In Advanced Settings, click *Management*.

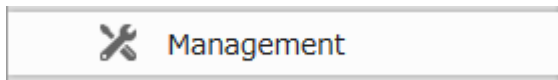

- 2** Click  to the right of "Restore/Erase".



- 3** Click *Initialize LinkStation*.

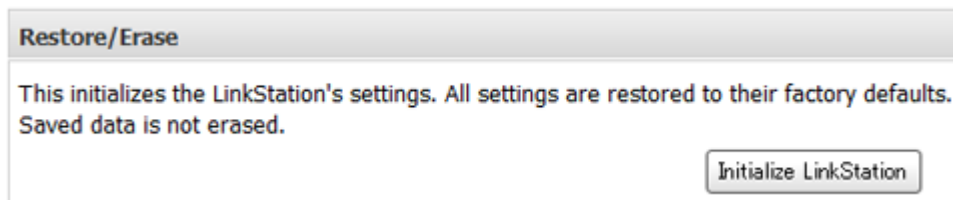

- 4** The "Confirm Operation" screen will open. Enter the confirmation number, then click *OK*.

- 5** The LinkStation will be restored to its factory default settings.

### Initializing with the Function Button

---

You can also initialize the settings with the function button.

- 1** Turn off the LinkStation.
- 2** Turn the LinkStation on while holding down the function button. The function LED will flash white.
- 3** Press the function button again while the LED is flashing.
- 4** Initialization will take 5 to 10 minutes. Do not power down the LinkStation while it is initializing and showing an I23 information message in NAS Navigator2 and with the power LED. When initialization is finished, the LinkStation will automatically reboot.

**Notes:**

- The following settings will be initialized: admin username, admin password, IP address, and Ethernet frame size.
- To disable initializing username and password, navigate to *Management - Restore/Erase - Edit* and change "Restore factory default settings" to "Keep current settings". Be careful with this option! If this is selected and you lose your admin password, you will not be able to reset it.

---

## Online Update

---

If a new firmware is available, a message is displayed when the LinkStation boots. You can update the firmware as follows:

**1** In Advanced Settings, click *Management*.



**2** Click  to the right of "Update".



**3** Click *Install Update*.

**Notes:**

- Settings is not available while the firmware is updating. Don't try to access Settings from another computer until the update is complete.
- You can disable update notifications in *Management - Update*.
- To clear an update notification, press the function button.

---

## Name, Date, Time, and Language

---

Configure the LinkStation's hostname, date, time, and language as follows.

**1** In Advanced Settings, click *Management*.

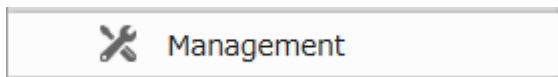

**2** Click  to the right of "Name/Time/Language".



**3** Click *Edit*.

- 4 Click the *Name* tab and configure the LinkStation's name and description.

The screenshot shows a configuration window titled "Name/Time/Language". It has four tabs: "Name", "Time", "Language", and "Management Information". The "Name" tab is selected. The "Name" field contains "LS210DCBF" and the "Description" field contains "LinkStation". A red asterisk and the word "Required" are visible at the bottom right of the form area. "OK" and "Cancel" buttons are at the bottom.

- 5 Click the *Time* tab. Enable NTP server and check "Use Local Date/Time" to use your computer's time settings for the LinkStation.

The screenshot shows the same configuration window, but the "Time" tab is selected. Under "Date/Time Source:", the "Enable" radio button is selected. The "NTP IP Address" field contains "ntp.jst.mfeed.ad.jp". The "Use Default NTP Server" checkbox is checked. The "NTP Synchronization Frequency" dropdown is set to "Daily". The "Disable" radio button is unselected. The "Date" field shows "10/23/2013" and the "Time" field shows "10 : 46 : 52". A "Use Local Date/Time" button is present. The "Time Zone" dropdown is set to "(UTC+09:00) Osaka, Sapporo, Tokyo". A red asterisk and the word "Required" are visible at the bottom right of the form area. "OK" and "Cancel" buttons are at the bottom.

By default, the LinkStation adjusts its clock automatically by using a default NTP server. This NTP server belongs to Internet Multi Feed Inc. For more information, visit <http://www.jst.mfeed.ad.jp>.

To use a different NTP server, navigate to *Management - Name/Time/Language*. Click *Time*, then *Edit*. Uncheck "Use Default NTP Server" and enter a new NTP IP address. Click *OK*.



If NTP is not used, enter the time and date manually. Click *Use Local Date/Time* to import the time and date from your computer.

If an NTP server is specified by name instead of IP address, make sure that a DNS server is configured for the LinkStation.

**Note:** The internal clocks of the LinkStation and other devices on your network may run at slightly different speeds. Over a long period of time your network devices may show somewhat different times, which can cause network problems. If clocks on your network vary by more than 5 minutes it may cause unexpected behavior. For best results, keep all clocks on the network set to the same time by adjusting them regularly, or use an NTP server to correct them all automatically.

**6** Click the *Language* tab. Select the language to be used in the Windows client, then click *OK*.

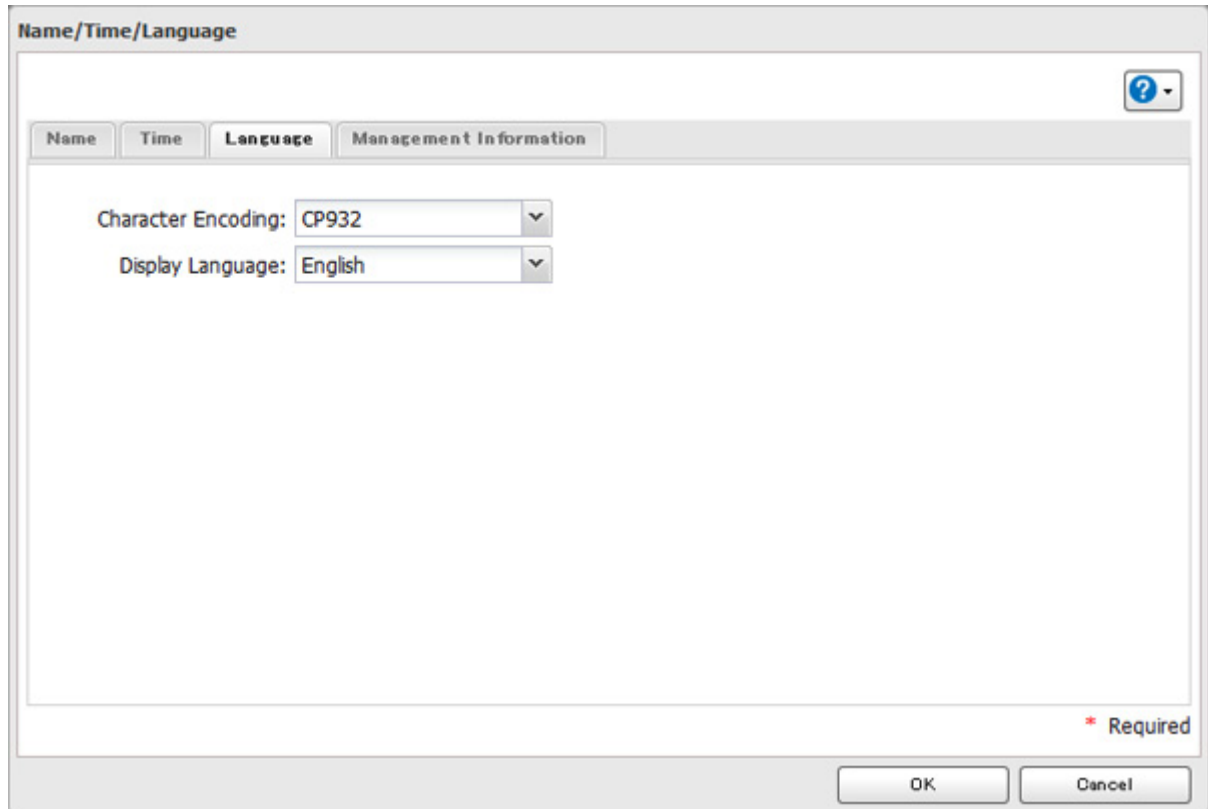

**Note:** This tab changes the language used by the LinkStation for email notification, DLNA, and other functions. To change the language displayed in Settings, go to Advanced Settings or Easy Admin and click *Language* in the menu bar. Choose your desired language from the drop-down menu.

---

## Jumbo Frames

---

If your other network devices support it, you may be able to increase network performance with jumbo frames.

**1** In Advanced Settings, click *Network*.

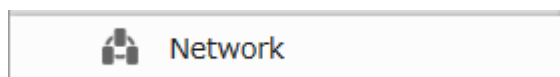

**2** Click  to the right of "IP Address".





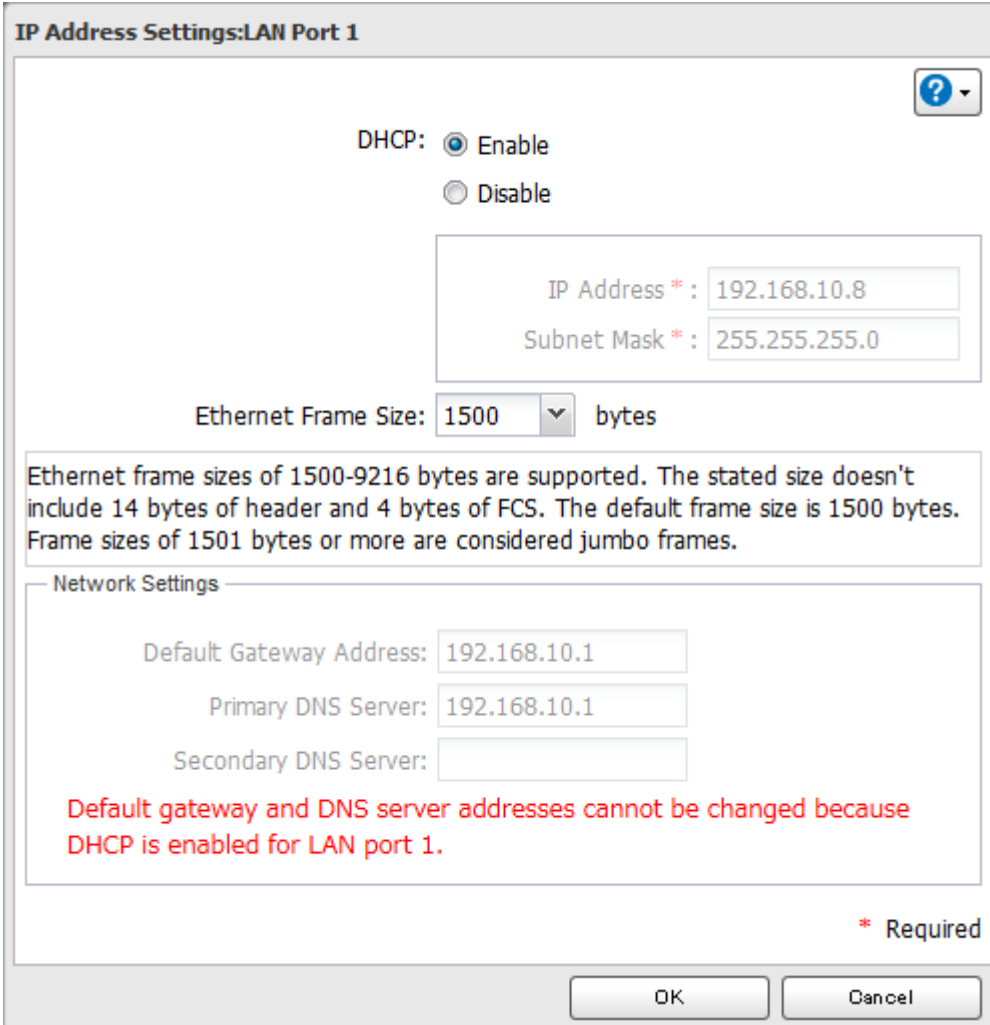

**3** Click the LAN port where the jumbo frames will be used.

**4** Select your desired Ethernet frame size and click *OK*.



The image shows a dialog box titled "IP Address Settings:LAN Port 1". It contains the following elements:

- A help icon (question mark in a blue square) in the top right corner.
- DHCP settings: "DHCP:" followed by two radio buttons, "Enable" (which is selected) and "Disable".
- IP Address and Subnet Mask fields: "IP Address \* : 192.168.10.8" and "Subnet Mask \* : 255.255.255.0".
- Ethernet Frame Size: "Ethernet Frame Size: 1500 bytes", where "1500" is in a dropdown menu.
- Informational text: "Ethernet frame sizes of 1500-9216 bytes are supported. The stated size doesn't include 14 bytes of header and 4 bytes of FCS. The default frame size is 1500 bytes. Frame sizes of 1501 bytes or more are considered jumbo frames."
- Network Settings section: "Network Settings" followed by three fields: "Default Gateway Address: 192.168.10.1", "Primary DNS Server: 192.168.10.1", and "Secondary DNS Server:" (empty).
- A red warning message: "Default gateway and DNS server addresses cannot be changed because DHCP is enabled for LAN port 1."
- A legend: "\* Required" in red text.
- Buttons: "OK" and "Cancel" at the bottom.

Connection			Transmission	
LinkStation	Jumbo Frame Compatible Hub	Jumbo Frame Compatible PC		Transfer data in jumbo frames.
LinkStation	Jumbo Frame Compatible Hub	Jumbo Frame <b>Incompatible</b> PC		Transfer data not using jumbo frames.
LinkStation	Jumbo Frame <b>Incompatible</b> Hub	Jumbo Frame <b>Incompatible</b> PC		Transfer data not using jumbo frames.
LinkStation	Jumbo Frame <b>Incompatible</b> Hub	Jumbo Frame Compatible PC		Any data cannot be transferred.

## Changing the IP Address

Normally, the LinkStation's IP address is set automatically from a DHCP server on your network. If you prefer, you can set it manually. An easy way to do this is to change it from NAS Navigator2 running on a computer connected to the same router (subnet) as the LinkStation. The procedure to change the IP address in Settings is below.

- 1 In Advanced Settings, click *Network*.

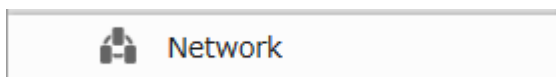

- 2 Click  to the right of "IP Address".



- 3 Click the LAN port where the IP address will be changed.

**4** Disable "DHCP", enter the desired network address settings, and click *OK*.

**IP Address Settings:LAN Port 1**

DHCP:  Enable  
 Disable

IP Address \* : 192.168.10.8  
Subnet Mask \* : 255.255.255.0

Ethernet Frame Size: 1500 bytes

Ethernet frame sizes of 1500-9216 bytes are supported. The stated size doesn't include 14 bytes of header and 4 bytes of FCS. The default frame size is 1500 bytes. Frame sizes of 1501 bytes or more are considered jumbo frames.

Network Settings

Default Gateway Address: 192.168.10.1  
Primary DNS Server: 192.168.10.1  
Secondary DNS Server:

\* Required

OK Cancel

**Note:** The following IP addresses are reserved and should not be used. If you configure one of them by accident, initialize settings with the function button on the LinkStation.

Local loopback address: 127.0.0.1, 255.255.255.0

Network address: 0.0.0.0, 255.255.255.0

Broadcast address: 255.255.255.255, 255.255.255.0

The IP address range from 224.0.0.0 to 255.255.255.255

# Chapter 9 Utilities

## NAS Navigator2 for Windows

NAS Navigator2 is a utility program that makes it easy to display Settings, change the LinkStation's IP address, or check its hard drive. If you installed the LinkStation with LinkNavigator, NAS Navigator2 was installed automatically. NAS Navigator2 will run in the system tray when the computer is on.



Double-click the  icon to start NAS Navigator2.

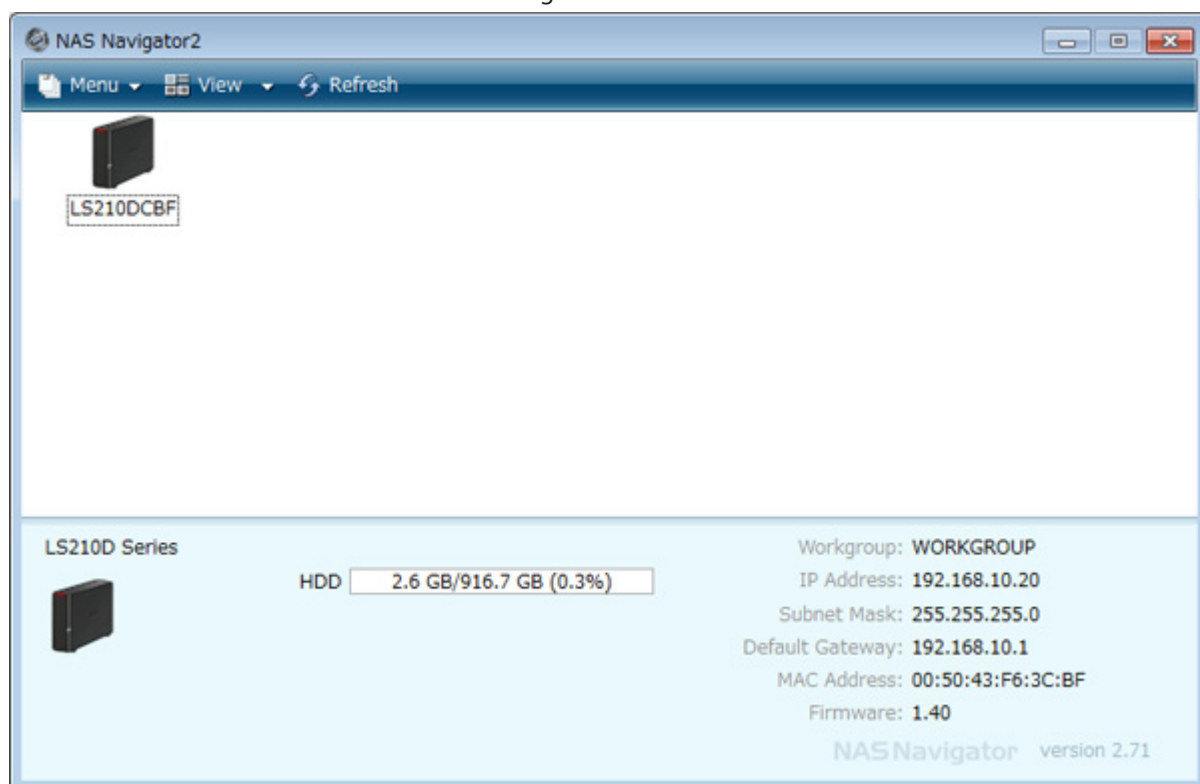

Click your LinkStation's icon to open a share on the LinkStation and display:

- Total capacity
- Capacity in use
- IP address
- Workgroup
- Subnet mask
- Default gateway
- MAC address
- Firmware version

Name		Description
Menu	Map Share*	Assigns the LinkStation's or TeraStation's shared folders as a network drive.
	Disconnect Share*	Unmaps the network drive.
	Map All Remote Shares to Drive Letters	Assigns all the LinkStations' or TeraStations' shared folders as network drives.
	Create Desktop Shortcut*	Creates a desktop shortcut to the selected LinkStation's or TeraStation's shared folders.
	Launch NAS Navigator2 on Startup	Launches NAS Navigator2 in the system tray when Windows boots.
	Display Errors	If an error occurs, an error message will pop up from the NAS Navigator2 icon in the system tray.
	Properties*	Opens the selected LinkStation's or TeraStation's properties page.
	Close	Closes NAS Navigator2.
	View	Icons: Displays icons. Details: Displays hostname, product name, workgroup, IP address, subnet mask, and default gateway.
	Sort by	If you have multiple LinkStations and TeraStations on the network, you may choose to display them in order of hostname, product name, workgroup, IP address, subnet mask, or default gateway.
Browse*		Opens the selected LinkStation's or TeraStation's shared folders.
Refresh		Searches for NAS devices on the network again.
Displays when you right-click a device's icon.	Browse Shares	Opens the selected LinkStation's or TeraStation's shared folders.
	Settings	Opens Settings for the selected LinkStation or TeraStation.
	Properties	Opens the selected LinkStation's or TeraStation's properties page.
	Map Share	Assigns the LinkStation's or TeraStation's shared folders as a network drive.
	Disconnect Share	Unmaps the network drive.
	Create Desktop Shortcut	Creates a desktop shortcut to the selected LinkStation's or TeraStation's shared folders.

\*Click on the selected LinkStation's or TeraStation's icon to display these options.

When NAS Navigator2 is minimized, right-click on the NAS Navigator2 icon in the system tray for the following options.

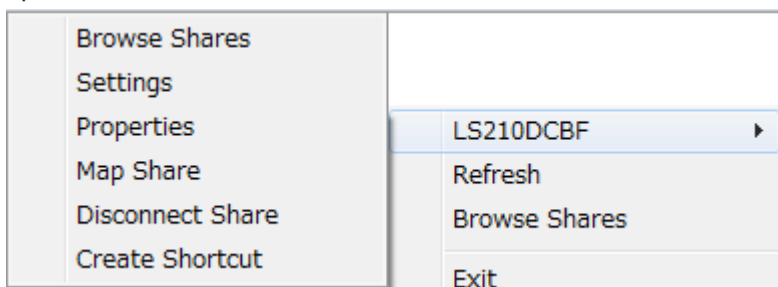

Name		Description
NAS Name	Browse Shares	Opens the selected LinkStation's or TeraStation's share folders.
	Settings	Opens Settings for the selected LinkStation or TeraStation.
	Properties	Opens the selected LinkStation's or TeraStation's properties page.
	Map Share	Assigns the LinkStation's or TeraStation's shared folders as a network drive.
	Disconnect Share	Unmaps the network drive.
	Create Shortcut	Creates a desktop shortcut to the selected LinkStation's or TeraStation's shared folders.
Refresh		Refreshes list of NAS devices.
Browse Shares		Displays NAS Navigator2 window.
Exit		Exits NAS Navigator2.

The following tasks may be performed from the LinkStation's or TeraStation's properties page.

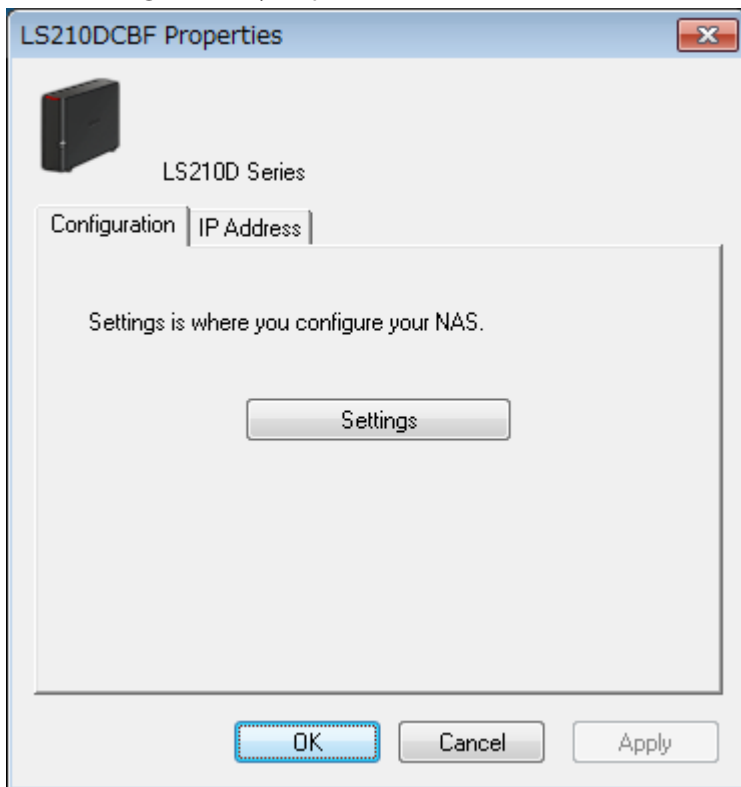

Name	Description
Configuration	Click <i>Settings</i> to open the configuration interface.
IP Address	Check <i>Use DHCP</i> to assign an IP address from the DHCP server automatically. If there is no DHCP server in the network, you cannot use this function. Check <i>Renew IP address</i> to obtain an IP address from the DHCP server. You can manually enter an IP address, subnet mask, and default gateway.

## Mounting as a Network Drive

You can easily map a shared folder as a network drive using NAS Navigator2.



1 Double-click the  icon to start NAS Navigator2.

2 Right-click on the LinkStation's icon and choose *Map Share*.

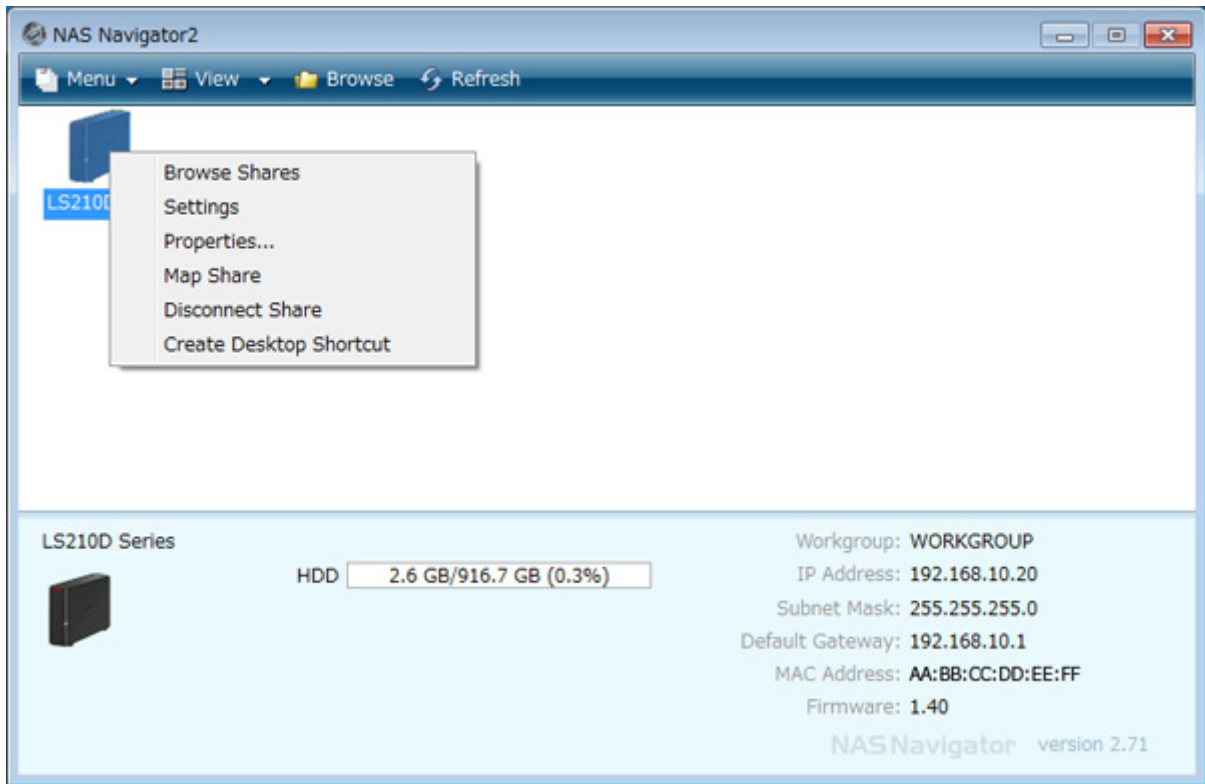

**Note:** The following shared folders can be mounted as network drives from NAS Navigator2: share, share2, share3, share4, usbdisk1, usbdisk2, usbdisk3, usbdisk4, usbdisk5

3 An icon for the mapped share will appear in Computer or My Computer. You can use this network drive just like any other hard drive.



## Changing the IP Address

---



1 Double-click the  icon to start NAS Navigator2.

2 Right-click on your LinkStation's icon and choose *Properties - IP Address*.



- 3** Uncheck "Use DHCP"; enter the IP address and subnet mask, and click *OK*. If the username and password prompts appears, enter the admin username and password.

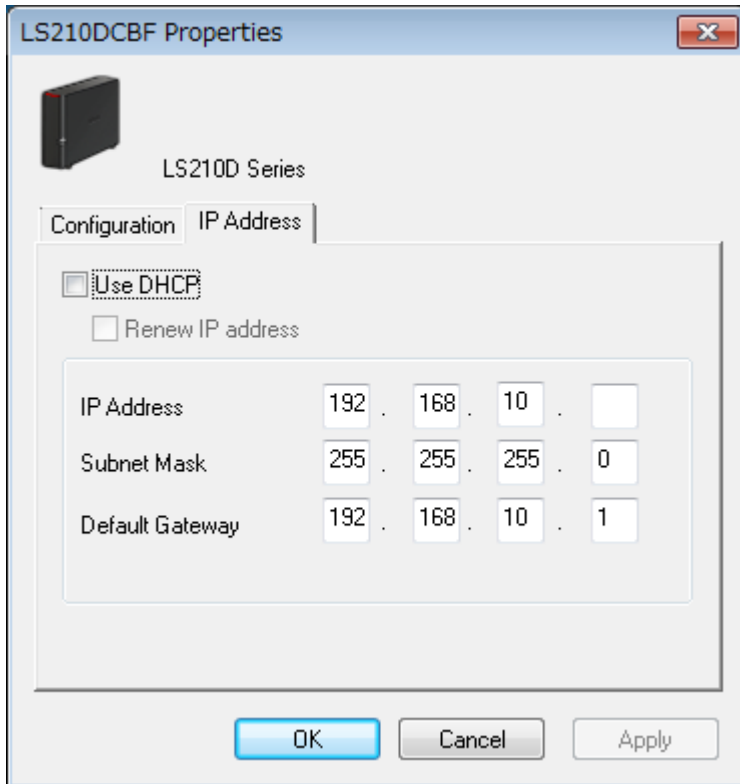

**Note:** The following IP addresses are reserved and should not be used. If you configure one of them by accident, initialize settings with the function button on the LinkStation.

Local loopback address: 127.0.0.1, 255.255.255.0  
Network address: 0.0.0.0, 255.255.255.0  
Broadcast address: 255.255.255.255, 255.255.255.0  
The IP address range from 224.0.0.0 to 255.255.255.255

---

## NAS Navigator2 for macOS

---

NAS Navigator2 is a utility that makes it easy to display Settings, change the LinkStation's IP address, or check its hard drive. If you installed the LinkStation with LinkNavigator, NAS Navigator2 was installed automatically.



Click the  icon in the Dock to start NAS Navigator2.

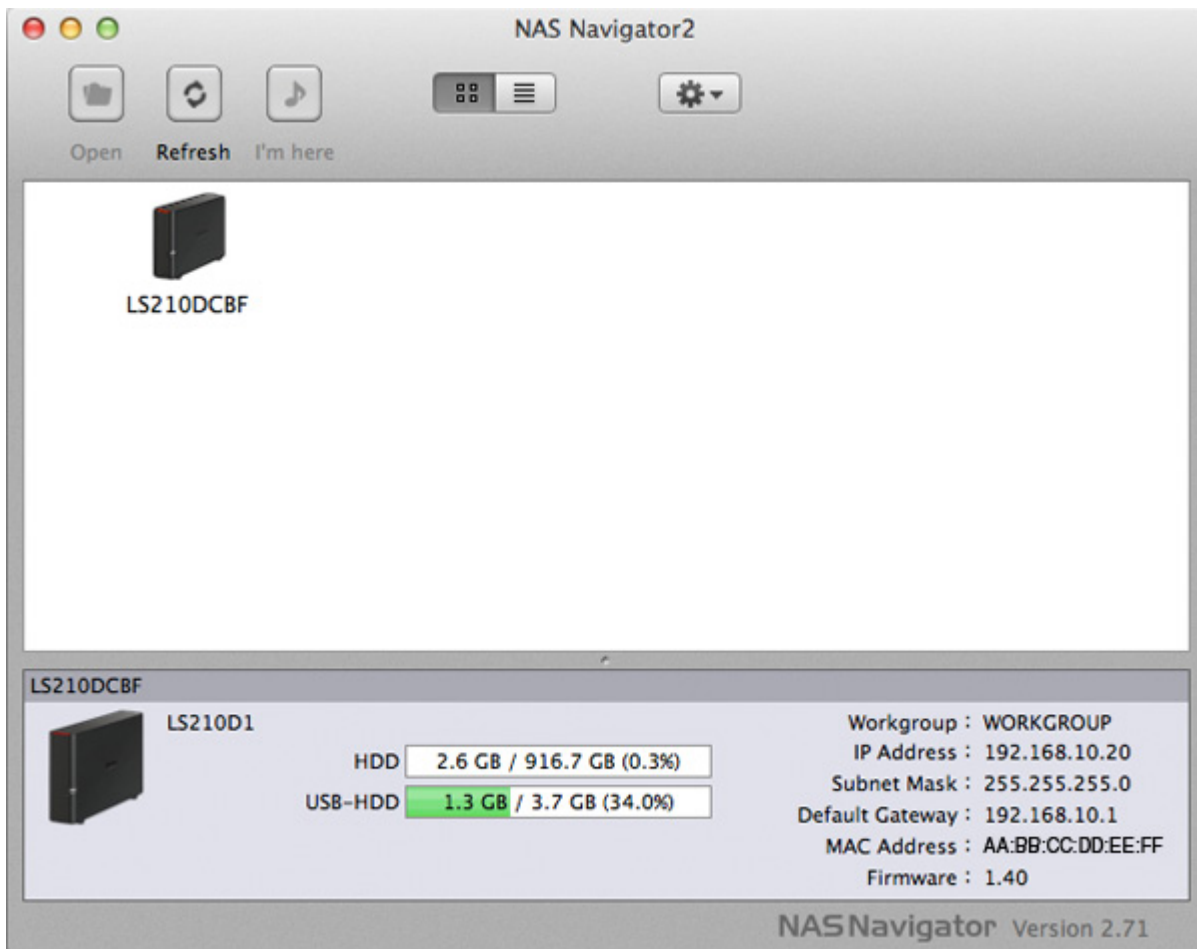

Click your LinkStation's icon to open a share on the LinkStation and display:

- Total capacity
- Capacity in use
- IP address
- Workgroup
- Subnet mask
- Default gateway
- MAC address
- Firmware version

Name	Description
Open	Opens the default shared folder for a selected LinkStation or TeraStation.
Refresh	Searches for NAS devices on the network again.
Settings	Opens Settings for the selected LinkStation or TeraStation.
Configure	Opens a window that lets you configure the NAS's IP address or open Settings.
Label Color	Selects the color of the name displayed below the icon.
View Options	Lets you choose icon size, position, and view mode.
Auto Power Mode	Auto power mode can turn supported TeraStations and LinkStations on the network on and off automatically.

Name	Description	
To display these options, hold down the control key and click a device's icon.	Open Folder	Opens the selected LinkStation's or TeraStation's shared folder.
	Settings	Opens Settings for the selected LinkStation or TeraStation.
	Configure	Opens a window that lets you configure the NAS's IP address or open Settings.
	Label Color	Selects the color of the name displayed below the icon.

## Mounting as a Network Drive

You can map a shared folder as a network drive from NAS Navigator2.



**1** Click the icon in the Dock to start NAS Navigator2.

**2** Double-click the LinkStation icon or click the LinkStation icon while holding down the control key, then select *Open Folder*. Enter a username and password with the rights to access the shared folder.

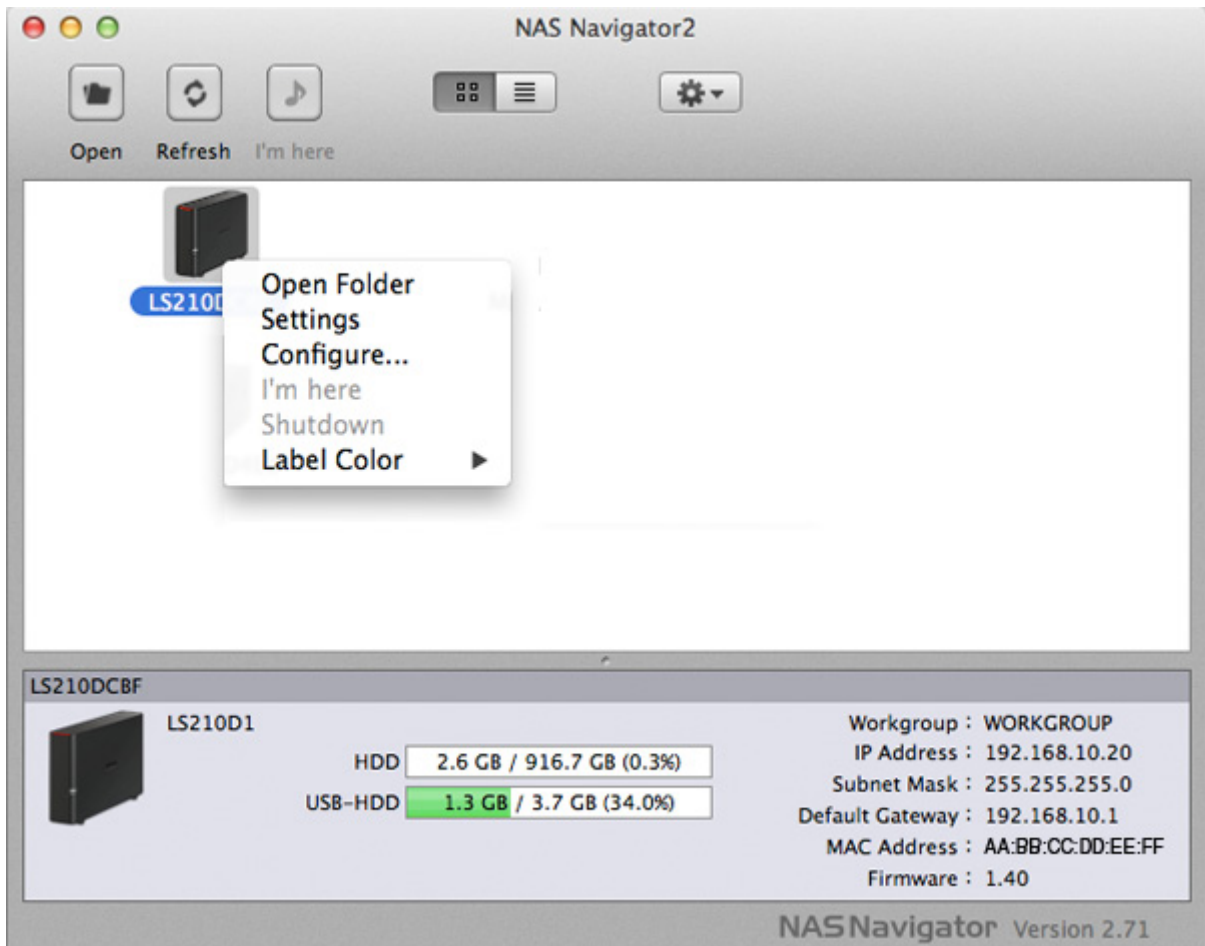

**3** Select the shared folder to mount and click *OK*.

**4** The shared folder is now mounted as a network drive.

## Changing the IP Address

---



- 1 Click the icon in the Dock to start NAS Navigator2.
- 2 Hold down the control key, select your LinkStation, and choose *Configure - IP Address*.
- 3 Uncheck "Use DHCP"; enter the desired settings and the administrator password, then click *Apply*.

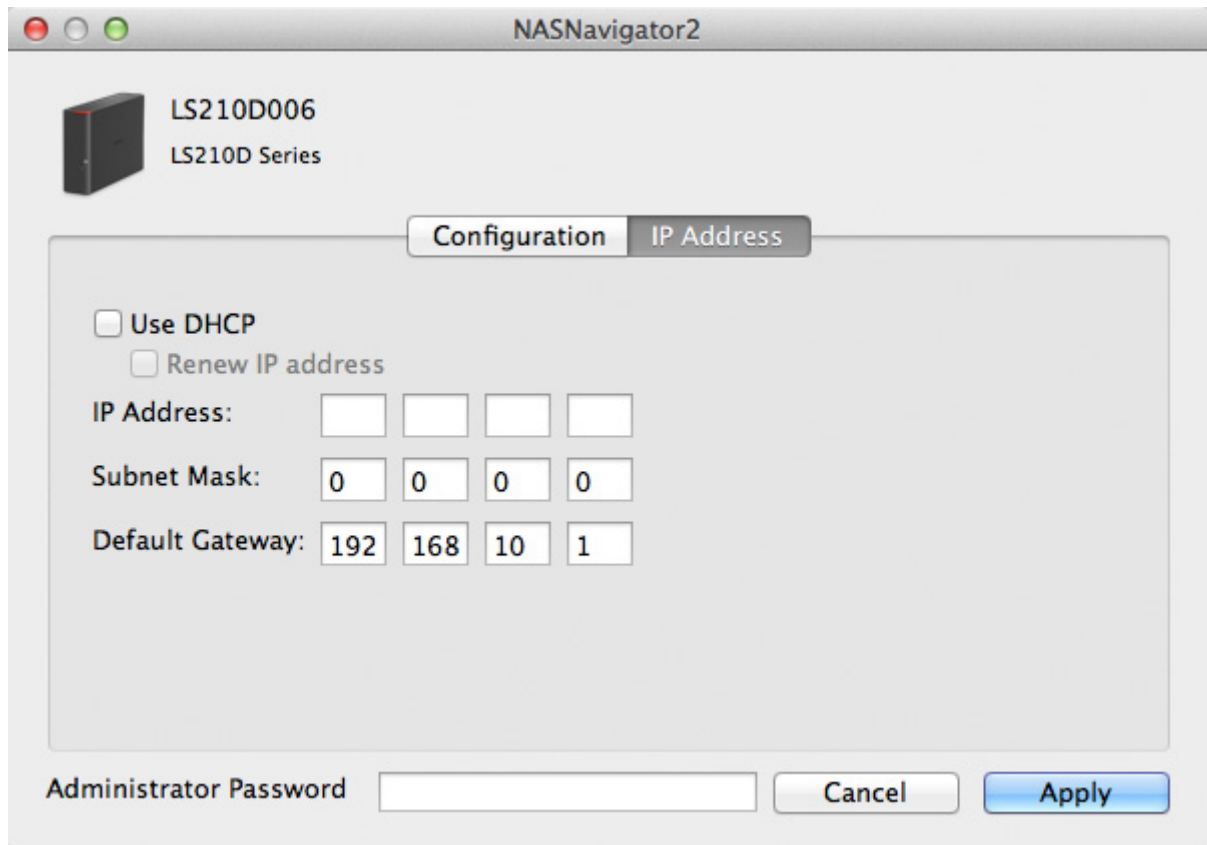

Configuration IP Address

Use DHCP  
 Renew IP address

IP Address:

Subnet Mask:

Default Gateway:

Administrator Password

**Note:** The following IP addresses are reserved and should not be used. If you configure one of them by accident, initialize settings with the function button on the LinkStation.

Local loopback address: 127.0.0.1, 255.255.255.0  
Network address: 0.0.0.0, 255.255.255.0  
Broadcast address: 255.255.255.255, 255.255.255.0  
The IP address range from 224.0.0.0 to 255.255.255.255

---

## NovaBACKUP

---

NovaBACKUP is a Windows utility that lets you back up the data on your computer or LinkStations.

### Installing from CD

---

The installation methods are different depending on which version of LinkNavigator CD you have. If you LinkNavigator CD is version 1.10 or earlier, install NovaBACKUP from the installed LinkNavigator CD.

- 1 Insert the LinkNavigator CD to your computer.
- 2 Launch LSNavi.exe from the LinkNavigator CD.

**3** Click *Options - Additional Software Installation*.

**4** Select "NovaBACKUP" and click *Install*. Follow the procedure to finish installing NovaBACKUP.

## **Installing from Website**

---

If your LinkNavigator CD is version 1.20 or later, install the software from [http://buffalo.jp/support\\_s/guide2/manual/ls/200/en/manual.html](http://buffalo.jp/support_s/guide2/manual/ls/200/en/manual.html). Select the region and model to go to the d.buffalo site of your specific product model.

To download the installer, you will need the serial number of your LinkStation. The serial number is printed on the label on the back of the unit.

# Chapter 10 Appendix

## When the Power LED Blinks

### White

The power LED will blink white during bootup or shutdown.

### Red

If there is an error, the power LED will blink red. The pattern of the blink gives the error code. You can also see any errors in NAS Navigator2.

Place of Error Code	Status
10s Place of Error Code	The LED flashes for 1.0 second every 0.3 seconds. This gives the tens place of the error code.
1s Place of Error Code	The LED flashes for 0.5 seconds every 0.3 seconds. This gives the ones place of the error code.

Error Code	Description	Corrective Action
E07	The firmware is corrupted.	Contact Buffalo technical support for assistance.
E11	An error occurred in the fan speed.	Check the fan. Use compressed air or tweezers to remove any dust or foreign objects. Confirm that the fan is spinning normally. If it is not, contact Buffalo technical support for assistance.
E12	A rise in the system temperature may have exceeded the allowable safety value.	Do not place objects in the area around the LinkStation. Also, move the LinkStation to a cool location.
E14	RAID array x cannot be mounted.	Run the RAID array disk check in Settings.
E15	The bad sectors have reached a dangerous level.	Replace the defective drive.
E16	Unable to find hard drive x.	Hard drive x may be disconnected or may have failed. Shut down the LinkStation and reinstall the hard drive.
E22	Unable to mount drive x.	Format the hard drive. After formatting, if the error still appears after rebooting, replace the hard drive. If the error is displayed again, contact Buffalo technical support for assistance.
E23	An error occurred, so the hard drive was removed from the RAID array.	Replace the faulty drive.
E30	A hard drive error occurred.	Replace the faulty drive.

## Amber

If there is a status message, the power LED will blink amber. The pattern of the blink gives the information code. You can also see any status messages in NAS Navigator2.

Place	Status
10s Place	The LED flashes for 1.0 seconds every 0.3 seconds. This gives the tens place of the information code.
1s Place	The LED flashes for 0.5 seconds every 0.3 seconds. This gives the ones place of the information code.

Information Code	Description	Corrective Action
I10	System temperature is too high.	Move the LinkStation to a cool location. Do not place objects in the area around the LinkStation.
I11	Drive x has too many bad sectors.	Replace hard drive x.
I12	Operating in degraded mode.	-
I13	Formatting RAID array x.	-
I14	Checking RAID array x.	-
I15	Examining the error status of RAID array x. <b>Note:</b> Transfer speeds are slower during the examination process.	-
I16	Creating RAID array x.	-
I17	Resynchronizing RAID array x. <b>Note:</b> Transfer speeds are slower during resynchronization.	-
I18	Rebuilding RAID array x. <b>Note:</b> Transfer speeds are slower during the rebuilding process.	-
I19	Writing 0s to RAID array x, erasing all data.	-
I20	Formatting hard drive x.	-
I21	Checking hard drive x.	-
I22	Erasing the data for hard drive x.	-
I23	System is being initialized.	-
I25	Updating the LinkStation firmware.	-
I26	Initializing all settings.	Don't turn off the LinkStation.
I27	Checking USB hard drive.	-
I28	Formatting USB hard drive.	Don't turn off the LinkStation.
I46	Data migration or conversion (RAID migration) is in progress.	Don't turn off the LinkStation.
I47	Data migration or conversion (RAID migration) is in progress.	Don't turn off the LinkStation.
I52	A new firmware version has been released.	Update the firmware.

Information Code	Description	Corrective Action
154	A backup job has failed.	Make sure that the backup job is configured correctly. Make sure that the NAS is on and not in standby mode. If the backup job still fails, check the status of the network and backup source and destination.

## Amber (Not Blinking)

When the power LED glows a steady amber, a new firmware version is available. Update the firmware to the newest version.

---

## Default Settings

---

Administrator's Name	admin
Password	password
Shared Folders	"share" (for both Windows and Mac computers). The recycle bin is enabled on "share" by default.
DHCP Client	Normally, the LinkStation will get its IP address automatically from a DHCP server on the network. If no DHCP server is available, then an IP address will be assigned as follows: IP address: 169.254.xxx.xxx (xxx is assigned randomly when booting the LinkStation.) Subnet mask: 255.255.0.0
Registered Groups	"hdusers", "admin", and "guest" are default groups and cannot be edited or deleted.
Microsoft Network Group Setting	WORKGROUP
Ethernet Frame Size	1500 bytes (not including 14 bytes of header and 4 bytes of FCS)
SMB2	Disabled
AFP	Disabled
FTP	Disabled
NTP	Enabled
Print Server	Disabled
WebAccess	Disabled
Time Machine	Disabled
DLNA Server	Disabled
iTunes Server	Enabled
BitTorrent	Disabled
Function Button Initialization	Restore factory default settings
Update Notification	Enabled
RAID Mode	RAID 1 (LS220D only)

---

## Specifications

---

Check the Buffalo website for the latest product information and specifications.



LAN Port	Interface	IEEE 802.3ab (1000BASE-T) IEEE 802.3u (100BASE-TX) IEEE 802.3 (10BASE-T)
	Transfer Speed	1000 Mbps full duplex (auto-negotiation) 100 Mbps full duplex/half duplex (auto-negotiation) 10 Mbps full duplex/half duplex (auto-negotiation)
	Number of Ports	1 port (supports auto-MDIX)
	Connector Type	RJ-45 8-pin
	Protocol	TCP/IP
	Access Method	CSMA/CD
	File Sharing	SMB/CIFS, AFP, FTP/FTPS, HTTP/HTTPS
	Management	HTTP/HTTPS
	Jumbo Frames	1500, 4084, 7404, and 9216 byte modes are supported. (not including 14 bytes of header and 4 bytes of FCS)
USB Port	1 USB 2.0 port (type A) <b>Note:</b> Compatible USB devices include printers and Buffalo USB hard drives.	
Internal Hard Drive	If a hard drive in your LS220D and LS220DE malfunctions, replace it with a Buffalo OP-HDBST series of the same or more capacity, available from the Buffalo website.	
Power Supply	AC 100–240 V, 50/60 Hz	
Dimensions (W x H x D)	LS210D: 45 x 128 x 205 mm; 1.8 x 5.0 x 8.1 in LS220D: 87 x 128 x 205; 3.4 x 5.0 x 8.1 in LS220DE: 87 x 128 x 205; 3.4 x 5.0 x 8.1 in	
Weight	LS210D: Approx. 1.1 kg; 2.4 lb LS220D: Approx. 2.5 kg; 5.5 lb LS220DE: Approx. 0.9 kg; 1.9 lb	
Power Consumption	LS210D: 1–2 TB models: max ~18 W, 3+ TB models: max ~24 W LS220D, LS220DE: max ~48 W	
Operating Environment	Temperature: 5–35°C; 41–95° F Environment humidity: 20–80% (no condensation)	
Compatible Devices and OS	<ul style="list-style-type: none"> <li>• Windows computers with Ethernet interface Windows 10*, Windows 8.1*, Windows 8*, Windows 7*, Windows Vista*, Windows XP, Windows RT 8.1, Windows RT</li> <li>• Intel Mac computers with Ethernet interface macOS 10.12, 10.11, 10.10, 10.9, 10.8, 10.7, 10.6</li> <li>• iPhone, iPad, iPod touch iOS 5 or later</li> <li>• Android smartphones and tablets Android 2.3 or later</li> <li>• Windows Phone Windows Phone 7.5 or later</li> </ul> <p>*32-bit and 64-bit <b>Note:</b> The LinkStation requires an Ethernet connection with your computer for operation. It cannot be connected via USB. To use with mobile devices, Wi-Fi connection is required.</p>	

# Chapter 11 Regulatory Compliance Information

---

## For Customers in the United States

---

### FCC Statement

This equipment has been tested and found to comply with the limits for a Class B digital device, pursuant to Part 15 of the FCC Rules. These limits are designed to provide reasonable protection against harmful interference in a residential installation.

This equipment generates, uses and can radiate radio frequency energy and, if not installed and used in accordance with the instructions, may cause harmful interference to radio communications. However, there is no guarantee that interference will not occur in a particular installation.

If this equipment does cause harmful interference to radio or television reception, which can be determined by turning the equipment off and on, the user is encouraged to try to correct the interference by one or more of the following measures:

- Reorient or relocate the receiving antenna.
- Increase the separation between the equipment and receiver.
- Connect the equipment into an outlet on a circuit different from that to which the receiver is connected.
- Consult the dealer or an experienced radio/TV technician for help.

This device complies with Part 15 of the FCC Rules. Operation is subject to the following two conditions: (1) This device may not cause harmful interference, and (2) this device must accept any interference received, including interference that may cause undesired operation.

Only use the cables and accessories that are included in the package. Don't use other accessories or cables unless specifically instructed to in the documentation.

### Proposition 65

#### WARNING:

This product and its components contain chemicals known to the State of California to cause cancer and birth defects, or reproductive harm. Wash hands after handling.

---

## For Customers in Europe

---

### EU Declaration of Conformity



Dansk

Brug ikke USB-kabler, der er 3 meter eller længere for at tilslutte USB enheder til denne LinkStation serie.

Der må kun bruges de kabler og det tilbehør der er inkluderet i pakken. Der må ikke bruges andet tilbehør eller kabler, medmindre det er udtrykkeligt beskrevet i dokumentationen.

#### Deutsch

Verwenden Sie keine USB-Kabel, die 3 Meter lang oder länger sind, um USB-Geräte an LinkStations dieser Serie anzuschließen.

Verwenden Sie ausschließlich die Kabel und Zubehörteile, die im Lieferumfang enthalten sind. Andere Zubehörteile oder Kabel dürfen nur dann verwendet werden, wenn dies in der Dokumentation ausdrücklich vorgeschrieben ist.

#### English

Do not use USB cables that are 3 meters or longer to connect USB devices to this LinkStation series.

Only use the cables and accessories that are included in the package. Don't use other accessories or cables unless specifically instructed to in the documentation.

#### Español

Utilice cables de una longitud inferior a 3 metros para conectar los dispositivos USB a este tipo de LinkStation.

Utilice únicamente los cables y accesorios incluidos en el paquete. No utilice otros accesorios ni cables a menos que así se indique en la documentación.

#### Français

Utilisez des câbles d'une longueur de moins 3 mètres pour connecter les périphériques USB à ce type de LinkStation.

Utilisez uniquement les câbles et accessoires inclus dans ce package. N'utilisez aucun autre accessoire ou câble sauf instruction spécifique de la documentation.

#### Italiano

Non utilizzare cavi USB lunghi 3 metri o più per collegare dispositivi USB a questa LinkStation.

Utilizzare esclusivamente i cavi e gli accessori inclusi nell'imballaggio. Non utilizzare altri accessori o cavi a meno che non sia specificamente indicato nella documentazione.

#### Nederlands

Gebruik geen USB-kabels die 3 meter of langer zijn om USB-apparaten met deze LinkStation series te verbinden.

Gebruik alleen de kabels en toebehoren die zich in de verpakking bevinden. Gebruik geen ander toebehoren of kabels tenzij dit uitdrukkelijk in de handleiding wordt aangegeven.

#### Norsk

Bruk ikke USB-kabler på tre meter eller mer for å koble USB-enheter til denne LinkStation-serien.

Bruk kun kabler og tilbehør som er inkludert i pakken. Ikke bruk annet tilbehør eller kabler med mindre spesielt instruert til å gjøre det i dokumentasjonen.

#### Português

Não usar cabos USB de 3 metros ou mais para ligar dispositivos USB a esta série LinkStation.

Utilizar apenas cabos e acessórios incluídos na embalagem. Não utilizar outros acessórios ou cabos, salvo se especificamente indicado na documentação.

#### Suomi

Älä käytä 3m tai pitempiä USB-kaapeleita USB-laitteiden liittämiseen näille LinkStation-sarjoille.

Käytä ainoastaan pakkauksen mukana toimitettuja kaapeleita ja varusteita. Älä käytä muita varusteita tai kaapeleita ellei näin ole erityisesti ohjeistettu asiakirjoissa.

Svensk

Använd inte USB-kablar som är 3 meter eller längre för att ansluta USB-enheter till den här LinkStation-serien. Använd bara kablar och tillbehör som ingår i förpackningen. Använd inte andra tillbehör eller kablar om du inte får uttryckliga instruktioner om det i dokumentationen.

Türk

USB aygıtları bu LinkStation serisine bağlamak için 3 metre ve daha uzun USB kabloları kullanmayın. Yalnızca pakette bulunan kablo ve aksesuarları kullanın. Belgelerde özellikle belirtilmedikçe başka aksesuar ve kablolar kullanmayın.

## AC Adapter

LS210D	1–2 TB models: Asian Power Devices Inc. WA-18H12 or WB-18L12R
	3+ TB models: Asian Power Devices Inc. WA-24E12 or WA-24Q12R
LS220D and LS220DE	Asian Power Devices Inc. DA-48Q12 or DA-48T12