

Dell Mobile Projector M318WL

User's Guide



Notes, Cautions, and Warnings



NOTE: A NOTE indicates important information that helps you make better use of your projector.



CAUTION: A CAUTION indicates potential damage to hardware or loss of data if instructions are not followed.



WARNING: A WARNING indicates a potential for property damage, personal injury, or death.

Information in this document is subject to change without notice.

© 2017 Dell Inc. All rights reserved.

Reproduction of these materials in any manner whatsoever without the written permission of Dell Inc. is strictly forbidden.

Trademarks used in this text: Dell and the DELL logo are trademarks of Dell Inc.; DLP and DLP logo and DLP BrilliantColor are trademarks of TEXAS INSTRUMENTS INCORPORATED; Microsoft and Windows are either trademarks or registered trademarks of Microsoft Corporation in the United States and/or other countries.

Wi-Fi® is a registered trademark of Wireless Ethernet Compatibility Alliance, Inc.

Other trademarks and trade names may be used in this document to refer to either the entities claiming the marks and names or their products. Dell Inc. disclaims any proprietary interest in trademarks and trade names other than its own.

Model : Dell Mobile Projector M318WL

November 2017 Rev. A01

Contents

1	About Your Dell Projector	4
	Projector Box Contents	4
	Projector Top and Bottom View	5
	Projector Connections	6
	Remote Control (Optional)	8
2	Adjusting Projector Image	11
	Adjusting Projected Zoom	11
	Adjusting Projector Position	12
	Adjusting Image Corners	14
	Adjusting Image Size	15
3	Using Your Projector	17
	Connecting a Computer Using Optional Wireless Dongle	17
	Connecting to Multimedia	23
	Using PC-Free Presentation	24
4	Troubleshooting	42
	Troubleshooting Tips	42
	Guiding Signals	45
5	Maintenance	46
	Replacing the Remote Control Battery	46
6	Specifications	47
	Compatibility Modes (Digital)	50
7	Additional Information	51
8	Contacting Dell	52

1

About Your Dell Projector

Your projector comes with all the items shown below. Ensure that you have all the items, and contact Dell if anything is missing.

Projector Box Contents

Package Contents

Power cable

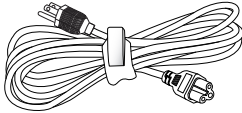

1.0 m HDMI cable (1.4 spec)

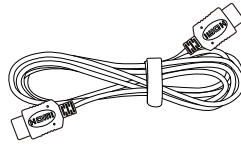

Carrying case

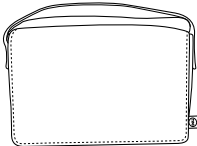

User's Guide and Documentation

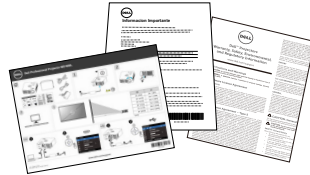

AC adapter

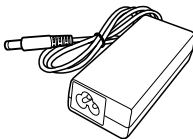

1.2 m USB-A to A cable

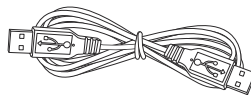

Projector Top and Bottom View

Top View

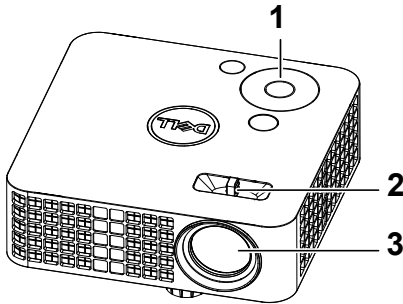

Bottom View

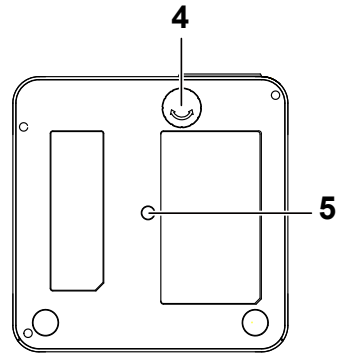

- | | |
|---|--|
| 1 | Control panel |
| 2 | Focus tab |
| 3 | Lens |
| 4 | Tilt adjusting wheel |
| 5 | Mounting hole for tripod: Insert nut 1/4"*20 UNC |



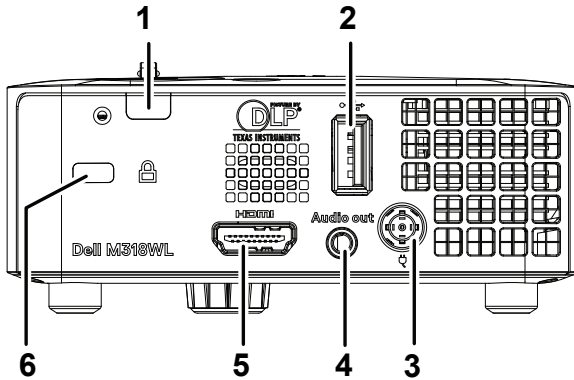

CAUTION: Before you begin any of the procedures in this section, follow the Safety Instructions as described on page 7.

Projector Connections



1	IR receiver	4	Audio output connector
2	USB type A connector*	5	HDMI connector
3	DC input connector	6	Security cable slot

 **NOTE:** *For USB display, multimedia playback (Video/Music/Photo/Office Viewer), USB memory storage access, firmware upgrade and optional wireless dongle.

 **CAUTION:** Before you begin any of the procedures in this section, follow the Safety Instructions as described on page 7.

CAUTION: Safety Instructions

- 1 Do not use the projector near appliances that generate a lot of heat.
- 2 Do not use the projector in areas where there is an excessive amount of dust. The dust may cause the system to fail and the projector will automatically shut down.
- 3 Ensure that the projector is mounted in a well-ventilated area.
- 4 Do not block the ventilation slots and openings on the projector.
- 5 Ensure the projector operates between ambient temperatures (5 °C to 35 °C).
- 6 Do not try to touch the ventilation outlet as it can become very hot after the projector has been turned on or immediately after it is turned off.
- 7 Do not look into the lens while the projector is on as it may cause injury to your eyes.
- 8 Do not place any objects near or in front of the projector or cover its lens while the projector is on as the heat may cause the object to melt or burn.
- 9 Do not use alcohol to wipe the lens.
- 10 Do not use the wireless projector near cardiac pacemakers.
- 11 Do not use the wireless projector near medical equipment.
- 12 Do not use the wireless projector near microwave ovens.









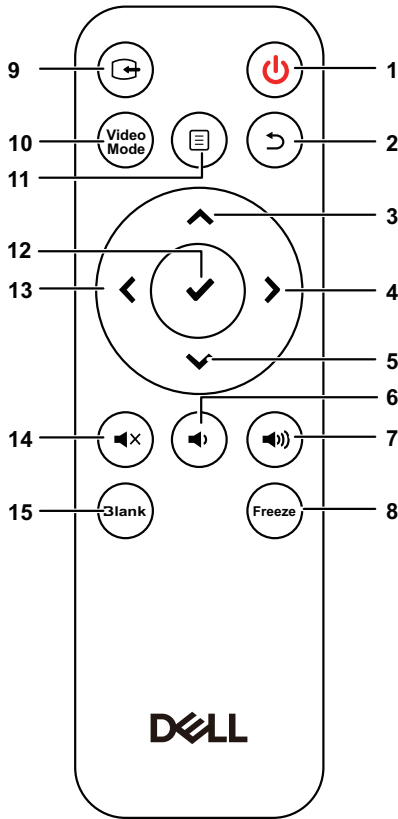



NOTE:

- For more information, see the Dell Support website at **dell.com/support**.
- For more information, see the Safety Information that shipped with your projector.
- The M318WL projector can only be used indoors.

Remote Control (Optional)





1	Power 	Turns the projector on or off.
2	Back 	Returns to the previous screen.
3	Up 	Press to navigate through the On-Screen Display (OSD) Menu items.
4	Right 	Press to navigate through the On-Screen Display (OSD) Menu items.
5	Down 	Press to navigate through the On-Screen Display (OSD) Menu items.
6	Volume down 	Press to decrease the volume.

7	Volume up 	Press to increase the volume.
8	Freeze	Press to pause the screen image, then press "Freeze" again to resume normal projection.
9	Video in	Press to switch between sources: HDMI, Wireless/LAN Display, and USB Viewer.
10	Video mode	<p>The projector has preset configurations that are optimized for displaying data (presentation slides) or video (movies, games, etc.).</p> <p>Press the Video Mode button to toggle between Presentation mode, Bright mode, Movie mode, sRGB, or Custom mode.</p> <p>Pressing the Video Mode button once will show the current display mode. Pressing the Video Mode button again will switch between modes.</p>
11	Menu 	Press to activate the OSD.
12	Enter ✓	Press to confirm the selection.
13	Left ←	Press to navigate through the On-Screen Display (OSD) Menu items.
14	Mute 	Press to mute or un-mute the projector speaker.
15	Blank 	Press to toggle between white/blank/resume the image.

Remote Control Operating Range

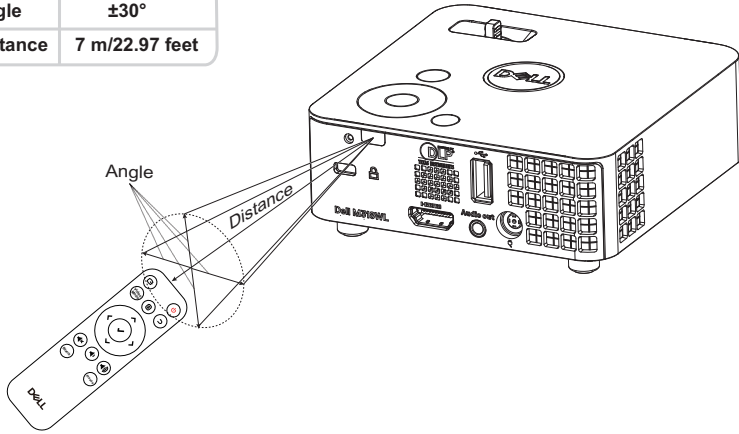
Operating range	
Angle	±30°
Distance	7 m/22.97 feet



 **NOTE:** Actual operating range may slightly differ from the diagram. Weak batteries will also prevent the remote control from properly operating the projector.

2

Adjusting Projector Image

Adjusting Projected Zoom

Raising the Projector Height

1 Raise the projector to the desired display angle, and use the front tilt adjustment wheel to fine-tune the display angle.

Lowering the Projector Height

1 Use the front tilt adjustment wheel to fine-tune the display angle.

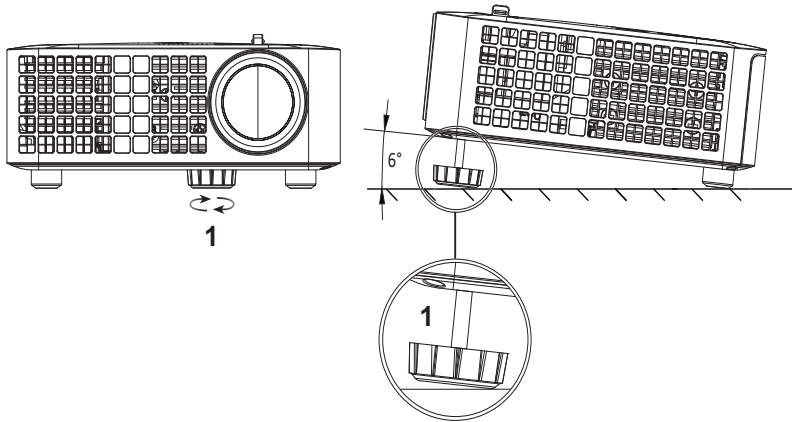

1 Front tilt adjustment wheel
(Angle of tilt: 0 to 6 degrees)

Adjusting Projector Position

When you select a position for the projector, consider the size and shape of your screen, the location of your power outlets, and the distance between the projector and the rest of your equipment. Follow these general guidelines:

- When positioning the projector to the screen, it must be at least 31 inches (78.4 cm) from the projection screen.
- Position the projector to the required distance from the screen. The distance from the lens of the projector to the screen, the zoom setting, and the video format determine the size of the projected image.
- Lens throw ratio: 0.52

You can set up or install the M318WL in the following ways:

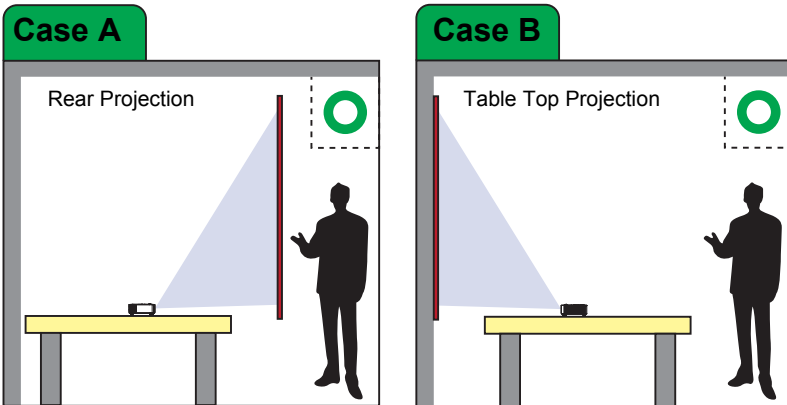

Do not install the M318WL projector in the following ways:

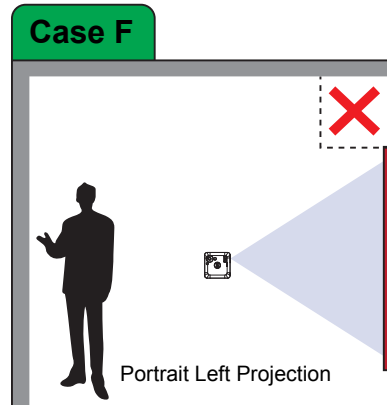
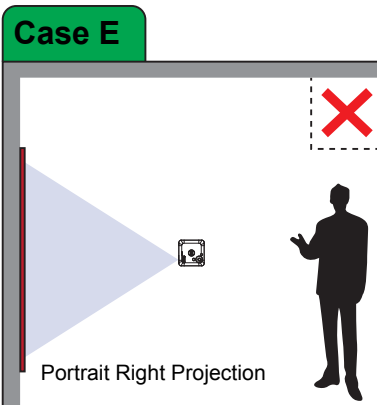
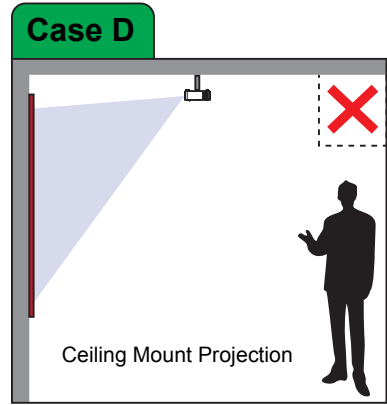
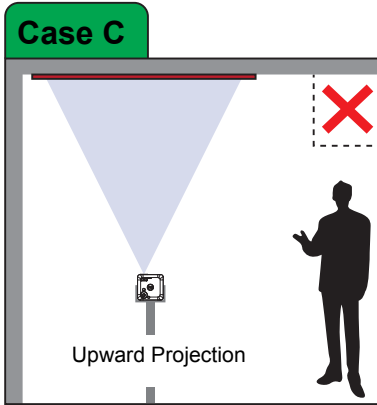

Adjusting Image Corners

Use Auto Adjust to automatically adjust the projector's **Horizontal**, **Vertical**, **Frequency**, and **Tracking** in PC mode.

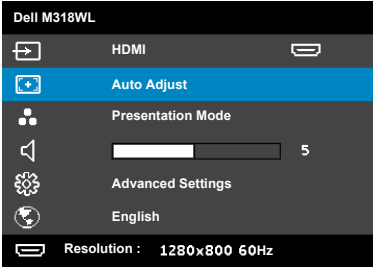

Adjusting Image Size

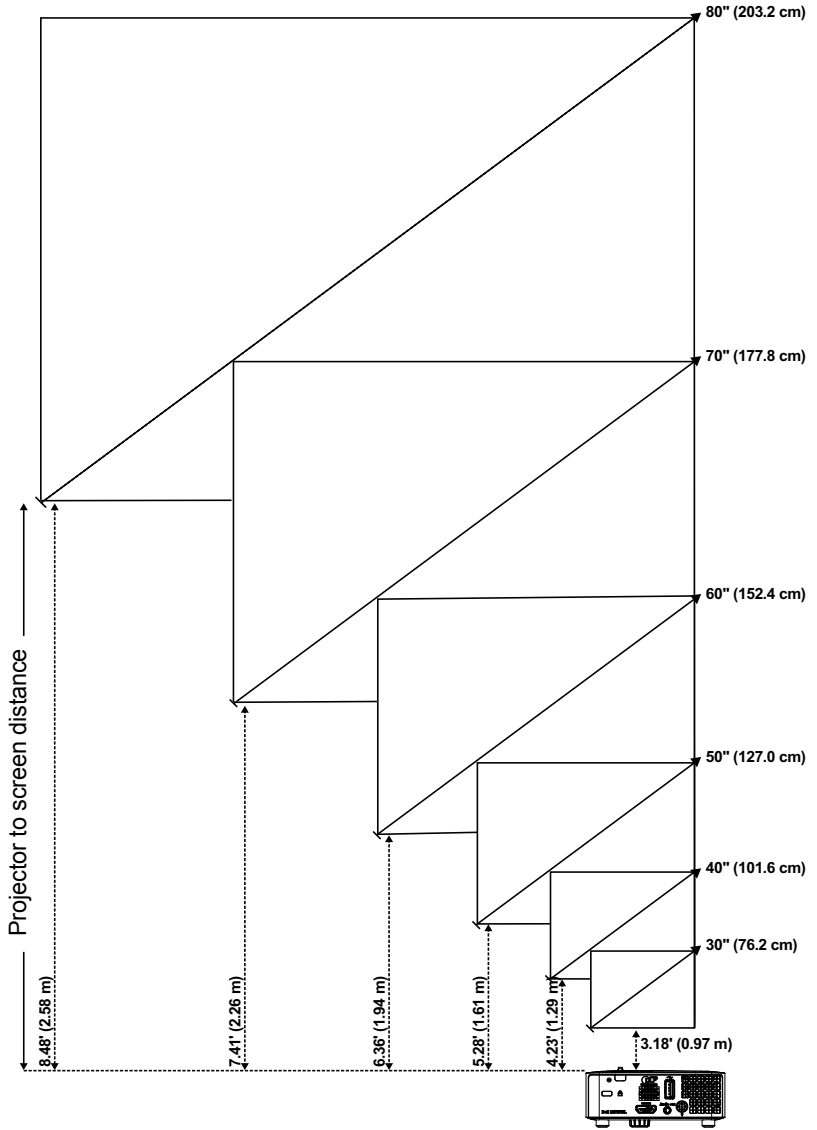

Adjusting Image Shape

Desired Distance (m) <A>	Screen size		Height
	Diagonal (inch) 	W (cm) x H (cm)	From base to top of image (cm) <C>
0.97	30	65 x 40	40
1.29	40	86 x 54	54
1.61	50	107 x 67	67
1.94	60	129 x 81	81
2.26	70	151 x 94	94
2.58	80	171 x 108	108

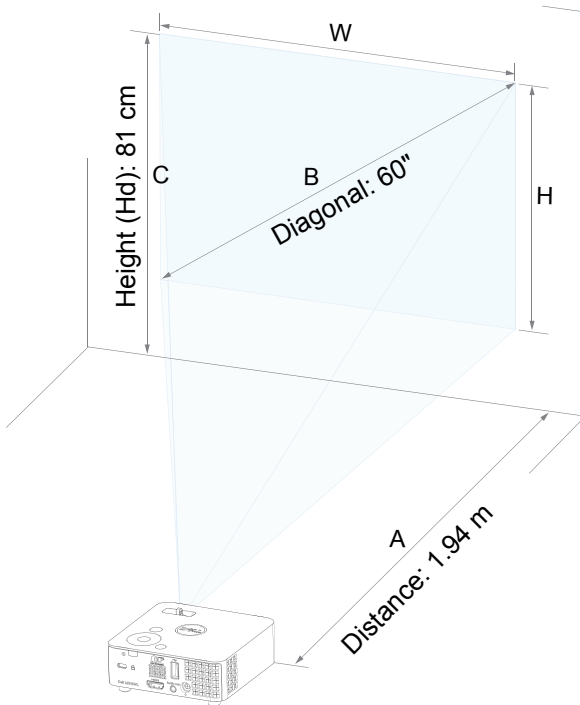

3

Using Your Projector

Connecting a Computer Using Optional Wireless Dongle

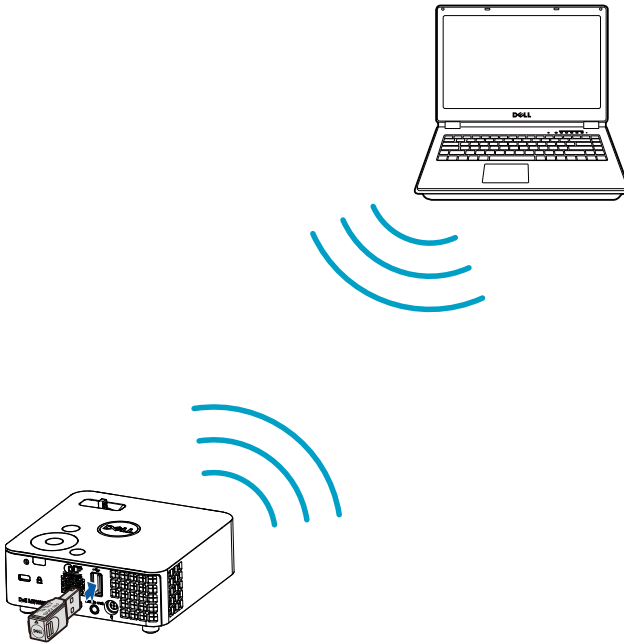

- 1 Connect the wireless dongle to the USB-A port on the projector.

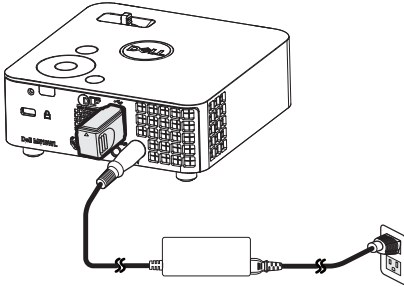

- 2 Set the input source to **Wireless Display** in order to enter the wireless menu.

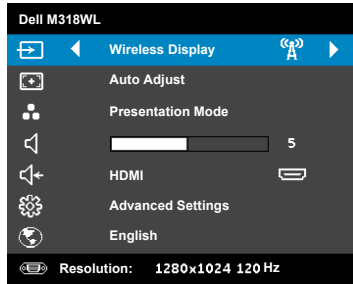
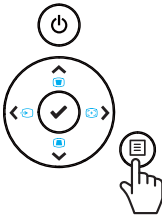

- 3 In your device's wireless menu, search for the projector by its ID. Then enter the PSK at the prompt to start sharing the same network with the projector.

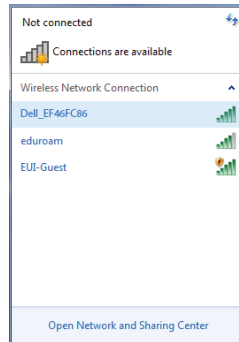
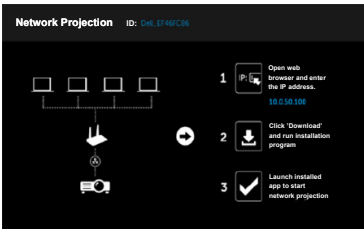

4 Do one of the following:

- a If this is the first time you are connecting to the projector via wireless method, first open the web browser on your computer and enter the IP address 10.0.50.100. Continue to Step 5.

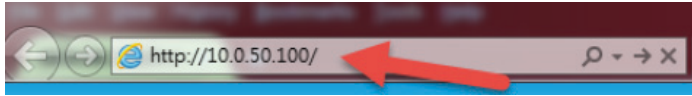

- b If you have previously connected your computer to the projector via wireless method, please continue to Step 6.

5 Follow the on-screen instruction to launch the web management page and download the app to start network projection.

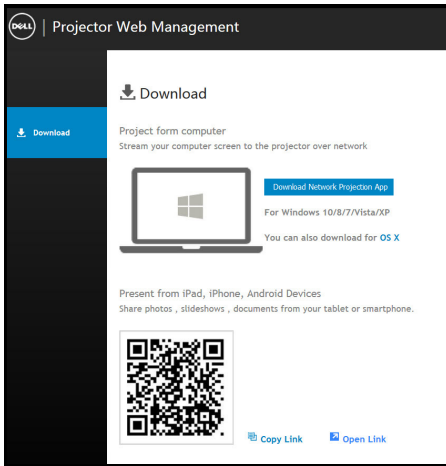

6 Open **Dell Network Projection** application on your computer.

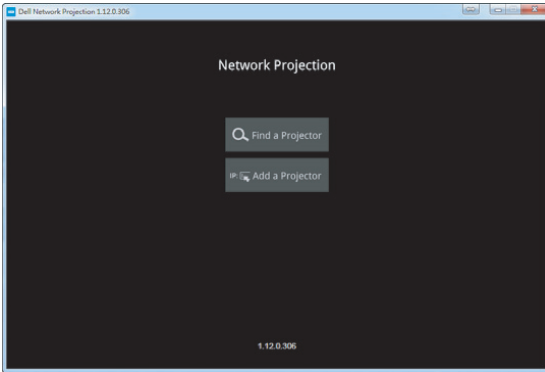

7 Find a Projector you connected with.

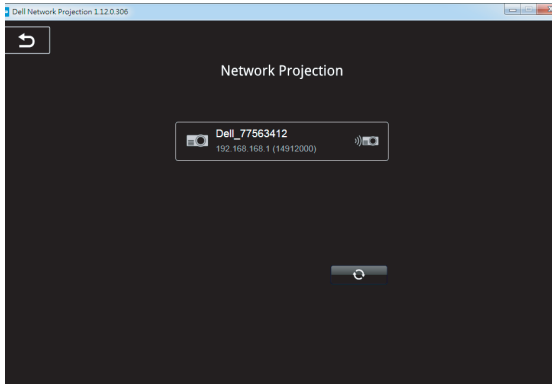

8 Select **Extend** to share your content.

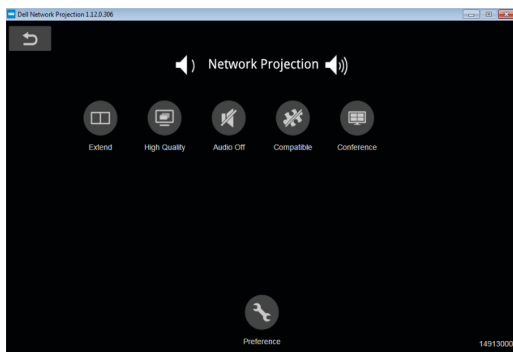

NOTE: Your computer should be equipped with wireless functionality and properly configured to detect another wireless connection. Refer to your computer's documentation on how to configure a wireless connection.



NOTE: Your projector must be installed with a wireless dongle if you want to use the wireless display. The wireless dongle is not shipped with your projector. You can purchase it on the Dell website at www.dell.com.

Connecting to Smartphone or Tablet Using Optional Wireless Dongle

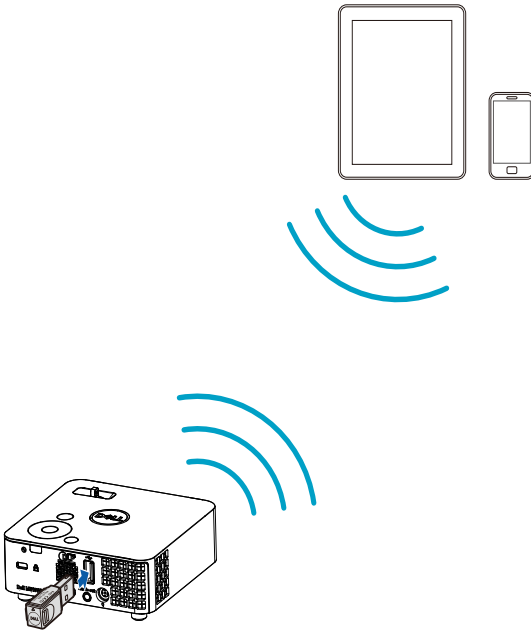

- 1 Install application **EZCast Pro** on your android or iOS device. In your device's wireless menu, search for the projector by its ID. Then enter the PSK at the prompt to start sharing the same network with the projector.
- 2 Launch the **EZCast Pro** application then click the top-right button to choose the device you connected with.

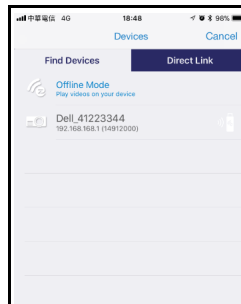
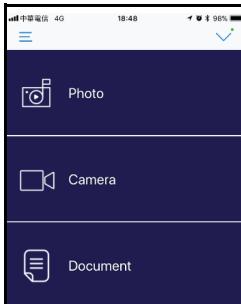



NOTE: Dell M318WL supports **EZView** function. It is an application that transmits supported content from your Android or iOS devices wirelessly. For more information, please visit the Dell Support site at dell.com/support.

Supported file formats are listed on page 24 in Multimedia File Type Support section.

Connecting to Multimedia

Using a USB Flash Disk

Refer to page 30 for detailed instructions.

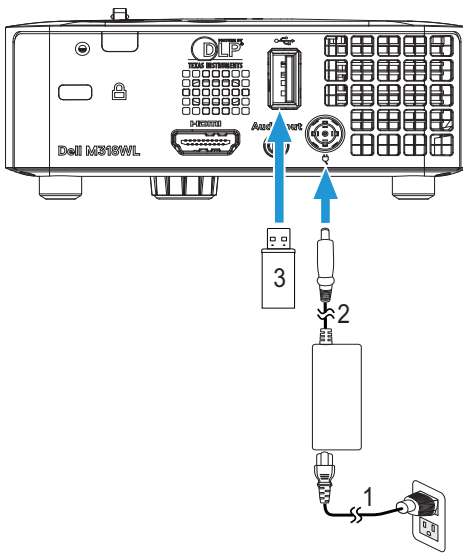

- | | |
|---|----------------|
| 1 | Power cord |
| 2 | AC adapter |
| 3 | USB flash disk |



NOTE: The USB flash disk is not shipped with your projector.

Using PC-Free Presentation

Multimedia File Type Support

Photo Format

Image Type (Ext Name)	Sub Type	Encode Type	Max Pixels	Max Size
Jpeg/Jpg	Baseline	YUV420	No Limitation	2GB
		YUV422		
		YUV440		
		YUV444		
	progressive	YUV420	64x panel resolution	2GB
		YUV422		
		YUV440		
		YUV444		
BMP			64x panel resolution	

Video Format

File Format	Video Format	MAX Res	MAX Bit Rate (bps)	Audio Format
MOV, MP4, AVI, MKV, DIVX	H264	1080P	20Mbps	AC3, DTS, MP1, MP2, MP3, PCM, ADPCM
MOV, MP4	MPEG4	1080P	20Mbps	AMR, PCM, ADPCM
WMV	WMV3	1080P	20Mbps	WMA2, WMA3

Music Format

Music Type (Ext Name)	Sample Rate (KHz)	Bit Rate (Kbps)
MP1	8-48	8-320
MP2	8-48	8-320
MP3	8-48	8-320
WMA	22-48	5-320

Setting up to Present via Internal Memory

Follow these steps to playback the **Photo**, **Video**, or **Music** files on your projector:

- 1 Connect power cable with AC adapter then using USB-A to USB-A cable to connect computer and projector. Power up the projector by pressing the power button.

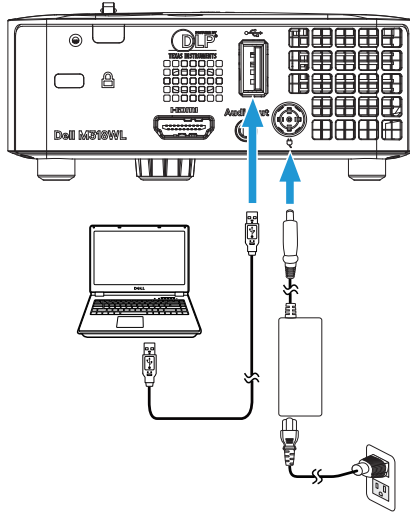

- 2 Access the **Input Source** menu, select the **Internal Memory** option, and press the **✓** button.

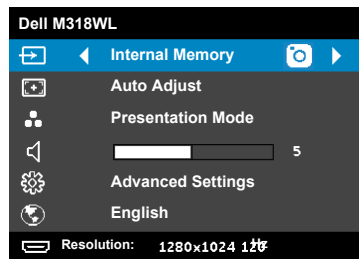
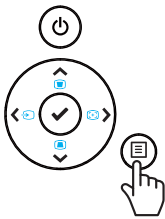

The Internal Memory Screen shown below appears:

- 3 Select **Storage Mode** to access the internal memory as **Removable Disk**.

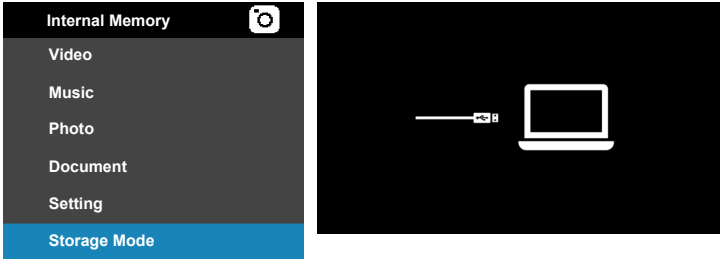

- 4 To copy files to the projector's Internal Memory, first open a file explorer window. Go to **Computer** and locate a **Removable Disk**. This refers to the Internal Memory of the projector. You may copy files to the Internal Memory. This will allow you to project the files directly from the projector in the future, without needing a computer. For supported file types, please refer to page 24.

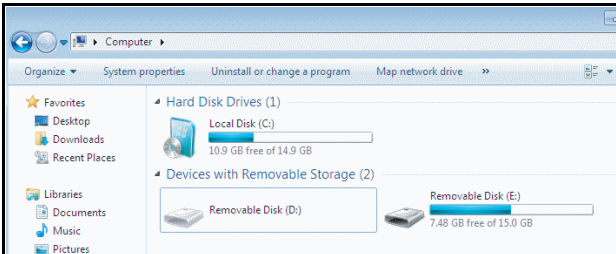

To project a file from the Internal Memory, select one from **Video**, **Music**, **Photo**, or **Document**, then press the **✓** button to start playing. Or select the **Setup** option to change multimedia settings.

The **Video Source Screen** shown below appears:



Video playback screen:

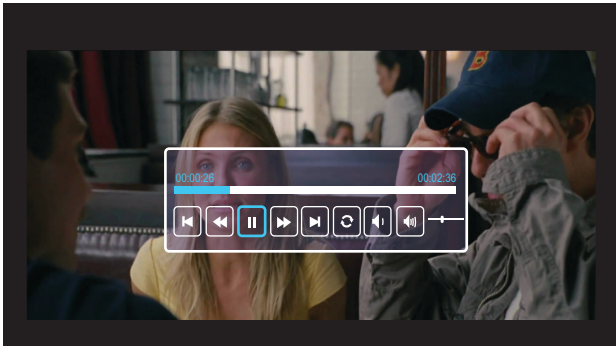

Press the **✓** button on the remote control or keypad to access the video playback control. Then you can use the following buttons on the screen to control video playback.



The **Music Source Screen** shown below appears:



Music playback screen:

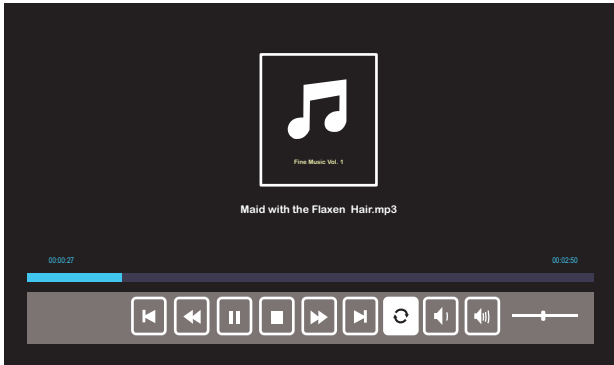

Press the **✓** button on the remote control or keypad to access the music playback control. Then you can use the following buttons on the screen to control music playback.

								
Previous	Rewind	Play / Pause	Stop	Forward	Next	Repeat	Volume - / +	

The **Photo Source Screen** shown below appears:

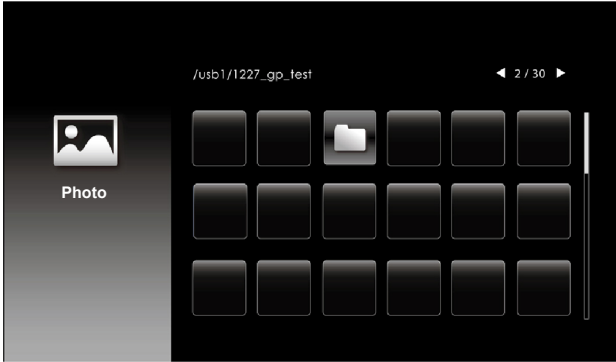

Slideshow screen:

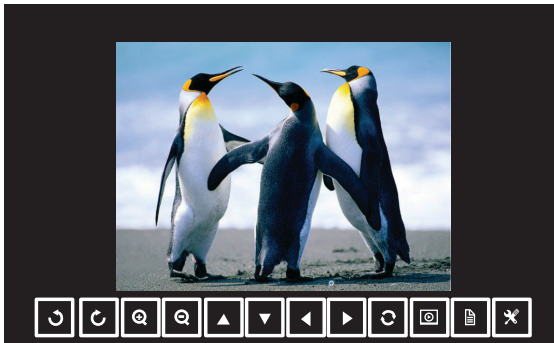



Press the **✓** button on the remote control or keypad to access the photo viewer control. Then you can use the following buttons on the screen to control photo viewer.

Rotate - / +		Zoom in / out		Up / Down / Left / Right (in Zoom mode)				Reset

Slideshow	Information	Slideshow settings

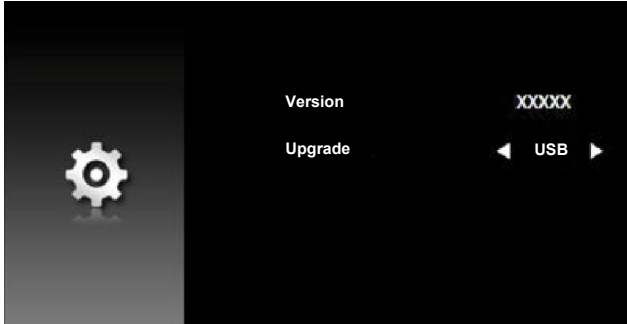
The **Settings Screen** shown below appears:



 **NOTE:** This is used for firmware upgrade via USB.

Setting up to Present Using External USB Storage

 **NOTE:** A USB flash disk must be plugged into the projector if you want to use the multimedia USB function.

Follow these steps to playback the **Photo**, **Video**, or **Music** files on your projector:

- 1 Connect the power cable with AC adapter and turn on the projector by pressing the power button.

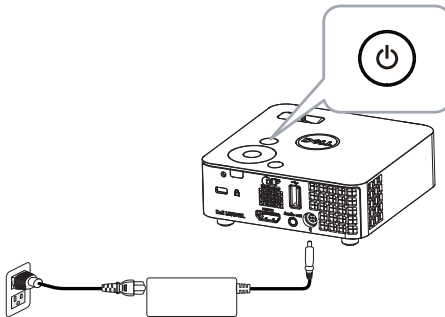

- 2 Plug in a **USB flash disk** to your projector.

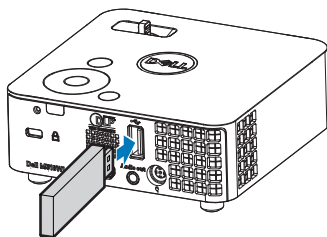

- 3 Access the **Input Source** menu, select the **USB Viewer** option, and press the **✓** button.

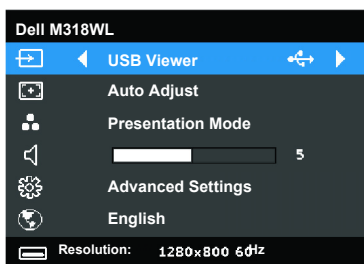
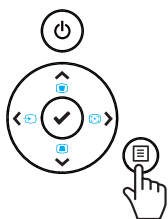

The **USB Screen** shown below appears:

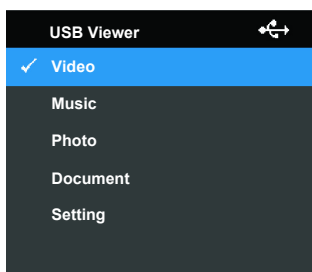

- 4 Select the multimedia files: **Video**, **Music**, **Photo**, or **Document**, and then press the **✓** to start playing. Or select the **Setup** option to change multimedia settings.

The **Video Source Screen** shown below appears:



Video playback screen:

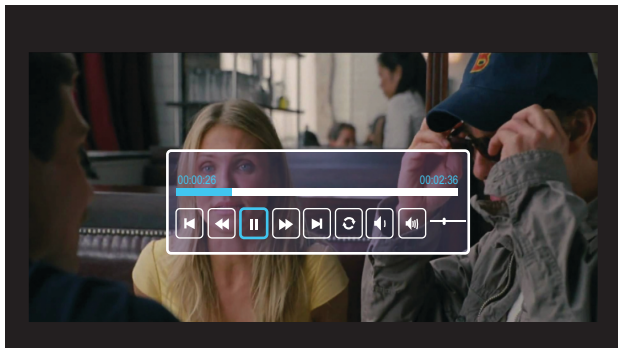

Press the **✓** button on the remote control or keypad to access the video playback control. Then you can use the following buttons on the screen to control video playback.



The **Music Source Screen** shown below appears:



Music playback screen:

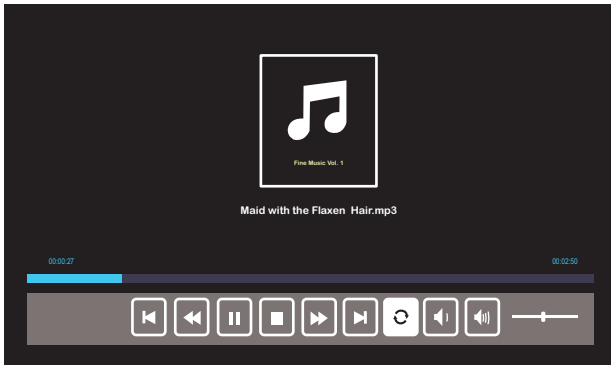

Press the **✓** button on the remote control or keypad to access the music playback control. Then you can use the following buttons on the screen to control music playback.





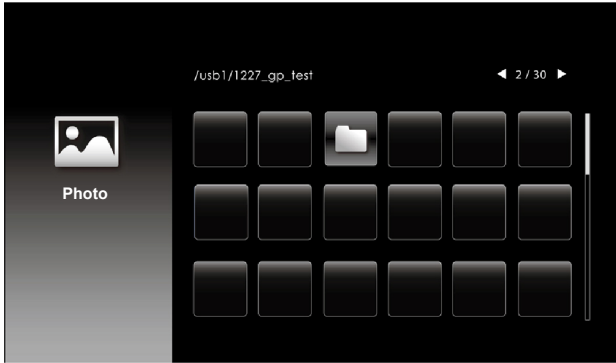

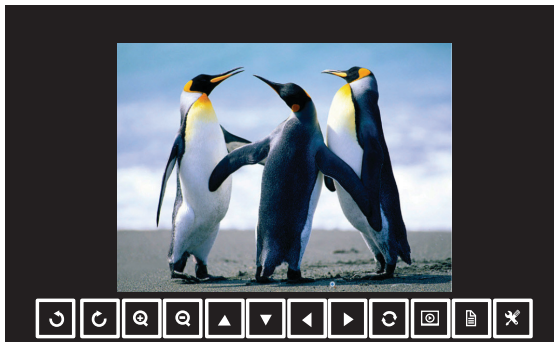

The **Photo Source Screen** shown below appears:





Slideshow screen:



Press the **✓** button on the remote control or keypad to access the photo viewer control. Then you can use the following buttons on the screen to control photo viewer.

								
Rotate - / +		Zoom in / out		Up / Down / Left / Right (in Zoom mode)				Reset

		
Slideshow	Information	Slideshow settings

The **Settings Screen** shown below appears:

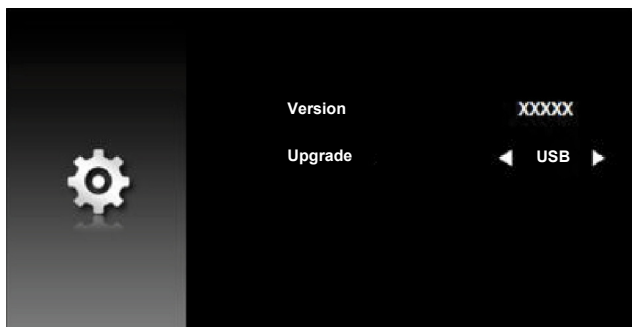



NOTE: This is used for firmware upgrade via USB.

Setting up to Present Using USB Display

Follow these steps to use **Dell Network Projection** application via USB cable.

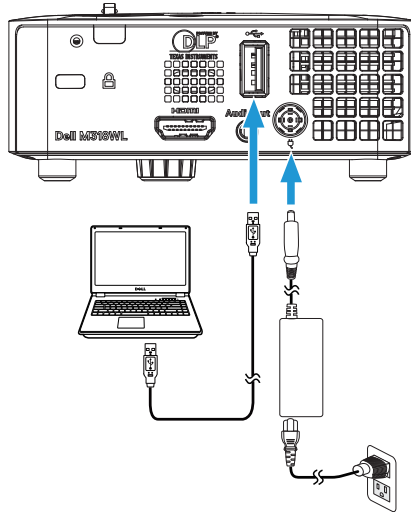
- 1 Connect power cable with AC adapter then using USB-A to USB-A cable to connect computer and projector. Power up the projector by pressing the power button.



- 2 Press the  button. Access the Input Source menu, select the **Internal Memory** option, and press the  button.

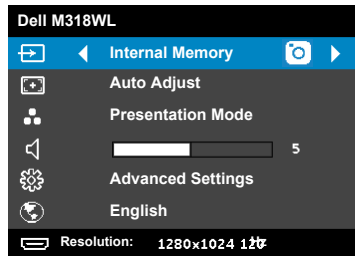
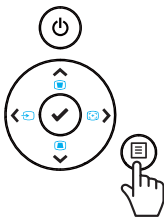

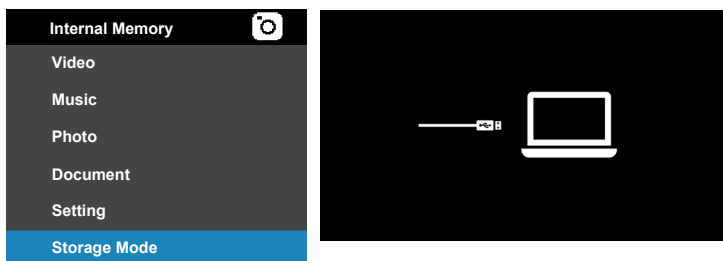

- 3 Select **Storage Mode** to access the internal memory as **Removable Disk**.

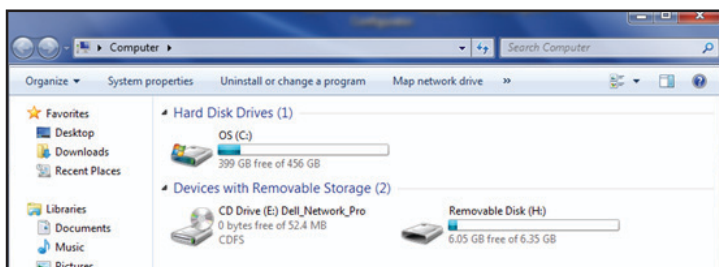

- 4 To use **Dell Network Projection Lite** application from the Internal Memory, first open a file explorer window on your computer. Go to **Computer** and locate a **Dell Network Pro**.



- 5 Open **Dell Network Pro** and copy **Dell Network Projection Lite** application to your computer.
- 6 On the projector, press the  button. Access the Input Source menu, select the USB Display option, and press the  button.

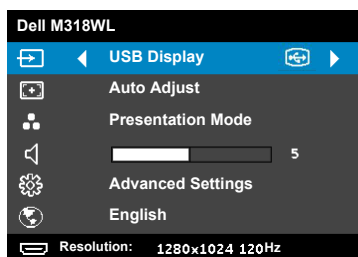

The USB Display screen shown below appears:

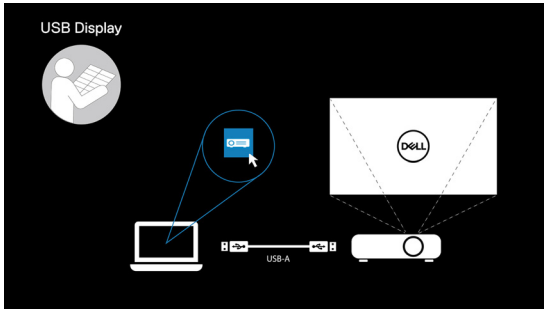

- 7 Run the **Dell Network Projection Lite** application from your computer.

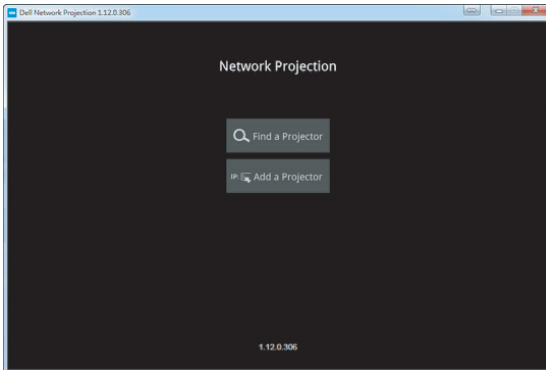

8 Find a Projector you connected with.

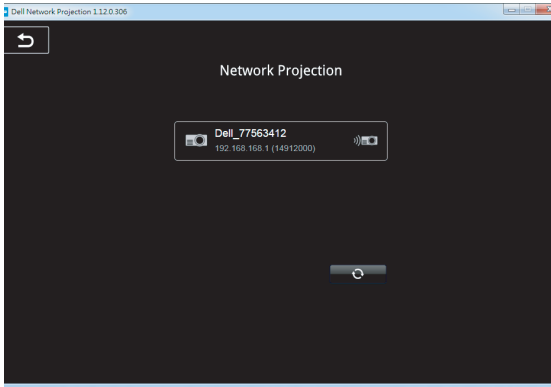

9 Select **Extend** to share your content.

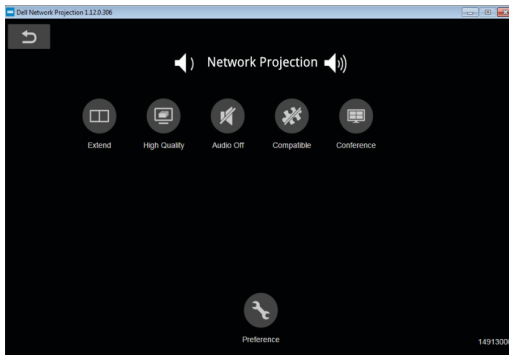

Powering up with Dell Power Companion

Identifying Parts and Controls

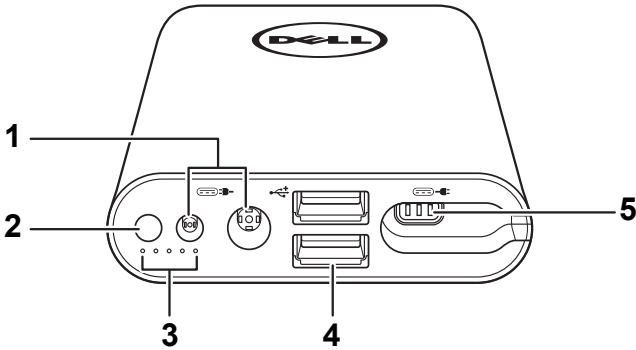

1 Power-in port (from laptop adapter)

2 Power button/Battery-status button

3 Battery-status lights (5)

4 USB-out ports (2)

5 Power-out port (to laptop)



NOTE: Powering up the projector only works with the selected/compatible power bank.

Powering Your Projector

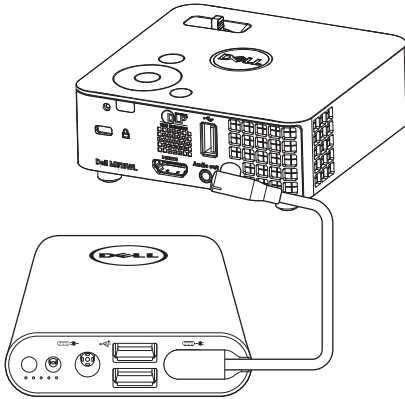

- 1 Connect one end of the power-output cable to the power-out port of the power companion.
- 2 Connect the other end of the power-output cable to the DC input connector of your projector.
- 3 Press the power button to start powering your projector.

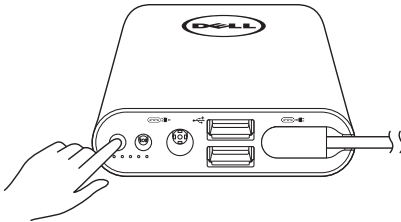

NOTE: The battery-status light blinks amber when the power companion battery is low.

4

Troubleshooting

Troubleshooting Tips

If you experience problems with your projector, see the following troubleshooting tips. If the problem persists, contact Dell (see Contacting Dell on page 52).

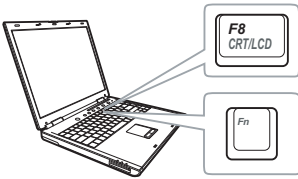

Problem

No image appears on the screen



Possible Solution

- Ensure that the projector is turned on.
 - Ensure that you have chosen the correct input source on the INPUT SOURCE menu.
 - Ensure the external graphics port is enabled. If you are using a Dell laptop computer, press **Fn** **F8** (Fn+F8). For other computers, see your respective documentation. If images are not displayed properly, please upgrade the video driver of your computer. For Dell computers, see dell.com/support.
 - Ensure that all the cables are securely connected. See "Connecting to Multimedia" on page 23.
 - Ensure that the pins of the connectors are not bent or broken.
 - Use **Test Pattern** in the **Projector Settings** of the **Advanced Settings** menu. Ensure that the colors of the test pattern are correct.
-

Problem <i>(continued)</i>	Possible Solution <i>(continued)</i>
Partial, scrolling, or incorrectly displayed image	<p>1 Press the Auto Adjust button on the remote control or the control panel.</p> <p>2 If you are using a Dell portable computer, set the resolution of the computer to WXGA (1280 x 800):</p> <ul style="list-style-type: none"> a Right-click the unused portion of your Microsoft® Windows® desktop, click Screen Resolution. b Verify that the setting is 1280 x 800 pixels for the external monitor port. c Press   (Fn+F8). <p>If you experience difficulty in changing resolutions, or if your monitor freezes, restart all the equipment and the projector.</p> <p>If you are not using a Dell portable computer, see your documentation. If images are not displayed properly, please upgrade the video driver of your computer. For a Dell computer, see dell.com/support.</p>
Image color is incorrect	Use Test Pattern in the Projector Settings of the Advanced Settings menu. Ensure that the colors of the test pattern are correct.
Image is out of focus	<p>1 Adjust the focus ring on the projector lens.</p> <p>2 Ensure that the projection screen is within the required distance from the projector (3.18 ft [97 cm] to 8.48 ft [258 cm]).</p>
Image is reversed	Select Projector Settings of the Advanced Settings from the OSD and adjust the projector mode.
Error LED is blinking amber	A projector fan has failed and the projector will automatically shut down.
TEMP LED is solid amber	The projector has overheated. The display automatically shuts down. Turn the display on again after the projector cools down. If the problem persists, contact Dell.

Problem <i>(continued)</i>	Possible Solution <i>(continued)</i>
TEMP LED is blinking amber	If the projector fan fails, the projector will automatically shut down. Clear the projector mode by pressing and holding the POWER button for 10 seconds. Please wait for about 5 minutes and try to power up again. If the problem persists, contact Dell.
The OSD does not appear on the screen	Press the Menu button on the panel for 15 seconds to unlock the OSD.
The remote control is not operating smoothly or works only within a limited range	The battery may be low. Check if the LED indication from the remote is too dim. If so, replace with a new CR2032 battery.
USB Display not displaying	Display over USB Should run automatically. To manually run USB display, go to My Computer and run "Dell Network Projection Lite.exe".  NOTE: You may require administrator level access to install the driver. Contact your network administrator for support.
Video file is not supported.	<ul style="list-style-type: none"> • Ensure the video file is supported by the projector's multimedia player. Go to pages 24-24 for Multimedia File Type Support. • Convert the video file to meet the following parameters: Video Setting: <ul style="list-style-type: none"> • Code: H.264 • Bit rate: 10Mbps (if it is limited by program, set it as maximum value allowed) • Frame rate: 30 fps (if it is limited by program, set it as maximum value allowed) <p>Audio Setting:</p> <ul style="list-style-type: none"> • Code: AAC • Channel: Stereo • Sample rate: 48 KHz • Bit rate: 96 KBps

Guiding Signals

Projector Status	Description	Control Buttons	Indicator	
		Power (White/Amber)	TEMP (Amber)	△ (Amber)
Standby mode	Projector in Standby mode. Ready to power on.	White Flashing	OFF	OFF
LED on	Projector in Normal mode, ready to display an image.	White	OFF	OFF
Cooling mode	Projector is cooling to shutdown.	White	OFF	OFF
Projector over-heated	Air vents might be blocked or ambient temperature may be above 35 °C. The projector automatically shuts down. Ensure that the air vents are not blocked and that the ambient temperature is within operational range. If the problem persists, contact Dell.	OFF	AMBER	OFF
Fan breakdown	One of the fans has failed. The projector automatically shuts down. If the problem persists, contact Dell.	OFF	AMBER Flashing	OFF
LED failure	LED defective.	OFF	OFF	AMBER
R-LED driver over-heated	Air vents might be blocked or the R-LED driver has overheated. The projector will automatically shut down. Turn the display on again after the projector cools down. If the problem persists, contact Dell.	AMBER	AMBER	OFF

5

Maintenance

Replacing the Remote Control Battery

- 1 Rotate the battery lid counterclockwise to remove the battery cover.

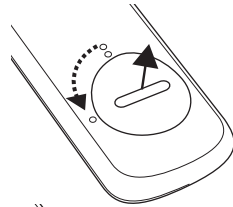

- 2 Insert a CR2032 coin cell battery and align the polarity correctly according to the marking in the battery holder.

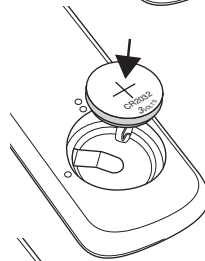

-  **NOTE:** When you use the remote control for the first time, there is a plastic sheet between the battery and its contact. Remove the sheet before use.

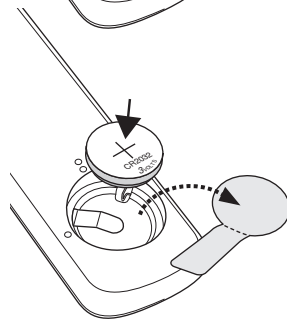

- 3 Rotate the battery lid clockwise to lock the battery cover.

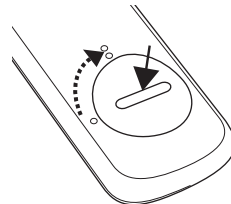

-  **NOTE:** Remote Control is not shipped with your projector.

6

Specifications

Digital Light Processing	0.45" WXGA S450 DMD, DarkChip3™
Brightness	500 ANSI Lumens (Max.)
Contrast Ratio	10000:1 Typical (Full On/Full Off)
Uniformity	85% Typical (Japan Standard - JBMA)
Number of Pixels	1280 x 800 (WXGA)
Aspect Ratio	16:10
Internal Flash	7 GB Memory (Max.)
Displayable Color	1.07 billion colors
Projection Lens	F-Stop: F/2.0 f=14.95 mm Fixed Lens Throw ratio =1.5 wide and tele Offset ratio: 100%
Projection Screen Size	30~80 inches (diagonal)
Projection Distance	3.18~8.48 ft (97~258 cm)
Video Compatibility	Composite Video: NTSC (M, 3.58, 4.43), PAL (B, D, G, H, I, M, N, 4.43), SECAM (B, D, G, K, K1, L, 4.25, 4.4) Component Video input via VGA: 1080i (50/60 Hz), 720p (50/60 Hz), 576i/p, 480i/p HDMI input: 1080p, 720p, 576i/p, 480i/p
Power Supply	Universal AC 100-240 V 50-60 Hz with 65 W power adapter

Power Consumption	Normal mode: 52 W \pm 10% @ 110 Vac Eco mode: 42 W \pm 10% @ 110 Vac Power saving mode: < 0.5 W (Fan speed at minimum) Standby mode: < 0.5 W
Audio	1 speaker x 1 watt RMS
Noise Level	Normal mode: 36 dB(A) Typical Eco mode: 32 dB(A) Typical
Weight	0.8 lbs \pm 0.05 lbs (0.36 kg \pm 0.02 kg)
Dimensions (W x H x D)	4.14 x 1.43 x 4.09 inches (105.3 x 36.5 x 104 mm)

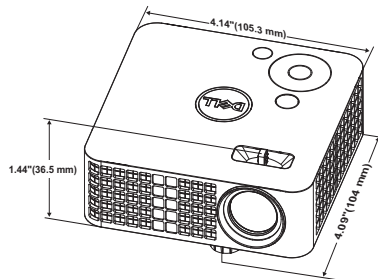

Environmental	Operating temperature: 5 °C - 35 °C (41 °F- 95 °F) Humidity: 80% maximum Storage temperature: 0 °C to 60 °C (32 °F to 140 °F) Humidity: 90% maximum Shipping temperature: -20 °C to 60 °C (-4 °F to 140 °F) Humidity: 90% maximum
I/O Connectors	Power: One DC power jack HDMI input: One HDMI connector for supporting HDMI 1.3. HDCP compliant. Audio output: One 3.5 mm stereo mini phone jack.

I/O Connectors	<p>USB (type A) port: One USB connector for supporting USB display, multimedia playback (Video/Music/Photo/Office Viewer), USB memory storage access (USB flash drive/internal memory), and supporting projector, media, and image processor firmware upgrade, and supporting optional wireless dongle.</p> <p>The USB thumb drive can support up to 32 GB.</p>
Wireless Dongle (Optional)	<p>Wireless Standard: IEEE 802.11b/g/n</p> <p>Wireless: One USB (type A) connector for supporting wireless dongle (USB interface, optional) and EZCast Pro.</p> <p>OS environment: Windows 8/7/Vista/XP/2000, MAC OS X</p> <p>Supports EZCast Pro.</p>
Light Source	Mercury-free LED (up to 30000 hours in Normal mode)



NOTE: The LED life rating for any projector is a measure of brightness degradation only, and is not a specification for the time it takes a LED to fail and cease light output. LED life is defined as the time it takes for more than 50 percent of a LED sample population to have brightness decrease by approximately 50 percent of the rated lumens for the specified LED. The LED life rating is not guaranteed in any way. The actual operating life span of a projector LED will vary according to operating conditions and usage patterns. Usage of a projector in stressful conditions which may include dusty environments, under high temperatures, many hours per day, and abrupt powering-off will most likely result in a LED's shortened operating life span or possible LED failure.

Compatibility Modes (Digital)

Resolution	Refresh Rate (Hz)	Hsync Frequency (KHz)	Pixel Clock (MHz)
640 x 350	70.087	31.469	25.175
640 x 480	59.940	31.469	25.175
720 x 480 p60	59.940	31.469	27.000
720 x 576 p50	50.000	31.250	27.000
720 x 400	70.087	31.469	28.322
640 x 480	75.000	37.500	31.500
640 x 480	85.008	43.269	36.000
800 x 600	60.317	37.879	40.000
800 x 600	75.000	46.875	49.500
800 x 600	85.061	53.674	56.250
1024 x 768	60.004	48.363	65.000
1280 x 720 p50	50.000	37.500	74.250
1280 x 720 p60	60.000	45.000	74.250
1920 x 1080 i50	50.000	28.125	74.250
1920 x 1080 i60	60.000	33.750	74.250
1280 x 720	59.855	44.772	74.500
1024 x 768	75.029	60.023	78.750
1280 x 800	59.810	49.702	83.500
1366 x 768	59.790	47.712	85.500
1360 x 768	60.015	47.712	85.500
1024 x 768	84.997	68.677	94.500
1440 x 900	59.887	55.935	106.500
1280 x 1024	60.020	63.981	108.000
1400 x 1050	59.978	65.317	121.750
1280 x 800	84.880	71.554	122.500
1280 x 1024	75.025	79.976	135.000
1440 x 900	74.984	70.635	136.750
1680 x 1050	59.954	65.290	146.250
1280 x 960	85.002	85.938	148.500
1920 x 1080	60.000	67.500	148.500

7

Additional Information

For additional information on how to use your projector, please see the **Dell Projectors User Guide** at www.dell.com/support/manuals.

8

Contacting Dell

For customers in the United States, call 800-WWW-DELL (800-999-3355).



NOTE: If you do not have an active Internet connection, you can find contact information on your purchase invoice, packing slip, bill, or Dell product catalog.

Dell provides several online and telephone-based support and service options. Availability varies by country and product, and some services may not be available in your area. To contact Dell for sales, technical support, or customer service issues:

- 1 Visit **www.dell.com/contactDell**.
- 2 Select your country from the displayed list.
- 3 Select a Segment for Contact.
- 4 Select the appropriate service or support link based on your need.

Index

A

Adjusting the Projected Image
11

Adjusting the Projector Height
11

lower the projector
Front tilt adjustment
wheel 11

Adjusting the Projector Zoom
and Focus 12

C

Connecting the Projector
AC adaptor 23
Power cord 23

Connection Ports
DC input connector 6
HDMI connector 6

Contact Dell 4, 43

D

Dell
contacting 51, 52

M

Main Unit 5
Control panel 5
Elevator button for height

adjustments 5
Focus ring 5
Lens 5

O

On-Screen Display 16

P

phone numbers 52

R

Remote Control 16

S

Specifications
Aspect Ratio 47
Audio 48
Brightness 47
Contrast Ratio 47
Digital Light Processing 47
Dimensions 48
Displayable Color 47
Environmental 48
I/O Connectors 48
Internal Flash 47
Noise Level 48
Number of Pixels 47
Power Consumption 48

- Power Supply 47
- Projection Distance 47
- Projection Lens 47
- Projection Screen Size 47
- Uniformity 47
- Video Compatibility 47
- Weight 48

support

- contacting Dell 51, 52

T

telephone numbers 52

Troubleshooting

- Contact Dell 42