

# IFP41-1 Series

## VS21061/VS21062/VS21063/VS21064/VS21065

### ViewBoard series

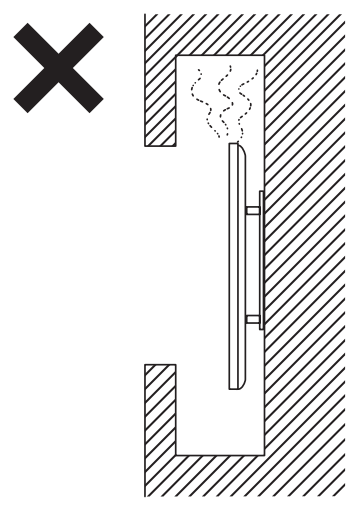
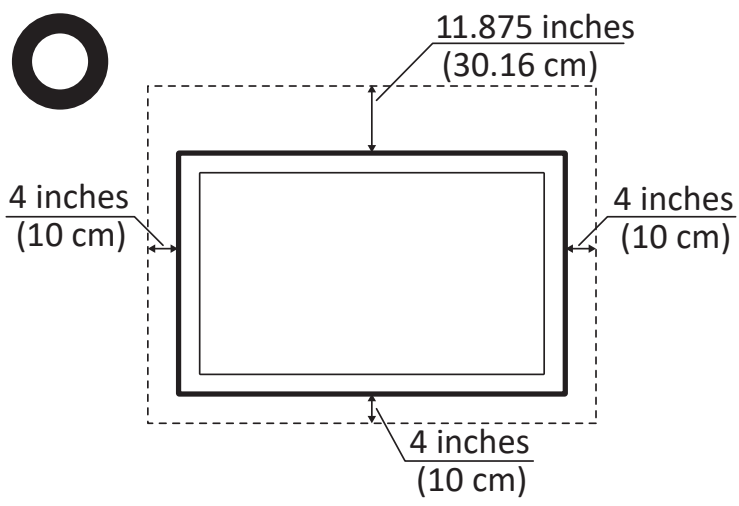
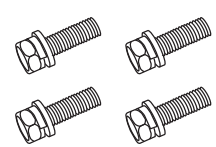
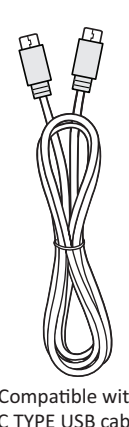
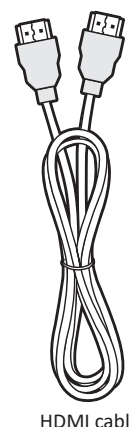
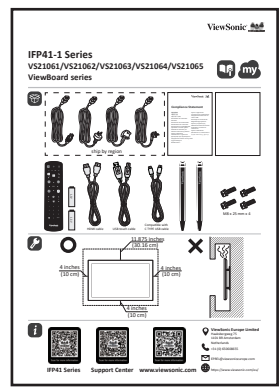
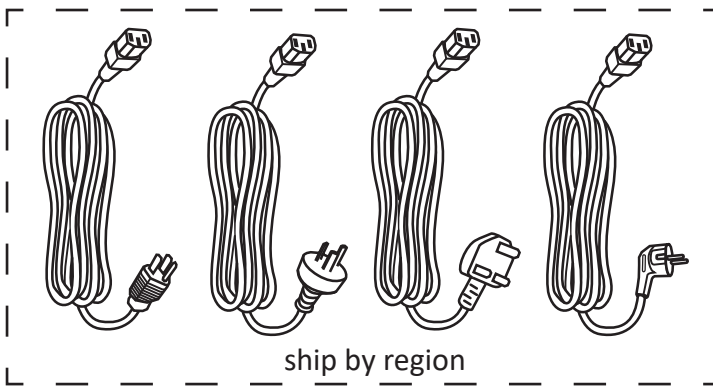

**ViewSonic Europe Limited**  
 Haaksbergweg 75  
 1101 BR Amsterdam  
 Netherlands  
 +31 (0) 650608655  
 EPREL@viewsoniceurope.com  
<https://www.viewsonic.com/eu/>

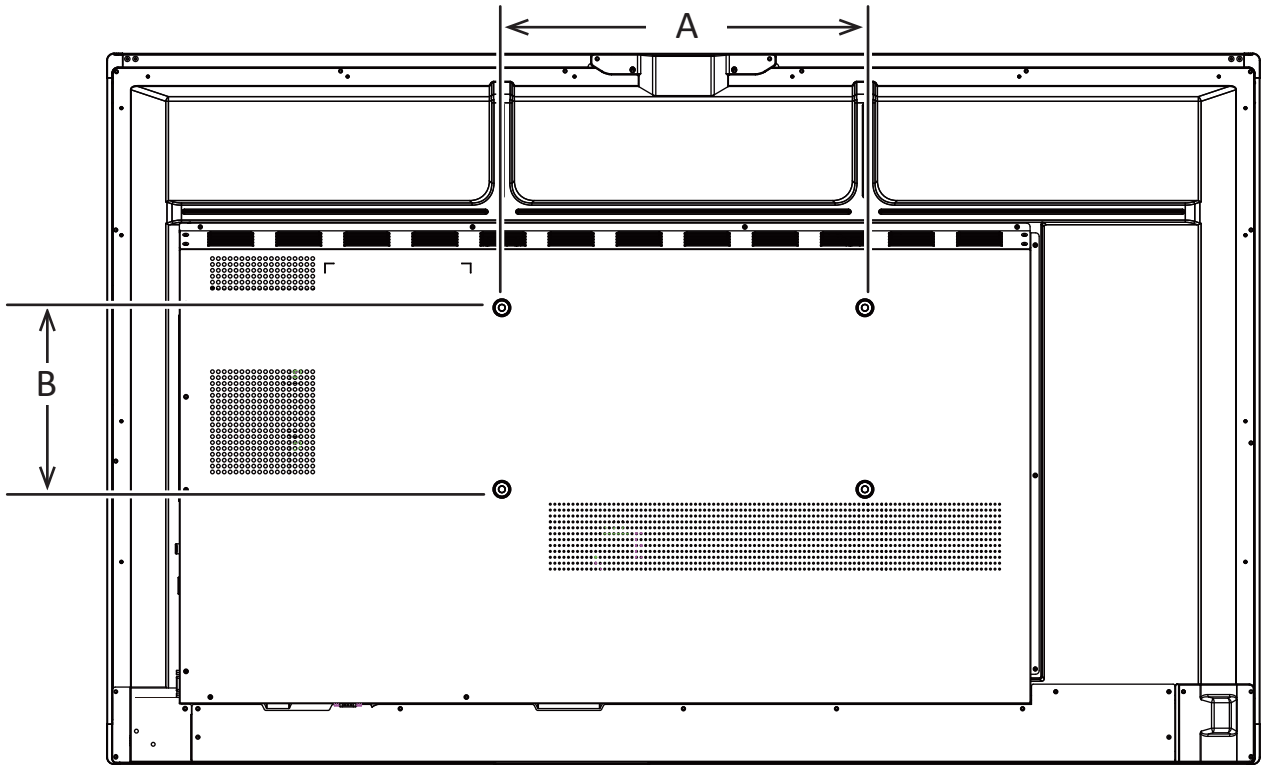

IFP5541-1	400 x 200 mm (A x B)	IFP8641-1	800 x 600 mm (A x B)
IFP6541-1	600 x 400 mm (A x B)	IFP9841-1	800 x 600 mm (A x B)
IFP7541-1	800 x 400 mm (A x B)		

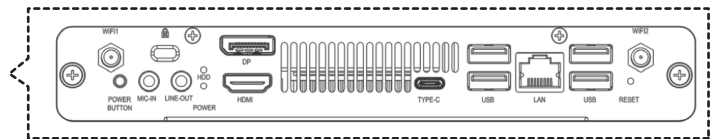
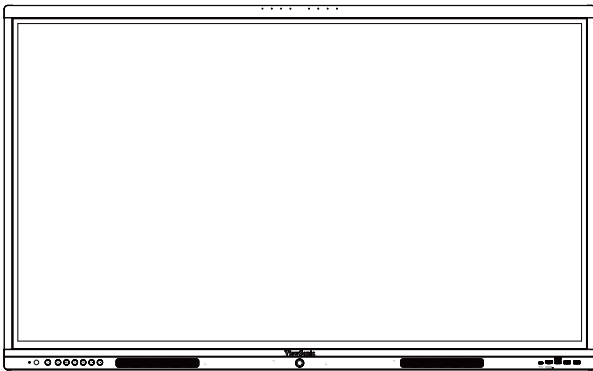

Optional OPS  
 VPC35 / VPCF5 / VPC37 / VPC-A31  
 VPC11/VPC13/VPC15

