



P/N: 15G065123000AK V1.0

# Quick Installation Guide 2U4G-EPYC



## Cable List

Item	Description
A	GPU Power Cable (Red & Orange /L=800mm ; Blue & Green /L=500mm)
B	PMBus Cable (L=390mm)
C	Power ATX Cable (8PIN) (L=350mm)
D	Power ATX Cable (24 PIN TO 24 PIN ) (L=150mm)
E	SWB Power Cable (SWB CABLE 2*6P(3.0)PWR; L=400mm)
F	HDD Power Cable (HDD PWR 2*4P TO 2*6P; L=800mm)
G	MNG Cable (L=960mm)
H	MINISAS HD TO 4*SATA+SGPIO Cable (L=700mm)
I	USB Cable (USD 3.0(20P) TO 2*5P HEADER) (L=880mm)
J	Front Control Cable (2*10P(2.0)TO 2*10P+2*5P(2.54))
K	SLIMLINE Cables (L=800mm / 500mm)
L	OcuLink Cables (L=600mm)

## Board Connection

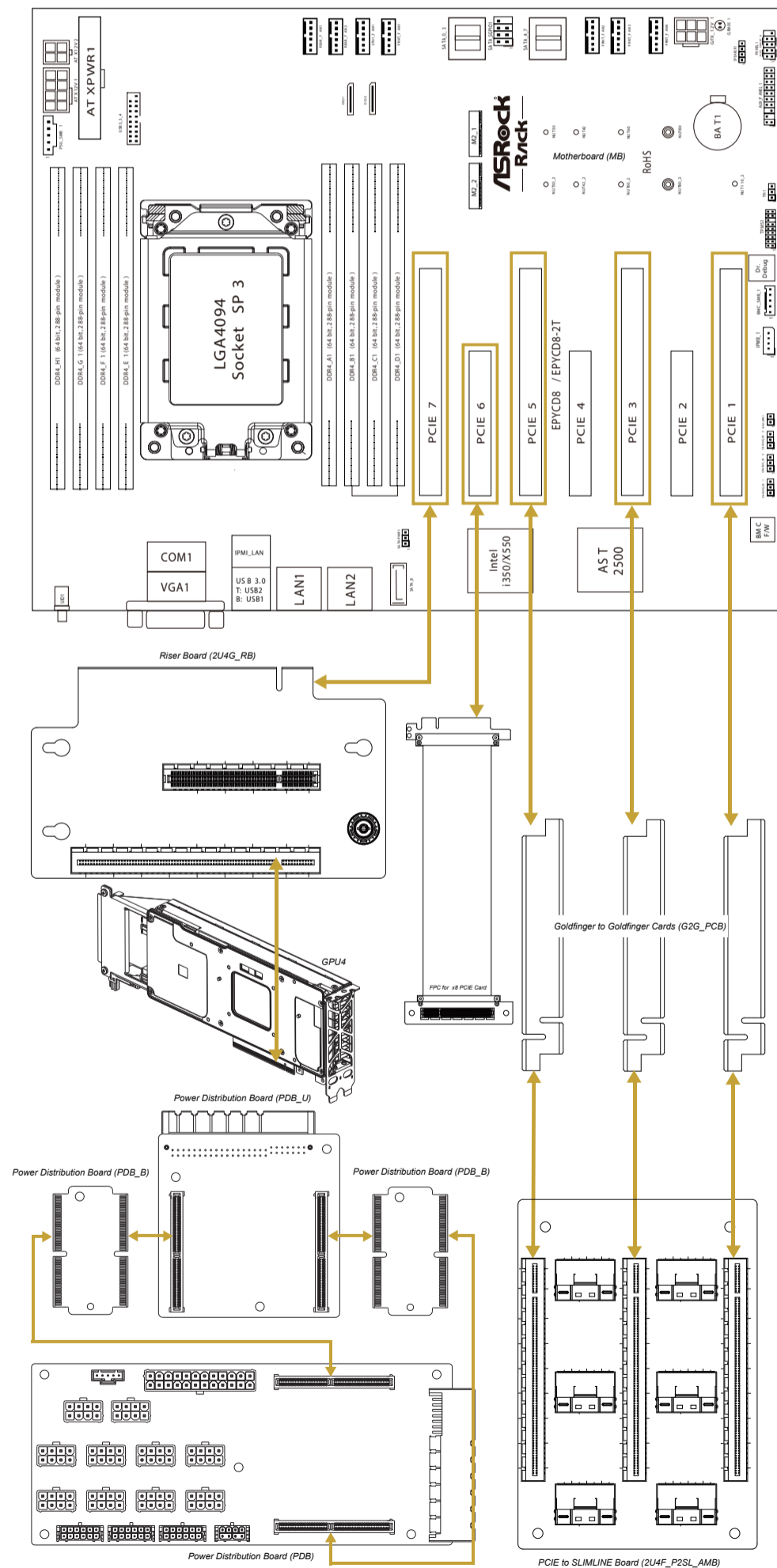

## Power Cable Connection

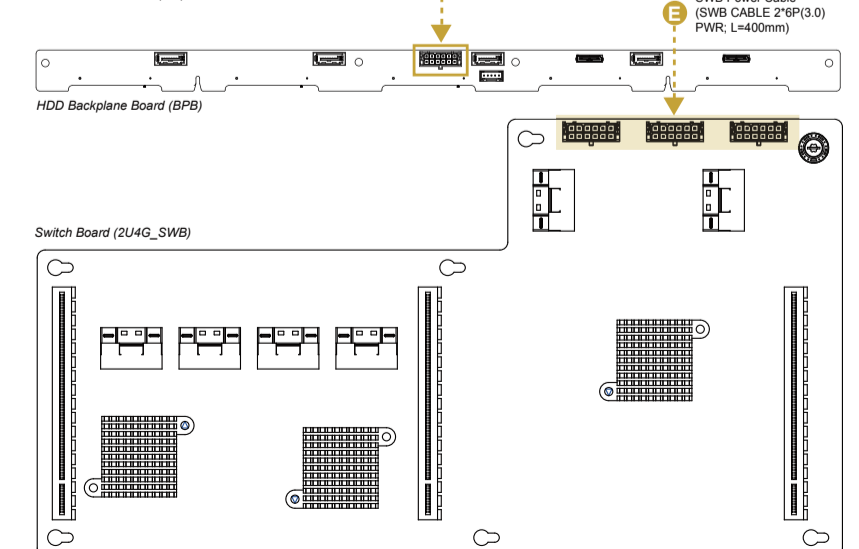
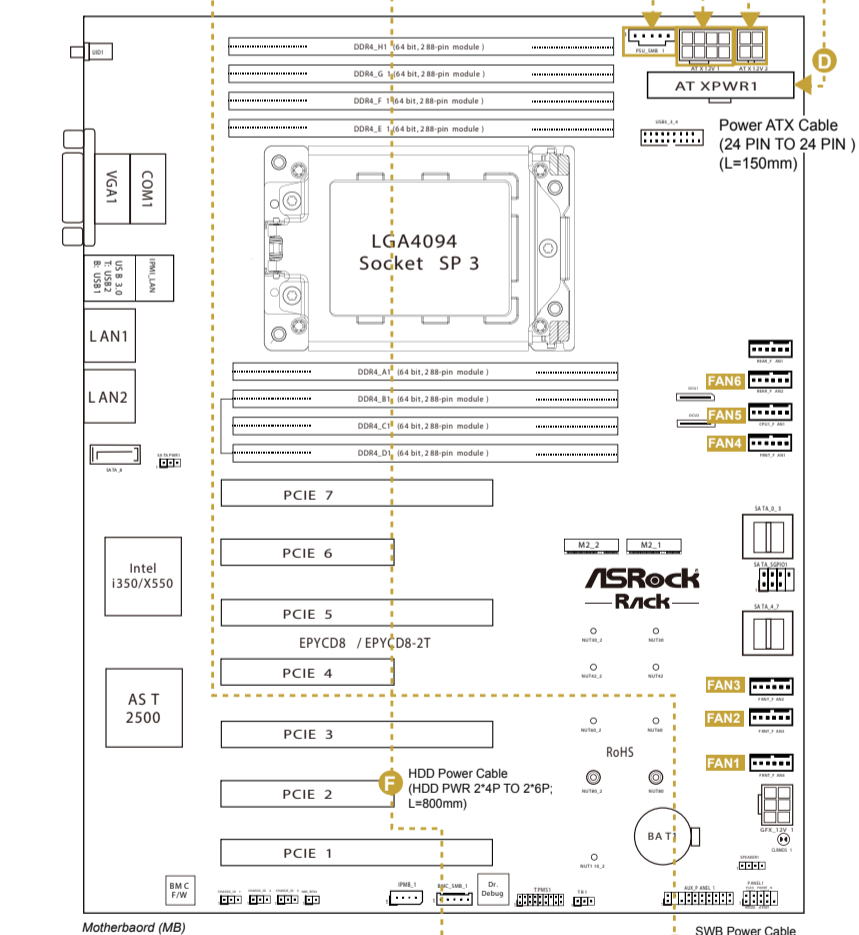
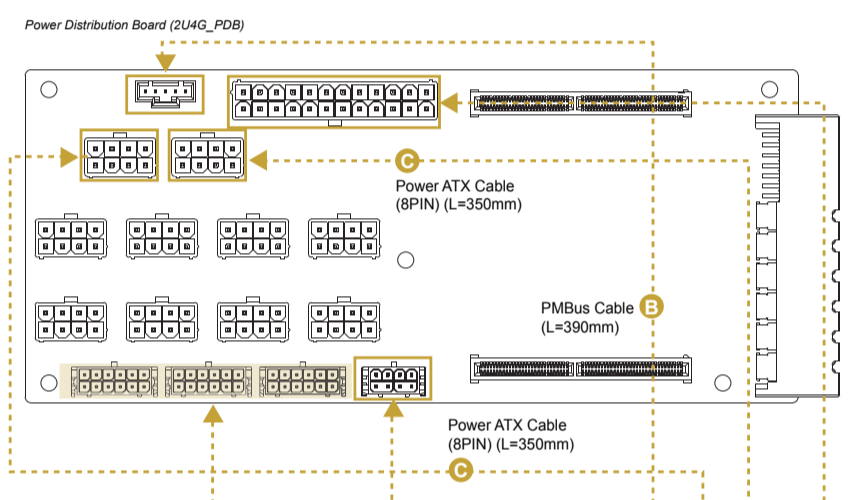
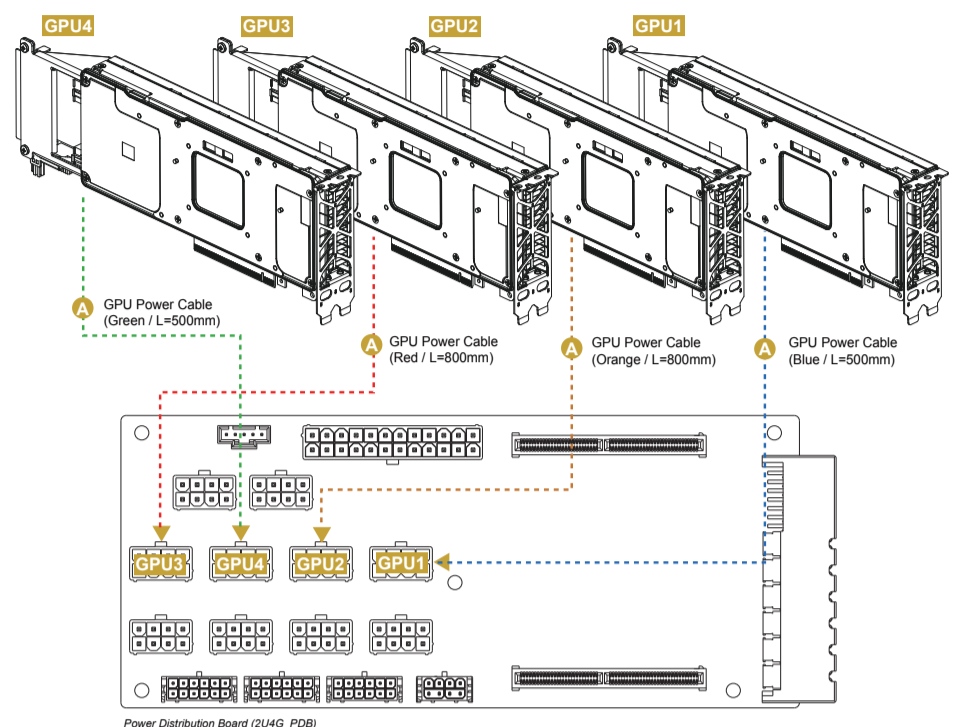

Riser Card Connection

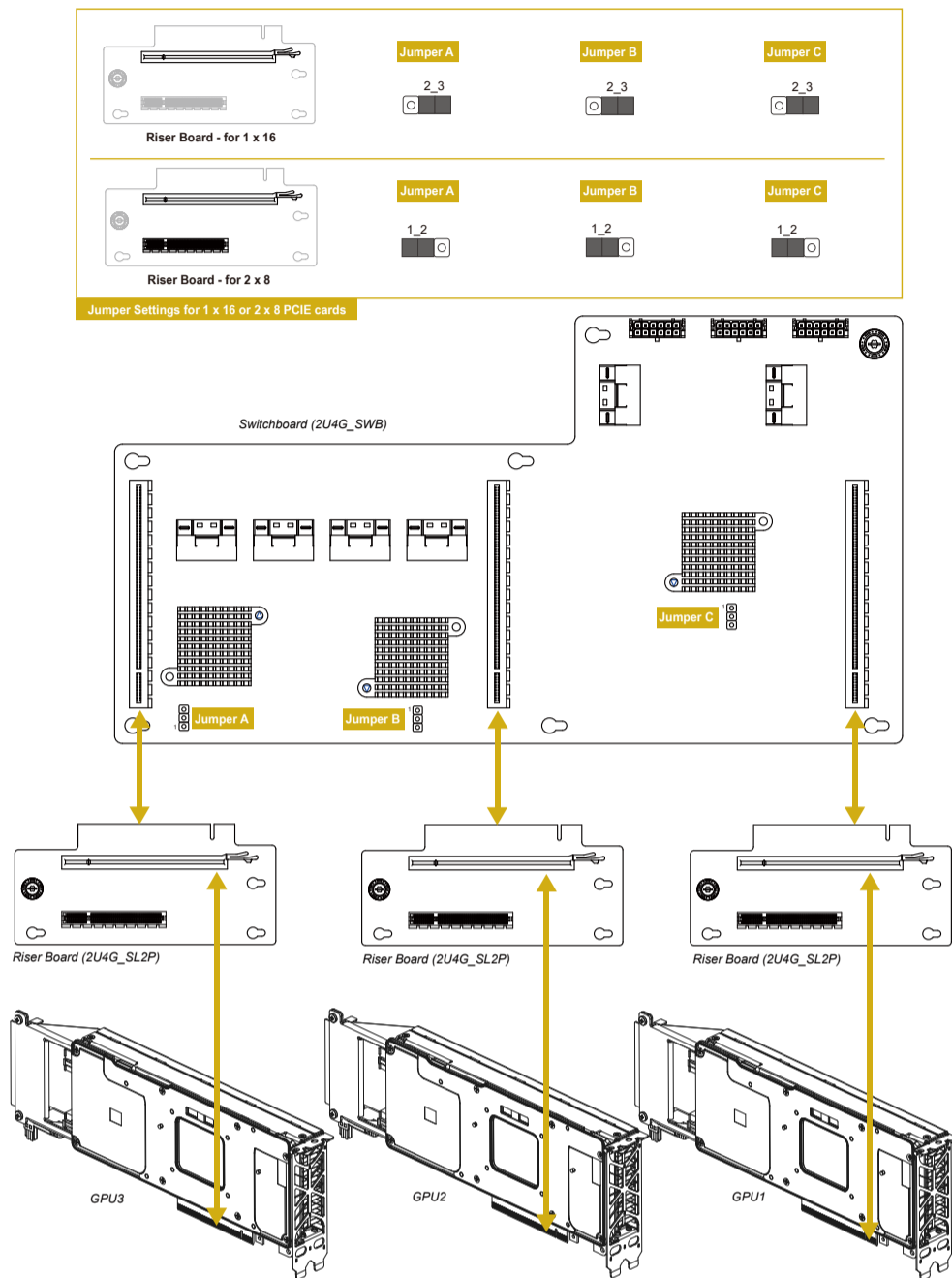

Front Panel Cable Connection

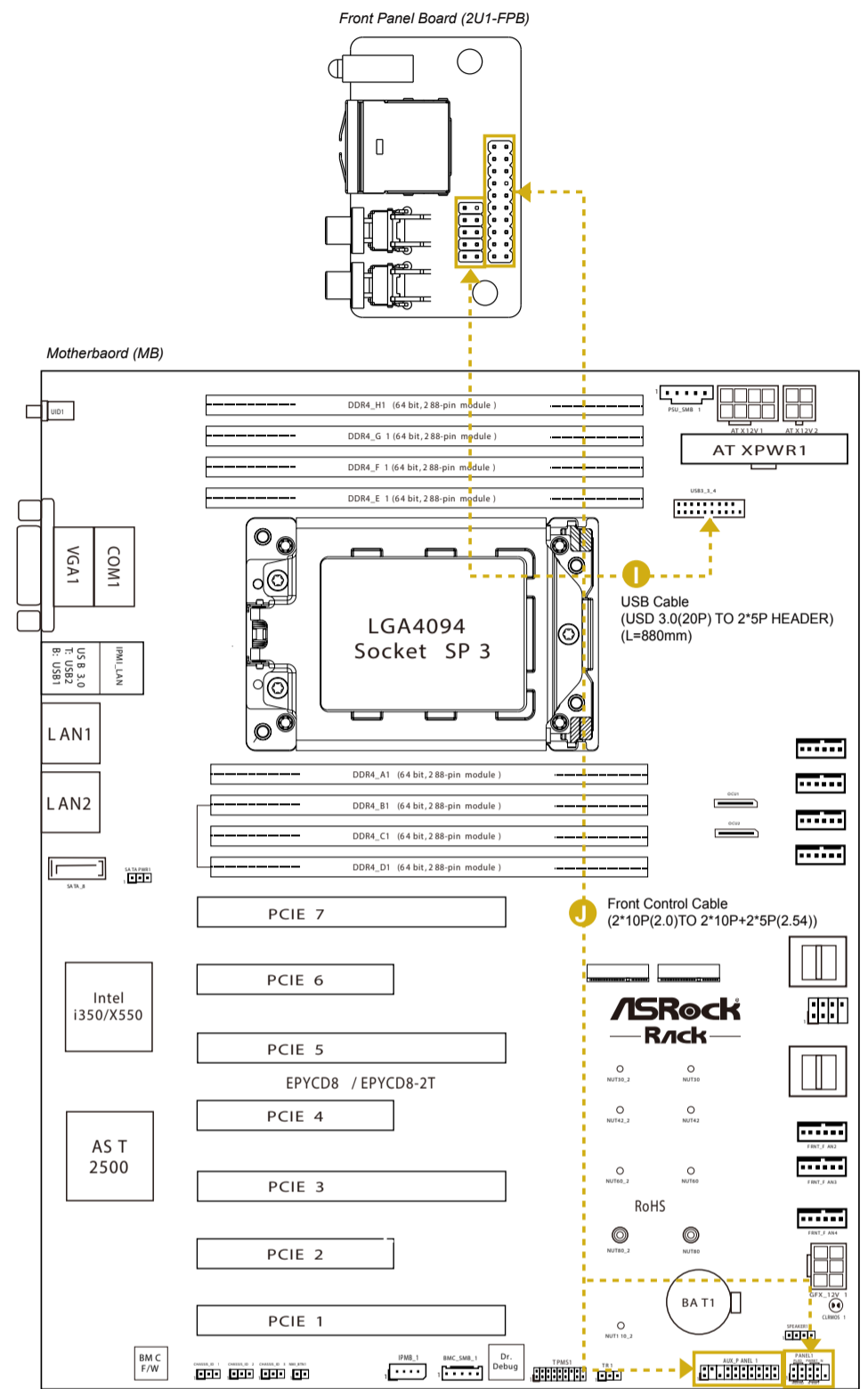

System Front View (HDD Slots)

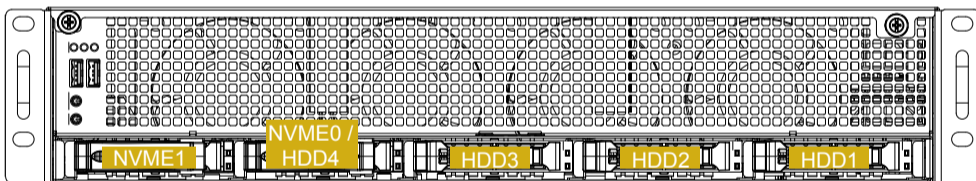

MINISAS HD to SATA Cable / OcuLink Cable Connection

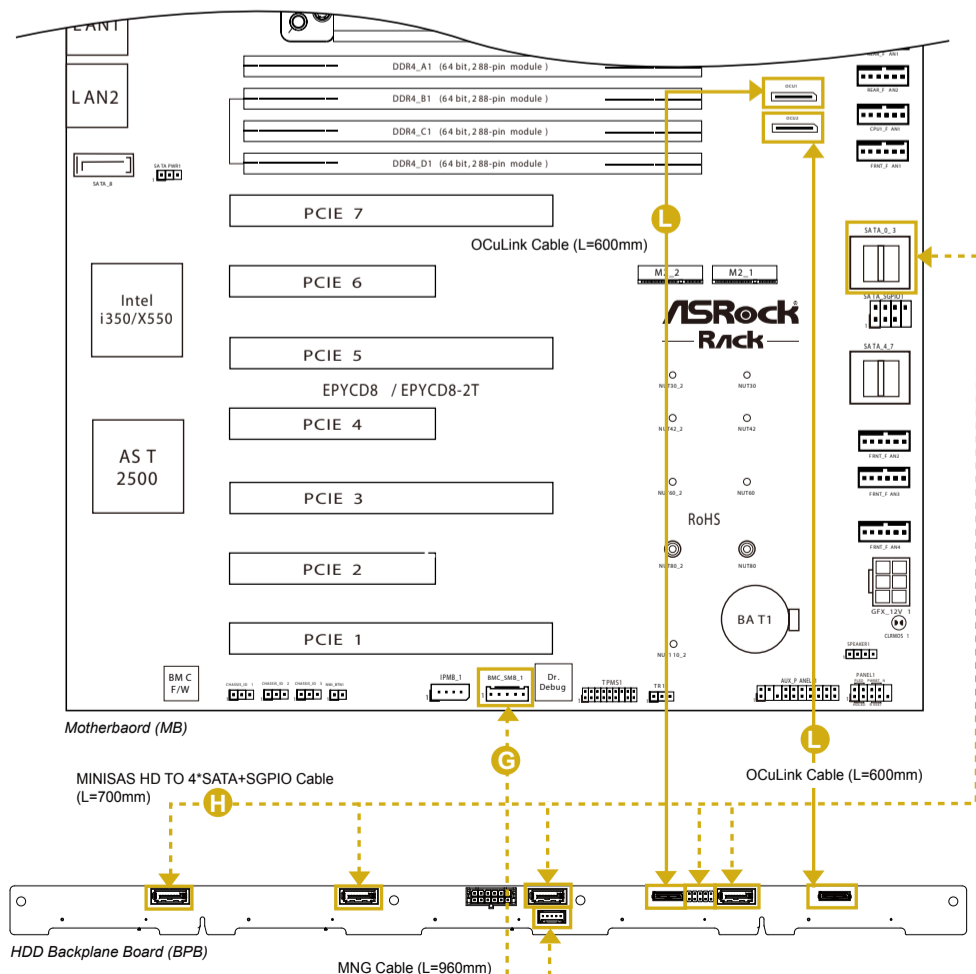

SLIMLINE Cable Connection

