

Intel® NUC Board/Kit NUC7i5DN

Technical Product Specification

February 2018

Intel® NUC Board NUC7i5DN may contain design defects or errors known as errata that may cause the product to deviate from published specifications. Current characterized errata, if any, are documented in Intel NUC Board NUC7i5DN Specification Update.

Revision History

Revision	Revision History	Date
100	First release of the Intel NUC Board/Kit NUC7i5DN Technical Product Specification	September 2017
101	Additional Specifications	September 2017
102	Clarifying Specifications	October 2017
103	Additional Explanations	February 2018
104	Added Clarifications	March 2018

Disclaimer

This product specification applies to only the standard Intel NUC Board with BIOS identifier DNKBLi50.86A. INFORMATION IN THIS DOCUMENT IS PROVIDED IN CONNECTION WITH INTEL® PRODUCTS. NO LICENSE, EXPRESS OR IMPLIED, BY ESTOPPEL OR OTHERWISE, TO ANY INTELLECTUAL PROPERTY RIGHTS IS GRANTED BY THIS DOCUMENT. EXCEPT AS PROVIDED IN INTEL'S TERMS AND CONDITIONS OF SALE FOR SUCH PRODUCTS, INTEL ASSUMES NO LIABILITY WHATSOEVER, AND INTEL DISCLAIMS ANY EXPRESS OR IMPLIED WARRANTY, RELATING TO SALE AND/OR USE OF INTEL PRODUCTS INCLUDING LIABILITY OR WARRANTIES RELATING TO FITNESS FOR A PARTICULAR PURPOSE, MERCHANTABILITY, OR INFRINGEMENT OF ANY PATENT, COPYRIGHT OR OTHER INTELLECTUAL PROPERTY RIGHT. UNLESS OTHERWISE AGREED IN WRITING BY INTEL, THE INTEL PRODUCTS ARE NOT DESIGNED NOR INTENDED FOR ANY APPLICATION IN WHICH THE FAILURE OF THE INTEL PRODUCT COULD CREATE A SITUATION WHERE PERSONAL INJURY OR DEATH MAY OCCUR.

All Intel NUC Boards are evaluated as Information Technology Equipment (I.T.E.) for use in personal computers (PC) for installation in homes, offices, schools, computer rooms, and similar locations. The suitability of this product for other PC or embedded non-PC applications or other environments, such as medical, industrial, alarm systems, test equipment, etc. may not be supported without further evaluation by Intel.

Intel Corporation may have patents or pending patent applications, trademarks, copyrights, or other intellectual property rights that relate to the presented subject matter. The furnishing of documents and other materials and information does not provide any license, express or implied, by estoppel or otherwise, to any such patents, trademarks, copyrights, or other intellectual property rights.

Intel may make changes to specifications and product descriptions at any time, without notice.

Designers must not rely on the absence or characteristics of any features or instructions marked "reserved" or "undefined." Intel reserves these for future definition and shall have no responsibility whatsoever for conflicts or incompatibilities arising from future changes to them.

Intel processor numbers are not a measure of performance. Processor numbers differentiate features within each processor family, not across different processor families: Go to: [Learn About Intel® Processor Numbers](#)

Intel NUC may contain design defects or errors known as errata, which may cause the product to deviate from published specifications. Current characterized errata are available on request.

Contact your local Intel sales office or your distributor to obtain the latest specifications before placing your product order.

Intel, the Intel logo, Intel NUC and Intel Core are trademarks of Intel Corporation in the U.S. and/or other countries.

* Other names and brands may be claimed as the property of others.

Copyright © 2017 Intel Corporation. All rights reserved.

Board Identification Information

Basic Intel® NUC Board NUC7i5DNBE Identification Information

AA Revision	BIOS Revision	Notes
J71739-502	DNKBLi5v.86A.0039	1,2

Notes:

1. The AA number is found on a small label on the component side of the board.
2. The Intel® Core™ i5-7300U processor is used on this AA revision consisting of the following component:

Device	Stepping	S-Spec Numbers
Intel Core i5	H0	SR340

Production Identification Information

Intel® NUC Products NUC7i5DN{x} Identification Information

Product Name	Intel® NUC Board
NUC7i5DNKE	NUC7i5DNB
NUC7i5DNHE	
NUC7i5DNBE	

Specification Changes or Clarifications

The table below indicates the Specification Changes or Specification Clarifications that apply to the Intel NUC Board/Kit NUC7i5DN.

Specification Changes or Clarifications

Date	Type of Change	Description of Changes or Clarifications
2/2/2018	Clarification	Pin 1 designator on board silkscreen is incorrect for the following headers and connectors: USB 2.0, HDMI CEC, Serial Port, SATA Power, and eDP. The pinout information and pin 1 designators in the TPS are correct for these headers.

Errata

Current characterized errata, if any, are documented in a separate Specification Update. See <http://www.intel.com/content/www/us/en/nuc/overview.html> for the latest documentation.

Preface

This Technical Product Specification (TPS) specifies the board layout, components, connectors, power and environmental requirements, and the BIOS for Intel® NUC Board/Kits NUC7i5DN. Some features are only available on Kit SKUs.

Intended Audience

The TPS is intended to provide detailed, technical information about Intel® NUC Board/Kit NUC7i5DN and its components to the vendors, system integrators, and other engineers and technicians who need this level of information. It is specifically *not* intended for general audiences.

What This Document Contains

Chapter	Description
1	A description of the hardware used on Intel® NUC Board NUC7i5DNBE
2	A map of the resources of the Intel® NUC Board
3	The features supported by the BIOS Setup program
4	A description of the BIOS error messages, beep codes, and POST codes
5	Regulatory compliance and battery disposal information

Typographical Conventions

This section contains information about the conventions used in this specification. Not all of these symbols and abbreviations appear in all specifications of this type.

Notes, Cautions, and Warnings



NOTE

Notes call attention to important information.



CAUTION

Cautions are included to help you avoid damaging hardware or losing data.

Other Common Notation

#	Used after a signal name to identify an active-low signal (such as USBP0#)
GB	Gigabyte (1,073,741,824 bytes)
GB/s	Gigabytes per second
Gb/s	Gigabits per second
KB	Kilobyte (1024 bytes)
Kb	Kilobit (1024 bits)
kb/s	1000 bits per second
MB	Megabyte (1,048,576 bytes)
MB/s	Megabytes per second
Mb	Megabit (1,048,576 bits)
Mb/s	Megabits per second
TDP	Thermal Design Power
xxh	An address or data value ending with a lowercase h indicates a hexadecimal value.
x.x V	Volts. Voltages are DC unless otherwise specified.
x.x A	Amperes.
*	This symbol is used to indicate third-party brands and names that are the property of their respective owners.

Contents

Revision History	ii
Disclaimer	ii
Board Identification Information.....	iii
Errata.....	iii
Preface	iv
Intended Audience.....	iv
What This Document Contains	iv
Typographical Conventions	iv
Contents	vii
1 Product Description	13
1.1 Overview	13
1.1.1 Feature Summary	13
1.1.2 Board Layout (Top)	15
1.1.3 Board Layout (Bottom).....	16
1.1.4 Block Diagram	18
1.2 Online Support.....	19
1.3 Processor	19
1.4 System Memory	19
1.5 Processor Graphics Subsystem.....	22
1.5.1 Integrated Graphics	22
1.6 USB.....	25
1.7 SATA Interface.....	25
1.7.1 AHCI Mode.....	26
1.7.2 NVMe.....	26
1.7.3 Intel® Rapid Storage Technology / SATA RAID	26
1.7.4 Intel® Next Generation Storage Acceleration.....	26
1.8 Real-Time Clock Subsystem.....	28
1.9 Audio Subsystem Software.....	28
1.9.1 Audio Subsystem Software	28
1.10 LAN Subsystem.....	29
1.10.1 Intel® I219LM Gigabit Ethernet Controller	29
1.10.2 RJ-45 LAN Connector with Integrated LEDs	30
1.10.3 Wireless Network Module	31
1.11 Hardware Management Subsystem	31
1.11.1 Hardware Monitoring	31
1.11.2 Fan Monitoring.....	31
1.11.3 Thermal Solution	32
1.12 Power Management	33

1.12.1	ACPI	33
1.12.2	Hardware Support	35
1.13	Intel® Security and Manageability Technologies.....	37
1.13.1	Intel® vPro™ Technology	37
2	Technical Reference	41
2.1	Memory Resources	41
2.1.1	Addressable Memory	41
2.2	Connectors and Headers.....	41
2.2.1	Front Panel Connectors	42
2.2.2	Back Panel Connectors	42
2.2.3	Connectors and Headers (Top).....	43
2.2.4	Connectors and Headers (Bottom).....	44
2.3	BIOS Security Jumper	55
2.4	Intel® Management Engine BIOS Extension (Intel® MEBX) Reset Header	57
2.5	Mechanical Considerations	59
2.5.1	Form Factor.....	59
2.6	Electrical Considerations	61
2.6.1	Power Supply Considerations	61
2.6.2	Fan Header Current Capability.....	62
2.7	Thermal Considerations.....	63
2.8	Reliability	67
2.9	Environmental	67
3	Overview of BIOS Features	69
3.1	Introduction	69
3.2	BIOS Flash Memory Organization	69
3.3	System Management BIOS (SMBIOS)	69
3.4	Legacy USB Support	70
3.5	BIOS Updates.....	71
3.5.1	Language Support.....	71
3.5.2	BIOS Recovery.....	71
3.6	Boot Options.....	73
3.6.1	Network Boot.....	73
3.6.2	Booting Without Attached Devices	73
3.6.3	Changing the Default Boot Device during POST	73
3.6.4	Power Button Menu.....	74
3.7	Hard Disk Drive Password Security Feature.....	75
3.8	BIOS Security Features	76
4	Error Messages and Blink Codes	77
4.1	Front-panel Power LED Blink Codes.....	77
4.2	BIOS Error Messages.....	77

5	Regulatory Compliance and Battery Disposal Information	79
5.1	Regulatory Compliance.....	79
5.1.1	Safety Standards.....	79
5.1.2	European Union Declaration of Conformity Statement	79
5.1.3	EMC Regulations	80
5.1.4	e-Standby and ErP Compliance.....	82
5.1.5	Regulatory Compliance Marks (Board Level)	83
5.2	Battery Disposal Information	84

Figures

Figure 1. Major Board Components (Top)	15
Figure 2. Major Board Components (Bottom)	16
Figure 3. Block Diagram.....	18
Figure 4. Memory Channel and SO-DIMM Configuration.....	21
Figure 5. eDP Connector on Bottom-side of the Board	24
Figure 6. LAN Connector LED Locations.....	30
Figure 7. Thermal Solution and Fan Header	32
Figure 8. Location of the Standby Power LED	36
Figure 9. Front Panel Connectors.....	42
Figure 10. Back Panel Connectors	42
Figure 11. Connectors and Headers (Top).....	43
Figure 12. Connectors and Headers (Bottom)	44
Figure 13. Connection Diagram for Front Panel Header (2.0 mm Pitch)	52
Figure 14. Connection Diagram for the Internal Power Supply Connector.....	54
Figure 15. Location of the BIOS Security Jumper	55
Figure 16. Intel MEBX Reset Header	58
Figure 17. Board Dimensions	59
Figure 18. Board Height Dimensions	60
Figure 19. Localized High Temperature Zones	64
Figure 20. Installation Area of the Thermal Pad	65

Tables

Table 1. Feature Summary.....	13
Table 2. Components Shown in Figure 2.....	17
Table 3. Supported Memory Configurations.....	20
Table 4. Unsupported Memory Configurations	20
Table 5. LAN Connector LED States.....	30
Table 6. Effects of Pressing the Power Switch	33
Table 7. Power States and Targeted System Power	34
Table 8. Wake-up Devices and Events.....	35
Table 9. Connectors and Headers Shown in Figure 11.....	43
Table 10. Connectors and Headers Shown in Figure 12	45
Table 11. SATA Power Header (1.25 mm pitch)	46
Table 12. Internal USB 2.0 Header (1.25 mm pitch).....	46
Table 13. Internal USB 3.0 Header (1.25 mm pitch).....	47
Table 14. Serial Port Header (1.25 mm pitch).....	47
Table 15. HDMI CEC Header (1.25 mm pitch)	48
Table 16. M.2 2280 Module (Mechanical Key M) Connector	48
Table 17. M.2 2230 Module (Mechanical Key E) Connector	49
Table 18. 40-Pin eDP Connector.....	51
Table 19. Front Panel Header (2.0 mm Pitch).....	52
Table 20. States for a One-Color Power LED.....	53
Table 21. States for a Dual-Color Power LED	53
Table 22. 12-24 V Internal Power Supply Connector	54
Table 23. BIOS Security Jumper Settings.....	56
Table 24. Intel MEBX Reset Header Signals.....	58
Table 25. Power Budget for Assessing the DC-to-DC Circuit's Power Rating (worst case: Embedded board in 3 rd party chassis)	61
Table 26. Fan Header Current Capability.....	62
Table 27. Thermal Considerations for Components	66
Table 28. Tcontrol Values for Components	66
Table 29. Environmental Specifications.....	67
Table 30. Acceptable Drives/Media Types for BIOS Recovery	71
Table 31. Boot Device Menu Options.....	73
Table 32. Master Key and User Hard Drive Password Functions.....	75
Table 33. Supervisor and User Password Functions	76
Table 34. Front-panel Power LED Blink Codes	77
Table 35. BIOS Error Messages.....	77
Table 36. Safety Standards.....	79
Table 37. EMC Regulations	81
Table 38. Regulatory Compliance Marks	83

1 Product Description

1.1 Overview

1.1.1 Feature Summary

Table 1 summarizes the major features of Intel® NUC Board NUC7i5DNBE.

Table 1. Feature Summary

Form Factor	4.0 inches by 4.0 inches (101.60 millimeters by 101.60 millimeters)
Processor	Intel® NUC Board NUC7i5DNBE has a soldered-down 7 th generation Intel® Core™ i5-7300U dual-core processor with up to 15 W TDP <ul style="list-style-type: none"> — Intel® HD Graphics 620 — Integrated memory controller — Integrated PCH
Memory	Two 260-pin 1.2 V DDR4 SDRAM Small Outline Dual Inline Memory Module (SO-DIMM) sockets <ul style="list-style-type: none"> — Support for DDR4 1866/2133 MHz SO-DIMMs — Support for 4 Gb and 8 Gb memory technology — Support for up to 32 GB of system memory with two SO-DIMMs using 8 Gb memory technology — Support for non-ECC memory — Support for 1.2 V low voltage JEDEC memory only <p>Note: 2 Gb memory technology (SDRAM Density) is not compatible</p>
Graphics	Integrated graphics support for processors with Intel® Graphics Technology: <ul style="list-style-type: none"> — Two High Definition Multimedia Interface* 2.0a (HDMI*) back panel connectors — Flat panel displays via the internal Embedded DisplayPort* 1.4 (eDP) connector
Audio	Intel® High Definition (Intel® HD) Audio via the HDMI v2.0a interface through the processor
Storage	SATA ports: <ul style="list-style-type: none"> — One SATA 6.0 Gb/s port (blue) — One SATA 6.0 Gb/s port is reserved for an M.2 2280 module <p>Note: Intel® NUC Board NUC7i5DNBE supports key type M (PCI Express* x1/x2/x4 and SATA)</p>
Peripheral Interfaces	USB 3.0 ports: <ul style="list-style-type: none"> — Two ports are implemented with external front panel connectors (blue) — Two ports are implemented with external back panel connectors (blue) — One port is implemented with an internal 1x10 1.25mm pitch header (white) <p>USB 2.0 ports:</p> <ul style="list-style-type: none"> — Two ports via two single-port internal 1x4 1.25 mm pitch headers (white) — One port is reserved for an M.2 2230 Module (key type E) <p>Serial Port 1x9 1.25mm pitch header(black)</p> <p>HDMI CEC 1x4 1.25 mm pitch header (black)</p>

continued

Table 1. Feature Summary (continued)

Expansion Capabilities	One M.2 Module supporting M.2 2280 (key type M) One M.2 Module supporting M.2 2230 (key type E)
BIOS	Intel® BIOS resident in the Serial Peripheral Interface (SPI) Flash device Support for Advanced Configuration and Power Interface (ACPI), Plug and Play, and System Management BIOS (SMBIOS)
LAN	Gigabit (10/100/1000 Mb/s) LAN subsystem using the Intel® I219LM Gigabit Ethernet Controller
Hardware Monitor Subsystem	Hardware monitoring subsystem, based on ITE Tech. ITE8987E-VG embedded controller, including: Voltage sense to detect out of range power supply voltages Thermal sense to detect out of range thermal values One processor fan header Fan sense input used to monitor fan activity Fan speed control
Wireless (Kit only)	Intel® Dual Band Wireless-AC vPro 8265 — 802.11ac, Dual Band, 2x2 Wi-Fi + Bluetooth v4.2 — Maximum Transfer speed up to 867 Mbps Supports Intel® Smart Connect Technology
Intel® vPro™ Technologies	Intel® Active Management Technology (Intel® AMT) 11.6 Intel® Virtualization (Intel® VT-x) Intel® Virtualization for Directed I/O (Intel® VT-d) Intel® Trusted Execution Technology (Intel® TXT) Intel® Identity Protection Technology (Intel® IPT) Intel® Software Guard Extensions (Intel® SGX) Intel® Transparent Supply Chain (Intel® TSC) Trusted Platform Module (TPM) 2.0

1.1.2 Board Layout (Top)

Figure 1 shows the location of the major components on the top-side of Intel NUC Board NUC7i5DNBE.

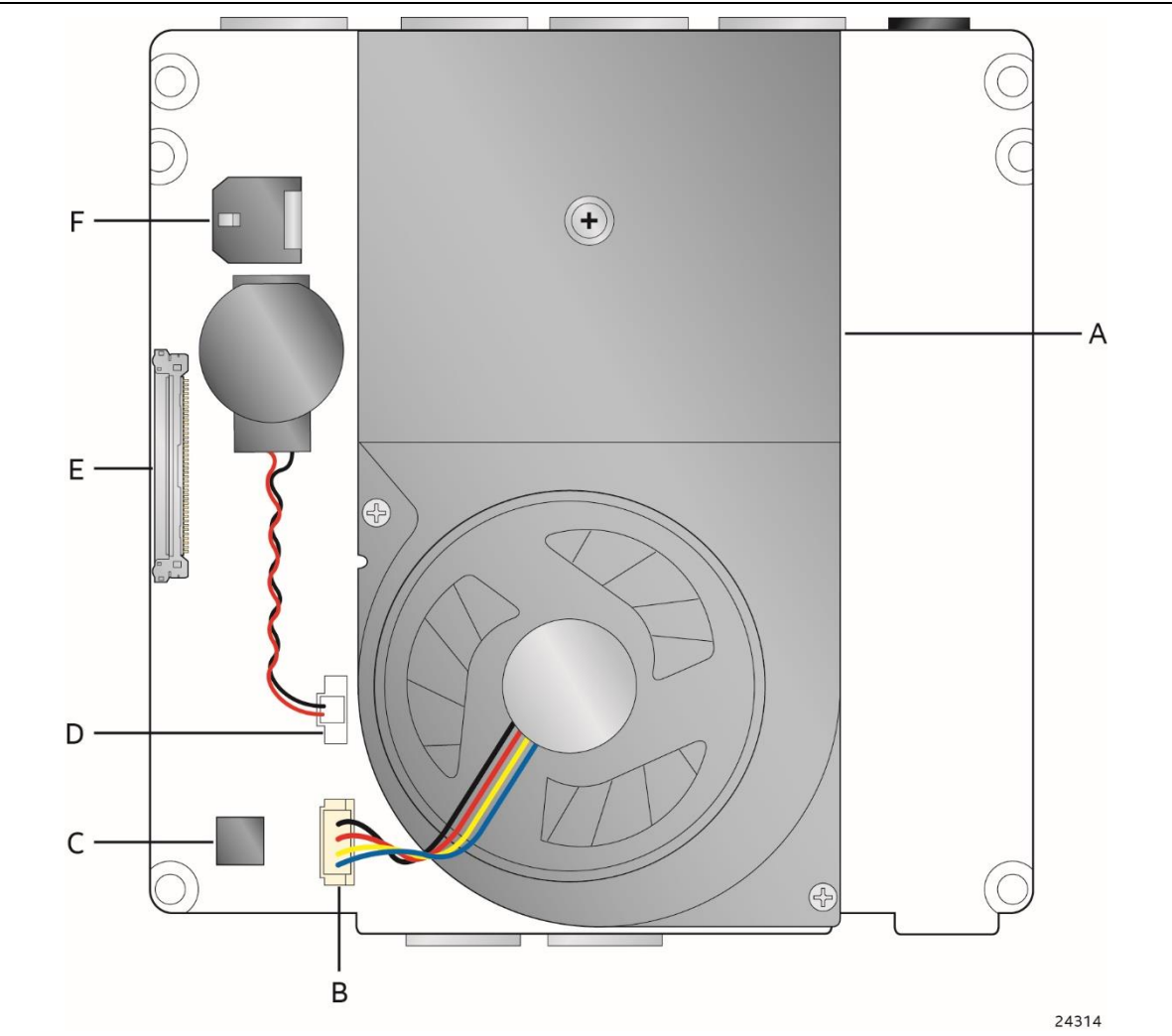

Figure 1. Major Board Components (Top)

Table 2. Components Shown in Figure 1

Item from Figure 1	Description
A	Thermal Solution
B	Processor Fan Header
C	SPI
D	Battery Header
E	eDP Connector
F	DC Internal Power Connector

1.1.3 Board Layout (Bottom)

Figure 2 shows the location of the major components on the bottom-side of Intel NUC Board NUC7i5DNBE.

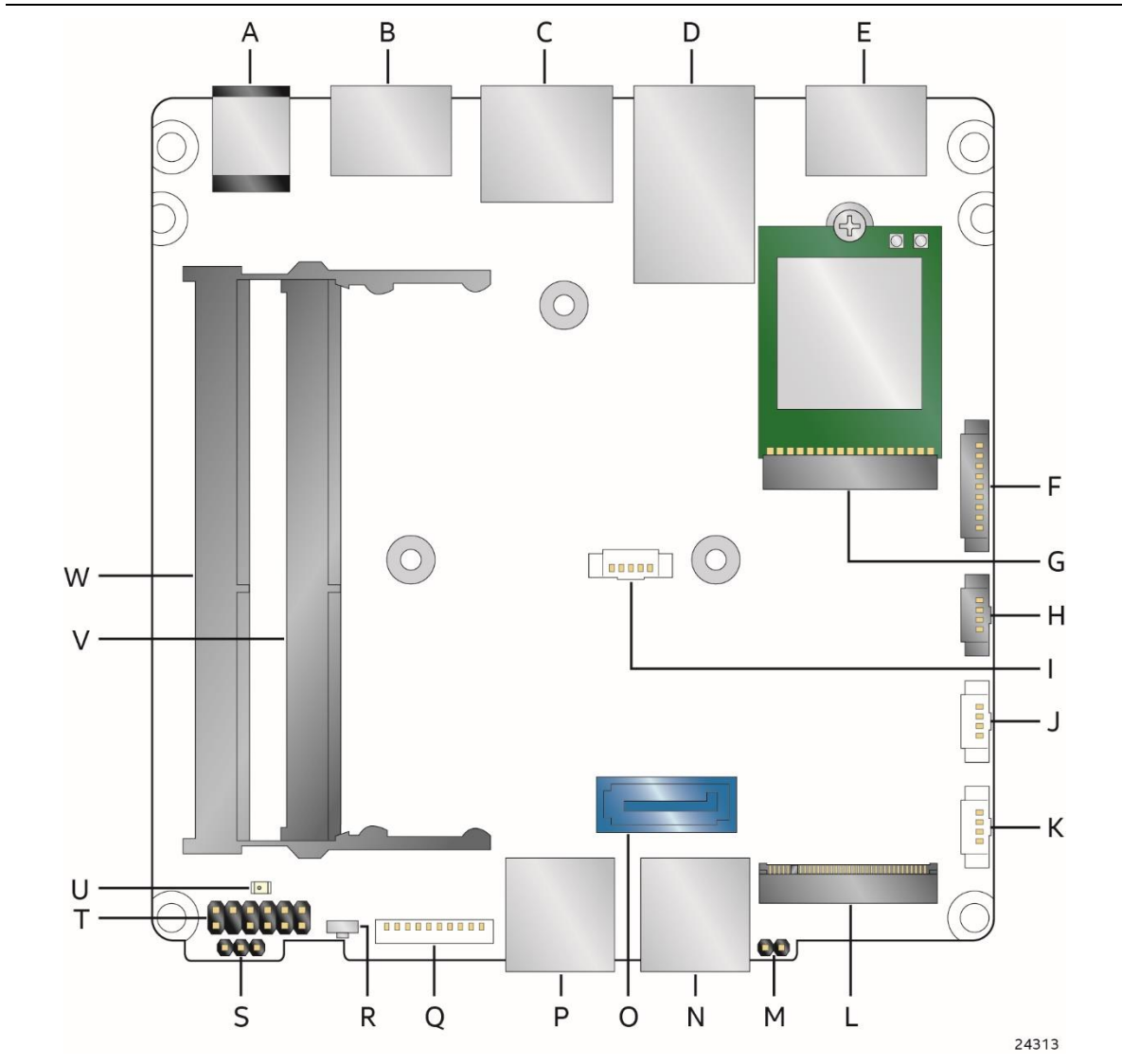

Figure 2. Major Board Components (Bottom)

Table 2. Components Shown in Figure 2

Item from Figure 2	Description
A	12-24 V DC Input Jack
B	HDMI 2.0a Port 1 with HDCP 2.2 Support and Built-In CEC Support
C	LAN Connector
D	Back Panel USB 3.0
E	HDMI 2.0a Port 2
F	Serial Port Header
G	M.2 2230 Module Connector (Key Type E) (Wireless card on Kit only)
H	HDMI CEC
I	SATA Power Header
J	USB 2.0 Header
K	USB 2.0 Header
L	M.2 2280 Module Connector (Key Type M)
M	Intel® Management Engine BIOS Extension (Intel® MEBX) Reset Header
N	Front Panel USB 3.0
O	SATA 6.0 Gb/s Connector
P	Front Panel USB 3.0
Q	USB 3.0 Header
R	Front Panel Power Button
S	BIOS Security Header
T	Front Panel Header
U	Standby Power LED
V	DDR4 SO-DIMM 2 Socket
W	DDR4 SO-DIMM 1 Socket

1.1.4 Block Diagram

Figure 3 is a block diagram of the major functional areas of the board.

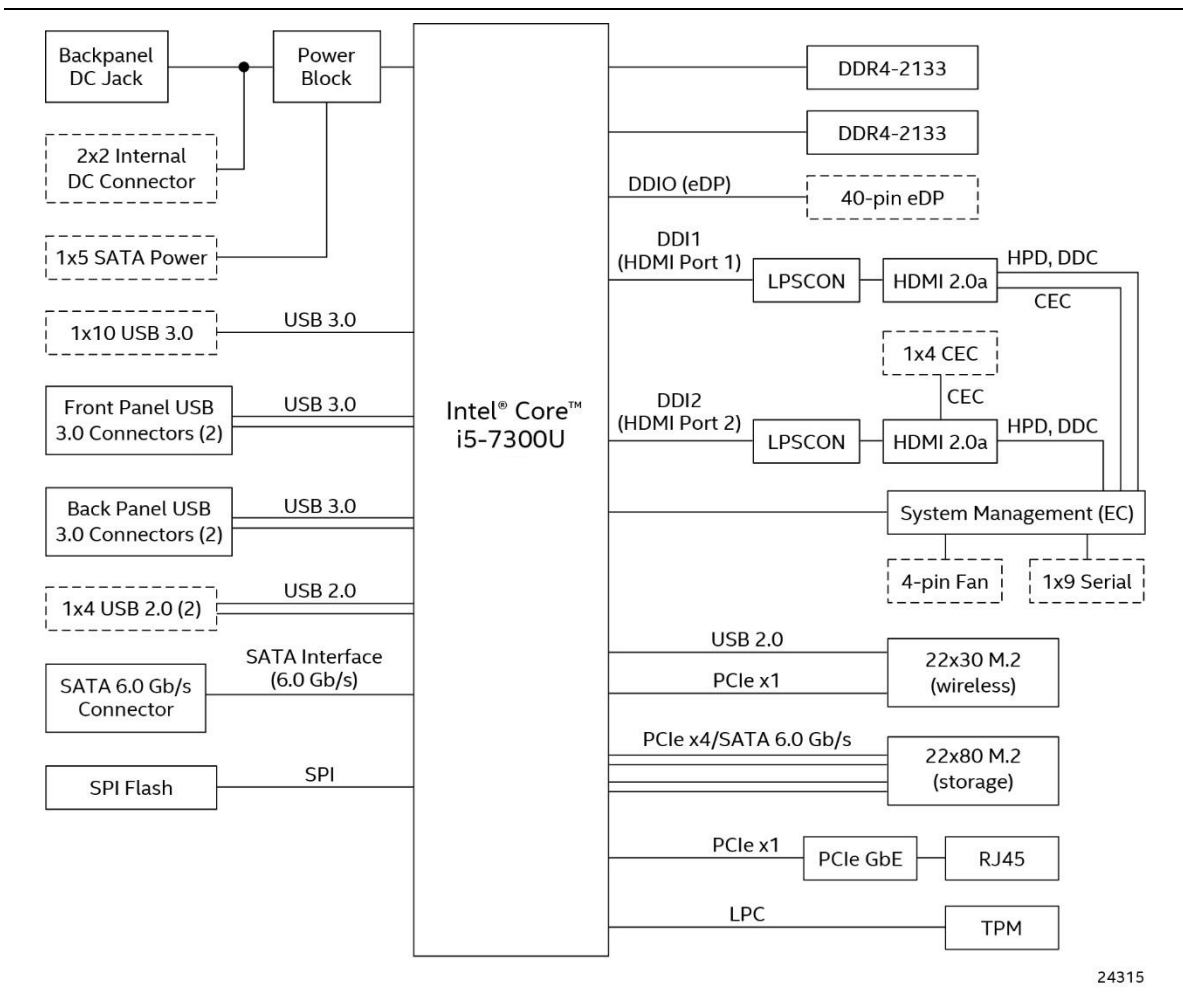

24315

Figure 3. Block Diagram

1.2 Online Support

To find information about...

Intel NUC Board/Kit NUC7i5DN
 Intel NUC Board/Kit Support
 High level details for Intel NUC Board/Kit NUC7i5DN
 BIOS and driver updates
 Tested memory
 Integration information
 Processor datasheet

Visit this World Wide Web site:

<http://www.intel.com/NUC>
<http://www.intel.com/NUCSupport>
<http://ark.intel.com>
<http://downloadcenter.intel.com>
<http://www.intel.com/NUCSupport>
<http://www.intel.com/NUCSupport>
<http://ark.intel.com>

1.3 Processor

Intel NUC Board NUC7i5DNBE has a soldered-down 7th generation Intel Core i5-7300U dual-core processor with up to 15 W TDP:

- Intel® HD Graphics 620
- Integrated memory controller
- Integrated PCH



NOTE

There are specific requirements for providing power to the processor. Refer to Section 2.6.1 on page 61 for information on power supply requirements.

1.4 System Memory

The board has two 260-pin SO-DIMM sockets and supports the following memory features:

- 1.2 V DDR4 SDRAM SO-DIMMs with gold plated contacts
- Two independent memory channels with interleaved mode support
- Unbuffered, single-sided or double-sided SO-DIMMs
- 32 GB maximum total system memory (with 8 Gb memory technology). Refer to Section 2.1.1 on page 41 for information on the total amount of addressable memory.
- Minimum recommended total system memory: 2048 MB
- Non-ECC SO-DIMMs
- Serial Presence Detect
- DDR4 1866/2133 MHz SDRAM SO-DIMMs
- Supports 4 Gb and 8 Gb memory technology (SDRAM Density)

**NOTE**

To be fully compliant with all applicable DDR SDRAM memory specifications, the board should be populated with SO-DIMMs that support the Serial Presence Detect (SPD) data structure. This allows the BIOS to read the SPD data and program the chipset to accurately configure memory settings for optimum performance. If non-SPD memory is installed, the BIOS will attempt to correctly configure the memory settings, but performance and reliability may be impacted or the SO-DIMMs may not function under the determined frequency.

**NOTE**

Intel NUC Board NUC7i5DNBE supports only 4 Gb and 8 Gb memory technologies (also referred to as “SDRAM density”). Table 3 lists the supported SO-DIMM configurations. Table 4 lists the SO-DIMM configurations that are **not** supported.

Table 3. Supported Memory Configurations

SO-DIMM Capacity	Configuration ^(Note)	SDRAM Density	SDRAM Organization Front-side/Back-side	Number of SDRAM Devices
2048 MB	SS	4 Gbit	512 M x4/empty	4
4096 MB	DS	4 Gbit	512 M x4/512 M x4	8
4096 MB	SS	8 Gbit	1024 M x4/empty	4
8192 MB	DS	4 Gbit	512 M x8/512 M x8	16
8192 MB	DS	8 Gbit	1024 M x4/1024 M x4	8
16384 MB	DS	8 Gbit	1024 M X8/1024 M x8	16

Note: “DS” refers to double-sided memory modules and “SS” refers to single-sided memory modules.

Table 4. Unsupported Memory Configurations

SO-DIMM Capacity	Configuration ^(Note)	SDRAM Density	SDRAM Organization Front-side/Back-side	Number of SDRAM Devices
1024 MB	SS	1 Gbit	128 M x8/empty	8
2048 MB	DS	1 Gbit	128 M x8/128 M x8	16
2048 MB	SS	2 Gbit	256 M x8/empty	8
4096 MB	DS	2 Gbit	256 M x8/256 M x8	16

Note: “DS” refers to double-sided memory modules and “SS” refers to single-sided memory modules.

For information about...**Refer to:**

Tested Memory

<http://www.intel.com/NUCSupport>

Figure 4 illustrates the memory channel and SO-DIMM configuration.

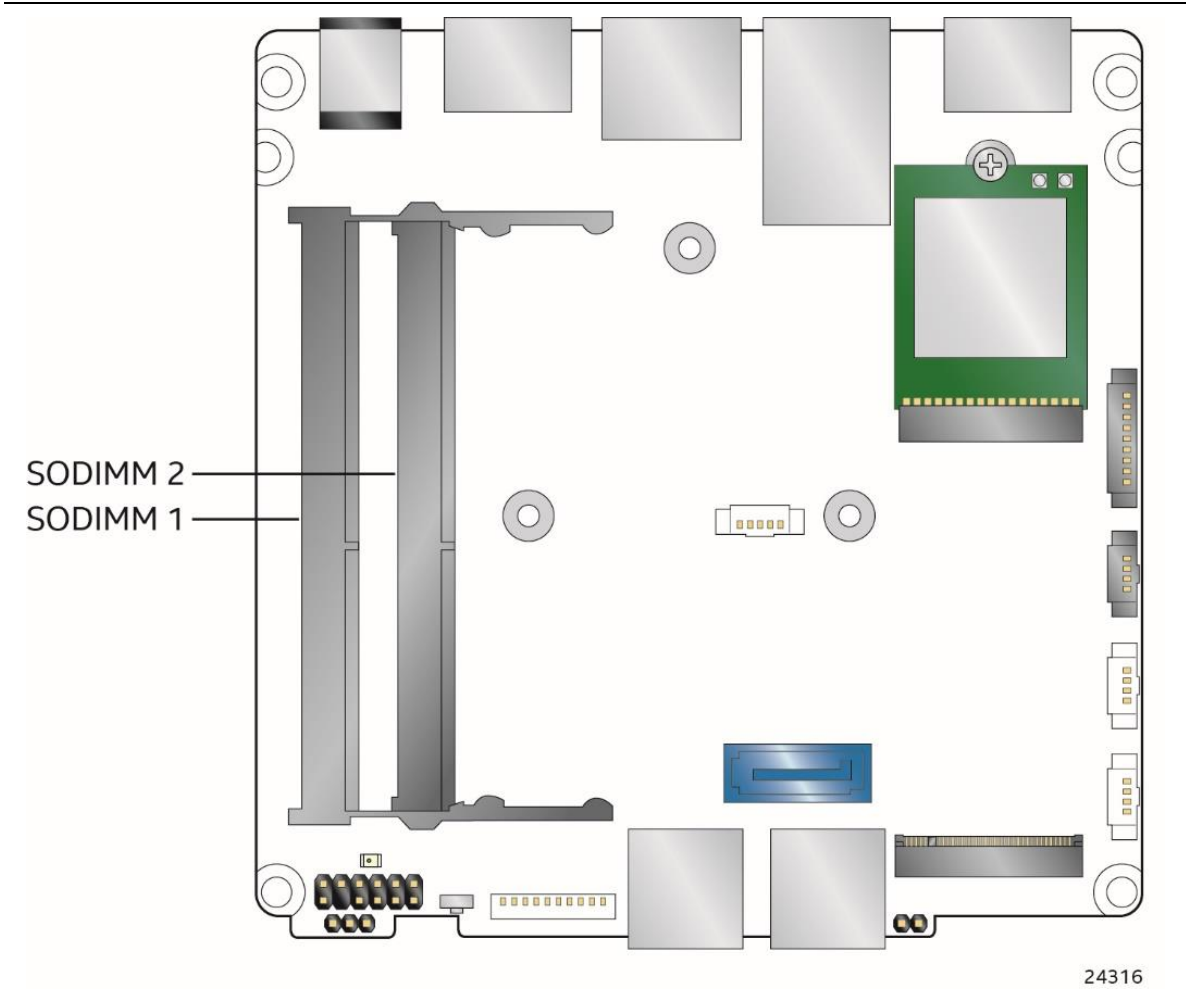

Figure 4. Memory Channel and SO-DIMM Configuration

1.5 Processor Graphics Subsystem

The board supports graphics through Intel® HD Graphics 620.

1.5.1 Integrated Graphics

The board supports integrated graphics via the processor.

1.5.1.1 Intel® High Definition (Intel® HD) Graphics

The Intel® HD Graphics 620 controller features the following:

- 3D Features
 - DirectX* 12 support
 - OpenGL* 4.4 support
- Display
 - Supports eDP flat panel displays up to 3840 x 2160 at 60 Hz
 - Supports HDMI displays up to 4096 x 2160 at 60 Hz
- Next Generation Intel® Clear Video Technology HD support is a collection of video playback and enhancement features that improve the end user's viewing experience
- Encode/transcode HD content
- Playback of high definition content including Blu-ray* disc
- Superior image quality with sharper, more colorful images
- DirectX* Video Acceleration (DXVA) support for accelerating video processing
- Full AVC/VC1/MPEG2/HEVC/VP8/JPEG HW Decode
- Intel HD Graphics with Advanced Hardware Video Transcoding (Intel® Quick Sync Video)
- HDR 10 (High Dynamic Range 10 bit)
- HDCP (High-bandwidth Digital Content Protection) 2.2



NOTE

Intel Quick Sync Video is enabled by an appropriate software application.

1.5.1.2 High Definition Multimedia Interface* (HDMI*)

The HDMI ports are HDMI 2.0a specification compliant and support standard, enhanced, or high definition video, plus multi-channel digital audio on a single cable. The port is compatible with all ATSC and DVB HDTV standards and supports thirty-two full range channels of lossless audio formats. The system can support up to two displays at the maximum supported resolution of 4096 x 2160 @ 60 Hz, 24bpp.

For information about

HDMI technology

Refer to

<http://www.hdmi.org>

1.5.1.2.1 Integrated Audio Provided by the HDMI Interfaces

The following audio technologies are supported by the HDMI 2.0a interface:

- AC3 – Dolby* Digital
- Dolby Digital Plus

- DTS-HD*
- 192kHz/16-bit or 176.4 kHz/24-bit, 32 Channel
- Dolby True HD, DTS-HD Master Audio* (Lossless Blu-ray Disc* Audio Format)

1.5.1.3 High-bandwidth Digital Content Protection (HDCP)

HDMI Port 1 supports HDCP 2.2. HDCP is the technology for protecting high definition content against unauthorized copy or interception between a source (computer, digital set top boxes, etc.) and the sink (panels, monitor, and TVs). The PCH supports HDCP 2.2 for content protection over wired displays.

1.5.1.4 HDMI Consumer Electronics Control (CEC)

The system provides built-in HDMI CEC support on port 1 (refer to Figure 2), as well as a header for 3rd party HDMI CEC daughtercard support on HDMI port 2. The built-in HDMI CEC feature is OS agnostic and supports bi-directional power on/off control between the system and the attached display, as well as automatic HDMI input port detection from the display. This feature can be enabled and configured in BIOS Setup (Advanced → Display tab). Additional HDMI CEC capabilities can be implemented on HDMI port 2 using a 3rd party daughtercard, which allows bi-directional power on/off control and other capabilities as supported by the daughtercard, such as the use of the media buttons on the display's remote controller.

For information about	Refer to
HDMI CEC feature on NUC	https://www.intel.com/content/www/us/en/support/articles/000023500/mini-pcs/intel-nuc-kits.html

1.5.1.5 Flat Panel Display Interfaces

The board supports flat panel displays via the Embedded DisplayPort interface. Figure 5 shows the flat panel connector on the bottom-side of the board.

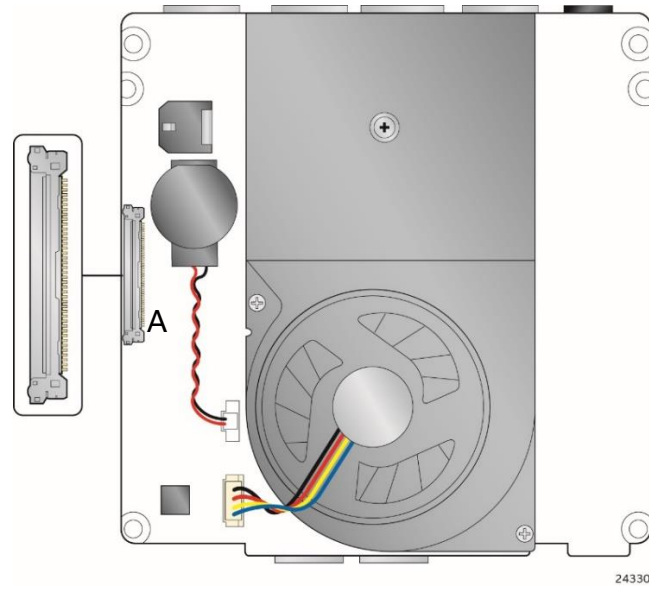

Item	Description
A	Embedded DisplayPort Connector

Figure 5. eDP Connector on Bottom-side of the Board

1.5.1.5.1 Embedded DisplayPort (eDP) Interface

The Embedded DisplayPort 1.4 (eDP) flat panel display interface supports the following:

- Maximum resolution of 3840 x 2160 at 60 Hz
- 4-lane bandwidth at 5.4 GT/s
- Multiple EDID data source capability (panel, predefined, and custom payloads)
- 3.3V flat panel display voltage
- 0.6A of maximum backlight current capability
- Backlight power voltage same as NUC board DC power source
- Board connector used is [I-PEX-20455-040E-12](#), or compatible.
- Mating plug is I-PEX 20453-040T, or compatible.

1.5.1.5.2 Configuration Modes

Video mode configuration for eDP displays is supported as follows:

- Panel: automatic panel identification via Extended Display Identification Data (EDID) for panels with onboard EDID support
- Predefined: panel selection from common predefined panel types
- Custom payloads: custom EDID payload installation for ultimate parameter flexibility, allowing custom definition of EDID data on panels without onboard EDID

In addition, BIOS setup provides the following configuration parameters for internal flat panel displays:

- Color Depth: allows the system integrator to select whether the panel is 24 bpp with VESA or JEIDA color mapping, or 18 bpp.

- eDP Interface Type: allows the system integrator to select whether the eDP panel is a single-lane, dual-lane, or quad-lane display.
- eDP Data Rate: allows the system integrator to select whether the eDP panel runs at 1.62 Gb/s, 2.7 Gb/s, or 5.4 Gb/s.
- Inverter Frequency and Polarity: allows the system integrator to set the operating frequency and polarity of the panel inverter board.
- Maximum and Minimum Inverter Current Limit (%): allows the system integrator to set maximum PWM%, as appropriate, according to the power requirements of the internal flat panel display and the selected inverter board.



NOTE

Support for flat panel display configuration complies with the following:

1. Internal flat panel display settings will be preserved across BIOS updates.
2. Backlight inverter voltage option "Vin" refers to board input voltage as provided to board power input connector.

1.6 USB

The board supports eight USB ports. All eight ports are high-speed, full-speed, and low-speed capable. The port arrangement is as follows:

- USB 3.0 ports:
 - Two ports are implemented with external front panel connectors (blue)
 - Two ports are implemented with external back panel connectors (blue)
 - One port is implemented with a 1x10 1.25mm internal header (white)
- USB 2.0 ports:
 - Two ports via two single-port internal 1x4 1.25 mm pitch headers (white)
 - One port is reserved for the M.2 2230 Module Connector (Key Type E) (Wireless card on Kit only)



NOTE

Computer systems that have an unshielded cable attached to a USB port may not meet FCC Class B requirements, even if no device is attached to the cable. Use a shielded cable that meets the requirements for full-speed devices.

For information about	Refer to
The location of the USB connectors on the back panel	Figure 10, page 42
The location of the front panel USB headers	Figure 9, page 42
The location of the internal connectors	Figure 12, page 44

1.7 SATA Interface

The board provides the following SATA interfaces:

- One internal M.2 SATA port supporting M.2 2280 (key type M) modules
- One SATA 6.0 Gb/s port (blue)

The PCH provides independent SATA ports with a theoretical maximum transfer rate of 6 Gb/s. A point-to-point interface is used for host to device connections.

1.7.1 AHCI Mode

The board supports AHCI storage mode.



NOTE

In order to use AHCI mode, AHCI must be enabled in the BIOS. Microsoft Windows* 10 includes the necessary AHCI drivers without the need to install separate AHCI drivers during the operating system installation process; however, it is always good practice to update the AHCI drivers to the latest available by Intel.*

1.7.2 NVMe

The board supports M.2 NVM Express* (NVMe) drives. NVMe is an optimized, high-performance scalable host controller interface designed to utilize PCIe-based solid-state storage. NVMe is designed to provide efficient access to storage devices built with non-volatile memory, from current NAND flash technology to future, higher performing persistent memory technologies like Optane. NVMe is designed to meet serial bandwidth requirements and very high IOPs. It is based on PCIe Gen 3 and can deliver up to 4GB/s bandwidth. Current NVMe is based on version 1.3 of the specification.

1.7.3 Intel® Rapid Storage Technology / SATA RAID

The PCH supports Intel® Rapid Storage Technology, providing both AHCI and integrated RAID functionality. The RAID capability provides high-performance RAID 0 and 1 functionality on all SATA ports. Other RAID features include hot spare support, SMART alerting, and RAID 0 auto replace. Software components include an Option ROM for pre-boot configuration and boot functionality, a Microsoft Windows compatible driver, and a user interface for configuration and management of the RAID capability of the PCH.



NOTE

Intel Rapid Storage Technology / SATA RAID is only supported if an M.2 SATA SSD module is used with the onboard SATA interface. RAID is not available with an M.2 NVMe SSD module and onboard SATA interface. Supported on chassis with 2.5 inch SATA HDD capability.

1.7.4 Intel® Next Generation Storage Acceleration

Intel® Next Generation Storage Acceleration with Intel® Optane™ Technology is a disk caching solution that can provide improved computer system performance with improved power savings. It allows configuration of a computer system with the advantage of having HDDs for maximum storage capacity and with Intel® Optane™ Technology for improved system performance. Supported on chassis with 2.5 inch SATA HDD capability.

For more information on Intel® Optane™ Technology, go to <http://www.intel.com/content/www/us/en/architecture-and-technology/non-volatile-memory.html>

1.8 Real-Time Clock Subsystem

A coin-cell battery (CR2032) powers the real-time clock and CMOS memory. When the computer is not plugged into a wall socket, the battery has an estimated life of three years. When the computer is plugged in, the standby current from the power supply extends the life of the battery. The clock is accurate to ± 13 minutes/year at 25 °C with 3.3 VSB applied via the power supply 5 V STBY rail.



NOTE

If the battery and AC power fail, date and time values will be reset and the user will be notified during the POST.

When the voltage drops below a certain level, the BIOS Setup program settings stored in CMOS RAM (for example, the date and time) might not be accurate. Replace the battery with an equivalent one. Figure 1 on page 15 shows the location of the battery.

1.9 Audio Subsystem Software

Audio is supported through the HDMI 2.0a ports interface through the processor and supports eight full range channels of lossless audio formats per port. When using an encoded format (such as DTS-HD MA or Dolby True HD) the board supports a single 7.1 stream. When using an un-encoded format the board supports 8 discrete, un-encoded channels per HDMI port simultaneously, for a total of 16 discrete/un-encoded channels.

1.9.1 Audio Subsystem Software

Audio drivers are built into the Graphics driver and are available from Intel's website.

For information about	Refer to
Obtaining NUC software and drivers	http://downloadcenter.intel.com

1.10 LAN Subsystem

The LAN subsystem consists of the following:

- Intel I219LM Gigabit Ethernet Controller (10/100/1000 Mb/s)
- RJ-45 LAN connector with integrated status LEDs

Additional features of the LAN subsystem include:

- CSMA/CD protocol engine
- LAN connect interface between the Processor and the LAN controller
- Power management capabilities
 - ACPI technology support
 - LAN wake capabilities
- LAN subsystem software

For information about

LAN software and drivers

Refer to

<http://downloadcenter.intel.com>

1.10.1 Intel® I219LM Gigabit Ethernet Controller

The Intel I219LM Gigabit Ethernet Controller supports the following features:

- Compliant with the 1 Gb/s Ethernet 802.3, 802.3u, 802.3z, 802.3ab specifications
- Multi-speed operation: 10/100/1000 Mb/s
- Full-duplex operation at 10/100/1000 Mb/s; Half-duplex operation at 10/100 Mb/s
- Flow control support compliant with the 802.3X specification as well as the specific operation of asymmetrical flow control defined by 802.3z
- VLAN support compliant with the 802.3q specification
- Supports Jumbo Frames (up to 9 kB)
 - IEEE 1588 supports (Precision Time protocol)
- MAC address filters: perfect match unicast filters, multicast hash filtering, broadcast filter, and promiscuous mode

1.10.2 RJ-45 LAN Connector with Integrated LEDs

Two LEDs are built into the RJ-45 LAN connector (shown in Figure 6).

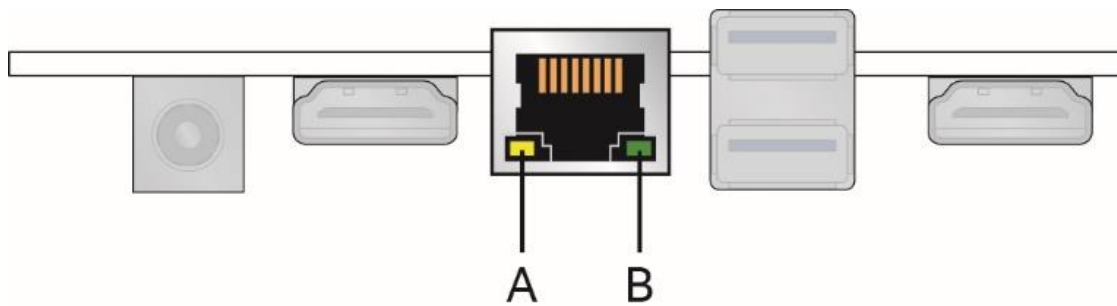

24321

Item	Description
A	Link LED (Green)
B	Data Rate LED (Green/Yellow)

Figure 6. LAN Connector LED Locations

Table 5 describes the LED states when the board is powered up and the LAN subsystem is operating.

Table 5. LAN Connector LED States

LED	LED Color	LED State	Condition
Link	Green	Off	LAN link is not established.
		On	LAN link is established.
		Blinking	LAN activity is occurring.
Data Rate	Green/Yellow	Off	10 Mb/s data rate is selected.
		Green	100 Mb/s data rate is selected.
		Yellow	1000 Mb/s data rate is selected.

1.10.3 Wireless Network Module

The Intel Dual Band Wireless-AC vPro 8265 module provides hi-speed wireless connectivity provided with the following capabilities and is supported by Intel vPro Technology. The wireless module is included with Kit SKUs only:

- Compliant IEEE 802.11a/b/g/n/ac, 802.11d, 802.11e, 802.11i, 802.11w, 802.11r, 802.11k, 802.11v (pending OS support) specifications
- Maximum bandwidth of 867 Mbps
- Dual Mode Bluetooth* 4.2
- Wi-Fi Direct* for peer to peer device connections
- Wi-Fi Miracast* as Source
- Authentication: WPA and WPA2, 802.1X (EAP-TLS, TTLS, PEAP, LEAP, EAP-FAST), EAP-SIM, EAP-AKA
- Encryption: 64-bit and 128-bit WEP, 128-bit AES-CCMP

For information about	Refer to
Obtaining WLAN software and drivers	http://downloadcenter.intel.com
Full Specifications	http://intel.com/wireless

1.11 Hardware Management Subsystem

The board has several hardware management features, including thermal and voltage monitoring.

1.11.1 Hardware Monitoring

The hardware monitoring and fan control subsystem is based on an ITE Tech. ITE8987E-VG embedded controller, which supports the following:

- Processor and system ambient temperature monitoring
- Fan speed monitoring
- Voltage monitoring of CPU IO Vcc (+Vccio), Memory Vcc (V_SM), CPU IN Vcc (+Vccp)
- SMBus communication with internal components

1.11.2 Fan Monitoring

Fan monitoring can be implemented using third-party software.

1.11.3 Thermal Solution

Figure 7 shows the location of the thermal solution and processor fan header.

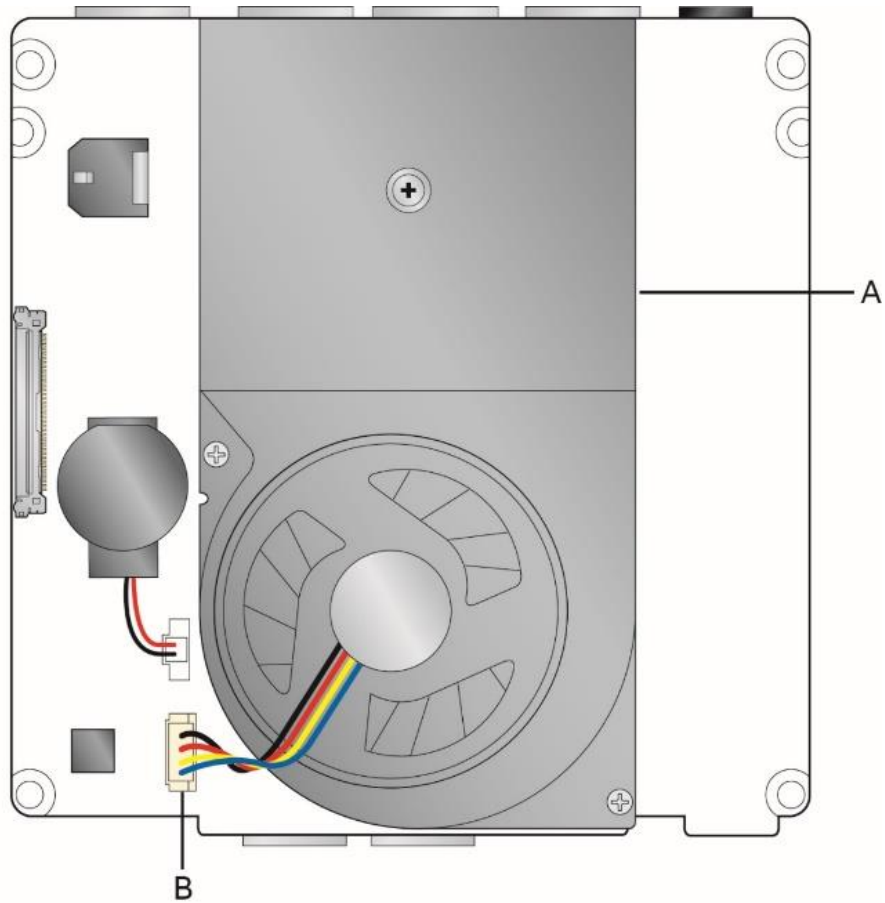

24317

Item	Description
A	Thermal Solution
B	Processor Fan Header

Figure 7. Thermal Solution and Fan Header

1.12 Power Management

Power management is implemented at several levels, including:

- Software support through Advanced Configuration and Power Interface (ACPI)
- Hardware support:
 - Power Input
 - LAN wake capabilities
 - Wake from USB
 - +5 V Standby Power Indicator LED

1.12.1 ACPI

ACPI gives the operating system direct control over the power management and Plug and Play functions of a computer. The use of ACPI with this board requires an operating system that provides full ACPI support. ACPI features include:

- Plug and Play (including bus and device enumeration)
- Power management control of individual devices, add-in boards (some add-in boards may require an ACPI-aware driver), video displays, and hard disk drives
- Methods for achieving less than 15-watt system operation in the power-on/standby sleeping state
- A Soft-off feature that enables the operating system to power-off the computer
- Support for multiple wake-up events (see Table 8 on page 35)
- Support for a front panel power and sleep mode switch

Table 6 lists the system states based on how long the power switch is pressed, depending on how ACPI is configured with an ACPI-aware operating system.

Table 6. Effects of Pressing the Power Switch

If the system is in this state...	...and the power switch is pressed for	...the system enters this state
Off (ACPI G2/G5 – Soft off)	Less than four seconds	Power-on (ACPI G0 – working state)
On (ACPI G0 – working state)	Less than four seconds	Soft-off/Standby (ACPI G1 – sleeping state) ^{Note}
On (ACPI G0 – working state)	More than six seconds	Fail safe power-off (ACPI G2/G5 – Soft off)
Sleep (ACPI G1 – sleeping state)	Less than four seconds	Wake-up (ACPI G0 – working state)
Sleep (ACPI G1 – sleeping state)	More than six seconds	Power-off (ACPI G2/G5 – Soft off)

Note: Depending on power management settings in the operating system.

1.12.1.1 System States and Power States

Under ACPI, the operating system directs all system and device power state transitions. The operating system puts devices in and out of low-power states based on user preferences and knowledge of how devices are being used by applications. Devices that are not being used can be turned off. The operating system uses information from applications and user settings to put the system as a whole into a low-power state.

Table 7 lists the power states supported by the board along with the associated system power targets. See the ACPI specification for a complete description of the various system and power states.

Table 7. Power States and Targeted System Power

Global States	Sleeping States	Processor States	Device States
G0 – working state	S0 – working	C0 – working	D0 – working state.
G1 – sleeping state	S3 – Suspend to RAM. Context saved to RAM.	No power	D3 – no power except for wake-up logic.
G1 – sleeping state	S4 – Suspend to disk. Context saved to disk.	No power	D3 – no power except for wake-up logic.
G2/S5	S5 – Soft off. Context not saved. Cold boot is required.	No power	D3 – no power except for wake-up logic.
G3 – mechanical off AC power is disconnected from the computer.	No power to the system.	No power	D3 – no power for wake-up logic, except when provided by battery or external source.

Notes:

1. Total system power is dependent on the system configuration, including add-in boards and peripherals powered by the system chassis' power supply.
2. Dependent on the standby power consumption of wake-up devices used in the system.

1.12.1.2 Wake-up Devices and Events

Table 8 lists the devices or specific events that can wake the computer from specific states.

Table 8. Wake-up Devices and Events

Devices/events that wake up the system...	...from this sleep state	Comments
Power switch	S3, S4, S5 ¹	
RTC alarm	S3, S4, S5 ¹	Monitor to remain in sleep state
LAN	S3, S4, S5 ^{1,3}	"S5 WOL after G3" must be supported; monitor to remain in sleep state
WIFI	S3, S4, S5 ^{1,3}	"S5 WOL after G3" must be supported; monitor to remain in sleep state
Bluetooth	S3 ¹	
USB	S3, S4, S5 ^{1,2,3}	Wake S4, S5 controlled by BIOS option (not after G3)
HDMI CEC	S3, S4, S5 ¹	Emulates power button push
Serial	N/A	Wake from Serial is not supported

Notes:

1. S4 implies operating system support only.
2. Will not wake from Deep S4/S5. USB S4/S5 Power is controlled by BIOS. USB S5 wake is controlled by BIOS. USB S4 wake is controlled by OS driver, not just BIOS option.
3. Windows Fast startup will block wake from LAN and USB from S5.



NOTE

The use of these wake-up events from an ACPI state requires an operating system that provides full ACPI support. In addition, software, drivers, and peripherals must fully support ACPI wake events.

1.12.2 Hardware Support

The board provides several power management hardware features, including:

- Wake from Power Button signal
When resuming from an AC power failure, the computer returns to the power state defined in the BIOS. Available states are "Power On", "Stay Off", and "Last State".
- LAN wake capabilities
Enables remote wake-up of the computer through a network. The LAN subsystem monitors network traffic at the Media Independent Interface. Upon detecting a Magic Packet* frame, the LAN subsystem asserts a wake-up signal that powers up the computer.
- Wake from USB
USB bus activity wakes the computer from an ACPI S3 state (not after G3).
- +5 V Standby Power Indicator LED
The standby power indicator LED shows that power is still present even when the computer appears to be off. Figure 8 shows the location of the standby power LED.



NOTE

The use of Wake from USB from an ACPI state requires an operating system that provides full ACPI support. Wake from USB requires the use of a USB peripheral that supports Wake from USB.



CAUTION

If AC power has been switched off and the standby power indicator is still lit, disconnect the power cord before installing or removing any devices connected to the board. Failure to do so could damage the board and any attached devices.

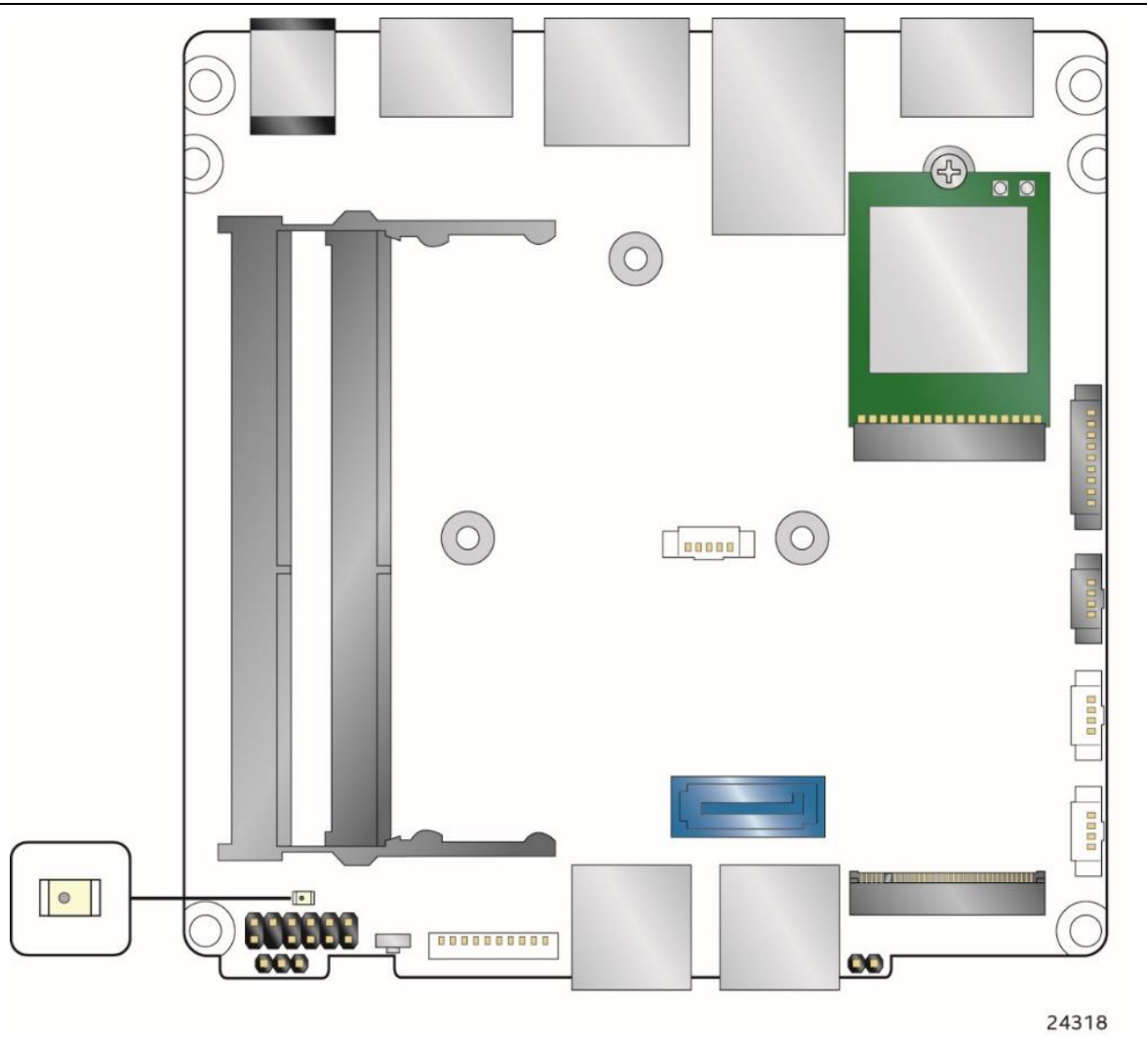

Figure 8. Location of the Standby Power LED

1.13 Intel® Security and Manageability Technologies

Intel® Security and Manageability Technologies provides tools and resources to help small business owners and IT organizations protect and manage their assets in a business or institutional environment.



NOTE

Software with security and/or manageability capability is required to take advantage of Intel platform security and/or management technologies.

1.13.1 Intel® vPro™ Technology

Intel® vPro™ Technology is a collection of platform capabilities that support enhanced manageability, security, virtualization and power efficiency. The key platform capabilities include:

- Intel® Active Management Technology (Intel® AMT) 11.6
- Intel® Virtualization (Intel® VT-x)
- Intel® Virtualization for Directed I/O (Intel® VT-d)
- Intel® Trusted Execution Technology (Intel® TXT)
- Intel® Identity Protection Technology (Intel® IPT)
- Intel® Software Guard Extensions (Intel® SGX)
- Intel® Transparent Supply Chain (Intel® TSC)
- Trusted Platform Module 2.0 (TPM)

For information about

Refer to

Intel® vPro Technology

<http://support.intel.com/support/vpro/>

1.13.1.1 Intel® Active Management Technology 11.6

When used with third-party management and security applications, Intel Active Management Technology (Intel® AMT) allows business owners and IT organizations to better discover, heal, and protect their networked computing assets.

Some of the features of Intel AMT include:

- Out-of-band (OOB) system access, to discover assets even while PCs are powered off
- Remote trouble-shooting and recovery, which allows remote diagnosis and recovery of systems after OS failures
- Hardware-based agent presence checking that automatically detects and alerts when critical software agents have been stopped or are missing
- Proactive network defense, which uses filters to block incoming threats while isolating infected clients before they impact the network
- Remote hardware and software asset tracking, helping to track computer assets and keep virus protection up-to-date
- Keyboard, video and mouse (KVM) remote control, which allows redirection of a managed system's video to a remote console which can then interact with it using the console's own mouse and keyboard

**NOTE**

Intel AMT requires a network connector and an Intel AMT enabled remote management console. Setup requires additional configuration of the platform.

For information about

Intel® Active Management Technology

Refer to

<http://www.intel.com/technology/platform-technology/intel-amt/index.htm>

1.13.1.2 Intel® Virtualization Technology

Intel® Virtualization Technology (Intel® VT-x) is a hardware-assisted technology that, when combined with software-based virtualization solutions, provides maximum system utilization by consolidating multiple environments into a single server or client.

**NOTE**

A processor with Intel VT does not guarantee that virtualization will work on your system. Intel VT requires a computer system with a chipset, BIOS, enabling software and/or operating system, device drivers, and applications designed for this feature.

For information about

Intel® Virtualization Technology

Refer to

<http://www.intel.com/technology/virtualization/technology.htm>

1.13.1.3 Intel® Virtualization Technology for Directed I/O

Intel® Virtualization Technology for Directed I/O (Intel® VT-d) allows addresses in incoming I/O device memory transactions to be remapped to different host addresses. This provides Virtual Machine Monitor (VMM) software with:

- Improved reliability and security through device isolation using hardware assisted remapping.
- Improved I/O performance and availability by direct assignment of devices.

For information about

Intel® Virtualization Technology for Directed I/O

Refer to

<https://software.intel.com/en-us/node/139035?wapkw=vt+directed+io>

1.13.1.4 Intel® Trusted Execution Technology

Intel® Trusted Execution Technology (Intel® TXT) is a hardware security solution that protects systems against software-based attacks by validating the behavior of key components at startup against a known good source. It requires that Intel VT be enabled and the presence of a TPM.

For information about	Refer to
Intel® Trusted Execution Technology	http://www.intel.com/content/www/us/en/architecture-and-technology/trusted-execution-technology/malware-reduction-general-technology.html

1.13.1.5 Intel® Identity Protection Technology

Intel® Identity Protection Technology (Intel® IPT) provides a simple way for websites and enterprises to validate that a user is logging in from a trusted computer. This is accomplished by using the Intel Manageability Engine embedded in the chipset to generate a six-digit number that, when coupled with a user name and password, will generate a One-Time Password (OTP) when visiting Intel IPT-enabled websites. Intel IPT eliminates the need for the additional token or key fob required previously for two-factor authentication.

For information about	Refer to
Intel® Identity Protection Technology	http://ipt.intel.com

1.13.1.6 Intel® Software Guard Extensions

Intel® Software Guard Extensions (Intel® SGX) is for application developers who are seeking to protect select code and data from disclosure or modification. Intel SGX makes such protections possible through the use of enclaves, which are protected areas of execution in memory. Application code can be put into an enclave by special instructions and software made available to developers via the Intel SGX Software Development Kit (SDK).

For information about	Refer to
Intel® Software Guard Extensions	https://software.intel.com/en-us/sgx

1.13.1.7 Intel® Transparent Supply Chain (TSC)

Intel® Transparent Supply Chain is being able to prove that all components used for Intel products were sourced from approved manufacturers and purchased from authorized suppliers or distributors. The components will be traceable to each finished goods serial number. TSC data aids in the detection of counterfeit, gray market, and/or components that do not conform to spec.

For information about	Refer to
Intel® Transparent Supply Chain	https://tsc.intel.com

1.13.1.8 Trusted Platform Module (TPM)

The TPM version 2.0 component is specifically designed to enhance platform security above-and-beyond the capabilities of today's software by providing a protected space for key operations and other security critical tasks. Using both hardware and software, the TPM protects encryption and signature keys at their most vulnerable stages—operations when the keys are being used unencrypted in plain-text form. The TPM shields unencrypted keys and platform authentication information from software-based attacks.



NOTE

Support for TPM v2.0 requires a UEFI-enabled operating system, such as Microsoft Windows 10.

For information about	Refer to
Infineon SLB9665VQ2.0 TPM v2.0	www.infineon.com/cms/en/product/channel.html?channel=db3a30433efacd9a013f10d3ded64daf
NationZ Z32H320TC TPM v2.0 (China only)	http://www.nationz.com.cn/upfile/2016/20160408085201_906.pdf

2 Technical Reference

2.1 Memory Resources

2.1.1 Addressable Memory

The system has been validated with up to 32 GB of addressable system memory. Typically the address space that is allocated for PCI Express configuration space, BIOS (SPI Flash device), and chipset overhead resides above the top of DRAM (total system memory). On a system that has 16 GB of system memory installed, it is not possible to use all of the installed memory due to system address space being allocated for other system critical functions. These functions include the following:

- BIOS/SPI Flash device (16 MB)
- Local APIC (19 MB)
- Direct Media Interface (40 MB)
- PCI Express configuration space (256 MB)
- PCH base address registers PCI Express ports (up to 256 MB)
- Memory-mapped I/O that is dynamically allocated for M.2 add-in cards (256 MB)
- Integrated graphics shared memory (up to 1.5 GB; 64 MB by default)

2.2 Connectors and Headers



CAUTION

Only the following connectors and headers have overcurrent protection: back panel USB, front panel USB, and internal USB headers.

All other connectors and headers are not overcurrent protected and should connect only to devices inside the computer's chassis, such as fans and internal peripherals. Do not use these connectors or headers to power devices external to the computer's chassis. A fault in the load presented by the external devices could cause damage to the computer, the power cable, and the external devices themselves.

Furthermore, improper connection of USB header single wire connectors may eventually overload the overcurrent protection and cause damage to the board.

This section describes the board's connectors and headers. The connectors and headers can be divided into these groups:

- Front panel I/O connectors
- Back panel I/O connectors
- On-board I/O connectors and headers (see page 43 and 44)



NOTE

Unless otherwise noted, all 2.0 mm headers are dual-row, straight, surface mount with each two-pin section measuring 2.0 mm x 4.0 mm, with a pin height of 4.0 mm.

2.2.1 Front Panel Connectors

Figure 9 shows the location of the front panel connectors for the board.

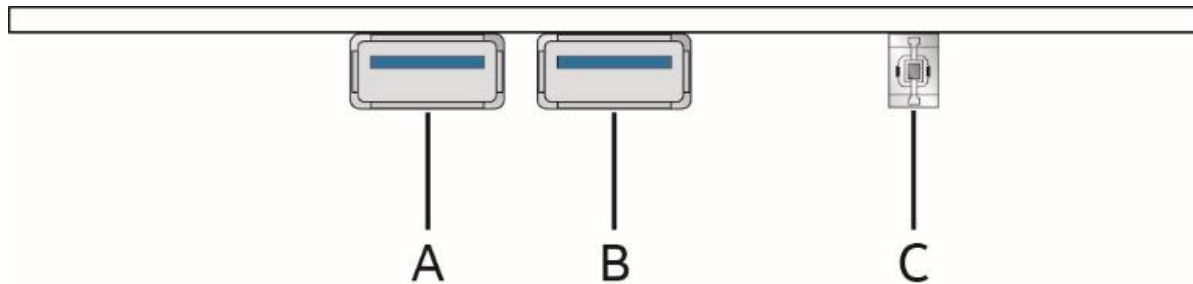

24319

Item	Description
A	Front Panel Power Button
B	USB 3.0 Port (blue)
C	USB 3.0 Port (blue)

Figure 9. Front Panel Connectors

2.2.2 Back Panel Connectors

Figure 10 shows the location of the back panel connectors for the board.

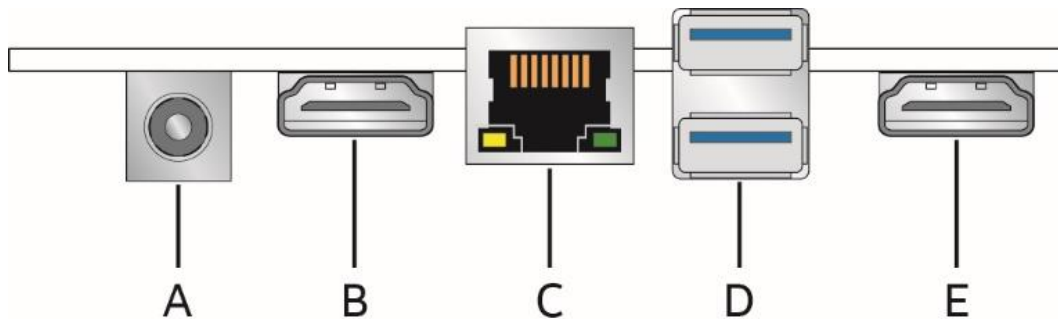

24320

Item	Description
A	12-24 V DC Input Jack
B	HDMI Port 1
C	LAN Connector
D	USB 3.0 Ports (blue)
E	HDMI Port 2

Figure 10. Back Panel Connectors

2.2.3 Connectors and Headers (Top)

Figure 11 shows the location of the connectors and headers on the top-side of the board.

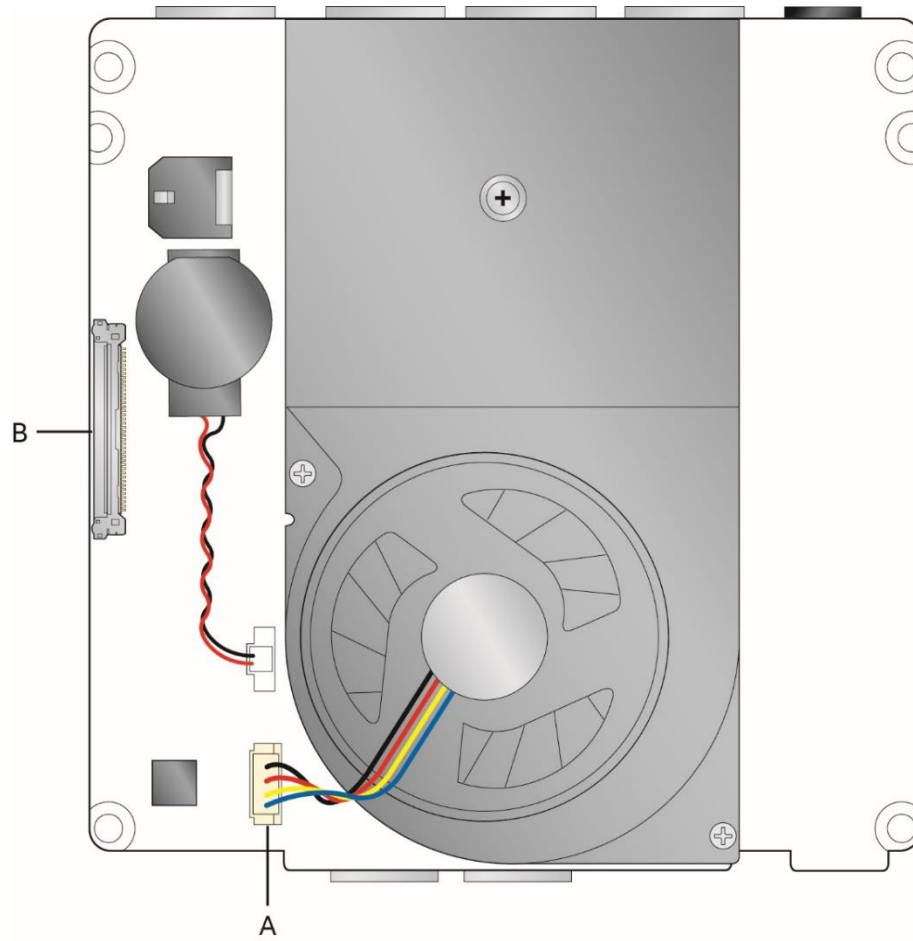

24323

Figure 11. Connectors and Headers (Top)

Table 9. Connectors and Headers Shown in Figure 11

Item from Figure 11	Description
A	Processor Fan Header
B	eDP Connector

2.2.4 Connectors and Headers (Bottom)

Figure 12 shows the locations of the connectors and headers on the bottom-side of the board.

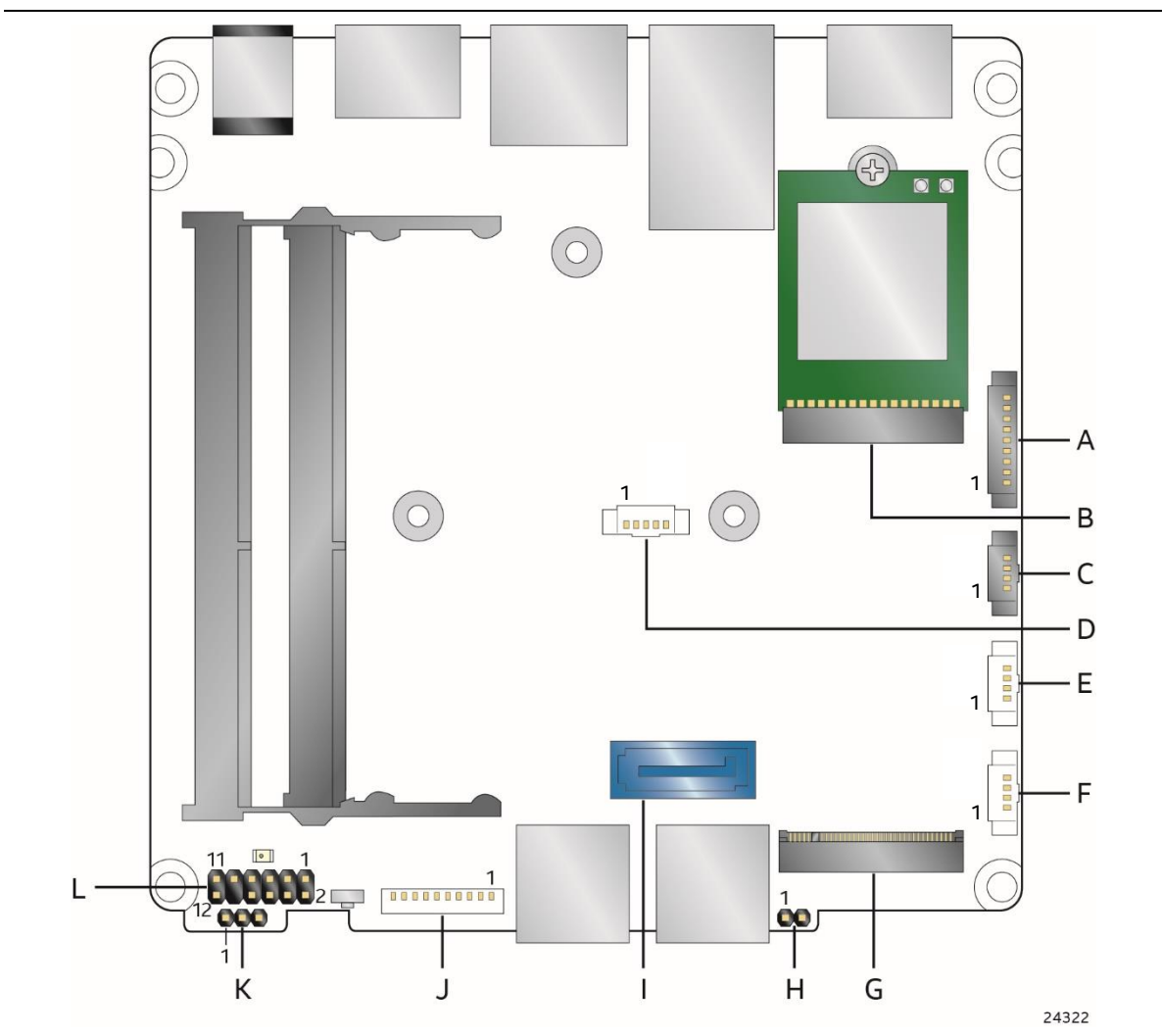

Figure 12. Connectors and Headers (Bottom)

Table 10 lists the connectors and headers identified in Figure 12.

Table 10. Connectors and Headers Shown in Figure 12

Item from Figure 12	Description
A	Serial Port Header
B	M.2 2230 Module Connector (Key Type E) (Wireless card on Kit only)
C	HDMI CEC
D	SATA Power Header
E	USB 2.0 Header
F	USB 2.0 Header
G	M.2 2280 Module Connector (Key Type M)
H	Intel® Management Engine BIOS Extension (Intel® MEBX) Reset Header
I	SATA 6.0 Gb/s Connector
J	USB 3.0 Header
K	BIOS Security Header
L	Front Panel Header

2.2.4.1 Signal Tables for the Connectors and Headers

Table 11. SATA Power Header (1.25 mm pitch)

Pin	Signal Name
1	5 V (1.5A total for pins 1, 2)
2	5 V (1.5A total for pins 1, 2)
3	3.3 V
4	GND
5	GND

Connector is Molex part number 53398-0571, 1.25mm Pitch PicoBlade* Header, Surface Mount, Vertical, Lead-Free, 5 Circuits.

Table 12. Internal USB 2.0 Header (1.25 mm pitch)

Pin	Signal Name
1	5 V ¹
2	D -
3	D +
4	GND

¹ The two USB 2.0 headers on the board can deliver a combined power rating of 1.5 A, with any one of the headers supplying 1 A and the other supplying 500 mA.

Connector is Molex part number 53398-0471, 1.25mm Pitch PicoBlade* Header, Surface Mount, Vertical, Lead-Free, 4 Circuits.

Table 13. Internal USB 3.0 Header (1.25 mm pitch)

Pin	Signal Name
1	USB_VBUS
2	USB1_N
3	USB1_P
4	GND
5	USBSS1_TX_N
6	USBSS1_TX_P
7	GND
8	USBSS1_RX_N
9	USBSS1_RX_P
10	Host/Device ID Switch ¹

¹Wiring requirement for pin 10 ("Host/Device ID Switch") is as follows:

Port Type	Pin 10 wired to...	Port automatically configured as...
Type A or internal USB peripheral	Ground	Host port
Type B	Not connected	Device port
Micro B or Micro AB	ID pin on attached port	Dynamic configuration as host or device port (depending on attached peripheral)

Connector is 1x10 1.25mm Pitch PicoBlade* Header, Surface Mount, Vertical, Lead-Free, 10 Circuits.

Table 14. Serial Port Header (1.25 mm pitch)

Pin	Signal Name	Description
1	DCD	Data Carrier Detect
2	RXD#	Receive Data
3	TXD#	Transmit Data
4	DTR	Data Terminal Ready
5	GND	Ground
6	DSR	Data Set Ready
7	RTS	Request to Send
8	CTS	Clear to Send
9	RI	Ring Indicator

Connector is 1x9 1.25mm Pitch PicoBlade* Header, Surface Mount, Vertical, Lead-Free, 9 Circuits.

Table 15. HDMI CEC Header (1.25 mm pitch)

Pin	Signal Name
1	5VSTBY
2	GND
3	POWER_SWITCH#
4	HDMI_CEC (Port 1)

Connector is 1x4 1.25mm Pitch PicoBlade* Header, Surface Mount, Vertical, Lead-Free, 4 Circuits.

Table 16. M.2 2280 Module (Mechanical Key M) Connector

Pin	Signal Name	Pin	Signal Name
74	3.3V (2.75A total for pins 74, 72, 70, 4, 2)	75	GND
72	3.3V (2.75A total for pins 74, 72, 70, 4, 2)	73	GND
70	3.3V (2.75A total for pins 74, 72, 70, 4, 2)	71	GND
68	SUSCLK(32kHz) (O)(0/3.3V)	69	PEDET (NC-PCIe/GND-SATA)
66	Connector Key	67	N/C
64	Connector Key	65	Connector Key
62	Connector Key	63	Connector Key
60	Connector Key	61	Connector Key
58	N/C	59	Connector Key
56	N/C	57	GND
54	PEWAKE# (I/O)(0/3.3V) or N/C	55	REFCLKP
52	CLKREQ# (I/O)(0/3.3V) or N/C	53	REFCLKN
50	PERST# (O)(0/3.3V) or N/C	51	GND
48	N/C	49	PETp0/SATA-A+
46	N/C	47	PETn0/SATA-A-
44	N/C	45	GND
42	N/C	43	PERp0/SATA-B-
40	N/C	41	PERn0/SATA-B+
38	DEVSLP (O)	39	GND
36	N/C	37	PETp1
34	N/C	35	PETn1
32	N/C	33	GND
30	N/C	31	PERp1
28	N/C	29	PERn1
26	N/C	27	GND
24	N/C	25	PETp2
22	N/C	23	PETn2
20	N/C	21	GND
18	3.3V	19	PERp2
16	3.3V	17	PERn2

14	3.3V	15	GND
12	3.3V	13	PETp3
10	DAS/DSS# (I/O)/LED1# (I)(0/3.3V)	11	PETn3
8	N/C	9	GND
6	N/C	7	PERp3
4	3.3V (2.75A total for pins 74, 72, 70, 4, 2)	5	PERn3
2	3.3V (2.75A total for pins 74, 72, 70, 4, 2)	3	GND
		1	GND

Table 17. M.2 2230 Module (Mechanical Key E) Connector

Pin	Signal Name	Pin	Signal Name
74	3.3V (2.75A total for pins 74, 72, 4, 2)	75	GND
72	3.3V (2.75A total for pins 74, 72, 4, 2)	73	RESERVED/REFCLKN1
70	UIM_POWER_SRC/GPIO1/PEWAKE1#	71	RESERVED/REFCLKP1
68	UIM_POWER_SNK/CLKREQ1#	69	GND
66	UIM_SWP/PERST1#	67	RESERVED/PERn1
64	RESERVED	65	RESERVED/PERp1
62	ALERT# (I)(0/3.3)	63	GND
60	I2C CLK (O)(0/3.3)	61	RESERVED/PETn1
58	I2C DATA (I/O)(0/3.3)	59	RESERVED/PETp1
56	W_DISABLE1# (O)(0/3.3V)	57	GND
54	W_DISABLE2# (O)(0/3.3V)	55	PEWAKE0# (I/O)(0/3.3V)
52	PERST0# (O)(0/3.3V)	53	CLKREQ0# (I/O)(0/3.3V)
50	SUSCLK(32kHz) (O)(0/3.3V)	51	GND
48	COEX1 (I/O)(0/1.8V)	49	REFCLKN0
46	COEX2(I/O)(0/1.8V)	47	REFCLKP0
44	COEX3(I/O)(0/1.8V)	45	GND
42	CLink_CLK (I/O)	43	PERn0
40	CLink_DATA (I/O)	41	PERp0
38	C-Link RESET* (I) (0/3.3V)	39	GND
36	UART CTS (I) (0/1.8V)	37	PETn0
34	UART RTS (O) (0/1.8V)	35	PETp0
32	UART RXD (I) (0/1.8V)	33	GPIO_2 (I/O)(0/1.8V*)
30	Connector Key	31	Connector Key
28	Connector Key	29	Connector Key
26	Connector Key	27	Connector Key
24	Connector Key	25	Connector Key
22	UART TXD (O) (0/1.8V)	23	RESERVED
20	UART WAKE# (O) (0/3.3V)	21	RESERVED
18	GND	19	RESERVED

Intel NUC Board/Kit NUC7i5DN Technical Product Specification

16	ANTCTL0 (I)(0/1.8V)	17	RESERVED
14	ANTCTL1 (I)(0/1.8V)	15	RESERVED
12	ANTCTL2 (I)(0/1.8V)	13	RESERVED
10	ANTCTL3 (I)(0/1.8V)	11	RESERVED
8	RESET# (O)(0/1.8V)	9	RESERVED
6	CONFIG_1	7	GND
4	3.3V (2.75A total for pins 74, 72, 4, 2)	5	USB_D-
2	3.3V (2.75A total for pins 74, 72, 4, 2)	3	USB_D+
		1	GND

Table 18. 40-Pin eDP Connector

Pin	Signal Name	Pin	Signal Name
1	NC – Reserved	21	LCD_VCC (2.0A total for pins 21, 20, 19, 18)
2	H_GND	22	NC
3	Lane3_N	23	LCD_GND
4	Lane3_P	24	LCD_GND
5	H_GND	25	LCD_GND
6	Lane2_N	26	LCD_GND
7	Lane2_P	27	HPD
8	H_GND	28	BL_GND
9	Lane1_N	29	BL_GND
10	Lane1_P	30	BL_GND
11	H_GND	31	BL_GND
12	Lane0_N	32	BL_ENABLE
13	Lane0_P	33	BL_PWM_DIM
14	H_GND	34	NC - RESERVED
15	AUX_CH_P	35	NC - RESERVED
16	AUX_CH_N	36	BL_PWR (0.6A total for pins 39, 38, 37, 36)
17	H_GND	37	BL_PWR (0.6A total for pins 39, 38, 37, 36)
18	LCD_VCC (2.0A total for pins 21, 20, 19, 18)	38	BL_PWR (0.6A total for pins 39, 38, 37, 36)
19	LCD_VCC (2.0A total for pins 21, 20, 19, 18)	39	BL_PWR (0.6A total for pins 39, 38, 37, 36)
20	LCD_VCC (2.0A total for pins 21, 20, 19, 18)	40	NC - RESERVED

Connector used is right-angled I-PEX-20455-040E-12, 1x40 eDP connector.

2.2.4.2 Add-in Card Connectors

The board supports M.2 2230 (key type E) (WLAN) and 2280 (key type M) (SSD) Modules.

- M.2 2230 (key type E) (WLAN): Supports PCIe x1, USB 2.0
- M.2 2280 (key type M) (SSD): Supports PCIe x4 and SATA

2.2.4.3 Front Panel Header (2.0 mm Pitch)

This section describes the functions of the front panel header. Table 19 lists the signal names of the front panel header. Figure 9 is a connection diagram for the front panel header.

Table 19. Front Panel Header (2.0 mm Pitch)

Pin	Signal Name	Description	Pin	Signal Name	Description
1	HDD_POWER_LED	Pull-up 750 Ω to +5V	2	POWER_LED_MAIN	[Out] Front panel LED (main color)
3	HDD_LED#	[Out] HDD activity LED	4	POWER_LED_ALT	[Out] Front panel LED (alt color)
5	GROUND	Ground	6	POWER_SWITCH#	[In] Power switch
7	RESET_SWITCH#	[In] Reset switch	8	GROUND	Ground
9	+5V_DC (1A) (Vcc)	VCC5 (1A current rating)	10	Key	No pin
11	5Vsby (2A)	5VSB (2A current rating)	12	3.3Vsby (1A)	3VSB (1A current rating)

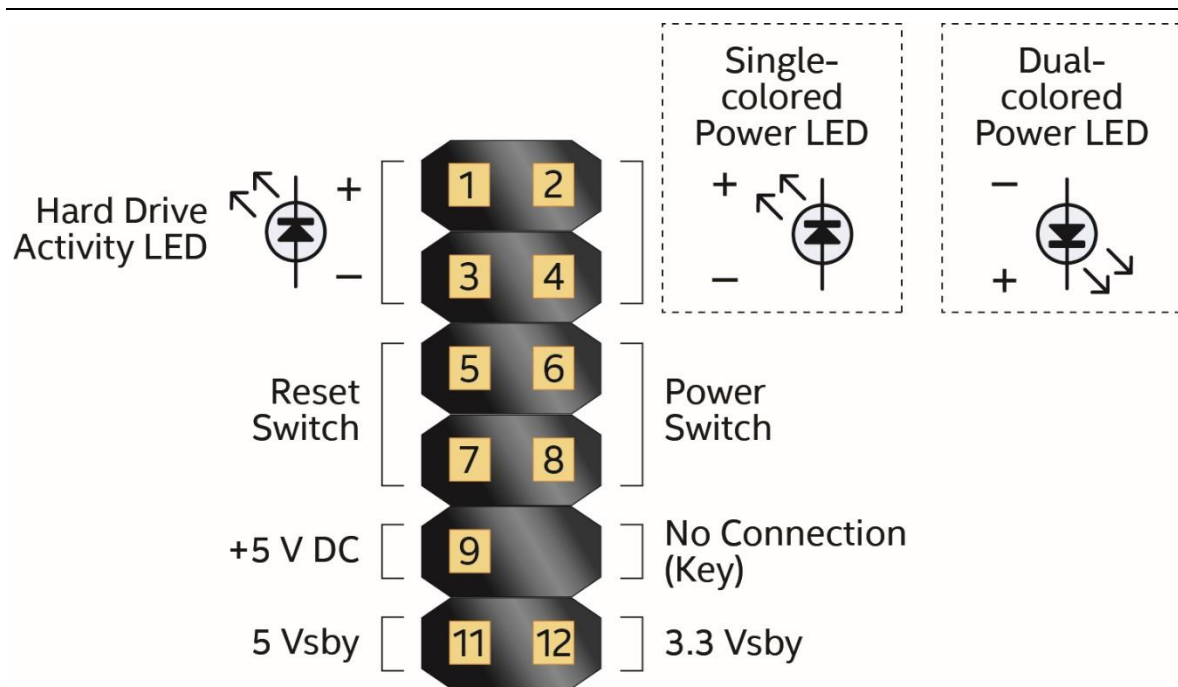

24329

Figure 13. Connection Diagram for Front Panel Header (2.0 mm Pitch)

2.2.4.3.1 Hard Drive Activity LED Header

Pins 1 and 3 can be connected to an LED to provide a visual indicator that data is being read from or written to a hard drive. Proper LED function requires a SATA hard drive or optical drive connected to an onboard SATA connector.

2.2.4.3.2 Reset Switch Header

Pins 5 and 7 can be connected to a momentary single pole, single throw (SPST) type switch that is normally open. When the switch is closed, the board resets and runs the POST.

2.2.4.3.3 Power/Sleep LED Header

Pins 2 and 4 can be connected to a one- or two-color LED. Table 20 and Table 21 show the possible LED states.

Table 20. States for a One-Color Power LED

LED State	Description
Off	Power off
Blinking	Standby
Steady	Normal operation

Table 21. States for a Dual-Color Power LED

LED State	Description
Off	Power off
Blinking (white)	Standby
Steady (white)	Normal operation



NOTE

The LED behavior shown in Table 20 is default – other patterns may be set via BIOS setup.

2.2.4.3.4 Power Switch Header

Pins 6 and 8 can be connected to a front panel momentary-contact power switch. The switch must pull the SW_ON# pin to ground for at least 50 ms to signal the power supply to switch on or off (the time requirement is due to internal debounce circuitry on the board). At least two seconds must pass before the power supply will recognize another on/off signal.

2.2.4.4 Power Supply Connectors

The board has the following power supply connectors:

- **External Power Supply** – the board can be powered through a 12-24 V DC connector on the back panel. The back panel DC connector is compatible with a 5.5 mm/OD (outer diameter) and 2.5 mm/ID (inner diameter) plug, where the inner contact is +12-24 ($\pm 10\%$) V DC and the shell is GND. The maximum current rating is 10 A.



NOTE

External power voltage, 12-24 V DC, is dependent on the type of power brick used.

- **Internal Power Supply** – the board can alternatively be powered via the internal 12-24 V DC 2 x 2 power connector, where pins 1 and 2 are +12-24 ($\pm 10\%$) V DC and pins 3 and 4 are GND. The maximum current rating is 10 A.

The connector used is Molex Micro-Fit (3mm pitch), right-angled, 4-pos/dual row (2x2).

Table 22. 12-24 V Internal Power Supply Connector

Pins	Signal Name
1, 2	+12-24 V ($\pm 10\%$)
3, 4	Ground

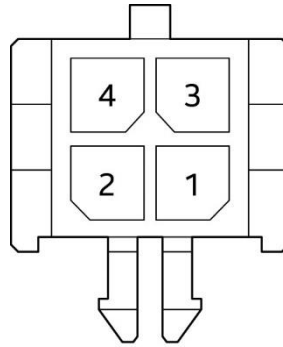

OM24146

Figure 14. Connection Diagram for the Internal Power Supply Connector

2.2.4.4.1 Power Sensing Circuit

The board has a power sensing circuit that:

- manages CPU power usage to maintain system power consumption below 65 W
- is designed and tested for use with the provided 65 W AC-DC adapters



NOTE

It is recommended that you disable this feature (via BIOS option) when using an AC-DC adapter greater than 65 W.

For information about

Power supply considerations

Refer to

Section 2.6.1, page 61

2.3 BIOS Security Jumper

⚠ CAUTION

Do not move a jumper with the power on. Always turn off the power and unplug the power cord from the computer before changing a jumper setting. Otherwise, the board could be damaged.

Figure 15 shows the location of the BIOS Security Jumper. The 3-pin jumper determines the BIOS Security program's mode.

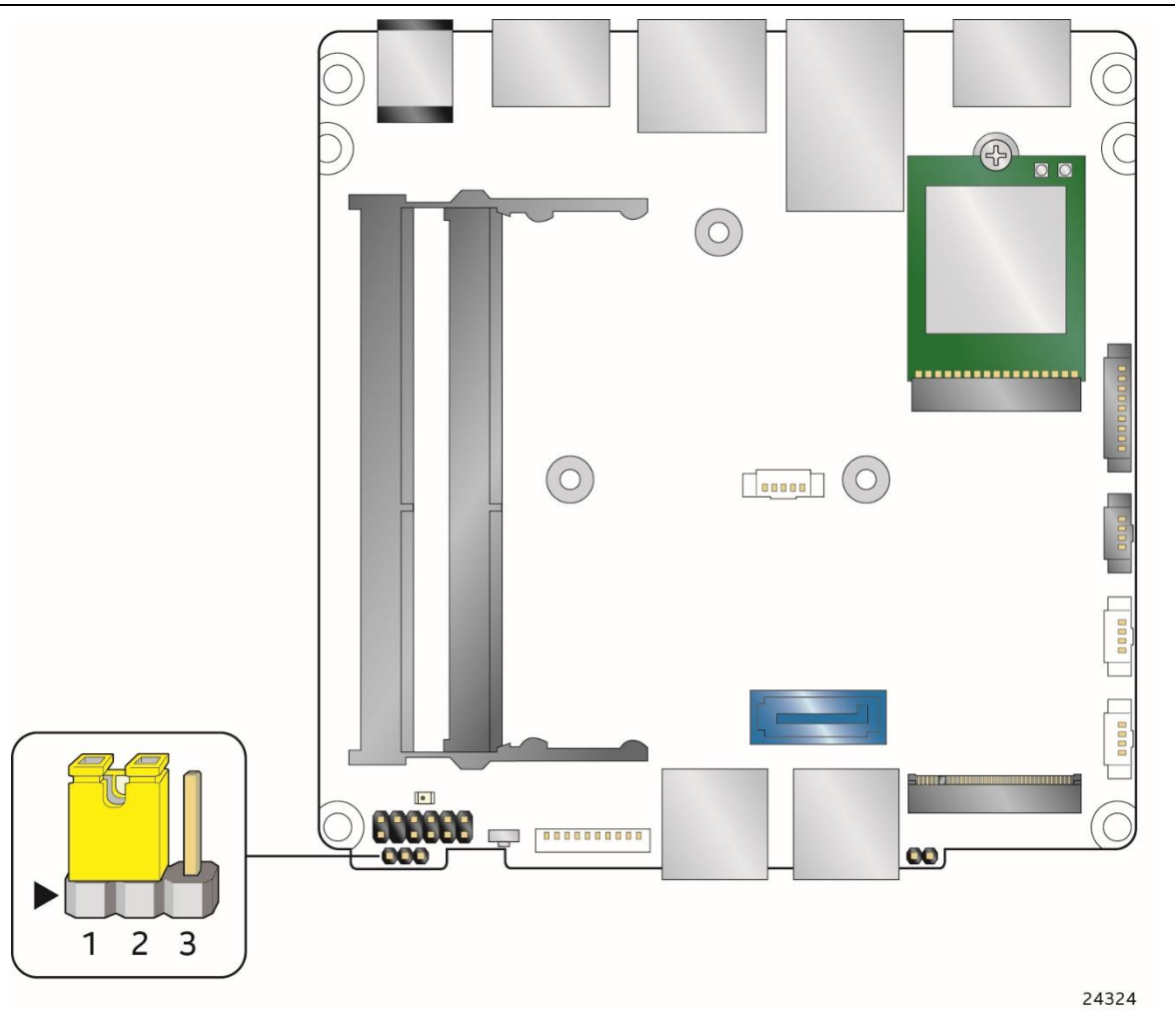

24324

Figure 15. Location of the BIOS Security Jumper

Table 23 describes the jumper settings for the three modes: normal, lockdown, and configuration.

Table 23. BIOS Security Jumper Settings

Function/Mode	Jumper Setting	Configuration
Normal	1-2	The BIOS uses current configuration information and passwords for booting.
Lockdown	2-3	<p>The BIOS uses current configuration information and passwords for booting, except:</p> <ul style="list-style-type: none"> • All POST Hotkeys are suppressed (prompts are not displayed and keys are not accepted. For example, F2 for Setup, F10 for the Boot Menu). • Power Button Menu is not available (see Section 0 Power Button Menu). <p>BIOS updates are not available except for automatic Recovery due to flash corruption.</p>
Configuration	None	<p>BIOS Recovery Update process if a matching *.bio file is found. Recovery Update can be cancelled by pressing the Esc key.</p> <p>If the Recovery Update was cancelled or a matching *.bio file was not found, a Config Menu will be displayed. The Config Menu consists of the following (followed by the Power Button Menu selections):</p> <p>[1] Suppress this menu until the BIOS Security Jumper is replaced.</p> <p>[2] Clear BIOS User and Supervisor Passwords.</p> <p>[3] Reset Intel® AMT to default factory settings.</p> <p>[4] Clear Trusted Platform Module. Warning: Data encrypted with the TPM will no longer be accessible if the TPM is cleared.</p> <p>[F2] Intel® Visual BIOS.</p> <p>[F4] BIOS Recovery.</p> <p>See Section 0 Power Button Menu.</p>

2.4 Intel® Management Engine BIOS Extension (Intel® MEBX) Reset Header

The Intel® MEBX reset header (see Figure 16) allows you to reset the Intel ME configuration to the factory defaults. Momentarily shorting pins 1 and 2 with a jumper (not supplied) will accomplish the following:

- Return all Intel ME parameters to their default values.
- Reset the Intel MEBX password to the default value (admin).
- Unconfigure Intel AMT.



CAUTION

Always turn off the power and unplug the power cord from the computer before installing an MEBX reset jumper. The jumper must be removed before reapplying power. The system must be allowed to reach end of POST before reset is complete. Otherwise, the board could be damaged.



NOTE

After using the MEBX Reset, a "CMOS battery failure" warning will occur during the next POST. This is expected and does not indicate a component failure.



NOTE

The MEBX_RESET header has a non-conductive protective cap installed. This must be removed before installing the MEBX_RESET jumper, and reinstalled before reassembling the system. Failure to do so may result in inadvertent shorting of the bottom cover screw to the header during bottom cover reassembly (see Figure 16).

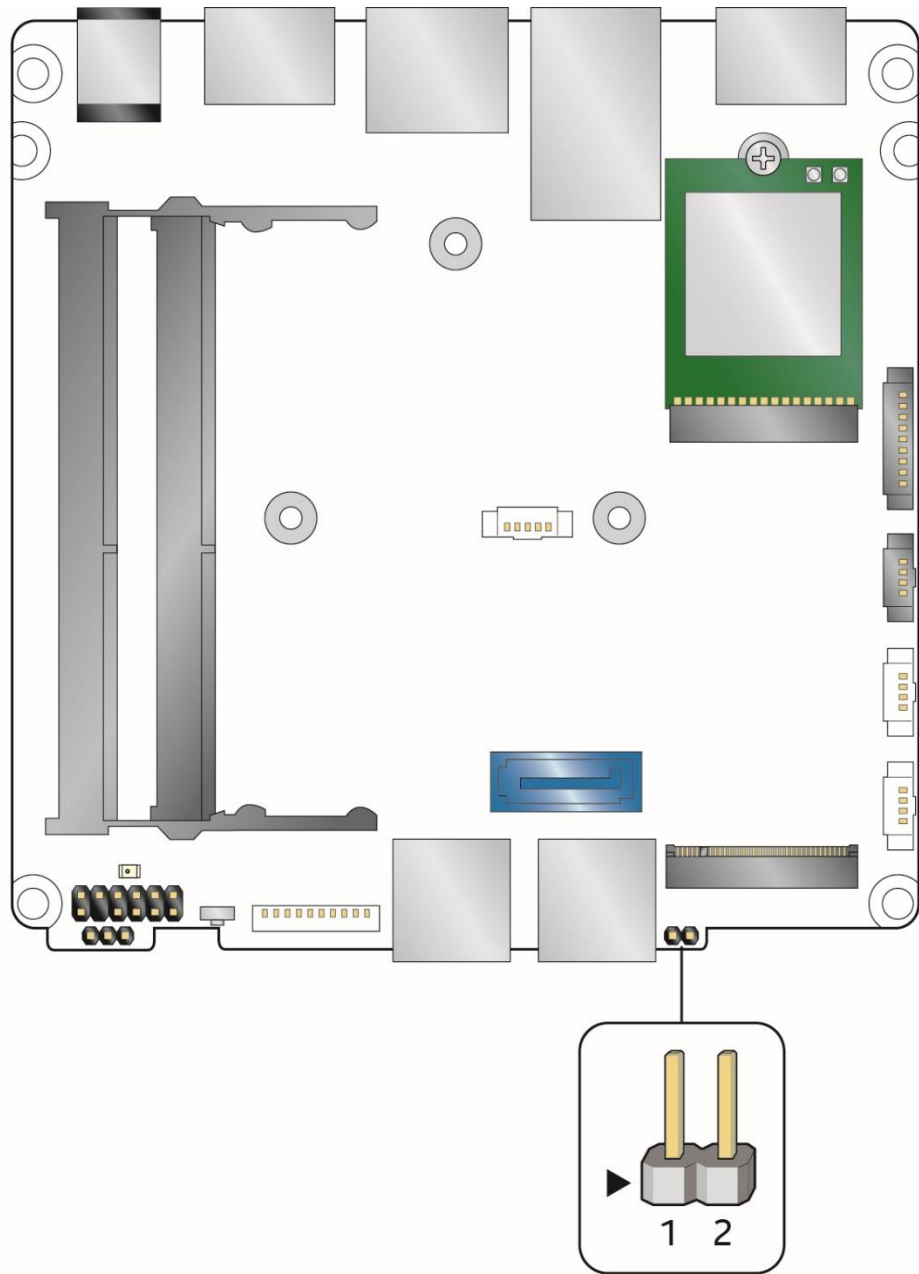

24325

Figure 16. Intel MEBX Reset Header

Table 24. Intel MEBX Reset Header Signals

Pin	Function
1	RTCRST
2	Ground

2.5 Mechanical Considerations

2.5.1 Form Factor

The board is designed to fit into a custom chassis. Figure 17 illustrates the mechanical form factor for the board. Dimensions are given in inches [millimeters]. The outer dimensions are 4.0 inches by 4.0 inches [101.60 millimeters by 101.60 millimeters].

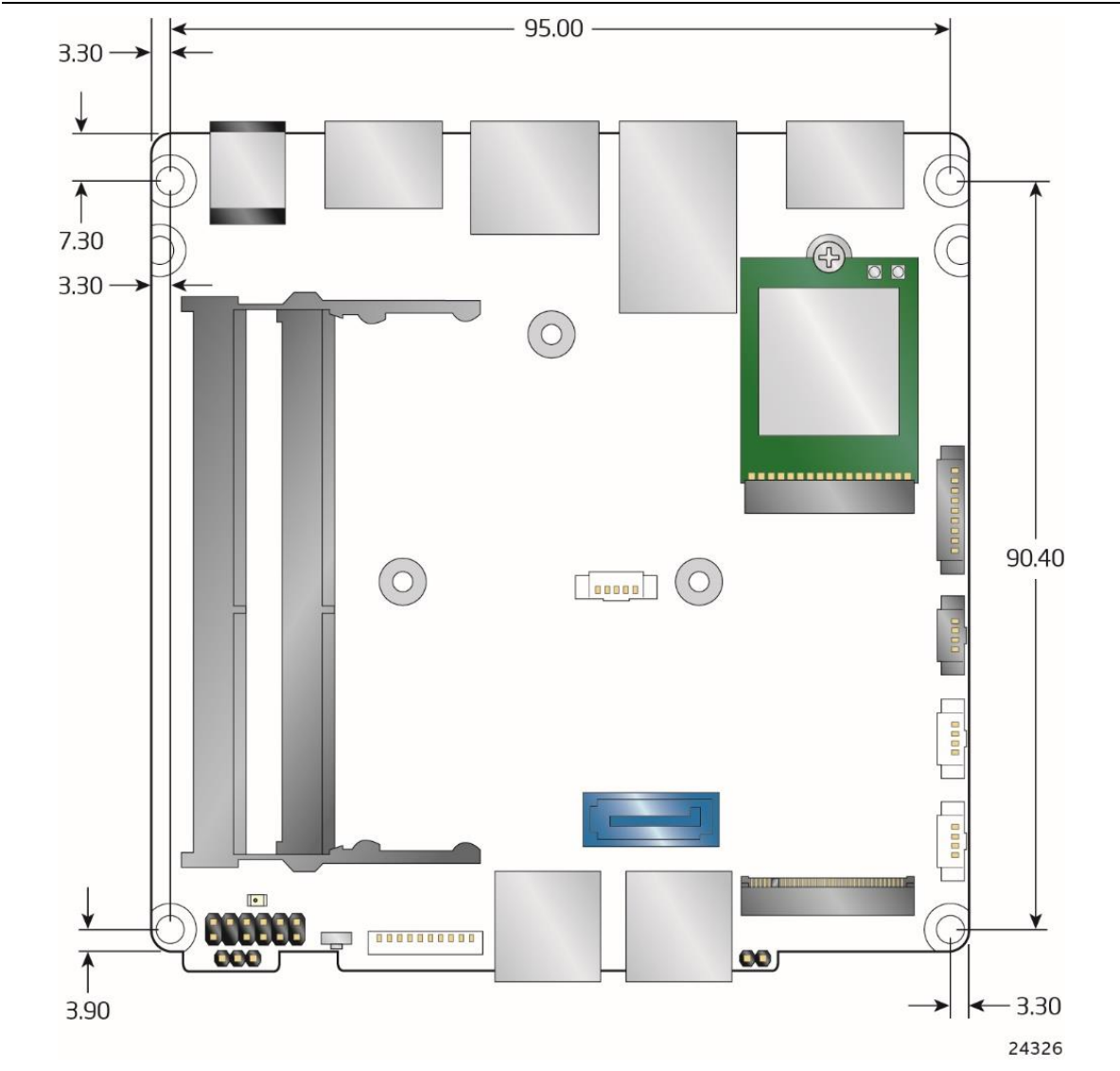

Figure 17. Board Dimensions

Figure 18 shows the height dimensions of the board. Dimensions are in mm.

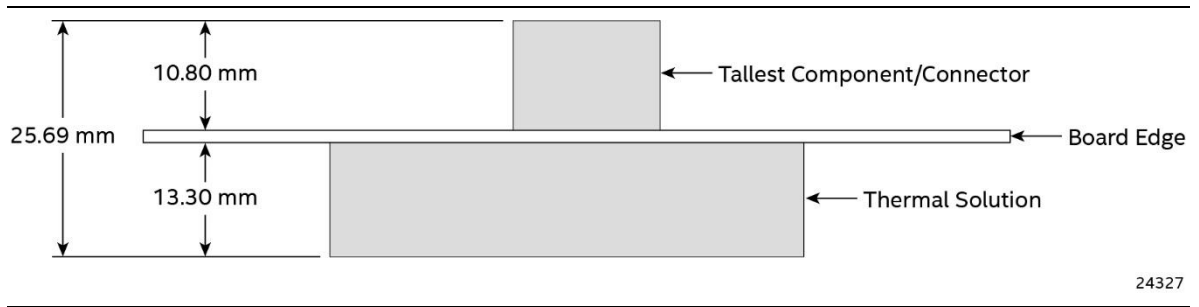

Figure 18. Board Height Dimensions

2.6 Electrical Considerations

2.6.1 Power Supply Considerations

System power requirements will depend on actual system configurations chosen by the integrator, as well as end user expansion preferences. It is the system integrator's responsibility to ensure an appropriate power budget for the system configuration is properly assessed based on the system-level components chosen. See Section 2.2.4.4 Power Supply Connector for more information.

- The back panel input range is 12-24 V DC
- The internal power connector input range is 12-24 V DC



CAUTION

The external DC jack is the primary power input connector of Intel NUC Board NUC7i5DNBE. However, the board also provides an internal 2 x 2 power connector that can be used in custom-developed systems that have an internal power supply. The internal 2 x 2 power connector is a Molex Micro-Fit (3mm pitch), right-angled, 4-pos/dual row connector.

There is no isolation circuitry between the external DC jack and the internal 2 x 2 power connector. It is the system integrator's responsibility to ensure no more than one power supply unit is or can be attached to the board at any time and to ensure the external DC jack is covered if the internal 2 x 2 power connector is to be used. Simultaneous connection of both external and internal power supply units could result in potential damage to the board, power supplies, or other hardware.

Table 25. Power Budget for Assessing the DC-to-DC Circuit's Power Rating (worst case: Embedded board in 3rd party chassis)

NUC7i5DNBE (3 rd party chassis)	Estimated Adapter Power Consumption (W)
CPU KBL-U 15 W SoC	15
Chipset	2.38
2 x DDR4 SODIMM	7.99
WLAN	0.40
2 x USB 2.0 (Internal)	2.78
USB 3.0 (Internal)	2.50
4 x USB 3.0	20
2 x HDMI 2.0	0.06
M.2 2280 Module	3.03
SATA HDD 2.5"	4.43
LAN	0.07
Front Panel	0.56
HDMI CEC	0.11

2.6.2 Fan Header Current Capability

Table 35 lists the current capability of the fan headers.

Table 26. Fan Header Current Capability

Fan Header	Maximum Available Current
Processor fan	.6 A

2.7 Thermal Considerations



CAUTION

Failure to ensure appropriate airflow may result in reduced performance of both the processor and/or voltage regulator or, in some instances, damage to the board.

All responsibility for determining the adequacy of any thermal or system design remains solely with the system integrator. Intel makes no warranties or representations that merely following the instructions presented in this document will result in a system with adequate thermal performance.



CAUTION

Ensure that the ambient temperature does not exceed the board's maximum operating temperature. Failure to do so could cause components to exceed their maximum case temperature and malfunction. For information about the maximum operating temperature, see the environmental specifications in Section 0.



CAUTION

Ensure that proper airflow is maintained in the processor voltage regulator circuit. Failure to do so may result in shorter than expected product lifetime.

Figure 19 shows the locations of the localized high temperature zones.

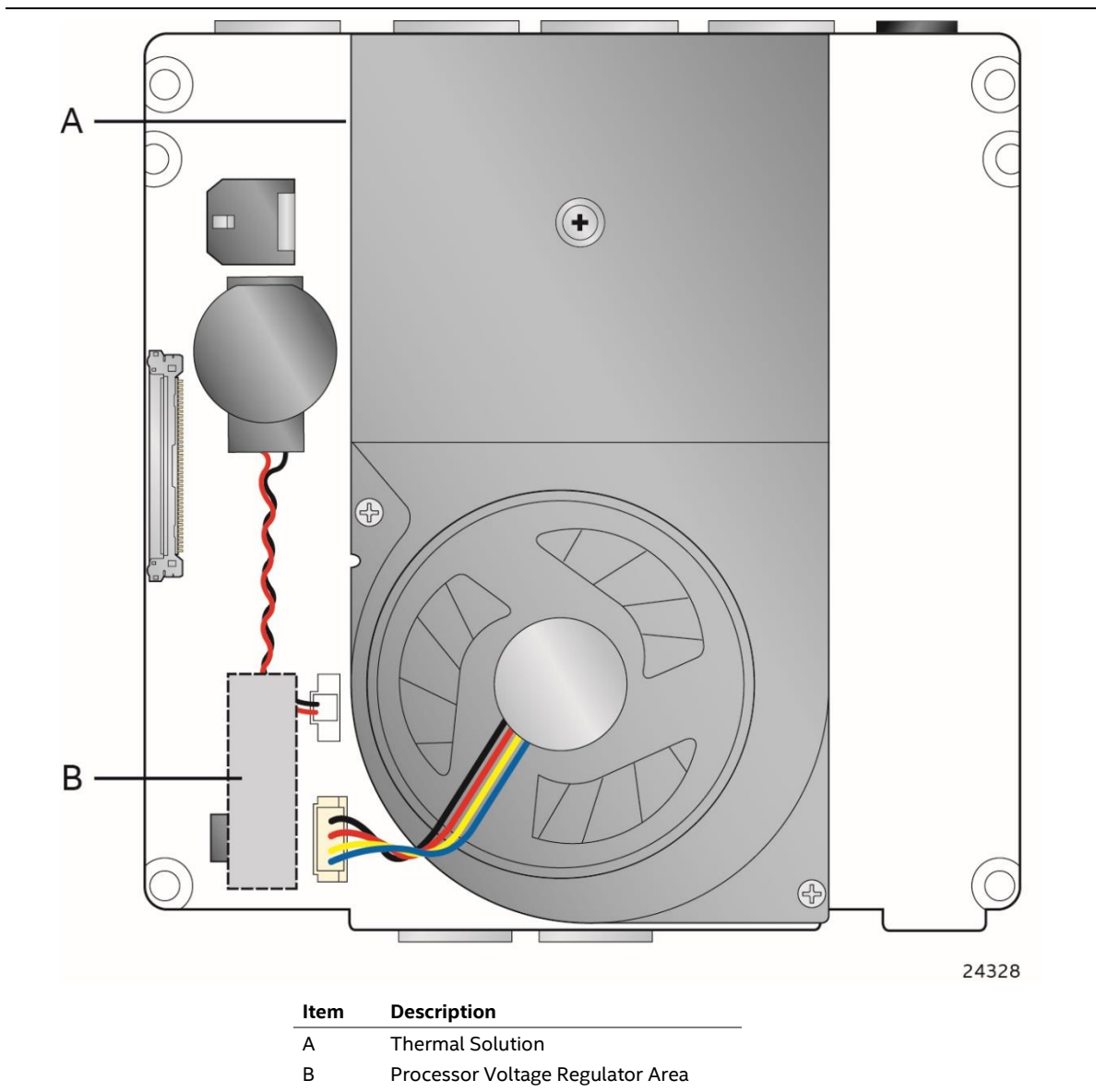
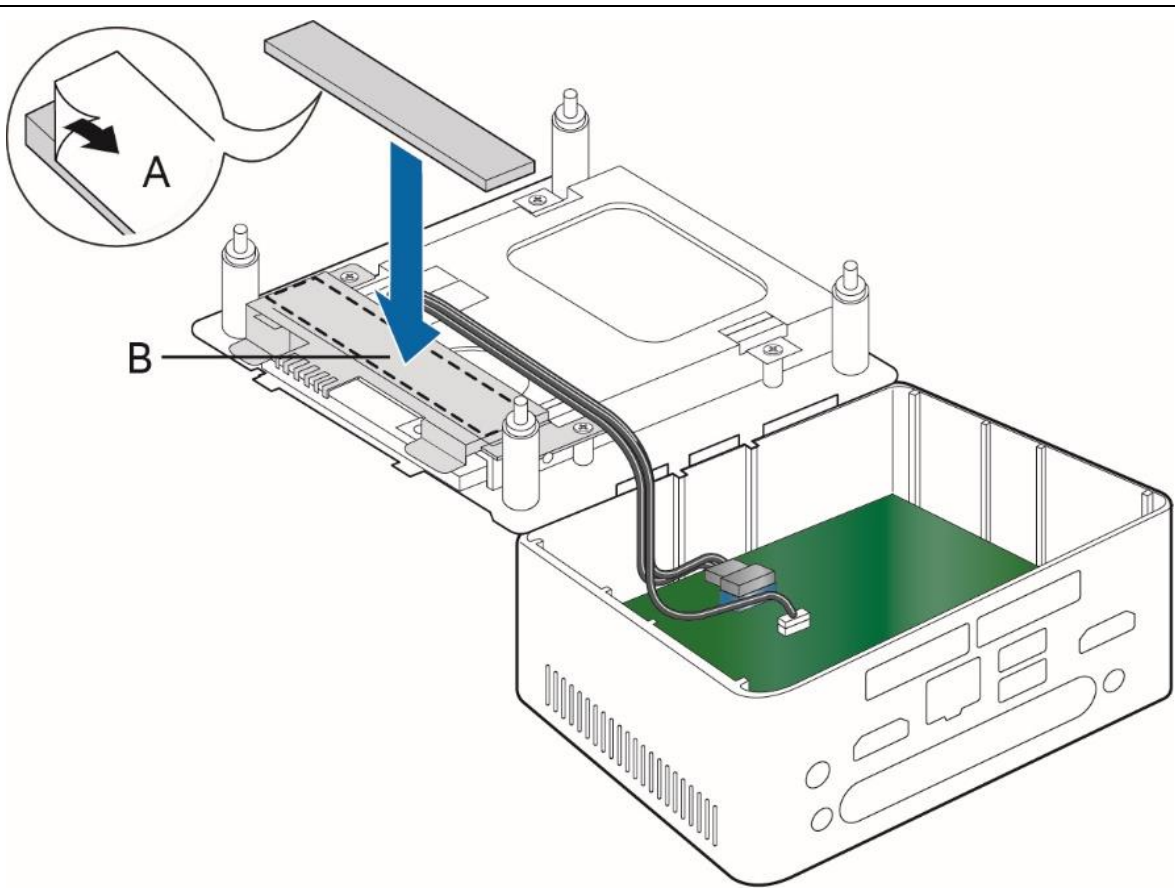

Figure 19. Localized High Temperature Zones

A thermal pad has been installed for the bottom of the chassis to improve the thermal performance when using M.2 devices that operate at higher temperatures. If the thermal pad ever needs to be replaced, Figure 24 shows the installation area of the thermal pad.



24331

Item	Description
A	Thermal Pad
B	Thermal Pad Installation Area

Figure 20. Installation Area of the Thermal Pad

Table 27 provides maximum case temperatures for the components that are sensitive to thermal changes. The operating temperature, current load, or operating frequency could affect case temperatures. Maximum case temperatures are important when considering proper airflow to cool the board.

Table 27. Thermal Considerations for Components

Component	Maximum Case Temperature
Processor	For processor case temperature, see processor datasheets and processor specification updates

To ensure functionality and reliability, the component is specified for proper operation when Case Temperature is maintained at or below the maximum temperature listed in Table 28. This is a requirement for sustained power dissipation equal to Thermal Design Power (TDP is specified as the maximum sustainable power to be dissipated by the components). When the component is dissipating less than TDP, the case temperature should be below the Maximum Case Temperature. The surface temperature at the geometric center of the component corresponds to Case Temperature.

It is important to note that the temperature measurement in the system BIOS is a value reported by embedded thermal sensors in the components and does not directly correspond to the Maximum Case Temperature. The upper operating limit when monitoring this thermal sensor is Tcontrol.

Table 28. Tcontrol Values for Components

Component	Tcontrol
Processor	For processor case temperature, see processor datasheets and processor specification updates

For information about	Refer to
Processor datasheets and specification updates	Section 1.3, page 19

2.8 Reliability

The demonstrated Mean Time Between Failures (MTBF) is done through 24/7 testing. Full Intel® NUC systems in chassis with memory, SSD or HDD, and a fan are ran at 100% on time for 90 days continuously while running system wide stress inducing software in a 40 °C ambient air temperature chamber. The demonstrated MTBF for Intel NUC Board NUC7i7DNBE is 50,000 hours.

2.9 Environmental

Table 29 lists the environmental specifications for the board.

Table 29. Environmental Specifications

Parameter	Specification		
Temperature			
Sustained Storage Limits (i.e. warehouse)	-20 °C to +40 °C		
Short Duration Limits (i.e. shipping)	-40 °C to +60 °C		
Ambient Operating – NUC Kit*	0 °C to +40 °C		
Ambient Operating – NUC Board*	0 °C to +50 °C		
* Processor performance may automatically decrease when the system operates in the top 5 °C of the ambient operating temperature ranges above.			
Shock			
Unpackaged	50 g trapezoidal waveform		
Velocity change of 170 inches/s ²			
Packaged	Product Weight (pounds)	Non-palletized Product drop height (inches)	Palletized drop heights (single product) (inches)
	<20	36	N/A
	21-40	30	N/A
	41-80	24	N/A
	81-100	18	12
	100-120	12	9
	>120	9	9
Vibration			
Unpackaged	5 Hz to 20 Hz: 0.01 g ² Hz sloping up to 0.02 g ² Hz		
	20 Hz to 500 Hz: 0.02 g ² Hz (flat)		
Packaged	5 Hz to 40 Hz: 0.015 g ² Hz (flat)		
	40 Hz to 500 Hz: 0.015 g ² Hz sloping down to 0.00015 g ² Hz		

Note: The operating temperature of the board may be determined by measuring the air temperature from the junction of the heatsink fins and fan, next to the attachment screw, in a closed chassis, while the system is in operation.

Note: Before attempting to operate this board, the overall temperature of the board must be above the minimum operating temperature specified. It is recommended that the board temperature be at least room temperature before attempting to power on the board. The operating and non-operating environment must avoid condensing humidity.



CAUTION

If the external ambient temperature exceeds 40 °C, further thermal testing is required to ensure components do not exceed their maximum operating temperature.

3 Overview of BIOS Features

3.1 Introduction

The board uses Intel Visual BIOS that is stored in the Serial Peripheral Interface Flash Memory (SPI Flash) and can be updated using a disk-based program. The SPI Flash contains the Visual BIOS Setup program, POST, the PCI auto-configuration utility, LAN EEPROM information, and Plug and Play support.

The BIOS displays a message during POST identifying the type of BIOS and a revision code. The initial production BIOSs are identified as DNKBLi5v.86A.

The Visual BIOS Setup program can be used to view and change the BIOS settings for the computer. The BIOS Setup program is accessed by pressing the <F2> key after the Power-On Self-Test (POST) memory test begins and before the operating system boot begins.



NOTE

The maintenance menu is displayed only when the board is in configure mode. Section 2.3 on page 55 shows how to put the board in configure mode.

3.2 BIOS Flash Memory Organization

The Serial Peripheral Interface Flash Memory (SPI Flash) includes a 16 MB flash memory device.

3.3 System Management BIOS (SMBIOS)

SMBIOS is a Desktop Management Interface (DMI) compliant method for managing computers in a managed network.

The main component of SMBIOS is the Management Information Format (MIF) database, which contains information about the computing system and its components. Using SMBIOS, a system administrator can obtain the system types, capabilities, operational status, and installation dates for system components. The MIF database defines the data and provides the method for accessing this information. The BIOS enables applications such as third-party management software to use SMBIOS. The BIOS stores and reports the following SMBIOS information:

- BIOS data, such as the BIOS revision level
- Fixed-system data, such as peripherals, serial numbers, and asset tags
- Resource data, such as memory size, cache size, and processor speed
- Dynamic data, such as event detection and error logging

Non-Plug and Play operating systems require an additional interface for obtaining the SMBIOS information. The BIOS supports an SMBIOS table interface for such operating systems. Using this support, an SMBIOS service-level application running on a non-Plug and Play operating system can obtain the SMBIOS information. Additional board information can be found in the BIOS under the Additional Information header under the Main BIOS page.

3.4 Legacy USB Support

Legacy USB support enables USB devices to be used even when the operating system's USB drivers are not yet available. Legacy USB support is used to access the BIOS Setup program, and to install an operating system that supports USB. By default, Legacy USB support is set to Enabled.

Legacy USB support operates as follows:

1. When you apply power to the computer, legacy support is disabled.
2. POST begins.
3. Legacy USB support is enabled by the BIOS allowing you to use a USB keyboard to enter and configure the BIOS Setup program and the maintenance menu.
4. POST completes.
5. The operating system loads. While the operating system is loading, USB keyboards and mice are recognized and may be used to configure the operating system. (Keyboards and mice are not recognized during this period if Legacy USB support was set to Disabled in the BIOS Setup program.)
6. After the operating system loads the USB drivers, all legacy and non-legacy USB devices are recognized by the operating system, and Legacy USB support from the BIOS is no longer used.

To install an operating system that supports USB, verify that Legacy USB support in the BIOS Setup program is set to Enabled and follow the operating system's installation instructions.

3.5 BIOS Updates

The BIOS can be updated using one of the following methods:

- Intel® Express BIOS Update utility, which enables automated updating while in the Windows environment. Using this utility, the BIOS can be updated from a file on a hard disk, a USB drive, a CD-ROM, or from the file location on the Web.
- Intel® Flash Memory Update Utility, which requires booting from DOS. In order to boot from DOS the legacy boot option in the BIOS has to be checked. Using this utility, the BIOS can be updated from a file on a hard disk or a USB drive.
- Intel® F7 switch during POST allows a user to select where the BIOS .bio file is located and perform the update from that location/device. Similar to performing a BIOS Recovery without removing the BIOS configuration jumper. The F7 switch supports FAT, FAT32, and NTFS format storage.
- Intel® Visual BIOS has an option to update the BIOS from a valid .bio file located on a hard disk or USB drive. Enter Intel Visual BIOS by pressing <F2> during POST.

Both utilities verify that the updated BIOS matches the target system to prevent accidentally installing an incompatible BIOS.



NOTE

Review the instructions distributed with the upgrade utility before attempting a BIOS update.

For information about	Refer to
BIOS update utilities	http://support.intel.com/support/motherboards/desktop/sb/CS-034499.htm

3.5.1 Language Support

The BIOS Setup program and help messages are supported in US English. Check the Intel web site for support.

3.5.2 BIOS Recovery

It is unlikely that anything will interrupt a BIOS update; however, if an interruption occurs, the BIOS could be damaged. Table 30 lists the drives and media types that can and cannot be used for BIOS recovery. The BIOS recovery media does not need to be made bootable.

Table 30. Acceptable Drives/Media Types for BIOS Recovery

Media Type ^(Note)	Can be used for BIOS recovery?
Hard disk drive (connected to SATA or USB)	Yes
USB flash drive	Yes



NOTE

Supported file systems for BIOS recovery:

- *NTFS (sparse, compressed, or encrypted files are not supported)*
- *FAT32*
- *FAT16*
- *FAT12*
- *ISO 9660*

For information about	Refer to
------------------------------	-----------------

BIOS recovery	http://www.intel.com/support/motherboards/desktop/sb/cs-034524.htm
---------------	---

3.6 Boot Options

In the BIOS Setup program, the user can choose to boot from a hard drive, optical drive, removable drive, or the network. The default setting is for the optical drive to be the first boot device, the hard drive second, removable drive third, and the network fourth.



NOTE

Optical drives are not supported by the onboard SATA connectors. Optical drives are supported only via the USB interfaces.

3.6.1 Network Boot

The network can be selected as a boot device. This selection allows booting from the onboard LAN or a network add-in card with a remote boot ROM installed.

Pressing the <F12> key during POST automatically forces booting from the LAN. To use this key during POST, the User Access Level in the BIOS Setup program's Security menu must be set to Full.

3.6.2 Booting Without Attached Devices

For use in embedded applications, the BIOS has been designed so that after passing the POST, the operating system loader is invoked even if the following devices are not present:

- Video adapter
- Keyboard
- Mouse

3.6.3 Changing the Default Boot Device during POST

Pressing the <F10> key during POST causes a boot device menu to be displayed. This menu displays the list of available boot devices. Table 31 lists the boot device menu options.

Table 31. Boot Device Menu Options

Boot Device Menu Function Keys	Description
<↑> or <↓>	Selects a default boot device
<Enter>	Exits the menu, and boots from the selected device
<Esc>	Exits the menu and boots according to the boot priority defined through BIOS setup

3.6.4 Power Button Menu

As an alternative to Back-to-BIOS Mode or normal POST Hotkeys, the user can use the power button to access a menu. The Power Button Menu is accessible via the following sequence:

1. System is in S4/S5 (not G3)
2. User pushes the power button and holds it down for 3 seconds
3. The system will emit three short beeps from the front panel (FP) audio port, then stop to signal the user to release the power button. The FP power button LED will also change from Blue to Amber when the user can release the power button.
4. User releases the power button before the 4-second shutdown override

If this boot path is taken, the BIOS will use default settings, ignoring settings in VPD where possible.

At the point where Setup Entry/Boot would be in the normal boot path, the BIOS will display the following prompt and wait for a keystroke:

[ESC] Normal Boot
[F2] Intel Visual BIOS
[F3] Disable Fast Boot
[F4] BIOS Recovery
[F7] Update BIOS
[F10] Enter Boot Menu
[F12] Network Boot

[F2] Enter Setup is displayed instead if Visual BIOS is not supported.

[F3] Disable Fast Boot is only displayed if at least one Fast Boot optimization is enabled.

[F9] Remote Assistance is only displayed if Remote Assistance is supported.

If an unrecognized key is hit, then the BIOS will beep and wait for another keystroke. If one of the listed hotkeys is hit, the BIOS will follow the indicated boot path. Password requirements must still be honored.

If Disable Fast Boot is selected, the BIOS will disable all Fast Boot optimizations and reset the system.

3.7 Hard Disk Drive Password Security Feature

The Hard Disk Drive Password Security feature blocks read and write accesses to the hard disk drive until the correct password is given. Hard Disk Drive Passwords are set in BIOS SETUP and are prompted for during BIOS POST. For convenient support of S3 resume, the system BIOS will automatically unlock drives on resume from S3. Valid password characters are A-Z, a-z, and 0-9. Passwords may be up to 19 characters in length.

The User hard disk drive password, when installed, will be required upon each power-cycle until the Master Key or User hard disk drive password is submitted.

The Master Key hard disk drive password, when installed, will not lock the drive. The Master Key hard disk drive password exists as an unlock override in the event that the User hard disk drive password is forgotten. Only the installation of the User hard disk drive password will cause a hard disk to be locked upon a system power-cycle.

Table 32 shows the effects of setting the Hard Disk Drive Passwords.

Table 32. Master Key and User Hard Drive Password Functions

Password Set	Password During Boot
Neither	None
Master only	None
User only	User only
Master and User Set	Master or User

During every POST, if a User hard disk drive password is set, POST execution will pause with the following prompt to force the user to enter the Master Key or User hard disk drive password:

“Enter Hard Disk Drive Password:”

Upon successful entry of the Master Key or User hard disk drive password, the system will continue with normal POST.

If the hard disk drive password is not correctly entered, the system will go back to the above prompt. The user will have three attempts to correctly enter the hard disk drive password. After the third unsuccessful hard disk drive password attempt, the system will halt with the message:

“Hard Disk Drive Password Entry Error”

A manual power cycle will be required to resume system operation.



NOTE

As implemented on Intel NUC Board NUC7i5DNBE, Hard Disk Drive Password Security is only supported on either SATA Port 0 (M.2) or SATA Port 1 (onboard SATA connector). The passwords are stored on the hard disk drive so if the drive is relocated to another computer that does not support Hard Disk Drive Password Security feature, the drive will not be accessible.

3.8 BIOS Security Features

The BIOS includes security features that restrict access to the BIOS Setup program and who can boot the computer. A supervisor password and a user password can be set for the BIOS Setup program and for booting the computer, with the following restrictions:

- The supervisor password gives unrestricted access to view and change all the Setup options in the BIOS Setup program. This is the supervisor mode.
- The user password gives restricted access to view and change Setup options in the BIOS Setup program. This is the user mode.
- If only the supervisor password is set, pressing the <Enter> key at the password prompt of the BIOS Setup program allows the user restricted access to Setup.
- If both the supervisor and user passwords are set, users can enter either the supervisor password or the user password to access Setup. Users have access to Setup respective to which password is entered.
- Setting the user password restricts who can boot the computer. The password prompt will be displayed before the computer is booted. If only the supervisor password is set, the computer boots without asking for a password. If both passwords are set, the user can enter either password to boot the computer.
- For enhanced security, use different passwords for the supervisor and user passwords.
- Valid password characters are A-Z, a-z, and 0-9. Passwords may be up to 16 characters in length.
- To clear a set password, enter a blank password after entering the existing password.

Table 33 shows the effects of setting the supervisor password and user password. This table is for reference only and is not displayed on the screen.

Table 33. Supervisor and User Password Functions

Password Set	Supervisor Mode	User Mode	Setup Options	Password to Enter Setup	Password During Boot
Neither	Can change all options (Note)	Can change all options (Note)	None	None	None
Supervisor only	Can change all options	Can change a limited number of options	Supervisor Password	Supervisor	None
User only	N/A	Can change all options	Enter Password Clear User Password	User	User
Supervisor and user set	Can change all options	Can change a limited number of options	Supervisor Password Enter Password	Supervisor or user	Supervisor or user

Note: If no password is set, any user can change all Setup options.

4 Error Messages and Blink Codes

4.1 Front-panel Power LED Blink Codes

Whenever a recoverable error occurs during POST, the BIOS causes the board's front panel power LED to blink an error message describing the problem (see Table 34).

Table 34. Front-panel Power LED Blink Codes

Type	Pattern	Note
BIOS update in progress	Off when the update begins, then on for 0.5 seconds, then off for 0.5 seconds. The pattern repeats until the BIOS update is complete.	
Video error ^(Note)	On-off (1.0 second each) two times, then 2.5-second pause (off), entire pattern repeats (blink and pause) until the system is powered off.	When no VGA option ROM is found.
Memory error	On-off (1.0 second each) three times, then 2.5-second pause (off), entire pattern repeats (blinks and pause) until the system is powered off.	
Thermal trip warning	Each beep will be accompanied by the following blink pattern: .25 seconds on, .25 seconds off, .25 seconds on, .25 seconds off. This will result in a total of 16 blinks.	

Note: Disabled per default BIOS setup option.

4.2 BIOS Error Messages

Table 35 lists the error messages and provides a brief description of each.

Table 35. BIOS Error Messages

Error Message	Explanation
CMOS Battery Low	The battery may be losing power. Replace the battery soon.
CMOS Checksum Bad	The CMOS checksum is incorrect. CMOS memory may have been corrupted. Run Setup to reset values.
Memory Size Decreased	Memory size has decreased since the last boot. If no memory was removed, then memory may be bad.
No Boot Device Available	System did not find a device to boot.

5 Regulatory Compliance and Battery Disposal Information

5.1 Regulatory Compliance

This section contains the following regulatory compliance information for Intel NUC Board NUC7i5DNBE:

- Safety standards
- European Union Declaration of Conformity statement
- Electromagnetic Compatibility (EMC) standards
- Product Ecology statements
- Regulatory Compliance Marks

5.1.1 Safety Standards

Intel NUC Board NUC7i5DNBE complies with the safety standards stated in Table 36 when correctly installed in a compatible host system.

Table 36. Safety Standards

Standard	Title
CSA/UL 60950-1	Information Technology Equipment – Safety - Part 1: General Requirements (USA and Canada)
EN 60950-1	Information Technology Equipment – Safety - Part 1: General Requirements (European Union)
IEC 60950-1	Information Technology Equipment – Safety - Part 1: General Requirements (International)
EN62368-1	Information Technology Equipment – Safety - Part 1: General Requirements (European Union)

5.1.2 European Union Declaration of Conformity Statement

We, Intel Corporation, declare under our sole responsibility that the products Intel® NUC Board NUC7i5DNBE is in conformity with all applicable essential requirements necessary for CE marking, following the provisions of the European Council Directive 2004/108/EC (EMC Directive), 2006/95/EC (Low Voltage Directive), and 2011/65/EU (ROHS Directive).

The product is properly CE marked demonstrating this conformity and is for distribution within all member states of the EU with no restrictions.



This product follows the provisions of the European Directives 2004/108/EC, 2006/95/EC, and 2011/65/EU.

Čeština Tento výrobek odpovídá požadavkům evropských směrnic 2004/108/EC, 2006/95/EC a 2002/95/EC.

- Dansk** Dette produkt er i overensstemmelse med det europæiske direktiv 2004/108/EC, 2006/95/EC & 2002/95/EC.
- Dutch** Dit product is in navolging van de bepalingen van Europees Directief 2004/108/EC, 2006/95/EC & 2002/95/EC.
- Eesti** Antud toode vastab Euroopa direktiivides 2004/108/EC, ja 2006/95/EC ja 2002/95/EC kehtestatud nõuetele.
- Suomi** Tämä tuote noudattaa EU-direktiivin 2004/108/EC, 2006/95/EC & 2002/95/EC määräyksiä.
- Français** Ce produit est conforme aux exigences de la Directive Européenne 2004/108/EC, 2006/95/EC & 2002/95/EC.
- Deutsch** Dieses Produkt entspricht den Bestimmungen der Europäischen Richtlinie 2004/108/EC, 2006/95/EC & 2002/95/EC.
- Ελληνικά** Το παρόν προϊόν ακολουθεί τις διατάξεις των Ευρωπαϊκών Οδηγιών 2004/108/EC, 2006/95/EC και 2002/95/EC.
- Magyar** E termék megfelel a 2004/108/EC, 2006/95/EC és 2002/95/EC Európai Irányelv előírásainak.
- Icelandic** Þessi vara stenst reglugerð Evrópska Efnahags Bandalagsins númer 2004/108/EC, 2006/95/EC, & 2002/95/EC.
- Italiano** Questo prodotto è conforme alla Direttiva Europea 2004/108/EC, 2006/95/EC & 2002/95/EC.
- Latviešu** Šis produkts atbilst Eiropas Direktīvu 2004/108/EC, 2006/95/EC un 2002/95/EC noteikumiem.
- Lietuvių** Šis produktas atitinka Europos direktyvų 2004/108/EC, 2006/95/EC, ir 2002/95/EC nuostatas.
- Malti** Dan il-prodott hu konformi mal-provvedimenti tad-Direttivi Ewropej 2004/108/EC, 2006/95/EC u 2002/95/EC.
- Norsk** Dette produktet er i henhold til bestemmelsene i det europeiske direktivet 2004/108/EC, 2006/95/EC & 2002/95/EC.
- Polski** Niniejszy produkt jest zgodny z postanowieniami Dyrektyw Unii Europejskiej 2004/108/EC, 206/95/EC i 2002/95/EC.
- Portuguese** Este produto cumpre com as normas da Diretiva Europeia 2004/108/EC, 2006/95/EC & 2002/95/EC.
- Español** Este producto cumple con las normas del Directivo Europeo 2004/108/EC, 2006/95/EC & 2002/95/EC.
- Slovensky** Tento produkt je v súlade s ustanoveniami európskych direktív 2004/108/EC, 2006/95/EC a 2002/95/EC.
- Slovenščina** Izdelek je skladen z določbami evropskih direktiv 2004/108/EC, 2006/95/EC in 2002/95/EC.
- Svenska** Denna produkt har tillverkats i enlighet med EG-direktiv 2004/108/EC, 2006/95/EC & 2002/95/EC.
- Türkçe** Bu ürün, Avrupa Birliği'nin 2004/108/EC, 2006/95/EC ve 2002/95/EC yönergelerine uyar.

5.1.3 EMC Regulations

Intel NUC Board NUC7i5DNBE complies with the EMC regulations stated in Table 37 when correctly installed in a compatible host system.

Table 37. EMC Regulations

Regulation	Title
FCC 47 CFR Part 15, Subpart B	Title 47 of the Code of Federal Regulations, Part 15, Subpart B, Radio Frequency Devices. (USA)
ICES-003	Interference-Causing Equipment Standard, Digital Apparatus. (Canada)
EN55032	Limits and methods of measurement of Radio Interference Characteristics of Information Technology Equipment. (European Union)
EN55024	Information Technology Equipment – Immunity Characteristics Limits and methods of measurement. (European Union)
EN55022	Australian Communications Authority, Standard for Electromagnetic Compatibility. (Australia and New Zealand)
CISPR 32	Limits and methods of measurement of Radio Disturbance Characteristics of Information Technology Equipment. (International)
CISPR 24	Information Technology Equipment – Immunity Characteristics – Limits and Methods of Measurement. (International)
VCCI-CISPR 32	Voluntary Control for Interference by Information Technology Equipment. (Japan)
KN-35, KN-24	Korean Communications Commission – Framework Act on Telecommunications and Radio Waves Act (South Korea)
CNS 13438	Bureau of Standards, Metrology, and Inspection (Taiwan)

FCC Declaration of Conformity

This device complies with Part 15 of the FCC Rules. Operation is subject to the following two conditions: (1) this device may not cause harmful interference, and (2) this device must accept any interference received, including interference that may cause undesired operation.

For questions related to the EMC performance of this product, contact:

Intel Corporation, 5200 N.E. Elam Young Parkway, Hillsboro, OR 97124
1-800-628-8686

This equipment has been tested and found to comply with the limits for a Class B digital device, pursuant to Part 15 of the FCC Rules. These limits are designed to provide reasonable protection against harmful interference in a residential installation. This equipment generates, uses, and can radiate radio frequency energy and, if not installed and used in accordance with the instructions, may cause harmful interference to radio communications. However, there is no guarantee that interference will not occur in a particular installation. If this equipment does cause harmful interference to radio or television reception, which can be determined by turning the equipment off and on, the user is encouraged to try to correct the interference by one or more of the following measures:

- Reorient or relocate the receiving antenna.
- Increase the separation between the equipment and the receiver.
- Connect the equipment to an outlet on a circuit other than the one to which the receiver is connected.
- Consult the dealer or an experienced radio/TV technician for help.

Any changes or modifications to the equipment not expressly approved by Intel Corporation could void the user's authority to operate the equipment.

Tested to comply with FCC standards for home or office use.

Canadian Department of Communications Compliance Statement

This digital apparatus does not exceed the Class B limits for radio noise emissions from digital apparatus set out in the Radio Interference Regulations of the Canadian Department of Communications.

Le présent appareil numérique n'émet pas de bruits radioélectriques dépassant les limites applicables aux appareils numériques de la classe B prescrites dans le Règlement sur le brouillage radioélectrique édicté par le ministère des Communications du Canada.

Japan VCCI Statement

Japan VCCI Statement translation: This is a Class B product based on the standard of the Voluntary Control Council for Interference from Information Technology Equipment (VCCI). If this is used near a radio or television receiver in a domestic environment, it may cause radio interference. Install and use the equipment according to the instruction manual.

この装置は、情報処理装置等電波障害自主規制協議会（VCCI）の基準に基づくクラスB情報技術装置です。この装置は、家庭環境で使用することを目的としていますが、この装置がラジオやテレビジョン受信機に近接して使用されると、受信障害を引き起こすことがあります。
取扱説明書に従って正しい取り扱いをして下さい。

Korea Class B Statement

Korea Class B Statement translation: This equipment is for home use, and has acquired electromagnetic conformity registration, so it can be used not only in residential areas, but also other areas.

이 기기는 가정용(B급) 전자파적합기기로서 주로 가정에서 사용하는 것을 목적으로 하며, 모든 지역에서 사용할 수 있습니다.

5.1.4 e-Standby and ErP Compliance

Intel NUC Board NUC7i5DNBE meets the following program requirements in an adequate system configuration, including appropriate selection of an efficient power supply:









- EPEAT*
- Korea e-Standby
- European Union Energy-related Products Directive 2013 (ErP) Lot 6

For information about	Refer to
Electronic Product Environmental Assessment Tool (EPEAT)	http://www.epeat.net/
Korea e-Standby Program	http://www.kemco.or.kr/new_eng/pg02/pg02_100300.asp
European Union Energy-related Products Directive 2009 (ErP)	http://ec.europa.eu/enterprise/policies/sustainable-business/sustainable-product-policy/ecodesign/index_en.htm

5.1.5 Regulatory Compliance Marks (Board Level)

Intel NUC Board NUC7i5DNBE has the regulatory compliance marks shown in Table 38.

Table 38. Regulatory Compliance Marks

Description	Mark
UL joint US/Canada Recognized Component mark. Includes adjacent UL file number for Intel NUC: E210882.	
FCC Declaration of Conformity logo mark for Class B equipment.	
CE mark. Declaring compliance to the European Union (EU) EMC directive, Low Voltage directive, and RoHS directive. For CE Mark-Related Questions: Intel Corporation Attn: Corporate Quality 2200 Mission College Blvd. Santa Clara, CA 95054-1549 USA	
Australian Communications Authority (ACA) and New Zealand Radio Spectrum Management (NZ RSM) C-tick mark. Includes adjacent Intel supplier code number, N-232.	
Japan VCCI (Voluntary Control Council for Interference) mark.	
Korea Certification mark. Includes an adjacent MSIP (Ministry of Science, ICT & Future Planning) certification number: MSIP-REM-CPU-NUC5i5MYBE	
Taiwan BSMI (Bureau of Standards, Metrology and Inspections) mark. Includes adjacent Intel company number, D33025.	 D33025 RoHS
Printed wiring board manufacturer's recognition mark. Consists of a unique UL recognized manufacturer's logo, along with a flammability rating (solder side). Dependent upon the rating material.	V-0 or V-1
China RoHS/Environmentally Friendly Use Period Logo: This is an example of the symbol used on Intel NUC and associated collateral. The color of the mark may vary depending upon the application. The Environmental Friendly Usage Period (EFUP) for Intel NUC has been determined to be 10 years.	

5.2 Battery Disposal Information



CAUTION

Risk of explosion if the battery is replaced with an incorrect type. Batteries should be recycled where possible. Disposal of used batteries must be in accordance with local environmental regulations.



PRÉCAUTION

Risque d'explosion si la pile usagée est remplacée par une pile de type incorrect. Les piles usagées doivent être recyclées dans la mesure du possible. La mise au rebut des piles usagées doit respecter les réglementations locales en vigueur en matière de protection de l'environnement.



FORHOLDSREGEL

Eksplodingsfare, hvis batteriet erstattes med et batteri af en forkert type. Batterier bør om muligt genbruges. Bortskaffelse af brugte batterier bør foregå i overensstemmelse med gældende miljølovgivning.



OBS!

Det kan oppstå eksplosjonsfare hvis batteriet skiftes ut med feil type. Brukte batterier bør kastes i henhold til gjeldende miljølovgivning.



VIKTIGT!

Risk för explosion om batteriet ersätts med felaktig batterityp. Batterier ska kasseras enligt de lokala miljövårdsbestämmelserna.



VARO

Räjähdysvaara, jos pariston tyyppi on väärä. Paristot on kierrätettävä, jos se on mahdollista. Käytetyt paristot on hävitettävä paikallisten ympäristömääräysten mukaisesti.



VORSICHT

Bei falschem Einsetzen einer neuen Batterie besteht Explosionsgefahr. Die Batterie darf nur durch denselben oder einen entsprechenden, vom Hersteller empfohlenen Batterietyp ersetzt werden. Entsorgen Sie verbrauchte Batterien den Anweisungen des Herstellers entsprechend.



AVVERTIMENTO

Esiste il pericolo di un esplosione se la pila non viene sostituita in modo corretto. Utilizzare solo pile uguali o di tipo equivalente a quelle consigliate dal produttore. Per disfarsi delle pile usate, seguire le istruzioni del produttore.

**PRECAUCIÓN**

Existe peligro de explosión si la pila no se cambia de forma adecuada. Utilice solamente pilas iguales o del mismo tipo que las recomendadas por el fabricante del equipo. Para deshacerse de las pilas usadas, siga igualmente las instrucciones del fabricante.

**WAARSCHUWING**

Er bestaat ontploffingsgevaar als de batterij wordt vervangen door een onjuist type batterij. Batterijen moeten zoveel mogelijk worden gerecycled. Houd u bij het weggoeien van gebruikte batterijen aan de plaatselijke milieuwetgeving.

**ATENÇÃO**

Haverá risco de explosão se a bateria for substituída por um tipo de bateria incorreto. As baterias devem ser recicladas nos locais apropriados. A eliminação de baterias usadas deve ser feita de acordo com as regulamentações ambientais da região.

**AŠCIAROŽZNAŚĆ**

Існуе рызыка выбуху, калі заменены акумулятар неправільнага тыпу. Акумулятары павінны, па магчымасці, перепрацоўвацца. Пазбаўляцца ад старых акумулятараў патрэбна згодна з мясцовым заканадаўствам па экалогіі.

**UPOZORNĚNÍ**

V případě výměny baterie za nesprávný druh může dojít k výbuchu. Je-li to možné, baterie by měly být recyklovány. Baterie je třeba zlikvidovat v souladu s místními předpisy o životním prostředí.

**Προσοχή**

Υπάρχει κίνδυνος για έκρηξη σε περίπτωση που η μπαταρία αντικατασταθεί από μία λανθασμένου τύπου. Οι μπαταρίες θα πρέπει να ανακυκλώνονται όταν κάτι τέτοιο είναι δυνατό. Η απόρριψη των χρησιμοποιημένων μπαταριών πρέπει να γίνεται σύμφωνα με τους κατά τόπο περιβαλλοντικούς κανονισμούς.

**VIGYÁZAT**

Ha a telepet nem a megfelelő típusú telepre cseréli, az felrobbanhat. A telepeket lehetőség szerint újra kell hasznosítani. A használt telepeket a helyi környezetvédelmi előírásoknak megfelelően kell kiselejtezni.

**注意**

異なる種類の電池を使用すると、爆発の危険があります。リサイクルが可能な地域であれば、電池をリサイクルしてください。使用後の電池を破棄する際には、地域の環境規制に従ってください。



AWAS

Risiko letupan wujud jika bateri digantikan dengan jenis yang tidak betul. Bateri sepatutnya dikitar semula jika boleh. Pelupusan bateri terpakai mestilah mematuhi peraturan alam sekitar tempatan.



OSTRZEŻENIE

Istnieje niebezpieczeństwo wybuchu w przypadku zastosowania niewłaściwego typu baterii. Zużyte baterie należy w miarę możliwości utylizować zgodnie z odpowiednimi przepisami ochrony środowiska.



PRECAUȚIE

Risc de explozie, dacă bateria este înlocuită cu un tip de baterie necorespunzător. Bateriile trebuie reciclate, dacă este posibil. Depozitarea bateriilor uzate trebuie să respecte reglementările locale privind protecția mediului.



ВНИМАНИЕ

При использовании батареи несоответствующего типа существует риск ее взрыва. Батареи должны быть утилизированы по возможности. Утилизация батарей должна проводиться по правилам, соответствующим местным требованиям.



UPOZORNENIE

Ák batériu vymeníte za nesprávny typ, hrozí nebezpečenstvo jej výbuchu. Batérie by sa mali podľa možnosti vždy recyklovať. Likvidácia použitých batérií sa musí vykonávať v súlade s miestnymi predpismi na ochranu životného prostredia.



POZOR

Zamenjava baterije z baterijo drugačnega tipa lahko povzroči eksplozijo. Če je mogoče, baterije reciklirajte. Rabljene baterije zavržite v skladu z lokalnimi okoljevarstvenimi predpisi.



คำเตือน

ระวังการระเบิดที่เกิดจากเปลี่ยนแบตเตอรี่ผิดประเภท หากเป็นไปได้ ควรนำแบตเตอรี่ไปรีไซเคิล การทิ้งแบตเตอรี่ใช้แล้วต้องเป็นไปตามกฎข้อบังคับด้านสิ่งแวดล้อมของท้องถิ่น.



UYARI

Yanlış türde pil takıldığında patlama riski vardır. Piller mümkün olduğunda geri dönüştürülmelidir. Kullanılmış piller, yerel çevre yasalarına uygun olarak atılmalıdır.



ОСТОРОГА

Використовуйте батареї правильного типу, інакше існуватиме ризик вибуху. Якщо можливо, використані батареї слід утилізувати. Утилізація використаних батареї має бути виконана згідно місцевих норм, що регулюють охорону довкілля.

**UPOZORNĚNÍ**

V případě výměny baterie za nesprávný druh může dojít k výbuchu. Je-li to možné, baterie by měly být recyklovány. Baterie je třeba zlikvidovat v souladu s místními předpisy o životním prostředí.

**ETTEVAATUST**

Kui patarei asendatakse uue ebasobivat tüüpi patareiga, võib tekkida plahvatusoht. Tühjad patareid tuleb võimaluse korral viia vastavasse kogumispunkti. Tühjade patareide äraviskamisel tuleb järgida kohalikke keskkonnakaitse alaseid reegleid.

**FIGYELMEZTETÉS**

Ha az elemet nem a megfelelő típusúra cseréli, felrobbanhat. Az elemeket lehetőség szerint újra kell hasznosítani. A használt elemeket a helyi környezetvédelmi előírásoknak megfelelően kell kiselejtezni.

**UZMANĪBU**

Pastāv eksplozijas risks, ja baterijas tiek nomainītas ar nepareiza veida baterijām. Ja iespējams, baterijas vajadzētu nodot attiecīgos pieņemšanas punktus. Bateriju izmešanai atkritumos jānotiek saskaņā ar vietējiem vides aizsardzības noteikumiem.

**DĒMESIO**

Naudojant netinkamo tipo baterijas įrenginys gali sprogti. Kai tik įmanoma, baterijas reikia naudoti pakartotinai. Panaudotas baterijas išmesti būtina pagal vietinius aplinkos apsaugos nuostatus.

**ATTENZJONI**

Riskju ta' splużjoni jekk il-batterija tinbidel b'tip ta' batterija mhux korrett. Il-batteriji għandhom jiġu riċiklati fejn hu possibbli. Ir-rimi ta' batteriji użati għandu jsir skond ir-regolamenti ambjentali lokali.

**OSTRZEŻENIE**

Ryzyko wybuchu w przypadku wymiany na baterie niewłaściwego typu. W miarę możliwości baterie należy poddać recyklingowi. Zużytych baterii należy pozbywać się zgodnie z lokalnie obowiązującymi przepisami w zakresie ochrony środowiska.