

5

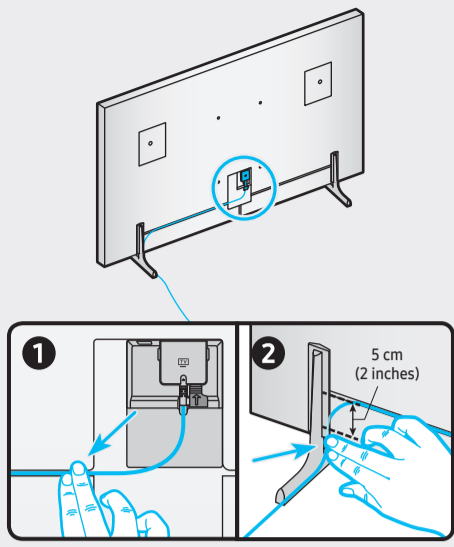

6

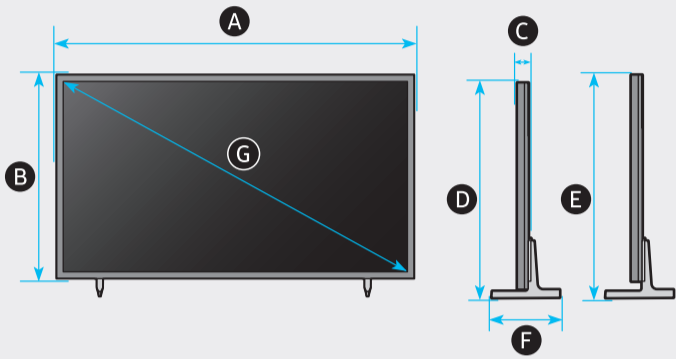
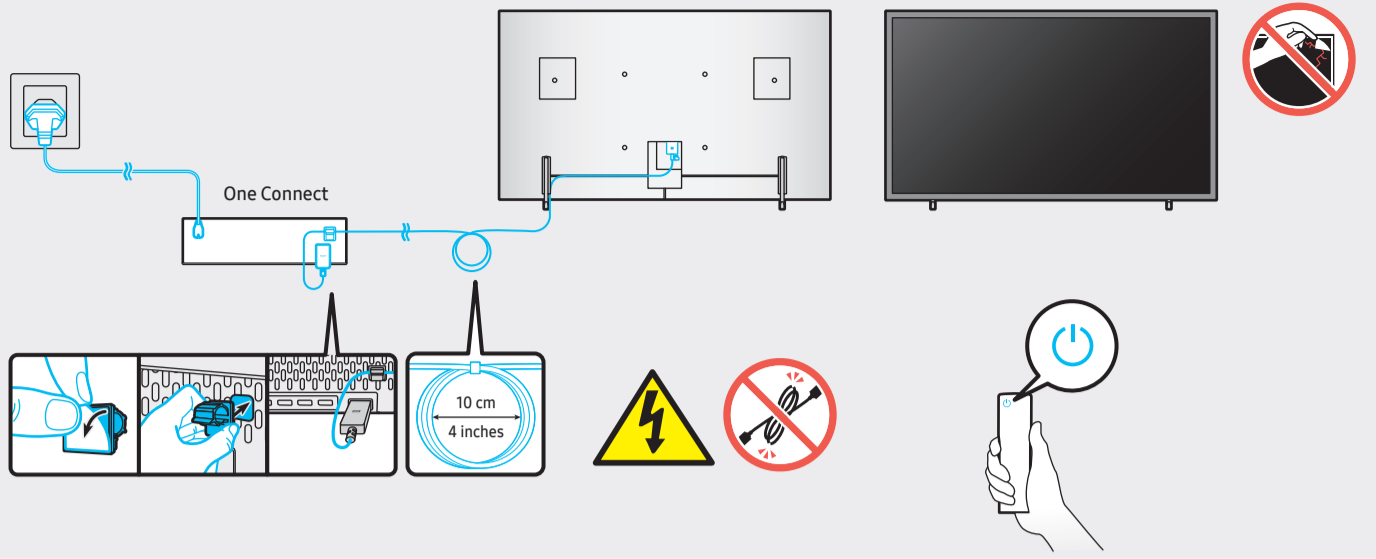

	A	B	C	D	E	F	G	H	I
QN43LS03B	38.2 inches (969.5 mm)	22.0 inches (557.8 mm)	1.0 inches (24.9 mm)	23.3 inches (591.9 mm)	24.3 inches (616.9 mm)	7.7 inches (196.8 mm)	42.5 inches	19.0 lbs (8.6 kg)	19.6 lbs (8.9 kg)
QN50LS03B	44.3 inches (1124.1 mm)	25.4 inches (644.9 mm)	1.0 inches (24.9 mm)	26.7 inches (679.2 mm)	27.7 inches (704.2 mm)	9.0 inches (227.8 mm)	49.5 inches	26.0 lbs (11.8 kg)	26.9 lbs (12.2 kg)

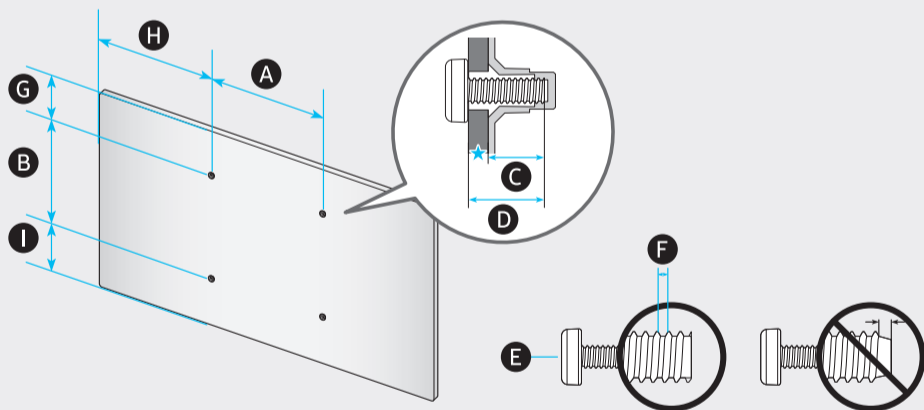
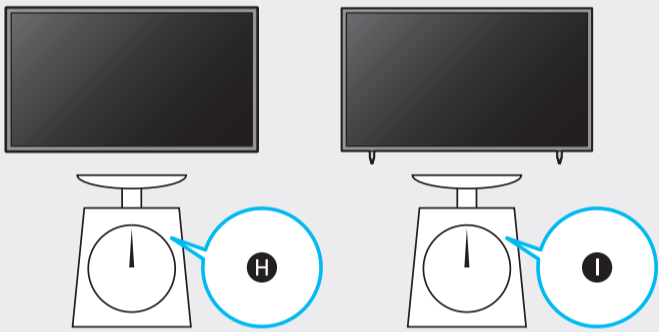

	VESA A x B (mm)	C (mm)	D	E x 4	F (mm)	G (inches)	H (inches)	I (inches)
QN43LS03B	200 x 200	9-11		M8	1.25	7.6	15.1	6.5
QN50LS03B		10-12	C + ★			8.3	18.2	9.2

★: Wall-Mount Bracket

SAMSUNG

Quick Setup Guide (Unpacking and Installation Guide)



◀ Scan this QR code with your smart phone to see helpful videos.

43"

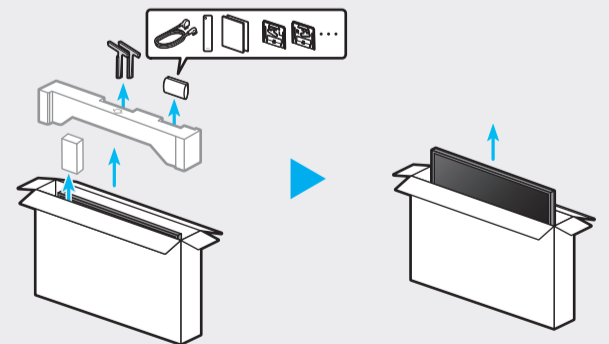

50"

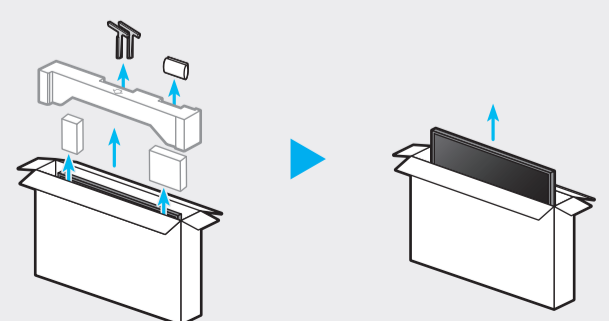

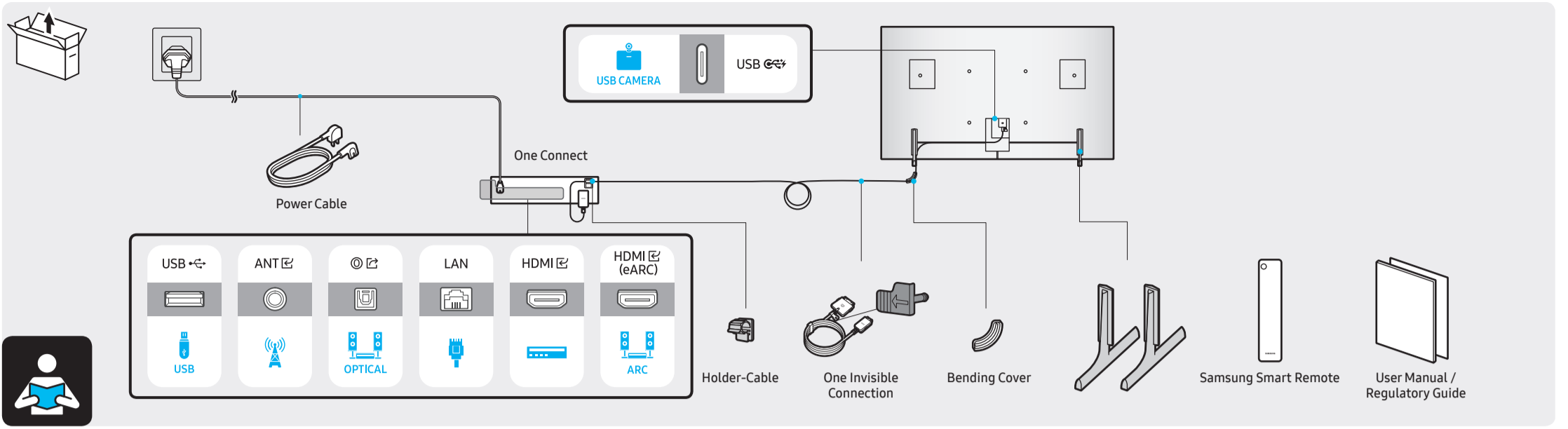

1

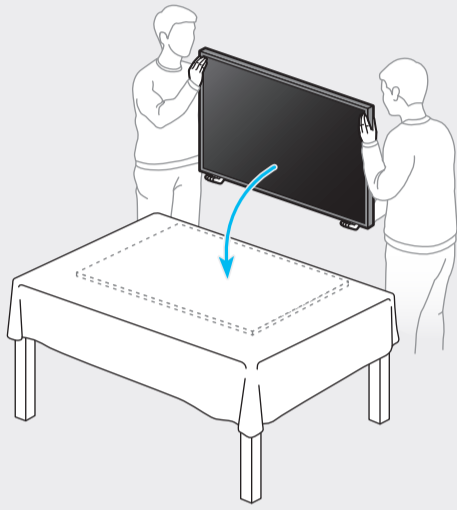

2

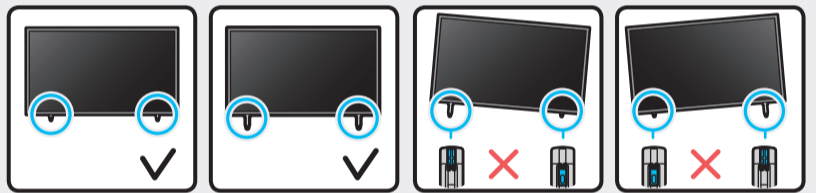
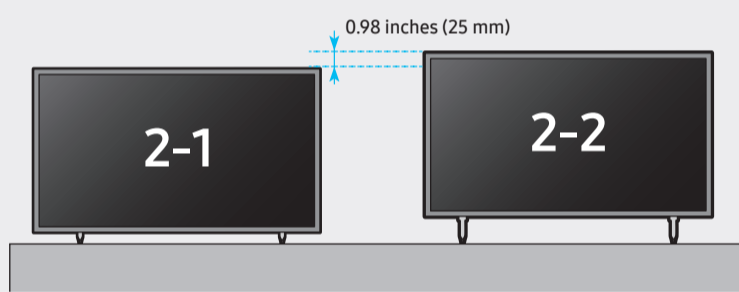
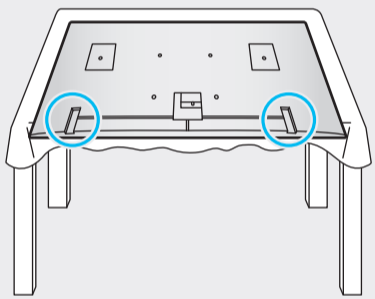

2-1

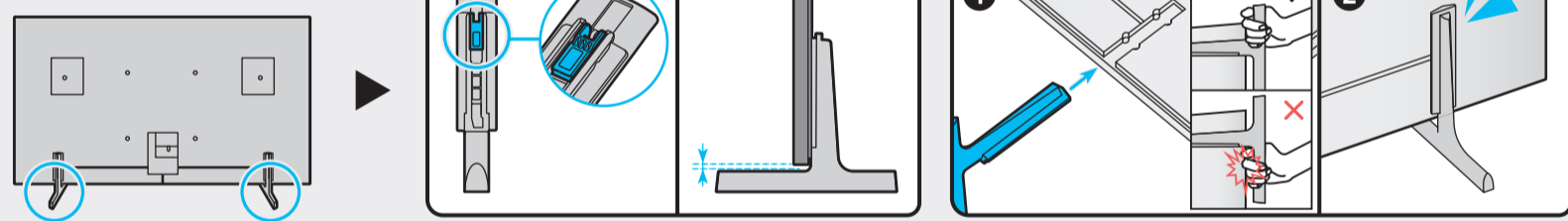

2-2

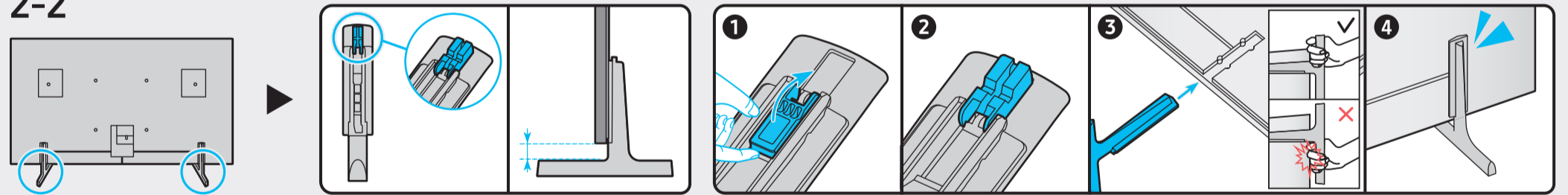

3

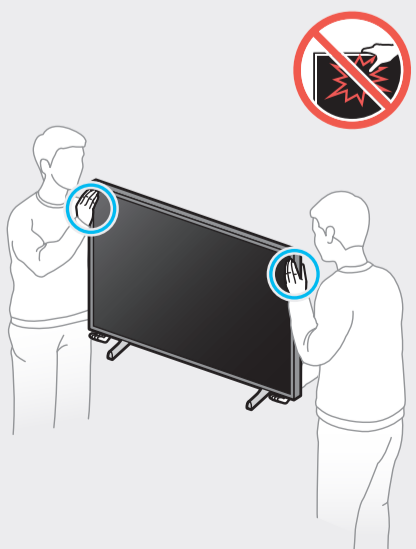

4

