

SAMSUNG Galaxy XR



User guide

Contents

Getting started

Device Layout: [Galaxy XR](#)

Set up your device: [Charge the battery pack](#) | [Wear the headset](#) | [Customize the fit](#) | [Power the device while wearing it](#)

Start using your device: [Connect the headset to your mobile device](#) | [Navigation](#) | [Home environment](#) | [Launcher](#) | [Galaxy AI](#) | [Iris recognition](#) | [Enter text](#)

Apps

Samsung apps: [Bixby](#) | [Clock](#) | [Calendar](#) | [Camera](#) | [Galaxy Avatar](#) | [Gallery](#) | [Internet](#) | [Messages](#) | [My Files](#) | [Notes](#) | [Phone](#) | [Samsung TV Plus](#) | [Tips](#)

Google Apps: [Chrome](#) | [Drive](#) | [Gemini](#) | [Gmail](#) | [Google](#) | [Google TV](#) | [Maps](#) | [Meet](#) | [Messages](#) | [Photos](#) | [Play Store](#) | [YouTube](#) | [YT Music](#)

Settings

[Access Settings](#) | [Connections](#) | [Display](#) | [Sound and Notifications](#) | [Management](#) | [Security](#) | [Accounts](#)

Learn More

[Videos](#) | [Samsung Care](#) | [Talk to an agent](#)

Legal information

[Restricting children's access to your mobile device](#) | [Class 1 Laser Information](#) | [Safety information](#)

Getting started

Galaxy XR

Bottom View

Set up your device

Start using your device



Galaxy XR

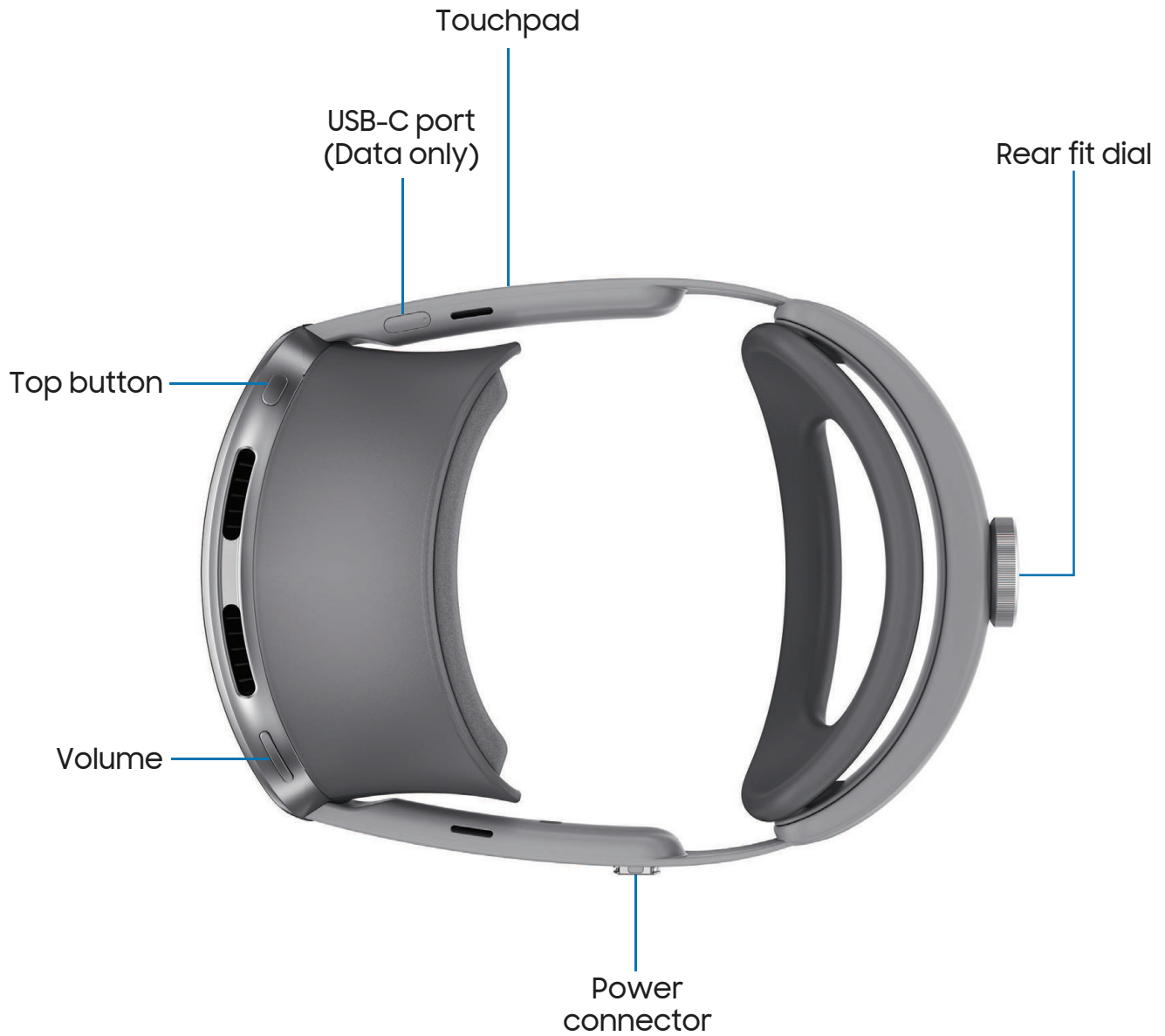

Bottom View

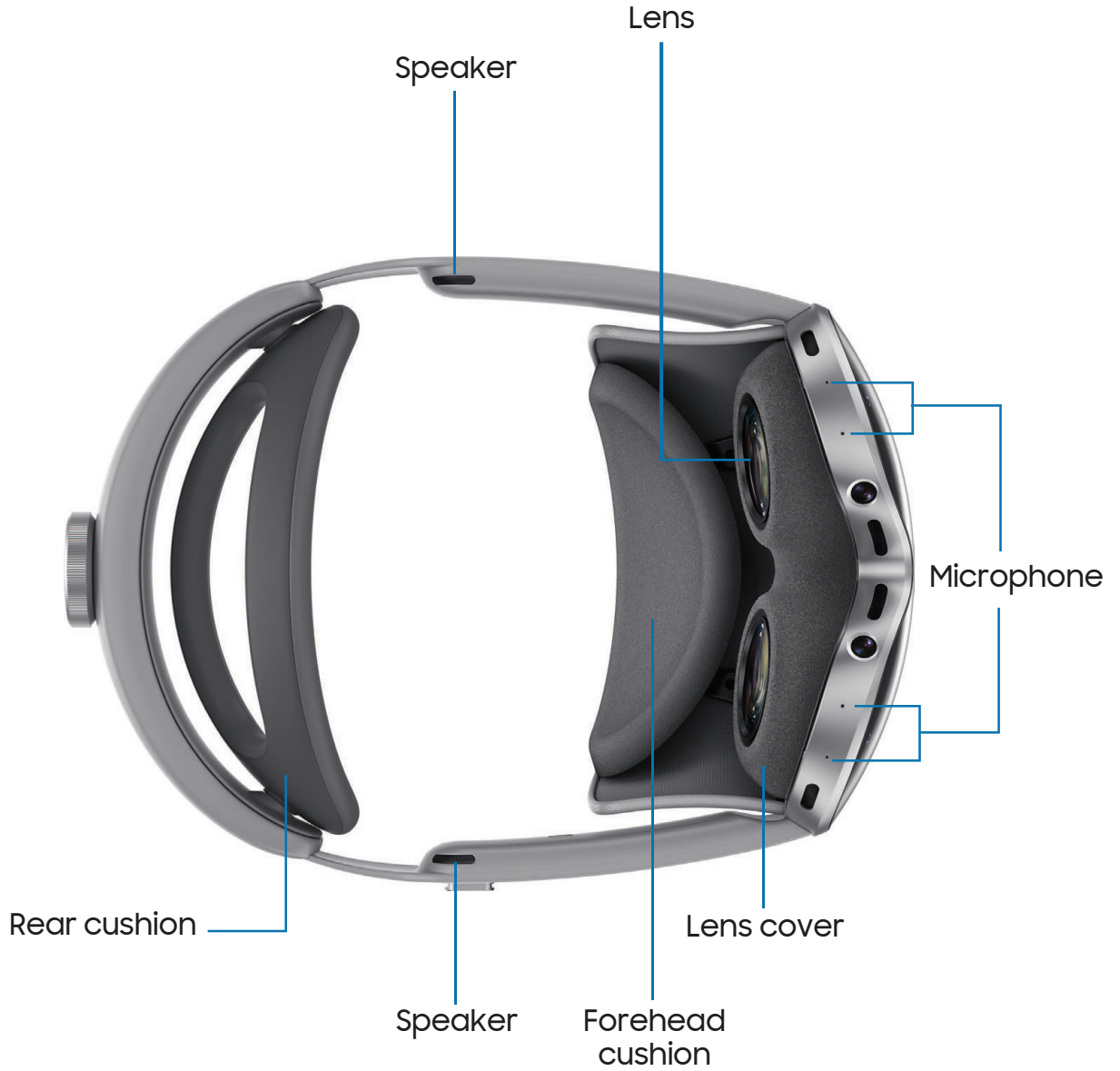

Set up your device

Learn more about your device hardware, assembling and charging, and how to get started using your new device.

[Charge the battery pack](#) | [Wear the headset](#) | [Customize the fit](#) | [Power the device while wearing it](#)

Charge the battery pack

Charge the battery pack before using the device.

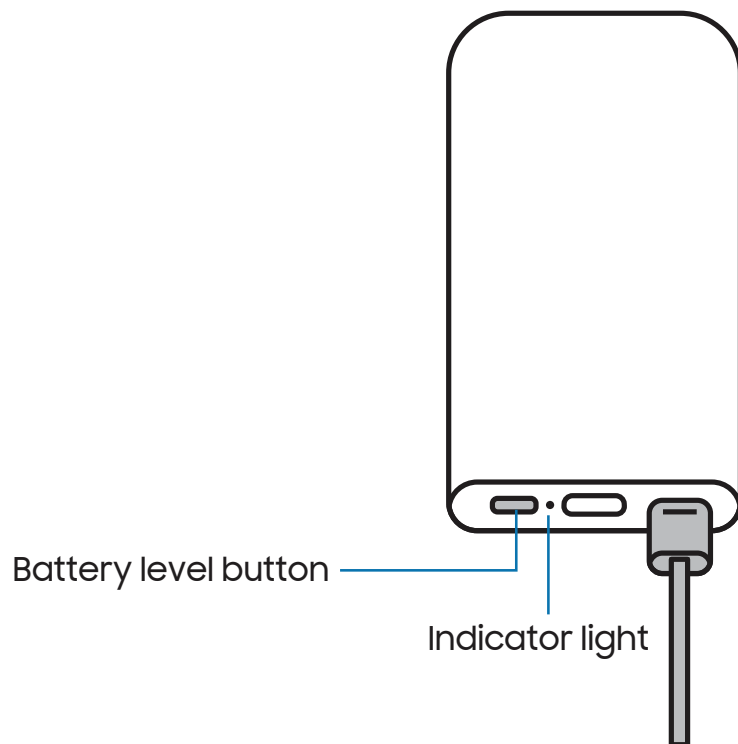

1. Connect one end of the USB-C cable to the USB-C port on the battery pack, and the other end to the wall charger
2. Connect the wall charger into a wall outlet.
 - The indicator light shows charging status.



CAUTION Power cable and USB Type-C accessory cable included. Use only compatible charging devices and accessories. Damage caused by use of accessories which are not compatible may not be covered by warranty.

Check the charge status

The indicator light on the battery pack shows the charging status.

Color	Status
Red	Charging
Green	Charging complete

Check the remaining battery

Use the Battery level button and indicator light to check the remaining battery power.

To check the battery level:

- Press the **Battery level** button to see the remaining power level.

Color	Remaining power
Green	60-100%
Yellow	30-60%
Red	Less than 30%
Flashing red	Less than 15%

While charging, the device and the charger may become hot. This does not affect the device's lifespan or performance and is in the device's normal range of operation. Remove the device from the charger and wait for the device to cool down.

Learn more: samsung.com/us/support/answer/ANS10002887/



NOTE Do not disassemble, modify, or repair your device. Placing objects, such as magnetic stripe cards, including credit cards, phone cards, passbooks, and boarding passes, next to the device or charger may cause damage from the charger or device's magnetic field.

Wear the headset

The device should rest on your forehead, held in place by the band around your head. It should not rest on your nose or cheekbones.

1. Remove the Protective cover and put on the device, adjusting its position on your forehead until the center of the screen is clear.



2. You can turn the rear fit dial to adjust the device to fit your head and hold the device firmly in place.

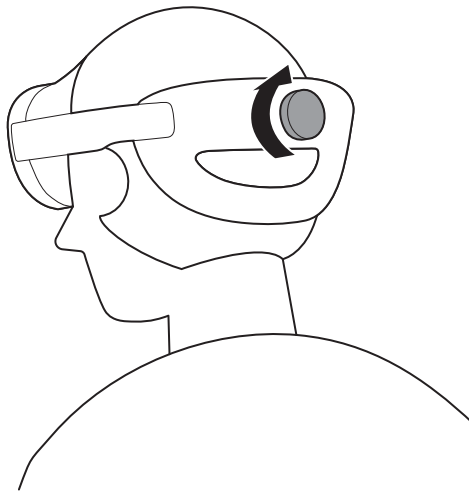

Customize the fit

Use the provided accessories for the best fit.

- Adjust the distance between the screen and your eyes using the Cushion size adjusters.
- Rotate the Rear fit dial to adjust how the device fits around your head.
- Block any unnecessary light coming from the outside by using the Light shields.

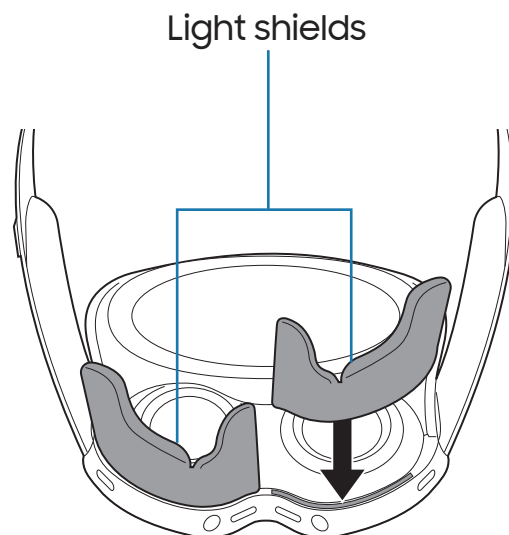
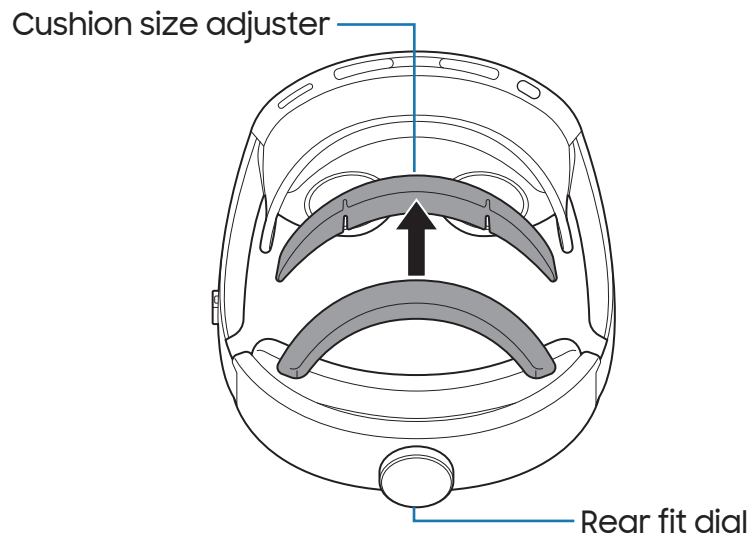

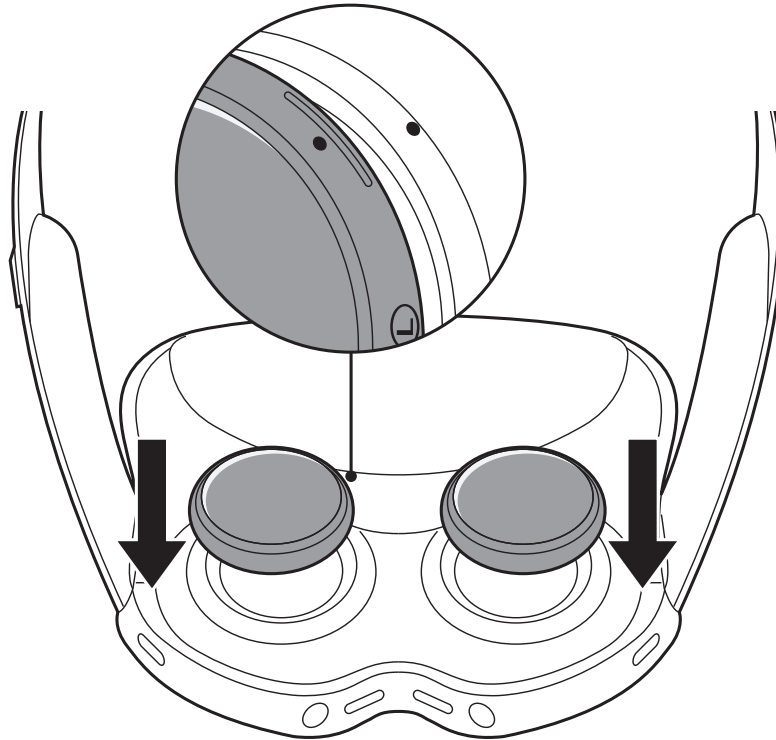

Prescription lenses

If you wear prescription glasses, you can order optional prescription lens inserts from a Samsung partner to use with your Galaxy XR. Lens inserts are sold and delivered separately.



1. Align the left and right lens inserts by matching the circular L and R engravings.
2. Press the lens inserts into the device.
 - The first time you wear the device with the lenses, follow the on-screen prompts for set-up instructions.

 **TIP** If you need to revisit how to set up the inserts, go to  **Settings** >  **Input** > **Eye calibration** > **Optical inserts** > **Register optical inserts**.

Power the device while wearing it

While wearing the device, connect to power.

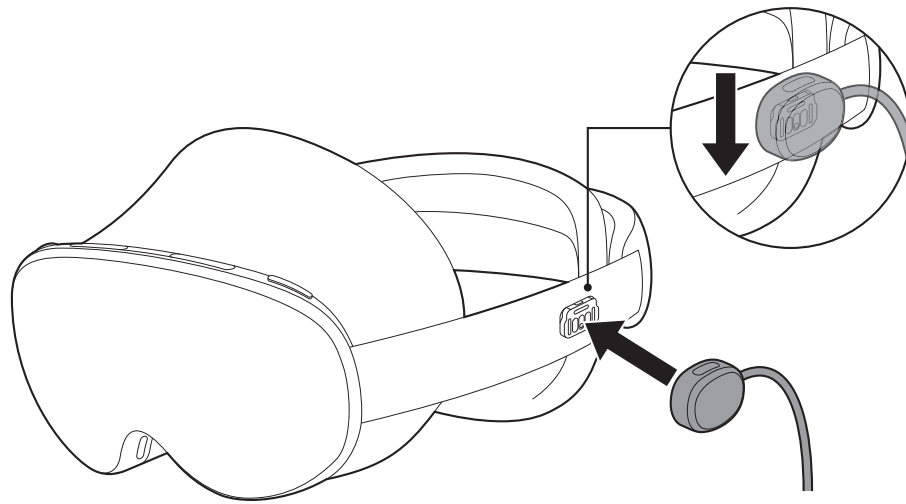

1. Slide the cable end of the power cable into the power connector on the device until it clicks.

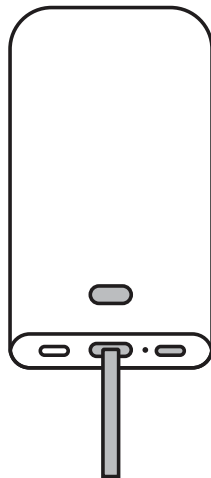

2. Insert the other end of the power cable into the center port on the battery pack.
3. Connect the battery pack to the wall charger with the USB-C cable, and then connect the wall charger to a wall outlet.

- When the battery pack is fully charged, disconnect the battery pack from the charger.



TIP While wearing the device, keep the battery pack close to you, such as in a pocket, and keep the connection to the wall charger and power outlet close by and free from obstructions while wearing the device.

Power off the device

To turn off your device:

- Press and hold the **Top** and **Volume down** buttons at the same time.



TIP You can also turn the device off from the Launcher. Tap  **Quick settings** >  **Power off**.

Disconnect the power cable

When not using the product, disconnect the power cable to disconnect the power.

To disconnect:

- Press the **USB release button**, and gently pull the power cable out of the battery pack.

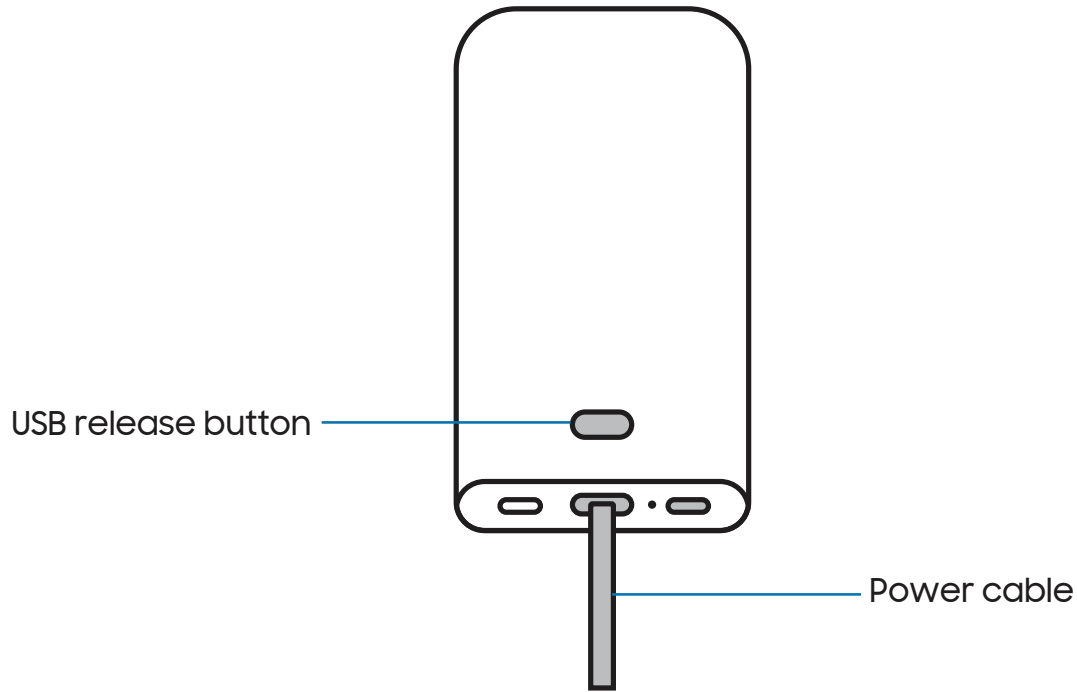

Start using your device

[Connect the headset to your mobile device](#) | [Navigation](#) | [Home environment](#) | [Launcher](#) | [Galaxy AI](#) | [Iris recognition](#) | [Enter text](#)

Connect the headset to your mobile device

To connect your device to a phone, you must install the Galaxy XR app on the phone you want to connect. The Galaxy XR app can be downloaded from the Galaxy Store.

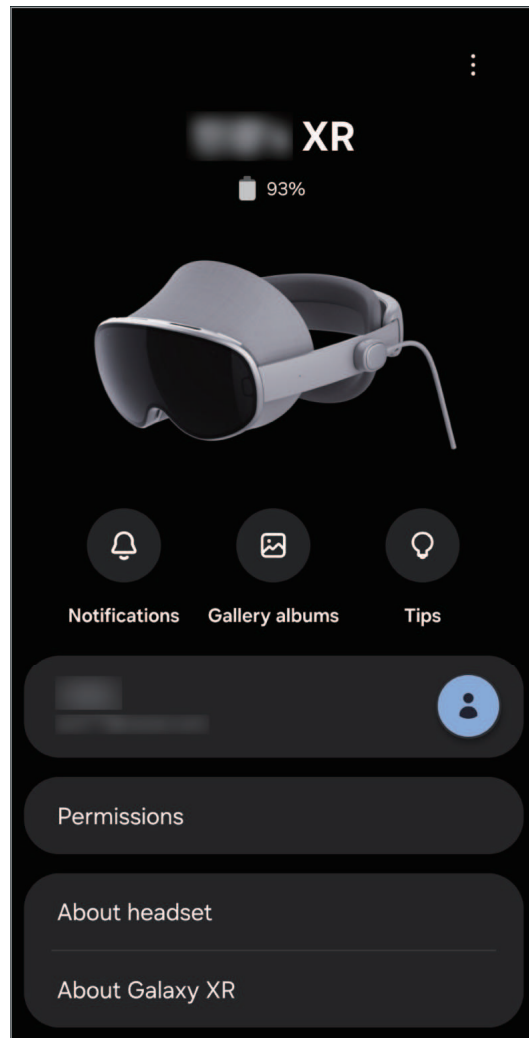

Device compatibility:

- This device can be connected to phones running Android 12.1 or higher. Some smartphone series and tablets may be incompatible with your device.
- To connect the device to a phone, you must have a phone that supports version 1.3.8 or higher of the Continuity Service app. To check the version of your Continuity Service app, open **Settings** and select **Applications > Continuity Service**.

Navigation

Learn how to navigate your device.

Tap

Touch your thumb and index finger together to tap objects on the screen. Hold your fingers pinched together for more than 2 seconds to select the object.



Drag

Pinch and hold an object to select it, then move your thumb and index finger up, down, left, or right to move the selection. You can also do this to scroll or swipe on the screen.





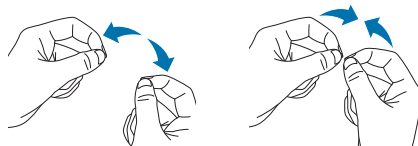

Zoom

Touch your thumb and index finger together on both hands and push or pull your hands towards or away from you to zoom in or out on the screen.





Navigation buttons

You can use icons to navigate.

1. Raise your palm toward your face, to display the  **Menu** icon.
2. Tap  **Menu** and select a navigation option:
 -  **Recent apps**: Open apps you have accessed recently.
 -  **Launcher**: Tap to open the Launcher, or press and hold to open Circle to search.
 -  **Back**: Go back one step.

Circle to search

Search for information about a desired part of the image or text on the screen.

1. Raise your palm toward your face and tap  **Menu**.
2. Tap and hold  **Launcher** until the Google icon appears.
3. Tap on an image or text, or draw a circle around the content you want to search for.

Home environment

Home environments are divided into mixed reality and virtual reality. In mixed reality, you can use content while viewing the real-world surroundings, while in virtual reality, you can use content in a space with a virtual background.

- From the Launcher, open  **Settings** >  **Home environment** to customize.



Mixed reality

In mixed reality, you can use content while viewing the real-world surroundings.

- The mixed reality environment may differ from the actual environment in terms of shape, color, size, etc., so caution is required when using it. In situations requiring accurate judgment, remove the product and check for yourself.
- Use the mixed reality feature only in an environment that ensures sufficient safety. Failure to do so may result in an accident.

Switch to Virtual Reality

In mixed reality, you can use content while viewing the real-world surroundings.

- Double-tap the **Touchpad** on the right side of the device to switch between mixed reality and virtual reality.

Tracking

Your device uses motion detection and eye-tracking to track your movements and implement them on screen.

Gesture tracking

Gesture tracking recognizes your finger movements, allowing you to point to and select items with hand gestures.



1. When you extend your hand to the screen, a pointer appears.
2. Move your hand to move the pointer to the desired location.

Eye tracking

Eye tracking recognizes your eye movements, allowing you to point to an item and select it with a hand gesture. For example, in the Gallery app, you can point to a photo by looking at it.

Input settings



You can configure motion detection methods and input tools.

- From the Launcher, open  **Settings** >  **Input** for the following options:
 - **Aiming method:** Set whether to use hand gestures and eye movements together or hand gestures alone when pointing at the screen.
 - **Eye calibration:** If the screen appears blurry or items are difficult to select, you can align the display to your field of vision and perform eye tracking calibration.
 - **Hand for gesture navigation:** Set which hand is recognized when using hand gestures to open the navigation menu.
 - **Fit tips:** Get help on proper positioning of the device while wearing it.
 - **Controllers:** You can register a controller for your product.
 - **Virtual keyboard:** Select the default keyboard type for your product and configure additional keyboard-related options.
 - **Physical keyboard:** Configure the external keyboard usage environment.
 - **Mouse:** Sets the usage environment for an external mouse.
 - **Trackpad:** Sets the usage environment for an external trackpad.

Boundary

Home environments are divided into mixed reality and virtual reality. In mixed reality, you can use content while viewing the real-world surroundings, while in virtual reality, you can use content in a space with a virtual background.





1. From the Launcher, open  **Settings** >  **Boundary**.
2. Tap **Small** or **Large** to set the boundary size.
 - To adjust the boundary, tap **Move boundary**.
 - To adjust the floor level, tap **Adjust floor level**.

Launcher



The launcher is where you can open apps, the notifications panel home environment, , and quick settings.



- From the Home screen, press the **Top button** to open the Launcher.
 - To access additional pages, swipe right or left.
 - To close the Launcher press the **Top button**.
 - To open the Notification panel, tap  **Notifications**
 - To open Quick settings, tap  **Quick settings**.

Galaxy AI

Use Galaxy AI features with compatible Galaxy apps on your device to unleash your productivity, enhance your communication, and create epic images.

- From the Launcher, open  **Settings** >  **Advanced features** > **Galaxy AI**, and sign in to your Samsung account. Tap an option to use advanced intelligence features:
 - **Note assist:** Automatically format, summarize, correct, and generate covers for your notes.
 - **Browsing assist:** Get simple summaries and translations of webpage text.
 - **Process data only on device:** For added privacy, process advanced intelligence data on your device instead of online. Some features are not available when this option is enabled.
 - **About advanced intelligence:** Learn how advanced intelligence works and uses your data.
 - **Terms and conditions:** Review the terms and conditions for advanced intelligence.

Iris recognition

Iris recognition enhances device security by leveraging the unique characteristics of your iris, including its shape and pattern. Iris data can be used for various authentication methods.

Register irises

Follow the prompts to register your irises.

1. From the Launcher, open  **Settings** >  **Security and privacy**.
2. Tap **Iris**, and follow the prompts to complete registration.

Enter text

When you need to enter text, a virtual keyboard appears.

- Tap a key on the keyboard with your index finger to enter text.
 - You can also point to a button and pinch the keys to enter text.

Voice input

Instead of typing your text, you can speak it.

- Tap  **Voice input** and speak the message you want to enter.

Apps

Navigate apps

Apps settings

Samsung apps

Google Apps





Navigate apps

The Launcher displays all preloaded and downloaded apps. Apps can be downloaded from the Google Play store.

- From the Launcher, you can access the apps installed on your device.
 - To scroll through the list of apps, pinch and hold then swipe left and right.
 - To review a list of recently opened apps, tap **Recent apps**.

Apps settings

Manage your downloaded and preloaded apps.

1. From the Launcher, open  **Settings** >  **Apps**.
2. Tap an option to customize:
 - **Choose default apps:** Choose which apps to use for making calls, sending messages, going to websites, and more.
 - **Samsung app updates:** Tap a Samsung app in the list and search for updates.
 - **Your apps:** Tap an app to review information about its privacy and usage settings. Options vary by app.



TIP To reset app options that have been changed, tap  **More options** > **Reset app preferences**.

Samsung apps

The following apps come pre-installed or downloaded over-the-air to your device.

[Bixby](#) | [Clock](#) | [Calendar](#) | [Camera](#) | [Galaxy Avatar](#) | [Gallery](#) | [Internet](#) | [Messages](#) | [My Files](#) | [Notes](#) | [Phone](#) | [Samsung TV Plus](#) | [Tips](#)

Bixby

Bixby displays customized content based on your interactions. Bixby learns from your usage patterns and suggests content you may like.

- From the Launcher, open  Bixby.

Clock

The Clock app offers features for keeping track of time and setting alarms.

- From the Launcher, open  Clock.

Calendar

The Calendar app can be connected to your various online accounts to consolidate all your calendars in one place.

- From the Launcher, open  Calendar.

Camera

You can take photos and videos of the scene you are seeing through the headset.

- From the Launcher, open  Camera.

 **TIP** You can use a shortcut to open the Camera app when you do not want to navigate through the apps list. Double press the Top button.



Galaxy Avatar

Create your own avatar using your Galaxy. You can create a card for your profile, create stickers, and videos with your avatar.

- From the Launcher, open  **Galaxy Avatar** and follow the prompts to get started.





Gallery

You can open photos and videos stored on your device.

1. From the Launcher, open  **Gallery**.
2. Scroll through the thumbnails, then tap an image or video to open it.

Share pictures and videos

Share pictures and videos from the Gallery app.

1. From the Launcher, open  **Gallery**.
2. Tap  **More options** > **Select** and select the pictures or videos you want to share.
3. Tap  **Share**, and then choose an app or connection to use for sharing your selection. Follow the prompts.

Take a screenshot

Capture an image of your screen. Your device automatically creates a Screenshots album in the Gallery app.

- From any screen, press and release the **Top button** and **Volume down button**.

Screen recorder

Record activities on your device, write notes, and use the camera to record a video overlay of yourself to share with friends or family.

1. From Quick Settings, tap  **Screen recorder**.
2. Choose a sound setting, and tap **Start recording**.

Internet

You can access websites to search for the information you want, or bookmark frequently visited web pages.

- From the Launcher, open  **Internet**.

 **TIP** Visit samsung.com/us/apps/samsung-internet/ for more information about the Internet app.

Browsing assist

Summarize and translate webpages using Browsing assist.

- From a webpage, tap  **Browsing assist** for the following features:
 - **Summarize:** Use Advanced intelligence to create simple summaries of webpage text.
 - **Translate:** Convert webpages into your preferred language.

Messages

Keep in touch with your contacts by using the Messages app to share photos, send emojis, or say a quick hello.

- From Apps, tap  **Messages** >  **Compose**.

 **NOTE** This feature is only available when **Call on other devices** is enabled under **Settings > Connected devices**.



My Files

Open and manage files stored on your device, including images, videos, music, and sound clips.

- From the Launcher, tap  **My Files**.

Notes

Use Samsung Notes to create notes containing text, images with footnotes, voice recordings, and music. You can share your notes using social networking services. Learn more: samsung.com/us/support/owners/app/samsung-notes

1. From the Launcher, open  **Samsung Notes**.
2. Tap  **Compose** to start a new note.

Note assist

Use Advanced intelligence to assist you in writing notes.

- From a note, tap  **Note assist** for the following options:
 - **Auto format:** Automatically change the format of your content based on predefined rules or styles.
 - **Summarize:** Use Advanced intelligence to create simple summaries of web page text.
 - **Spelling and grammar:** Get suggested grammar and spelling corrections.
 - **Translate:** Use Advanced intelligence to convert text to your preferred language.

Phone

Make calls and receive them while using your headset.

To make a call:

1. From the Launcher, open  **Phone**.
2. Enter a phone number on the keypad, and tap  **Dial** or  **Meet**.

Respond to an incoming call

- Tap  **Answer** or  **Reject** on the incoming call screen.

 **NOTE** This feature is only available when **Call on other devices** is enabled under **Settings > Connected devices**.

Samsung TV Plus

You can enjoy a variety of video content for free by selecting channels like you would on a TV.

- From the Launcher, open  Samsung TV Plus.

Tips

Learn tips and techniques and access the user guide for your device.

- From the Launcher, open  Tips.

Google Apps

Enjoy these apps from Google. Certain apps require a Google Account.

Learn more: google.com

[Chrome](#) | [Drive](#) | [Gemini](#) | [Gmail](#) | [Google](#) | [Google TV](#) | [Maps](#) | [Meet](#) | [Messages](#) | [Photos](#) | [Play Store](#) | [YouTube](#) | [YT Music](#)



Chrome

Browse the Internet with Chrome™ and bring your open tabs, bookmarks, and address bar data from your computer to your mobile device.

Learn more: google.com/chrome



Drive

Open, review, rename, and share files saved to your Google Drive™ cloud account.

Learn more: google.com/drive



Gemini

Get direct access to Google's family of AI models on your device so you can get help with writing, brainstorming, and learning. Use Gemini to summarize and find quick info from Gmail or Google Drive, generate images and more.

Learn more: google.com/gemini



Gmail

Send and receive email with Google's web-based email service.

Learn more: support.google.com/mail

Google

Find online content with tools that learn what interests you. Turn on your personalized feed to receive customized content.

Learn more: google.com

Google TV

Watch movies and TV shows purchased from Google Play. You can also play videos saved on your device.

Learn more: google.com/googletv

Maps

Get directions and other location-based information. You must enable location services to use Google Maps™.

Learn more: google.com/maps

Meet

Make cross-platform video calls on phones and tablets, smart devices, and on the web.

Learn more: google.com/meet

Messages

Send and receive messages over Wi-Fi or data with Google's official app for texting and chat.

Learn more: google.com/messages

Photos

Store and back up your photos and videos automatically to your Google Account with Google Photos™.

Learn more: google.com/photos

Play Store

Find new apps, movies and TV shows, music, books, magazines, and games in the Google Play™ store.

Learn more: google.com/play

YouTube

Watch and upload YouTube™ videos right from your device.

Learn more: google.com/youtube

YT Music

Stream and browse playlists, albums, and artists from YouTube Music.

Learn more: google.com/youtubemusic

Settings

Access Settings

Connections

Display

Sound and Notifications

Management

Security

Accounts



Access Settings

Customize your device using the device settings.

- From the Launcher, tap  **Settings**.

Search for Settings

If you are not sure exactly where to find a certain setting, you can search for it.

1. From Settings, tap  **Search**, and enter keywords.
2. Tap an entry to go to that setting.

Add a Samsung account

Sign in to your Samsung account to access exclusive Samsung content and make full use of Samsung apps.

- From the Launcher, open  **Settings** >  **Accounts** > **Add account** > **Samsung account**.

Connections

Manage connections between your device and a variety of networks and other devices.

[Wi-Fi](#) | [Bluetooth](#) | [Airplane mode](#) | [Connect to a printer](#) | [Virtual Private Networks](#) | [Private DNS](#) | [Connected devices](#)



Wi-Fi

Activate the Wi-Fi feature to connect to a Wi-Fi network.

- From the Launcher, open  **Settings** >  **Connections** > **Wi-Fi**.

Connect to a Wi-Fi network

This feature is available when the device is not connected to another device through Bluetooth.

1. From the Launcher, open  **Settings** >  **Connections** > **Wi-Fi**.
2. Tap a network from the **Available networks** list.
 - Networks that require a password display a lock icon.
 - To manually add a hidden network, tap **Add network** at the bottom of the list.
3. Enter the password if required, and tap **Connect**.



NOTE Once the device connects to a Wi-Fi network, the headset reconnects to that network each time it is available without requiring a password. To prevent the headset from connecting to the network automatically, select the network, and then tap **Forget**.



Wi-Fi Direct

Wi-Fi Direct uses Wi-Fi to share data between devices.

1. From the Launcher, open  **Settings** >  **Connections** > **Wi-Fi**.
2. Tap  **More options** > **Wi-Fi Direct**.
3. Tap a device, and then follow the prompts to connect.

Bluetooth

Use Bluetooth to connect the headset to a smartphone or an optional headset for playing music (headset not included).

1. From the Launcher, open  **Settings** >  **Connections** > **Bluetooth**.
2. Tap the switch to turn on the feature.

Airplane mode

Airplane mode disconnects your device from all networks and turns off connectivity features, such as phone calls and Wi-Fi.

- From the Launcher, open  **Settings** >  **Connections** > **Airplane mode**.

Connect to a printer

Connect your device to a printer on the same Wi-Fi network to print documents and images from your device.



1. From the Launcher, open  **Settings** >  **Connections**.
2. Tap **More connection settings** > **Printing**.
3. Tap **Default print service**, and then tap  **More options** > **Add printer**.



NOTE Not all apps support printing.



Virtual Private Networks

A Virtual Private Network (VPN) allows you to connect to a private secured network from your device. You need the connection information from your VPN administrator.

1. From the Launcher, open  **Settings** >  **Connections**.
2. Tap **More connection settings** > **VPN**.
3. Tap  **More options** > **Add VPN profile**.
4. Enter the VPN network information provided by your network administrator, and tap **Save**.



Private DNS

You can configure your device to connect to a private DNS host.

1. From the Launcher, open  **Settings** >  **Connections**.
2. Tap **More connection settings** > **Private DNS**.
3. Tap one of the available options to configure a private DNS connection.
4. Tap **Save**.

Connected devices

Achieve mobile continuity between your device and other connected devices. Options may vary by service provider.

- From the Launcher, open  **Settings** >  **Connected devices** for the following features:
 - **Quick Share:** Allow anyone with a Samsung account to share files with your device.
 - **Call on other devices:** Make and answer calls and text messages from your Galaxy devices that are signed in to your Samsung account.
 - **Auto switch Buds:** Automatically switch your Galaxy Buds from another device to this device when you make a call, answer a call, or play media.
 - **Continue apps on other devices:** Pick up where you left off on your Galaxy devices that are signed in to your Samsung account.
 - **Smart View:** Show your device's screen or play videos on a nearby TV.
 - **PC Link:** Connect your device to a PC or TV for an enhanced multitasking experience.

Display

You can configure the screen brightness, timeout delay, font size, and many other display settings.

[Avatars](#) | [Dark mode](#) | [Screen brightness](#) | [Font size and style](#)



Avatars

Calibrate face tracking and select which avatar you want to use in apps.

1. From the Launcher, open  **Setting** >  **Avatars**.
2. Tap **Start calibration** to map your face.

Dark mode



Your device has a dark mode which adjusts the screen quality for low light situations.

1. From the Launcher, open  **Setting** >  **Display**.
2. Tap **Light/Dark** to switch modes.

Screen brightness



Adjust the screen brightness according to lighting conditions or personal preference.

1. From the Launcher, open  **Setting** >  **Display**.
2. Tap **Brightness**, and drag the sliders to set a custom brightness level.

 **TIP** You can also adjust screen brightness from the Launcher, open  **Quick settings** and drag the sliders to adjust brightness.

Font size and style

Customize the font style and size on your device.



1. From the Launcher, open  **Setting** >  **Display**.
2. Tap **Font size and style** to customize.

Sound and Notifications

Configure the sounds used to indicate notifications, screen touches, and other interactions.

[Sounds](#) | [Notifications](#)



Sounds

- From the Launcher, open  **Settings** >  **Sound** for the following options:
 - **Ringtone:** Customize your call ringtone by choosing from preset sounds or adding your own.
 - **Notification sound:** Choose a preset sound for all notification alerts.
 - **System sound:** Customize your device's sounds for actions like tapping the screen and charging the device

- **Volume:** Set the volume level for call ringtones, notifications, media, and system sounds.
- **Spatial audio:** Reflect spatial location and distance to enhance your immersion.
- **Scene acoustics:** Dynamically adjust audio to match your physical room or environment.

Notifications

You can prioritize and streamline app alerts by changing which apps send notifications and how notifications alert you.

- From the Launcher, open  **Settings** >  **Notifications** for the following options:
 - **App notifications:** Select the apps you want to receive notifications from.
 - **Phone notifications:** Check notifications from your connected phone on your device.
 - **Do Not Disturb:** Silence all sounds except for those you've set as exceptions.



Management

You can configure things like general settings, advanced features, battery and accessibility.

[General management](#) | [Advanced features](#) | [Battery](#) | [Accessibility](#)

General management



You can configure general settings for language, date, and time on your device.

- From the Launcher, open  **Settings** >  **General management** for the following options:
 - **Language:** Select the language to use on your device.
 - **Language packs:** Download a list of language packs for voice input, text-to-speech, and translation.
 - **Samsung keyboard settings:** Configure the Samsung Keyboard settings.

- **Keyboard list and default:** Select the keyboard type to use as the default for your device and configure additional keyboard-related options.
- **Date and time:** Set how the time and date are displayed.
- **Reset:** Resets the device settings or delete all data.
- **Contact us:** Contact Samsung with any questions or browse frequently asked questions.



Advanced features

You can activate useful features and customize your usage preferences.

- From the Launcher, open  **Settings** >  **Advanced features** for the following options:
 - **Galaxy AI:** You can use enhanced intelligence features to help you use your device.
 - **Bixby:** Displays customized content based on your interactions. Bixby learns from your usage patterns and suggests content you may like.
 - **Top button:** Select a feature to launch by pressing and holding the top button.
 - **Labs:** You can use new features on your device.

Battery



Review how battery power is used for your various device activities. You can extend or conserve battery life by adjusting your settings.

- From the Launcher, open  **Setting** >  **Battery** for the following options:
 - **Power saving:** Save battery life by limiting background network usage, syncing, and location checking. Choose from additional power saving options to save more power when this mode is enabled.
 - **Auto power off:** Set the device to automatically power off when it is not used for a certain period of time or when the charger is not connected to the battery pack.

Accessibility

There are accessibility settings for people who need help seeing, hearing, or otherwise operating their device. Accessibility services are special features that make using the device easier for everyone.

Learn more: samsung.com/us/sustainability/accessibility/overview/

- From the Launcher, open  **Settings** >  **Accessibility** for the following options:
 - **Vision enhancements:** Adjust features to assist with visual aspects of your device.
 - **TalkBack:** Receive spoken feedback when using your device, such as what you touch, select, or activate
 - **Hearing enhancements:** Adjust features to assist with audial aspects of the device.
 - **Interaction and dexterity:** Change settings to improve product accessibility with mobility impairments.
 - **Accessibility toolbar and shortcuts:** Configure settings to provide immediate access to your accessibility tools.
 - **Installed apps:** Review accessibility services installed on your device.



Security

Secure and protect your device by customizing the lock and location features.

[Locking](#) | [Security](#) | [Location](#)



Locking

You can secure your device and protect your data by setting a screen lock.

- From the Launcher, open  **Settings** >  **Locking**, and select a lock type. Follow the prompts to set your lock method.



Security and privacy

You can secure your device and protect your data by setting a screen lock.

- From the Launcher, open  **Settings** >  **Security and privacy**, and select an option to customize.
 - **Device unlock:** Change lock screen settings.
 - **Privacy:** Change privacy settings.
 - **Iris:** Set up iris recognition to unlock the screen
 - **More security and privacy:** Change additional security and privacy settings.

Location

Location services use a combination of GPS, mobile network and Wi-Fi to determine the location of your device.

1. From the Launcher, open  **Settings** >  **Location**.
2. Tap **Location**, and tap an option to customize:
 - **App permissions:** Open a list of apps that have permission to access your device's location and change their permission settings.
 - **Location services:** Allow the use of Wi-Fi or Bluetooth to improve the accuracy of location information, even when Wi-Fi or Bluetooth is turned off. You can also review a list of location services your device is using.
 - **Recent access:** Review information about apps that have recently requested your location information.



Accounts

Manage your different accounts.

[Add an Account](#) | [Google settings](#) | [Software update](#)

Add an Account

You can add and sync all your email, social networking, and picture and video sharing accounts.

1. From the Launcher, open  **Settings** >  **Accounts**.
2. Tap  **Add account**, and select one of the account types.
3. Follow the prompts to enter your credentials and set up the account.
 - Tap **Auto sync data** to enable automatic updates to your accounts.

Google settings

You can configure your device's Google settings. Available options depend on your Google Account.

- From the Launcher, open  **Settings** >  **Google**, and select an option to customize.



Software update

Check for and install available software updates for your device.

- From the Launcher, open  **Settings** >  **Software update**.

Headset Information

Display information about the device.

- From the Launcher, open  **Settings** >  **About headset** to review information about your device:
 - **Status information:** Access device information about the headset.
 - **Legal information:** Access legal information related to the headset.
 - **Regulatory information:** Check model and manufacturer information.

- **Software information:** Check your headset's software version and security status.
- **Storage:** Check the available storage space.

Learn more

Videos

youtube.com/samsungcare

Samsung Care

samsung.com/us/support

Talk to an agent

Contact us on Facebook Messenger: m.me/samsungsupport

Find us on Facebook: facebook.com/samsungsupport

Follow us on X (formerly Twitter): x.com/samsungsupport

Legal information

READ THIS INFORMATION BEFORE USING YOUR MOBILE DEVICE.

Dispute Resolution Agreement - This Product is subject to a binding dispute resolution agreement between you and SAMSUNG ELECTRONICS AMERICA, INC. ("Samsung"). You can opt out of the agreement within 30 calendar days of the first consumer purchase by emailing optout@sea.samsung.com or calling 1-800-SAMSUNG (726-7864) and providing the applicable information.

The full Dispute Resolution Agreement, Standard One-year Limited Warranty, End User License Agreement (EULA), and Health & Safety Information for your device are available online:

Phone:

- English: samsung.com/us/support/legal/mobile
- Spanish: samsung.com/us/support/legal/mobile-sp

This information can also be found on the device in the "About device" or "About phone" or "About tablet" or "About headset" section, for example:

- **Settings > About phone or About device or About tablet > Legal information > Samsung legal**
- Or, search "Legal"

If your device required Federal Communications Commission (FCC) approval, you can access the FCC certification by opening **Settings > About phone or About device or About tablet > Status information**.

Restricting children's access to your mobile device

Your device is not a toy. Do not allow children to play with it because they could hurt themselves and others, or damage the device, or make calls that increase your device bill. Keep the device and all its parts and accessories out of the reach of small children.

Class 1 Laser Information

This product is classified as a class 1 laser product per IEC 60825-1 Ed. 3.0:2014. This product complies with 21 CFR 1040.10 and 1040.11 except for conformance with IEC 60825-1 Ed. 3., as described in Laser Notice No. 56, dated May 8, 2019.

 **CAUTION** Use of controls or adjustments or performance of procedures other than those specified herein may result in hazardous radiation exposure. There is no user service possible on the embedded laser module. Contact Samsung for service.

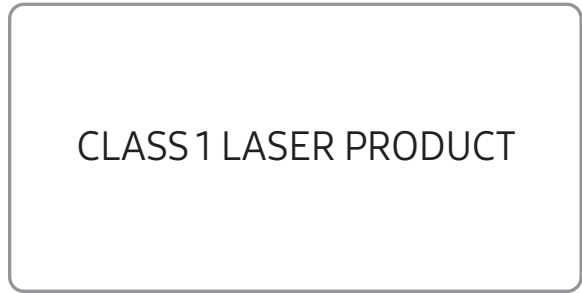

Safety information

Please read this important safety information before you use the device. It contains general safety information for devices and may include content that does not apply to your device. Follow the warning and caution information to prevent injury to yourself or others and to prevent damage to your device.



NOTE: The term device refers to the product, the items supplied with the product, and any Samsung-approved accessories used with the product.

This device is designed for users aged 13 and above. Children who are under the age of 13 cannot use the device, and minors who are aged 13 and above should use it under adult supervision.

This device is not medical equipment. If you need a medical diagnosis or treatment, consult a licensed medical professional.



Warning

Failure to comply with safety warnings and regulations can cause serious injury or death.

Your device contains magnets. Keep it away from credit cards, implanted medical devices, and other devices that may be affected by magnets. In the case of medical devices, keep your device more than 6 inches apart. Stop using your device if you suspect any interference with your medical device and consult your physician or your medical device manufacturer.

Do not use damaged power cords or plugs, or loose electrical sockets

Unsecured connections can cause electric shock or fire.

Do not touch the device, power cords, plugs, or the electric socket with wet hands or other wet body parts

Doing so may cause electric shock.

Do not pull the power cord excessively when disconnecting it

Doing so may cause electric shock or fire.

Do not bend or damage the power cord

Doing so may cause electric shock or fire.

Do not directly connect together the charger's positive and negative terminals

Doing so may cause fire or serious injury.

Do not use your device outdoors during a thunderstorm

Doing so may result in electric shock or device malfunction.

Use only compatible chargers, batteries and cords, specifically designed for your device.

Do not carry your device's battery pack in your back pockets or on your waist

- The device may be damaged, explode, or result in a fire if too much pressure is applied to it.
- You may be injured if you are bumped or fall.

Do not drop or cause excessive impact to the device

- This may damage your device or battery, cause the device to malfunction, or shorten its lifespan.
- This may also cause overheating, combustion, fire, or other hazards.

Handle and dispose of the device and charger with care

- For more information, visit samsung.com/us/aboutsamsung/sustainability/environment/responsible-recycling/programs/
- Never dispose of the battery or device in a fire. Never place the battery or device on or in heating devices, such as microwave ovens, stoves, or radiators. The device may explode when overheated. Follow all local regulations when disposing of used battery or device.
- Never crush or puncture the device.

- Avoid exposing the device to high external pressure, which can lead to an internal short circuit and overheating.

Protect the device, battery and charger from damage

- Avoid exposing your device and battery to very cold or very hot temperatures.
- Extreme temperatures can damage the device and reduce the charging capacity and life of your device and battery.
- Use the device only in a well-ventilated area; failure to do so may affect performance or lead to injury or property damage
- Do not use a cable whose covering is peeled off or damaged, and do not use any charger or battery that is damaged or malfunctioning.

Do not store your device near or in heaters, microwaves, hot cooking equipment, or high pressure containers

- The battery may leak.
- Your device may overheat and cause a fire.

Do not use or store your device in areas with high concentrations of dust or airborne materials

Dust or foreign materials can cause your device to malfunction and may result in fire or electric shock.

Prevent the multipurpose jack and the small end of the charger from contact with conductive materials, such as liquids, dust, metal powders, and pencil leads. Do not touch the multipurpose jack with sharp tools or cause an impact to the multipurpose jack

Conductive materials may cause a short circuit or corrosion of the terminals, which may result in an explosion or fire.

Do not bite or suck the device or the battery

- Doing so may damage the device or result in an explosion or fire.
- Children or animals can choke on small parts.
- If minors who are aged 13 and above use the device, make sure that they use the device properly.

Do not insert the device or supplied accessories into the eyes, ears, or mouth

Doing so may cause suffocation or serious injuries.

Do not handle a damaged or leaking Lithium Ion (Li-Ion) battery

For safe disposal of your Li-Ion battery, contact your nearest authorized service center.

Read and follow all setup and operating instructions provided with the device

- Review the hardware and software recommendations for use of the device. Risk of malfunction may increase if the recommended hardware and software are not used.
- Using accessories, software, and other devices not compatible may result in injury to you or others, and may cause performance issues or damage to your system and related services.
- A comfortable extended reality experience requires an unimpaired sense of motion and balance. Do not use the device when you are tired, need sleep, are under the influence of alcohol or drugs, are hung-over, have digestive problems, are under emotional stress or anxiety, or when suffering from cold, flu, headaches, migraines, or earaches, as this can increase your susceptibility to adverse symptoms.
- Make sure to consult a physician before using the device if you are pregnant, elderly, have psychiatric disorders or experience discomfort because of differences in vision between your eyes, or suffer from a heart condition or other serious medical condition.
- If you need corrective lenses, attach the corrective lenses (sold separately) to the device. If you wear contact lenses while using the device, some features may not work properly.

If you are experiencing discomfort while using the device, keep the following in mind:

- Immediately discontinue use if anyone using the device experiences any of the following symptoms: seizures; loss of awareness; eye strain; eye or muscle twitching; involuntary movements; altered, blurred, or double vision or other visual abnormalities; dizziness; disorientation; impaired balance; impaired hand-eye coordination; excessive sweating; increased salivation; nausea; lightheadedness; discomfort or pain in the head or eyes; drowsiness; fatigue; or any symptoms similar to motion sickness.
- You may experience a swaying sensation or a loss of direction during or after using the device. These symptoms may persist for some time and even become more apparent hours after use. Excessive drowsiness and inability to multitask may also appear as symptoms. These symptoms should be temporary and should improve with adequate rest. However, if the symptoms persist or you experience discomfort, consult your doctor.
- Rest until you have fully recovered from any symptoms. While the symptoms persist, do not drive, operate machinery, or engage in other visually or physically demanding activities that have potentially serious consequences (in other words, activities in which experiencing any symptoms could lead to death, personal injury, or damage to property), or other activities that require unimpaired balance and hand-eye coordination (such as playing sports or riding a bicycle, etc.).
- Do not use the device until all symptoms have completely subsided for several hours. Make sure you have properly configured the device before resuming use.
- Be mindful of the type of content that you were using prior to the onset of any symptoms because you may be more prone to symptoms based upon the content being used.
- Consult a physician if you have serious and persistent symptoms.

Be aware that injuries to your muscles, joints, or skin may be caused by repetitive use of the device

If any part of your body becomes tired or sore while using the device, or if you feel symptoms such as tingling, numbness, burning, or stiffness, stop and get enough rest. Do not use the device until all symptoms have completely subsided. If you continue to experience any of the symptoms or discomfort during or after play, stop using the device and consult a physician.

Be careful handling the battery when using controllers

- Do not ingest any battery. If a battery is swallowed, it can cause severe internal burns and potential perforation of the esophagus in just 2 hours and can lead to death.
- If the battery compartment does not close, stop using the product.
- There is a risk of fire as batteries could cause a thermal event or leak if installed backwards, disassembled, overcharged, punctured, crushed, mixed with used or other types of batteries, or if they are directly exposed to fire or high temperature. Do not recharge disposable batteries. Replace all batteries in a single device at the same time.
- Keep the battery in the original package until ready to use. Properly dispose of used batteries promptly.
- Do not allow conductive materials to touch the battery terminals of the devices. Keep batteries dry and prevent water intrusion.
- Do not disassemble, pierce, or attempt to modify batteries.

To reduce the risk of electric shock, be aware of the following:

Do not modify or open any of the provided device and components.

Do not use the product if any cable is damaged or any wires are exposed.

Do not share the device with people who have infectious diseases or illnesses or the symptoms of such diseases or illnesses on their eyes, skin, or scalp.

There is a risk of infection with infectious diseases or illnesses, such as conjunctivitis.

If the symptoms of skin irritation continue, stop using the device and consult a physician.

There may be swelling, itching, and other irritation to parts of your body that have come into contact with the device, such as the scalp, during use.

Caution

Failure to comply with safety cautions and regulations can cause serious injury or property damage

Do not use your device while operating an automobile or any other vehicle.

Only use your device in safe setting free of obstructions or potentially dangerous surfaces.

Do not use your device near other electronic devices.

- Most electronic devices use radio frequency signals. Your device may interfere with other electronic devices.
- Using a Wi-Fi or Bluetooth data connection may cause interference with other devices, such as audio equipment and telephones.

Do not use your device in a hospital, on an aircraft, or near automotive equipment that can be interfered with by radio frequency

- Avoid using your device within a 6 inch range of a pacemaker, if possible, as your device can interfere with the pacemaker.
- If you use medical equipment, contact the equipment manufacturer before using your device to determine whether or not the equipment will be affected by radio frequencies emitted by the device.
- On an aircraft, using electronic devices can interfere with the aircraft's electronic navigational instruments. Follow the regulations provided by the airline and the instructions of aircraft personnel.
- Electronic devices in your car may malfunction, because of radio interference from your device. Contact the manufacturer for more information.

Do not expose the device to heavy smoke or fumes

- Doing so may damage the outside of the device or cause it to malfunction.

Be careful when using the device if you are using a hearing aid.

Some hearing aids may malfunction or not work properly when using the device.

Do not use your device near devices or apparatuses that emit radio frequencies, such as sound systems or radio towers

Radio frequencies may cause your device to malfunction.

Turn off the device in potentially explosive environments if the device contains an internal battery.

- Turn off your device in potentially explosive environments instead of removing the battery. If the battery is removable, remove it to power off the device.
- Always comply with regulations, instructions and signs in potentially explosive environments.
- Do not use your device at refueling points (petrol stations), near fuels or chemicals, or in blasting areas.
- Do not store or carry flammable liquids, gases, or explosive materials in the same compartment as the device, its parts, or accessories.

If any part of the device is broken, smokes, or emits a burning odor, stop using the device immediately. Use the device again only after it has been repaired at a Samsung Service Center or an authorized service center

- Broken glass or acrylic could cause injury to your hands and face.
- When the device smokes or emits a burning odor, it may result in battery explosion or fire.

Care and use your device properly

Keep your device dry

- Humidity and liquids may damage the parts or electronic circuits in your device.
- Do not turn on your device if it is wet. If your device is already on, turn it off and remove the battery immediately (if the device will not turn off or you cannot remove the battery, leave it as-is). Then, dry the device with a towel and take it to a service center.
- This device has internal liquid indicators fitted. Damage caused by exposure to water or other liquids may not be covered by the manufacturer's limited product warranty.

Store your device only on flat surfaces

- If your device falls, it may be damaged.

The device can be used in locations with an ambient temperature of 0 °C to 30 °C. You can store the device at an ambient temperature of -20 °C to 45 °C. Using or storing the device outside of the recommended temperature ranges may damage the device or reduce the battery's lifespan

- Do not store your device in very hot areas such as inside a car in the summertime. Doing so may cause the screen to malfunction, result in damage to the device, or cause the battery to explode.
- Do not expose your device to direct sunlight for extended periods of time (on the dashboard of a car, for example).
- For a device with a removable battery, the battery can be stored separately in locations with an ambient temperature of 0 °C to 45 °C.

Do not store your device with metal objects, such as coins, keys, and necklaces

- Your device may be scratched or may malfunction.
- If the battery terminals come into contact with metal objects, this may cause a fire.

Do not store your device near magnetic fields

- Your device may malfunction or the battery may discharge from exposure to magnetic fields.
- Magnetic stripe cards, including credit cards, phone cards, passbooks, and boarding passes, may be damaged by magnetic fields.

Avoid contact with your device when it is overheating. Failure to do so may cause low temperature burns, redness and skin pigmentation

- Do not use the device for extended periods. Be careful to not overheat the device during prolonged use.
- Do not sit on your device or make direct contact with your skin for extended periods when charging or connected to a power source.
- Tolerance to high temperature varies individually. Please take extra caution regarding the use of the device by children, elders and people with special conditions.

- Be careful not to expose the camera lens to a strong light source, such as direct sunlight or lasers
- If the camera lens is exposed to a strong light source, such as direct sunlight, the camera image sensor may be damaged. A damaged image sensor is irreparable and will cause dots or spots in pictures.

Use caution when exposed to flashing lights

- Seizures or blackouts can occur when you are exposed to flashing lights while watching videos or playing Flash-based games for extended periods. If you feel any discomfort, stop using the device immediately.
- If anyone related to you has experienced seizures or blackouts while using a similar device, consult a physician before using the device.
- If you feel discomfort, such as a muscle spasm, or disoriented, stop using the device immediately and consult a physician.
- To prevent eye strain, take frequent breaks while using the device.

Reduce the risk of repetitive motion injuries

When you repetitively perform actions, such as entering text or playing games, you may experience occasional discomfort in your hands, neck, shoulders, or other parts of your body. When using your device for extended periods, take frequent breaks. If you continue to have discomfort during or after use, stop using the device and consult a physician.

Protect your hearing and ears when using your device

- Excessive exposure to loud sounds can cause hearing damage.
- Exposure to loud sounds while walking may distract your attention and cause an accident.
- Always turn the volume down before plugging the headphones into an audio source and use only the minimum volume setting necessary to hear your conversation or music.
- In dry environments, static electricity can build up in the headset. Avoid using headsets in dry environments or touch a metal object to discharge static electricity before connecting a headset to the device.

Do not paint or put stickers on your device

- Paint and stickers can clog moving parts and prevent proper operation.
- If you are allergic to paint or metal parts of the device, you may experience itching, eczema, or swelling of the skin. When this happens, stop using the device and consult your physician.

Do not drop your device or cause impacts to your device

- Your device may be damaged or may malfunction.
- If bent or deformed, your device may be damaged or parts may malfunction.

Ensure maximum battery and charger life

- Batteries may malfunction if they are not used for extended periods.
- Over time, unused device will discharge and must be recharged before use.
- Disconnect the charger from power sources when not in use.
- Use the battery only for their intended purposes.
- Follow all instructions in this manual to ensure the longest lifespan of your device and battery. Damages or poor performance caused by failure to follow warnings and instructions can void your manufacturer's warranty.
- Your device may wear out over time. Some parts and repairs are covered by the warranty within the validity period, but damages or deterioration caused by using unapproved accessories are not.
- Damage to your device caused by unauthorized modifications or repairs may not be covered by the manufacturer's standard limited warranty.
- Do not disassemble or puncture the battery, as this can cause explosion or fire.
- Do not disassemble or reuse the battery.
- Turn off the device before removing the battery. If you remove the battery with the device turned on, it may cause the device to malfunction.

When cleaning your device, mind the following

- When cleaning the visor window, use the supplied lens cleaning cloth.
- When cleaning the speaker, use a soft brush or cotton swab to remove any foreign materials.

- When washing the fabric, wet a soft cloth with a mild detergent mixed with water, wring out the cloth, and then wipe the fabric with it.
- Do not use harsh chemicals or detergents. Doing so may discolor or corrode the outside the device or may result in electric shock or fire.
- Prevent the device from being exposed to dust, sweat, ink, oil, and chemical products such as cosmetics, antibacterial spray, hand cleaner, and insecticides. The device's exterior and interior parts may be damaged or it could result in poor performance. If your device is exposed to any of the previously mentioned substances, use a lint-free, soft cloth to clean it.

Do not use the device for anything other than its intended use

Your device may malfunction.

Allow only qualified personnel to repair your device

Allowing unqualified personnel to repair your device may result in damage to your device that might not be covered by your manufacturer's warranty.

Protect your personal data and prevent leakage or misuse of sensitive information

- While using your device, be sure to back up important data. Samsung is not responsible for the loss of any data.
- When disposing of your device, back up all data and then reset your device to prevent misuse of your personal information.
- Carefully read the permissions screen when downloading applications. Be particularly cautious with applications that have access to many functions or to a significant amount of your personal information.
- Check your accounts regularly for unapproved or suspicious use. If you find any sign of misuse of your personal information, contact your service provider to delete or change your account information.
- In the event your device is lost or stolen, change the passwords on your accounts to protect your personal information.
- Avoid using applications from unknown sources and lock your device with a pattern, password, or PIN.

Do not distribute copyright-protected material

Do not distribute copyright-protected material without the permission of the content owners. Doing this may violate copyright laws. The manufacturer is not liable for any legal issues caused by the user's illegal use of copyrighted material.

To reduce the risk of injury or discomfort, you should always follow these instructions and observe these precautions while using the device

- Use only in a safe environment
 - Always be aware of your surroundings before beginning use and while using the device. Use caution to avoid injury.
 - Use of the device may cause loss of balance. Clear an area for safe use before using the device.
 - Remember that the objects you see in the extended reality environment do not exist in the real environment, so don't sit or stand on them or use them for support.
 - Serious injuries can occur from tripping, running into, or striking walls, furniture, or other objects, so clear an area for safe use before using the device.
 - Take special care to ensure that you are not near other people, objects, stairs, balconies, open doorways, windows, furniture, open flames, ceiling fans or light fixtures or other items that you can bump into or knock down when using—or immediately after using—the device.
 - Remember that while using the device you may be unaware that people and pets may enter your immediate area.
 - Do not handle sharp or otherwise dangerous objects while using the device.
 - Do not wear the device during activities that require extra attention, such as biking or driving.
 - Never wear the device in situations that require your attention, such as bicycling, driving, or exercising. Doing so may distract you from what you are doing and lead to an accident or injury.
 - Do not use the device in moving vehicles such as cars, buses, or trains. Using the device in a moving vehicle may cause the tracking function to fail entirely, rendering the device unusable.

- Make sure the charger or cable does not become entangled in your arms or nearby objects and furniture while using the device.
- Make sure the device is level and secured comfortably on your head. If you have trouble wearing the device, refer to the user manual.
- Using the device with any accessories on your face may increase the risk of injury. Remove all accessories, such as nose rings or eyebrow piercings, before using the device to reduce the risk of injury. Also, do not use the device if your face is injured in any way.
- Ease into the use of the device to allow your body to adjust; use for only a few minutes at a time at first, and only increase the amount of time using the device gradually as you grow accustomed to the device.
- Take a break at least every 30 minutes while using the device, even if you don't think you need it. Each person is different, so take more frequent and longer breaks if you feel discomfort. You should decide what works best for you.
- The device may be equipped with a Pass-through feature (VST) which permits you to check out your surroundings for brief real world interaction. You should always remove the device for any real-world situation that requires attention or coordination.
- Listening to sound at high volumes can cause irreparable damage to your hearing. Background noise, as well as continued exposure to high volume levels, can make sounds seem quieter than they actually are. Because of the immersive nature of the extended reality experience, do not use the device with the sound at a high volume so that you can maintain awareness of your surroundings and reduce the risk of hearing damage.

Malware and viruses

To protect your device from malware and viruses, follow these usage tips. Failure to do so may result in damages or loss of data that may not be covered by the warranty service

- Do not download unknown applications.
- Do not visit untrusted websites.
- Delete suspicious messages or email from unknown senders.
- Set a password and change it regularly.

- Turn off wireless features, such as Bluetooth, when not in use.
- If the device behaves abnormally, run an antivirus app to check for infection.
- Run an antivirus app on your device before you open newly-downloaded applications and files.
- Install antivirus apps on your computer and run them regularly to check for infection.
- Do not edit registry settings or modify the device's operating system.

Specific Absorption Rate (SAR) certification information

For more information, visit www.samsung.com/sar and search for your device with the model number.

Correct disposal of this product



(Waste Electrical & Electronic Equipment)

This marking on the product, accessories or literature indicates that the product and its electronic accessories (such as charger, headset, USB cable) should not be disposed of with other household waste.

To prevent possible harm to the environment or human health from uncontrolled waste disposal, please separate these items from other types of waste and recycle them responsibly to promote the sustainable reuse of material resources.

Household users should contact either the retailer where they purchased this product, or their local government office, for details of where and how they can take these items for environmentally safe recycling.

Business users should contact their supplier and check the terms and conditions of the purchase contract. This product and its electronic accessories should not be mixed with other commercial wastes for disposal.

Correct disposal of batteries in this product



This marking on the battery, manual or packaging indicates that the batteries in this product should not be disposed of with other household waste at the end of their working life.

FCC Information



NOTE The FCC approved model meets the following requirements described below.

This device complies with part 15 of the FCC Rules. Operation is subject to the following two conditions: (1) This device may not cause harmful interference, and (2) this device must accept any interference received, including interference that may cause undesired operation.

Note : This equipment has been tested and found to comply with the limits for a Class B digital device, pursuant to part 15 of the FCC Rules. These limits are designed to provide reasonable protection against harmful interference in a residential installation. This equipment generates, uses and can radiate radio frequency energy and, if not installed and used in accordance with the instructions, may cause harmful interference to radio communications. However, there is no guarantee that interference will not occur in a particular installation. If this equipment does cause harmful interference to radio or TV reception, which can be determined by turning the equipment off and on, the user is encouraged to try to correct the interference by one or more of the following measures:

- Reorient or relocate the receiving antenna.
- Increase the separation between the equipment and receiver.
- Connect the equipment into an outlet on a circuit different from that to which the receiver is connected.
- Consult the dealer or an experienced radio/TV technician for help.

Pursuant to Part 15.21 of the FCC Rules, you are cautioned that changes or modifications not expressly approved by Samsung could void your authority to operate the device. Some devices allow you to perform device-to-device charging without the need for a charger through Samsung's Wireless Power Sharing feature. If your device supports the wireless charging or power sharing features, this equipment should be operated with a minimum distance of 20 cm between the device and your body.

Disclaimer

Some content and services accessible through this device belong to third parties and are protected by copyright, patent, trademark or other intellectual property laws. Such content and services are provided solely for your personal non-commercial use. You may not use any content or services in a manner that has not been authorized by the content owner or service provider. Without limiting the foregoing, unless expressly authorized by the applicable content owner or service provider, you may not modify, copy, republish, upload, post, transmit, translate, sell, create derivative works, exploit, or distribute in any manner or medium any content or services displayed through this device.

THIRD PARTY CONTENT AND SERVICES ARE PROVIDED "AS IS." SAMSUNG DOES NOT WARRANT CONTENT OR SERVICES SO PROVIDED, EITHER EXPRESSLY OR IMPLIEDLY, FOR ANY PURPOSE. SAMSUNG EXPRESSLY DISCLAIMS ANY IMPLIED WARRANTIES, INCLUDING BUT NOT LIMITED TO, WARRANTIES OF MERCHANTABILITY OR FITNESS FOR A PARTICULAR PURPOSE. SAMSUNG DOES NOT GUARANTEE THE ACCURACY, VALIDITY, TIMELINESS, LEGALITY, OR COMPLETENESS OF ANY CONTENT OR SERVICE MADE AVAILABLE THROUGH THIS DEVICE AND UNDER NO CIRCUMSTANCES, INCLUDING NEGLIGENCE, SHALL SAMSUNG BE LIABLE, WHETHER IN CONTRACT OR TORT, FOR ANY DIRECT, INDIRECT, INCIDENTAL, SPECIAL OR CONSEQUENTIAL DAMAGES, ATTORNEY FEES, EXPENSES, OR ANY OTHER DAMAGES ARISING OUT OF, OR IN CONNECTION WITH, ANY INFORMATION CONTAINED IN, OR AS A RESULT OF THE USE OF ANY CONTENT OR SERVICE BY YOU OR ANY THIRD PARTY, EVEN IF ADVISED OF THE POSSIBILITY OF SUCH DAMAGES.

Third party services may be terminated or interrupted at any time, and Samsung makes no representation or warranty that any content or service will remain available for any period of time. Content and services are transmitted by third parties by means of networks and transmission facilities over which Samsung has no control.

Without limiting the generality of this disclaimer, Samsung expressly disclaims any responsibility or liability for any interruption or suspension of any content or service made available through this device.

Samsung is neither responsible nor liable for customer service related to the third-party content and services. Any question or request for service relating to the content or services should be made directly to the respective content and service providers.

Samsung Electronics America, Inc.

Address:

700 Sylvan Avenue
Englewood Cliffs, NJ 07632

Phone: 1-800-SAMSUNG (726-7864)

Internet: [samsung.com](https://www.samsung.com)

©2025 Samsung Electronics Co., Ltd. Samsung and Samsung Galaxy are trademarks of Samsung Electronics Co., Ltd. Bluetooth is a registered trademark of Bluetooth SIG Inc. Google, Google Gemini and other Google trademarks are the property of Google LLC. Other company and product names mentioned herein may be trademarks of their respective owners.

Manufactured under license from Dolby Laboratories. Dolby, Dolby Atmos, and the double-D symbol are trademarks of Dolby Laboratories.

Some multimedia (audio/video) files contain Digital Rights Management (DRM) technology to verify you have the right to use the files. Preloaded apps on your device may not be compatible with DRM-protected files.

Screen images are simulated. Appearance of device may vary.

Descriptions are based on the device's default settings. Some content may differ depending on carrier, model, or software.

The actual available capacity of the internal storage is less than the specified capacity because the operating system and default applications occupy part of the storage. The available capacity may change when you upgrade the device.

Please check with your service provider to verify qualifying services/features.

Using accessories provided by sources other than Samsung Electronics or companies approved by Samsung Electronics may cause performance problems and malfunctions that are not covered by the warranty.