

User's Guide

Samsung Printer **ProXpress**

M332x series
M382x series
M402x series

BASIC

This guide provides information concerning installation, basic operation and troubleshooting on windows.

ADVANCED

This guide provides information about the installation, advanced configuration, operation and troubleshooting on various OS environments.

Some features may not be available depending on models or countries.



1. Introduction

Key benefits	5
Features by models	8
Useful to know	11
About this user's guide	12
Safety information	13
Machine overview	19
Control panel overview	22
Turning on the machine	24
Installing the driver locally	25
Reinstalling the driver	28



2. Menu Overview and Basic Setup

Menu overview	30
Machine's basic settings	33
Media and tray	35
Basic printing	46



3. Maintenance

Ordering supplies and accessories	53
Available consumables	54
Available accessories	56
Available maintenance parts	57
Storing the toner cartridge	58
Redistributing toner	60
Replacing the toner cartridge	62
Replacing the imaging unit	65
Installing accessories	67
Monitoring the supplies life	71
Setting the toner/imaging unit low alert	72
Cleaning the machine	73
Tips for moving & storing your machine	77



4. Troubleshooting

Tips for avoiding paper jams	79
Clearing paper jams	80
Understanding the status LED	92
Understanding display messages	95



5. Appendix

Specifications	101
Regulatory information	109
Copyright	119



1. Introduction

This chapter provides information you need to know before using the machine.

- **Key benefits** 5
- **Features by models** 8
- **Useful to know** 11
- **About this user's guide** 12
- **Safety information** 13
- **Machine overview** 19
- **Control panel overview** 22
- **Turning on the machine** 24
- **Installing the driver locally** 25
- **Reinstalling the driver** 28

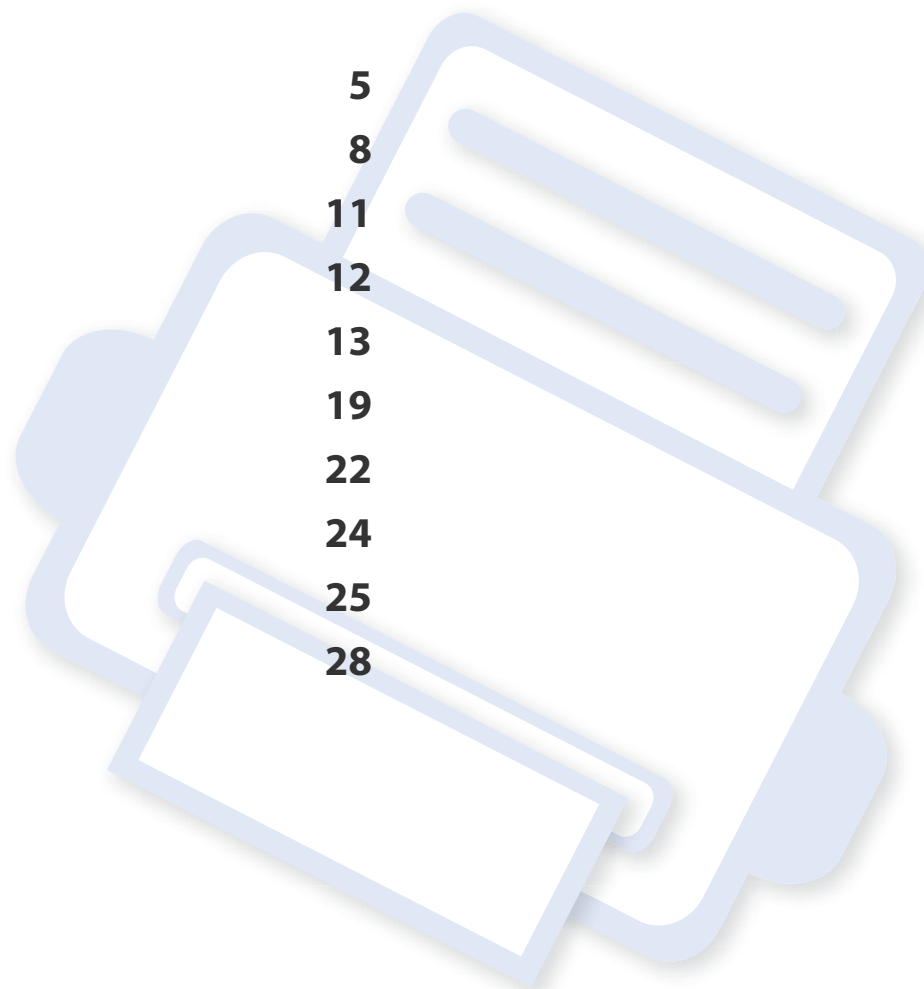

Key benefits

Environmentally friendly



- To save toner and paper, this machine supports Eco feature (see "Eco printing" on page 49).
- To save paper, you can print multiple pages on one single sheet of paper (see "Using advanced print features" on page 193).
- To save paper, you can print on both sides of the paper (double-sided printing) (see "Using advanced print features" on page 193).
- To save electricity, this machine automatically conserves electricity by substantially reducing power consumption when not in use.
- We recommend using recycled paper for saving energy.

Fast high resolution printing



- You can print with a resolution of up to 1,200 x 1,200 dpi effective output (1200 x 600 x 2 bit).
- Fast, on-demand printing.
 - M332x series
 - For single-side printing, 33 ppm (A4) or 35 ppm (Letter).
 - M382x series
 - For single-side printing, 38 ppm (A4) or 40 ppm (Letter).
 - M402x series
 - For single-side printing, 40 ppm (A4) or 42 ppm (Letter).

Key benefits

Convenience



- You can print on the go from your smartphone or computer using Google Cloud Print™ enabled apps (see "Google Cloud Print™" on page 173).
- Easy Capture Manager allows you to easily edit and print whatever you captured using the Print Screen key on the keyboard (see "Easy Capture Manager" on page 212).
- Samsung Easy Printer Manager and Printing Status is a program that monitors and informs you of the machine's status and allows you to customize the machine's settings (see "Using Samsung Easy Printer Manager" on page 219 or "Using Samsung Printer Status" on page 222).
- Samsung AnyWeb Print helps you screen-capture, preview, scrap, and print the screen of Windows Internet Explorer more easily than when you use the ordinary program (see "Samsung AnyWeb Print" on page 213).
- Smart Update allows you to check for the latest software and install the latest version during the printer driver installation process. This is available only for Windows.
- If you have Internet access, you can get help, support application, machine drivers, manuals, and order information from the Samsung website, www.samsung.com > find your product > Support or Downloads.

Wide range of functionality and application support



- Supports various paper sizes (see "Print media specifications" on page 103).
- Print watermark: You can customize your documents with words, such as "**CONFIDENTIAL**" (see "Using advanced print features" on page 193).
- Print posters: The text and pictures of each page of your document are magnified and printed across the multiple sheets of paper and can then be taped together to form a poster (see "Using advanced print features" on page 193).
- You can print in various operating systems (see "System requirements" on page 105).
- Your machine is equipped with a USB interface and/or a network interface.

Key benefits

Supports various wireless network setting method



- Using the WPS (Wi-Fi Protected Setup™) button
 - You can easily connect to a wireless network using the WPS button on the machine and the access point (a wireless router).
- Using the USB cable or a network cable
 - You can connect and set various wireless network settings using a USB cable or a network cable.
- Using the Wi-Fi Direct
 - You can conveniently print from your mobile device using the Wi-Fi or Wi-Fi Direct feature.



See "Introducing wireless set up methods" on page 146.

Features by models

Some features and optional goods may not be available depending on model or country.

Operating System

Operating System	M332x series	M382x series	M402x series
Windows	•	•	•
Mac	•	•	•
Linux	•	•	•
Unix	•	• (M382xND/M382xDW only)	•

(●: Included, Blank: Not available)

Features by models

Software

You can install the printer driver and software when you insert the software CD into your CD-ROM drive. For windows, select the printer driver and software in the **Select Software to Install** window.

Software		M332x series	M382x series	M402x series
SPL printer driver		●	●	●
PCL printer driver		●	● (M382xND/M382xDW only)	●
PS printer driver ^a		●	● (M382xND/M382xDW only)	●
XPS printer driver ^a		●	●	●
Samsung Easy Printer Manager	Device Settings	●	●	●
Samsung Printer Status		●	●	●
Direct Printing Utility ^a		●	●	●
Samsung AnyWeb Print ^a		●	●	●
SyncThru™ Web Service		●	● (M382xND/M382xDW only)	●
SyncThru Admin Web Service		●	● (M382xND/M382xDW only)	●
Easy Eco Driver		●	●	●
Easy Capture Manager		●	●	●

a. Download the software from the Samsung website and install it: (<http://www.samsung.com> > find your product > Support or Downloads). Before installing, check whether your computer's OS support the software.

(●: Included, Blank: Not available)

Features by models

Variety feature

Features	M332x series	M382x series	M402x series
Hi-Speed USB 2.0	●	●	●
IEEE 1284B parallel connector ^a	○	○	○
Network Interface Ethernet 10/100 Base TX wired LAN	●	● (M382xND/M382xDW only)	
Network Interface Ethernet 10/100/1000 Base TX wired LAN			●
Network Interface 802.11b/g/n wireless LAN ^b		● (M382xDW only)	
Eco printing	●	●	●
Duplex (2-sided) printing	●	●	●
USB memory interface			
Memory module		○ (M382xND/M382xDW only)	○
Optional tray (Tray2)	○	○ (M382xND/M382xDW only)	○
AirPrint	●	●	●
Google Cloud Print™	●	●	●

a. If you use the parallel port, you cannot use the USB cable.

b. Depending on your country, wireless LAN card may not be available. For some countries, only 802.11 b/g can be applied. Contact your local Samsung dealer or the retailer where you bought your machine.

(●: Included, ○: optional, Blank: Not available)

Useful to know



The machine does not print.

- Open the print queue list and remove the document from the list (see "Canceling a print job" on page 47).
- Remove the driver and install it again (see "Installing the driver locally" on page 25).
- Select your machine as your default machine in your Windows (see "Setting your machine as a default machine" on page 192).



Where can I purchase accessories or supplies?

- Inquire at a Samsung distributor or your retailer.
- Visit www.samsung.com/supplies. Select your country/region to view product service information.



The status LED flashes or remains constantly on.

- Turn the product off and on again.
- Check the meanings of LED indications in this manual and troubleshoot accordingly (see "Understanding the status LED" on page 92).



A paper jam has occurred.

- Open and close the door (see "Front view" on page 20).
- Check the instructions on removing jammed paper in this manual and troubleshoot accordingly (see "Clearing paper jams" on page 80).



Printouts are blurry.

- The toner level might be low or uneven. Shake the toner cartridge (see "Redistributing toner" on page 60).
- Try a different print resolution setting (see "Opening printing preferences" on page 47).
- Replace the toner cartridge (see "Replacing the toner cartridge" on page 62).



Where can I download the machine's driver?

- You can get help, support application, machine drivers, manuals, and order information from the Samsung website, www.samsung.com > find your product > Support or Downloads.

About this user's guide

This user's guide provides information for your basic understanding of the machine as well as detailed steps to explain machine usage.



- Read the safety information before using the machine.
- If you have a problem using the machine, refer to the troubleshooting chapter.
- Terms used in this user's guide are explained in the glossary chapter.
- All illustrations in this user's guide may differ from your machine depending on its options or model you purchased.
- The screenshots in this user's guide may differ from your machine depending on the machine's firmware/driver version.
- The procedures in this user's guide are mainly based on Windows 7.

Conventions

Some terms in this guide are used interchangeably, as below:

- Document is synonymous with original.
- Paper is synonymous with media, or print media.
- Machine refers to printer or MFP.

General icons



Icon	Text	Description
	Caution	Gives users information to protect the machine from possible mechanical damage or malfunction.
	Note	Provides additional information or detailed specification of the machine function and feature.

Safety information

These warnings and precautions are included to prevent injury to you and others, and to prevent any potential damage to your machine. Be sure to read and understand all of these instructions before using the machine. After reading this section, keep it in a safe place for future reference.

Important safety symbols

Explanation of all icons and signs used in this chapter

	Warning	Hazards or unsafe practices that may result in severe personal injury or death.
	Caution	Hazards or unsafe practices that may result in minor personal injury or property damage.
		Do not attempt.

Operating environment

Warning



Do not use if the power cord is damaged or if the electrical outlet is not grounded.

This could result in electric shock or fire.



Do not place anything on top of the machine (water, small metal or heavy objects, candles, lit cigarettes, etc.).

This could result in electric shock or fire.

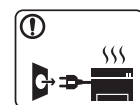

- If the machine gets overheated, it releases smoke, makes strange noises, or generates an odd odor, immediately turn off the power switch and unplug the machine.

- The user should be able to access the power outlet in case of emergencies that might require the user to pull the plug out.

This could result in electric shock or fire.



Do not bend, or place heavy objects on the power cord.

Stepping on or allowing the power cord to be crushed by a heavy object could result in electric shock or fire.







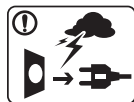

Do not remove the plug by pulling on the cord; do not handle the plug with wet hands.

This could result in electric shock or fire.







Safety information

Caution



	<p>During an electrical storm or for a period of non-operation, remove the power plug from the electrical outlet.</p> <p>This could result in electric shock or fire.</p>
	<p>Be careful, the paper output area is hot.</p> <p>Burns could occur.</p>
	<p>If the machine has been dropped, or if the cabinet appears damaged, unplug the machine from all interface connections and request assistance from qualified service personnel.</p> <p>Otherwise, this could result in electric shock or fire.</p>
	<p>If the machine does not operate properly after these instructions have been followed, unplug the machine from all interface connections and request assistance from qualified service personnel.</p> <p>Otherwise, this could result in electric shock or fire.</p>
	<p>If the plug does not easily enter the electrical outlet, do not attempt to force it in.</p> <p>Call an electrician to change the electrical outlet, or this could result in electric shock.</p>
	<p>Do not allow pets to chew on the AC power, telephone or PC interface cords.</p> <p>This could result in electric shock or fire and/or injury to your pet.</p>

Operating method

Caution

	<p>Do not forcefully pull the paper out during printing.</p> <p>It can cause damage to the machine.</p>
	<p>Be careful not to put your hand between the machine and paper tray.</p> <p>You may get injured.</p>
	<p>Be care when replacing paper or removing jammed paper.</p> <p>New paper has sharp edges and can cause painful cuts.</p>
	<p>When printing large quantities, the bottom part of the paper output area may get hot. Do not allow children to touch.</p> <p>Burns can occur.</p>
	<p>When removing jammed paper, do not use tweezers or sharp metal objects.</p> <p>It can damage the machine.</p>
	<p>Do not allow too many papers to stack up in the paper output tray.</p> <p>It can damage the machine.</p>

Safety information



	Do not block or push objects into the ventilation opening. This could result in elevated component temperatures which can cause damage or fire.
	Use of controls or adjustments or performance of procedures other than those specified herein may result in hazardous radiation exposure.
	This machine's power reception device is the power cord. To switch off the power supply, remove the power cord from the electrical outlet.

Installation / Moving





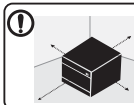

Warning

	Do not place the machine in an area with dust, humidity, or water leaks. This could result in electric shock or fire.
--	--

Caution

	Before moving the machine, turn the power off and disconnect all cords. The information below are only suggestions based on the units weight. If you have a medical condition that prevents you from lifting, do not lift the machine. Ask for help, and always use the appropriate amount of people to lift the device safety. Then lift the machine: <ul style="list-style-type: none">• If the machine weighs under 20 kg (44.09 lbs), lift with 1 person.• If the machine weighs 20 kg (44.09 lbs) - 40kg (88.18 lbs), lift with 2 people.• If the machine weighs more than 40 kg (88.18 lbs), lift with 4 or more people. The machine could fall, causing injury or machine damage.
	Choose a flat surface with enough space for ventilation to place the machine. Also consider the space required to open the cover and trays. The place should be well-ventilated and be far from direct light, heat, and humidity.
	When using the machine for a long period of time or printing a large number of pages in a non-ventilated space, it could pollute the air and be harmful to your health. Place the machine in a well-ventilated space or open a window to circulate the air periodically.





Safety information

	Do not place the machine on an unstable surface. The machine could fall, causing injury or machine damage.
	Use only No.26 AWG ^a or larger, telephone line cord, if necessary. Otherwise, it can cause damage to the machine.
	Make sure you plug the power cord into a grounded electrical outlet. Otherwise, this could result in electric shock or fire.
	Use the power cord supplied with your machine for safe operation. If you are using a cord which is longer than 2 meters (6 feet) with a 110V machine, then the gauge should be 16 AWG or larger. Otherwise, it can cause damage to the machine, and could result in electric shock or fire.
	Do not put a cover over the machine or place it in an airtight location, such as a closet. If the machine is not well-ventilated, this could result in fire.
	Do not overload wall outlets and extension cords. This can diminish performance, and could result in electric shock or fire.
	The machine should be connected to the power level which is specified on the label. If you are unsure and want to check the power level you are using, contact the electrical utility company.



a. AWG: American Wire Gauge

Maintenance / Checking

Caution



	Unplug this product from the wall outlet before cleaning the inside of the machine. Do not clean the machine with benzene, paint thinner or alcohol; do not spray water directly into the machine. This could result in electric shock or fire.
	When you are working inside the machine replacing supplies or cleaning the inside, do not operate the machine. You could get injured.
	Keep cleaning supplies away from children. Children could get hurt.
	Do not disassemble, repair or rebuild the machine by yourself. It can damage the machine. Call a certified technician when the machine needs repairing.







Safety information

	<p>To clean and operate the machine, strictly follow the user's guide provided with the machine.</p> <p>Otherwise, you could damage the machine.</p>
	<p>Keep the power cable and the contact surface of the plug clean from dust or water.</p> <p>Otherwise, this could result in electric shock or fire.</p>
	<ul style="list-style-type: none">• Do not remove any covers or guards that are fastened with screws.• Fuser units should only be repaired by a certified service technician. Repair by non-certified technicians could result in fire or electric shock.• The machine should only be repaired by a Samsung service technician.

Supply usage

Caution

 	<p>Do not disassemble the toner cartridge.</p> <p>Toner dust can be dangerous if inhaled or ingested.</p>
--	---

	<p>Do not burn any of the supplies such as toner cartridge or fuser unit.</p> <p>This could cause an explosion or uncontrollable fire.</p>
 	<p>When storing supplies such as toner cartridges, keep them away from children.</p> <p>Toner dust can be dangerous if inhaled or ingested.</p>
	<p>Using recycled supplies, such as toner, can cause damage to the machine.</p> <p>In case of damage due to the use of recycled supplies, a service fee will be charged.</p>
	<p>For supplies that contain toner dust (toner cartridge, waste toner bottle, imaging unit, etc.) follow the instructions below.</p> <ul style="list-style-type: none">• When disposing of the supplies, follow the instructions for disposal. Refer to the reseller for disposal instructions.• Do not wash the supplies.• For a waste toner bottle, do not reuse it after emptying the bottle. <p>If you do not follow the instructions above, it may cause machine malfunction and environmental pollution. The warranty does not cover damages caused by a user's carelessness.</p>
	<p>When toner gets on your clothing, do not use hot water to wash it.</p> <p>Hot water sets toner into fabric. Use cold water.</p>

Safety information



When changing the toner cartridge or removing jammed paper, be careful not to let toner dust touch your body or clothes.

Toner dust can be dangerous if inhaled or ingested.

Machine overview

Components

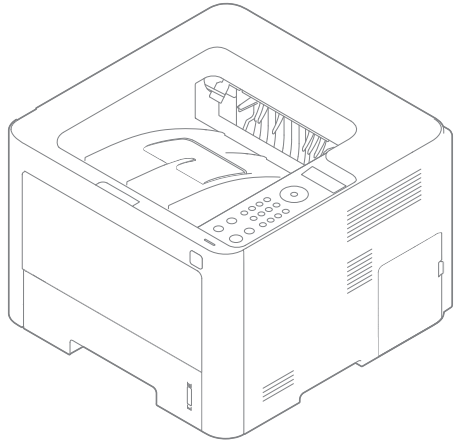
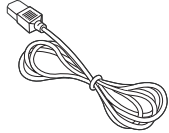
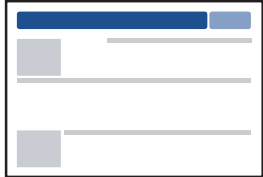
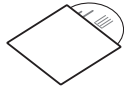
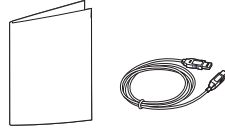
		
	Power cord	Quick installation guide
		
Machine	Software CD ^a	Misc. accessories ^b

a. The software CD contains the print drivers, user's guide, and software applications.

b. Miscellaneous accessories included with your machine may vary by country of purchase and specific model.

Machine overview

Front view



- This illustration may differ from your machine depending on your model. There are various types of machine.
- Some features and optional goods may not be available depending on model or country (see "Features by models" on page 8).

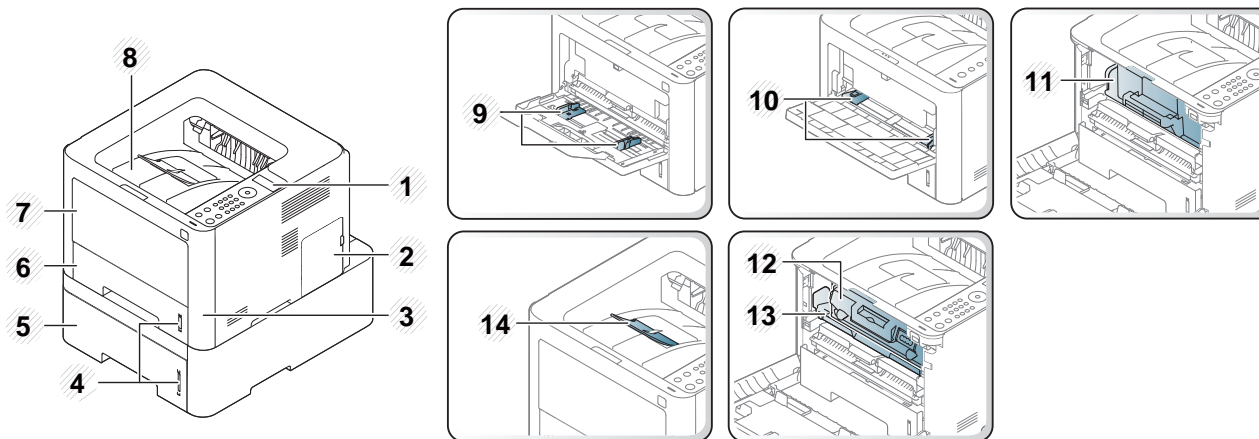

1	Control panel	5	Tray 2 ^a	9	Paper width guides on a multi-purpose tray	13	Imaging unit ^c
2	Control board cover	6	Tray 1	10	Paper width guides on a manual feeder	14	Output support
3	Front cover	7	Multi-purpose (or manual feeder) tray	11	Toner cartridge ^b		
4	Paper level indicator	8	Output tray	12	Toner cartridge ^c		

a. Optional. Not available for M382xD.

b. M3320/M3820/M4020 series only.

c. M3325/M3825/M4025 series only.

Machine overview

Rear view



- This illustration may differ from your machine depending on your model. There are various types of machine.
- Some features and optional goods may not be available depending on model or country (see "Features by models" on page 8).

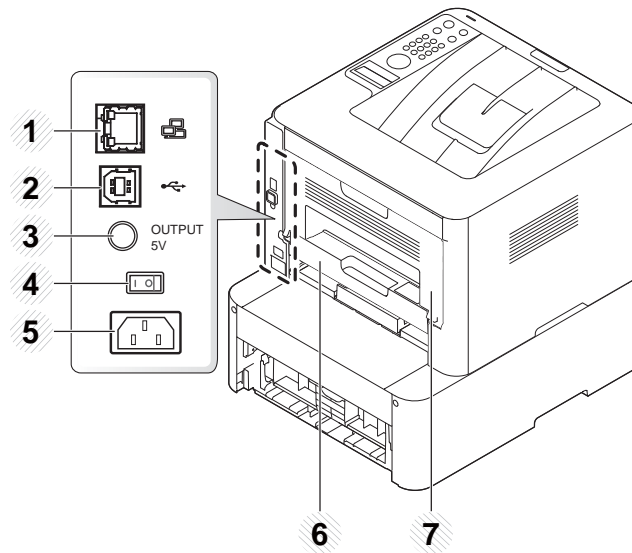

1	Network port ^a	4	Power-switch	7	Rear cover
2	USB port	5	Power receptacle		
3	5V output port for IEEE 1284B parallel connector ^b	6	Duplex unit		

a. Not available for M382xD.

b. To use the optional IEEE 1284B parallel connector, plug it to the USB port and the 5V output port.

Control panel overview



- This control panel may differ from your machine depending on its model. There are various types of control panels.
- Some features and optional goods may not be available depending on model or country (see "Features by models" on page 8).

M332xND/M382xD

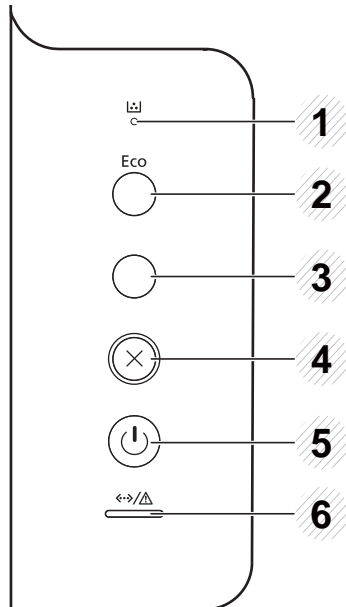

1	Toner LED	Shows the status of the toner (see "Understanding the status LED" on page 92).
---	------------------	--

2	Eco		Turn on the Eco mode to reduce toner consumption and paper usage (see "Eco printing" on page 49).
3	Info sheet		Prints a demo page and network configuration ^a page by pressing this button.
4	Cancel		Stops current operation.
5	Power		You can turn the power on and off with this button. Or wake up from the power save mode.
6	Status LED		Indicates the status of your machine (see "Understanding the status LED" on page 92).

a. M332xND only.

Control panel overview

M382xND/M382xDW/M402xND

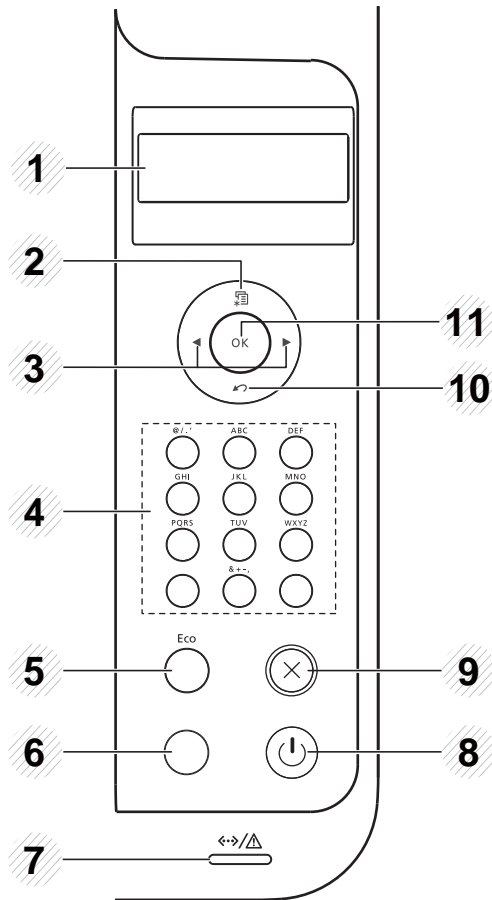

1	Display screen	Shows the current status and prompts during an operation.
---	-----------------------	---

2	Menu		Enters menu mode and scrolls through the available menus (see "Accessing the menu" on page 30).
3	Arrow		Navigates available values by moving to the next or previous options.
4	Numeric keypad		Use the keypad to enter numbers and characters (see "Keypad letters and numbers" on page 191).
5	Eco		Turn on the Eco mode to reduce toner consumption and paper usage (see "Eco printing" on page 49).
6	Info sheet		Prints a demo page and network configuration ^a page by pressing this button.
	WPS^b		Configures the wireless network connection easily without a computer (see "Using the WPS button" on page 148).
7	Status LED		Indicates the status of your machine (see "Understanding the status LED" on page 92).
8	Power		You can turn the power on and off with this button. Or wake up from the power save mode.
9	Cancel		Stops current operation.
10	Back		Sends you back to the upper menu level.
11	OK		Confirms the selection on the screen.

a. M382xND/M402xND only.

b. M382xDW only.

Turning on the machine

- 1 Connect the machine to the electricity supply first.

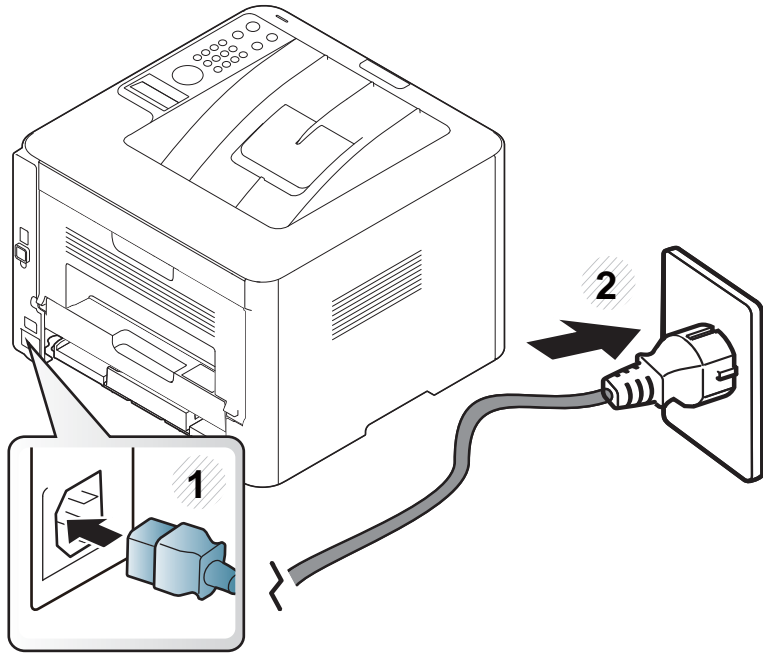

- 2 Turn the switch on.

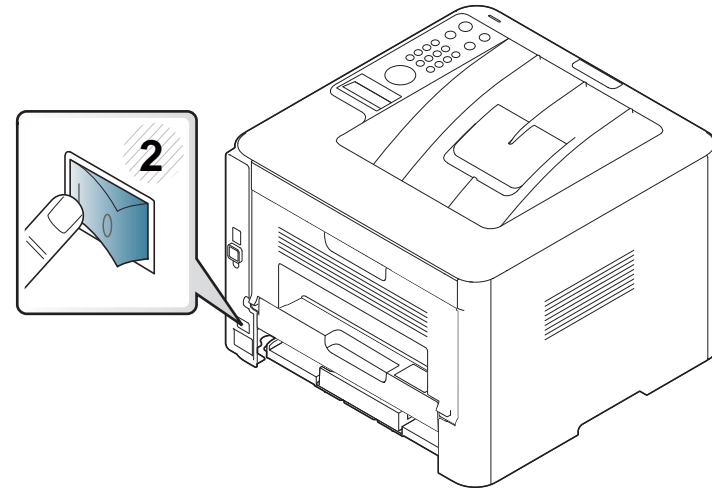

If you want to turn the power off, press the  (**Power/Wakeup**) button.

Installing the driver locally

A locally connected machine is a machine directly attached to your computer using the cable. If your machine is attached to a network, skip the following steps below and go on to installing a network connected machine's driver (see "Installing driver over the network" on page 133).



- If you are a Mac, Linux, or UNIX operating systems user, refer to the "Installation for Mac" on page 124, "Installation for Linux" on page 126, or "Installing the UNIX printer driver package" on page 139.
- The installation window in this User's Guide may differ depending on the machine and interface in use.
- Only use a USB cable no longer than 3 meters (118 inches).

Installing the driver locally

Windows

- 1 Make sure that the machine is connected to your computer and powered on.
- 2 Insert the supplied software CD into your CD-ROM drive.

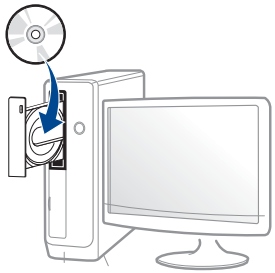

If the installation window does not appear, click **Start > All programs > Accessories > Run**.

X:\Setup.exe replacing "X" with the letter, which represents your CD-ROM drive and click **OK**.

- For Windows 8,
If the installation window does not appear, from **Charms**, select **Search > Apps** and search for **Run**. Type in X:\Setup.exe, replacing "X" with the letter that represents your CD-ROM drive and click **OK**.
If "**Tap to choose what happens with this disc.**" pop-up window appears, click the window and select **Run Setup.exe**.

- 3 Read and check **The software End User License Agreement** and **Using Enhanced Features and Participating in Printer Usage Information**

Collection Program (optional). Then, click **Next**.

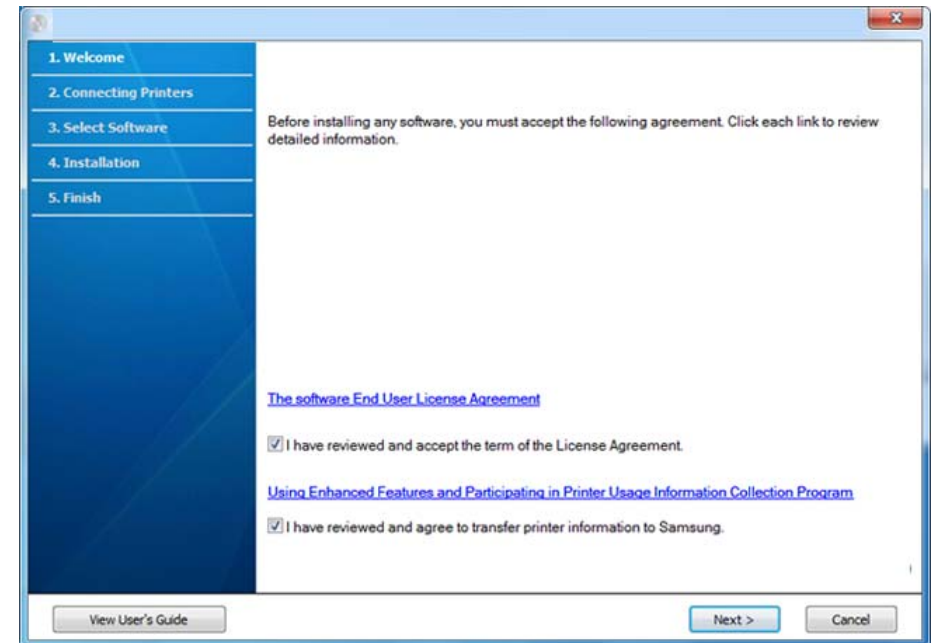

- 4 Follow the instructions in the installation window.



You can select the software applications in the **Select Software to Install** window.

Installing the driver locally

From the Windows 8 Start Screen



- **Samsung Printer Experience** app can only be used in the **Start** screen when V4 driver is installed. The V4 driver is automatically downloaded from the Windows Update if your computer is connected to the Internet. If not, you can manually download the V4 driver from Samsung website, www.samsung.com > find your product > Support or downloads.
- You can download Samsung Printer Experience app from the **Windows Store**. You need have a Microsoft account to use the Windows **Store**.
 - 1 From **Charms**, select **Search**.
 - 2 Click **Store**.
 - 3 Search and click **Samsung Printer Experience**.
 - 4 Click **Install**.
- If you install the driver using the supplied software CD, V4 driver is not installed. If you want to use the V4 driver in the **Desktop** screen, you can download from the Samsung website, www.samsung.com > find your product > Support or downloads.
- If you want to install Samsung's printer management tools, you need to install them using the supplied software CD.

- 1 Make sure that your computer is connected to the Internet and powered on.
- 2 Make sure that the machine is powered on.
- 3 Connect the computer and the machine with a USB cable.
The driver is automatically installed from the **Windows Update**.

Reinstalling the driver

If the printer driver does not work properly, follow the steps below to reinstall the driver.

Windows

- 1 Make sure that the machine is connected to your computer and powered on.
- 2 From the **Start** menu, select **Programs** or **All Programs** > **Samsung Printers** > **Uninstall Samsung Printer Software**.
 - For Windows 8,
 - 1 From Charms, select **Search** > **Apps**.
 - 2 Search and click **Control Panel**.
 - 3 Click **Programs and Features**.
 - 4 Right-click the driver you want to uninstall and select **Uninstall**.
- 3 Follow the instructions in the installation window.

- 4 Insert the software CD into your CD-ROM drive and install the driver again (see "Installing the driver locally" on page 25).

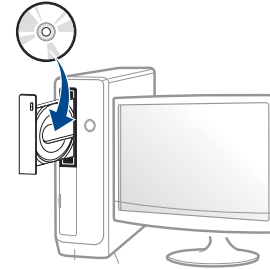

From the Windows 8 Start Screen

- 1 Make sure that the machine is connected to your computer and powered on.
- 2 Click on the **Uninstall Samsung Printer Software** tile in the **Start** screen.
- 3 Follow the instructions in the window.



- If you cannot find a Samsung Printer Software tile, uninstll from the desktop screen mode.
- If you want to uninstall Samsung's printer management tools, from the **Start** screen, right-click the app > **Uninstall** > right-click the program you want to delete > **Uninstall** and follow the instruction in the window.



2. Menu Overview and Basic Setup

This chapter provides information about the overall menu structure and the basic setup options.

- **Menu overview** 30
- **Machine's basic settings** 33
- **Media and tray** 35
- **Basic printing** 46





Menu overview

The control panel provides access to various menus to set up the machine or use the machine's functions.



- For models that do not have the display screen on the control panel, this feature is not applicable.
- Some menus may not appear on the display depending on options or models. If so, it is not applicable to your machine.
- Some menu names may differ from your machine depending on its options or the models.
- The menus are described in the Advanced Guide (see "Useful Setting Menus" on page 176).

Accessing the menu

- 1 Press  (**Menu**) button on the control panel.
- 2 Press the arrows until the needed menu item appears and press **OK**.
- 3 If the setting item has sub menus, repeat step 2.
- 4 Press **OK** to save the selection.
- 5 Press  (**Cancel**) to return to the ready mode.

Menu overview

Information	Layout	Paper	Graphic	System Setup	
Menu Map	Orientation	Copies	Resolution	Date & Time^d	Auto Continue
Configuration	Portrait	MP Tray	Standard	Clock Mode^d	Auto Tray Swi.
Demo Page	Landscape	Paper Size	High Resol.	Language	Paper Substit.
Supplies Info.	Margin	Paper Type	Clear Text	Default Paper	Tray Protect.
Usage Counter	Common Margin	Tray <x>	Off	A4	SkipBlankPages
Account^a	MP Tray	Paper Size	Minimum	Letter	Maintenance
PCL Font	<Tray X>	Paper Type	Normal	Power Save	CLR Empty Msg.^e
PS Font	Emulation Mar.	Paper Source	Maximum	Wakeup Event	Supplies Life
EPSON Font	Duplex	Tray 1	Auto CR	Job Timeout	Image Mgr.
KSC5843 Font^b	Off	Tray 2^c		Altitude Adj.	TonerLow Alert
KSC5895 Font^b	Long Edge	MP Tray		Normal	ImgU.Low Alert^f
KSSM Font^b	Short Edge	Auto		High 1	RAM Disk
				High 2	Toner Save
				High 3	Eco Settings
				High 4	Auto Power Off

a. This is used only available when Job Accounting is enabled from the SyncThru™ Web Admin Service.

b. This option may not be available depending on your country.

c. This option only appears when an optional tray is installed.

d. M382xDWonly.

e. This option only appears when small amount of toner is left in the cartridge.

f. M3325/M3825/M4025 series only.

Menu overview

Emulation	Network		Job Management ^a
Emulation Type Setup	TCP/IP (IPv4)	Protocol Mgr.	Active Job
	DHCP	HTTP	Secured Job
	BOOTP	WINS	Stored Job
	Static	SNMPv1/v2	Print
	TCP/IP (IPv6)	UPnP(SSDP)	Delete
	IPv6 Protocol	mDNS	Filing Policy
	DHCPv6 Config	SetIP	Change Name
	Ethernet	SLP	Overwrite
	Ethernet Port	Network Conf.	
	Ethernet Speed	Clear Setting	
	802.1x		
	Wi-Fi ^b		
	Wi-Fi On/Off		
	Wi-Fi Settings		
	WPS		
	Wi-Fi Direct		
Wi-Fi Signal			
CLR Wi-Fi Set.			

a. This option is available when the optional memory installed or RAM Disk is checked.

b. M382xDW only.

Machine's basic settings



- For models that do not have the display screen on the control panel, set the machine's settings by using the **Device Settings** in Samsung Easy Printer Manager program
 - For Windows and Mac users, you set from **Samsung Easy Printer Manager** >  (**Switch to advanced mode**) > **Device Settings**, see "Device Settings" on page 221.

After installation is complete, you may want to set the machine's default settings.

To change the machine's default settings, follow these steps:



It may be necessary to press **OK** to navigate to lower-level menus for some models.

- 1 Select  (**Menu**) button on the control panel.
- 2 Press **System Setup**.
- 3 Select the option you want, then press **OK**.
 - **Language:** Change the language that is displayed on the control panel.
 - **Date & Time:** You can set the time and date. They are printed on reports. If, however, they are not correct, you need to change it for the correct time being.



Enter the correct time and date using arrows or numeric keypad (see "Keypad letters and numbers" on page 191).

- Month = 01 to 12
- Day = 01 to 31
- Year = requires four digits
- Hour = 01 to 12
- Minute = 00 to 59

- **Clock Mode:** You can set your machine to display the current time using either a 12 hours or 24 hours format.
- **Power Save:** When you are not using the machine for a while, use this feature to save power.



- When you press the power button or start printing, the product will wake up from the power saving mode.
- When you press any button except power button, the machine wake up from the power save mode. Press  (**Menu**) > **System Setup** > **Wakeup Event** > **On** on the control panel.

- **Altitude Adj.:** Print quality is affected by atmospheric pressure, which atmospheric pressure is determined by the height of the machine above sea level. Before you set the altitude value, determine the altitude where you are (see "Altitude adjustment" on page 190).

Machine's basic settings

- 4 Select the option you want, then press **OK**.
- 5 Press **OK** to save the selection.
- 6 Press  (**Cancel**) to return to ready mode.



Refer to below links to set other settings useful for using the machine.

- See "Setting the paper size and type" on page 44.
- See "Keypad letters and numbers" on page 191.

Media and tray

This chapter provides information on how to load print media into your machine.



- Using print media that does not meet these specifications may cause problems or require repairs. Such repairs are not covered by Samsung's warranty or service agreements.
- Make sure not to use the inkjet photo paper with this machine. It could cause damage to the machine.
- Using inflammable print media can cause a fire.
- Use designated print media (see "Print media specifications" on page 103).
- Make sure not to use the inkjet photo paper with this machine. It could cause damage to the machine.



The use of inflammable media or foreign materials left in the printer may lead to overheating of the unit and, in rare cases may cause a fire.

Tray overview



If you do not adjust the guide, it may cause paper registration, image skew, or jamming of the paper.

To change the size, you need to adjust the paper guides.

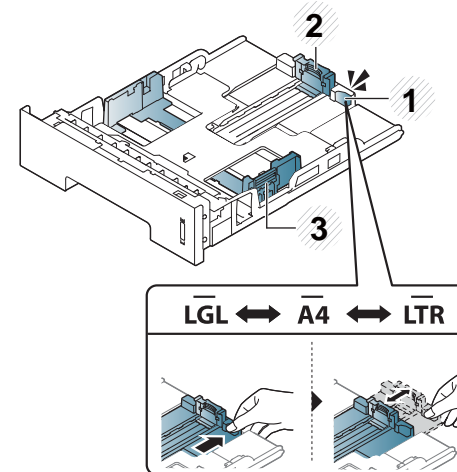

- 1 Tray extension guide
- 2 Paper length guide
- 3 Paper width guide

Media and tray

The duplex unit is preset to Letter/LGL or A4 size, depending on your country. To change the paper size, adjust the guides as shown below.

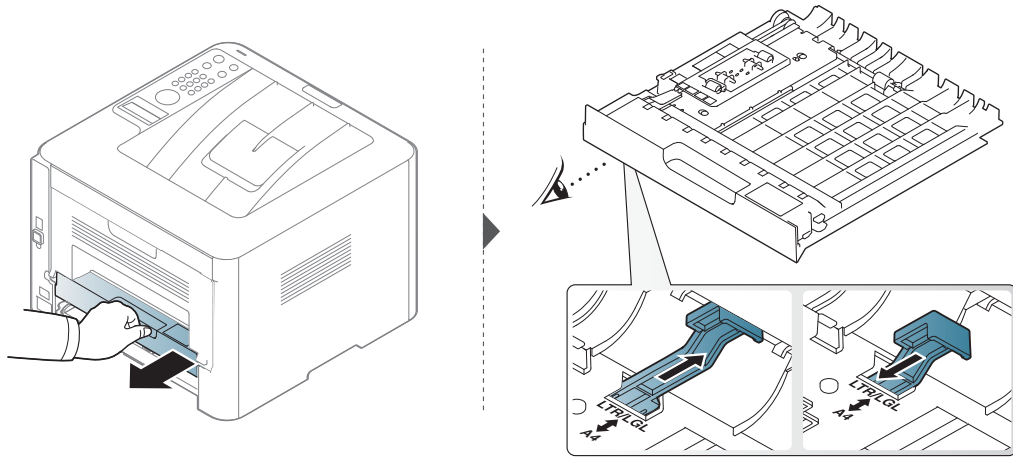

Paper quantity indicator shows the amount of paper in the tray.

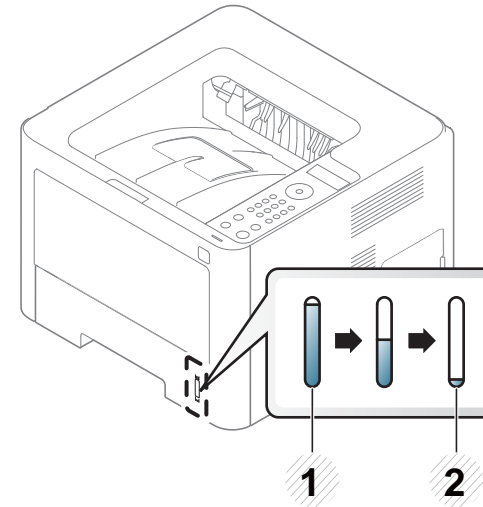

- 1 Full
- 2 Empty

Loading paper in the tray



Illustrations on this user's guide may differ from your machine depending on its options or models. Check your machine type (see "Front view" on page 20).

Media and tray

Tray 1 / optional tray

- 1 Pull out the paper tray.

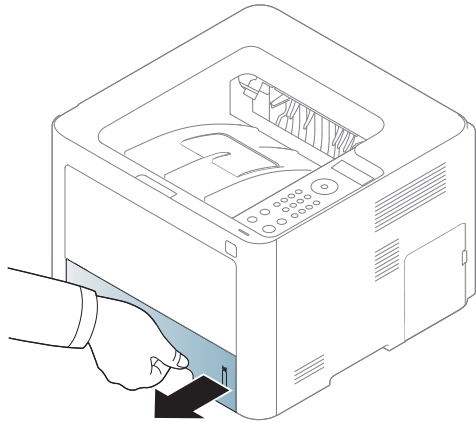

- 2 Squeeze the paper width guide and paper length lever to locate them in the correct paper size slot marked at the bottom of the tray to adjust to the size (see "Tray overview" on page 35).

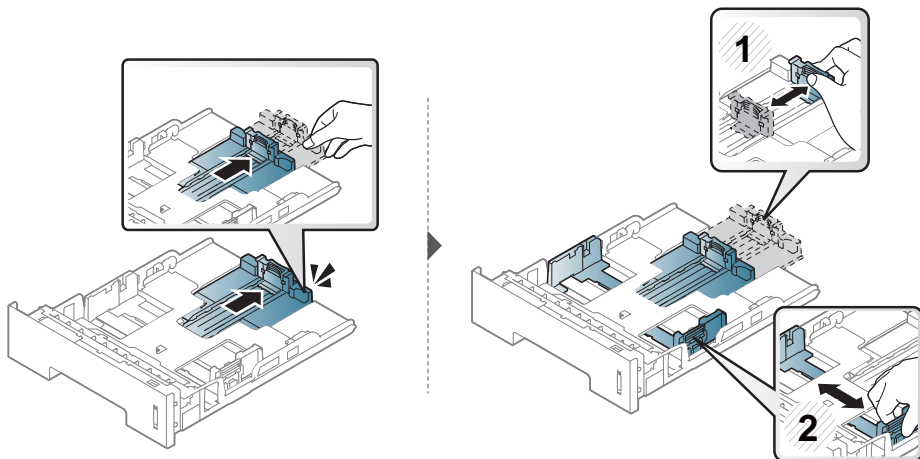

- 3 Flex or fan the edge of the paper stack to separate the pages before loading papers.

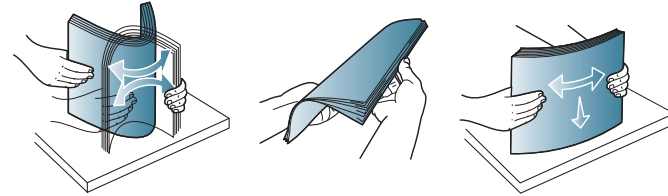

- 4 After inserting paper into the tray, squeeze the paper width guides and paper length guide.

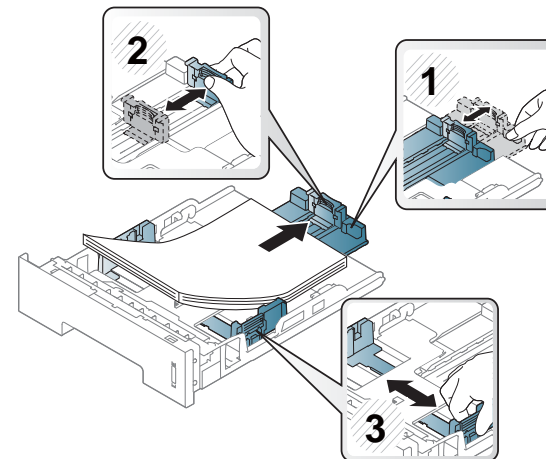

Media and tray



- Do not push the paper width guide too far causing the media to warp.
- If you do not adjust the paper width guide, it may cause paper jams.

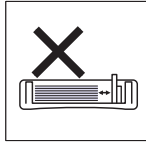
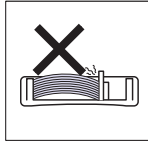
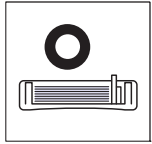

- Do not use a paper with a leading-edge curl, it may cause a paper jam or the paper can be wrinkled.

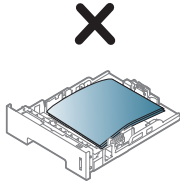
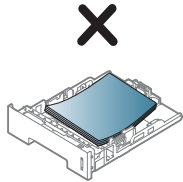
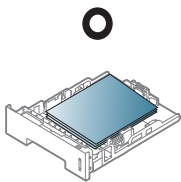

- 5** Insert the tray back into the machine.

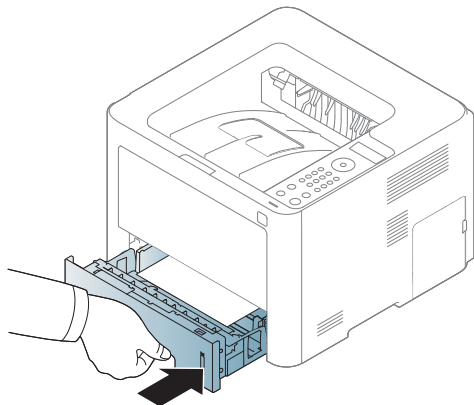

- 6** When you print a document, set the paper type and size for the tray (see "Setting the paper size and type" on page 44).

Multi-purpose (or Manual feeder) tray



Illustrations on this user's guide may differ from your machine depending on its options or models. Check your machine type (see "Front view" on page 20).

The Multi-purpose (or Manual feeder) tray can hold special sizes and types of print material, such as postcards, note cards, and envelopes (see "Print media specifications" on page 103).

Tips on using the Multi-purpose (or Manual feeder) tray

- Load only one type, size and weight of print media at a time in the Multi-purpose (or Manual feeder) tray.
- To prevent paper jams, do not add paper while printing when there is still paper in the Multi-purpose (or Manual feeder) tray. This also applies to other types of print media.
- Always load the specified print media only to avoid paper jams and print quality problems (see "Print media specifications" on page 103).
- Flatten any curl on postcards, envelopes, and labels before loading them into the Multi-purpose (or Manual feeder) tray.

Media and tray

1 Pull out the paper tray for manual feeding.

Or

Press the push-release of Multi-purpose (or Manual feeder) tray to open.

- M332xND/M382xD series

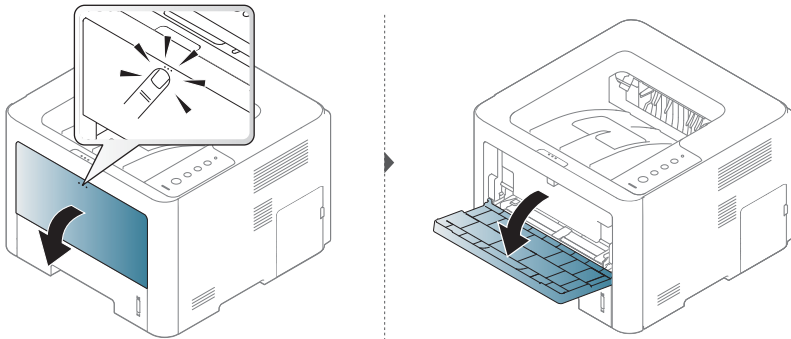

- M382xND/M382xDW/M402xND series

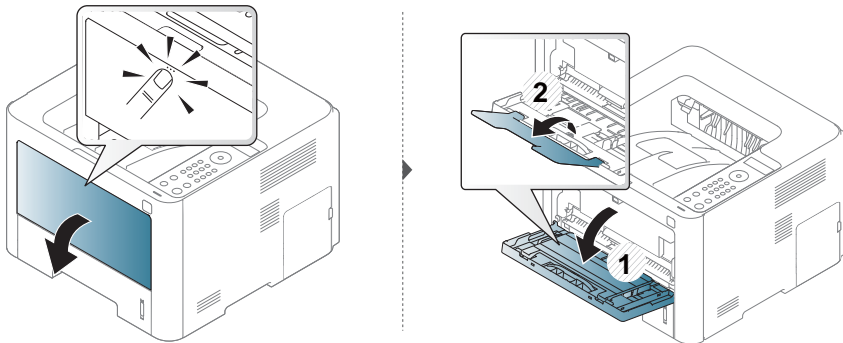

2 Load the paper.

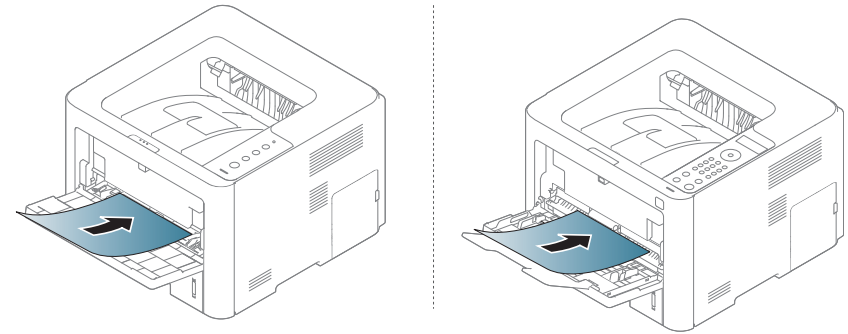

3 Squeeze the Multi-purpose (or Manual feeder) tray paper width guides and adjust them to the width of the paper. Do not force them too much, or the paper will bent resulting in a paper jam or skew.

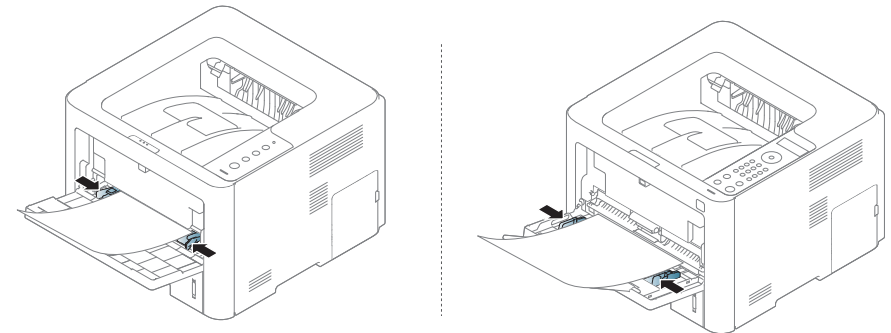

- When printing the special media, you must follow the loading guideline (See "Printing on special media" on page 40).
- When papers overlap when printing using Multi-purpose (or Manual feeder) tray, open tray 1 and remove overlapping papers then try printing again.

Media and tray

- 4 When you print a document, set the paper type and size for the Multi-purpose (or Manual feeder) tray (see "Setting the paper size and type" on page 44).

Printing on special media

The table below shows the special media usable in tray.

The paper setting in the machine and driver should match to print without a paper mismatch error.

To change the paper setting set in the machine, from the **Samsung Easy Printer Manager** select  **(Switch to advanced mode)** > **Device Settings**.

Or if your machine supports a display screen, you can set it using the  **(Menu)** button on the control panel.

Then, set the paper type from the **Printing preferences** window > **Paper** tab > **Paper Type** (see "Opening printing preferences" on page 47).



- When using special media, we recommend you feed one sheet at a time (see "Print media specifications" on page 103).
- Illustrations on this user's guide may differ from your machine depending on its options or models. Check your machine type (see "Front view" on page 20).

To see for paper weights for each sheet, refer to "Print media specifications" on page 103.

Types	Tray 1	Optional tray ^a	Multi-purpose (or manual feeder) tray
Plain	•	•	•
Thick	•	•	•
Thicker			•
Thin	•	•	•
Bond	•	•	•
Color			•
CardStock	•	•	•
Labels			•
Transparency			•
Envelope			•
Preprinted			•
Cotton			•
Recycled	•	•	•
Archive	•	•	•

a. This is feature is available when you install and optional tray (see "Variety feature" on page 10).

Media and tray

(●: Supported, Blank: Not supported)

Envelope

Printing successfully on envelopes depends upon the quality of the envelopes.

To print an envelope, place it as shown in the following figure.

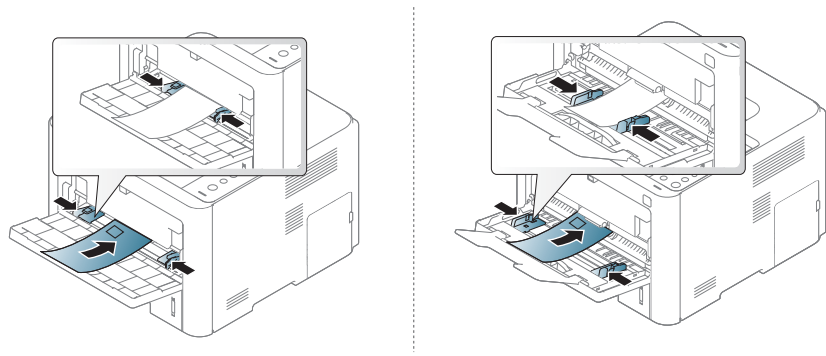

- When selecting envelopes, consider the following factors:
 - **Weight:** should not exceed 90 g/m² otherwise; jams may occur.
 - **Construction:** should lie flat with less than 6 mm curl and should not contain air.
 - **Condition:** should not be wrinkled, nicked, nor damaged.
 - **Temperature:** should resist the heat and pressure of the machine during operation.
- Use only well-constructed envelopes with sharp and well-creased folds.
- Do not use stamped envelopes.

- Do not use envelopes with clasps, snaps, windows, coated lining, self-adhesive seals, or other synthetic materials.
- Do not use damaged or poorly made envelopes.
- Be sure the seam at both ends of the envelope extends all the way to the corner of the envelope.

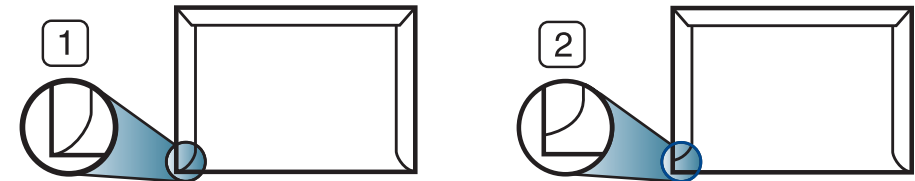

- 1 Acceptable
- 2 Unacceptable

- Envelopes with a peel-off adhesive strip or with more than one flap that folds over to seal must use adhesives compatible with the machine's fusing temperature for 0.1 second about 170°C (338 °F). The extra flaps and strips might cause wrinkling, creasing, or jams, and may even damage the fuser.
- For the best print quality, position margins no closer than 15 mm from the edges of the envelope.
- Avoid printing over the area where the envelope's seams meet.

Media and tray

Transparency

To avoid damaging the machine, use only transparencies designed for use in laser printers.

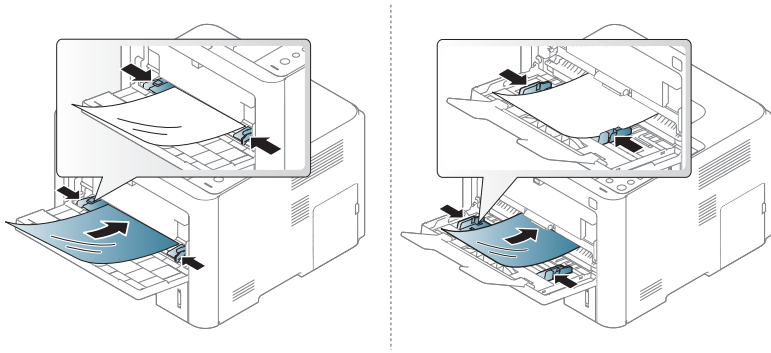

- Must withstand the machine's fusing temperature.
- Place them on a flat surface after removing them from the machine.
- Do not leave unused transparencies in the paper tray for long. Dust and dirt may accumulate on them, resulting in spotty printing.
- To avoid smudging caused by fingerprints, handle them carefully.
- To avoid fading, do not expose printed transparencies to prolonged sunlight.
- Ensure that transparencies are not wrinkled, curled, or have any torn edges.
- Do not use transparencies that separate from the backing sheet.
- To prevent transparencies from sticking to each other, do not let the printed sheets stack up as they are being printed out.

Labels

To avoid damaging the machine, use only labels designed for use in laser printers.

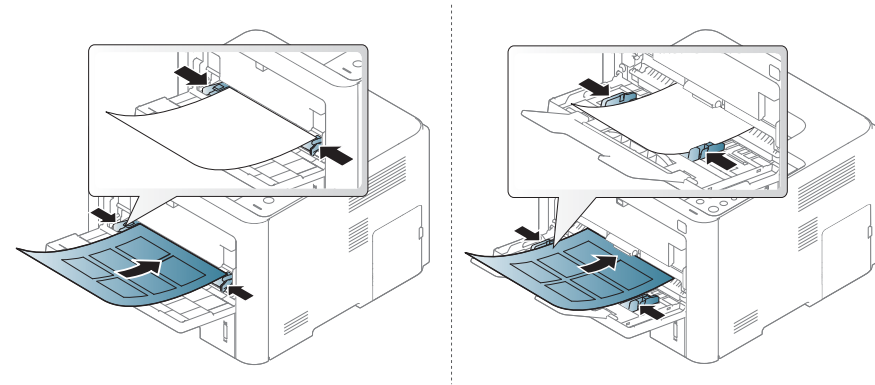

- When selecting labels, consider the following factors:
 - **Adhesives:** Should be stable at your machine's fusing temperature about 170°C (338°F).
 - **Arrangement:** Only use labels with no exposed backing between them. Labels can peel off sheets that have spaces between the labels, causing serious jams.
 - **Curl:** Must lie flat with no more than 13 mm of curl in any direction.
 - **Condition:** Do not use labels with wrinkles, bubbles, or other indications of separation.
- Make sure that there is no exposed adhesive material between labels. Exposed areas can cause labels to peel off during printing, which can cause paper jams. Exposed adhesive can also cause damage to machine components.

Media and tray

- Do not run a sheet of labels through the machine more than once. The adhesive backing is designed for only a single pass through the machine.
- Do not use labels that are separating from the backing sheet or are wrinkled, bubbled, or otherwise damaged.

Card stock/ Custom-sized paper

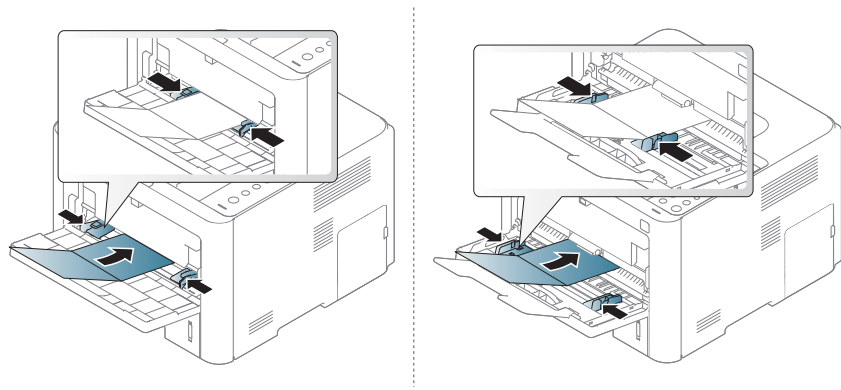

- In the software application, set the margins to at least 6.4 mm (0.25 inches) away from the edges of the material.

Preprinted paper

When loading preprinted paper, the printed side should be facing up with an uncurled edge at the front. If you experience problems with paper feeding, turn the paper around. Note that print quality is not guaranteed.

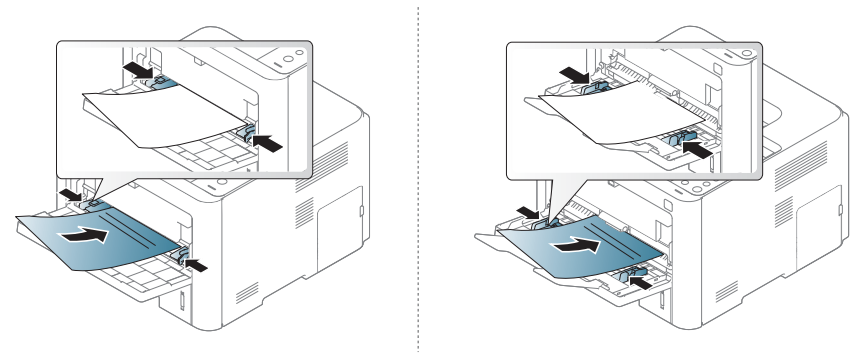

- Must be printed with heat-resistant ink that will not melt, vaporize, or release hazardous emissions when subjected to the machine's fusing temperature for 0.1 second (about 170°C (338°F)).
- Preprinted paper ink must be non-flammable and should not adversely affect machine rollers.
- Before you load preprinted paper, verify that the ink on the paper is dry. During the fusing process, wet ink can come off preprinted paper, reducing print quality.

Media and tray

Glossy Photo

- Recommended media: Glossy paper (Letter) for this machine by **HP Brochure Paper** (Product: Q6611A) only.
- Recommended media: Glossy paper (A4) for this machine by **HP Superior Paper 160 glossy** (Product: Q6616A).

Setting the paper size and type

After loading paper in the paper tray, set the paper size and type using the control panel buttons.

The paper setting in the machine and driver should match to print without a paper mismatch error.



To change the paper setting set in the machine, from the **Samsung Easy Printer Manager** select  **(Switch to advanced mode)** > **Device Settings**.

Or if your machine supports a display screen, you can set it using the  **(Menu)** button on the control panel.

Then, set the paper type from the **Printing preferences** window > **Paper** tab > **Paper Type** (see "Opening printing preferences" on page 47).



It may be necessary to press **OK** to navigate to lower-level menus for some models.

- 1 Select  **(Menu)** button on the control panel.
- 2 Press **Paper** and select the tray you want.
- 3 Press **Paper Size** or **Paper Type**.
- 4 Select the option you want.
- 5 Press **OK** to save the selection.
- 6 Press  **(Cancel)** to return to ready mode.



If you want to use special-sized paper such as billing paper, select the **Paper** tab > **Size** > **Edit...** and set **Custom Paper Size Settings** in the **Printing Preferences** (see "Opening printing preferences" on page 47).

Media and tray

Using the output support



The surface of the output tray may become hot if you print a large number of pages at once. Make sure that you do not touch the surface, and do not allow children near it.

The printed pages stack on the output support, and the output support will help the printed pages to align. Unfold the output support.

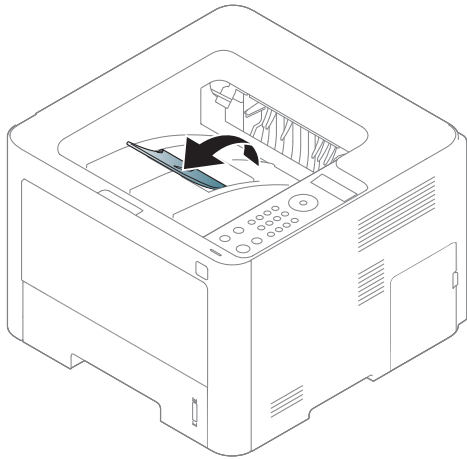

- Illustrations on this user's guide may differ from your machine depending on its options or models. Check your machine type (see "Front view" on page 20).
- If more than 50 pages (one-sided) of Legal paper is stacked in the output tray, paper can be mis-aligned or paper jams can occur. Do not let paper to stack up in the output tray.
- When printing on thick paper, paper may not properly align on the output support. Close the output support or turn the paper over in the tray before printing .

Basic printing



For special printing features, refer to the Advanced Guide (see "Using advanced print features" on page 193).

Printing



- If you are a Mac, Linux, or Unix operating systems user, refer to the Advanced Guide (see "Mac printing" on page 202, "Linux printing" on page 204, or "Unix printing" on page 206).
- For Windows 8 user, see "Basic printing" on page 225.

The following **Printing Preferences** window is for Notepad in Windows 7.

- 1 Open the document you want to print.
- 2 Select **Print** from the **File** menu.

- 3 Select your machine from the **Select Printer** list.

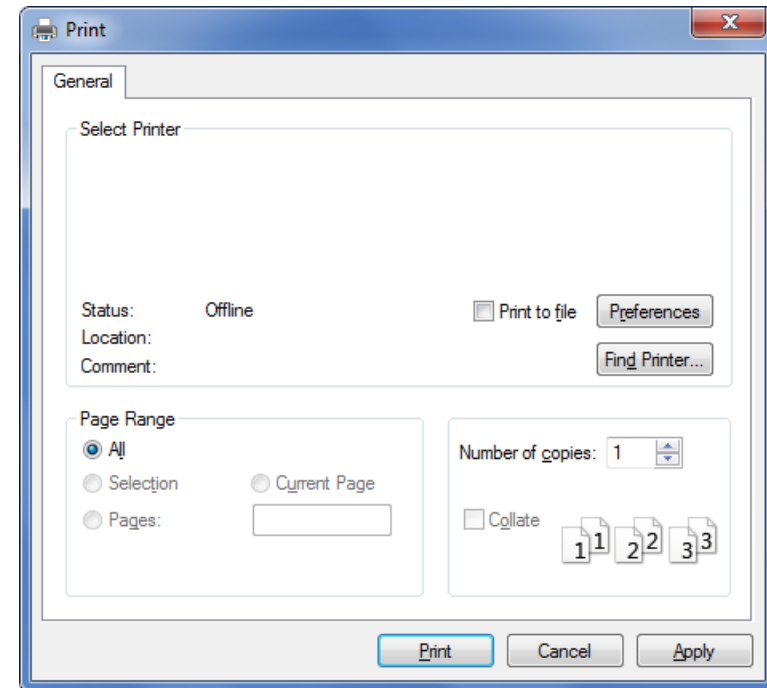

- 4 The basic print settings including the number of copies and print range are selected within the **Print** window.





To take advantage of the advanced printing features, click **Properties** or **Preferences** from the **Print** window (see "Opening printing preferences" on page 47).

- 5 To start the print job, click **OK** or **Print** in the **Print** window.

Basic printing





Canceling a print job

If the print job is waiting in the print queue or print spooler, cancel the job as follows:

- You can access this window by simply double-clicking the machine icon () in the Windows task bar.
- You can also cancel the current job by pressing  (**Cancel**) on the control panel.

Opening printing preferences



- The **Printing Preferences** window that appears in this user's guide may differ depending on the machine in use.
- When you select an option in **Printing Preferences**, you may see a warning mark  or . An  mark means you can select that certain option but it is not recommended, and an  mark means you cannot select that option due to the machine's setting or environment.
- For Windows 8 user, see "Opening more settings" on page 226.

- 1 Open the document you want to print.
- 2 Select **Print** from the file menu. The **Print** window appears.
- 3 Select your machine from the **Select Printer**.
- 4 Click **Properties** or **Preferences**.



The screenshot may differ depending on model.

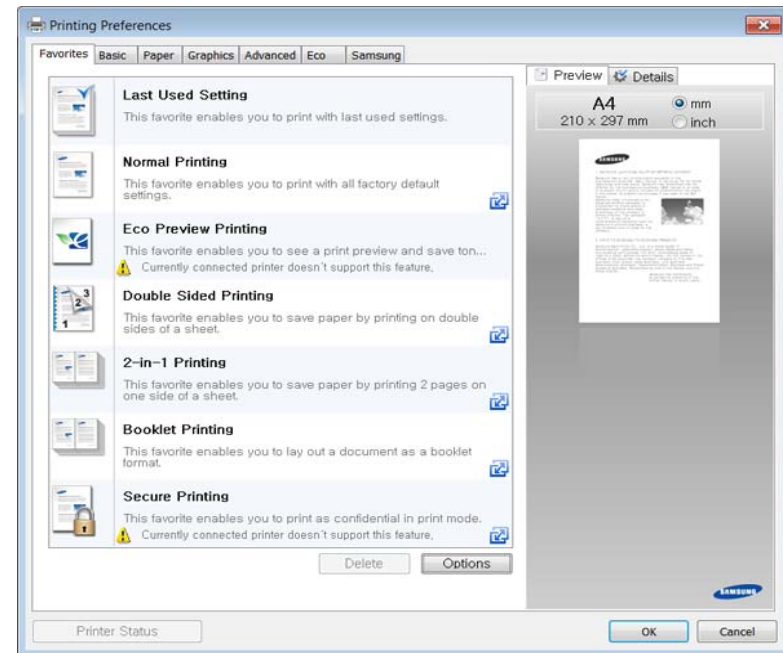

Basic printing



- You can apply **Eco** features to save paper and toner before printing (see "Easy Eco Driver" on page 214).
- You can check the machine's current status pressing the **Printer Status** button (see "Using Samsung Printer Status" on page 222).

Using a favorite setting

The **Favorites** option, which is visible on each preferences tab except for the **Samsung** tab, allows you to save the current preferences for future use.

To save a **Favorites** item, follow these steps:

- 1 Change the settings as needed on each tab.
- 2 Enter a name for the item in the **Favorites** input box.

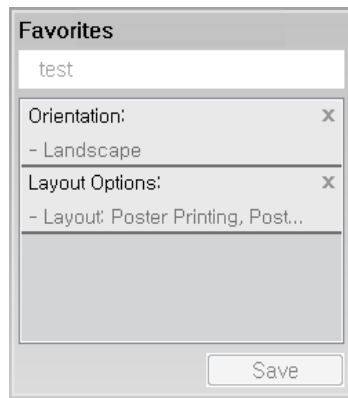

- 3 Click **Save**.

- 4 Enter name and description, and then select the desired icon.
- 5 Click **OK**. When you save **Favorites**, all current driver settings are saved.



To use a saved setting, select it in the **Favorites** tab. The machine is now set to print according to the settings you have selected.

To delete saved settings, select it in the **Favorites** tab and click **Delete**.

Using help

Click the option you want to know on the **Printing Preferences** window and press **F1** on your keyboard.

Basic printing

Eco printing

The **Eco** function reduces toner consumption and paper usage. The **Eco** function allows you to save print resources and lead you to eco-friendly printing.

If you press the **Eco** button from the control panel, Eco mode is enabled. The default setting of Eco mode is double-sided printing (long edge), multiple pages per side (2-up), skip blank pages, and toner save. Some features may not be available depending on the model.



- Double-sided printing (long edge) feature is only available for duplex models (see "Variety feature" on page 10).
- Depending on the printer driver you use, Skip blank pages may not work properly. If Skip blank pages feature does not work properly, set the feature from the Easy Eco Driver (see "Easy Eco Driver" on page 214).

Setting Eco mode on the control panel



- For models that do not have the display screen on the control panel, this feature is not applicable.
- It may be necessary to press **OK** to navigate to lower-level menus for some models.

1 Select  (**Menu**) > **System Setup** > **Eco Setup** on the control panel.

2 Select the option you want and press **OK**.

- **Default Mode:** Select this to turn on or off the eco mode.
 - **Off:** Set the eco mode off.
 - **On:** Set the eco mode on.



If you set the eco mode on with a password from the SyncThru™ Web Service (**Settings** tab > **Machine Settings** > **System** > **Eco Settings**) or Samsung Easy Printer Manager (**Device Settings** > **Eco**), the **On force** message appears. You have to enter the password to change the eco mode status.

- **Change Temp.:** Follow the settings from SyncThru™ Web Service or Samsung Easy Printer Manager. Before you select this item, you must set the eco function in SyncThru™ Web Service (**Settings** tab > **Machine Settings** > **System** > **Eco Settings**) or Samsung Easy Printer Manager (**Device Settings** > **Eco**).
 - **Default Eco:** The machine is set to **Default Eco** mode.
 - **Custom Eco:** Change any necessary values.

3 Press **OK** to save the selection.

Basic printing

Setting eco mode on the driver



To take advantage of the advanced printing features, click **Properties** or **Preferences** from the **Print** window (see "Opening printing preferences" on page 47).

Open the **Eco** tab to set Eco mode. When you see the eco image (), that means the eco mode is currently enabled.

Eco options

- **Printer Default:** Follows the settings from the machine's control panel.
- **None:** Disables Eco mode.
- **Eco Printing:** Enables eco mode. Activate the various Eco items you want to use.
- **Password:** If the administrator fixed to enable the Eco mode, you have to enter the password to change the status.



Password button: You can set from SyncThru™ Web Service (**Settings** tab > **Machine Settings** > **System** > **Eco Settings**) or Samsung Easy Printer Manager (**Device Settings** > **Eco**), the password button is activated. To change the print settings, click on this button, enter the password or need to contact the administrator.

Result simulator

Result Simulator shows the results of reduced emission of carbon dioxide, used electricity, and the amount of saved paper in accordance with the settings you selected.

- The results are calculated on the basis that the total number of printed paper is one hundred without a blank page when the Eco mode is disabled.
- Refers to the calculation coefficient about CO₂, energy, and paper from **IEA**, the index of Ministry of Internal Affairs and Communication of Japan and www.remanufacturing.org.uk. Each model has a different index.
- The power consumption in printing mode refers to the average printing power consumption of this machine.
- The actual amount displayed is only an estimate as the actual amount may differ depending on the operating system used, computing performance, application software, connection method, media type [thickness], media size, job complexity, etc.

Basic printing

Secure printing



- This feature is not supported for M332xND/M382xD.
- Some menus may not appear on the display depending on options or models. If so, it is not applicable to your machine.
- You might not be able to print a complex document using the RAM disk. Install an optional memory to print a complex document.

When you use a printing device in an office, school or other public place, you can protect your personal documents or confidential information by using the secure printing feature.

Starting secure printing from the SyncThru™ Web Service

- 1 Access a web browser, such as Internet Explorer, from Windows.
Enter the machine IP address of your printer (<http://xxx.xxx.xxx.xxx>) in the address field and press the Enter key or click **Go**.
- 2 Click Login on the upper right of SyncThru™ Web Service website.
- 3 **Settings > Machine Settings > System > Ram Disk.**
- 4 Enable **Ram Disk**.



This features may not appear on the display depending on options or models. If so, it is not applicable to your machine.

Printing secure documents from the control panel

- 1 Select **(Menu)** > **Job Management** > **Stored Job** on the printer's control panel.
- 2 Select the document to print.
- 3 Enter the password that you set from the printer driver.
- 4 Print or delete the document.



3. Maintenance

This chapter provides information about purchasing supplies, accessories and maintenance parts available for your machine.

- **Ordering supplies and accessories** 53
- **Available consumables** 54
- **Available accessories** 56
- **Available maintenance parts** 57
- **Storing the toner cartridge** 58
- **Redistributing toner** 60
- **Replacing the toner cartridge** 62
- **Replacing the imaging unit** 65
- **Installing accessories** 67
- **Monitoring the supplies life** 71
- **Setting the toner/imaging unit low alert** 72
- **Cleaning the machine** 73
- **Tips for moving & storing your machine** 77

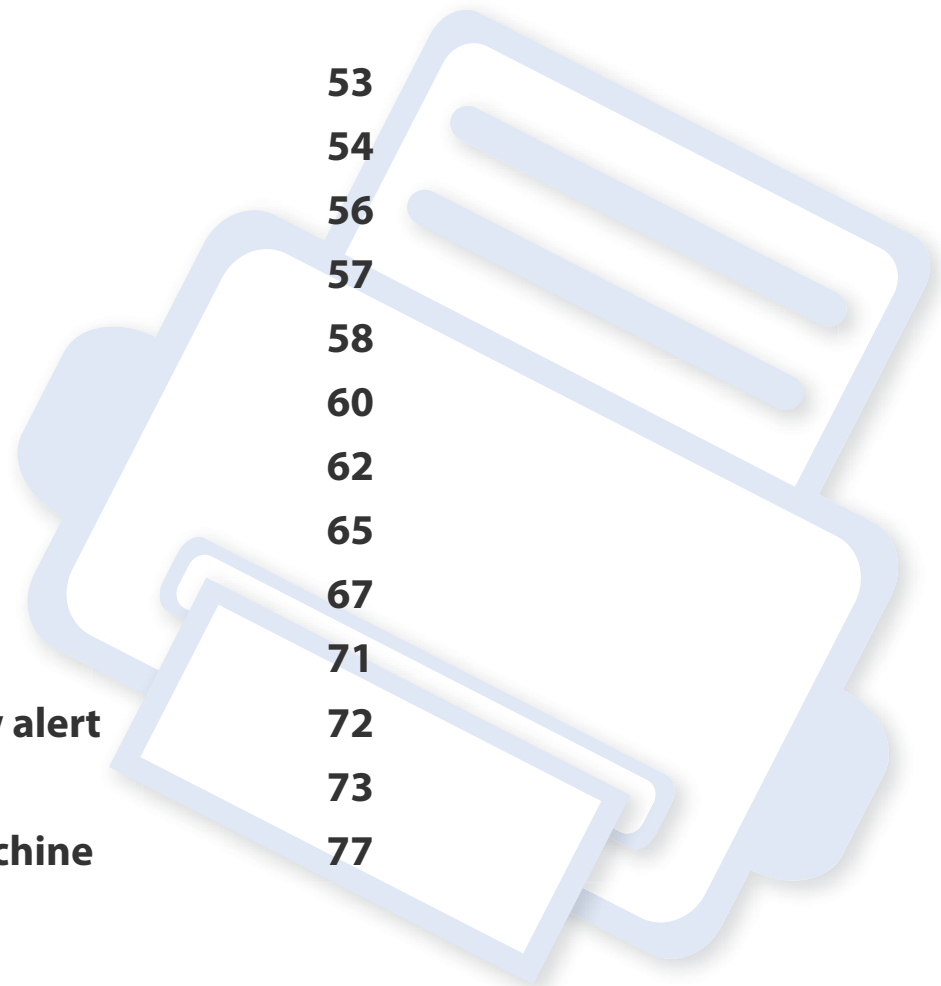

Ordering supplies and accessories



Available accessories may differ from country to country. Contact your sales representatives to obtain the list of available supplies, and maintenance parts (see "Available consumables" on page 54, "Available accessories" on page 56, "Available maintenance parts" on page 57).

To order Samsung-authorized supplies, accessories, and maintenance parts, contact your local Samsung dealer or the retailer where you purchased your machine. You can also visit www.samsung.com/supplies, and then select your country/region to obtain the contact information for service.

Available consumables

When supplies reach the end of their life spans, you can order the followings of consumables for your machine:

Type	Average yield ^a	Part name
Toner cartridge	Approx. 3,000 pages	<ul style="list-style-type: none">• M3320 M3820 M4020 series: MLT-D203S• M3325 M3825 M4025 series: MLT-D204S
	Approx. 5,000 pages	<ul style="list-style-type: none">• M3320 M3820 M4020 series: MLT-D203L• M3325 M3825 M4025 series: MLT-D204L
	Approx. 10,000 pages	<ul style="list-style-type: none">• M3820 M4020 series: MLT-D203E• M3825 M4025 series: MLT-D204E
	Approx. 15,000 pages	<ul style="list-style-type: none">• M4020 series: MLT-D203U• M4025 series: MLT-D204U
Imaging Unit	Approx. 30,000 pages (based on 3 average letter/A4 size pages for print job)	<ul style="list-style-type: none">• M3325 M3825 M4025 series: MLT-R204

a. Declared yield value in accordance with ISO/IEC 19752.



Depending on the options, percentage of image area and job mode used, the toner cartridge's lifespan may differ.



When purchasing new toner cartridges or other consumables, these must be purchased in the same country as the machine you are using. Otherwise, new toner cartridges or other consumables will be incompatible with your machine due to different configurations of toner cartridges and other consumables according to the specific country conditions.

Available consumables



Samsung does not recommend using non-genuine Samsung toner cartridge such as refilled or remanufactured toner. Samsung cannot guarantee non-genuine Samsung toner cartridge's quality. Service or repair required as a result of using non-genuine Samsung toner cartridges will not be covered under the machine's warranty.

Available accessories

You can purchase and install accessories to enhance your machine's performance and capacity.



Some features and optional goods may not be available depending on models or countries (see "Features by models" on page 8).

Accessory	Function	Part name
Memory module^a	Extends your machine's memory capacity.	ML-MEM370: 512 MB
Optional tray^b	If you are experiencing frequent paper supply problems, you can attach an additional 520 ^c sheet tray.	<ul style="list-style-type: none">• SL-SCF3800^d• SL-SCF3805^e
IEEE 1284B parallel Connector^f	Allows you to use various interface.  <ul style="list-style-type: none">• When installing the printer driver with an IEEE1284B parallel connector, the machine might not be found and after installing the printer driver, only basic printing features are available.• If you want to check the machine's status or set the settings, connect the machine to a computer with a USB cable or a network.• If you use the IEEE 1284B parallel connector, you can not use the USB cable.	ML-PAR100

a. Not available for M332xND/382xD

b. Not available for M382xD

c. Plain paper 80 g/m² (20 lb bond).

d. For M3320ND/M3820ND/M3820DW/M4020ND.

e. For M3325ND/M3825ND/M3825DW/M4025ND.

f. To use the optional IEEE 1284B parallel connector, plug it to the UBS port and the 5V output port.

Available maintenance parts

To purchase maintenance parts, contact the source where you bought the machine. Replacing maintenance parts can be performed only by an authorized service provider, dealer, or the retailer where you bought the machine. The warranty does not cover the replacement of any maintenance parts once it has reached its "Average yield".

Maintenance parts are replaced at specific intervals to avoid print quality and paper feed problems resulting from worn parts, see table below. The purpose of which is to maintain your machine in top working condition. The maintenance parts below should be replaced when the life span of each item has been met.

Parts	Average yield^a
Tray 1 roller	Approx. 90,000 pages
Tray 1 retard roller	Approx. 60,000 pages
Tray 2 roller	Approx. 200,000 pages
Tray 2 retard roller	Approx. 100,000 pages
MP roller	Approx. 100,000 pages
MP retard roller	Approx. 80,000 pages
Transfer roller	Approx. 100,000 pages
Fuser unit	Approx. 90,000 pages

a. It will be affected by the operating system used, computing performance, application software, connecting method, media, media size and job complexity.

Storing the toner cartridge

Toner cartridges contain components that are sensitive to light, temperature and humidity. Samsung suggests users follow these recommendations to ensure optimal performance, highest quality, and longest life from your new Samsung toner cartridge.

Store this cartridge in the same environment in which the printer will be used. This should be in controlled temperature and humidity conditions. The toner cartridge should remain in its original and unopened package until installation – if original packaging is not available, cover the top opening of the cartridge with paper and store in a dark cabinet.

Opening the cartridge package prior to use dramatically shortens its useful shelf and operating life. Do not store on the floor. If the toner cartridge is removed from the printer, follow the instructions below to store the toner cartridge properly.

- Store the cartridge inside the protective bag from the original package.
- Store lying flat (not standing on end) with the same side facing up as if it were installed in the machine.
- Do not store consumables in any of the following conditions:
 - Temperature greater than 40°C (104°F).
 - Humidity range less than 20% or greater than 80%.
 - An environment with extreme changes in humidity or temperature.
 - Direct sunlight or room light.
 - Dusty places.
 - A car for a long period of time.
 - An environment where corrosive gases are present.

- An environment with salty air.

Handling instructions

- Do not touch the surface of the photoconductive drum in the cartridge.
- Do not expose the cartridge to unnecessary vibrations or shock.
- Never manually rotate the drum, especially in the reverse direction; this can cause internal damage and toner spillage.

Toner cartridge usage

Samsung Electronics does not recommend or approve the use of non-Samsung brand toner cartridges in your printer including generic, store brand, refilled, or remanufactured toner cartridges.



Samsung's printer warranty does not cover damage to the machine caused by the use of a refilled, remanufactured, or non-Samsung brand toner cartridges.

Storing the toner cartridge

Estimated cartridge life

Estimated cartridge life (the life of the toner cartridge yield) depends on the amount of toner that print jobs require. The actual print yield may vary depending on the print density of the pages you print on, operating environment, percentage of image area, printing interval, media type and/or media size. For example, if you print a lot of graphics, the consumption of the toner is higher and you may need to change the cartridge more often.

Redistributing toner

When the toner cartridge is near the end of its life:

- White streaks or light printing occurs and/or density variation side to side.
- The **Status** LED blinks red. The toner-related message saying that the toner is low may appear on the display.

If this happens, you can temporarily improve print quality by redistributing the remaining toner in the cartridge. In some cases, white streaks or light printing will still occur even after you have redistributed the toner. Replace the toner cartridge (see "Available consumables" on page 54).



Illustrations on this user's guide may differ from your machine depending on its options or models.



- To prevent damage to the toner cartridge, do not expose it to light for more than a few minutes. Cover it with a piece of paper, if necessary.
- Do not touch the green area of the toner cartridge. Use the handle on the cartridge to avoid touching this area.
- Do not use sharp objects such as a knife or scissors to open the toner cartridge package. They might scratch the drum of the cartridge.
- If toner gets on your clothing, wipe it off with a dry cloth and wash clothing in cold water. Hot water sets toner into fabric.

Redistributing toner

M3320/M3820/M4020 series

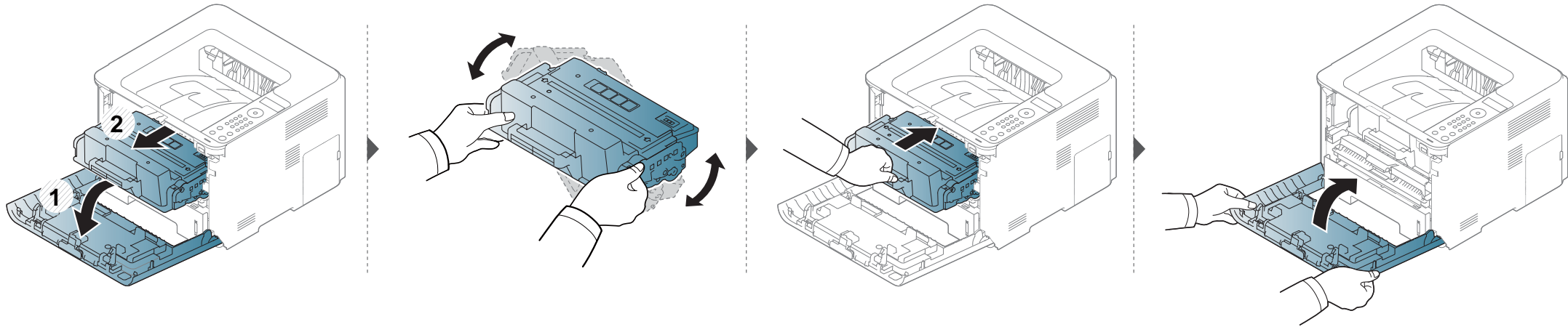

M3325/M3825/M4025 series

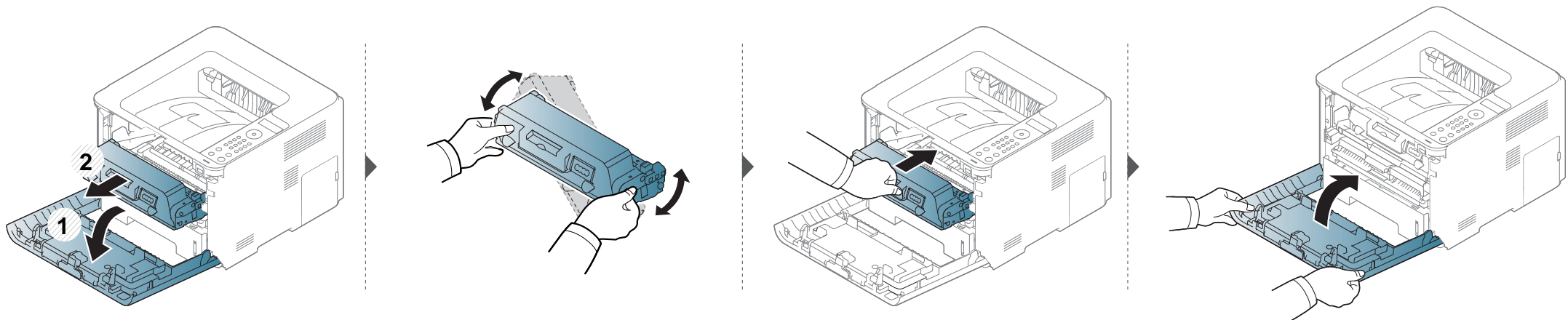

Replacing the toner cartridge

A toner cartridge has almost reached its estimated cartridge life:

- The status LED and the toner-related message on the display indicate when the toner cartridge should be replaced.
- The computer's Samsung Printing Status Program window appears on the computer telling you when the cartridge is empty (see "Using Samsung Printer Status" on page 222).



- Shake the toner cartridge thoroughly, it will increase the initial print quality.
- Illustrations on this user's guide may differ from your machine depending on its options or models. Check your machine type (see "Front view" on page 20).



- To prevent damage to the toner cartridge, do not expose it to light for more than a few minutes. Cover it with a piece of paper, if necessary.
- Do not touch the green area of the toner cartridge. Use the handle on the cartridge to avoid touching this area.
- Do not use sharp objects such as a knife or scissors to open the toner cartridge package. They might scratch the drum of the cartridge.
- If toner gets on your clothing, wipe it off with a dry cloth and wash clothing in cold water. Hot water sets toner into fabric.

Toner cartridge

When a toner cartridge has reached the end of life, the machine will stop printing.

Replacing the toner cartridge

M3320 M3820 M4020 series

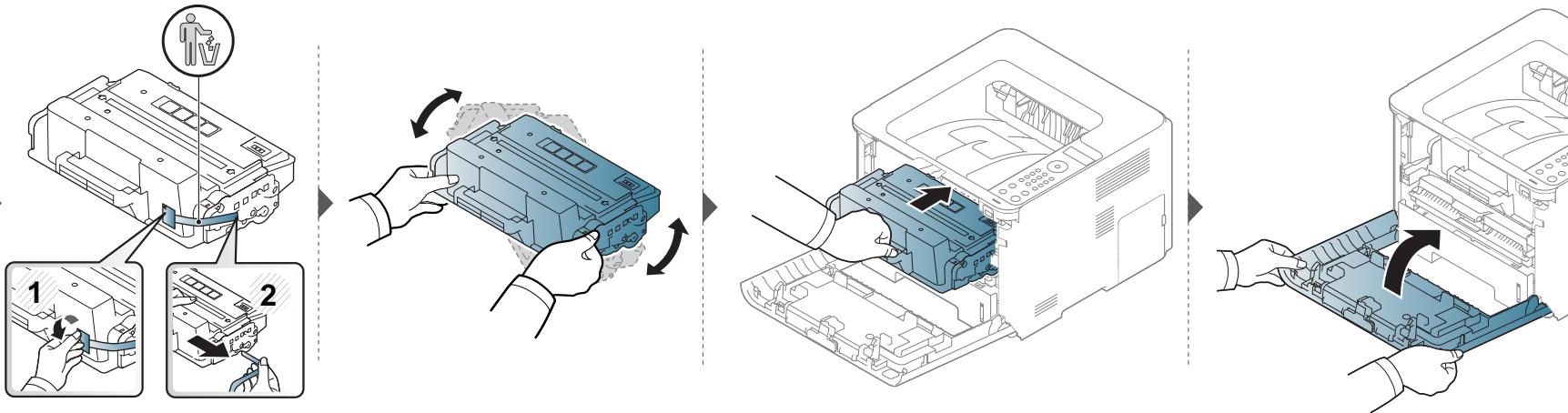
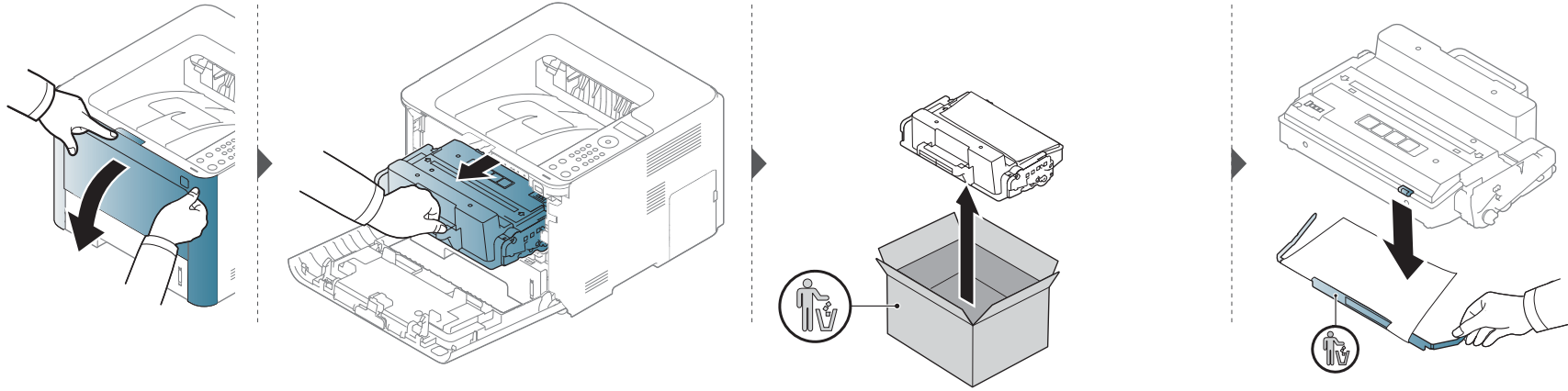

Replacing the toner cartridge

M3325 M3825 M4025 series

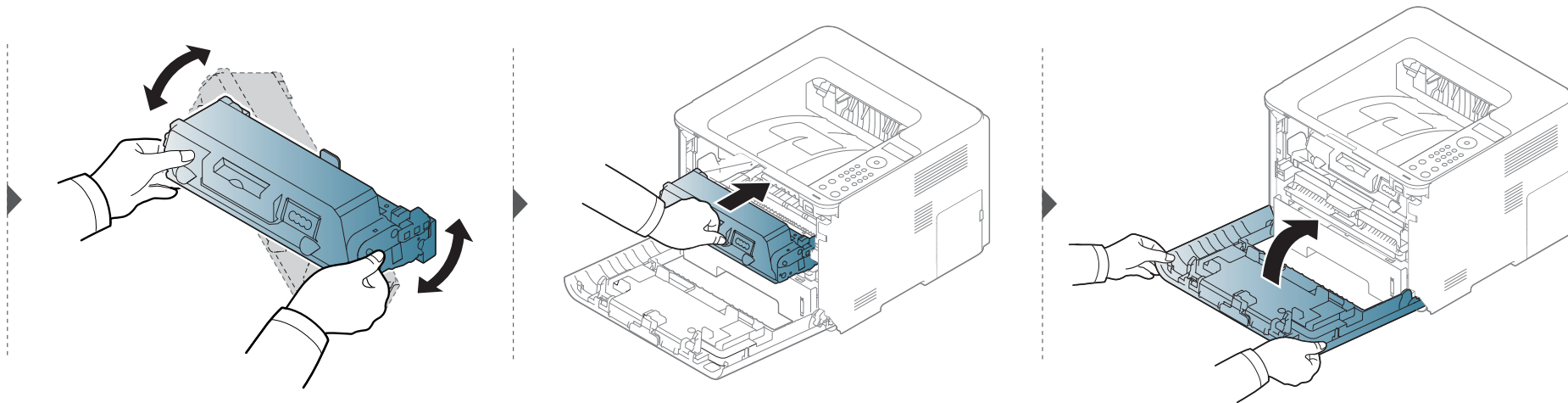
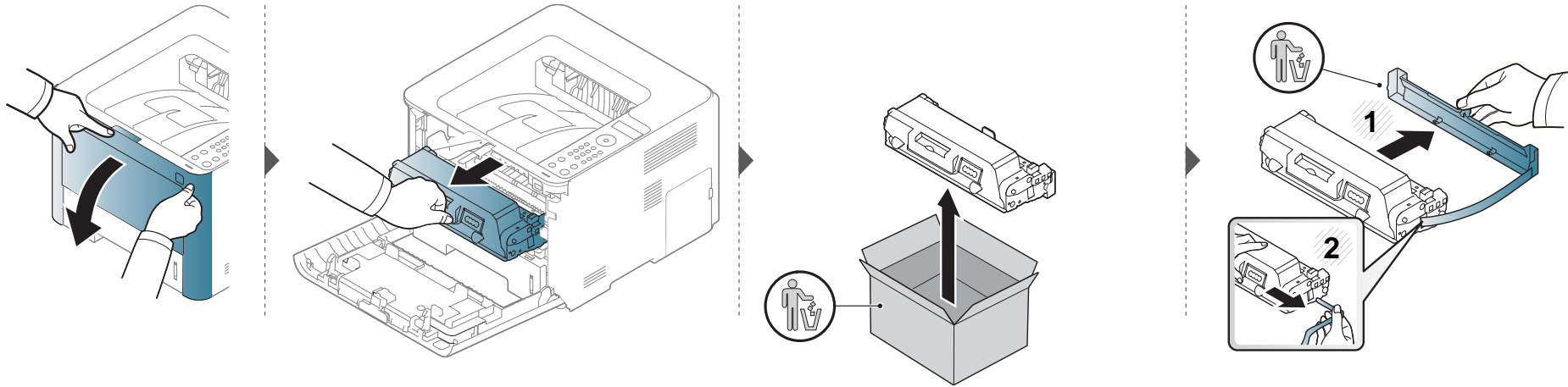

Replacing the imaging unit

When a imaging unit has reached the end of life, the machine will stop printing.



- Do not use sharp objects such as a knife or scissors to open the toner cartridge package. They might scratch the drum of the cartridge.
- If toner gets on your clothing, wipe it off with a dry cloth and wash clothing in cold water. Hot water sets toner into fabric.

Replacing the imaging unit

Imaging unit

M3325/M3825/M4025 series

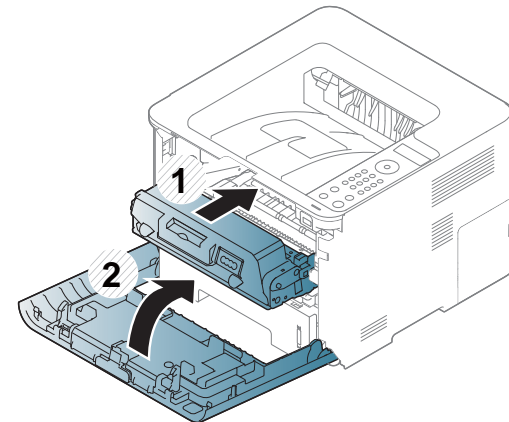
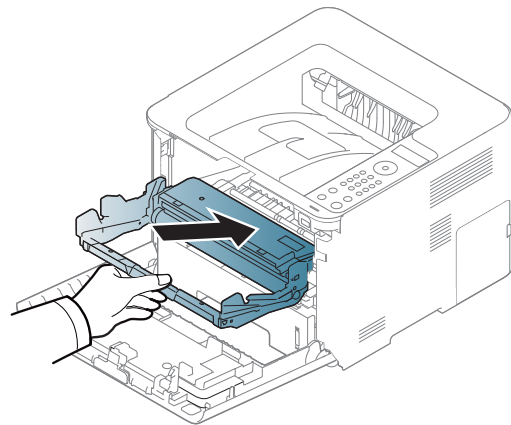
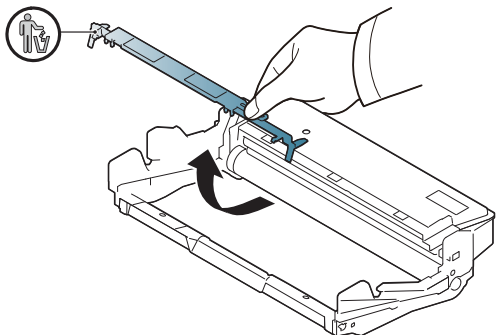
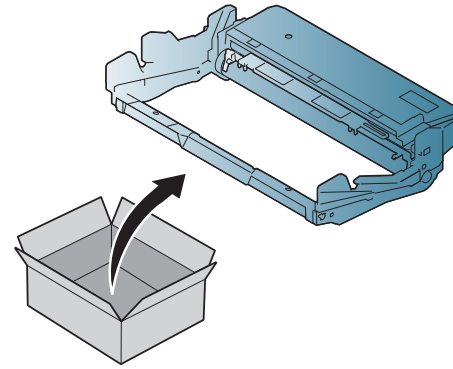
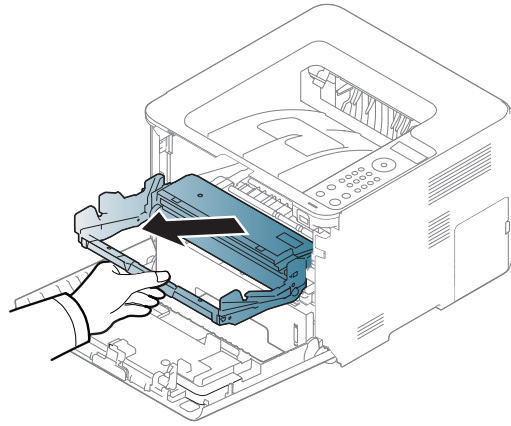
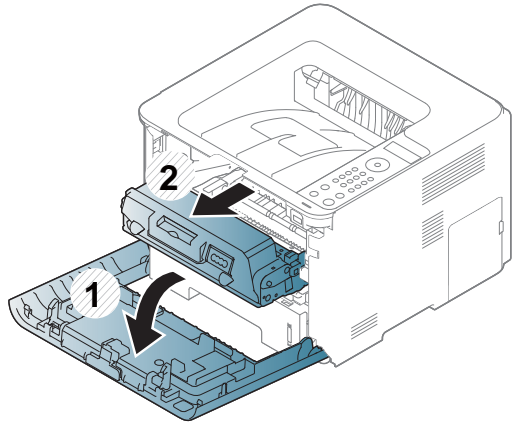

Installing accessories

Precautions

- Disconnect the power cord
Never remove the control board cover while the power is turned on.
To avoid the possibility of an electrical shock, always disconnect the power cord when installing or removing ANY internal or external accessories.
- Discharge static electricity
The control board and internal accessories (network interface card or memory module) are sensitive to static electricity. Before installing or removing any internal accessories, discharge static electricity from your body by touching something metal, such as the metal back plate on any device plugged into a grounded power source. If you walk around before finishing the installation, repeat this procedure to discharge any static electricity again.



When installing accessories, the battery inside the machine is a service component. Do not change it by yourself. There is a risk of an explosion if battery is replaced by an incorrect type. Dispose used batteries according to the instructions.

Setting Device Options

When you install the optional devices such as optional tray, memory, etc, this machine automatically detects and sets the optional devices. If you cannot use the optional devices you installed in this driver, you need to set the optional devices in **Device Options**.

- 1 Click the Windows **Start** menu.
 - For Windows 8, from the **Charms**, select **Search > Settings**.
- 2 For Windows XP/2003, select **Printers and Faxes**.
 - For Windows 2008/Vista, select **Control Panel > Hardware and Sound > Printers**.
 - For Windows 7, select **Control Panel > Hardware and Sound > Devices and Printers**.
 - For Windows 8, search for **Devices and Printers**.
 - For Windows Server 2008 R2, select **Control Panel > Hardware > Devices and Printers**.
- 3 Right-click your machine.
- 4 For Windows XP/2003/2008/Vista, press **Properties**.
For Windows 7, Windows 8, and Windows Server 2008 R2, from context menus, select the **Printer properties**.

Installing accessories



If **Printer properties** item has ► mark, you can select other printer drivers connected with selected printer.

5

Select **Device Options**.



The **Properties** window may differ depending on the driver or operating system you are using.

6

Select the appropriate option.



Some menus may not appear in the display depending on options or models. If so, it is not applicable to your machine.

- **Tray Options:** Select the optional tray you installed. You can select the tray.
- **Storage Options:** Select the optional memory you installed. If this feature is checked, you can select the **Print Mode**.
- **Printer Configuration:** Select the printer language for the print job.
- **Administrator Settings:** You can select the **Printer Status** and **EMF Spooling**.

- **Admin Job Accounting:** Allows you to associate user and account identification information with each document you print.
 - **User permission:** If you check this option, only users with user permission can start a print job.
 - **Group permission:** If you check this option, only groups with group permission can start a print job.



If you want to encrypt job accounting password, check **Job Accounting Password Encryption**.

- **Custom Paper Size Settings:** You can specify custom paper size.

7

Click **OK** until you exit the **Properties** or **Printer properties** window.

Installing accessories

Upgrading a memory module

Your machine has a dual in-line memory module (DIMM). Use this memory module slot to install additional memory. We recommend the use of only genuine Samsung DIMM's. You may void your warranty if it is determined that your machine problem is being caused by third party DIMM's.

The order information is provided for optional accessories (see "Available accessories" on page 56).



- After installing the optional memory, you can use the advanced printing features, such as proofing a job and specifying of printing a secure print job in the printer properties window. You can control the active job queue and file policy in **Job Management** menu (see "Using optional device features" on page 208).
- Not supported for M332xND/M3825D.

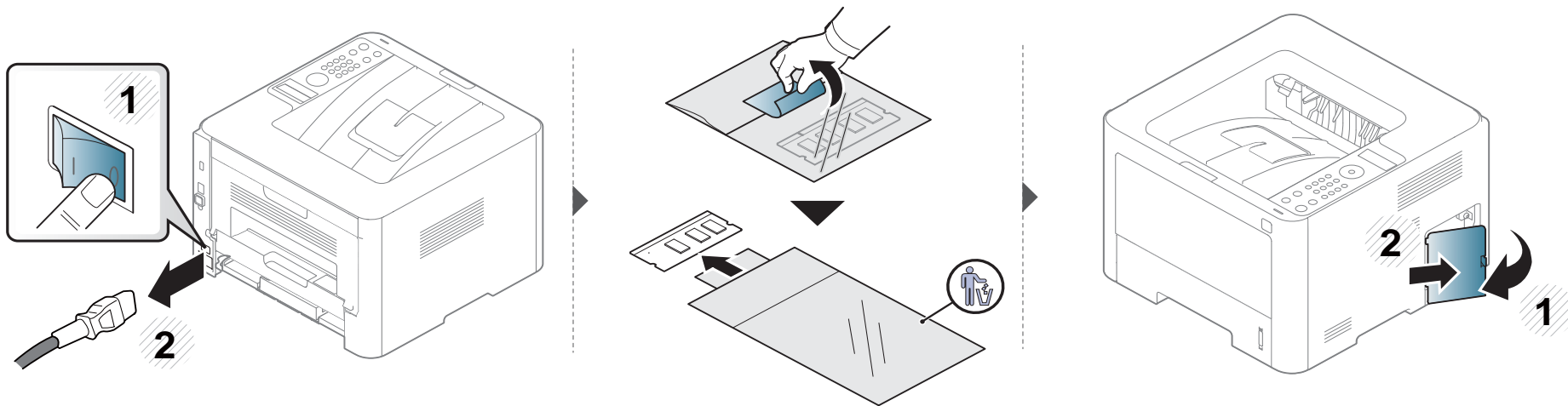

Installing accessories

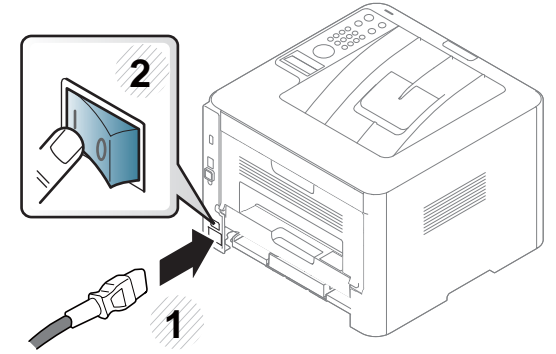
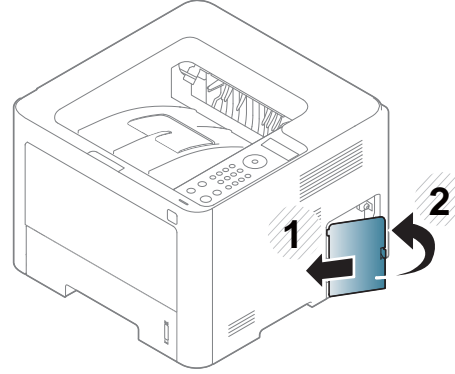
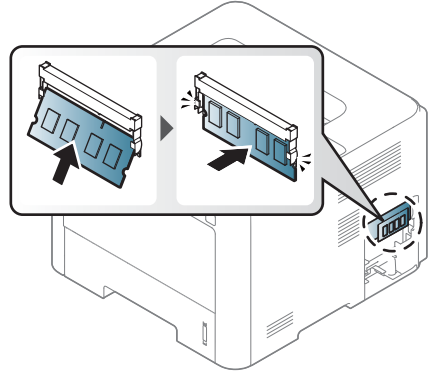
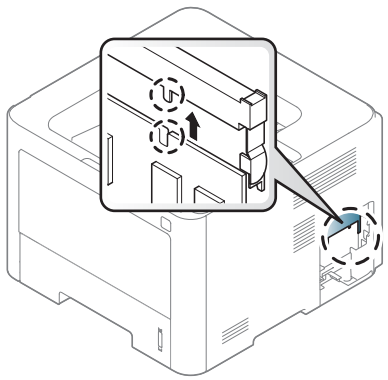



Monitoring the supplies life

If you experience frequent paper jams or printing problems, check the number of pages the machine has printed or scanned. Replace the corresponding parts, if necessary.



- For models that do not support the display screen: In ready mode, press and hold  (**Cancel**) button for about 6 seconds, then release. A supplied Information report prints out.
- It may be necessary to press **OK** to navigate to lower-level menus for some models.

- 1** Select  (**Menu**) > **System Setup** > **Maintenance** > **Supplies Life** on the control panel.
- 2** Select the option you want and press **OK**.
- 3** Press  (**Cancel**) to return to ready mode.

Setting the toner/imaging unit low alert

If the amount of toner in the cartridge is low, a message or LED informing the user to change the toner cartridge appears. You can set the option for whether or not this message or LED appears.



For models that do not support the display screen on the control panel, you can set the machine's settings by using the **Device Settings** in Samsung Easy Printer Manager program.

- For Windows and Mac users, you set from **Samsung Easy Printer Manager** >  **(Switch to advanced mode)** > **Device Settings**, see "Device Settings" on page 221.

- 1 Select  **(Menu)** > **System Setup** > **Maintenance** > **TonerLow Alert** or **ImgU.Low Alert on** the control panel.
- 2 Select the option you want.
- 3 Press **OK** to save the selection.

Cleaning the machine

If printing quality problems occur or if you use your machine in a dusty environment, you need to clean your machine regularly to keep it in the best printing condition and use your machine longer.



- Cleaning the cabinet of the machine with cleaning materials containing large amounts of alcohol, solvents, or other strong substances can discolor or distort the cabinet.
- If your machine or the surrounding area is contaminated with toner, we recommend you use a cloth or tissue dampened with water to clean it. If you use a vacuum cleaner, toner blows in the air and might be harmful to you.

Cleaning the outside

Clean the machine cabinet with a soft, lint-free cloth. Dampen the cloth slightly with water, but be careful not to let any water drip onto or into the machine.

Cleaning the machine

Cleaning the inside

During the printing process, paper, toner, and dust particles can accumulate inside the machine. This buildup can cause print quality problems, such as toner specks or smearing. Cleaning the inside of the machine clears and reduces these problems.



- To prevent damage to the toner cartridge, do not expose it to light for more than a few minutes. Cover it with a piece of paper, if necessary.
- Do not touch the green area of the toner cartridge. Use the handle on the cartridge to avoid touching this area.
- Use a dry lint free cloth when cleaning the inside of the machine, be careful not to damage the transfer roller or any other inside parts. Do not use solvents such as benzene or thinner. Printing quality problems can occur and cause damage to the machine.



- Use a dry lint-free cloth to clean the machine.
- Turn the machine off and unplug the power cord. Wait for the machine to cool down. If your machine has a power switch, turn the power switch off before cleaning the machine.
- Illustrations on this user's guide may differ from your machine depending on its options or models. Check your machine type (see "Front view" on page 20).

Cleaning the machine

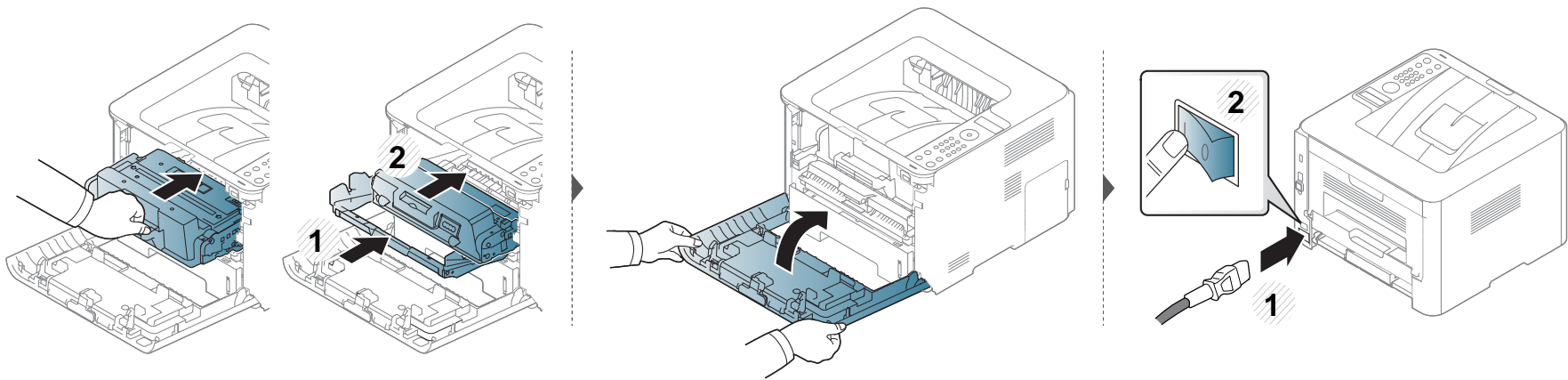
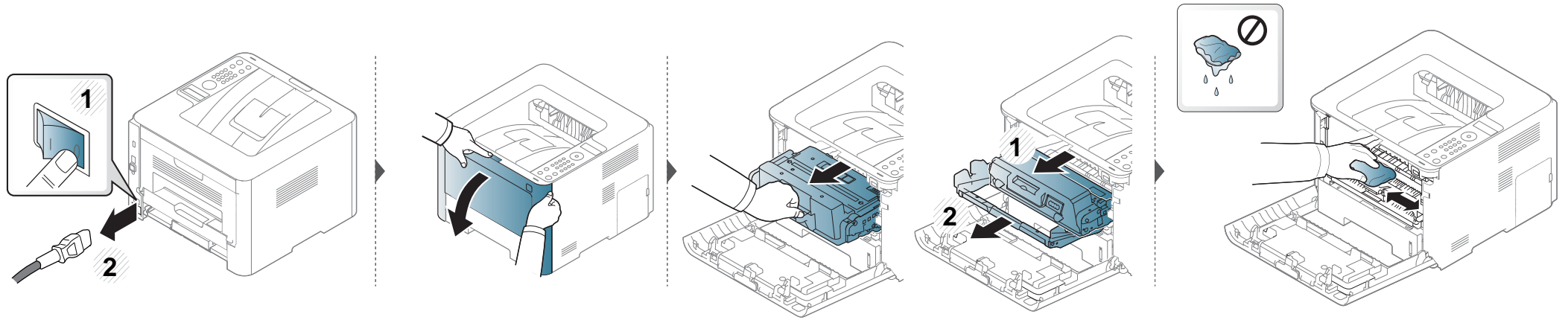

Cleaning the machine

Cleaning the pickup roller



- Turn the machine off and unplug the power cord. Wait for the machine to cool down. If your machine has a power switch, turn the power switch off before cleaning the machine.
- Illustrations on this user's guide may differ from your machine depending on its options or models. Check your machine type (see "Front view" on page 20).

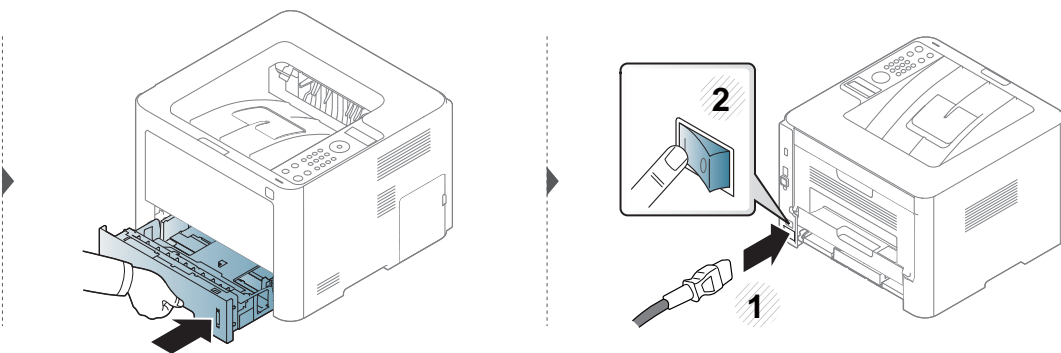
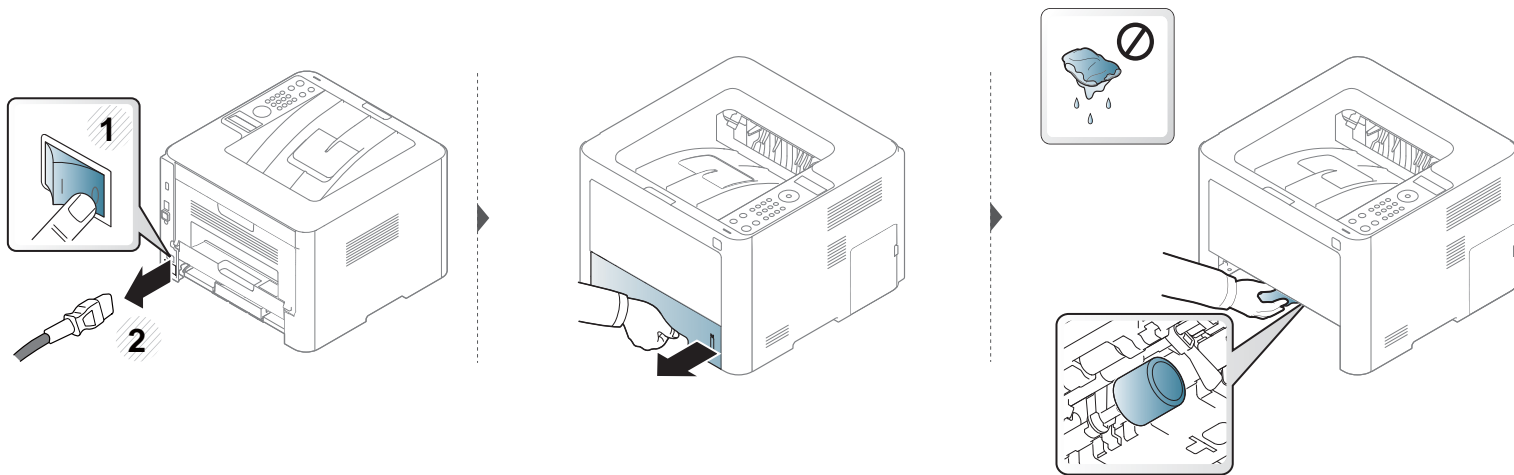

Tips for moving & storing your machine

- When moving the machine, do not tilt or turn it upside down. Otherwise, the inside of the machine may be contaminated by toner, which can cause damage to the machine or reduce print quality.
- When moving the machine, make sure at least two people are holding the machine securely.



4. Troubleshooting

This chapter gives helpful information for what to do if you encounter an error.

- **Tips for avoiding paper jams** 79
- **Clearing paper jams** 80
- **Understanding the status LED** 92
- **Understanding display messages** 95



This chapter gives helpful information for what to do if you encounter an error. If your machine has a display screen, check the message on the display screen first to solve the error.

If you cannot find a solution to your problem in this chapter, refer to the **Troubleshooting** chapter in the Advanced Guide (see "Troubleshooting" on page 234).

If you cannot find a solution in the User's Guide or the problem persists, call for service.

Tips for avoiding paper jams

By selecting the correct medias, most paper jams can be avoided. To avoid paper jams, refer to the following guidelines:

- Ensure that the adjustable guides are positioned correctly (see "Tray overview" on page 35).
- Do not remove paper from the tray while your machine is printing.
- Flex, fan, and straighten paper before loading.
- Do not use creased, damp, or highly curled paper.
- Do not mix papers in a tray.
- Use only recommended print media (see "Print media specifications" on page 103).

Clearing paper jams

 To avoid tearing the paper, pull the jammed paper out slowly and gently.

In tray 1

 Illustrations on this user's guide may differ from your machine depending on its options or models. Check your machine type (see "Front view" on page 20).

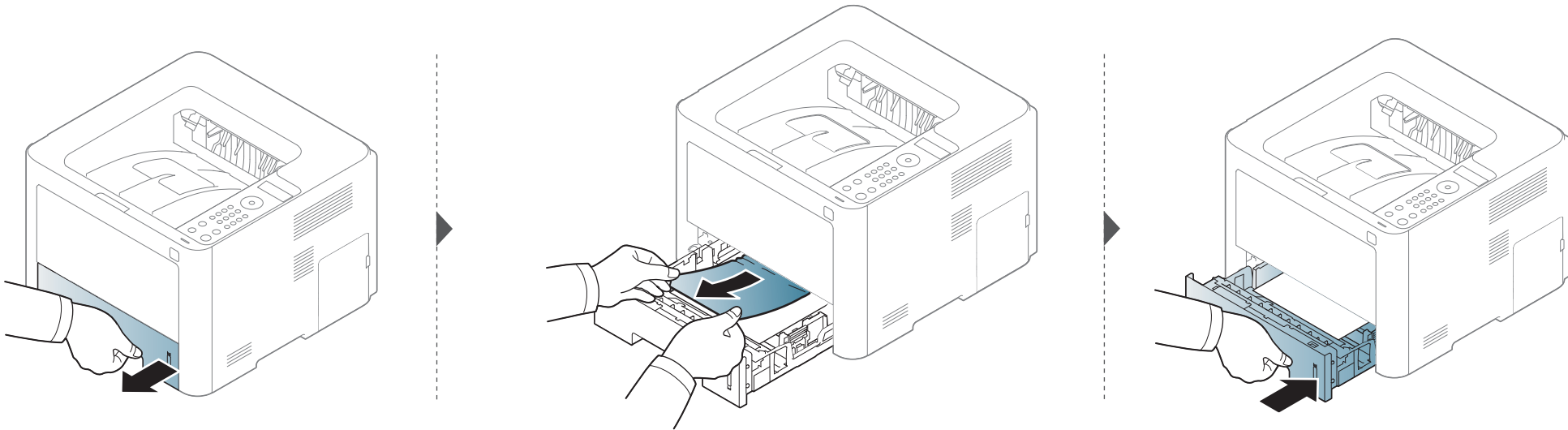

Clearing paper jams

In optional tray

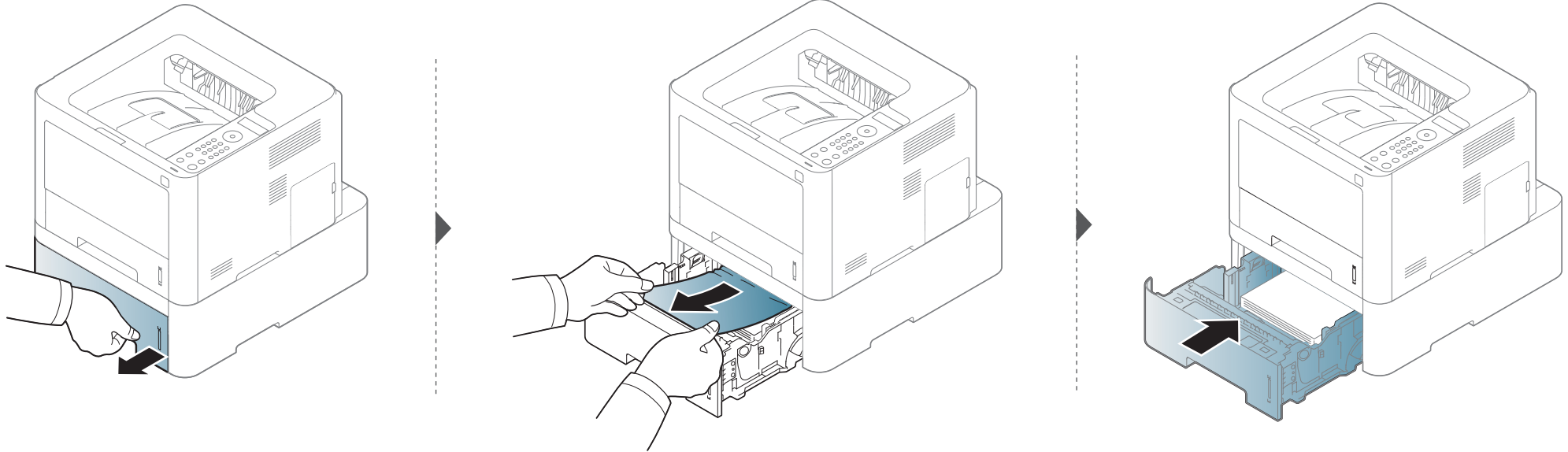

Clearing paper jams

If you do not see the paper in this area, stop and go to next step:

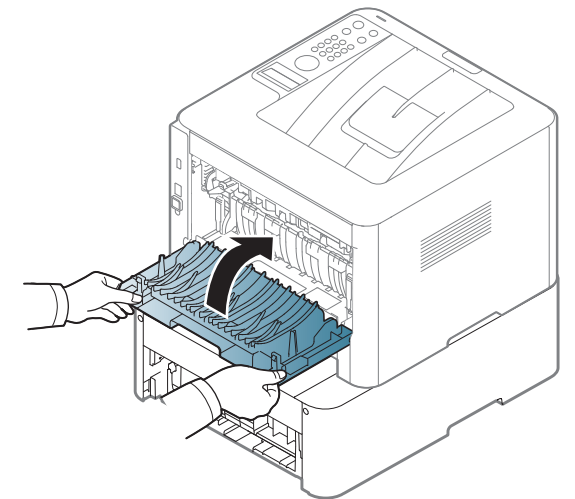
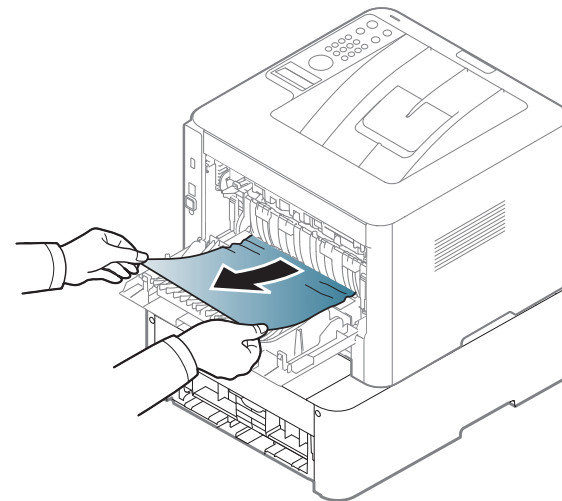
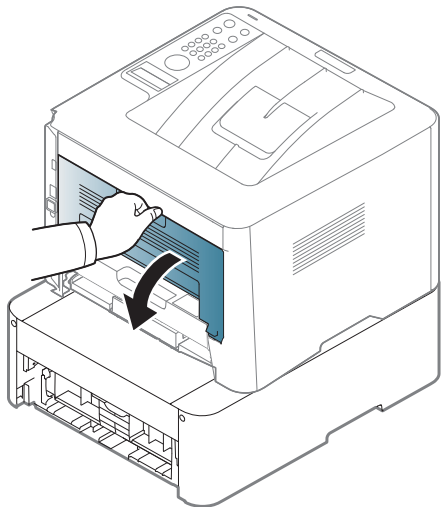
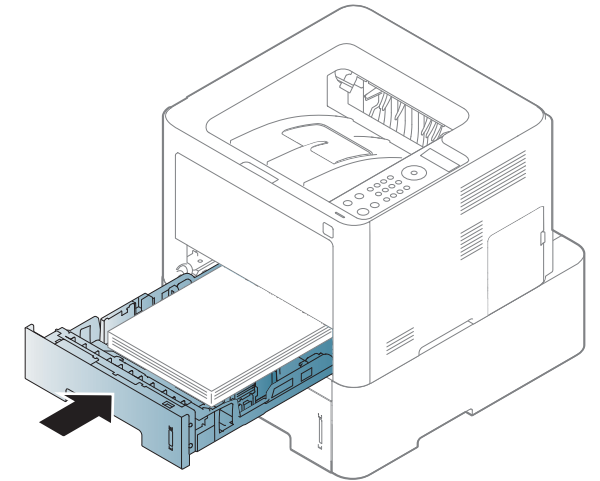
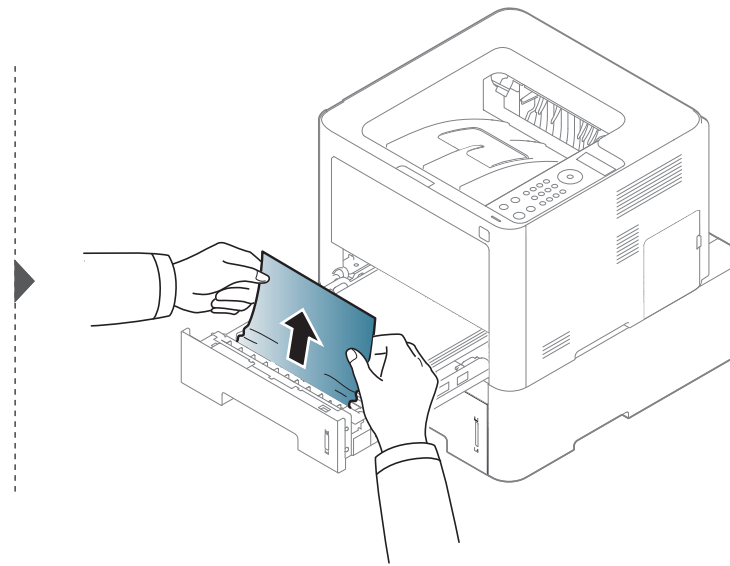
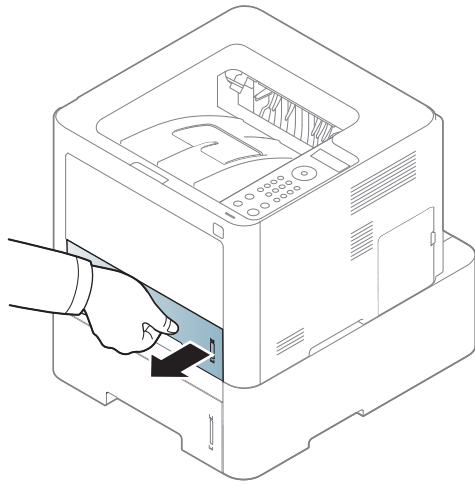

Clearing paper jams

In the manual feeder/multi-purpose tray

M332xND/M382xD series

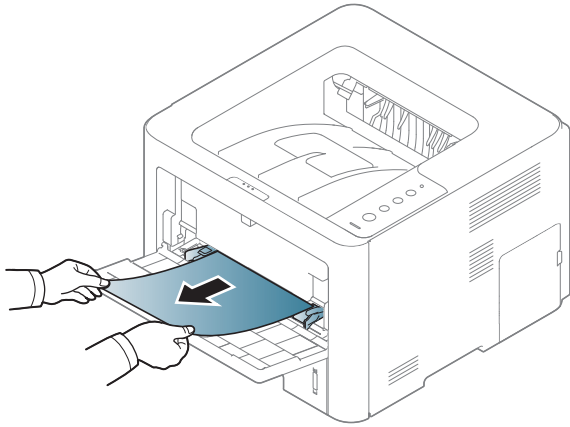

Clearing paper jams

M382xND/M382xDW/M402xND series

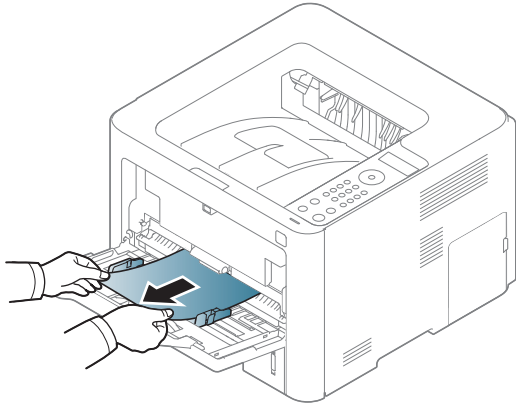

Clearing paper jams

Inside the machine



The fuser area is hot. Take care when removing paper from the machine.

Clearing paper jams

M3320/M3820/M4020 series

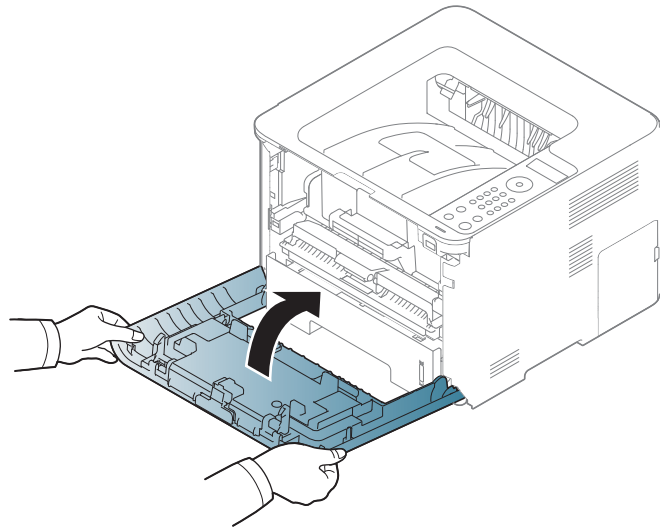
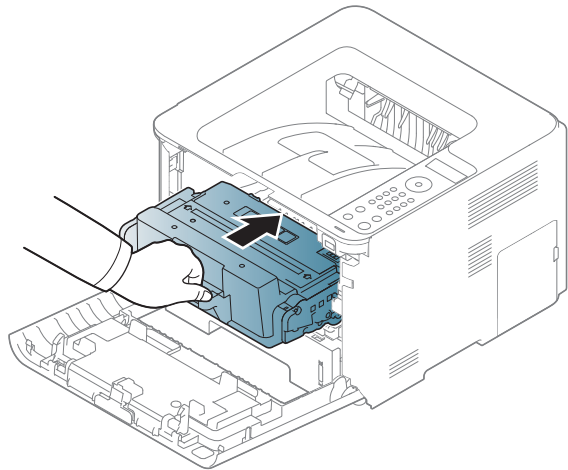
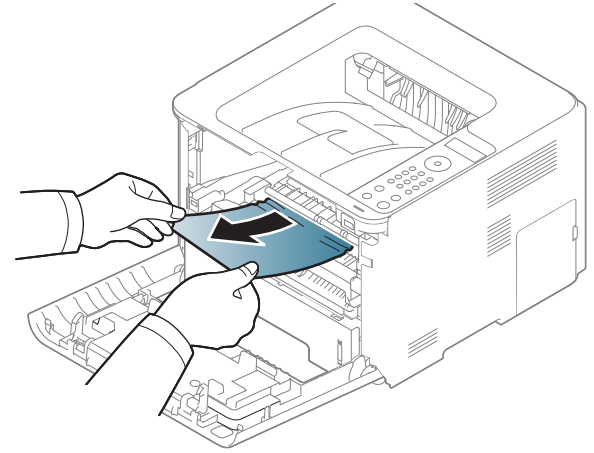
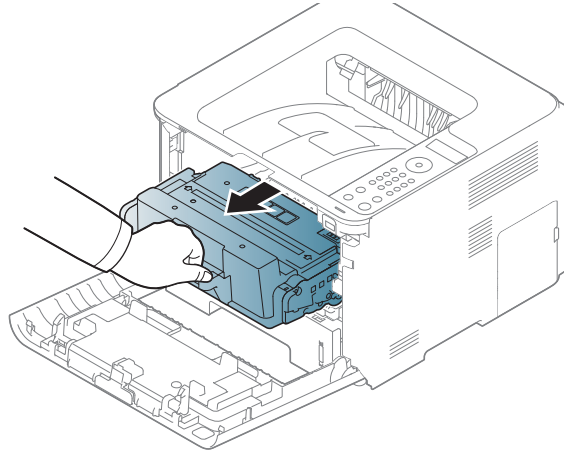
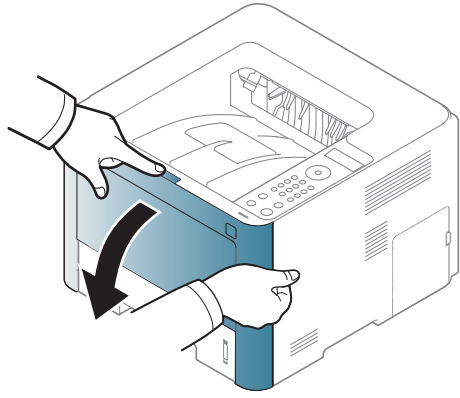

Clearing paper jams

M3325/M3825/M4025 series

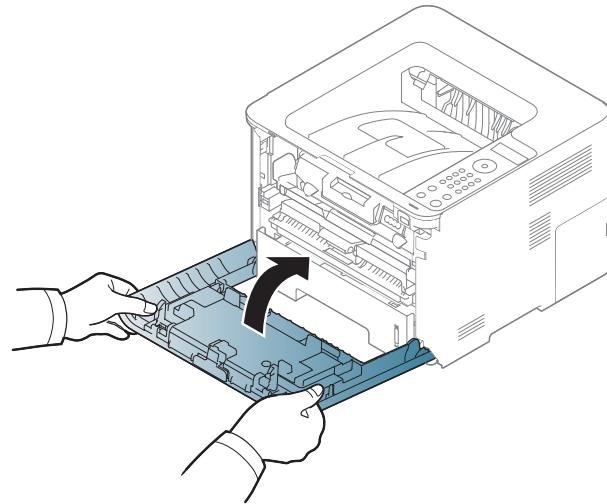
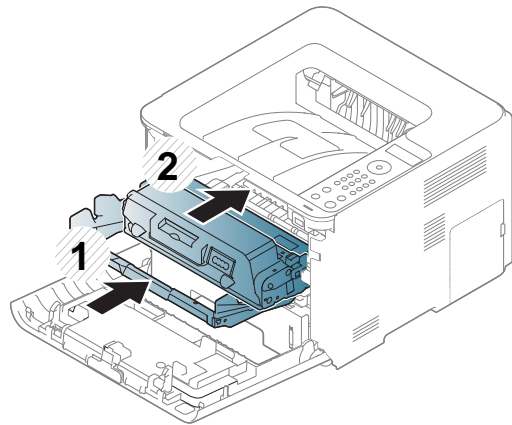
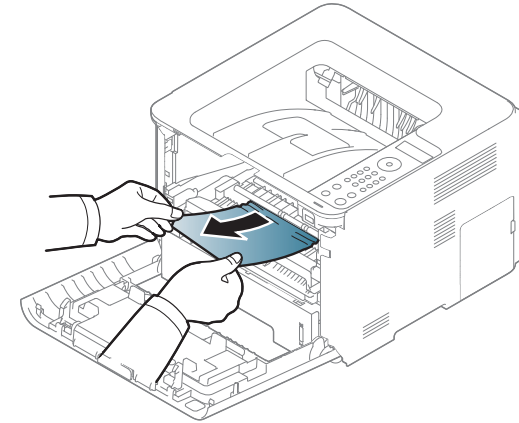
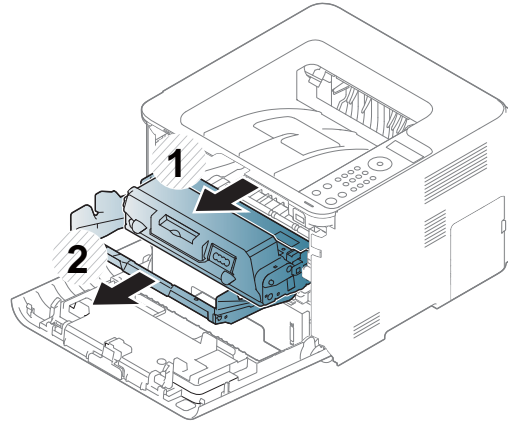
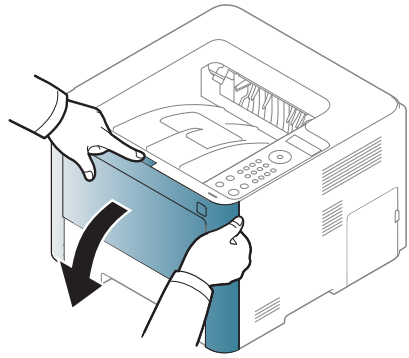

Clearing paper jams

In exit area



The fuser area is hot. Take care when removing paper from the machine.

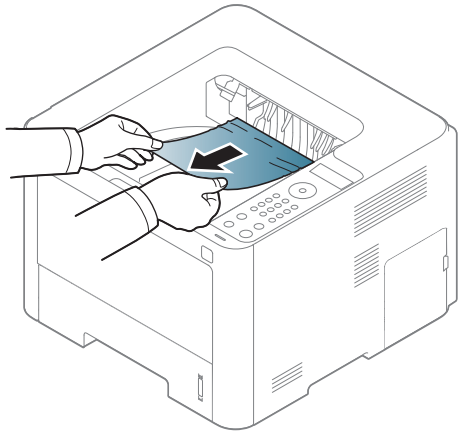

Clearing paper jams

If you do not see the paper in this area, stop and go to next step:

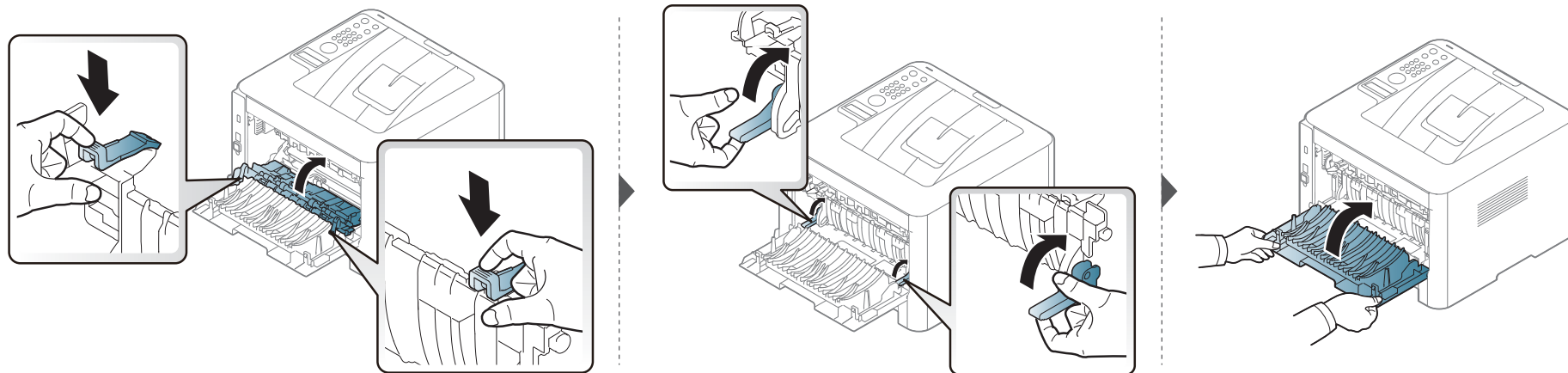
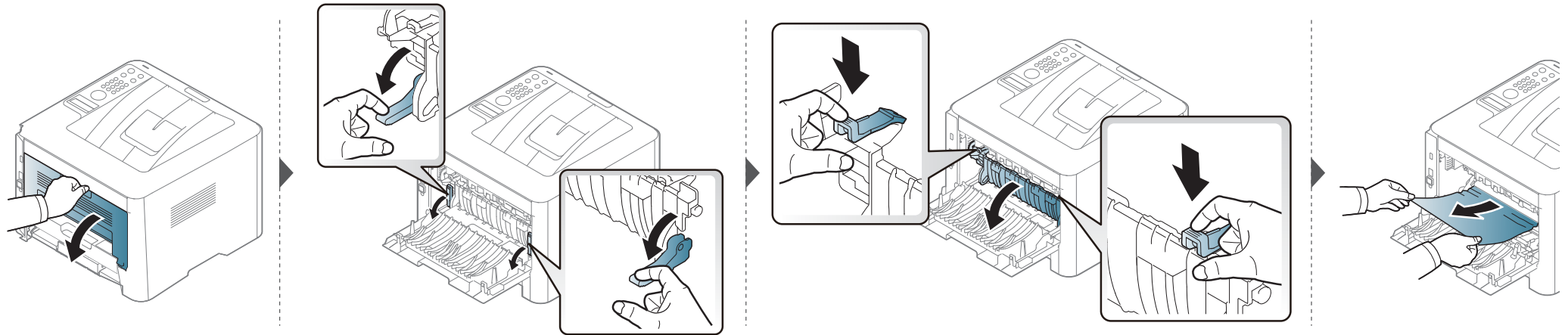

Clearing paper jams

In the duplex unit area

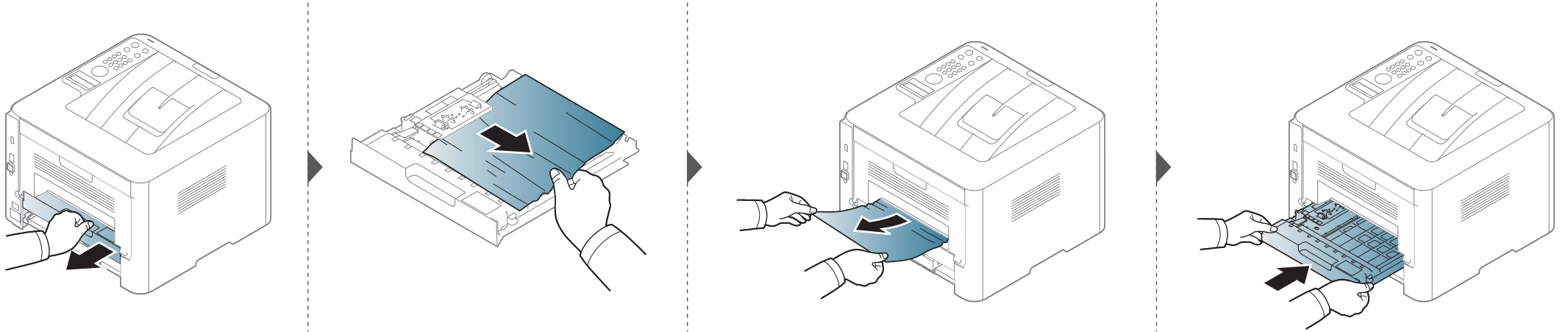

Clearing paper jams

If you do not see the paper in this area, stop and go to next step:

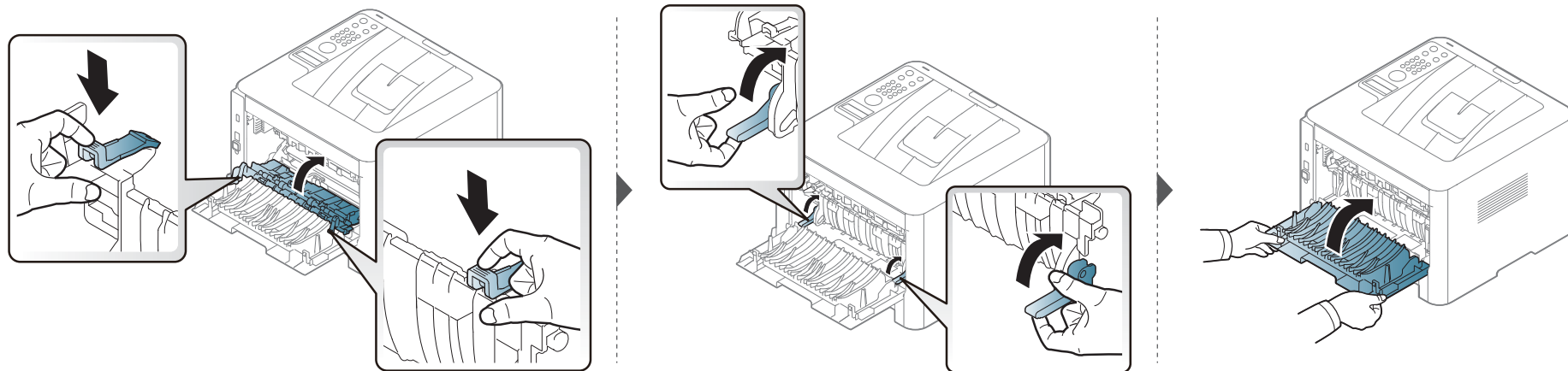
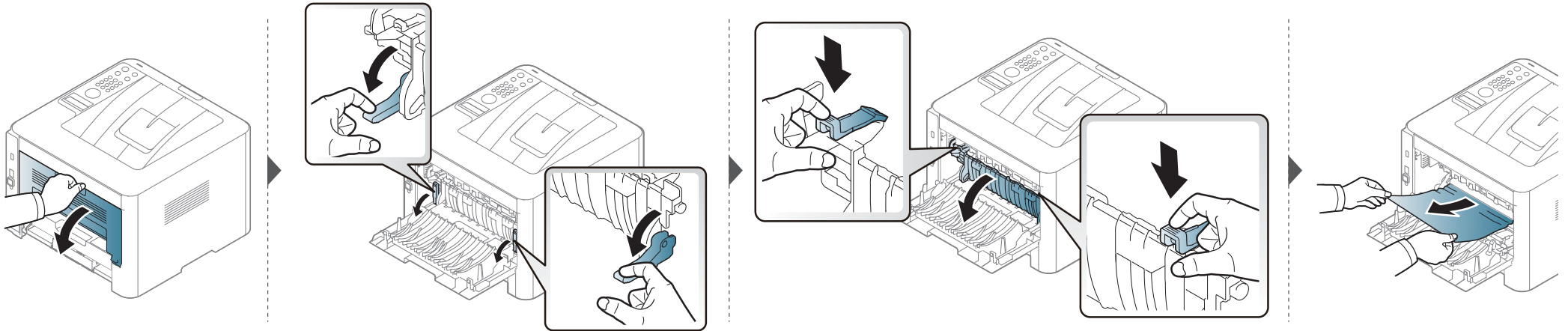



Understanding the status LED

The color of the LED indicates the machine's current status.



- Some LEDs may not be available depending on model or country (see "Control panel overview" on page 22).
- To resolve the error, look at the error message and its instructions from the troubleshooting part (see "Understanding display messages" on page 95).
- You also can resolve the error with the guideline from the computers's Samsung Printing Status program window (see "Using Samsung Printer Status" on page 222).
- If the problem persists, call a service representative.

Understanding the status LED

LED	Status	Description	
 Status	Off	The machine is off-line.	
	Green	Blinking	When the backlight blinks, the machine is receiving or printing data.
		On	<ul style="list-style-type: none"> The machine is on-line and can be used.
	Red	Blinking	<ul style="list-style-type: none"> A minor error has occurred and the machine is waiting for the error to be cleared. For models that supports display screen on the control panel, check the display message. When the problem is cleared, the machine resumes. Small amount of toner is left in the cartridge. The estimated cartridge life^a of toner is close. Prepare a new cartridge for replacement. You may temporarily increase the printing quality by redistributing the toner (see "Redistributing toner" on page 60).^b
		On	<ul style="list-style-type: none"> A toner cartridge has almost reached its estimated cartridge life^a. It is recommended to replace the toner cartridge (see "Replacing the toner cartridge" on page 62). The cover is opened. Close the cover. There is no paper in the tray when receiving or printing data. Load paper in the tray. The machine has stopped due to a major error. Check the display message (see "Understanding display messages" on page 95). A paper jam has occurred (see "Clearing paper jams" on page 80). An imaging unit has almost reached its estimated cartridge life^c. It is recommended to replace the toner cartridge.
 WPS^b	Blue	Blinking	The machine is attempting to connect to a wireless network.
		On	The machine is connected to a wireless network (see "Wireless network setup" on page 145).
		Off	The machine is disconnected from a wireless network.
 Power	Blue	On	The machine is in power save mode.
		Off	The machine is in ready mode or machine's power is off.

Understanding the status LED

LED	Status	Description	
Eco	Green	On	Eco mode is on (see "Eco printing" on page 49).
		Off	Eco mode is off.

- a. Estimated cartridge life means the expected or estimated toner cartridge life, which indicates the average capacity of print-outs and is designed pursuant to ISO/IEC 19798. The number of pages may be affected by operating environment, percentage of image area, printing interval, graphics, media and media size. Some amount of toner may remain in the cartridge even when red LED is on and the printer stops printing.
- b. Some LEDs may not be available depending on model or country (see "Control panel overview" on page 22).
- c. When the imaging unit has reached its end of life, the machine will stop printing. In this case, you can choose to stop or continue printing from the SyncThru™ Web Service (**Settings > Machine Settings > System > Setup > Supplies Management > Imaging Unit Stop**) or Samsung Easy Printer Manager (**Device Settings > System > Supplies Management > Imaging Unit Stop**). Turning off this option and continuing to print may damage the device's system.

Understanding display messages

Messages appear on the control panel display to indicate the machine's status or errors. Refer to the tables below to understand the messages' and their meaning, and correct the problem, if necessary.



- You can resolve the error with the guideline from the computer's Printing Status program window (see "Using Samsung Printer Status" on page 222).
- If a message is not in the table, reboot the power and try the printing job again. If the problem persists, call a service representative.
- When you call for service, provide the service representative with the contents of display message.
- Some messages may not appear on the display depending on the options or models.
- [error number] indicates the error number.
- [tray type] indicates the tray number.
- [media type] indicates the media type.
- [media size] indicates the media size.

Paper Jam-related messages

Message	Meaning	Suggested solutions
Paper jam in exit area	Paper has jammed in the exit area.	Clear the jam (see "In exit area" on page 88).

Message	Meaning	Suggested solutions
Paper jam inside of duplex	Paper has jammed during duplex printing. This is applicable only to machines with this feature.	Clear the jam (see "In the duplex unit area" on page 90).
Paper jam inside machine	Paper has jammed in inside the machine.	Clear the jam (see "Inside the machine" on page 85).
Paper jam in tray 1	Paper has jammed in the tray.	Clear the jam (see "In tray 1" on page 80).
Paper jam in tray 2	Paper has jammed in the optional tray.	Clear the jam (see "In optional tray" on page 81).
Paper jam in MP tray	Paper has jammed in the multi-purpose tray.	Clear the jam (see "In the manual feeder/ multi-purpose tray" on page 83).

Understanding display messages

Toner-related messages

Message	Meaning	Suggested solutions
Install toner	A toner cartridge is not installed.	Reinstall the toner cartridge.
	A toner cartridge is not being detected	Reinstall the toner cartridge two or three times to confirm it is seated properly. If the problem persists, contact the service representatives.
	Not removed protective film from toner.	Remove the protective film from the toner cartridge.
Not Compatible Toner cartridge	The indicated toner cartridge is not suitable for your machine.	Install the corresponding toner cartridge with a Samsung-genuine cartridge (see "Replacing the toner cartridge" on page 62).
Prepare new cartridge	Small amount of toner is left in the indicated cartridge. The estimated cartridge life ^a of toner is close.	Prepare a new cartridge for a replacement. You may temporarily increase the printing quality by redistributing the toner (see "Redistributing toner" on page 60).

Message	Meaning	Suggested solutions
Replace new cartridge	A toner cartridge has reached its estimated cartridge life ^a .	<ul style="list-style-type: none"> You can choose Stop or Continue as shown on the control panel. If you select Stop, the printer stops printing. If you select Continue, the printer keeps printing but the printing quality cannot be guaranteed. Replace the toner cartridge for the best print quality when this message appears. Using a cartridge beyond this stage can result in printing quality issues (see "Replacing the toner cartridge" on page 62).

a. Estimated cartridge life means the expected or estimated toner cartridge life, which indicates the average capacity of print-outs and is designed pursuant to ISO/IEC 19798 (see "Available consumables" on page 54). The number of pages may be affected by operating environment, percentage of image area, printing interval, media, percentage of image area, and media size. Some amount of toner may remain in the cartridge even when replace new cartridge appears and the machine stops printing.



Samsung does not recommend using a non-genuine Samsung toner cartridge such as refilled or remanufactured. Samsung cannot guarantee a non-genuine Samsung toner cartridge's quality. Service or repair required as a result of using non-genuine Samsung toner cartridges will not be covered under the machine warranty.

Understanding display messages

Imaging unit-related messages

Message	Meaning	Suggested solutions
Not Installed Imaging unit	An imaging unit is not installed.	Reinstall the imaging unit.
	An imaging unit is not being detected	Reinstall the imaging unit two or three times to confirm it is seated properly. If the problem persists, contact the service representatives.
	Not remove protective film from toner.	Remove the protective film from the imaging unit.
Not compatible Imaging unit	The imaging unit is not suitable for your machine.	Install the corresponding cartridge with a Samsung-genuine cartridge (see "Replacing the imaging unit" on page 65).
Prepare new Image unit	Small amount of toner is left in the imaging unit. The estimated cartridge life of toner is close.	Prepare a new imaging unit for a replacement.

Message	Meaning	Suggested solutions
Replace new Image unit	An imaging unit has reached its estimated cartridge life.	<ul style="list-style-type: none"> You can choose Stop or Continue as shown on the control panel. If you select Stop, the printer stops printing. If you select Continue, the printer keeps printing but the printing quality cannot be guaranteed. Replace the imaging unit for the best print quality when this message appears. Using a cartridge beyond this stage can result in printing quality issues (see "Replacing the imaging unit" on page 65). If the machine stops printing, replace the imaging unit (see "Replacing the imaging unit" on page 65).



Samsung does not recommend using a non-genuine Samsung cartridge such as refilled or remanufactured. Samsung cannot guarantee a non-genuine Samsung cartridge's quality. Service or repair required as a result of using non-genuine Samsung cartridges will not be covered under the machine warranty.

Understanding display messages

Tray-related messages

Message	Meaning	Suggested solutions
Paper Empty in [tray number]	There is no paper in the indicated tray.	Load paper in the tray (see "Loading paper in the tray" on page 36).

Network-related messages

Message	Meaning	Suggested solutions
Network Problem: IP Conflict	The IP address is used elsewhere.	Check the IP address or obtain a new IP address.
802.1x Network Error	Fail to authenticate.	Check the network authentication protocol. If the problem persists, contact your network administrator.

Misc. messages

Message	Meaning	Suggested solutions
Door Open Close it	The cover is not securely latched.	Close the cover until it locks into place.
Error [error number] Install toner	The toner cartridge is installed improperly, or the connector is polluted.	Reinstall the Samsung-genuine toner cartridge two or three times to confirm it is seated properly. If the problem persists, please call for service.
Error [error number] Turn off then on	The machine unit cannot be controlled.	Reboot the power and try the printing job again. If the problem persists, please call for service.
Error [error number] Call for service		
Not proper room temp. Move set	The machine is in a room with improper room temperature.	Move the machine to a room with proper room temperature.

Understanding display messages

Message	Meaning	Suggested solutions
Output bin Full Remove paper	The output tray is full.	Remove papers from the output tray, the machine resumes printing. If the problem persists, call for service.
Replace Fuser Soon	The life of the fuser unit will be expired soon.	Replace the fuser unit with a new one. If the problem persists, please call for service.
Replace new Fuser unit	The life of the fuser unit will be expired.	
<ul style="list-style-type: none">• Replace new Tray1 roller• Replace new Tray2 roller	<p>The life of the tray pick-up roller will expired soon.</p> <p>The life of the tray pick-up roller will expired.</p>	Replace the tray pick-up roller with a new one. If the problem persists, please call for service.



5. Appendix

This chapter provides product specifications and information concerning applicable regulations.

- **Specifications** 101
- **Regulatory information** 109
- **Copyright** 119

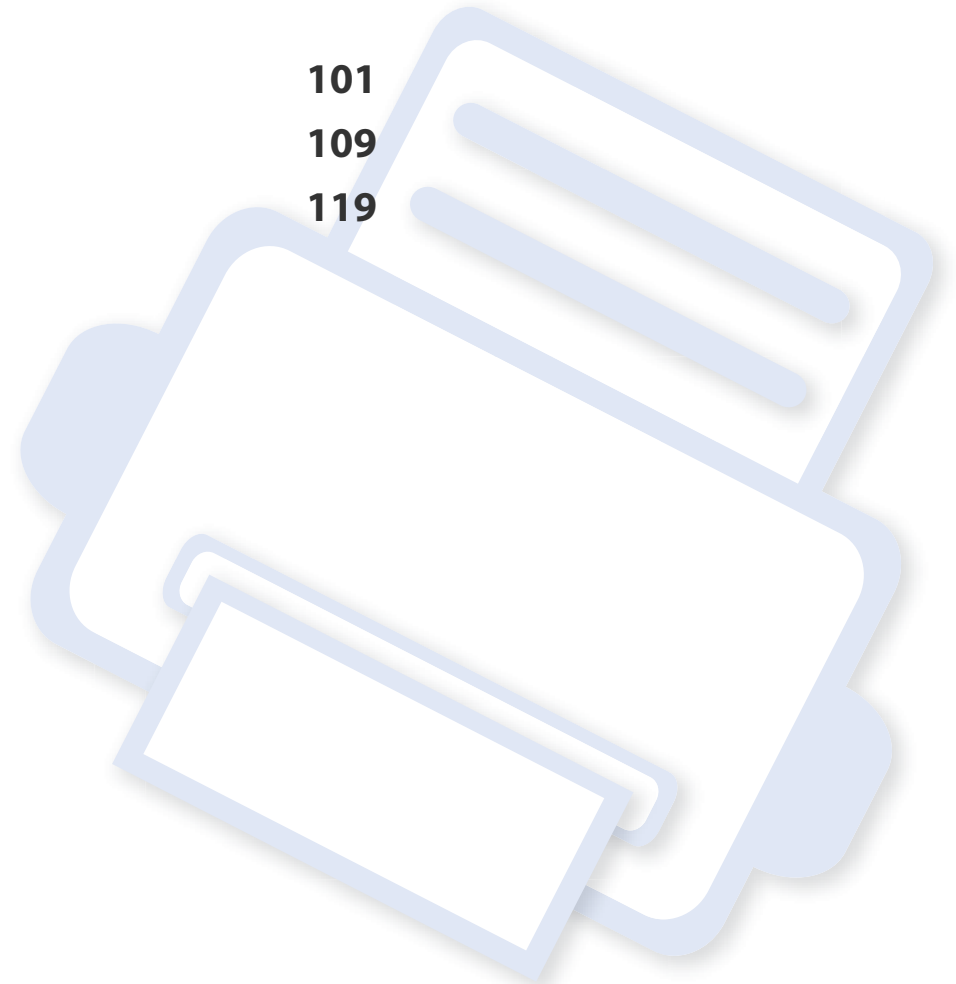

Specifications

General specifications



The specification values listed below are subject to change without notice. See www.samsung.com for possible changes in information.

Items		Description
Dimension	Width x Length x Height	366 x 365.6 x 262.5 mm (14.4 x 14.39 x 10.33 inches)
Weight	Machine with consumables	<ul style="list-style-type: none">• M332xND/M382xD series: 9.86 kg (21.7 lbs)• M382xND/M382xDW/M402xND series: 10.18 kg (22.4 lbs)
Noise Level^a	Ready mode	Less than 26 dB (A)
	Print mode	<ul style="list-style-type: none">• M332x series: Less than 55 dB (A)• M382x/M402x series: Less than 57 dB (A)
Temperature	Operation	10 to 30 °C (50 to 86 °F)
	Storage (packed)	-20 to 40 °C (-4 to 104 °F)
Humidity	Operation	20 to 80% RH
	Storage (packed)	10 to 90% RH
Power rating^b	110 volt models	AC 110 - 127 V
	220 volt models	AC 220 - 240 V

Specifications

	Items	Description
Power consumption	Average operating mode	Less than 700 W
	Ready mode	Less than 10 W
	Power save mode ^c	Less than 1.1W (Wi-Fi Direct on: Less than 2.8 W ^d)
	Power off mode ^e	Less than 0.1 W
Wireless^f	Module	SPW-B4319U

a. Sound Pressure Level, ISO 7779. Configuration tested: basic machine installation, A4 paper, simplex printing.

b. See the rating label on the machine for the correct voltage (V), frequency (hertz) and of current (A) for your machine.

c. The power consumption of power save mode may be affected by machine's status, setting conditions, operating environment.

d. Wireless model only (see "Features by models" on page 8).

e. Power consumption can be completely avoided only when the power cable is not connected.

f. Wireless models only (see "Features by models" on page 8).

Specifications

Print media specifications

Type	Size	Dimensions	Print media weight/Capacity ^a		
			Tray1 / Optional tray	Multi-purpose tray	Manual feeder ^{b c}
Plain paper	Letter	216 x 279 mm (8.5 x 11 inches)	70 to 85 g/m ² (19 to 24 lbs bond) • 250 sheets of 80 g/m ² (20 lbs bond) • 150 sheets of 75 g/m ² (20 lbs bond)	70 to 85 g/m ² (19 to 24 lbs bond) • 50 sheets of 80 g/m ² (20 lbs bond)	70 to 85 g/m ² (19 to 24 lbs bond) • 1 sheet of 80 g/m ² (20 lbs bond)
	Legal	216 x 356 mm (8.5 x 14 inches)			
	US Folio	216 x 330 mm (8.5 x 13 inches)			
	A4	210 x 297 mm (8.26 x 11.69 inches)			
	Oficio	216 x 343 mm (8.5 x 13.5 inches)			
	JIS B5	182 x 257 mm (7.16 x 10.11 inches)			
	ISO B5	176 x 250 mm (6.93 x 9.84 inches)			
	Executive	184 x 267 mm (7.25 x 10.5 inches)			
	A5	148 x 210 mm (5.82 x 8.26 inches)			
	A6	105 x 148 mm (4.13 x 5.82 inches)			
Envelope	Envelope Monarch	98 x 191 mm (3.87 x 7.5 inches)	Not available in tray1/ optional tray.	75 to 90 g/m ² (20 to 24 lbs bond)	75 to 90 g/m ² (20 to 24 lbs bond)
	Envelope No. 10	105 x 241 mm (4.12 x 9.5 inches)			
	Envelope DL	110 x 220 mm (4.33 x 8.66 inches)			
	Envelope C5	162 x 229 mm (6.37 x 9.01 inches)			
	Envelope C6	114 x 162 mm (4.48 x 6.38 inches)			
Thick paper	Refer to the Plain paper section	Refer to the Plain paper section	86 to 105 g/m ² (23 to 28 lbs bond)	86 to 105 g/m ² (23 to 28 lbs bond)	86 to 105 g/m ² (23 to 28 lbs bond)
Thicker paper	Refer to the Plain paper section	Refer to the Plain paper section	Not available in tray1/ optional tray.	164 to 220 g/m ² (44 to 58 lbs bond)	164 to 220 g/m ² (44 to 58 lbs bond)
Thin paper	Refer to the Plain paper section	Refer to the Plain paper section	60 to 70 g/m ² (16 to 19 lbs bond)	60 to 70 g/m ² (16 to 19 lbs bond)	60 to 70 g/m ² (16 to 19 lbs bond)

Specifications

Type	Size	Dimensions	Print media weight/Capacity ^a		
			Tray1 / Optional tray	Multi-purpose tray	Manual feeder ^{b c}
Transparency	Letter, A4	Refer to the Plain paper section	Not available in tray1/ optional tray.	138 to 146 g/m ² (36.81 to 38.91 lbs bond)	138 to 146 g/m ² (36.81 to 38.91 lbs bond)
Labels ^d	Letter, Legal, US Folio, A4, JIS B5, ISO B5, Executive, A5	Refer to the Plain paper section	Not available in tray1/ optional tray.	120 to 150 g/m ² (32 to 40 lbs bond)	120 to 150 g/m ² (32 to 40 lbs bond)
Card stock	Letter, Legal, US Folio, A4, JIS B5, ISO B5, Executive, A5	Refer to the Plain paper section	121 to 163 g/m ² (32 to 43 lbs bond)	121 to 163 g/m ² (32 to 43 lbs bond)	121 to 163 g/m ² (32 to 43 lbs bond)
Bond paper	Refer to the Plain paper section	Refer to the Plain paper section	106 to 120 g/m ² (28 to 32 lbs bond)	106 to 120 g/m ² (28 to 32 lbs bond)	106 to 120 g/m ² (28 to 32 lbs bond)
Minimum size (custom)^{e, f}		<ul style="list-style-type: none"> Multi-purpose(or manual feeder) tray: 76 x 127 mm (2.99 x 5 inches) Tray 1: 105 x 148.5 mm (4.13 x 5.85 inches) 	60 to 163 g/m ² (16 to 43 lbs bond) Not available in optional tray.		
Maximum size (custom)		216 x 356 mm (8.5 x 14 inches)			

a. Maximum capacity may differ depending on media weight, thickness, and environmental conditions.

b. M332xND/M382xD series only.

c. 1 sheet for manual feeder.

d. The smoothness of the labels used in this machine is 100 to 250 (sheffield). This means the numeric level of smoothness.

e. The paper types available in multi-purpose tray: Plan, Thick, Thicker, Thin, Cotton, Colored, Pre-printed, Recycled, Envelope, Transparency, Labels, Cardstock, Bond, Archive

f. The paper types available in tray 1: Plan, Thick, Thin, Recycled, Cardstock, Bond, Archive

Specifications

System requirements

Microsoft® Windows®

Operating system	Requirement (recommended)		
	CPU	RAM	free HDD space
Windows® XP	Intel® Pentium® III 933 MHz (Pentium IV 1 GHz)	128 MB (256 MB)	1.5 GB
Windows Server® 2003	Intel® Pentium® III 933 MHz (Pentium IV 1 GHz)	128 MB (512 MB)	1.25 GB to 2 GB
Windows Server® 2008	Intel® Pentium® IV 1 GHz (Pentium IV 2 GHz)	512 MB (2 GB)	10 GB
Windows Vista®	Intel® Pentium® IV 3 GHz	512 MB (1 GB)	15 GB
Windows® 7	Intel® Pentium® IV 1 GHz 32-bit or 64-bit processor or higher <ul style="list-style-type: none">• Support for DirectX® 9 graphics with 128 MB memory (to enable the Aero theme).• DVD-R/W Drive	1 GB (2 GB)	16 GB
Windows Server® 2008 R2	Intel® Pentium® IV 1 GHz (x86) or 1.4 GHz (x64) processors (2 GHz or faster)	512 MB (2 GB)	10 GB
Windows® 8	Intel® Pentium® IV 1 GHz 32-bit or 64-bit processor or higher	1 GB (2 GB)	16 GB



- Internet Explorer 6.0 or higher is the minimum requirement for all Windows operating systems.
- Users who have administrator rights can install the software.
- **Windows Terminal Services** is compatible with your machine.

Specifications

Mac

Operating system	Requirements (Recommended)		
	CPU	RAM	Free HDD space
Mac OS X 10.5	<ul style="list-style-type: none">Intel® processors867 MHz or faster Power PC G4/G5	512 MB (1 GB)	1 GB
Mac OS X 10.6	<ul style="list-style-type: none">Intel® processors	1 GB (2 GB)	1 GB
Mac OS X 10.7 - 10.8	<ul style="list-style-type: none">Intel® processors	2 GB	4 GB

Linux

Items	Requirements
Operating system	Redhat® Enterprise Linux WS 4, 5, 6 (32/64 bit) Fedora 5 ~ 15 (32/64 bit) OpenSuSE® 10.2, 10.3, 11.0, 11.1, 11.2, 11.3, 11.4 (32/64 bit) Mandriva 2007, 2008, 2009, 2009.1, 2010 (32/64 bit) Ubuntu 6.06, 6.10, 7.04, 7.10, 8.04, 8.10, 9.04, 9.10, 10.04, 10.10, 11.04 (32/64 bit) SuSE Linux Enterprise Desktop 10, 11 (32/64 bit) Debian 4.0, 5.0, 6.0 (32/64 bit)
CPU	Pentium IV 2.4GHz (Intel Core™2)
RAM	512 MB (1 GB)

Specifications

Items	Requirements
Free HDD space	1 GB (2 GB)

Unix

Items	Requirements
Operating system	Sun Solaris 9, 10, 11 (x86, SPARC) HP-UX 11.0, 11i v1, 11i v2, 11i v3 (PA-RISC, Itanium) IBM AIX 5.1, 5.2, 5.3, 5.4, 6.1, 7.1 (Power PC)
Free HDD space	Up to 100 MB

Specifications

Network environment



Network and wireless models only (see "Features by models" on page 8).

You need to set up the network protocols on the machine to use it as your network machine. The following table shows the network environments supported by the machine.

Items	Specifications
Network interface	<ul style="list-style-type: none">• Ethernet 10/100/1000 Base-TX Wired Lan• 802.11b/g/n Wireless LAN
Network operating system	<ul style="list-style-type: none">• Windows® XP, Windows Server® 2003, Windows Vista®, Windows® 7, Windows® 8, Windows Server® 2008 R2• Various Linux OS• Mac OS X 10.5 -10.8• UNIX OS
Network protocols	<ul style="list-style-type: none">• TCP/IPv4• DHCP, BOOTP• DNS, WINS, Bonjour, SLP, UPnP• Standard TCP/IP Printing (RAW), LPR, IPP, WSD, AirPrint, Google Cloud Print• SNMPv 1/2/3, HTTP, IPSec• TCP/IPv6 (DHCP, DNS, RAW, LPR, SNMPv 1/2/3, HTTP, IPSec)
Wireless security	<ul style="list-style-type: none">• Authentication: Open System, Shared Key, WPA Personal, WPA2 Personal (PSK)• Encryption: WEP64, WEP128, TKIP, AES

Regulatory information

This machine is designed for a normal work environment and certified with several regulatory statements.

Laser safety statement

The printer is certified in the U.S. to conform to the requirements of DHHS 21 CFR, chapter 1 Subchapter J for Class I(1) laser products, and elsewhere is certified as a Class I laser product conforming to the requirements of IEC 60825-1 : 2007.

Class I laser products are not considered to be hazardous. The laser system and printer are designed so there is never any human access to laser radiation above a Class I level during normal operation, user maintenance or prescribed service condition.

Warning

Never operate or service the printer with the protective cover removed from laser/scanner assembly. The reflected beam, although invisible, can damage your eyes.

When using this product, these basic safety precautions should always be followed to reduce risk of fire, electric shock, and injury to persons:



CAUTION - CLASS 3B. INVISIBLE LASER RADIATION WHEN OPEN. AVOID EXPOSURE TO THE BEAM.

DANGER - INVISIBLE LASER RADIATION WHEN OPEN. AVOID DIRECT EXPOSURE TO BEAM.

DANGER - KLASSE 3B. UNSICHTBARE LASERSTRAHLUNG, WENN OFFEN. STRAHLENAUSSETZUNG VERMEIDEN.

VORSICHT - UNSICHTBARE LASERSTRAHLUNG KLASSE 3 B, WENN ABDECKUNG GEÖFFNET. NICHT DEM STRAHL AUSSETZEN.

ATTENZIONE - CLASSE 3B. RADIZIONI LASER INVISIBILI CON IL DISPOSITIVO APERTO. EVITARE L'ESPOSIZIONE AL RAGGIO.

PRECAUCIÓN - RADIACIÓN LÁSER INVISIBLE DE CLASE 3B PRESENTE AL ABRIR. EVITE LA EXPOSICIÓN AL HAZ.

PERIGO - CLASSE 3B. RADIAÇÃO LASER INVISÍVEL AO ABRIR. EVITE EXPOSIÇÃO DIRECTA AO FEIXE.

GEVAAR - KLASSE 3B. ONZICHTBARE LASERSTRALING INDIEN GEOPEND. VERMIJD BLOOTSTELLING AAN DE STRAAL.

ADVARSEL - KLASSE 3B. USYNLIG LASERSTRÅLING VED ÅBNING. UNDGÅ UDSÆTTELSE FOR STRÅLING.

ADVARSEL - KLASSE 3B. USYNLIG LASERSTRÅLING NÅR DEKSEL ÅPNES. UNNGÅ EKSPONERING FOR STRÅLEN.

VARNING - KLASSE 3B OSYNLIG LASERSTRÅLNING NÅR DENNA DEL ÅR ÖPPNAD. STRÅLEN ÅR FARLIG.

VAROITUS - LUOKAN 3B NÄKYMÄTTÖMÄLLE LASER-SÄTEILYÄ AVATTUNA. VÄLTÄ ALTISTUMISTA SÄTEELLE.

注意 - CLASS 3B. 严禁打开，以免被不可见激光辐射泄漏灼伤

주의 - 열리면 등급 3B 비가시 레이저 방사선 이 방출됩니다. 광선에 노출을 피하십시오.

Regulatory information

Ozone safety



This product's ozone emission rate is under 0.1 ppm. Because ozone is heavier than air, keep the product in a place with good ventilation.

Power saver



This printer contains advanced energy conservation technology that reduces power consumption when it is not in active use.

When the printer does not receive data for an extended period of time, power consumption is automatically lowered.

ENERGY STAR and the ENERGY STAR mark are registered U.S. marks.

For more information on the ENERGY STAR program see <http://www.energystar.gov>

For ENERGY STAR certified models, the ENERGY STAR label will be on your machine. Check if your machine is ENERGY STAR certified.

Recycling



Recycle or dispose of the packaging material for this product in an environmentally responsible manner.

China only

回收和再循环

为了保护环境，我公司已经为废弃的产品建立了回收和再循环系统。我们会为您无偿提供回收同类废旧产品的服务。当您要废弃您正在使用的产品时，请您及时与授权耗材更换中心取得联系，我们会及时为您提供服务。

中国能效标识

型号	能效等级	典型能耗 (kW·h)
ProXpress M3325ND	1	1.57
ProXpress M3825ND ProXpress M3825D	1	1.81
ProXpress M4025ND	1	1.95

依据国家标准 GB 25956-2010

Regulatory information

Correct disposal of this product (Waste electrical & electronic equipment)

(Applicable in countries with separate collection systems)



This marking on the product, accessories or literature indicates that the product and its electronic accessories (e.g. charger, headset, USB cable) should not be disposed of with other household waste at the end of their working life. To prevent possible harm to the environment or human health from uncontrolled waste disposal, please separate these items from other s of waste and recycle them responsibly to promote the sustainable reuse of material resources.

Household users should contact either the retailer where they purchased this product, or their local government office, for details of where and how they can take these items for environmentally safe recycling.

Business users should contact their supplier and check the terms and conditions of the purchase contract. This product and its electronic accessories should not be mixed with other commercial wastes for disposal.

(The United States of America only)

Dispose unwanted electronics through an approved recycler. To find the nearest recycling location, go to our website: www.samsung.com/recyclingdirect Or call, (877) 278 - 0799

State of California Proposition 65 Warning (US Only)

The California Safe Drinking Water and Toxic Enforcement Act requires the Governor of California to publish a list of chemicals known to the State of California to cause cancer or reproductive toxicity and requires businesses to warn of potential exposure to such chemicals.

WARNING: This product contains chemicals known to the State of California to cause cancer, birth defects or other reproductive harm.
This appliance can cause low-level exposure to the chemicals, which can be minimized by operating the appliance in a well ventilated area.

Radio frequency emissions

FCC information to the user

This device complies with Part 15 of the FCC Rules. Operation is subject to the following two conditions:

- This device may not cause harmful interference, and
- This device must accept any interference received, including interference that may cause undesired operation.

Regulatory information

This equipment has been tested and found to comply with the limits for a Class B digital device, pursuant to Part 15 of the FCC Rules. These limits are designed to provide reasonable protection against harmful interference in a residential installation. This equipment generates, uses and can radiate radio frequency energy and, if not installed and used in accordance with the instructions, may cause harmful interference to radio communications. However, there is no guarantee that interference will not occur in a particular installation. If this equipment does cause harmful interference to radio or television reception, which can be determined by turning the equipment off and on, the user is encouraged to try to correct the interference by one or more of the following measures:

- Reorient or relocate the receiving antenna.
- Increase the separation between the equipment and receiver.
- Connect the equipment into an outlet on a circuit different from that to which the receiver is connected.
- Consult the dealer or experienced radio TV technician for help.



Change or modifications not expressly approved by the manufacturer responsible for compliance could void the user's authority to operate the equipment.

Canadian radio interference regulations

This digital apparatus does not exceed the Class B limits for radio noise emissions from digital apparatus as set out in the interference-causing equipment standard entitled "Digital Apparatus", ICES-003 of the Industry and Science Canada.

Cet appareil numérique respecte les limites de bruits radioélectriques applicables aux appareils numériques de Classe B prescrites dans la norme sur le matériel brouilleur: "Appareils Numériques", ICES-003 édictée par l'Industrie et Sciences Canada.

United States of America

Federal Communications Commission (FCC)

Intentional emitter per FCC Part 15

Low power, Radio LAN devices (radio frequency (RF) wireless communication devices), operating in the 2.4 GHz/5 GHz Band, may be present (embedded) in your printer system. This section is only applicable if these devices are present. Refer to the system label to verify the presence of wireless devices.

Wireless devices that may be in your system are only qualified for use in the United States of America if an FCC ID number is on the system label.

Regulatory information

The FCC has set a general guideline of 20 cm (8 inches) separation between the device and the body, for use of a wireless device near the body (this does not include extremities). This device should be used more than 20 cm (8 inches) from the body when wireless devices are on. The power output of the wireless device (or devices), which may be embedded in your printer, is well below the RF exposure limits as set by the FCC.

This transmitter must not be collocated or operation in conjunction with any other antenna or transmitter.

Operation of this device is subject to the following two conditions: (1) This device may not cause harmful interference, and (2) this device must accept any interference received, including interference that may cause undesired operation of the device.



Wireless devices are not user serviceable. Do not modify them in any way. Modification to a wireless device will void the authorization to use it. Contact manufacturer for service.

FCC Statement for Wireless LAN use:



While installing and operating this transmitter and antenna combination the radio frequency exposure limit of 1m W/cm² may be exceeded at distances close to the antenna installed. Therefore, the user must maintain a minimum distance of 20cm from the antenna at all times. This device cannot be collocated with another transmitter and transmitting antenna.

Russia only



Germany only

Das Gerät ist nicht für die Benutzung am Bildschirmarbeitsplatz gemäß BildscharbV vorgesehen.

Regulatory information

Turkey only

- **RoHS**
EEE Yönetmeliğine Uygundur.
This EEE is compliant with RoHS.
- Bu ürünün ortalama yaşam süresi 7 yıl, garanti süresi 2 yıldır.

Thailand only

This telecommunication equipment conforms to NTC technical requirement.

Replacing the Fitted Plug (for UK Only)

Important

The mains lead for this machine is fitted with a standard (BS 1363) 13 amp plug and has a 13 amp fuse. When you change or examine the fuse, you must re-fit the correct 13 amp fuse. You then need to replace the fuse cover. If you have lost the fuse cover, do not use the plug until you have another fuse cover.

Contact the people from you purchased the machine.

The 13 amp plug is the most widely used in the UK and should be suitable. However, some buildings (mainly old ones) do not have normal 13 amp plug sockets. You need to buy a suitable plug adaptor. Do not remove the moulded plug.



If you cut off the moulded plug, get rid of it straight away.

You cannot rewire the plug and you may receive an electric shock if you plug it into a socket.

Important warning:



You must earth this machine.

The wires in the mains lead have the following color code:

- **Green and Yellow:** Earth
- **Blue:** Neutral
- **Brown:** Live

If the wires in the mains lead do not match the colors marked in your plug, do the following:

You must connect the green and yellow wire to the pin marked by the letter “E” or by the safety ‘Earth symbol’ or colored green and yellow or green.

You must connect the blue wire to the pin which is marked with the letter “N” or colored black.

Regulatory information

You must connect the brown wire to the pin which is marked with the letter “L” or colored red.

You must have a 13 amp fuse in the plug, adaptor, or at the distribution board.

Declaration of conformity (European countries)

Approvals and Certifications

Hereby, Samsung Electronics, declares that this [ProXpress M332xND, ProXpress M382xD, ProXpress M382xND, ProXpress M402xND] is in compliance with the essential requirements and other relevant provisions of Low Voltage Directive (2006/95/EC), EMC Directive (2004/108/EC).



Hereby, Samsung Electronics, declares that this [ProXpress M382xDW] is in compliance with the essential requirements and other relevant provisions of R&TTE Directive 1999/5/EC.

The declaration of conformity may be consulted at www.samsung.com, go to Support > Download center and enter your printer (MFP) name to browse the EuDoC.

January 1, 1995: Council Directive 2006/95/EC Approximation of the laws of the member states related to low voltage equipment.

January 1, 1996: Council Directive 2004/108/EC, approximation of the laws of the Member States related to electromagnetic compatibility.

March 9, 1999: Council Directive 1999/5/EC on radio equipment and telecommunications terminal equipment and the mutual recognition of their conformity. A full declaration, defining the relevant Directives and referenced standards can be obtained from your Samsung Electronics Co., Ltd. representative.

EC Certification

Certification to 1999/5/EC Radio Equipment & Telecommunications Terminal Equipment Directive (FAX)

This Samsung product has been self-certified by Samsung for pan-European single terminal connection to the analogue public switched telephone network (PSTN) in accordance with Directive 1999/5/EC. The product has been designed to work with the national PSTNs and compatible PBXs of the European countries:

In the event of problems, you should contact the Euro QA Lab of Samsung Electronics Co., Ltd. in the first instance.

The product has been tested against TBR21. To assist in the use and application of terminal equipment which complies with this standard, the European Telecommunication Standards Institute (ETSI) has issued an advisory document (EG 201 121) which contains notes and additional requirements to ensure network compatibility of TBR21 terminals. The product has been designed against, and is fully compliant with, all of the relevant advisory notes contained in this document.

Regulatory information

European radio approval information (for products fitted with EU-approved radio devices)

Low power, Radio LAN type devices (radio frequency (RF) wireless communication devices), operating in the 2.4 GHz/5 GHz band, may be present (embedded) in your printer system which is intended for home or office use. This section is only applicable if these devices are present. Refer to the system label to verify the presence of wireless devices.



Wireless devices that may be in your system are only qualified for use in the European Union or associated areas if a CE mark is on the system label.

The power output of the wireless device or devices that may be embedded in your printer is well below the RF exposure limits as set by the European Commission through the R&TTE directive.

European states qualified under wireless approvals:

EU countries

European states with restrictions on use:

EU

EEA/EFTA countries

No limitations at this time

Israel only

מס' אישור אלחוטי של משרד התקשורת הוא 51-30319
אסור להחליף את האנטנה המקורית של המכשיר,
ולא לעשות בו כל שינוי טכני אחר.

Regulatory compliance statements

Wireless guidance

Low power, Radio LAN devices (radio frequency (RF) wireless communication devices), operating in the 2.4 GHz/5 GHz Band, may be present (embedded) in your printer system. The following section is a general overview of considerations while operating a wireless device.

Additional limitations, cautions, and concerns for specific countries are listed in the specific country sections (or country group sections). The wireless devices in your system are only qualified for use in the countries identified by the Radio Approval Marks on the system rating label. If the country you will be using the wireless device in, is not listed, contact your local Radio Approval agency for requirements. Wireless devices are closely regulated and use may not be allowed.

Regulatory information

The power output of the wireless device or devices that may be embedded in your printer is well below the RF exposure limits as known at this time. Because the wireless devices (which may be embedded into your printer) emit less energy than is allowed in radio frequency safety standards and recommendations, manufacturer believes these devices are safe for use. Regardless of the power levels, care should be taken to minimize human contact during normal operation.

As a general guideline, a separation of 20 cm (8 inches) between the wireless device and the body, for use of a wireless device near the body (this does not include extremities) is typical. This device should be used more than 20 cm (8 inches) from the body when wireless devices are on and transmitting.

This transmitter must not be collocated or operation in conjunction with any other antenna or transmitter.

Some circumstances require restrictions on wireless devices. Examples of common restrictions are listed below:



Radio frequency wireless communication can interfere with equipment on commercial aircraft. Current aviation regulations require wireless devices to be turned off while traveling in an airplane. IEEE 802.11 (also known as wireless Ethernet) and Bluetooth communication devices are examples of devices that provide wireless communication.



In environments where the risk of interference to other devices or services is harmful or perceived as harmful, the option to use a wireless device may be restricted or eliminated. Airports, Hospitals, and Oxygen or flammable gas laden atmospheres are limited examples where use of wireless devices may be restricted or eliminated. When in environments where you are uncertain of the sanction to use wireless devices, ask the applicable authority for authorization prior to use or turning on the wireless device.



Every country has different restrictions on the use of wireless devices. Since your system is equipped with a wireless device, when traveling between countries with your system, check with the local Radio Approval authorities prior to any move or trip for any restrictions on the use of a wireless device in the destination country.



If your system came equipped with an internal embedded wireless device, do not operate the wireless device unless all covers and shields are in place and the system is fully assembled.



Wireless devices are not user serviceable. Do not modify them in any way. Modification to a wireless device will void the authorization to use it. Contact manufacturer for service.



Only use drivers approved for the country in which the device will be used. See the manufacturer System Restoration Kit, or contact manufacturer Technical Support for additional information.

Regulatory information

China only

产品中有害有毒物质或元素的名称及含量

部件名称	有害有毒物质或元素					
	铅 (Pb)	汞 (Hg)	镉 (Cd)	六价铬 (Cr ⁶⁺)	多溴联苯 (PBB)	多溴联苯醚 (PBDE)
塑料	○	○	○	○	○	○
金属 (机箱)	X	○	○	○	○	○
印刷电路部件 (PCA)	X	○	○	○	○	○
电缆 / 连接器	X	○	○	○	○	○
电源设备	X	○	○	○	○	○
电源线	X	○	○	○	○	○
机械部件	X	○	○	○	○	○
卡盒部件	X	○	○	○	○	○
定影部件	X	○	○	○	○	○
扫描仪部件 - CCD (如果有)	X	X	○	○	○	○
扫描仪部件 - 其它 (如果有)	X	○	○	○	○	○
印刷电路板部件 (PBA)	X	○	○	○	○	○
墨粉	○	○	○	○	○	○
滚筒	○	○	○	○	○	○

○：表示该有害有毒物质在该部件所有均质材料中的含量均在 SJ/T 11363-2006 标准规定的限量要求以下。

X：表示该有害有毒物质至少在该部件的某一均质材料中的含量超出 SJ/T 11363-2006 标准规定的限量要求。

以上表为目前本产品含有有害有毒物质的信息。本信息由本公司的配套厂家提供，经本公司审核后而做成，本产品的部分部件含有有害有毒物质，这些部件是在现有科学技术水平下暂时无可替代物质，但三星电子将会一直为满足 SJ/T 11363-2006 标准而做不懈的努力。

Copyright

© 2013 Samsung Electronics Co., Ltd. All rights reserved.

This user's guide is provided for information purposes only. All information included herein is subject to change without notice.

Samsung Electronics is not responsible for any direct or indirect damages, arising from or related to use of this user's guide.

- Samsung and the Samsung logo are trademarks of Samsung Electronics Co., Ltd.
- Microsoft, Windows, Windows Vista, Windows 7, Windows 8 and Windows Server 2008 R2 are either registered trademarks or trademarks of Microsoft Corporation.
- Google, Picasa, Google Docs, Android and Gmail are either registered trademarks or trademarks of Google Inc.
- Google Cloud Print is a trademark of Google Inc.
- iPad, iPhone, iPod touch, Mac and Mac OS are trademarks of Apple Inc., registered in the U.S and other countries. AirPrint and the AirPrint logo are trademarks of Apple Inc.
- All other brand or product names are trademarks of their respective companies or organizations.

Refer to the '**LICENSE.txt**' file in the provided CD-ROM for the open source license information.

REV.1.00

User's Guide

Samsung Printer **ProXpress**

M332x series
M382x series
M402x series

ADVANCED

This guide provides information about installation, advanced configuration, operation and troubleshooting on various OS environments.

Some features may not be available depending on models or countries.

BASIC

This guide provides information concerning installation, basic operation and troubleshooting on windows.



1. Software Installation

Installation for Mac	124
Reinstallation for Mac	125
Installation for Linux	126
Reinstallation for Linux	127



2. Using a Network-Connected

Useful network programs	129
Wired network setup	130
Installing driver over the network	133
IPv6 configuration	142
Wireless network setup	145
Samsung MobilePrint	170
AirPrint	171
Google Cloud Print™	173



3. Useful Setting Menus

Before you begin reading a chapter	177
---	-----

Information	178
Layout	179
Paper	180
Graphic	181
System Setup	182
Emulation	185
Network	186
Job Management	188



4. Special Features

Altitude adjustment	190
Entering various characters	191
Printing features	192
Using optional device features	208



5. Useful Management Tools

Accessing management tools	211
Easy Capture Manager	212
Samsung AnyWeb Print	213
Easy Eco Driver	214
Using SyncThru™ Web Service	215

Using Samsung Easy Printer Manager	219
Using Samsung Printer Status	222
Using Samsung Printer Experience	224
Using the Linux Unified Driver Configurator	230



6. Troubleshooting

Paper feeding problems	235
Power and cable connecting problems	236
Printing problems	237
Printing quality problems	241
Operating system problems	249



1. Software Installation

This chapter provides instructions for installing essential and helpful software for use in an environment where the machine is connected via a cable. A locally connected machine is a machine directly attached to your computer using the cable. If your machine is attached to a network, skip the following steps below and go on to installing a network connected machine's driver (see "Installing driver over the network" on page 133).

- **Installation for Mac** **124**
- **Reinstallation for Mac** **125**
- **Installation for Linux** **126**
- **Reinstallation for Linux** **127**



- If you are a Windows OS user, refer to the Basic Guide for installing the machine's driver (see "Installing the driver locally" on page 25).
- Only use a USB cable no longer than 3 meter (118 inches).

Installation for Mac

1 Make sure that the machine is connected to your computer and powered on.

2 Insert the supplied software CD into your CD-ROM drive.

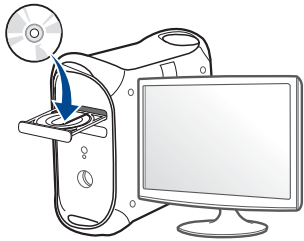

3 Double-click the CD-ROM icon that appears on your Mac desktop.

- For Mac OS X 10.8, double-click the CD-ROM that appears on **Finder**.

4 Double-click the **MAC_Installer** folder > **Installer OS X** icon.

5 Click **Continue**.

6 Read the license agreement and click **Continue**.

7 Click **Agree** to agree to the license agreement.

8 Click **Install**. All components necessary for machine operations will be installed.

If you click **Customize**, you can choose individual components to install.

9 Enter the password and click **OK**.

10 Select **Direct Connection using USB cable** on the **Printer Connection Type** and click **Continue**.

11 Click **Add Printer** button to select your printer and add it to your printer list.

If your machine supports fax, click **Add Fax** button to select your fax and add it to your fax list

12 After the installation is finished, click **Close**.

Reinstallation for Mac

If the printer driver does not work properly, uninstall the driver and reinstall it.

- 1 Open the **Applications** folder > **Samsung** > **Printer Software Uninstaller**.
- 2 To uninstall printer software, click **Continue**.
- 3 Check the program you want to delete and click **Uninstall**.
- 4 Enter the password and click **OK**.
- 5 After the uninstallation is finished, click **Close**.



If a machine has already been added, delete it from the **Print Setup Utility** or **Print & Fax**.

Installation for Linux

You need to download Linux software packages from the Samsung website to install the printer software (<http://www.samsung.com> > find your product > Support or Downloads).

The installation program added the Unified Driver Configurator desktop icon and the Unified Driver group to the system menu for your convenience. If you have any difficulties, consult the on-screen help that is available through your system menu or from the driver package Windows applications, such as **Unified Driver Configurator** or **Image Manager**.

Installing the Unified Linux Driver

- 1 Make sure that the machine is connected to your computer and powered on.
- 2 When the **Administrator Login** window appears, type "root" in the **Login** field and enter the system password.



You must log in as a super user (root) to install the machine software. If you are not a super user, ask your system administrator.

- 3 From the Samsung website, download the Unified Linux Driver package to your computer.
- 4 Right-click the **Unified Linux Driver** package and extract the package.
- 5 Double click **cdroot** > **autorun**.
- 6 When the welcome screen appears, click **Next**.
- 7 When the installation is complete, click **Finish**.

Reinstallation for Linux

If the printer driver does not work properly, uninstall the driver and reinstall it.

- 1 Make sure that the machine is connected to your computer and powered on.
- 2 When the **Administrator Login** window appears, type "root" in the **Login** field and enter the system password.
You must log in as a super user (root) to uninstall the printer driver. If you are not a super user, ask your system administrator.
- 3 Open the Terminal program. When the Terminal screen appears, type in the following.

```
[root@localhost root]#cd /opt/Samsung/mfp/uninstall/  
[root@localhost uninstall]#./uninstall.sh
```
- 4 Click **Next**.
- 5 Click **Finish**.



2. Using a Network-Connected Machine

This chapter gives you step-by-step instructions for setting up a network connected machine and software.

- **Useful network programs** 129
- **Wired network setup** 130
- **Installing driver over the network** 133
- **IPv6 configuration** 142
- **Wireless network setup** 145
- **Samsung MobilePrint** 170
- **AirPrint** 171
- **Google Cloud Print™** 173



Supported optional devices and features may differ according to your model (see "Features by models" on page 8).

Useful network programs

There are several programs available to setup the network settings easily in a network environment. For the network administrator especially, managing several machines on the network is possible.



- Before using the programs below, set the IP address first.
- Some features and optional goods may not be available depending on model or country (see "Features by models" on page 8).

SyncThru™ Web Service

The web server embedded on your network machine allows you to do the following tasks (see "Using SyncThru™ Web Service" on page 215).

- Check the supplies information and status.
- Customize machine settings.
- Set the email notification option. When you set this option, the machine status (toner cartridge shortage or machine error) will be sent to a certain person's email automatically.
- Configure the network parameters necessary for the machine to connect to various network environments.

SyncThru™ Web Admin Service

Web-based machine management solution for network administrators. SyncThru™ Web Admin Service provides you with an efficient way of managing network devices and lets you remotely monitor and troubleshoot network machines from any site with corporate internet access.

- Download this program from <http://solution.samsungprinter.com>.

SetIP wired network setup

This utility program allows you to select a network interface and manually configure the IP addresses for use with the TCP/IP protocol.

- See "IPv4 configuration using SetIP (Windows)" on page 130.
- See "IPv4 configuration using SetIP (Mac)" on page 131.
- See "IPv4 configuration using SetIP (Linux)" on page 132.



- The machine that does not support the network port, it will not be able to use this feature (see "Rear view" on page 21).
- TCP/IPv6 is not supported by this program.



Wired network setup

Printing a network configuration report

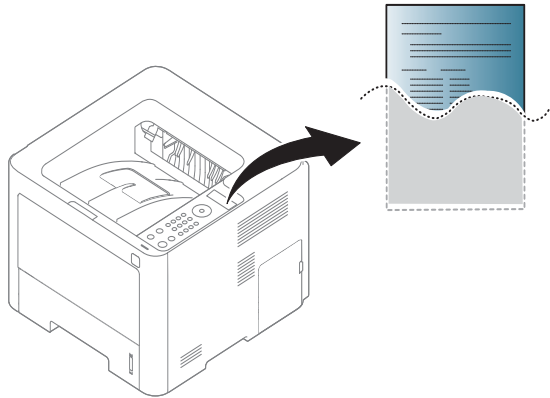
You can print **Network Configuration Report** from the machine's control panel that will show the current machine's network settings. This will help you to set up a network.



- Accessing menus may differ from model to model (see "Accessing the menu" on page 30).
- It may be necessary to press **OK** to navigate to lower-level menus for some models.

- **The machine has the display screen:** Press the  (**Menu**) button on the control panel and select **Network > Network Conf.**
- **The machine does not have the display screen:** Press the  (**Cancel**) button for more than five seconds on the control panel.

Using this **Network Configuration Report**, you can find your machine's MAC address and IP address.

For example:

- MAC Address: 00:15:99:41:A2:78
- IP Address: 169.254.192.192

Setting IP address



- The machine that does not support the network interface, it will not be able to use this feature (see "Rear view" on page 21).
- TCP/IPv6 is not supported by this program.

First, you have to set up an IP address for network printing and managements. In most cases a new IP address will be automatically assigned by a DHCP (Dynamic Host Configuration Protocol) server located on the network.

IPv4 configuration using SetIP (Windows)

Before using the SetIP program, disable the computer firewall from **Control Panel > Security Center > Windows Firewall**.

Wired network setup

- 1 Download the software from the Samsung website then unpack and install it: (<http://www.samsung.com> > find your product > Support or Downloads).
- 2 Follow the instructions in the installation window.
- 3 Connect your machine to the network with a network cable.
- 4 Turn on the machine.
- 5 From the Windows **Start** menu, select **All Programs > Samsung Printers > SetIP > SetIP**.
- 6 Click the  icon in the SetIP window to open the TCP/IP configuration window.
- 7 Enter the machine's new information into the configuration window. In a corporate intranet, you may need to have this information assigned by a network manager before proceeding.



Find the machine's MAC address from the **Network Configuration Report** (see "Printing a network configuration report" on page 130) and enter it without the colons. For example, 00:15:99:29:51:A8 becomes 0015992951A8.

- 8 Click **Apply**, and then click **OK**. The machine will automatically print the **Network Configuration Report**. Confirm that all the settings are correct.

IPv4 configuration using SetIP (Mac)

Before using the SetIP program, disable the computer firewall from **System Preferences > Security > Firewall**.



The following instructions may vary from your model.

- 1 Connect your machine to the network with a network cable.
- 2 Insert the supplied software CD into your CD-ROM drive.

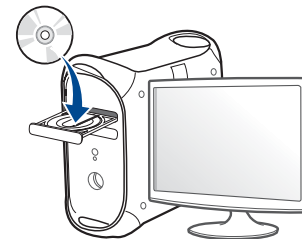

- 3 Double-click the CD-ROM icon that appears on your Mac desktop.
 - For Mac OS X 10.8, Double-click the CD-ROM that appears on Finder.
- 4 Double-click the **MAC_Installer** folder > **Installer OS X** icon.
- 5 Click **Continue**.
- 6 Read the license agreement and click **Continue**.
- 7 Click **Agree** to agree to the license agreement.

Wired network setup

- 8 Click **Install**. All components necessary for machine operations will be installed.
If you click **Customize**, you can choose individual components to install.
- 9 Enter the password and click **OK**.
- 10 Select **Network connection** on the **Printer Connection Type** and click **Set IP Address** button.
- 11 Click the  icon in the SetIP window to open the TCP/IP configuration window.
- 12 Enter the machine's new information into the configuration window. In a corporate intranet, you may need to have this information assigned by a network manager before proceeding.

 Find the machine's MAC address from the **Network Configuration Report** (see "Printing a network configuration report" on page 130) and enter it without the colons. For example, 00:15:99:29:51:A8 becomes 0015992951A8.

- 13 Click **Apply**, and then click **OK**. The machine will automatically print the **Network Configuration Report**. Confirm that all the settings are correct.

IPv4 configuration using SetIP (Linux)

Before using the SetIP program, disable the computer firewall from **System Preferences** or **Administrator**.



The following instructions may vary from your model or operating systems.

- 1 Open `/opt/Samsung/mfp/share/utlis/`.
- 2 Double-click the **SetIPApplet.html** file.
- 3 Click to open the TCP/IP configuration window.
- 4 Enter the machine's new information into the configuration window. In a corporate intranet, you may need to have this information assigned by a network manager before proceeding.



Find the machine's MAC address from the **Network Configuration Report** (see "Printing a network configuration report" on page 130) and enter it without the colons. For example, 00:15:99:29:51:A8 becomes 0015992951A8.

- 5 The machine will automatically print the **Network Configuration Report**.

Installing driver over the network



- Some features and optional goods may not be available depending on model or country (see "Features by models" on page 8).
- The machine that does not support the network interface, it will not be able to use this feature (see "Rear view" on page 21).
- You can install the printer driver and software when you insert the software CD into your CD-ROM drive.

For Windows, select the printer driver and software in the **Select Software to Install** window.

Installing driver over the network

Windows

- 1 Make sure that the machine is connected to the network and powered on. Also, your machine's IP address should have been set (see "Setting IP address" on page 130).
- 2 Insert the supplied software CD into your CD-ROM drive.



If the installation window does not appear, click **Start > All programs > Accessories > Run**.

X:\Setup.exe replacing "X" with the letter, which represents your CD-ROM drive and click **OK**.

- For Windows 8,

If the installation window does not appear, from **Charms**, select **Search > Apps** and search for **Run**. Type in X:\Setup.exe, replacing "X" with the letter that represents your CD-ROM drive and click **OK**.

If "**Tap to choose what happens with this disc.**" pop-up window appears, click the window and select **Run Setup.exe**.

- 3 Read and accept **The software End User License Agreement** and

Using **Enhanced Features and Participating in Printer Usage Information Collection Program** (optional). Then, click **Next**.

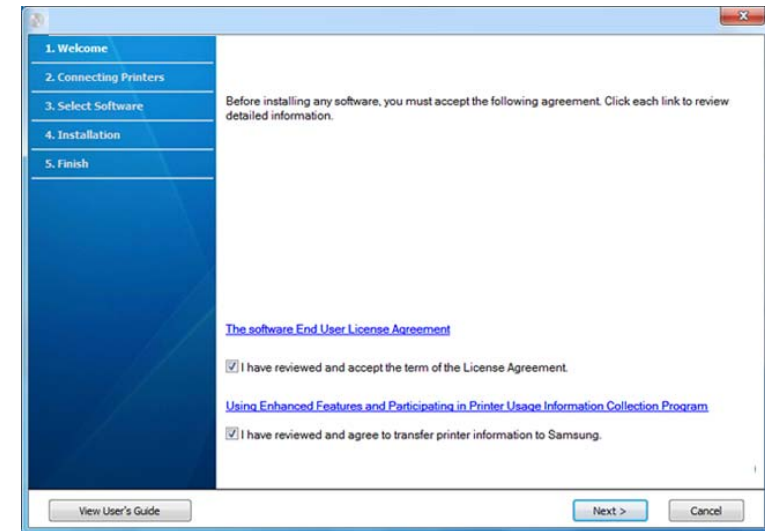

- 4 Select **Network connection** on the **Printer Connection Type** screen.
- 5 If the **Connected Device** window appears, check that the machine is connected to your network. Then, click **Next**.



The firewall software might be blocking network communication. Before connecting the device to the network, disable the computer's firewall.

- 6 The searched machines will be shown on the screen. Select the one you wish to use and click **OK**.
- 7 Follow the instructions in the installation window.

Installing driver over the network

From the Windows 8 Start Screen



- **Samsung Printer Experience** app can only be used in the **Start** screen when V4 driver is installed. The V4 driver is automatically downloaded from the Windows Update if your computer is connected to the Internet. If not, you can manually download the V4 driver from Samsung website, www.samsung.com > find your product > Support or downloads.
- You can download **Samsung Printer Experience** app from the **Windows Store**. You need have a Microsoft account to use the Windows Store.
 - a From **Charms**, select **Search**.
 - b Click **Store**.
 - c Search and click **Samsung Printer Experience**.
 - d Click **Install**.
- If you install the driver using the supplied software CD, V4 driver is not installed. If you want to use the V4 driver in the **Desktop** screen, you can download from the Samsung website, www.samsung.com > find your product > Support or downloads.
- If you want to install Samsung's printer management tools, you need to install them using the supplied software CD.

1 Make sure that the machine is connected to the network and powered on. Also, your machine's IP address should have been set (see "Setting IP address" on page 130).

2 From **Charms**, select **Settings** > **Change PC settings** > **Devices**.

3 Click **Add a device**.

Discovered machines will be shown on the screen.

4 Click the model name or host name you wish to use.



You can print a Network Configuration Report from the machine's control panel that will show the current machine's host name (see "Printing a network configuration report" on page 161).

5 The driver is automatically installed from the **Windows Update**.

Silent installation Mode

Silent installation mode is an installation method that does not require any user intervention. Once you start the installation, the machine driver and software are automatically installed on you computer. You can start the silent installation by typing **/s** or **/S** in the command window.



Command-line Parameters

Following table shows commands that can be used in the command window.



Following command-line are effective and operated when command is used with **/s** or **/S**. But **/h**, **/H** or **/?** are exceptional commands that can be operated solely.

Installing driver over the network

Command- line	Definition	Description
/s or /S	Starts silent installation.	Installs machine drivers without prompting any UIs or user intervention.
/p"<port name>" or /P"<port name>"	Specifies printer port.  Network Port will be created by use of Standard TCP/IP Port monitor. For local port, this port must exist on system before being specified by command.	Printer port name can be specified as IP address, hostname, USB local port name or IEEE1284 port name. For example: <ul style="list-style-type: none"> • /p"xxx.xxx.xxx.xxx" in where, "xxx.xxx.xxx.xxx" means IP address for network printer. /p"USB001", /P"LPT1:", /p"hostname"
/a"<dest_path>" or /A"<dest_path>"	Specifies destination path for installation.  The destination path should be a fully qualified path.	Since machine drivers should be installed on the OS specific location, this command applies to only application software.

Command- line	Definition	Description
/n"<Printer name>" or /N"<Printer name>"	Specifies printer name. Printer instance shall be created as specified printer name.	With this parameter, you can add printer instances as your wishes.
/nd or /ND	Commands not to set the installed driver as a default machine driver.	It indicates installed machine driver will not be the default machine driver on your system if there are one or more printer drivers installed. If there is no installed machine driver on your system, then this option won't be applied because Windows OS will set installed printer driver as a default machine driver.
/x or /X	Uses existing machine driver files to create printer instance if it is already installed.	This command provides a way to install a printer instance that uses installed printer driver files without installing an additional driver.

Installing driver over the network

Command- line	Definition	Description
/up"<printer name>" or /UP"<printer name>"	Removes only specified printer instance and not the driver files.	This command provides a way to remove only specified printer instance from your system without effecting other printer drivers. It will not remove printer driver files from your system.
/d or /D	Uninstalls all device drivers and applications from your system.	This command will remove all installed device drivers and application software from your system.
/v"<share name>" or /V"<share name>"	Shares installed machine and add other available platform drivers for Point & Print.	It will install all supported Windows OS platform's machine drivers to system and share it with specified <share name> for point and print.
/o or /O	Opens Printers and Faxes folder after installation.	This command will open Printers and Faxes folder after the silent installation.
/h, /H or /?	Shows Command-line Usage.	

Mac

- 1 Make sure that the machine is connected to your network and powered on.
- 2 Insert the supplied software CD into your CD-ROM drive.

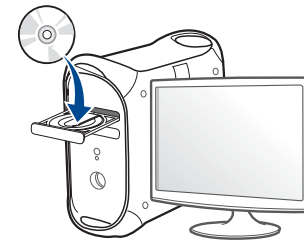

- 3 Double-click the CD-ROM icon that appears on your Mac desktop.
 - For Mac OS X 10.8, double-click the CD-ROM that appears on **Finder**.
- 4 Double-click the **MAC_Installer** folder > **Installer OS X** icon.
- 5 Click **Continue**.
- 6 Read the license agreement and click **Continue**.
- 7 Click **Agree** to agree to the license agreement.
- 8 Click **Install**. All components necessary for machine operations will be installed.
If you click **Customize**, you can choose individual components to install.

Installing driver over the network

- 9 Enter the password and click **OK**.
- 10 Select **Network connection** on the **Printer Connection Type** and click **Continue**.
- 11 Click **Add Printer** button to select your printer and add it to your printer list.
- 12 Click **IP** and select **HP Jetdirect - Socket** in **Protocol**.
- 13 Enter the machine's IP address in the **Address** input field.
- 14 Enter the queue name in the **Queue** input field. If you cannot determine the queue name for your machine server, try using the default queue first.
- 15 If Auto Select does not work properly, choose **Select Printer Software** and your machine name in **Print Using**.
- 16 Click **Add**.
- 17 After the installation is finished, click **Close**.

Linux

You need to download Linux software packages from the Samsung website to install the printer software (<http://www.samsung.com> > find your product > Support or Downloads).

Install the Linux driver and add network printer

- 1 Make sure that the machine is connected to your network and powered on. Also, your machine's IP address should have been set.
- 2 Download the Unified Linux Driver package from the Samsung website.
- 3 Extract the UnifiedLinuxDriver.tar.gz file and open the new directory.
- 4 Double-click the **cdroot > autorun**.
- 5 The Samsung installer window opens. Click **Next**.
- 6 The add printer wizard window opens. Click **Next**.
- 7 Select network printer and click **Search** button.
- 8 The machine's IP address and model name appears on list field.
- 9 Select your machine and click **Next**.
- 10 Input the printer description and **Next**.
- 11 After the machine is added, click **Finish**.
- 12 When installation is done, click **Finish**.

Installing driver over the network

Add a network printer

- 1 Double-click the **Unified Driver Configurator**.
- 2 Click **Add Printer**.
- 3 The **Add printer wizard** window opens. Click **Next**.
- 4 Select **Network printer** and click the **Search** button.
- 5 The printer's IP address and model name appears on list field.
- 6 Select your machine and click **Next**.
- 7 Enter the printer description and click **Next**.
- 8 After the machine is added, click **Finish**.

UNIX



- Make sure your machine supports the UNIX operating system before installing the UNIX printer driver (see "Operating System" on page 8).
- The commands are marked with "", when typing the commands, do not type "".
- Some features and optional goods may not be available depending on model or country (see "Operating System" on page 8).

To use the UNIX printer driver, you have to install the UNIX printer driver package first, then setup the printer. You can download the UNIX printer driver package from the Samsung website (<http://www.samsung.com> > find your product > Support or Downloads).

Installing the UNIX printer driver package

The installation procedure is common for all variants of UNIX OS mentioned.

- 1 From the Samsung website, download and unpack the UNIX Printer Driver package to your computer.
- 2 Acquire root privileges.
"su -"
- 3 Copy the appropriate driver archive to the target UNIX computer.



See administration guide of your UNIX OS for details.

- 4 Unpack the UNIX printer driver package.
For example, on IBM AIX, use the following commands.
"gzip -d < enter the package name | tar xf -"
- 5 Go to the unpacked directory.

Installing driver over the network

6 Run the install script.

`./install -i`

install is the installer script file which is used to install or uninstall the UNIX Printer Driver package.

Use `chmod 755 install` command to give the permission to the installer script.

7 Execute the `./install -c` command to verify installation results.

8 Run `installprinter` from the command line. This will bring up the **Add Printer Wizard** window. Setup the printer in this window referring to the following procedures.



On some UNIX OS, for example on Solaris 10, just added printers may not be enabled and/or may not accept jobs. In this case run the following two commands on the root terminal:

```
"accept <printer_name>"
```

```
"enable <printer_name>"
```

Uninstalling the printer driver package



The utility should be used to delete the printer installed in the system.

a Run `uninstallprinter` command from the terminal.

It will open the **Uninstall Printer Wizard**.

The installed printers are listed in the drop-down list.

b Select the printer to be deleted.

c Click **Delete** to delete the printer from the system.

d Execute the `./install -d` command to uninstall the whole package.

e To verify removal results, execute the `./install -c` command.

To re-install it, use the command `./install -i` to reinstall the binaries.

Setting up the printer

To add the printer to your UNIX system, run `installprinter` from the command line. This will bring up the Add Printer Wizard window. Setup the printer in this window according to the following steps:

1 Type the name of the printer.

2 Select the appropriate printer model from the model list.

3 Enter any description corresponding to the type of the printer in the **Type** field. This is optional.

Installing driver over the network

- 4 Specify any printer description in the **Description** field. This is optional.
- 5 Specify the printer location in the **Location** field.
- 6 Type the IP address or DNS name of the printer in the **Device** textbox for network-connected printers. On IBM AIX with **jetdirect Queue type**, only the DNS name is possible-numeric IP address is not allowed.
- 7 **Queue type** shows the connection as **lpd** or **jetdirect** in the corresponding list box. Additionally, **usb** type is available on Sun Solaris OS.
- 8 Select **Copies** to set the number of copies.
- 9 Check the **Collate** option to receive copies already sorted.
- 10 Check the **Reverse Order** option to receive copies in the reverse order.
- 11 Check the **Make Default** option to set this printer as default.
- 12 Click **OK** to add the printer.

IPv6 configuration



IPv6 is supported properly only in Windows Vista or higher.



- Some features and optional goods may not be available depending on model or country (see "Features by models" on page 8 or "Menu overview" on page 30).
- If the IPv6 network seems to not be working, set all the network setting to the factory defaults and try again using **Clear Setting**.

The machine supports the following IPv6 addresses for network printing and managements.

- **Link-local Address:** Self-configured local IPv6 address (Address starts with FE80).
- **Stateless Address:** Automatically configured IPv6 address by a network router.
- **Stateful Address:** IPv6 address configured by a DHCPv6 server.
- **Manual Address:** Manually configured IPv6 address by a user.

In the IPv6 network environment, follow the next procedure to use the IPv6 address.

From the control panel

Activating IPv6



- Accessing menus may differ from model to model (see "Accessing the menu" on page 30).
- It may be necessary to press **OK** to navigate to lower-level menus for some models.

- 1 Select  **(Menu) > Network > TCP/IP (IPv6) > IPv6 Protocol** on the control panel.
- 2 Select **On** and press **OK**.
- 3 Turn the machine off and turn it on again.



When you install the printer driver, do not configure both IPv4 and IPv6. We recommend to configure either IPv4 or IPv6.

DHCPv6 address configuration

If you have a DHCPv6 server on your network, you can set one of the following options for default dynamic host configuration.

IPv6 configuration



- Accessing menus may differ from model to model (see "Accessing the menu" on page 30).
- It may be necessary to press **OK** to navigate to lower-level menus for some models.

- 1 Select  (**Menu**) > **Network** > **TCP/IP (IPv6)** > **DHCPv6 Config** on the control panel.
- 2 Press **OK** to select the required value you want.
 - **Router:** Use DHCPv6 only when requested by a router.
 - **Always Use:** Always use DHCPv6 regardless of router request.
 - **Never Use:** Never use DHCPv6 regardless of router request.

From the SyncThru™ Web Service

Activating IPv6

- 1 Access a web browser, such as Internet Explorer, from Windows. Enter the machine IP address (<http://xxx.xxx.xxx.xxx>) in the address field and press the Enter key or click **Go**.
- 2 If it's your first time logging into **SyncThru™ Web Service** you need to log-in as an administrator. Type in the below default ID and password. We recommend you to change the default password for security reasons.
 - **ID: admin**
 - **Password: sec00000**
- 3 When the **SyncThru™ Web Service** window opens, move the mouse cursor over the **Settings** of the top menu bar and then click **Network Settings**.
- 4 Click **TCP/IPv6** on the left pane of the website.
- 5 Check the **IPv6 Protocol** check box to activate IPv6.
- 6 Click the **Apply** button.
- 7 Turn the machine off and turn it on again.

IPv6 configuration



- You can also set the DHCPv6.
- To manually set the IPv6 address:
Check the **Manual Address** check box. Then, the **Address/Prefix** text box is activated. Enter the rest of the address (e.g., :3FFE:10:88:194::**AAAA**. "A" is the hexadecimal 0 through 9, A through F).



Address must be enclosed in '[']' brackets.

IPv6 address configuration

- 1 Start a web browser, such as Internet Explorer, that supports IPv6 addressing as a URL.
- 2 Select one of the IPv6 addresses (**Link-local Address**, **Stateless Address**, **Stateful Address**, **Manual Address**) from **Network Configuration Report** (see "Printing a network configuration report" on page 130).
 - **Link-local Address:** Self-configured local IPv6 address (Address starts with FE80).
 - **Stateless Address:** Automatically configured IPv6 address by a network router.
 - **Stateful Address:** IPv6 address configured by a DHCPv6 server.
 - **Manual Address:** Manually configured IPv6 address by a user.
- 3 Enter the IPv6 addresses (e.g., : http://[FE80::215:99FF:FE66:7701]).

Wireless network setup



- Make sure your machine supports wireless networking. Wireless networking may not be available depending on the model (see "Features by models" on page 8).
- If the IPv6 network seems to not be working, set all the network settings to the factory defaults and try again using **Clear Setting**.

Getting started

Understanding your network type

Typically, you can only have one connection between your computer and the machine at a time.

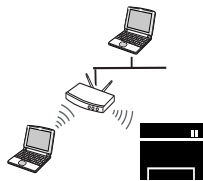

Infrastructure mode

This is an environment generally used for homes and SOHOs (Small Office/ Home Office). This mode uses an access point to communicate with the wireless machine.

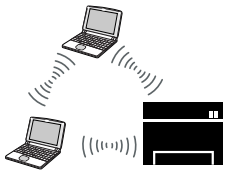

Ad hoc mode

This mode does not use an access point. The wireless computer and wireless machine communicate directly.

Wireless network name and network password

Wireless networks require higher security, so when an access point is first set up, a network name (SSID), the type of security used, and a Network Password are created for the network. Ask your network administrator about this information before proceeding with the machine installation.







Wireless network setup

Introducing wireless set up methods



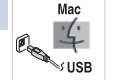



You can set wireless settings either from the machine or the computer. Choose the setting method from the below table.



Some wireless network installation types may not be available depending on the model or country.

Set up method	Connecting method		Description & Reference
With Access Point 	From the computer 	A 	Windows user, see "Access point via USB cable (recommended)" on page 152.
		B 	Mac user, see "Access point via USB cable (recommended)" on page 157.
		C 	See "Using a network cable" on page 160.
	From the machine's control panel 	D 	See "Machines with a display screen" on page 149.
		E 	See "Using the menu button" on page 151.

Wireless network setup

Set up method	Connecting method		Description & Reference
Without Access Point 	From the computer Ad-hoc 	F 	Windows user, see "Ad hoc via USB cable" on page 154.
		G 	Mac user, see "Ad hoc via USB cable" on page 158.
	Wi-Fi Direct setup Wi-Fi Direct 	H 	See "Setting the Wi-Fi Direct for mobile printing" on page 163.



- If problems occur during wireless set up or driver installation, refer to the troubleshooting chapter (see "Troubleshooting for wireless network" on page 165).
- It is strongly recommended that you set the password on Access Points. If you do not set the password on Access Points, they might be exposed to illegal access from unknown machine including PCs, smart phones and printers. Refer to the Access Point user guide for password settings.

Wireless network setup

Using the WPS button

If your machine and an access point (or wireless router) support Wi-Fi Protected Setup™ (WPS), you can easily configure the wireless network settings by pressing the  (WPS) button on the control panel without a computer.





- If you want to use the wireless network using the infrastructure mode, make sure that the network cable is disconnected from the machine. Using the **WPS (PBC)** button or entering the PIN from the computer to connect to the access point (or wireless router) varies depending on the access point (or wireless router) you are using. Refer to the user's guide of the access point (or wireless router) you are using.
- When using the WPS button to set the wireless network, security settings may change. To prevent this, lock the WPS option for the current wireless security settings. The option name may differ depending on the access point (or wireless router) you are using.

Items to prepare

- Check if the access point (or wireless router) supports Wi-Fi Protected Setup™ (WPS).
- Check if your machine supports Wi-Fi Protected Setup™ (WPS).
- Networked computer (PIN mode only)

Choosing your type

There are two methods available to connect your machine to a wireless network using the  (WPS) button on the control panel.

The **Push Button Configuration (PBC)** method allows you to connect your machine to a wireless network by pressing both the  (WPS) button on the control panel of your machine and the WPS (PBC) button on a Wi-Fi Protected Setup™ WPS-enabled access point (or wireless router) respectively.

The **Personal Identification Number (PIN)** method helps you connect your machine to a wireless network by entering the supplied PIN information on a Wi-Fi Protected Setup™ WPS-enabled access point (or wireless router).

Factory default in your machine is **PBC** mode, which is recommended for a typical wireless network environment.





You can change the WPS mode from the control panel  (**Menu**) > **Network** > **Wi-Fi** > **WPS**).

Wireless network setup

Machines with a display screen

Connecting in PBC mode

- 1 Select  (**Menu**) > **Network** > **Wi-Fi** > **WPS** > **ConnectViaPBC** on the control panel.

Or press and hold the  (WPS) button on the control panel for more than 2 seconds.

The machine starts waiting for up to two minutes until you press the WPS (PBC) button on the access point (or wireless router).

- 2 Press the **WPS (PBC)** button on the access point (or wireless router).
The messages are displayed on the display screen in the order below:
 - a **Connecting:** The machine is connecting to the access point (or wireless router).
 - b **Connected:** When the machine is successfully connected to the wireless network, the WPS LED light stays on.
 - c **AP SSID:** After completing the wireless network connection process, the AP's SSID information appears on the display.
- 3 Insert the supplied software CD into your CD-ROM drive, and follow the instructions in the window to set up the wireless network.

Connecting in PIN mode

- 1 Select  (**Menu**) > **Network** > **Wi-Fi** > **WPS** > **ConnectViaPIN** on the control panel.

Or press and hold the  (WPS) button on the control panel for more than 2 seconds.

- 2 The eight-digit PIN appears on the display.
You need to enter the eight-digit PIN within two minutes on the computer that is connected to the access point (or wireless router).
The messages are displayed on the display screen in the order below:
 - a **Connecting:** The machine is connecting to the wireless network.
 - b **Connected:** When the machine is successfully connected to the wireless network, the WPS LED light stays on.
 - c **SSID Type:** After completing the wireless network connection process, the AP's SSID information is displayed on the LCD display.
- 3 Insert the supplied software CD into your CD-ROM drive, and follow the instructions in the window to set up the wireless network.

Wireless network setup

Machines without a display screen



Connecting in PBC mode

- 1 Press and hold the  (WPS) button on the control panel for about 2 - 4 seconds until the status LED blinks quickly.

The machine starts connecting to the wireless network. The LED blinks slowly for up to two minutes until you press the PBC button on the access point (or wireless router).
- 2 Press the **WPS (PBC)** button on the access point (or wireless router).
 - a The light blinks fast on the WPS LED. The machine is connecting to the access point (or wireless router).
 - b When the machine is successfully connected to the wireless network, the WPS LED light stays on.
- 3 Insert the supplied software CD into your CD-ROM drive, and follow the instructions in the window to set up the wireless network.

Connecting in PIN mode

- 1 The network configuration report, including PIN, must be printed (see "Printing a network configuration report" on page 130).

In ready mode, press and hold the  (**Stop/Clear**) button on the control panel for about 5 seconds. You can find your machine's PIN.
- 2 Press and hold the  (WPS) button on the control panel for more than 4 seconds until the status LED stays on.

The machine starts connecting to the access point (or wireless router).
- 3 You need to enter the eight-digit PIN within two minutes on the computer that is connected to the access point (or wireless router).

The LED blinks slowly for up to two minutes until you enter the eight-digit PIN.

The WPS LED blinks in the order below:
 - a The light blinks fast on the WPS LED. The machine is connecting to the access point (or wireless router).
 - b When the machine is successfully connected to the wireless network, the WPS LED light stays on.
- 4 Insert the supplied software CD into your CD-ROM drive, and follow the instructions in the window to set up the wireless network.

Wireless network setup

Re-connecting to a network

When the wireless function is off, the machine automatically tries to re-connect to the access point (or wireless router) with the previously used wireless connection settings and address.



In the following cases, the machine automatically re-connects to the wireless network:

- The machine is turned off and on again.
- The access point (or wireless router) is turned off and on again.

Canceling the connection process

To cancel the wireless network connection when the machine is connecting to the wireless network, press and release the  (**Stop/Clear**) on the control panel. **You need to wait 2 minutes to re-connect to the wireless network.**

Disconnecting from a network

To disconnect the wireless network connection, press the  (WPS) button on the control panel for more than two seconds.

- **When the Wi-Fi network is in idle mode:** The machine is immediately disconnected from the wireless network and the WPS LED turns off.
- **When the Wi-Fi network is being used:** While the machine waits until the current job is finished, the light blinks fast on the WPS LED. Then, the wireless network connection is automatically disconnected and the WPS LED turns off.

Using the menu button



Some menus may not appear in the display depending on options or models. If so, it is not applicable to your machine (see "Features by models" on page 8).

Before starting, you will need to know the network name (SSID) of your wireless network and the network key if it is encrypted. This information was set when the access point (or wireless router) was installed. If you do not know about your wireless environment, please ask the person who set up your network.

Wireless network setup



After completing the wireless network connection, you need to install a machine driver to print from an application (see "Installing driver over the network" on page 133).

- 1 Select  (**Menu**) > **Network** > **Wi-Fi** > **Wi-Fi Settings** on the control panel.
- 2 Press the **OK** to select the setup method you want.
 - **Search List** (recommended): In this mode, the setup is automatic. The machine will display a list of available networks from which to choose. After a network is chosen then printer will prompt for the corresponding security key.
 - **Custom**: In this mode, users can give or edit manually their own SSID, or choose the security option in detail.

Setup using Windows



Shortcut to the **Samsung Easy Wireless Setup** program without the CD: If you have installed the printer driver once, you can access the **Samsung Easy Wireless Setup** program without the CD (see "Accessing management tools" on page 211).

Access point via USB cable (recommended)

Items to prepare

- Access point
- Network-connected computer
- Software CD that was provided with your machine
- A machine installed with a wireless network interface
- USB cable

Creating the infrastructure network

- 1 Turn on your computer, access point, and machine.
- 2 Insert the supplied software CD into your CD-ROM drive.

Wireless network setup

- 3 Read and accept **The software End User License Agreement** and **Using Enhanced Features and Participating in Printer Usage Information Collection Program** (optional). Then, click **Next**.

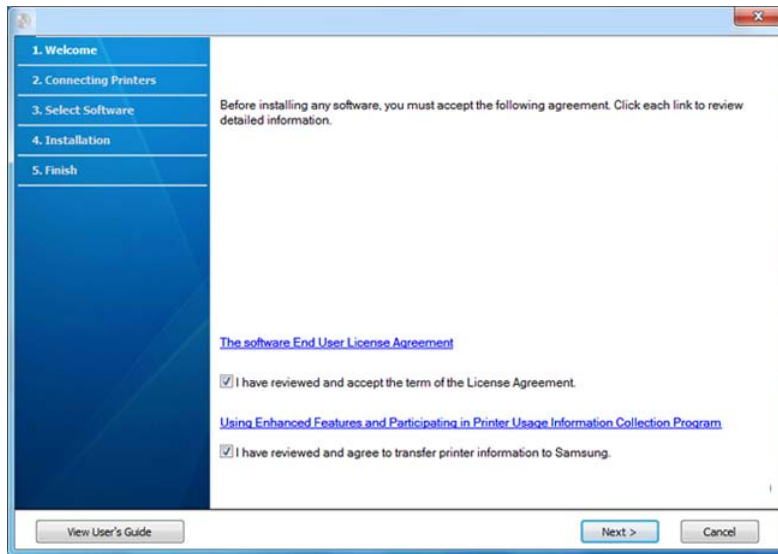

- 4 Select **Configure the wireless network connection using USB cable** on the **Printer Connection Type** screen. Then, click **Next**.

- 5 After searching, the window shows the wireless network devices. Select the name (SSID) of the access point you want to use and click **Next**.

If the wireless network is already set up, the **Wireless Network Information** window appears. Select **I want to install software with the current settings. (Recommended)**. Then, click **Next**.



If you cannot find the network name you want to choose, or if you want to set the wireless configuration manually, click **Advanced Setting**.

- **Enter the wireless Network Name:** Enter the SSID of the access point (SSID is case-sensitive).
- **Operation Mode:** Select **Infrastructure**.
- **Authentication:** Select an authentication type.
 - Open System:** Authentication is not used, and encryption may or may not be used, depending on the need for data security.
 - Shared Key:** Authentication is used. A device that has a proper WEP key can access the network.
 - WPA Personal or WPA2 Personal:** Select this option to authenticate the print server based on a WPA Pre-Shared Key. This uses a shared secret key (generally called Pre Shared Key pass phrase), which is manually configured on the access point and each of its clients.
- **Encryption:** Select the encryption (None, WEP64, WEP128, TKIP, AES, TKIP AES).
- **Network Password:** Enter the encryption network password value.
- **Confirm Network Password:** Confirm the encryption network password value.
- **WEP Key Index:** If you are using WEP Encryption, select the appropriate **WEP Key Index**.



The wireless network security window appears when the access point has security settings.

Enter the Network Password of the access point (or router).

Wireless network setup

6 When the network connection window appears, disconnect the network cable. Then, click **Next**. The network cable connection can interfere with searching for wireless devices.

7 If your printer supports Wi-Fi Direct, the following screen appears. Click **Next**.

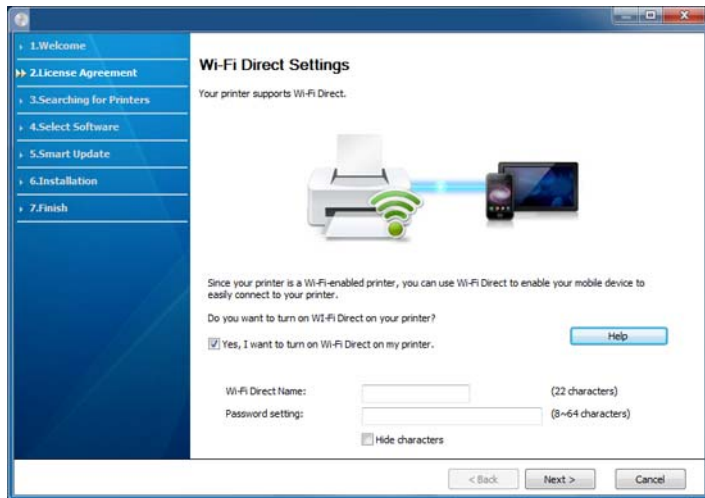

- Can start to build Wi-Fi Direct by using Samsung Easy Printer Manager (see "Setting up Wi-Fi Direct" on page 164).
- **Wi-Fi Direct Name:** The default Wi-Fi Direct Name is the model name and the maximum length is 22 characters.
- **Password setting** is the numeric string, and the size is 8 ~ 64 characters.

8 When the wireless network set up is completed, disconnect the USB cable between the computer and machine. Click **Next**.

9 Select the components to be installed.

10 After selecting the components, you can also change the machine name, set the machine to be shared on the network, set the machine as the default machine, and change the port name of each machine. Click **Next**.

11 If you want to register your machine with the Samsung web site and receive useful information, click **On-line Registration**. If not, click **Finish**.

Ad hoc via USB cable

If you do not have an access point (AP), you may still connect the machine wirelessly to your computer by setting up an ad-hoc wireless network by following the simple steps below.

Items to prepare

- Network-connected computer
- Software CD that was provided with your machine
- A machine installed with a wireless network interface
- USB cable

Wireless network setup

Creating the ad hoc network in Windows

- 1 Turn on your computer and the wireless network machine.
- 2 Insert the supplied software CD into your CD-ROM drive.
- 3 Read and accept **The software End User License Agreement** and **Using Enhanced Features and Participating in Printer Usage Information Collection Program** (optional). Then, click **Next**.

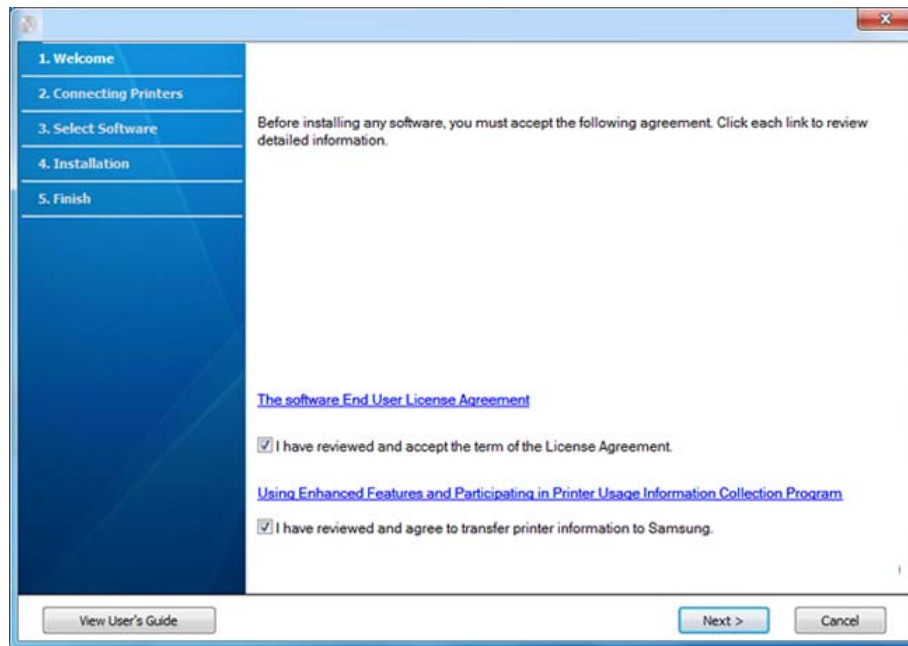

- 4 Select **Configure the wireless network connection using USB cable** on the **Printer Connection Type** screen.

- 5 After searching the wireless networks, a list of wireless networks your machine has searched appears. Click **Advanced Setting**.



- **Enter the wireless Network Name:** Enter the SSID name you want (SSID is case-sensitive).
- **Operation Mode:** Select ad hoc.
- **Channel:** Select the channel. (**Auto Setting** or 2412 MHz to 2467 MHz).
- **Authentication:** Select an authentication type.
 - **Open System:** Authentication is not used, and encryption may or may not be used, depending on the need for data security.
 - **Shared Key:** Authentication is used. A device that has a proper WEP key can access the network.
- **Encryption:** Select the encryption (None, WEP64, WEP128).
- **Network Password:** Enter the encryption network password value.
- **Confirm Network Password:** Confirm the encryption network password value.
- **WEP Key Index:** If you are using WEP Encryption, select the appropriate **WEP Key Index**.

The wireless network security window appears when the ad hoc network has security enabled.

Select **Open System** or **Shared Key** for the authentication and click **Next**.

- WEP (Wired Equivalent Privacy) is a security protocol preventing unauthorized access to your wireless network. WEP encrypts the data portion of each packet exchanged on a wireless network using a 64-bit or 128-bit WEP encryption key.

Wireless network setup

- 6 The window showing the wireless network setting appears. Check the settings and click **Next**.



Before entering the IP address for the machine, you must know the computer's network configuration information. If the computer's network configuration is set to DHCP, the wireless network setting should also be DHCP. Likewise, if the computer's network configuration is set to Static, the wireless network setting should also be Static.

If your computer is set to DHCP and you want to use the Static wireless network setting, you must contact the network administrator to get the static IP address.

- **For the DHCP method**

If the IP address assignment method is DHCP, check if DHCP is shown in the **Wireless Network Setting Confirm** window. If it shows Static, click **Change TCP/IP** to change the assignment method to **Receive IP address automatically (DHCP)**.

- **For the Static method**

If the IP address assignment method is Static, check if Static is shown in the **Wireless Network Setting Confirm** window. If it shows DHCP, click **Change TCP/IP** to enter the IP address and other network configuration values for the machine.

For example,

If the computer's network information is as shown follows:

- IP address: 169.254.133.42
- Subnet Mask: 255.255.0.0

Then, the machine's network information should be as below:

- IP address: 169.254.133.43

- Subnet Mask: 255.255.0.0 (Use the computer's subnet mask.)
- Gateway: 169.254.133.1

- 7 The **Wireless Network Setting Complete** window appears. Click **Next**.
- 8 When the wireless network settings are completed, disconnect the USB cable between the computer and machine. Click **Next**.
- 9 Select the components to be installed.
- 10 After selecting the components, you can also change the machine name, set the machine to be shared on the network, set the machine as the default machine, and change the port name of each machine. Click **Next**.
- 11 If you want to register your machine with the Samsung web site and receive useful information, click **On-line Registration**. If not, click **Finish**.

Setup using Mac

Items to prepare

- Access point
- Network-connected computer
- Software CD that was provided with your machine

Wireless network setup

- A machine installed with a wireless network interface
- USB cable

Access point via USB cable (recommended)

- 1 Check whether the USB cable is connected to the machine.
- 2 Turn on your computer, access point, and machine.
- 3 Insert the supplied software CD into your CD-ROM drive.
- 4 Double-click the CD-ROM icon that appears on your Mac desktop.
- 5 Double-click the **MAC_Installer** folder > **Installer OS X** icon.
- 6 Click **Continue**.
- 7 Read the license agreement and click **Continue**.
- 8 Click **Agree** to agree to the license agreement.
- 9 When the message that warns that all applications will close on your computer appears, click **Continue**.
- 10 Click **Wireless Network Setting** button on the **User Options Pane**.

- 11 After searching, the window shows the wireless network devices. Select the name (SSID) of the access point you want to use and click **Next**.

If the wireless network is already set up, the **Wireless Network Information** window appears. Select **I want to install software with the current settings. (Recommended)**. Then, click **Next**.



When you set the wireless configuration manually, click **Advanced Setting**.

- **Enter the wireless Network Name:** Enter the SSID of the access point (SSID is case-sensitive).
- **Operation Mode:** Select **Infrastructure**.
- **Authentication:** Select an authentication type.
 - Open System:** Authentication is not used, and encryption may or may not be used, depending on the need for data security.
 - Shared Key:** Authentication is used. A device that has a proper WEP key can access the network.
 - WPA Personal or WPA2 Personal:** Select this option to authenticate the print server based on the WPA Pre-Shared Key. This uses a shared secret key (generally called Pre Shared Key pass phrase) that is manually configured on the access point and each of its clients.
- **Encryption:** Select the encryption. (None, WEP64, WEP128, TKIP, AES, TKIP, AES)
- **Network Password:** Enter the encryption network password value.
- **Confirm Network Password:** Confirm the encryption network password value.
- **WEP Key Index:** If you are using WEP Encryption, select the appropriate **WEP Key Index**.

Wireless network setup

The wireless network security window appears when the access point has security enabled.

Enter the Network Password of the access point (or router).

12 If your printer supports Wi-Fi Direct, the following screen appears.

Click **Next**.

Wireless Settings

Wi-Fi Direct Settings

Your printer supports Wi-Fi Direct.

Since your printer is a Wi-Fi-enabled printer, you can use Wi-Fi Direct to enable your mobile device to easily connect to your printer.

Do you want to turn on Wi-Fi Direct on your printer?

Yes, I want to turn on Wi-Fi Direct on my printer. Help

Wi-Fi Direct Name: (23 characters)

Password setting: (8-64 characters)

Hide characters

< Back Next > Cancel



- Can start to build Wi-Fi Direct by using Samsung Easy Printer Manager (see "Setting up Wi-Fi Direct" on page 164).
- **Wi-Fi Direct Name:** The default Wi-Fi Direct Name is the model name and the maximum length is 22 characters.
- **Password setting** is the numeric string, and the size is 8 ~ 64 characters.

13 When the wireless network settings are completed, disconnect the USB cable between the computer and machine.

14 Wireless network set up is completed. After the installation is finished, click **Quit**.



After completing the wireless network connection, you need to install a machine driver to print from an application (see "Installation for Mac" on page 124).

Ad hoc via USB cable

If you do not have an access point (AP), you may still connect the machine wirelessly to your computer by setting up an ad hoc wireless network by following these simple directions.

Wireless network setup

Items to prepare

- Network-connected computer
- Software CD that was provided with your machine
- A machine installed with a wireless network interface
- USB cable

Creating the ad hoc network in Mac

- 1 Check whether the USB cable is connected to the machine.
- 2 Turn on your computer and the wireless network machine.
- 3 Insert the supplied software CD into your CD-ROM drive.
- 4 Double-click the CD-ROM icon that appears on your Mac desktop.
- 5 Double-click the **MAC_Installer** folder > **Installer OS X** icon.
- 6 Click **Continue**.
- 7 Read the license agreement and click **Continue**.
- 8 Click **Agree** to agree to the license agreement.
- 9 When the message that warns that all applications will close on your computer appears, click **Continue**.
- 10 Click **Wireless Network Setting** button on the **User Options Pane**.

- 11 After searching the wireless networks, a list of wireless networks your machine has searched appears. Click **Advanced Setting**.



- **Enter the wireless Network Name:** Enter the SSID name (SSID is case-sensitive).
- **Operation Mode:** Select ad hoc.
- **Channel:** Select the channel (**Auto Setting** or 2412 MHz to 2467 MHz).
- **Authentication:** Select an authentication type.
Open System: Authentication is not used, and encryption may or may not be used, depending on the need for data security.
Shared Key: Authentication is used. A device that has a proper WEP key can access the network.
- **Encryption:** Select the encryption (None, WEP64, WEP128).
- **Network Password:** Enter the encryption network password value.
- **Confirm Network Password:** Confirm the encryption network password value.
- **WEP Key Index:** If you are using WEP Encryption, select the appropriate **WEP Key Index**.

The wireless network security window appears when the ad hoc network has security setting.

Select **Open System** or **Shared Key** for the authentication and click **Next**.

- WEP (Wired Equivalent Privacy) is a security protocol preventing unauthorized access to your wireless network. WEP encrypts the data portion of each packet exchanged on a wireless network using a 64-bit or 128-bit WEP encryption key.

Wireless network setup

- 12** The window showing the wireless network settings appears. Check the settings and click **Next**.



Before entering the IP address for the machine, you must know the computer's network configuration information. If the computer's network configuration is set to DHCP, the wireless network setting should also be DHCP. Likewise, if the computer's network configuration is set to Static, the wireless network setting should also be Static.

If your computer is set to DHCP and you want to use Static wireless network setting, you must contact the network administrator to get the static IP address.

- **For the DHCP method**

If the IP address assignment method is DHCP, check if DHCP is shown in the **Wireless Network Setting Confirm** window. If it shows Static, click **Change TCP/IP** to change the assignment method to **Receive IP address automatically (DHCP)**.

- **For the Static method**

If the IP address assignment method is Static, check if Static is shown in the **Wireless Network Setting Confirm** window. If it shows DHCP, click **Change TCP/IP** to enter the IP address and other network configuration values for the machine.

For example,

If the computer's network information is shown as follows:

- IP address: 169.254.133.42
- Subnet Mask: 255.255.0.0

Then, the machine's network information should be as shown below:

- IP address: 169.254.133.**43**

- Subnet Mask: 255.255.0.0 (Use the computer's subnet mask.)
- Gateway: 169.254.133.**1**

- 13** When the window that tells you that the network cable connection is confirmed appears, disconnect the network cable and click **Next**.

If the network cable is connected, it may have trouble finding the machine when configuring the wireless network.

- 14** The wireless network connects according to the network configuration.

- 15** Wireless network set up is completed. After installation is finished, click **Quit**.



After completing the wireless network connection, you need to install a machine driver to print from an application (see "Installation for Mac" on page 124).

Using a network cable



Machines that do not support the network port will not be able to use this feature (see "Rear view" on page 21).

Wireless network setup

Your machine is a network compatible machine. To enable your machine to work with your network, you will need to perform some configuration procedures.



- After completing the wireless network connection, you need to install a machine driver to print from an application (see "Installing driver over the network" on page 133).
- See your network administrator, or the person that set up your wireless network, for information about your network configuration.

Items to prepare

- Access point
- Network-connected computer
- Software CD that was provided with your machine
- A machine installed with a wireless network interface
- Network cable

Printing a network configuration report

You can identify the network settings of your machine by printing a network configuration report.

See "Printing a network configuration report" on page 130.

IP setting using SetIP Program (Windows)

This program is used to manually set the network IP address of your machine using its MAC address to communicate with the machine. The MAC address is the hardware serial number of the network interface and can be found in the **Network Configuration Report**.

See "Setting IP address" on page 130.

Configuring the machine's wireless network

Before starting you will need to know the network name (SSID) of your wireless network and the network key if it is encrypted. This information was set when the access point (or wireless router) was installed. If you do not know about your wireless environment, please ask the person who set up your network.

To configure wireless parameters, you can use **SyncThru™ Web Service**.

Using SyncThru™ Web Service

Before starting wireless parameter configuration, check the cable connection status.

Wireless network setup

1 Check whether or not the network cable is connected to the machine. If not, connect the machine with a standard network cable.

2 Start a web browser such as Internet Explorer, Safari, or Firefox and enter your machine's new IP address in the browser window.

For example,



http://192.168.1.133/

3 Click **Login** on the upper right of the SyncThru™ Web Service website.

4 Type in the **ID** and **Password** then click **Login**. We recommend you to change the default password for security reasons.

- **ID: admin**
- **Password: sec00000**

5 When the **SyncThru™ Web Service** window opens, click **Network Settings**.

6 Click **Wireless > Wizard**.



Wizard will help you setup the wireless network configuration. However, if you want to set the wireless network directly, select **Custom**.

7 Select the one **Network Name(SSID)** in the list.

- **SSID:** SSID (Service Set Identifier) is a name that identifies a wireless network, access points, and wireless devices attempting to connect to a specific wireless network must use the same SSID. The SSID is case sensitive.
- **Operation Mode: Operation Mode** refers to the type of wireless connections (see "Wireless network name and network password" on page 145).
 - **Ad-hoc:** Allows wireless devices to communicate directly with each other in a peer-to-peer environment.
 - **Infrastructure:** Allows wireless devices to communicate with each other through an access point.



If your network's **Operation Mode** is **Infrastructure**, select the SSID of the access point. If the **Operation Mode** is **Ad-hoc**, select the machine's SSID.

8 Click **Next**.

If the wireless security setting window appears, enter the registered password (network password) and click **Next**.

9 The confirmation window appears, please check your wireless setup. If the setup is right, click **Apply**.

Wireless network setup



Disconnect the network cable (standard or network). Your machine should then start communicating wirelessly with the network. In case of Ad-hoc mode, you can use a wireless LAN and wired LAN simultaneously.

- 10 Insert the supplied software CD into your CD-ROM drive, and follow the instructions in the window to set up the wireless network.

Turning the Wi-Fi network on/off



If your machine has a display, you can also turn on/off the Wi-Fi from the machine's control panel using the **Network** menu.

- 1 Check whether the network cable is connected to the machine. If not, connect the machine with a standard network cable.
- 2 Start a web browser such as Internet Explorer, Safari, or Firefox and enter your machine's new IP address in the browser window.

For example,

 http://192.168.1.133/

- 3 Click **Login** on the upper right of the SyncThru™ Web Service website.

- 4 Type in the **ID** and **Password**, then click **Login**. We recommend you to change the default password for security reasons.

- **ID: admin**
- **Password: sec00000**

- 5 When the **SyncThru™ Web Service** window opens, click **Network Settings**.

- 6 Click **Wireless > Custom**.

You can also turn the Wi-Fi network on/off.

Setting the Wi-Fi Direct for mobile printing

Wi-Fi Direct is an easy-to-setup peer-to-peer connection method between the Wi-Fi Direct certified printer and a mobile device that provides a secure connection and better throughput than ad hoc mode.

With Wi-Fi Direct, you can connect your printer to a Wi-Fi Direct network while concurrently connecting to an access point. You can also use a wired network and a Wi-Fi Direct network simultaneously so multiple users can access and print documents both from Wi-Fi Direct and from a wired network.

Wireless network setup



- You cannot connect your mobile device to the internet through the printer's Wi-Fi Direct.
- The supported protocol list may differ from your model, Wi-Fi Direct networks do NOT support IPv6, network filtering, IPSec, WINS, and SLP services.
- The maximum number of devices that can be connected via Wi-Fi Direct is 3.

Setting up Wi-Fi Direct

You can enable Wi-Fi Direct feature by one of the following methods.

From the USB cable-connected computer(recommended)

After the driver installation is complete, Samsung Easy Printer Manager can be set and changes in the Wi-Fi Direct can be made.



Samsung Easy Printer Manager is Available for Windows and Mac OS users only.

- From the **Start** menu, select **Programs** or **All Programs** > **Samsung Printers** > Samsung Easy Printer Manager > **Device Settings** > **Network**.
 - **Wi-Fi Direct On/Off:** Select **On** to enable.

- **Device Name:** Enter the printer's name for searching for your printer on a wireless network. By default, the device name is the model name.
- **IP Address:** Enter the IP address of the printer. This IP address is used only for the local network and not for the infrastructure wired or wireless network. We recommend using the default local IP address (the default local IP address of the printer for Wi-Fi Direct is 192.168.3.1)
- **Group Owner:** Activate this option to assign the printer the Wi-Fi Direct group's owner. The **Group Owner** acts similar to a wireless access point. We recommend activating this option.
- **Network Password:** If your printer is a **Group Owner**, a **Network Password** is required for other mobile devices to connect to your printer. You can configure a network password yourself, or can remember the given Network Password that is randomly generated by default.

From the machine (Machines with a display screen)



Accessing menus may differ from model to model (see "Accessing the menu" on page 30).

- Select  (**Menu**) > **Network** > **Wi-Fi** > **Wi-Fi Direct** on the control panel.
- Enable **Wi-Fi Direct**.

Wireless network setup

From the network-connected computer

If your printer is using a network cable or a wireless access point, you can enable and configure Wi-Fi Direct from SyncThru™ Web Service.

- Access **SyncThru™ Web Service**, select **Settings > Network Settings > Wireless > Wi-Fi Direct**.
- Enable or disable **Wi-Fi Direct** and set other options.



- For Linux OS users,
 - Print an IP network configuration report to check the output (see "Printing a network configuration report" on page 130).
 - Access **SyncThru Web Service**, select **Settings > Network Settings > Wireless > Wi-Fi Direct**.
 - Enable or disable **Wi-Fi Direct**.

Setting up the mobile device

- After setting up Wi-Fi Direct from the printer, refer to the user manual of the mobile device you are using to set its Wi-Fi Direct.
- After setting up Wi-Fi Direct, you need to download the mobile printing application (For example: Samsung Mobile printer) to print from your smartphone.



- When you have found the printer you want to connect to from your mobile device, select the printer and the printer's LED will blink. Press the WPS button on the printer and it will be connected to your mobile device.
- If your mobile device does not support Wi-Fi Direct, you need to enter the "Network Key" of a printer instead of pushing the WPS button.

Troubleshooting for wireless network

Problems during setup or driver installation

Printers Not Found

- Your machine may not be turned on. Turn on your computer and the machine.
- USB cable is not connected between your computer and machine. Connect the machine to your computer using the USB cable.
- The machine does not support wireless networking (see "Features by models" on page 8).

Wireless network setup

Connecting Failure - SSID Not Found

- The machine is unable to find the network name (SSID) you have selected or entered. Check the network name (SSID) on your access point and try connecting again.
- Your access point is not turned on. Turn on your access point.

Wireless network setup

Connecting Failure - Invalid Security

- Security is not configured correctly. Check the configured security on your access point and machine.

Connecting Failure - General Connection Error

- Your computer is not receiving a signal from your machine. Check the USB cable and your machine's power.

Connecting Failure - Connected Wired Network

- Your machine is connected with a wired network cable. Remove the wired network cable from your machine.

Connecting Failure - Assigning the IP address

- Cycle the power for the access point (or wireless router) and machine.

PC Connection Error

- The configured network address is unable to connect between your computer and machine.
 - For a DHCP network environment
The machine receives the IP address automatically (DHCP) when computer is configured to DHCP.



If the printing job is not working in DHCP mode, the problem may be caused by the automatically changed IP address. Compare the IP address between

the product's IP address and the printer port's IP address.

How to compare:

- 1 Print the network information report of your printer, and then check the IP address (see "Printing a network configuration report" on page 130).
- 2 Check the printer port's IP address from your computer.
 - a Click the Windows **Start** menu.
 - For Windows 8, from **Charms**, select **Search > Settings**.
 - b For Windows XP/Server 2003, select **Printer and Faxes**.
 - For Windows Server 2008/Vista, select **Control Panel > Hardware and Sound > Printers**.
 - For Windows 7/8, select **Control Panel > Devices and Printers**.
 - For Windows Server 2008 R2, select **Control Panel > Hardware > Devices and Printers**.
 - c Right-click your machine.
 - d For Windows XP/2003/2008/Vista, press **Properties**.
For Windows 7/8 and Windows Server 2008 R2, from context menus, select the **Printer properties**.
If **Printer properties** item has ► mark, you can select other printer drivers connected with selected printer.
 - e Click **Port** tab.
 - f Click **Configure Port...** button.
 - g Check if **Printer Name or IP Address**: is the IP address on the network configuration Sheet.
- 3 Change the printer port's IP address if it is different from the network information report's.
If you want to use the software installation CD to change the port IP, Connect to a network printer. Then reconnect the IP address.

Wireless network setup

- For a Static network environment

The machine uses the static address when the computer is configured to static address.

For example,

If the computer's network information is as shown below:

- IP address: 169.254.133.42
- Subnet Mask: 255.255.0.0

Then the machine's network information should be as below:

- IP address: 169.254.133.**43**
- Subnet Mask: 255.255.0.0 (Use the computer's subnet mask.)
- Gateway: 169.254.133.1

Other problems

If problems occur while using the machine on a network, check the following:



For information on the access point (or wireless router), refer to its own user's guide.

- You cannot enable wired and wireless networks at the same time.
- Your computer, access point (or wireless router), or machine may not be turned on.

- Check the wireless reception around the machine. If the router is far from the machine or there is an obstacle, you might have difficulty receiving the signal.
- Cycle the power for the access point (or wireless router), machine, and computer. Sometimes cycling the power can recover network communication.
- Check whether firewall software (V3 or Norton) is blocking the communication.

If the computer and the machine are connected on the same network and it cannot be found when searching, firewall software might be blocking the communication. Refer to the user's guide for the software to turn it off and try searching for the machine again.

- Check whether the machine's IP address is allocated correctly. You can check the IP address by printing the network configuration report.
- Check whether the access point (or wireless router) has a configured security (password). If it has a password, refer to the access point (or wireless router) administrator.
- Check the machine's IP address. Reinstall the machine driver and change the settings to connect to the machine on the network. Due to the characteristics of DHCP, the allocated IP address could change if the machine is not used for a long time or if the access point has been reset.

Register the product's MAC address when you configure the DHCP server on the access point (or wireless router). Then you can always use the IP address that is set with the MAC address. You can identify the MAC address of your machine by printing a network configuration report (see "Printing a network configuration report" on page 130).

Wireless network setup

- Check the wireless environment. You might not be able to connect to the network in the infrastructure environment where you need to type in a user's information before connecting to the access point (or wireless router).
- This machine only supports IEEE 802.11 b/g/n and Wi-Fi. Other wireless communication types (e.g., Bluetooth) are not supported.
- When using the ad hoc mode, in operating systems such as Windows Vista, you might need to set the wireless connection setting every time you use the wireless machine.
- You cannot use infrastructure mode and ad hoc mode at the same time for Samsung wireless network machines.
- The machine is within the range of the wireless network.
- The machine is located away from obstacles that could block the wireless signal.

Remove any large metal objects between the access point (or wireless router) and the machine.

Make sure the machine and wireless access point (or wireless router) are not separated by poles, walls, or support columns containing metal or concrete.
- The machine is located away from other electronic devices that may interfere with the wireless signal.

Many devices can interfere with the wireless signal, including a microwave oven and some Bluetooth devices.
- Whenever the configuration of your access point (or wireless router) changes, you must do the device's wireless network setup again.
- The maximum number of device that can be connected via Wi-Fi Direct is 3.
- If Wi-Fi Direct is ON, this machine only supports IEEE 802.11 b/g.
- If the access point is set to work with the 802.11n standard only, it may not connect to your machine.

Samsung MobilePrint

What is Samsung MobilePrint?

Samsung MobilePrint is a free application that enables users to print photos, documents, and web pages directly from your smartphone or tablet. **Samsung MobilePrint** is not only compatible with your Android and iOS smart phones but also with your iPod Touch and tablet PC. It connects your mobile device to a network connected Samsung printer or to a wireless printer through a Wi-Fi access point. Installing a new driver or configuring network settings isn't necessary – just simply install the **Samsung MobilePrint** application, and it will automatically detect compatible Samsung printers. Besides printing photos, web pages, and PDFs, scanning is also supported. If you have a Samsung multifunction printer, scan any document into a JPG, PDF, or PNG format for quick and easy viewing on your mobile device.

Downloading Samsung MobilePrint

To download **Samsung MobilePrint**, go to the application store (Samsung Apps, Play Store, App Store) on your mobile device, and just search for "**Samsung MobilePrint**." You can also visit iTunes for Apple devices on your computer.



Supported Mobile OS

- Android OS 2.1 or higher
- iOS 4.0 or higher

Supported devices

- **iOS 4.0 or higher:** iPod Touch, iPhone, iPad
- **Android 2.1 or higher:** Galaxy S series, Galaxy Note series, Galaxy Tab series, Galaxy Camera series, and Android mobile device

AirPrint



Network model only (see "Features by models" on page 8).



AirPrint allows you to wirelessly print directly from an iPhone, iPad, and iPod touch running the latest version of iOS.

Setting up AirPrint

Bonjour(mDNS) and IPP protocols are required on your machine to use the **AirPrint** feature. You can enable the **AirPrint** feature by one of the following methods.

- 1 Check whether the machine is connected to the network.
- 2 Start a web browser such as Internet Explorer, Safari, or Firefox and enter your machine's new IP address in the browser window.

For example,



- 3 Click **Login** in the upper right of the SyncThru™ Web Service website.

- 4 Type in the **ID** and **Password**, then click **Login**. If it's your first time logging into SyncThru™ Web Service, type in the below default ID and password. We recommend you to change the default password for security reasons.

- **ID: admin**
- **Password: sec00000**

- 5 When the **SyncThru™ Web Service** window opens, click **Settings > Network Settings**.

- 6 Click **AirPrint**.
You can enable the AirPrint.

Printing via AirPrint

For example, the iPad manual provides these instructions:

- 1 Open your email, photo, web page, or document you want to print.
- 2 Touch the action icon()
- 3 Select **your printer driver name** and option menu to set up.
- 4 Touch **Print** button. Print it out.

AirPrint



Cancelling print job: To cancel the printing job or view the print summary, click the print center icon () in multitasking area. You can click cancel in the print center.

Google Cloud Print™

Google Cloud Print™ is a service that allows you to print to a printer using your smart phone, tablet, or any other web-connected devices. Just register your Google account with the printer, and you are ready to use the Google Cloud Print™ service. You can print your document or email with Chrome OS, Chrome browser, or a Gmail™/ Google Docs™ application on your mobile device, so you don't need to install the printer driver on the mobile device. Refer to the Google website (<http://www.google.com/cloudprint/learn/> or <http://support.google.com/cloudprint>) for more information about Google Cloud Print™.

Registering your Google account to the printer



- Make sure the printer machine is turned on and connected to a wired or wireless network that has access to the Internet.
- You should create your Google account in the advance.

- 1 Open the Chrome browser.
- 2 Visit www.google.com.
- 3 Sign in to the Google website with your Gmail™ address.
- 4 Enter your printer's IP address in the address field and press the Enter key or click **Go**.

- 5 Click **Login** in the upper right corner of the SyncThru™ Web Service website.
- 6 If it's your first time logging into **SyncThru™ Web Service** you need to log-in as an administrator. Type in the below default **ID** and **Password**. We recommend you to change the default password for security reasons.
 - **ID: admin**
 - **Password: sec00000**



If the network environment is using a proxy server, you need to configure the proxy's IP and port number from **Settings > Network Settings > Google Cloud Print > Proxy Setting**. Contact your network service provider or network administrator for more information.

- 7 When the **SyncThru™ Web Service** window opens, click **Settings > Network Settings > Google Cloud Print**.
- 8 Enter your printer's name and description.
- 9 Click **Register**.
The confirmation pop-up window appears.



If you set the browser to block pop-ups, the confirmation window will not appear. Allow the site to show pop-ups.

Google Cloud Print™

10 Click **Finish printer registration**.

11 Click **Manage your printers**.

Now your printer is registered with Google Cloud Print™ service.

Google Cloud Print™-ready devices will appear in the list.

Printing with Google Cloud Print™

The printing procedure varies depending on the application or the device you are using. You can see the application list that supports Google Cloud Print™ service.



Make sure the printer is turned on and connected to a wired or wireless network that has access to the Internet.

Printing from an application on mobile device

The following steps are an example of using the Google Docs™ app from Android mobile phone.

1 Install the Cloud Print application on your mobile device.



If you do not have the application, download it from the application store such as Android Market or App Store.

2 Access the Google Docs™ application from your mobile device.

3 Tap the option  button of the document that you want to print.

4 Tap the send  button.

5 Tap the Cloud Print  button.

6 Set the printing options if you want.

7 Tap **Click here to Print**.

Printing from the Chrome browser

The following steps are an example of using the Chrome browser.

1 Run Chrome.

2 Open the document or email that you want to print.

3 Click the wrench icon  in the browser's top right corner.

4 Click **Print**. A new tab for printing appears.

Google Cloud Print™

- 5 Select **Print with Google Cloud Print**.
- 6 Click the **Print** button.



3. Useful Setting Menus

This chapter explains how to browse the current status of your machine, and the method of setting for advanced machine setup.

- **Before you begin reading a chapter** 177
- **Information** 178
- **Layout** 179
- **Paper** 180
- **Graphic** 181
- **System Setup** 182
- **Emulation** 185
- **Network** 186
- **Job Management** 188

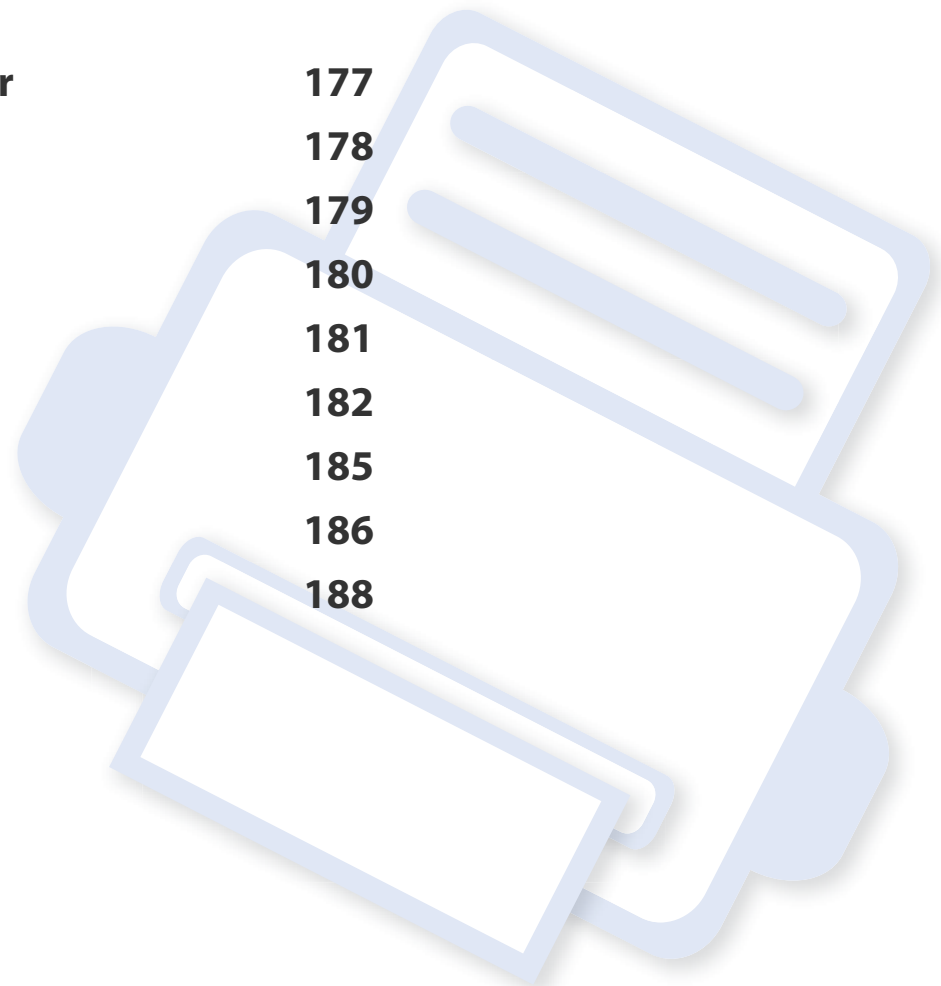



Before you begin reading a chapter

This chapter explains all the features available for this series' models to help users easily understand the features.

You can check the features available for each model in the Basic Guide (see "Menu overview" on page 30).

The following are tips for using this chapter

- The control panel provides access to various menus to set up the machine or use the machine's functions. These menus can be accessed by pressing  (**Menu**).
- Some menus may not appear on the display depending on options or models. If so, it is not applicable to your machine.
- For models that do not have the  (**Menu**) on the control panel, this feature is not applicable (see "Control panel overview" on page 22).
- Some menu names may differ from your machine depending on its options or the models.

Information



Some menus may not appear in the display depending on options or models. If so, it is not applicable to your machine (see "Menu overview" on page 30).

To change the menu options:

- Press  (**Menu**) > **Information** on the control panel.

Item	Description
Menu Map	Prints the menu map which shows the layout and current settings of this machine.
Configuration	Prints a report on the machine's overall configuration.
Demo Page	Prints the demo page to check whether your machine is printing properly or not.
Supplies Info.	Prints supplies' information page.
Usage Counter	Prints a usage page. The usage page contains the total number of pages printed.
Account	This is only available when Job Accounting is enabled from the SyncThru™ Web Admin Service. You can print a report of printout counts for each user.
PCL Font	Prints the PCL font list.
PS Font	Prints the PS font list.
EPSON Font	Prints the EPSON font list.

Item	Description
KSC5843 Font^a	Prints the KSC5843 font list.
KSC5895 Font^a	Prints the KSC5895 font list.
KSSM Font^a	Prints the KSSM font list.

a. This option may not be available depending on your country.



Layout



Some menus may not appear in the display depending on options or models. If so, it is not applicable to your machine (see "Menu overview" on page 30).

To change the menu options:

- Press  (**Menu**) > **Layout** on the control panel.

Item	Description
Orientation	<p>Selects the direction in which information is printed on a page.</p> <ul style="list-style-type: none"> Portrait  <ul style="list-style-type: none"> Landscape 

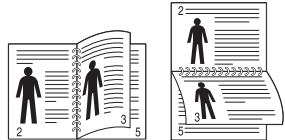
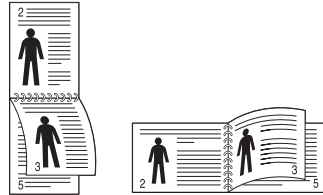
Item	Description
Margin	<ul style="list-style-type: none"> Common Margin: Sets the margin for each side of paper. MP Tray: Sets the paper margins in multi-purpose tray. Tray X: Sets the paper margins for the paper trays. Emulation Mar.: Sets the paper margins for emulation print page.
Duplex	<p>To print on both sides of the paper, choose the binding edge.</p> <ul style="list-style-type: none"> Off: Disables this option. Long Edge  <ul style="list-style-type: none"> Short Edge 

Paper



Some menus may not appear in the display depending on options or models. If so, it is not applicable to your machine (see "Menu overview" on page 30).

To change the menu options:

- Press  (**Menu**) > **Paper** on the control panel.

Item	Description
Copies	Selects the number of copies.
MP Tray/ [Tray <x>]	<ul style="list-style-type: none">• Paper Size: Selects the default paper size.• Paper Type: Selects the paper type currently loaded in the tray.
Paper Source	Sets the default paper tray to use. <div data-bbox="358 989 1075 1189" style="border: 1px solid #ccc; padding: 10px; margin-top: 10px;"> Auto: You can set the machine to automatically change to the tray with the same sized paper when the tray in use is empty.</div>

Graphic



Some menus may not appear in the display depending on options or models. If so, it is not applicable to your machine (see "Menu overview" on page 30).

To change the menu options:

- Press (Menu) > **Graphic** on the control panel.

Item	Description
Resolution	Specifies the number of dots printed per inch (dpi). The higher the setting, the sharper printed characters and graphics.
Clear Text	Prints text darker than on a normal document.
Auto CR	Allows you to append the required carriage return to each line feed, which is useful for Unix or DOS users.

System Setup



Some menus may not appear in the display depending on options or models. If so, it is not applicable to your machine (see "Menu overview" on page 30).

To change the menu options:

- Press  (**Menu**) > **System Setup** on the control panel.

Item	Description
Date & Time^a	Sets the date and time.
Clock Mode^a	Selects the format for displaying time between 12 hours and 24 hours.
Language	Sets the language of the text that appears on the control panel display.
Default Paper	You can set the default paper size to use.
Power Save	Sets how long the machine waits before going to power save mode. When the machine does not receive data for an extended period of time, power consumption is automatically lowered.



Item	Description
Wakeup Event	When this option is On , you can wake up the machine from the power saving mode with the following actions: <ul style="list-style-type: none">Loading paper in a tray.Opening or closing the front cover.Pulling a tray out or pushing a tray in.
Job Timeout	When there is no input for a certain period of time, the machine cancels the current job. You can set the amount of time the machine will wait before canceling the job.
Altitude Adj.	Optimize print quality according to the machine's altitude ("Altitude adjustment" on page 190).
Auto Continue	Determine whether or not the machine continues printing when it detects the paper does not match the paper settings. <ul style="list-style-type: none">0 Sec: This option allows you to continue printing when the paper size you have set is mismatched with the paper in the tray.30 Sec: If a paper mismatch occurs, an error message will display. The machine waits for about 30 second, then automatically clear the message and continue printing.Off: If a paper mismatch occurs, the machine waits until you insert the correct paper.

System Setup

Item	Description
Auto Tray Swi.	<p>Determine whether or not the machine continues printing when it detects the paper does not match. For example, if both tray 1 and tray 2 are filled with the same size paper, the machine automatically prints from tray 2 after the tray 1 runs out of paper.</p> <div style="border: 1px solid #ccc; padding: 5px; margin-top: 10px;">  This option does not appear if you selected Auto for Paper Source from printer driver. </div>
Paper Substit.	<p>Automatically substitutes the printer driver's paper size to prevent the paper mismatch between Letter and A4. For example, if you have A4 paper in the tray but you set the paper size to Letter in the printer driver, the machine prints on A4 paper and vice versa.</p>
Tray Protect.	<p>Decides to use or not use the Auto Tray Swi. feature. If you set tray 1 to on, for example, then tray 1 is excluded during tray switching.</p>
SkipBlankPage	<p>The printer detects the printing data from computer whether a page is empty or not. You can set to print or skip the blank page.</p>

Item	Description
Maintenance	<ul style="list-style-type: none"> • CLR Empty Msg.: This option appears only when toner cartridge is empty. • Supplies Life: Allows you to check how many pages are printed and how much toner is left in the cartridge. • Image Mgr.: Allows you to adjust the density. • TonerLow Alert: If toner in the cartridge has run out, a message informing the user to change the toner cartridge appears. You can set the option for this message to appear or not. • ImgU. Low Alert^b: Allows you to set the alarm for when the imaging unit is low. <div style="border: 1px solid #ccc; padding: 5px; margin-top: 10px;">  M3325/M3825/M4025 series only. </div> <ul style="list-style-type: none"> • RAM Disk: Enables/disables RAM disk to manage jobs.
Toner Save	<p>Activating this mode extends the life of your toner cartridge and reduces your cost per page beyond what one would experience in the normal mode, but it reduces print quality.</p>

System Setup

Item	Description
Eco Settings	<p>Allows you to save print resources and enables eco-friendly printing (see "Eco printing" on page 49).</p> <ul style="list-style-type: none">• Default Mode: Select whether to turn the Eco mode on or off. <div data-bbox="383 488 1079 687"> On Force: Sets the Eco mode on. If a user wants to turn the Eco mode off, the user needs to enter the password.</div> <ul style="list-style-type: none">• Select Temp.: Selects the eco template set from the SyncThru™ Web Service.
Auto Power Off	<p>Turns power off automatically when the machine has been in power save mode for the length of time set in Auto Power Off > On > Timeout.</p> <div data-bbox="383 986 1079 1453"><ul style="list-style-type: none">• To turn the machine on again, press the  (Power) button on the control panel (make sure the main power switch is on).• If you run the printer driver or Samsung Easy Printer Manager, the time automatically extends.• While the machine is connected to the network or working on a print job, Auto Power Off feature doesn't work.</div>

- a. M382xDW only
- b. M3325/M3825/M4025 series only.

Emulation



Some menus may not appear in the display depending on options or models. If so, it is not applicable to your machine (see "Menu overview" on page 30).

To change the menu options:

- Press  (**Menu**) > **Emulation** on the control panel.

Item	Description
Emulation Type	The machine language defines how the computer communicates with the machine.
Setup	Sets the detailed settings for the selected emulation type.

Network



Some menus may not appear in the display depending on options or models. If so, it is not applicable to your machine (see "Menu overview" on page 30).

To change the menu options:

- Press  (**Menu**) > **Network** on the control panel.





You can also use this feature from the SyncThru™ Web Service. Open the Web browser from your networked computer and type the IP address of your machine. When SyncThru™ Web Service opens, click **Settings** > **Network Settings** (see "Using SyncThru™ Web Service" on page 215).

Option	Description
TCP/IP (IPv4)	Selects the appropriate protocol and configure parameters to use the network environment (see "Setting IP address" on page 130).  There are lots of parameters to be set. If you are not sure, leave as is, or consult the network administrator.
TCP/IP (IPv6)	Selects this option to use the network environment through IPv6 (see "IPv6 configuration" on page 142).

Option	Description
Ethernet	Configure the ethernet port and network transmission speed.  Turn the power off and on after you change this option.
802.1x	You can select the user authentication for network communication. For detailed information consult the network administrator.
Wi-Fi	Select this option to use the wireless network (see "Wireless network setup" on page 145).

Network

Option	Description
Protocol Mgr.	<p>You can activate or deactivate the following protocols.</p> <ul style="list-style-type: none">• HTTP: You can sets whether to use SyncThru™ Web Service or not.• WINS: You can configure the WINS server. WINS(Windows Internet Name Service) is used in the Windows operating system.• SNMP V1/V2: You have to enable this option to use SNMP V1/V2 protocol. Administrator's can use SNMP to monitor and manage machines on the network.• UPnP(SSDP): You have to enable this option to use UPnP(SSDP) protocol.• MDNS: You have to enable this option to use MDNS (Multicast Domain Name System) protocol.• SetIP: You have to enable this option to use SetIP protocol.• SLP: You can configure SLP (Service Location Protocol) settings. This protocol allows host applications to find services in a local area network without prior configuration. <div style="border: 1px solid #ccc; padding: 5px; margin-top: 10px;"> Turn the power off and on after you change this option.</div>
Network Conf.	<p>This list shows information on your machine's network connection and configuration (see "Printing a network configuration report" on page 130).</p>

Option	Description
Clear Setting	<p>Reverts the network settings to the default values.</p> <div style="border: 1px solid #ccc; padding: 5px; margin-top: 10px;"> Turn the power off and on.</div>

Job Management



- This feature is not supported for M382xD.
- Some menus may not appear in the display depending on options or models. If so, it is not applicable to your machine (see "Menu overview" on page 30).

To change the menu options:

- Press (Menu) > **Job Management** on the control panel.

Item	Description
Active Job	Shows the print job lists that are waiting to be printed.
Secured Job	Shows the print job lists that are secured on the disk.
Stored Job	Shows the print job lists that are stored on the disk.
Filing Policy	If the memory already has the same name when you entered a new file name, you can rename or overwrite it.



4. Special Features

This chapter explains special printing features.

- **Altitude adjustment** 190
- **Entering various characters** 191
- **Printing features** 192
- **Using optional device features** 208



- The procedures in this chapter are mainly based on Windows 7.
- It may be necessary to press **OK** to navigate to lower-level menus for some models.

Altitude adjustment

Print quality is affected by atmospheric pressure, which is determined by the height of the machine above sea level. The following information will guide you on how to set your machine for the best print quality.

Before you set the altitude value, determine the altitude where you are.

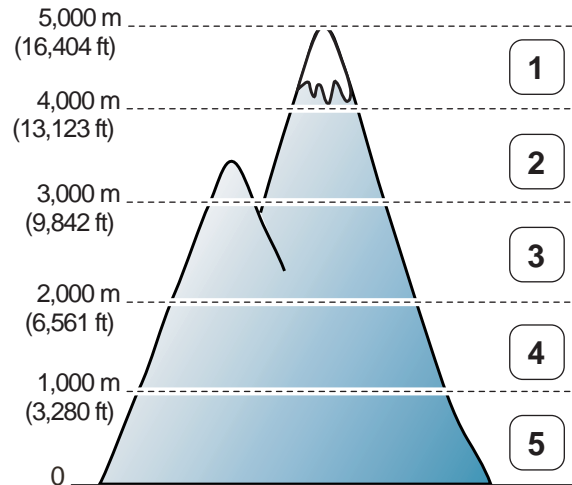

- 1 High 4
- 2 High 3
- 3 High 2
- 4 High 1
- 5 Normal

You can set the altitude value from **Device Settings** in Samsung Easy Printer Manager program.

- For Windows and Mac users, you set from **Samsung Easy Printer Manager** >  **(Switch to advanced mode)** > **Device Settings**, see "Device Settings" on page 221.



- If your machine is connected to the network, you can set the altitude via SyncThru™ Web Service (see "Using SyncThru™ Web Service" on page 215).
- You can also set the altitude in **System Setup** option on the machine's display (see "Machine's basic settings" on page 33).

Entering various characters



M382xND/M382xDW/M402xND only.

As you perform various tasks, you may need to enter names and numbers.

Entering alphanumeric characters

Press the button until the correct letter appears on the display. For example, to enter the letter O, press 6, labeled with MNO. Each time you press 6, the display shows a different letter, M, N, O, m, n, o and finally 6. To find the letter that you want to enter, see "Keypad letters and numbers" on page 191.



- You can enter a space by pressing 1 twice.
- To delete the last digit or character, press the arrow button.

Keypad letters and numbers



- Special character sets may differ from your machine depending on its options or the models.
- Some of the follow key values may not appear depending on the job you are doing.

Key	Assigned numbers, letters, or characters
1	@ / . ' 1
2	A B C a b c 2
3	D E F d e f 3
4	G H I g h i 4
5	J K L j k l 5
6	M N O m n o 6
7	P Q R S p q r s 7
8	T U V t u v 8
9	W X Y Z w x y z 9
0	& + - , 0
*	* % ^ _ ~ ! # \$ () [] (These symbols are available when you type for network authentication.)
#	# = ? " : { } < > ; (These symbols are available when you type for network authentication.)

Printing features



- For basic printing features, refer to the Basic Guide (see "Basic printing" on page 46).
- This feature may not be available depending on model or optional goods (see "Features by models" on page 8).

Changing the default print settings

- 1 Click the Windows **Start** menu.
- 2 Select **Control Panel > Devices and Printers**.
- 3 Right-click on your machine.
- 4 Select **Printing preferences**.



If **Printing preferences** has a ►, you can select other printer drivers connected to the selected printer.

- 5 Change the settings on each tab.
- 6 Click **OK**.



If you want to change the settings for each print job, change it in **Printing Preferences**.

Setting your machine as a default machine

- 1 Click the Windows **Start** menu.
- 2 Select **Control Panel > Devices and Printers**.
- 3 Select your machine.
- 4 Right-click your machine and select **Set as Default Printer**.



If **Printing preferences** has a ►, you can select other printer drivers connected to the selected printer.

Printing features

Using advanced print features



- See "Features by models" on page 8.
- **XPS printer driver:** used to print XPS file format.
 - The XPS printer driver can be installed only on Windows Vista OS or higher.
 - Install optional memory when an XPS job does not print because the printer is out of memory.
 - You can install the XPS printer driver when you insert the software CD into your CD-ROM drive. For windows, select the printer XPS driver in the **Select Software to Install** window.

Printing to a file (PRN)

You will sometimes need to save the print data as a file.

- 1 Check the **Print to file** box in the **Print** window.

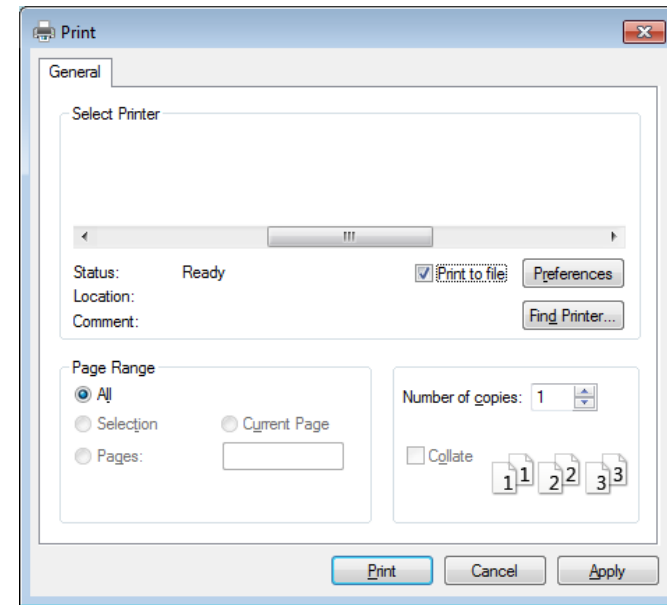

- 2 Click **Print**.
- 3 Type in the destination path and the file name, and then click **OK**.
For example, **c:\Temp\file name**.



If you type in only the file name, the file is automatically saved in **My Documents**, **Documents and Settings**, or **Users**. The saved folder may differ, depending on your operating system or the application you are using.

Printing features

Understanding special printer features

You can use advanced printing features when using your machine.





To take advantage of the printer features provided by your printer driver, click **Properties** or **Preferences** in the application's **Print** window to change the print settings. The machine name, that appears in the printer properties window may differ depending on the machine in use.

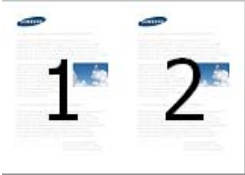
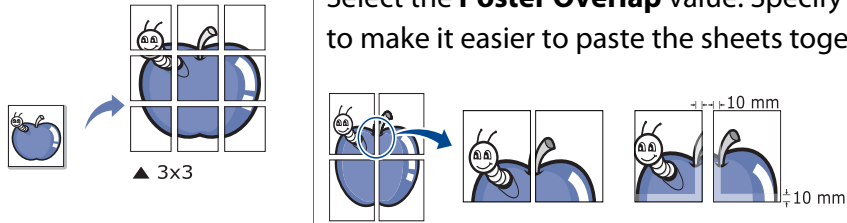

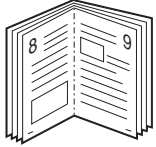

- Some menus may not appear on the display depending on options or models. If so, it is not applicable to your machine.
- Select the **Help** menu or press **F1** on your keyboard and click on any option you want to know about (see "Using help" on page 48).

Item	Description
<p data-bbox="51 770 315 842">Multiple Pages per Side</p> 	<p data-bbox="383 770 2175 847">Selects the number of pages to print on a single sheet of paper. To print more than one page per sheet, the pages will be reduced in size and arranged in the order you specify. You can print up to 16 pages on one sheet.</p>
<p data-bbox="51 1134 259 1166">Poster Printing</p> 	<p data-bbox="383 1094 2130 1171">Prints a single-page document onto 4 (Poster 2x2), 9 (Poster 3x3), or 16 (Poster 4x4) sheets of paper, for the purpose of pasting the sheets together to form one poster-size document.</p> <p data-bbox="383 1190 2190 1267">Select the Poster Overlap value. Specify Poster Overlap in millimeters or inches by selecting the radio button on the upper right of Basic tab to make it easier to paste the sheets together.</p>

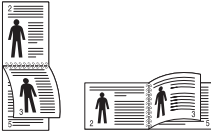
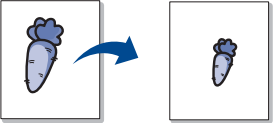

Printing features

Item	Description
<p data-bbox="53 373 293 408">Booklet Printing^a</p> 	<p data-bbox="380 272 2195 344">Prints your document on both sides of a sheet of paper and arranges the pages so that the paper can be folded in half after printing to produce a booklet.</p> <div data-bbox="380 395 2195 687"><ul data-bbox="477 427 2195 643" style="list-style-type: none"><li data-bbox="477 427 1854 459">• If you want to make a booklet, you need to print on Letter, Legal, A4, US Folio, or Oficio sized print media.<li data-bbox="477 480 2195 552">• The Booklet Printing option is not available for all paper sizes. Select the available paper Size option under the Paper tab to see what paper sizes are available.<li data-bbox="477 572 2195 643">• If you select an unavailable paper size, this option can be automatically canceled. Select only available paper (paper without  or  mark).</div>
<p data-bbox="53 788 241 860">Double-sided Printing</p>	<p data-bbox="380 724 1798 756">Print on both sides of a sheet of paper (duplex). Before printing, decide how you want your document oriented.</p> <div data-bbox="380 807 2195 922"><p data-bbox="477 839 1447 871">You can use this feature with Letter, Legal, A4, US Folio or Oficio sized paper</p></div>

Printing features

Item	Description
Double-sided Printing	<ul style="list-style-type: none">• Printer Default: If you select this option, this feature is determined by the settings you have selected on the control panel of the machine.• None: Disables this feature.• Long Edge: This option is the conventional layout used in bookbinding. • Short Edge: This option is the conventional layout used in calendars. • Reverse Double-Sided Printing: Check this option to reverse the print order when duplex printing.
Paper Options 	Changes the size of a document to appear larger or smaller on the printed page by entering in a percentage by which to enlarge or decrease the document.
Watermark 	The watermark option allows you to print text over an existing document. For example, you use it when you want to have large gray letters reading "DRAFT" or "CONFIDENTIAL" printed diagonally across the first page or all pages of a document.

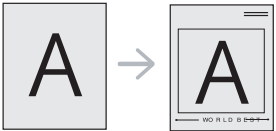

Printing features

Item	Description
Watermark (Creating a watermark)	<p>a To change the print settings from your software application, access Printing Preferences.</p> <p>b Click the Advanced tab, select Edit from the Watermark drop-down list. The Edit Watermarks window appears.</p> <p>c Enter a text message in the Watermark Message box. You can enter up to 256 characters. The message displays in the preview window.</p>
Watermark (Editing a watermark)	<p>a To change the print settings from your software application, access Printing Preferences.</p> <p>b Click the Advanced tab, select Edit from the Watermark drop-down list. The Edit Watermarks window appears.</p> <p>c Select the watermark you want to edit from the Current Watermarks list and change the watermark message and options.</p> <p>d Click Update to save the changes.</p> <p>e Click OK or Print until you exit the Print window.</p>
Watermark (Deleting a watermark)	<p>a To change the print settings from your software application, access Printing Preferences.</p> <p>b Click the Advanced tab, select Edit from the Watermark drop-down list. The Edit Watermarks window appears.</p> <p>c Select the watermark you want to delete from the Current Watermarks list and click Delete.</p> <p>d Click OK or Print until you exit the Print window.</p>
Overlay^a 	<p>This option is available only when you use the PCL/SPL printer driver (see "Software" on page 9).</p> <p>An overlay is text and/or images stored in the computer hard disk drive (HDD) as a special file format that can be printed on any document. Overlays are often used to take the place of letterhead paper. Rather than using preprinted letterhead, you can create an overlay containing exactly the same information that is currently on your letterhead. To print a letter with your company's letterhead, you do not need to load preprinted letterhead paper in the machine: just print the letterhead overlay on your document.</p> <p>To use a page overlay, you must create a new page overlay containing your logo or image.</p> <div data-bbox="383 1230 2197 1390"><ul style="list-style-type: none">• The overlay document size must be the same as the document you print with the overlay. Do not create an overlay with a watermark.• The resolution of the overlay document must be the same as that of the document you will print with the overlay.</div>

Printing features

Item	Description
Overlay^a (Creating a new page overlay)	<p>a To save the document as an overlay, access Printing Preferences.</p> <p>b Click the Advanced tab, and select Edit from the Text drop-down list. Edit Overlay window appears.</p> <p>c In the Edit Overlay window, click Create.</p> <p>d In the Save As window, type a name up to eight characters in the File name box. Select the destination path, if necessary (The default is C:\Formover).</p> <p>e Click Save. The name appears on the Overlay List.</p> <p>f Click OK or Print until you exit the Print window. The file is not printed. Instead, it is stored on your computer hard disk drive.</p>
Overlay^a (Using a page overlay)	<p>a Click the Advanced tab.</p> <p>b Select the desired overlay from the Text drop-down list.</p> <p>c If the overlay file you want does not appear in the Text drop-down list, select Edit... from the list and click Load. Select the overlay file you want to use. If you have stored the overlay file you want to use in an external source, you can also load the file when you access the Open window. After you select the file, click Open. The file appears in the Overlay List box and is available for printing. Select the overlay from the Overlay List box.</p> <p>d If necessary, check Confirm Page Overlay When Printing box. If this box is checked, a message window appears each time you submit a document for printing, asking you to confirm printing an overlay on your document. If this box is not checked and an overlay has been selected, the overlay automatically prints with your document.</p> <p>e Click OK or Print until you exit the Print window.</p>
Overlay^a (Deleting a page overlay)	<p>a In the Printing Preferences window, click the Advanced tab.</p> <p>b Select Edit in the Text drop down list.</p> <p>c Select the overlay you want to delete from the Overlay List box.</p> <p>d Click Delete.</p> <p>e When a confirming message window appears, click Yes.</p> <p>f Click OK or Print until you exit the Print window. You can delete page overlays that you no longer use.</p>

Printing features

Item	Description
Print Mode^b	<div data-bbox="383 284 2197 624"><ul style="list-style-type: none">• This feature is available only if you have installed the optional memory or mass storage device (HDD) (see "Variety feature" on page 10).• Some menus may not appear on the display depending on options or models. If so, it is not applicable to your machine.• To enable this feature, check Storage Options (see "Setting Device Options" on page 67).• Without installing the optional memory or mass storage device (HDD) in the machine, the RAM disk feature provides only 3 options: Normal, Proof, and Confidential.</div> <ul style="list-style-type: none">• Print Mode: The default Print Mode is Normal, which is for printing without saving the printing file in the memory.<ul style="list-style-type: none">- Normal: This mode prints without storing your document in the optional memory.- Proof: This mode is useful when you print more than one copy. You can print one copy first to check, then print the rest of the copies later.- Confidential: This mode is used for printing confidential documents. You need to enter a password to print.- Store: Select this setting to save a document in the optional memory or mass storage device (HDD) without printing.- Store and Print: This mode is used when printing and storing document at the same time.- Spool: This option can be useful when handling large amounts of data. If you select this setting, the printer spools the document into the optional memory or mass storage device (HDD) and then prints it from the optional memory or mass storage device (HDD) queue, decreasing the computer's work load.- Print Schedule: Select this setting to print the document at a specified time. <div data-bbox="383 1134 2197 1474"><ul style="list-style-type: none">• Job Name: This option is used when you need to find a stored file using the control panel.• User ID: This option is used when you need to find a stored file using the control panel. The user name automatically appears as the user name that you use to log on Windows.• Enter Password: If the Property of the document you selected is secured, you have to enter the password for the document. This option is used for loading a stored file using the control panel.• Confirm Password: Re-enter the password to confirm it.</div>

Printing features

Item	Description
Job Accounting^b	<p>This option allows you to print with the given permission.</p> <ul style="list-style-type: none">• User permission: If you check this option, only users with user permission can start a print job.• Group permission: If you check this option, only groups with group permission can start a print job. <div data-bbox="383 459 2197 619" style="background-color: #f0f0f0; padding: 10px;"><ul style="list-style-type: none">• Select the Help menu or press F1 on your keyboard and click on any option you want to know about (see "Using help" on page 48).• Administrators can enable job accounting and configure permissions in the control panel or SyncThru™ Web Admin Service.</div>

a. This option is not available when you use XPS driver.

b. Not supported for M382xD.

Printing features

Using Direct Printing Utility



- This feature is not supported for M382xD.
- Direct Printing Utility may not be available depending on model or optional goods (see "Software" on page 9).
- Available for Windows OS users only.

What is Direct Printing Utility?

Direct Printing Utility is a program that sends the PDF files directly to your machine to print without having to opening the file.

To install this program:

Download the software from the Samsung website then unpack and install it: (<http://www.samsung.com> > find your product > Support or Downloads).



- You cannot print PDF files that are restricted. Deactivate the printing restriction feature and retry printing.
- You cannot print PDF files that are restricted by a password. Deactivate the password feature, and retry printing.

- Whether or not a PDF file can be printed using the Direct Printing Utility program depends on how the PDF file was created.
- The Direct Printing Utility program supports PDF version 1.7 and below. For higher versions, you must open the file to print it.

Printing

There are several ways you can print using the Direct Printing Utility.

- 1 From the **Start** menu select **Programs** or **All Programs** .
 - For Windows 8, from **Charms**, select **Search > Apps**.
- 2 Find **Samsung Printers > Direct Printing Utility**.
- 3 Select your machine from the **Select Printer** drop-down list and click **Browse**.
- 4 Select the file you wish to print and click **Open**.
The file is added in the **Select Files** section.
- 5 Customize the machine settings for your needs.
- 6 Click **Print**. The selected PDF file is sent to the machine.

Printing features

Using the right-click menu

- 1 Right-click on the PDF file to print and select **Direct Printing**.
The Direct Printing Utility window appears with the PDF file is added.
- 2 Select the machine to use.
- 3 Customize the machine settings.
- 4 Click **Print**. The selected PDF file is sent to the machine.

Mac printing



Some features may not be available depending on models or options. It means that the features are not supported.

Printing a document

When you print with a Mac, you need to check the printer driver settings in each application you use. Follow the steps below to print from a Mac:

- 1 Open the document to print.
- 2 Open the **File** menu and click **Page Setup (Document Setup** in some applications).
- 3 Choose your paper size, orientation, scaling, other options, and make sure that your machine is selected. Click **OK**.
- 4 Open the **File** menu and click **Print**.
- 5 Choose the number of copies and indicate which pages to print.
- 6 Click **Print**.

Printing features

Changing printer settings

You can use advanced printing features when using your machine.

Open an application and select **Print** from the **File** menu. The machine name, which appears in the printer properties window, may differ depending on the machine in use. Except for the name, the composition of the printer properties window is similar to the following.

Printing multiple pages on one sheet

You can print more than one page on a single sheet of paper. This feature provides a cost-effective way to print draft copies.

- 1 Open an application, and select **Print** from the **File** menu.
- 2 Select **Layout** from the drop-down list under **Orientation**. In the **Pages per Sheet** drop-down list, select the number of pages you want to print on one sheet of paper.
- 3 Select the other options to use.
- 4 Click **Print**.

The machine prints the selected number of pages to print on one sheet of paper.

Printing on both sides of the paper



Some features may not be available depending on models or options. It means that the features are not supported (see "Variety feature" on page 10).

Before printing in the duplex mode, decide on which edge you will be binding your finished document. The binding options are, as follows:

- **Long-Edge Binding:** This option is the conventional layout used in book binding.
- **Short-Edge Binding:** This option is the type often used with calendars.

- 1 From your Mac application, select **Print** from the **File** menu.
- 2 Select **Layout** from the drop-down list under **Orientation**.
- 3 Select a binding orientation from the **Two-Sided** option.
- 4 Select the other options to use.
- 5 Click **Print** and the machine prints on both sides of the paper.



If you print more than 2 copies, the first copy and the second copy might print on the same sheet of paper. Avoid printing on both sides of paper when you are printing more than 1 copy.

Printing features

Using help

Click the question mark on the bottom-left corner of the window and click on the topic you want to know about. A pop-up window appears with information about that option's feature, which is provided from the driver.

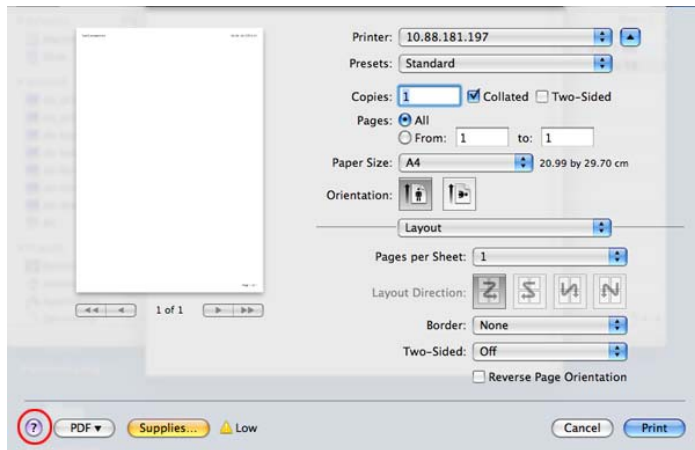

Linux printing



Some features may not be available depending on models or options. It means that the features are not supported.

Printing from applications

There are a lot of Linux applications that allow you to print using Common UNIX Printing System (CUPS). You can print on your machine from any such application.

- 1 Open the document to print.
- 2 Open the **File** menu and click **Page Setup** (**Print Setup** for some applications).
- 3 Choose your paper size, orientation, and make sure that your machine is selected. Click **Apply**.
- 4 Open the **File** menu and click **Print**.
- 5 Select your machine to print.
- 6 Choose the number of copies and indicate which pages to print.
- 7 Change other printing options in each tab, if necessary.
- 8 Click **Print**.



Automatic duplex printing may not be available depending on models. You can alternatively use the lpr printing system or other applications for odd-even printing (see "Features by models" on page 8).

Printing features

Printing files

You can print text, image, pdf files on your machine using the standard CUPS directly from the command line interface. The CUPS lp or lpr utility allows you to do that. You can print these files by using below command format.

"lp -d <printer name> -o <option> <file name>"

Please refer to lp or lpr man page on your system for more details.

Configuring Printer Properties

Using the **Printer Properties** window provided by the **Printers configuration**, you can change the various properties for your machine as a printer.

- 1 Open the **Unified Driver Configurator**.
If necessary, switch to **Printers configuration**.
- 2 Select your machine on the available printers list and click **Properties**.

- 3 The **Printer Properties** window appears.

The following five tabs display at the top of the window:

- **General:** Allows you to change the printer location and name. The name entered in this tab displays on the printer list in **Printers configuration**.
- **Connection:** Allows you to view or select another port. If you change the machine port from USB to parallel or vice versa while in use, you must re-configure the machine port in this tab.
- **Driver:** Allows you to view or select another machine driver. By clicking **Options**, you can set the default device options.
- **Jobs:** Shows the list of print jobs. Click **Cancel job** to cancel the selected job and select the **Show completed jobs** check box to see previous jobs on the job list.
- **Classes:** Shows the class that your machine is in. Click **Add to Class** to add your machine to a specific class or click **Remove from Class** to remove the machine from the selected class.

- 4 Click **OK** to apply the changes and close the **Printer Properties** window.

Printing features

Unix printing



Some features may not be available depending on models or options. It means that the features are not supported (see "Features by models" on page 8).

Proceeding the print job

After installing the printer, choose any of the image, text, or PS files to print.

- 1 Execute "**printui <file_name_to_print>**" command.
For example, if you are printing "**document1**"
printui document1
This will open the UNIX Printer Driver **Print Job Manager** in which the user can select various print options.
- 2 Select a printer that has been already added.
- 3 Select the printing options from the window such as **Page Selection**.
- 4 Select how many copies are needed in **Number of Copies**.



To take advantage of the printer features provided by your printer driver, press **Properties**.

- 5 Press **OK** to start the print job.

Changing the machine settings

The UNIX printer driver **Print Job Manager** in which the user can select various print options in printer **Properties**.

The following hot keys may also be used: "H" for **Help**, "O" for **OK**, "A" for **Apply**, and "C" for **Cancel**.

General tab

- **Paper Size:** Set the paper size as A4, Letter, or other paper sizes, according to your requirements.
- **Paper Type:** Choose the type of the paper. Options available in the list box are **Printer Default**, **Plain**, and **Thick**.
- **Paper Source:** Select from which tray the paper is used. By default, it is **Auto Selection**.
- **Orientation:** Select the direction in which information is printed on a page.
- **Duplex:** Print on both sides of paper to save paper.

Printing features



Automatic duplex printing may not be available depending on models. You can alternatively use the lpr printing system or other applications for odd-even printing.

- **Multiple pages:** Print several pages on one side of the paper.
- **Page Border:** Choose any of the border styles (e.g., **Single-line hairline**, **Double-line hairline**)

Image tab

In this tab, you can change the brightness, resolution, or image position of your document.

Text tab

Set the character margin, line space, or the columns of the actual print output.

Margins tab

- **Use Margins:** Set the margins for the document. By default, margins are not enabled. The user can change the margin settings by changing the values in the respective fields. Set by default, these values depend on the page size selected.
- **Unit:** Change the units to points, inches, or centimeters.

Printer-Specific Settings tab

Select various options in the **JCL** and **General** frames to customize various settings. These options are specific to the printer and depend on the PPD file.

Using optional device features



- This feature is not supported for M382xD.
- Some features may not be available depending on model or optional goods (see "Variety feature" on page 10).

From the printer driver

If you install the optional device, you can use advanced printing features, such as proofing a job and printing a private job in the **Print** window. Check the mass storage (HDD) or RAM disk option in **Device Options**, then you can select the various features from **Print Mode** (see "Setting Device Options" on page 67).

- 1 Open the document you want to print.
- 2 Select **Print** from the **File** menu. The **Print** window appears.

- 3 Select your printer driver from the **Select Printer** list.

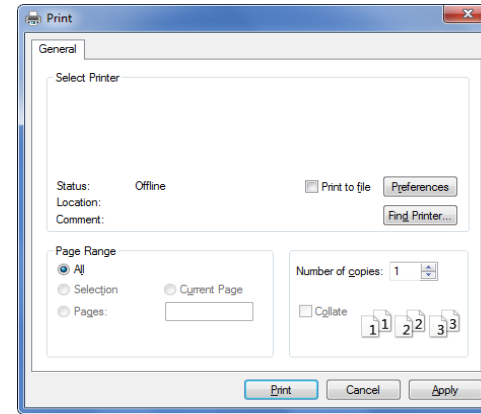

- 4 Click **Properties** or **Preferences**.
- 5 Click the each tab then select **Print Mode**.
- 6 Select the option you want (see "Understanding special printer features" on page 194).

From the control panel

If your machine has optional mass storage device (HDD) or RAM disk, you can use these features from the  (**Menu**) button > **System Setup** > **Job Management**.

Using optional device features



Some menus may not appear on the display depending on options or models. If so, it is not applicable to your machine.

- **Active Job:** All of the print jobs waiting to be printed are listed in the active job queue in the order you sent them to the printer. You can delete a job from the queue before printing, or promote a job to print sooner.
- **Secured Job:** You can print or delete a secured job. Shows the list of secured jobs the user has set in the printer driver. You need to enter the user name and password set in the printer driver.
- **Stored Job:** You can print or delete a stored job.
- **Filing Policy:** You can choose the file policy for generating file name before you proceed with the job through optional memory. If the optional memory already has the same name when you entered a new file name, you can rename or overwrite it.



5. Useful Management Tools

This chapter introduces management tools provided to help you make full use of your machine.

- **Accessing management tools** 211
- **Easy Capture Manager** 212
- **Samsung AnyWeb Print** 213
- **Easy Eco Driver** 214
- **Using SyncThru™ Web Service** 215
- **Using Samsung Easy Printer Manager** 219
- **Using Samsung Printer Status** 222
- **Using Samsung Printer Experience** 224
- **Using the Linux Unified Driver Configurator** 230

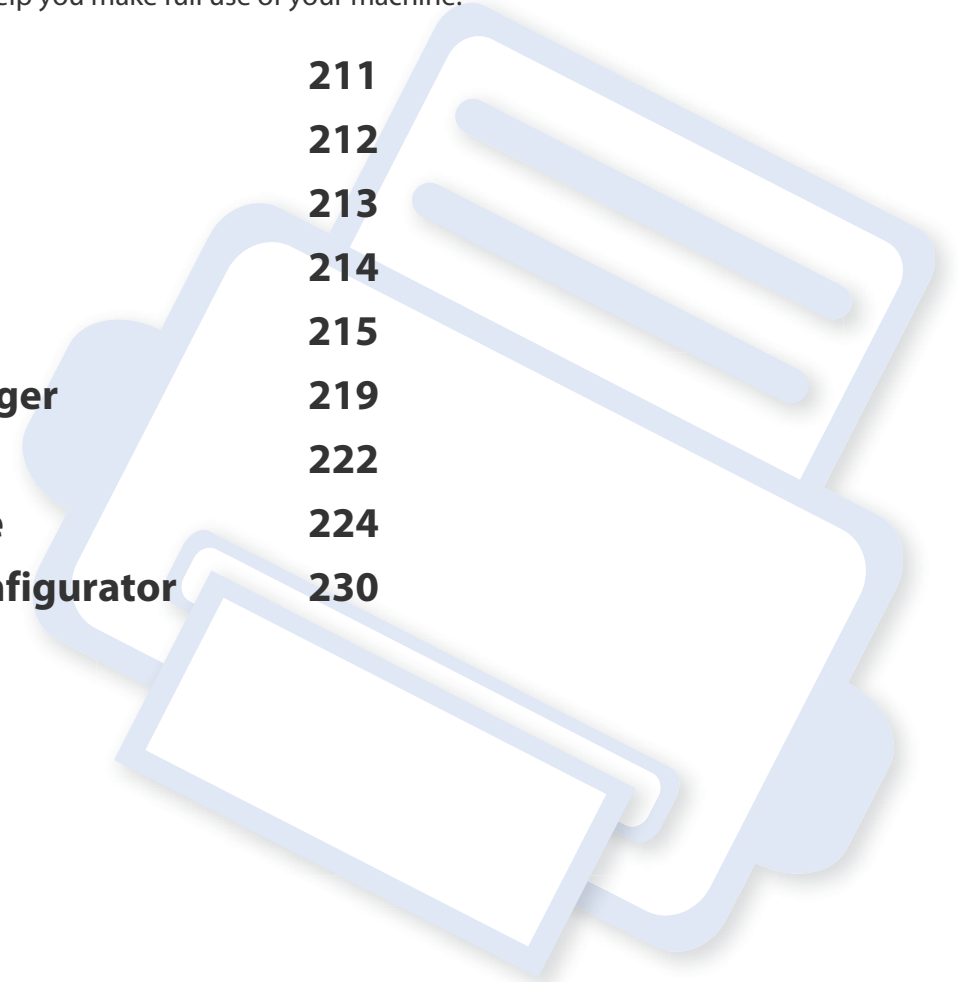

Accessing management tools

Samsung provides a variety of management tools for Samsung printers.

- 1 Make sure that the machine is connected to your computer and powered on.
- 2 From the **Start** menu, select **Programs** or **All Programs**.
 - For Windows 8, from the **Charms**, select **Search > Apps**.
- 3 Find **Samsung Printers**.
- 4 Under **Samsung Printers**, you can see installed management tools.
- 5 Click the management tool you want to use.



- After installing the driver, for some management tools, you can access them directly from the **Start** menu > **Programs** or **All Programs**.
- For Windows 8, after installing the driver, for some management tools, you can access them directly from the **Start** screen by clicking on the corresponding tile.

Easy Capture Manager



- This feature may not be available depending on model or optional goods (see "Software" on page 9).
- Available for Windows OS users only (see "Software" on page 9).

Capture your screen and launch Easy Capture Manager by simply pressing the Print Screen key. Now you can easily print your captured screen as captured or edited.

Samsung AnyWeb Print



- This feature may not be available depending on model or optional goods (see "Software" on page 9).
- Available for Windows and Mac OS users only (see "Software" on page 9).

This tool helps you screen-capture, preview, scrap, and print Windows Internet Explorer pages more easily, than when you use an ordinary program.

Download the software from the Samsung website then unpack and install it: (<http://www.samsung.com> > find your product > Support or Downloads).

Easy Eco Driver



- This feature may not be available depending on model or optional goods (see "Software" on page 9).
- Available for Windows OS users only (see "Software" on page 9).

With the Easy Eco Driver, you can apply Eco features to save paper and toner before printing. To use this application, **Printer Properties > Basic tab > Start Easy Eco Driver before printing job** checkbox should be checked.

Easy Eco Driver also allows you to do simple editing such as removing images and texts, changing fonts, and more. You can save frequently used settings as a preset.

How to use:

- 1 Open a document to print.
- 2 Print the document.
A preview window appears.
- 3 Select the options you want to apply to the document.
You can see the preview of the applied features.
- 4 Click **Print**.

Using SyncThru™ Web Service



- Internet Explorer 6.0 or higher is the minimum requirement for SyncThru™ Web Service.
- SyncThru™ Web Service explanation in this user's guide may differ from your machine depending on its options or models.
- Network model only (see "Software" on page 9).

Accessing SyncThru™ Web Service

- 1 Access a web browser, such as Internet Explorer, from Windows.
Enter the machine IP address of your printer (<http://xxx.xxx.xxx.xxx>) in the address field and press the Enter key or click **Go**.
- 2 Your machine's embedded website opens.

Logging into SyncThru™ Web Service

Before configuring options in SyncThru™ Web Service, you need to log-in as an administrator. You can still use SyncThru™ Web Service without logging in but you won't have access to **Settings** tab and **Security** tab.

- 1 Click **Login** on the upper right of the SyncThru™ Web Service website.
- 2 Type in the **ID** and **Password** then click **Login**. Type in the below default ID and password. We recommend you to change the default password for security reasons.
 - **ID: admin**
 - **Password: sec00000**

SyncThru™ Web Service overview



Information

Settings

Security

Maintenance



Some tabs may not appear depending on your model.

Using SyncThru™ Web Service

Information tab

This tab gives you general information about your machine. You can check things, such as remaining amount of toner. You can also print reports, such as an error report.

- **Active Alerts:** Shows the alerts that have occurred in the machine and their severity.
- **Supplies:** Shows how many pages are printed and amount of toner left in the cartridge.
- **Usage Counters:** Shows the usage count by print types: simplex and duplex.
- **Current Settings:** Shows the machine's and network's information.
- **Print information:** Prints reports such as system related reports, e-mail address, and font reports.

Settings tab

This tab allows you to set configurations provided by your machine and network. You need to log-in as an administrator to view this tab.

- **Machine Settings tab:** Sets options provided by your machine.
- **Network Settings tab:** Shows options for the network environment. Sets options such as TCP/IP and network protocols.

Security tab

This tab allows you to set system and network security information. You need to log-in as an administrator to view this tab.

- **System Security:** Sets the system administrator's information and also enables or disables machine features.
- **Network Security:** Sets settings for HTTPs, IPSec, IPv4/IPv6 filtering, 802.1x, and Authentication servers.
- **User Access Control:** Classifies users into several groups according to each user's role. Each user's authorization, authentication and accounting will be controlled by the group's role definition.

Maintenance tab

This tab allows you to maintain your machine by upgrading firmware and setting contact information for sending emails. You can also connect to Samsung website or download drivers by selecting the **Link** menu.

- **Firmware Upgrade:** Upgrade your machine's firmware.
- **Contact Information:** Shows the contact information.
- **Link:** Shows links to useful sites where you can download or check information.
- **License Management:** License management provides settings for or settings of installed applications and application license.

Using SyncThru™ Web Service

- **Cloning:** You can import or export (transfer) various settings (machine setting, network information, address book, etc.) between devices that have the **Cloning** feature in SyncThru™ Web Service.

E-mail notification setup

You can receive emails about your machine's status by setting this option. By setting information such as IP address, host name, e-mail address and SMTP server information, the machine status (toner cartridge shortage or machine error) will be sent to a certain person's e-mail automatically. This option may be used more frequently by a machine administrator.



Some menus may not appear in the display depending on options or models. If so, it is not applicable to your machine.

- 1** Start a web browser, such as Internet Explorer, from Windows.
Enter the machine IP address (<http://xxx.xxx.xxx.xxx>) in the address field and press the Enter key or click **Go**.
- 2** Your machine's embedded website opens.
- 3** From the **Settings** tab, select **Machine Settings > E-mail Notification**.



If you have not configured outgoing server environment, go to **Settings > Network Settings > Outgoing Mail Server(SMTP)** to configure network environment before setting e-mail notification.

4

Select **Enable** check box to use the **E-mail Notification**.

5

Click **Add** button to add e-mail notification user.

Set the recipient name and e-mail address(es) with notification items you want to receive an alert for.

6

Click **Apply**.



If the firewall is activated, the e-mail may not be sent successfully. In that case, contact the a network administrator.

Setting the system administrator's information

This setting is necessary for using the e-mail notification option.



Some menus may not appear in the display depending on options or models. If so, it is not applicable to your machine.

Using SyncThru™ Web Service

- 1** Start a web browser, such as Internet Explorer, from Windows.
Enter the machine IP address (http://xxx.xxx.xxx.xxx) in the address field and press the Enter key or click **Go**.
- 2** Your machine's embedded website opens.
- 3** From the **Security** tab, select **System Security** > **System Administrator**
- 4** Enter the name of the administrator, phone number, location, and email address.
- 5** Click **Apply**.

Using Samsung Easy Printer Manager



- This feature may not be available depending on model or optional goods (see "Software" on page 9).
- Available for Windows and Mac OS users only (see "Software" on page 9).
- For Windows, Internet Explorer 6.0 or higher is the minimum requirement for Samsung Easy Printer Manager.

Samsung Easy Printer Manager is an application that combines Samsung machine settings into one location. Samsung Easy Printer Manager combines device settings as well as printing environments, settings/actions and launching. All of these features provide a gateway to conveniently use your Samsung machine. Samsung Easy Printer Manager provides two different user interfaces for the user to choose from: the basic user interface and the advanced user interface. Switching between the two interfaces is easy: just click a button.

Understanding Samsung Easy Printer Manager

To open the program:

For Windows,

Select **Start > Programs** or **All Programs > Samsung Printers > Samsung Easy Printer Manager > Samsung Easy Printer Manager**.

For Mac,

Open the **Applications** folder > **Samsung** folder > **Samsung Easy Printer Manager**.

The Samsung Easy Printer Manager interface is comprised of various basic sections as described in the table that follows:





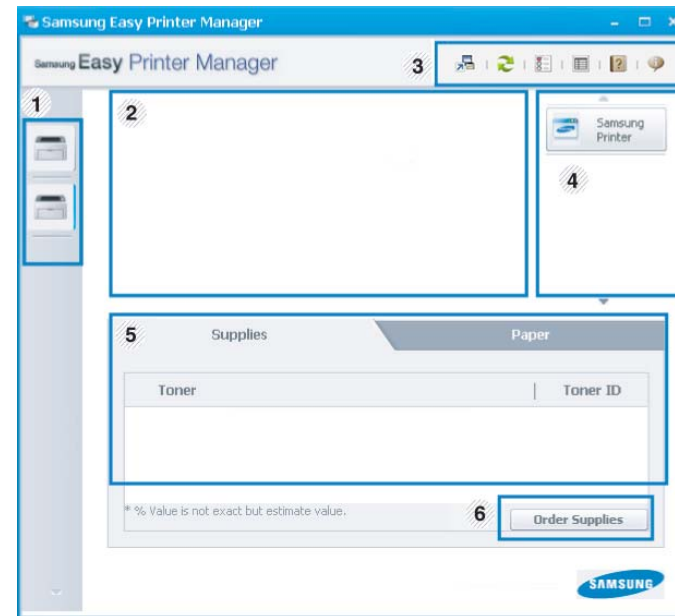

The screenshot may differ depending on the operating system you are using.



1	Printer list	The Printer List displays printers installed on your computer and network printers added by network discovery (Windows only).
---	--------------	---

Using Samsung Easy Printer Manager

2	Printer information	<p>This area gives you general information about your machine. You can check information, such as the machine's model name, IP address (or Port name), and machine status.</p> <p> You can view the online User's Guide.</p> <p>Troubleshooting button: This button opens the Troubleshooting Guide when an error occurs. You can directly open the necessary section in the user's guide.</p>
3	Application information	<p>Includes links for changing to the advanced settings (switching UI), refresh, preference setting, summary, help, and about.</p> <p> The  button is used to change the user interface to the advanced settings user interface (see "Advanced settings user interface overview" on page 220).</p>

4	Quick links	<p>Displays Quick links to machine specific functions. This section also includes links to applications in the advanced settings.</p> <p> If you connect your machine to a network, the SyncThru™ Web Service icon is enabled.</p>
5	Contents area	<p>Displays information about the selected machine, remaining toner level, and paper. The information will vary based on the machine selected. Some machines do not have this feature.</p>
6	Order supplies	<p>Click on the Order button from the supply ordering window. You can order replacement toner cartridge(s) from online.</p>

 Select the **Help** menu from the window and click on any option you want to know about.

Advanced settings user interface overview

The advanced user interface is intended to be used by the person responsible for managing the network and machines.

Using Samsung Easy Printer Manager



Some menus may not appear in the display depending on options or models. If so, it is not applicable to your machine.

Device Settings

You can configure various machine settings such as machine setup, paper, layout, emulation, network, and print information.

Alert Settings (Windows only)

This menu includes settings related to error alerting.

- **Printer Alert:** Provides settings related to when alerts will be received.
- **Email Alert:** Provides options relating to receiving alerts via email.
- **Alert History:** Provides a history of device and toner related alerts.

Job Accounting

Provides querying of quota information of the specified job accounting user. This quota information can be created and applied to devices by job accounting software such as SyncThru™ or CounThru™ admin software.

Using Samsung Printer Status

The Samsung Printer Status is a program that monitors and informs you of the machine status.



- The Samsung Printer Status window and its contents shown in this user's guide may differ depending on the machine or operating system in use.
- Check the operating system(s) that are compatible with your machine (see "Specifications" on page 101).
- Available for Windows OS users only (see "Software" on page 9).

Samsung Printer Status overview

If an error occurs while operating, you can check the error from the Samsung Printer Status. Samsung Printer Status is installed automatically when you install the machine software.

You can also launch Samsung Printer Status manually. Go to the **Printing Preferences**, click the **Basic** tab > **Printer Status** button.

These icons appear on the Windows task bar:

Icon	Mean	Description
	Normal	The machine is in ready mode and experiencing no errors or warnings.
	Warning	The machine is in a state where an error might occur in the future. For example, it might be in toner low status, which may lead to toner empty status.
	Error	The machine has at least one error.

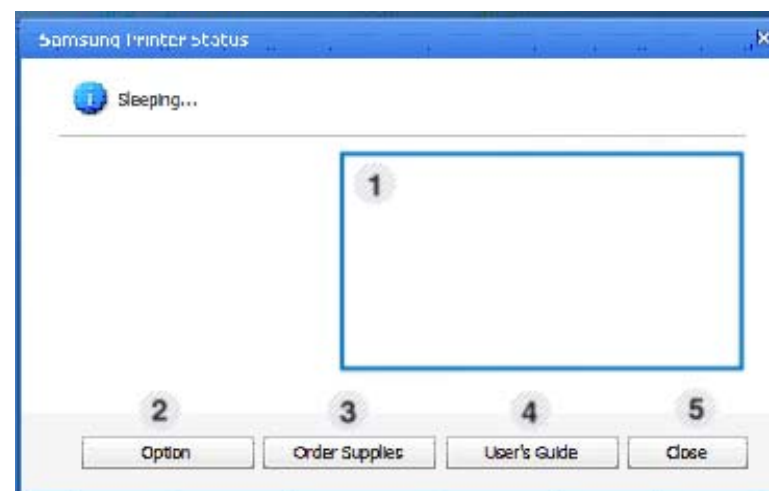

1	Toner Level	You can view the level of toner remaining in each toner cartridge. The machine and the number of toner cartridge(s) shown in the above window may differ depending on the machine in use. Some machines do not have this feature.
---	--------------------	---

Using Samsung Printer Status

2	Option	You can set printing job alert related settings.
3	Order Supplies	You can order replacement toner cartridge(s) from online.
4	User's Guide	<p>You can view the online User's Guide.</p> <div data-bbox="421 459 1084 703"> This button opens the Troubleshooting Guide when an error occurs. You can directly open the troubleshooting section in the user's guide.</div>
5	Close	Close the window.

Using Samsung Printer Experience

Samsung Printer Experience is a Samsung application that combines Samsung machine settings and machine management into one location. You can set device settings, order supplies, open troubleshooting guides, visit Samsung's web site, and check connected machine information. This application will be automatically downloaded from the Windows **Store** if the machine is connected to a computer with an Internet connection.

Understanding the Samsung Printer Experience

To open the application,

From the **Start** screen, select the **Samsung Printer Experience** () tile.

The **Samsung Printer Experience** interface comprises various useful features as described in the following table:

 The screenshot may differ depending on the model you are using.

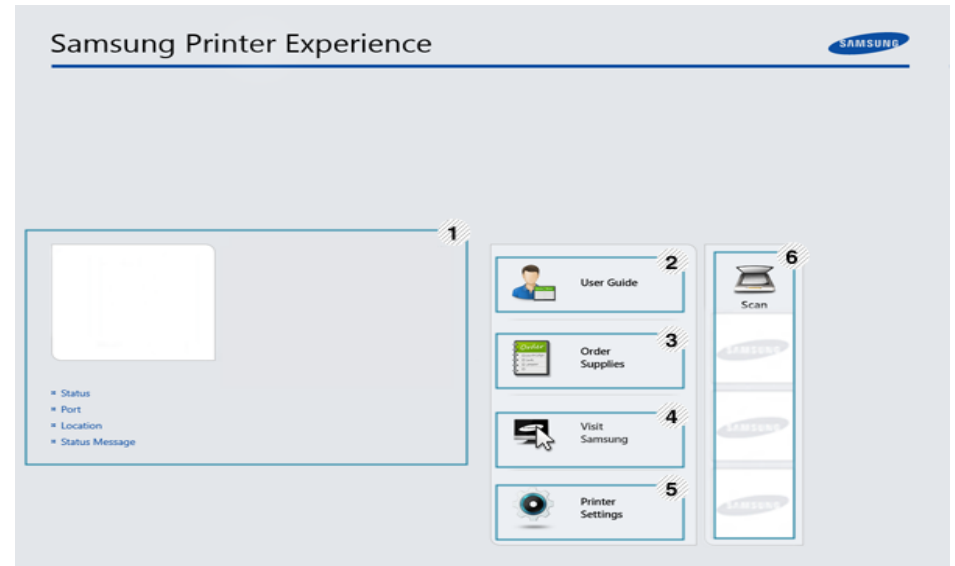

1	Printer Information	This area gives you general information about your machine. You can check information, such as the machine's status, location, IP address, and remaining toner level.
---	----------------------------	---

Using Samsung Printer Experience

2	User Guide	You can view the online User's Guide. You need to be connected to the Internet to use this feature.  This button opens the Troubleshooting Guide when an error occurs. You can directly open the troubleshooting section in the user's guide.
3	Order Supplies	Click on this button to order replacement toner cartridges online. You need to be connected to the Internet to use this feature.
4	Visit Samsung	Links to Samsung printer website. You need to be connected to the Internet to use this feature.
5	Printer Settings	You can configure various machine settings such as machine setup, paper, layout, emulation, networking, and print information through SyncThru™ Web Service . Your machine needs to be connected to a network. This button will be disabled if your machine is connected via USB cable.
6	Device List & Latest Scanned Image	The scan list displays devices that supports Samsung Printer Experience . Under the device, you can see the latest scanned images. Your machine needs to be connected to a network to scan from here. This section is for the users with multi-functional printers.

Printing from Windows 8

This section explains common printing tasks from the **Start** screen.

Basic printing

- 1 Open the document to print.
- 2 From the **Charms**, select **Devices**.
- 3 Select your printer from the list
- 4 Select the printer settings, such as the number of copies and orientation.

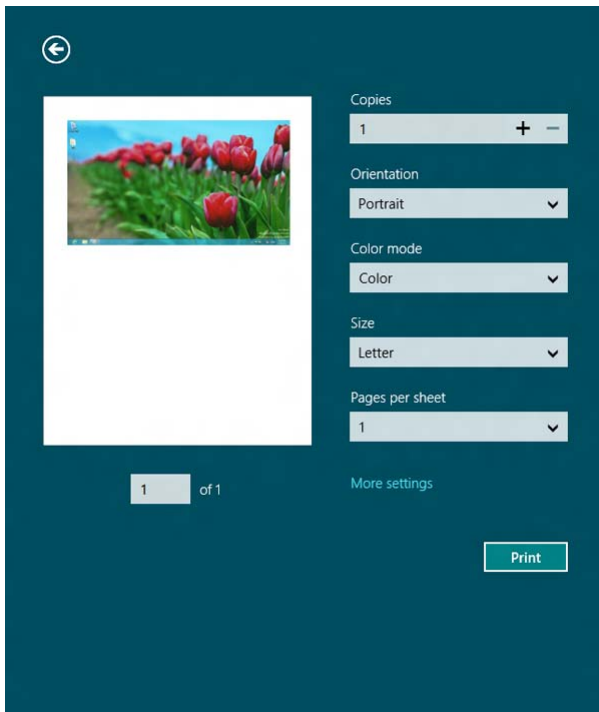

Using Samsung Printer Experience

- 5 Click the **Print** button to start the print job.



Canceling a print job

If the printing job is waiting in the print queue or print spooler, cancel the job as follows:

- You can access this window by simply double-clicking the machine icon () in the Windows task bar.
- You can also cancel the current job by pressing  (**Stop/Clear**) button on the control panel.

Opening more settings



The screen may appear somewhat different depending on the model or options.

You can set up more printing parameters.

- 1 Open the document you want to print.
- 2 From the **Charms**, select **Devices**.
- 3 Select your printer from the list
- 4 Click **More settings**.

Using Samsung Printer Experience

Basic tab

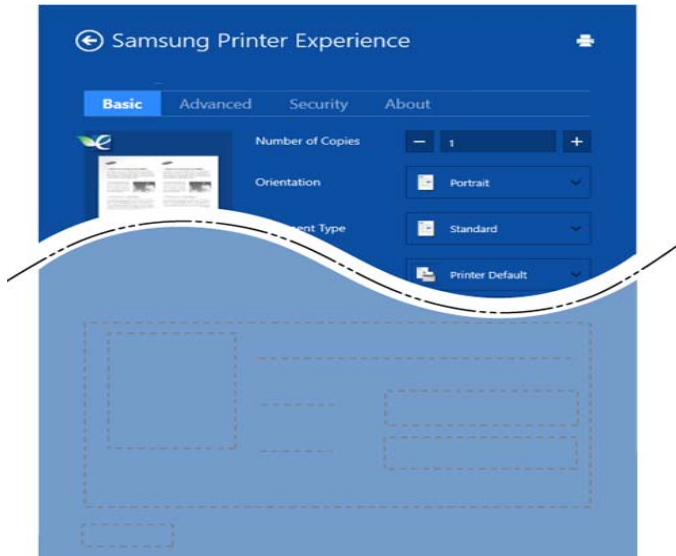

Basic

This option allows you to choose the basic printing settings such as copies, orientation, and document type.

Eco settings

This option allows you to choose multiple pages per side to save media.

Advanced tab

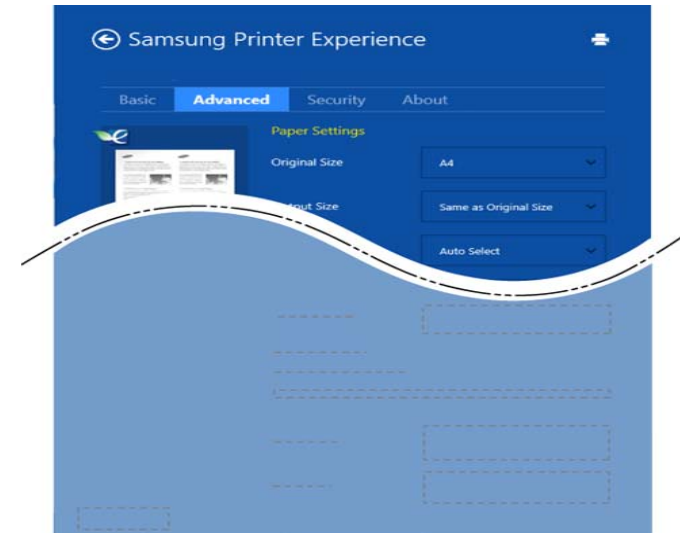

Paper settings

This option allows you to set the basic paper handling specifications.

Layout settings

This option allows you to set the various ways to layout your documents.

Using Samsung Printer Experience

Security tab



Some features may not be available depending on the model or options. If this tab is not shown or disabled, it means that these features are not supported.

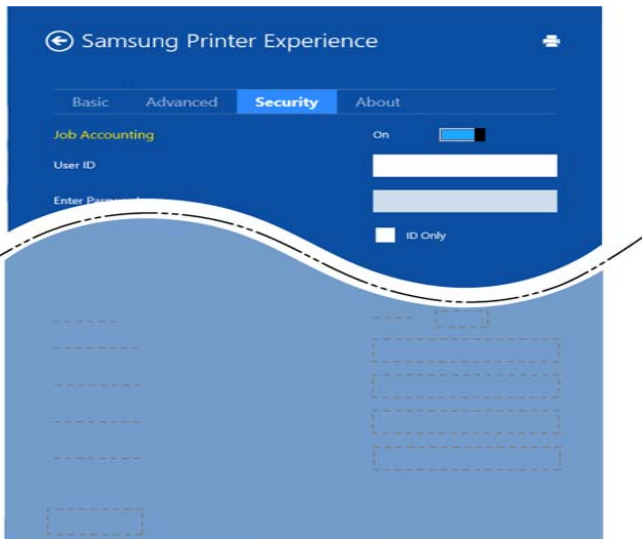

Job Accounting

This option allows you to print with the given permission.

Confidential Printing

This option is used for printing confidential documents. You need to enter a password to print using it.

Scanning from Windows 8





This section is for the users with multi-functional printers.

Scanning with your machine lets you turn pictures and text into digital files that can be stored on your computer.

Scanning from Samsung Printer Experience

The most frequently used printing menus are displayed for quick scanning.

- 1 Place a single document face down on the document glass, or load the documents face up into the document feeder.
- 2 Click the **Samsung Printer Experience** tile on the **Start** screen.
- 3 Click **Scan** ().
- 4 Set up the scanning parameters such as image type, document size, and resolution.
- 5 Click **Prescan** () to check the image.
- 6 Adjust the prescanned image with scanning operation functions such as rotate and mirror.

Using Samsung Printer Experience

7

Click **Scan** () and save the image.



- When you place the originals in the ADF (or DADF), **Prescan** () is not available.
- You can skip step 5, if the Prescan option is selected.

Using the Linux Unified Driver Configurator

The Unified Driver Configurator is a tool primarily intended for configuring machine devices. You need to install Unified Linux Driver to use Unified Driver Configurator (see "Installation for Linux" on page 126).

After the driver is installed on your Linux system, the Unified Driver Configurator icon will automatically be created on your desktop.

Opening Unified Driver Configurator

- 1 Double-click the **Unified Driver Configurator** on the desktop. You can also click the **Startup** Menu icon and select **Samsung Unified Driver > Unified Driver Configurator**.
- 2 Click each button on the left to switch to the corresponding configuration window.

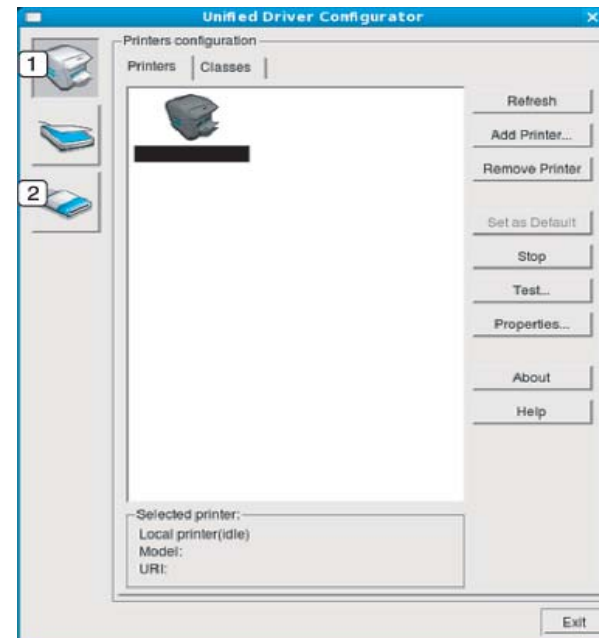

- 1 **Printer Configuration**
- 2 **Port Configuration**

Using the Linux Unified Driver Configurator



To use the on screen help, the **Help** or **?** button from the window.

- 3 After changing the configurations, click **Exit** to close the **Unified Driver Configurator**.

Printers configuration

Printers configuration has the two tabs: **Printers** and **Classes**.

Printers tab

View the current system's printer configuration by clicking on the machine icon button on the left side of the **Unified Driver Configurator** window.

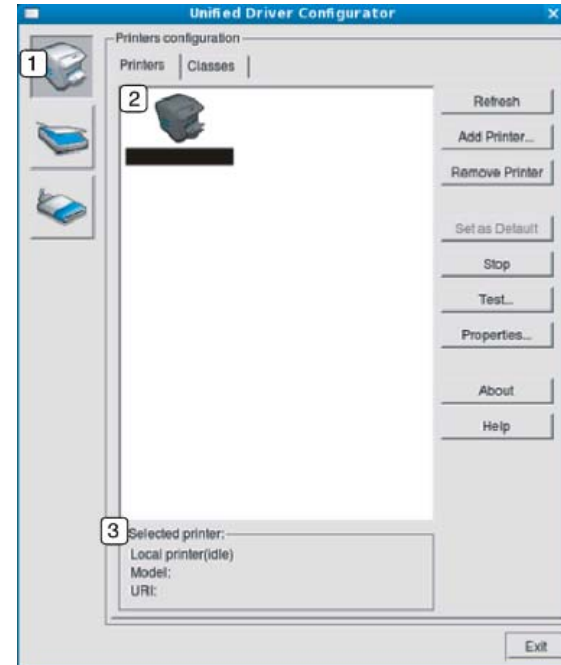

- | | |
|---|--|
| 1 | Switches to Printers configuration . |
| 2 | Shows all of the installed machines. |
| 3 | Shows the status, model name, and URI of your machine. |

Using the Linux Unified Driver Configurator

The printer control buttons are, as follows:

- **Refresh:** Renews the available machines list.
- **Add Printer:** Allows you to add a new machines.
- **Remove Printer:** Removes the selected machine.
- **Set as Default:** Sets the current selected machine as a default machine.
- **Stop/Start:** Stops/starts the machine.
- **Test:** Allows you to print a test page to ensure the machine is working properly.
- **Properties:** Allows you to view and change the printer's properties.

Classes tab

The Classes tab shows a list of available machine classes.

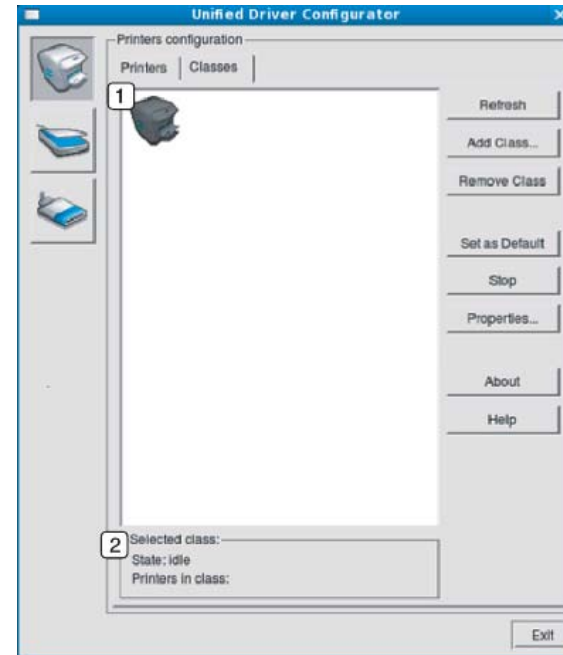

- | | |
|---|--|
| 1 | Shows all of the machine classes. |
| 2 | Shows the status of the class and the number of machines in the class. |

- **Refresh:** Renews the classes list.
- **Add Class:** Allows you to add a new machine class.
- **Remove Class:** Removes the selected machine class.

Using the Linux Unified Driver Configurator

Ports configuration

In this window, you can view the list of available ports, check the status of each port and release a port that is stalled in a busy state when its owner has terminated the job for any reason.

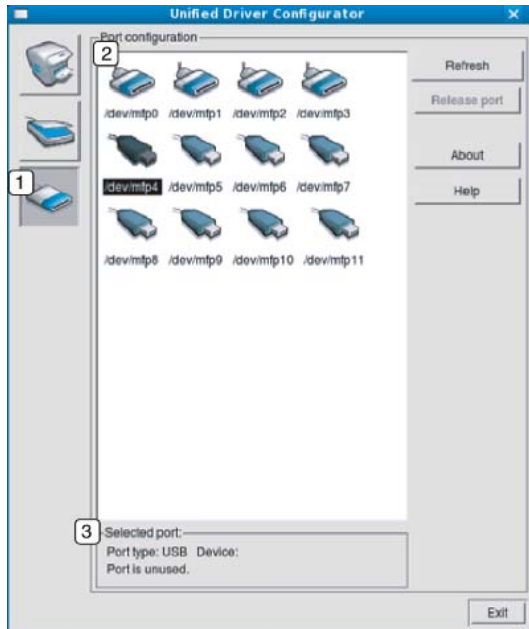

1	Switches to Ports configuration .
2	Shows all of the available ports.
3	Shows the port type, device connected to the port, and status.

- **Refresh:** Renews the available ports list.
- **Release port:** Releases the selected port.



6. Troubleshooting

This chapter gives helpful information for what to do if you encounter an error.

- **Paper feeding problems** 235
- **Power and cable connecting problems** 236
- **Printing problems** 237
- **Printing quality problems** 241
- **Operating system problems** 249



For errors that occur during the wireless software installation and settings, refer to the troubleshooting section in the wireless setting chapter (see "Troubleshooting for wireless network" on page 165).

Paper feeding problems

Condition	Suggested solutions
Paper jams during printing.	Clear the paper jam.
Paper sticks together.	<ul style="list-style-type: none">• Check the maximum paper capacity of the tray.• Make sure that you are using the correct type of paper.• Remove paper from the tray and flex or fan the paper.• Humid conditions may cause some paper to stick together.
Multiple sheets of paper do not feed.	Different types of paper may be stacked in the tray. Load paper of only one type, size, and weight.
Paper does not feed into the machine.	<ul style="list-style-type: none">• Remove any obstructions from inside the machine.• Paper has not been loaded correctly. Remove paper from the tray and reload it correctly.• There is too much paper in the tray. Remove excess paper from the tray.• The paper is too thick. Use only paper that meets the specifications required by the machine.
The paper keeps jamming.	<ul style="list-style-type: none">• There is too much paper in the tray. Remove excess paper from the tray. If you are printing on special materials, use the manual feeding in tray.• An incorrect type of paper is being used. Use only paper that meets the specifications required by the machine.• There may be debris inside the machine. Open the front cover and remove any debris.
Envelopes skew or fail to feed correctly.	Ensure that the paper guides are against both sides of the envelopes.

Power and cable connecting problems

Condition	Suggested solutions
The machine is not receiving power, or the connection cable between the computer and the machine is not connected properly.	<ul style="list-style-type: none">• Connect the machine to the electricity supply first. If the machine has a  (Power) button on the control, press it.• Disconnect the machine's cable and reconnect it.

Printing problems

Condition	Possible cause	Suggested solutions
The machine does not print.	The machine is not receiving power.	Connect the machine to the electricity supply first. If the machine has a  (Power) button on the control, press it.
	The machine is not selected as the default machine.	Select your machine as your default machine in Windows.
	Check the machine for the following: <ul style="list-style-type: none">• The cover is not closed. Close the cover.• Paper is jammed. Clear the paper jam (see "Clearing paper jams" on page 80).• No paper is loaded. Load paper (see "Loading paper in the tray" on page 36).• The toner cartridge is not installed. Install the toner cartridge (see "Replacing the toner cartridge" on page 62).• Make sure the protect cover and sheets are removed from the toner cartridge (see "Replacing the toner cartridge" on page 62). If a system error occurs, contact your service representative.	
	The connection cable between the computer and the machine is not connected properly.	Disconnect the machine cable and reconnect it (see "Rear view" on page 21).
	The connection cable between the computer and the machine is defective.	If possible, attach the cable to another computer that is working properly and print a job. You can also try using a different machine cable.
	The port setting is incorrect.	Check the Windows printer settings to make sure that the print job is sent to the correct port. If the computer has more than one port, make sure that the machine is attached to the correct one.

Printing problems

Condition	Possible cause	Suggested solutions
The machine does not print.	The machine may be configured incorrectly.	Check the Printing Preferences to ensure that all of the print settings are correct.
	The printer driver may be incorrectly installed.	Uninstall and reinstall the machine's driver.
	The machine is malfunctioning.	Check the display message on the control panel to see if the machine is indicating a system error. Contact a service representative.
	The document size is so big that the hard disk space of the computer is insufficient to access the print job.	Get more hard disk space and print the document again.
	The output tray is full.	Once the paper is removed from the output tray, the machine resumes printing.
The machine selects print materials from the wrong paper source.	The paper option that was selected in the Printing Preferences may be incorrect.	For many software applications, the paper source selection is found under the Paper tab within the Printing Preferences (see "Opening printing preferences" on page 47). Select the correct paper source. See the printer driver help screen (see "Using help" on page 48).
A print job is extremely slow.	The job may be very complex.	Reduce the complexity of the page or try adjusting the print quality settings.
Half the page is blank.	The page orientation setting may be incorrect.	Change the page orientation in your application (see "Opening printing preferences" on page 47). See the printer driver help screen (see "Using help" on page 48).
	The paper size and the paper size settings do not match.	Ensure that the paper size in the printer driver settings matches the paper in the tray. Or, ensure that the paper size in the printer driver settings matches the paper selection in the software application settings you use (see "Opening printing preferences" on page 47).
The machine prints, but the text is wrong, garbled, or incomplete.	The machine cable is loose or defective.	Disconnect the machine cable and reconnect. Try a print job that you have already printed successfully. If possible, attach the cable and the machine to another computer that you know works and try a print job. Finally, try a new machine cable.

Printing problems



Condition	Possible cause	Suggested solutions
	The wrong printer driver was selected.	Check the application's printer selection menu to ensure that your machine is selected.
	The software application is malfunctioning.	Try printing a job from another application.
	The operating system is malfunctioning.	Exit Windows and reboot the computer. Turn the machine off and back on again.
Pages print, but they are blank.	The toner cartridge is defective or out of toner.	Redistribute the toner, if necessary. If necessary, replace the toner cartridge. <ul style="list-style-type: none">• See "Redistributing toner" on page 60.• See "Replacing the toner cartridge" on page 62.
	The file may have blank pages.	Check the file to ensure that it does not contain blank pages.
	Some parts, such as the controller or the board, may be defective.	Contact a service representative.
The machine does not print PDF files correctly. Some parts of graphics, text, or illustrations are missing.	Incompatibility between the PDF file and the Acrobat products.	Printing the PDF file as an image may enable the file to print. Turn on Print As Image from the Acrobat printing options.  It will take longer to print when you print a PDF file as an image.
The print quality of photos is not good. Images are not clear.	The resolution of the photo is very low.	Reduce the photo size. If you increase the photo size in the software application, the resolution will be reduced.
Before printing, the machine emits vapor near the output tray.	Using damp/wet paper can cause vapor [white smoke] during printing.	This is not a problem. Just keep printing. If you are bothered by the smoke [vapor], then replace the paper with fresh paper from an unopened ream.

Printing problems

Condition	Possible cause	Suggested solutions
The machine does not print custom-sized paper, such as billing paper.	Paper size and paper size setting do not match.	Set the correct paper size in the Custom in Paper tab in Printing Preferences (see "Opening printing preferences" on page 47).
The printed billing paper is curled.	The paper type setting does not match.	Change the printer option and try again. Go to Printing Preferences , click Paper tab, and set type to Thin (see "Opening printing preferences" on page 47).

Printing quality problems

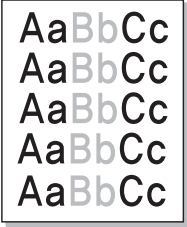

If the inside of the machine is dirty or paper has been loaded improperly, there might be a reduction in print quality. See the table below to clear the problem.

Condition	Suggested solutions
<p data-bbox="49 403 322 435">Light or faded print</p> 	<ul data-bbox="506 403 2188 799" style="list-style-type: none">• If a vertical white streak or faded area appears on the page, the toner supply is low. Install a new toner cartridge (see "Replacing the toner cartridge" on page 62).• The paper may not meet paper specifications; for example, the paper may be too moist or rough.• If the entire page is light, the print resolution setting is too low or the toner save mode is on. Adjust the print resolution and turn the toner save mode off. See the help screen of the printer driver.• A combination of faded or smeared defects may indicate that the toner cartridge needs cleaning. Clean the inside of your machine (see "Cleaning the machine" on page 73).• The surface of the LSU part inside the machine may be dirty. Clean the inside of your machine (see "Cleaning the machine" on page 73). If these steps do not correct the problem, contact a service representative.
<p data-bbox="49 834 472 946">The top half of the paper is printed lighter than the rest of the paper</p> 	<p data-bbox="506 834 1301 866">The toner might not adhere properly to this type of paper.</p> <ul data-bbox="506 885 2188 962" style="list-style-type: none">• Change the printer option and try again. Go to Printing Preferences, click the Paper tab, and set the paper type to Recycled (see "Opening printing preferences" on page 47).

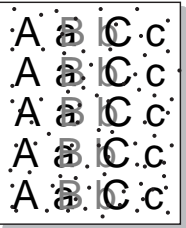
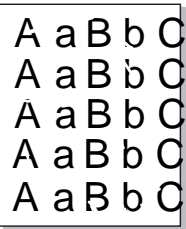
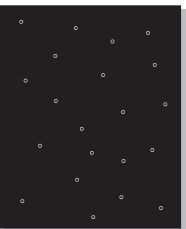
Printing quality problems

Condition	Suggested solutions
<p>Toner specks</p> 	<ul style="list-style-type: none">• The paper may not meet specifications; for example, the paper may be too moist or rough.• The transfer roller may be dirty. Clean the inside of your machine (see "Cleaning the machine" on page 73).• The paper path may need cleaning. Contact a service representative (see "Cleaning the machine" on page 73).
<p>Dropouts</p> 	<p>If faded areas, generally rounded, occur randomly on the page:</p> <ul style="list-style-type: none">• A single sheet of paper may be defective. Try reprinting the job.• The moisture content of the paper is uneven or the paper has moist spots on its surface. Try a different brand of paper.• The paper lot is bad. The manufacturing processes can cause some areas to reject toner. Try a different kind or brand of paper.• Change the printer option and try again. Go to Printing Preferences, click the Paper tab, and set type to Thick (see "Opening printing preferences" on page 47). <p>If these steps do not correct the problem, contact a service representative.</p>
<p>White Spots</p> 	<p>If white spots appear on the page:</p> <ul style="list-style-type: none">• The paper is too rough and a lot of dirt from paper falls to the inner components within the machine, so the transfer roller may be dirty. Clean the inside of your machine (see "Cleaning the machine" on page 73).• The paper path may need cleaning. Clean the inside of your machine (see "Cleaning the machine" on page 73). <p>If these steps do not correct the problem, contact a service representative.</p>

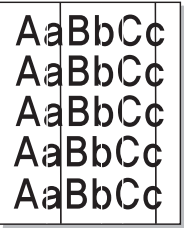
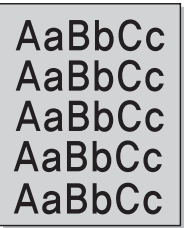
Printing quality problems

Condition	Suggested solutions
<p>Vertical lines</p> 	<p>If black vertical streaks appear on the page:</p> <ul style="list-style-type: none">• The surface (drum part) of the cartridge inside the machine has probably been scratched. Remove the cartridge and install a new one (see "Replacing the toner cartridge" on page 62, "Replacing the imaging unit" on page 65). <p>If white vertical streaks appear on the page:</p> <ul style="list-style-type: none">• The surface of the LSU part inside the machine may be dirty. Clean the inside of your machine (see "Cleaning the machine" on page 73). If these steps do not correct the problem, contact a service representative.
<p>Black or color background</p> 	<p>If the amount of background shading becomes unacceptable:</p> <ul style="list-style-type: none">• Change to a lighter weight paper.• Check the environmental conditions: very dry conditions or a high level of humidity (higher than 80% RH) can increase the amount of background shading.• Remove the old toner cartridge and install a new one (see "Replacing the toner cartridge" on page 62).• Thoroughly redistribute the toner (see "Redistributing toner" on page 60).
<p>Toner smear</p> 	<ul style="list-style-type: none">• Clean the inside of the machine (see "Cleaning the machine" on page 73).• Check the paper type and quality.• Remove the toner cartridge and install a new one (see "Replacing the toner cartridge" on page 62).

Printing quality problems

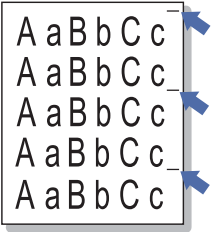
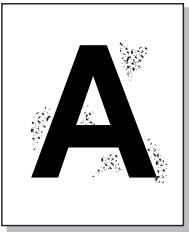
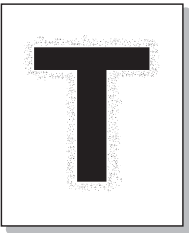
Condition	Suggested solutions
<p data-bbox="49 272 409 304">Vertical repetitive defects</p> 	<p data-bbox="504 272 1473 304">If marks repeatedly appear on the printed side of the page at even intervals:</p> <ul data-bbox="504 328 2190 544" style="list-style-type: none"><li data-bbox="504 328 2190 400">• The toner cartridge may be damaged. If you still have the same problem, remove the toner cartridge and, install a new one (see "Replacing the toner cartridge" on page 62).<li data-bbox="504 416 2190 488">• Parts of the machine may have toner on them. If the defects occur on the back of the page, the problem will likely correct itself after a few more pages.<li data-bbox="504 504 1464 544">• The fusing assembly may be damaged. Contact a service representative.
<p data-bbox="49 612 322 644">Background scatter</p> 	<p data-bbox="504 612 1621 644">Background scatter results from bits of toner randomly distributed on the printed page.</p> <ul data-bbox="504 668 2190 1059" style="list-style-type: none"><li data-bbox="504 668 2190 740">• The paper may be too damp. Try printing with a different batch of paper. Do not open packages of paper until necessary so that the paper does not absorb too much moisture.<li data-bbox="504 756 2190 876">• If background scatter occurs on an envelope, change the printing layout to avoid printing over areas that have overlapping seams on the reverse side. Printing on seams can cause problems. Or select Thick from the Printing Preferences window (see "Opening printing preferences" on page 47).<li data-bbox="504 892 2190 1011">• If background scatter covers the entire surface area of a printed page, adjust the print resolution through your software application or in Printing Preferences (see "Opening printing preferences" on page 47). Ensure the correct paper type is selected. For example: If Thicker Paper is selected, but Plain Paper actually used, an overcharging can occur causing this copy quality problem.<li data-bbox="504 1027 1868 1059">• If you are using a new toner cartridge, redistribute the toner first (see "Redistributing toner" on page 60).
<p data-bbox="49 1091 479 1163">Toner particles are around bold characters or pictures</p> 	<p data-bbox="504 1091 1249 1123">The toner might not adhere properly to this type of paper.</p> <ul data-bbox="504 1147 2190 1315" style="list-style-type: none"><li data-bbox="504 1147 2190 1219">• Change the printer option and try again. Go to Printing Preferences, click the Paper tab, and set the paper type to Recycled (see "Opening printing preferences" on page 47).<li data-bbox="504 1235 2190 1315">• Ensure the correct paper type is selected. For example: If Thicker Paper is selected, but Plain Paper actually used, an overcharging can occur causing this copy quality problem.

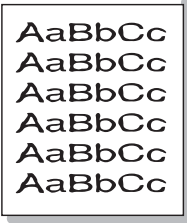
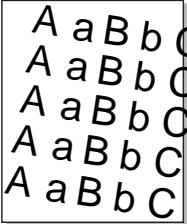
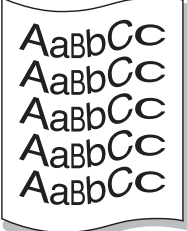

Printing quality problems

Condition	Suggested solutions
<p data-bbox="49 272 353 304">Misformed characters</p> 	<ul data-bbox="504 272 2072 304" style="list-style-type: none">• If characters are improperly formed and producing hollow images, the paper stock may be too slick. Try different paper.
<p data-bbox="49 608 203 639">Page skew</p> 	<ul data-bbox="504 608 1518 743" style="list-style-type: none">• Ensure that the paper is loaded properly.• Check the paper type and quality.• Ensure that the guides are not too tight or too loose against the paper stack.
<p data-bbox="49 951 226 983">Curl or wave</p> 	<ul data-bbox="504 951 1729 1086" style="list-style-type: none">• Ensure that the paper is loaded properly.• Check the paper type and quality. Both high temperature and humidity can cause paper curl.• Turn the stack of paper over in the tray. Also try rotating the paper 180° in the tray.

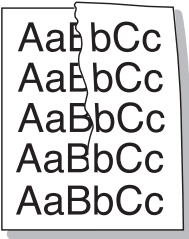
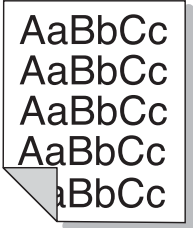
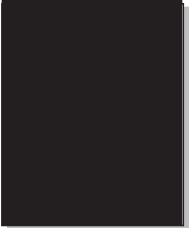
Printing quality problems

Condition	Suggested solutions
<p data-bbox="49 272 315 304">Wrinkles or creases</p> 	<ul data-bbox="506 272 1597 411" style="list-style-type: none">• Ensure that the paper is loaded properly.• Check the paper type and quality.• Turn the stack of paper over in the tray. Also try rotating the paper 180° in the tray.
<p data-bbox="49 619 412 651">Back of printouts are dirty</p> 	<ul data-bbox="506 619 1787 651" style="list-style-type: none">• Check for leaking toner. Clean the inside of the machine (see "Cleaning the machine" on page 73).
<p data-bbox="49 986 405 1018">Solid color or black pages</p> 	<ul data-bbox="506 986 2159 1161" style="list-style-type: none">• The toner cartridge may not be installed properly. Remove the cartridge and reinsert it.• The toner cartridge may be defective. Remove the toner cartridge and install a new one (see "Replacing the toner cartridge" on page 62).• The machine may require repairing. Contact a service representative.

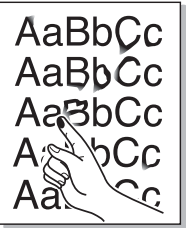
Printing quality problems

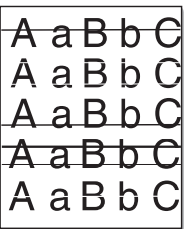
Condition	Suggested solutions
<p>Loose toner</p> 	<ul style="list-style-type: none">• Clean the inside of the machine (see "Cleaning the machine" on page 73).• Check the paper type, thickness, and quality.• Remove the toner cartridge and then, install a new one (see "Replacing the toner cartridge" on page 62). <p>If the problem persists, the machine may require repair. Contact a service representative.</p>
<p>Character voids</p> 	<p>Character voids are white areas within parts of characters that should be solid black:</p> <ul style="list-style-type: none">• You may be printing on the wrong surface of the paper. Remove the paper and turn it around.• The paper may not meet paper specifications.
<p>Horizontal stripes</p> 	<p>If horizontally aligned black streaks or smears appear:</p> <ul style="list-style-type: none">• The toner cartridge may be installed improperly. Remove the cartridge and reinsert it.• The toner cartridge may be defective. Remove the toner cartridge and install a new one (see "Replacing the toner cartridge" on page 62). <p>If the problem persists, the machine may require repairing. Contact a service representative.</p>

Printing quality problems

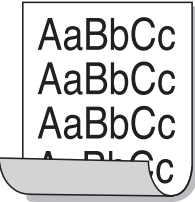
Condition	Suggested solutions
<p>Curl</p> 	<p>If the printed paper is curled or paper does not feed into the machine:</p> <ul style="list-style-type: none">• Turn the stack of paper over in the tray. Also try rotating the paper 180° in the tray.• Change the printer's paper option and try again. Go to Printing Preferences, click the Paper tab, and set type to Thin (see "Opening printing preferences" on page 47).
<ul style="list-style-type: none">• An unknown image repetitively appears on a few sheets• Loose toner• Light print or contamination occurs	<p>Your machine is probably being used at an altitude of 1,000 m (3,281 ft) or above.</p> <p>The high altitude may affect the print quality, such as loose toner or light imaging. Change the altitude setting for your machine (see "Altitude adjustment" on page 190).</p>

Operating system problems

Common Windows problems

Condition	Suggested solutions
“File in Use” message appears during installation.	Exit all software applications. Remove all software from the startup group, then restart Windows. Reinstall the printer driver.
“General Protection Fault”, “Exception OE”, “Spool 32”, or “Illegal Operation” messages appear.	Close all other applications, reboot Windows and try printing again.
“Fail To Print”, “A printer timeout error occurred” message appear.	These messages may appear during printing. Just keep waiting until the machine finishes printing. If the message appears in ready mode or after printing has completed, check the connection and/or whether an error has occurred.



Refer to the Microsoft Windows User's Guide that came with your computer for further information on Windows error messages.

Operating system problems

Common Mac problems

Condition	Suggested solutions
The machine does not print PDF files correctly. Some parts of graphics, text, or illustrations are missing.	<p>Printing the PDF file as an image may enable the file to print. Turn on Print As Image from the Acrobat printing options.</p> <p> It will take longer to print when you print a PDF file as an image.</p>
Some letters are not displayed normally during cover page printing.	<p>Mac OS cannot create the font while printing the cover page. The English alphabet and numbers are displayed normally on the cover page.</p>



Refer to the Mac User's Guide that came with your computer for further information on Mac error messages.

Operating system problems

Common Linux problems

condition	Suggested solutions
The machine does not print.	<ul style="list-style-type: none">• Check if the printer driver is installed in your system. Open Unified Driver Configurator and switch to the Printers tab in Printers configuration window to look at the list of available machines. Make sure that your machine is displayed on the list. If not, open Add new printer wizard to set up your device.• Check if the machine is started. Open Printers configuration and select your machine on the printers list. Look at the description in the Selected printer pane. If its status contains Stopped string, press the Start button. After that normal operation of the machine should be restored. The “stopped” status might be activated when some problems in printing occurred.• Check if your application has special print option such as “-oraw”. If “-oraw” is specified in the command line parameter, then remove it to print properly. For Gimp front-end, select “print” -> “Setup printer” and edit command line parameter in the command item.
I encounter error “Cannot open port device file” when printing a document.	Avoid changing print job parameters (via LPR GUI, for example) while a print job is in progress. Known versions of CUPS (Common UNIX Printing System) server break the print job whenever print options are changed and then try to restart the job from the beginning. Since Unified Linux Driver locks the port while printing, the abrupt termination of the driver keeps the port locked and unavailable for subsequent print jobs. If this situation occurs, try to release the port by selecting Release port in Port configuration window.
When printing a document over the network in SuSE 9.2, the printer does not print.	The CUPS (Common UNIX Printing System) version distributed with SuSE Linux 9.2 (cups-1.1.21) has a problem with ipp (Internet Printing Protocol) printing. Use the socket printing instead of ipp or install later version of CUPS (Common UNIX Printing System) (cups-1.1.22 or higher).



Refer to the Linux User’s Guide that came with your computer for further information on Linux error messages.

Operating system problems

Common PostScript problems

The following situations are PS language specific and may occur when several printer languages are used.

Problem	Possible cause	Solution
The PostScript file cannot be printed	The PostScript driver may not be installed correctly.	<ul style="list-style-type: none">• Install the PostScript driver (see "Software Installation" on page 123).• Print a configuration page and verify that the PS version is available for printing.• If the problem persists, contact a service representative.
Limit Check Error report prints	The print job was too complex.	You might need to reduce the complexity of the page or install more memory.
A PostScript error page prints	The print job may not be PostScript.	Make sure that the print job is a PostScript job. Check to see whether the software application expected a setup or PostScript header file to be sent to the machine.
The optional tray is not selected in the driver	The printer driver has not been configured to recognize the optional tray.	Open the driver properties, select the Device Options tab, and set the tray option (see "Setting Device Options" on page 67).

Contact SAMSUNG worldwide

If you have any comments or questions regarding Samsung products, contact the Samsung customer care center.

Country/Region	Customer Care Center	WebSite
ANGOLA	91-726-7864	www.samsung.com
ARGENTINA	0800-333-3733	www.samsung.com
ARMENIA	0-800-05-555	www.samsung.com
AUSTRALIA	1300 362 603	www.samsung.com
AUSTRIA	0810-SAMSUNG (7267864, € 0.07/min)	www.samsung.com
AZERBAIJAN	088-55-55-555	www.samsung.com
BAHRAIN	8000-4726	www.samsung.com/ae (English) www.samsung.com/ae_ar (Arabic)
BELARUS	810-800-500-55-500	www.samsung.com
BELGIUM	02-201-24-18	www.samsung.com/be (Dutch) www.samsung.com/be_fr (French)
BOLIVIA	800-10-7260	www.samsung.com
BOSNIA	051 133 1999	www.samsung.com

Country/Region	Customer Care Center	WebSite
BOTSWANA	0800-726-000	www.samsung.com
BRAZIL	0800-124-421 4004-0000	www.samsung.com
BULGARIA	07001 33 11 , normal tariff	www.samsung.com
CAMEROON	7095- 0077	www.samsung.com
CANADA	1-800-SAMSUNG (726-7864)	www.samsung.com/ca (English) www.samsung.com/ca_fr (French)
CHILE	800-SAMSUNG (726-7864) From mobile 02-24 82 82 00	www.samsung.com/cl
CHINA	400-810-5858	www.samsung.com
COLOMBIA	01-8000112112 Bogotá: 6001272	www.samsung.com/co
COSTA RICA	0-800-507-7267	www.samsung.com/latin (Spanish) www.samsung.com/latin_en (English)
CROATIA	062 SAMSUNG (062 726 786)	www.samsung.com
Cote D' Ivoire	8000 0077	www.samsung.com

Contact SAMSUNG worldwide

Country/Region	Customer Care Center	WebSite
CYPRUS	8009 4000 only from landline (+30) 210 6897691 from mobile and land line	www.samsung.com
CZECH	800-SAMSUNG (800-726786)	www.samsung.com
DENMARK	70 70 19 70	www.samsung.com
DOMINICA	1-800-751-2676	www.samsung.com/ latin (Spanish) www.samsung.com/ latin_en (English)
ECUADOR	1-800-10-7267	www.samsung.com/ latin (Spanish) www.samsung.com/ latin_en (English)
EGYPT	08000-726786	www.samsung.com
EIRE	0818 717100	www.samsung.com
EL SALVADOR	800-6225	www.samsung.com/ latin (Spanish) www.samsung.com/ latin_en (English)
ESTONIA	800-7267	www.samsung.com/ee
FINLAND	030-6227 515	www.samsung.com

Country/Region	Customer Care Center	WebSite
FRANCE	01 48 63 00 00	www.samsung.com/fr
GERMANY	0180 5 SAMSUNG bzw. 0180 5 7267864* (*0,14 €/Min. aus dem dt. Festnetz, aus dem Mobilfunk max. 0,42 €/Min.)	www.samsung.com
GEORGIA	8-800-555-555	www.samsung.com
GHANA	0800-10077 0302-200077	www.samsung.com
GREECE	80111-SAMSUNG (80111 726 7864) only from land line (+30) 210 6897691 from mobile and land line	www.samsung.com
GUATEMALA	1-800-299-0013	www.samsung.com/ latin (Spanish) www.samsung.com/ latin_en (English)
HONDURAS	800-27919267	www.samsung.com/ latin (Spanish) www.samsung.com/ latin_en (English)

Contact SAMSUNG worldwide

Country/Region	Customer Care Center	WebSite
HONG KONG	(852) 3698-4698	www.samsung.com/hk (Chinese) www.samsung.com/ hk_en (English)
HUNGARY	06-80-SAMSUNG (726-7864)	www.samsung.com
INDIA	1800 3000 8282 1800 266 8282	www.samsung.com/in
INDONESIA	0800-112-8888 021-5699-7777	www.samsung.com/id
IRAN	021-8255	www.samsung.com
ITALIA	800-SAMSUNG (726-7864)	www.samsung.com
JAMAICA	1-800-234-7267	www.samsung.com
JAPAN	0120-327-527	www.samsung.com
JORDAN	800-22273 065777444	www.samsung.com/ Levant (English)
KAZAKHSTAN	8-10-800-500-55-500 (GSM:7799)	www.samsung.com
KENYA	0800 724 000	www.samsung.com

Country/Region	Customer Care Center	WebSite
KUWAIT	183-2255 (183-CALL)	www.samsung.com/ae (English) www.samsung.com/ ae_ar (Arabic)
KYRGYZSTAN	00-800-500-55-500	www.samsung.com
LATVIA	8000-7267	www.samsung.com/lv
LITHUANIA	8-800-77777	www.samsung.com/lt
LUXEMBURG	261 03 710	www.samsung.com
MALAYSIA	1800-88-9999	www.samsung.com/ my
MEXICO	01-800-SAMSUNG (726-7864)	www.samsung.com
MOLDOVA	0-800-614-40	www.samsung.com
MONGOLIA	+7-800-555-55-55	www.samsung.com
MONTENEGRO	020 405 888	www.samsung.com
MOROCCO	080 100 2255	www.samsung.com
NAMIBIA	8197267864	www.samsung.com
NIGERIA	0800-726-7864	www.samsung.com
NETHERLANDS	0900-SAMSUNG (0900-7267864) (€ 0,10/min)	www.samsung.com
NEW ZEALAND	0800 SAMSUNG (0800 726 786)	www.samsung.com

Contact SAMSUNG worldwide

Country/Region	Customer Care Center	WebSite
NICARAGUA	00-1800-5077267	www.samsung.com/ latin (Spanish) www.samsung.com/ latin_en (English)
NORWAY	815-56 480	www.samsung.com
OMAN	800-SAMSUNG (726-7864)	www.samsung.com/ae (English) www.samsung.com/ ae_ar (Arabic)
PANAMA	800-7267	www.samsung.com/ latin (Spanish) www.samsung.com/ latin_en (English)
PARAGUAY	98005210001	www.samsung.com
PERU	0-800-777-08 (Only from landline) 336-8686 (From HHP & landline)	www.samsung.com

Country/Region	Customer Care Center	WebSite
PHILIPPINES	1-800-10-SAMSUNG(726-7864) for PLDT 1-800-3-SAMSUNG(726-7864) for Digitel 1-800-8-SAMSUNG(726-7864) for Globe 02-5805777	www.samsung.com/ph
POLAND	0 801-1SAMSUNG(172-678) * lub +48 22 607-93-33 ** * (całkowity koszt połączenia jak za 1 impuls według taryfy operatora) ** (koszt połączenia według taryfy operatora)	www.samsung.com/pl
PORTUGAL	808 20-SAMSUNG (808 20 7267)	www.samsung.com
PUERTO RICO	1-800-682-3180	www.samsung.com
QATAR	800-2255 (800-CALL)	www.samsung.com/ae (English) www.samsung.com/ ae_ar (Arabic)
ROMANIA	08008 SAMSUNG (08008 726 7864) TOLL FREE No.	www.samsung.com

Contact SAMSUNG worldwide

Country/Region	Customer Care Center	WebSite
RUSSIA	800-00-0077	www.samsung.com
SAUDI ARABIA	9200-21230	www.samsung.com/sa (Arabic)
SENEGAL	8-800-555-55-55	www.samsung.com
SERBIA	+381 11 321 6899 (old number still active 0700 7267864)	www.samsung.com
SINGAPORE	1800-SAMSUNG (726-7864)	www.samsung.com
SLOVAKIA	0800 - SAMSUNG(0800-726 786)	www.samsung.com
SOUTH AFRICA	0860 SAMSUNG (726-7864)	www.samsung.com
SPAIN	902-1-SAMSUNG(902 172 678)	www.samsung.com
SWEDEN	0771 726 7864 (SAMSUNG)	www.samsung.com
SWITZERLAND	0848-SAMSUNG (7267864, CHF 0.08/min)	www.samsung.com/ch www.samsung.com/ ch_fr/
SYRIA	18252273	www.samsung.com/ Levant (English)
TADJIKISTAN	8-10-800-500-55-500	www.samsung.com
TAIWAN	0800-329-999 0266-026-066	www.samsung.com

Country/Region	Customer Care Center	WebSite
TANZANIA	0685 88 99 00	www.samsung.com
THAILAND	1800-29-3232 02-689-3232	www.samsung.com/th
TRINIDAD & TOBAGO	1-800-SAMSUNG (726-7864)	www.samsung.com
TURKEY	444 77 11	www.samsung.com
U.A.E	800-SAMSUNG (726-7864)	www.samsung.com
U.K	0330 SAMSUNG (726-7864)	www.samsung.com
U.S.A	1-800-SAMSUNG (726-7864)	www.samsung.com
UGANDA	0800 300 300	www.samsung.com
UKRAINE	0-800-502-000	www.samsung.com/ua (Ukrainian) www.samsung.com/ ua_ru (Russian)
URUGUAY	40543733	www.samsung.com
UZBEKISTAN	8-10-800-500-55-500	www.samsung.com
VENEZUELA	0-800-100-5303	www.samsung.com
VIETNAM	1 800 588 889	www.samsung.com
ZAMBIA	211350370	www.samsung.com



The following glossary helps you get familiar with the product by understanding the terminologies commonly used with printing as well as mentioned in this user's guide.

802.11

802.11 is a set of standards for wireless local area network (WLAN) communication, developed by the IEEE LAN/MAN Standards Committee (IEEE 802).

802.11b/g/n

802.11b/g/n can share same hardware and use the 2.4 GHz band. 802.11b supports bandwidth up to 11 Mbps, 802.11n supports bandwidth up to 150 Mbps. 802.11b/g/n devices may occasionally suffer interference from microwave ovens, cordless telephones, and Bluetooth devices.

Access point

Access Point or Wireless Access Point (AP or WAP) is a device that connects wireless communication devices together on wireless local area networks (WLAN), and acts as a central transmitter and receiver of WLAN radio signals.

ADF

An Automatic Document Feeder (ADF) is a scanning unit that will automatically feed an original sheet of paper so that the machine can scan some amount of the paper at once.

AppleTalk

AppleTalk is a proprietary suite of protocols developed by Apple, Inc for computer networking. It was included in the original Mac (1984) and is now deprecated by Apple in favor of TCP/IP networking.

BIT Depth

A computer graphics term describing the number of bits used to represent the color of a single pixel in a bitmapped image. Higher color depth gives a broader range of distinct colors. As the number of bits increases, the number of possible colors becomes impractically large for a color map. 1-bit color is commonly called as monochrome or black and white.

BMP

A bitmapped graphics format used internally by the Microsoft Windows graphics subsystem (GDI), and used commonly as a simple graphics file format on that platform.

BOOTP

Bootstrap Protocol. A network protocol used by a network client to obtain its IP address automatically. This is usually done in the bootstrap process of computers or operating systems running on them. The BOOTP servers assign the IP address from a pool of addresses to each client. BOOTP enables 'diskless workstation' computers to obtain an IP address prior to loading any advanced operating system.

CCD

Charge Coupled Device (CCD) is a hardware which enables the scan job. CCD Locking mechanism is also used to hold the CCD module to prevent any damage when you move the machine.

Collation

Collation is a process of printing a multiple-copy job in sets. When collation is selected, the device prints an entire set before printing additional copies.

Control Panel

A control panel is a flat, typically vertical, area where control or monitoring instruments are displayed. They are typically found in front of the machine.

Coverage

It is the printing term used for a toner usage measurement on printing. For example, 5% coverage means that an A4 sided paper has about 5% image or text on it. So, if the paper or original has complicated images or lots of text on it, the coverage will be higher and at the same time, a toner usage will be as much as the coverage.

CSV

Comma Separated Values (CSV). A type of file format, CSV is used to exchange data between disparate applications. The file format, as it is used in Microsoft Excel, has become a de facto standard throughout the industry, even among non-Microsoft platforms.

DADF

A Duplex Automatic Document Feeder (DADF) is a scanning unit that will automatically feed and turn over an original sheet of paper so that the machine can scan on both sides of the paper.

Default

The value or setting that is in effect when taking a printer out of its box state, reset, or initialized.

DHCP

A Dynamic Host Configuration Protocol (DHCP) is a client-server networking protocol. A DHCP server provides configuration parameters specific to the DHCP client host requesting, generally, information required by the client host to participate on an IP network. DHCP also provides a mechanism for allocation of IP addresses to client hosts.

DIMM

Dual Inline Memory Module (DIMM), a small circuit board that holds memory. DIMM stores all the data within the machine like printing data, received fax data.

DLNA

The Digital Living Network Alliance (DLNA) is a standard that allows devices on a home network to share information with each other across the network.

DNS

The Domain Name Server (DNS) is a system that stores information associated with domain names in a distributed database on networks, such as the Internet.

Dot Matrix Printer

A dot matrix printer refers to a type of computer printer with a print head that runs back and forth on the page and prints by impact, striking an ink-soaked cloth ribbon against the paper, much like a typewriter.

DPI

Dots Per Inch (DPI) is a measurement of resolution that is used for scanning and printing. Generally, higher DPI results in a higher resolution, more visible detail in the image, and a larger file size.

DRPD

Distinctive Ring Pattern Detection. Distinctive Ring is a telephone company service which enables a user to use a single telephone line to answer several different telephone numbers.

Duplex

A mechanism that will automatically turn over a sheet of paper so that the machine can print (or scan) on both sides of the paper. A printer equipped with a Duplex Unit can print on both sides of paper during one print cycle.

Duty Cycle

Duty cycle is the page quantity which does not affect printer performance for a month. Generally the printer has the lifespan limitation such as pages per year. The lifespan means the average capacity of print-outs, usually within the warranty period. For example, if the duty cycle is 48,000 pages per month assuming 20 working days, a printer limits 2,400 pages a day.

ECM

Error Correction Mode (ECM) is an optional transmission mode built into Class 1 fax machines or fax modems. It automatically detects and corrects errors in the fax transmission process that are sometimes caused by telephone line noise.

Emulation

Emulation is a technique of one machine obtaining the same results as another.

An emulator duplicates the functions of one system with a different system, so that the second system behaves like the first system. Emulation focuses on exact reproduction of external behavior, which is in contrast to simulation, which concerns an abstract model of the system being simulated, often considering its internal state.

Ethernet

Ethernet is a frame-based computer networking technology for local area networks (LANs). It defines wiring and signaling for the physical layer, and frame formats and protocols for the media access control (MAC)/data link layer of the OSI model. Ethernet is mostly standardized as IEEE 802.3. It has become the most widespread LAN technology in use during the 1990s to the present.

EtherTalk

A suite of protocols developed by Apple Computer for computer networking. It was included in the original Mac (1984) and is now deprecated by Apple in favor of TCP/IP networking.

FDI

Foreign Device Interface (FDI) is a card installed inside the machine to allow a third party device such as a coin operated device or a card reader. Those devices allow the pay-for-print service on your machine.

FTP

A File Transfer Protocol (FTP) is a commonly used protocol for exchanging files over any network that supports the TCP/IP protocol (such as the Internet or an intranet).

Fuser Unit

The part of a laser printer that fuses the toner onto the print media. It consists of a heat roller and a pressure roller. After toner is transferred onto the paper, the fuser unit applies heat and pressure to ensure that the toner stays on the paper permanently, which is why paper is warm when it comes out of a laser printer.

Gateway

A connection between computer networks, or between a computer network and a telephone line. It is very popular, as it is a computer or a network that allows access to another computer or network.

Grayscale

A shade of gray that represent light and dark portions of an image when color images are converted to grayscale; colors are represented by various shades of gray.

Halftone

An image type that simulates grayscale by varying the number of dots. Highly colored areas consist of a large number of dots, while lighter areas consist of a smaller number of dots.

Mass storage device (HDD)

Mass storage device (HDD), commonly referred to as a hard drive or hard disk, is a non-volatile storage device which stores digitally-encoded data on rapidly rotating platters with magnetic surfaces.

IEEE

The Institute of Electrical and Electronics Engineers (IEEE) is an international non-profit, professional organization for the advancement of technology related to electricity.

IEEE 1284

The 1284 parallel port standard was developed by the Institute of Electrical and Electronics Engineers (IEEE). The term "1284-B" refers to a specific connector type on the end of the parallel cable that attaches to the peripheral (for example, a printer).

Intranet

A private network that uses Internet Protocols, network connectivity, and possibly the public telecommunication system to securely share part of an organization's information or operations with its employees. Sometimes the term refers only to the most visible service, the internal website.

IP address

An Internet Protocol (IP) address is a unique number that devices use in order to identify and communicate with each other on a network utilizing the Internet Protocol standard.

IPM

The Images Per Minute (IPM) is a way of measuring the speed of a printer. An IPM rate indicates the number of single-sided sheets a printer can complete within one minute.

IPP

The Internet Printing Protocol (IPP) defines a standard protocol for printing as well as managing print jobs, media size, resolution, and so forth. IPP can be used locally or over the Internet to hundreds of printers, and also supports access control, authentication, and encryption, making it a much more capable and secure printing solution than older ones.

IPX/SPX

IPX/SPX stands for Internet Packet Exchange/Sequenced Packet Exchange. It is a networking protocol used by the Novell NetWare operating systems. IPX and SPX both provide connection services similar to TCP/IP, with the IPX protocol having similarities to IP, and SPX having similarities to TCP. IPX/SPX was primarily designed for local area networks (LANs), and is a very efficient protocol for this purpose (typically its performance exceeds that of TCP/IP on a LAN).

ISO

The International Organization for Standardization (ISO) is an international standard-setting body composed of representatives from national standards bodies. It produces world-wide industrial and commercial standards.

ITU-T

The International Telecommunication Union is an international organization established to standardize and regulate international radio and telecommunications. Its main tasks include standardization, allocation of the radio spectrum, and organizing interconnection arrangements between different countries to allow international phone calls. A -T out of ITU-T indicates telecommunication.

ITU-T No. 1 chart

Standardized test chart published by ITU-T for document facsimile transmissions.

JBIG

Joint Bi-level Image Experts Group (JBIG) is an image compression standard with no loss of accuracy or quality, which was designed for compression of binary images, particularly for faxes, but can also be used on other images.

JPEG

Joint Photographic Experts Group (JPEG) is a most commonly used standard method of lossy compression for photographic images. It is the format used for storing and transmitting photographs on the World Wide Web.

LDAP

The Lightweight Directory Access Protocol (LDAP) is a networking protocol for querying and modifying directory services running over TCP/IP.

LED

A Light-Emitting Diode (LED) is a semiconductor device that indicates the status of a machine.

MAC address

Media Access Control (MAC) address is a unique identifier associated with a network adapter. MAC address is a unique 48-bit identifier usually written as 12 hexadecimal characters grouped in pairs (e. g., 00-00-0c-34-11-4e). This address is usually hard-coded into a Network Interface Card (NIC) by its manufacturer, and used as an aid for routers trying to locate machines on large networks.

MFP

Multi Function Peripheral (MFP) is an office machine that includes the following functionality in one physical body, so as to have a printer, a copier, a fax, a scanner and etc.

MH

Modified Huffman (MH) is a compression method for decreasing the amount of data that needs to be transmitted between the fax machines to transfer the image recommended by ITU-T T.4. MH is a codebook-based run-length encoding scheme optimized to efficiently compress white space. As most faxes consist mostly of white space, this minimizes the transmission time of most faxes.

MMR

Modified Modified READ (MMR) is a compression method recommended by ITU-T T.6.

Modem

A device that modulates a carrier signal to encode digital information, and also demodulates such a carrier signal to decode transmitted information.

MR

Modified Read (MR) is a compression method recommended by ITU-T T.4. MR encodes the first scanned line using MH. The next line is compared to the first, the differences determined, and then the differences are encoded and transmitted.

Glossary

NetWare

A network operating system developed by Novell, Inc. It initially used cooperative multitasking to run various services on a PC, and the network protocols were based on the archetypal Xerox XNS stack. Today NetWare supports TCP/IP as well as IPX/SPX.

OPC

Organic Photo Conductor (OPC) is a mechanism that makes a virtual image for print using a laser beam emitted from a laser printer, and it is usually green or rust colored and has a cylinder shape.

An imaging unit containing a drum slowly wears the drum surface by its usage in the printer, and it should be replaced appropriately since it gets worn from contact with the cartridge development brush, cleaning mechanism, and paper.

Originals

The first example of something, such as a document, photograph or text, etc, which is copied, reproduced or translated to produce others, but which is not itself copied or derived from something else.

OSI

Open Systems Interconnection (OSI) is a model developed by the International Organization for Standardization (ISO) for communications. OSI offers a standard, modular approach to network design that divides the required set of complex functions into manageable, self-contained, functional layers. The layers are, from top to bottom, Application, Presentation, Session, Transport, Network, Data Link and Physical.

PABX

A private automatic branch exchange (PABX) is an automatic telephone switching system within a private enterprise.

PCL

Printer Command Language (PCL) is a Page Description Language (PDL) developed by HP as a printer protocol and has become an industry standard. Originally developed for early inkjet printers, PCL has been released in varying levels for thermal, dot matrix printer, and laser printers.

PDF

Portable Document Format (PDF) is a proprietary file format developed by Adobe Systems for representing two dimensional documents in a device independent and resolution independent format.

PostScript

PostScript (PS) is a page description language and programming language used primarily in the electronic and desktop publishing areas. - that is run in an interpreter to generate an image.

Printer Driver

A program used to send commands and transfer data from the computer to the printer.

Print Media

The media like paper, envelopes, labels, and transparencies which can be used in a printer, a scanner, a fax or, a copier.

PPM

Pages Per Minute (PPM) is a method of measurement for determining how fast a printer works, meaning the number of pages a printer can produce in one minute.

PRN file

An interface for a device driver, this allows software to interact with the device driver using standard input/output system calls, which simplifies many tasks.

Protocol

A convention or standard that controls or enables the connection, communication, and data transfer between two computing endpoints.

PS

See PostScript.

PSTN

The Public-Switched Telephone Network (PSTN) is the network of the world's public circuit-switched telephone networks which, on industrial premises, is usually routed through the switchboard.

RADIUS

Remote Authentication Dial In User Service (RADIUS) is a protocol for remote user authentication and accounting. RADIUS enables centralized management of authentication data such as usernames and passwords using an AAA (authentication, authorization, and accounting) concept to manage network access.

Resolution

The sharpness of an image, measured in Dots Per Inch (DPI). The higher the dpi, the greater the resolution.

SMB

Server Message Block (SMB) is a network protocol mainly applied to share files, printers, serial ports, and miscellaneous communications between nodes on a network. It also provides an authenticated Inter-process communication mechanism.

SMTP

Simple Mail Transfer Protocol (SMTP) is the standard for e-mail transmissions across the Internet. SMTP is a relatively simple, text-based protocol, where one or more recipients of a message are specified, and then the message text is transferred. It is a client-server protocol, where the client transmits an email message to the server.

SSID

Service Set Identifier (SSID) is a name of a wireless local area network (WLAN). All wireless devices in a WLAN use the same SSID in order to communicate with each other. The SSIDs are case-sensitive and have a maximum length of 32 characters.

Subnet Mask

The subnet mask is used in conjunction with the network address to determine which part of the address is the network address and which part is the host address.

TCP/IP

The Transmission Control Protocol (TCP) and the Internet Protocol (IP); the set of communications protocols that implement the protocol stack on which the Internet and most commercial networks run.

TCR

Transmission Confirmation Report (TCR) provides details of each transmission such as job status, transmission result and number of pages sent. This report can be set to print after each job or only after failed transmissions.

TIFF

Tagged Image File Format (TIFF) is a variable-resolution bitmapped image format. TIFF describes image data that typically come from scanners. TIFF images make use of tags, keywords defining the characteristics of the image that is included in the file. This flexible and platform-independent format can be used for pictures that have been made by various image processing applications.

Toner Cartridge

A kind of bottle or container used in a machine like a printer which contains toner. Toner is a powder used in laser printers and photocopiers, which forms the text and images on the printed paper. Toner can be fused by a combination of heat/pressure from the fuser, causing it to bind to the fibers in the paper.

TWAIN

An industry standard for scanners and software. By using a TWAIN-compliant scanner with a TWAIN-compliant program, a scan can be initiated from within the program. It is an image capture API for Microsoft Windows and Apple Mac operating systems.

UNC Path

Uniform Naming Convention (UNC) is a standard way to access network shares in Window NT and other Microsoft products. The format of a UNC path is:
\\<servername>\<sharename>\<Additional directory>

URL

Uniform Resource Locator (URL) is the global address of documents and resources on the Internet. The first part of the address indicates what protocol to use, the second part specifies the IP address or the domain name where the resource is located.

USB

Universal Serial Bus (USB) is a standard that was developed by the USB Implementers Forum, Inc., to connect computers and peripherals. Unlike the parallel port, USB is designed to concurrently connect a single computer USB port to multiple peripherals.

Watermark

A watermark is a recognizable image or pattern in paper that appears lighter when viewed by transmitted light. Watermarks were first introduced in Bologna, Italy in 1282; they have been used by papermakers to identify their product, and also on postage stamps, currency, and other government documents to discourage counterfeiting.

WEP

Wired Equivalent Privacy (WEP) is a security protocol specified in IEEE 802.11 to provide the same level of security as that of a wired LAN. WEP provides security by encrypting data over radio so that it is protected as it is transmitted from one end point to another.

WIA

Windows Imaging Architecture (WIA) is an imaging architecture that is originally introduced in Windows Me and Windows XP. A scan can be initiated from within these operating systems by using a WIA-compliant scanner.

WPA

Wi-Fi Protected Access (WPA) is a class of systems to secure wireless (Wi-Fi) computer networks, which was created to improve upon the security features of WEP.

WPA-PSK

WPA-PSK (WPA Pre-Shared Key) is special mode of WPA for small business or home users. A shared key, or password, is configured in the wireless access point (WAP) and any wireless laptop or desktop devices. WPA-PSK generates a unique key for each session between a wireless client and the associated WAP for more advanced security.

WPS

The Wi-Fi Protected Setup (WPS) is a standard for establishing a wireless home network. If your wireless access point supports WPS, you can configure the wireless network connection easily without a computer.

XPS

XML Paper Specification (XPS) is a specification for a Page Description Language (PDL) and a new document format, which has benefits for portable document and electronic document, developed by Microsoft. It is an XML-based specification, based on a new print path and a vector-based device-independent document format.

Index

A

accessories	
installing	67
ordering	56
AirPrint	171
AnyWeb Print	213

B

buttons	
eco	22, 23
print screen	22, 23
wps	23

C

cleaning	
inside	74
outside	73
pickup roller	76
cleaning a machine	73
control panel	22
convention	12

D

default settings	
------------------	--

tray setting	44
device options	67
direct printing utility	201
driver installation	
Unix	139

E

eco printing	49
entering character	191
error message	95

F

favorites settings, for printing	48
features	5
machine features	176
print media feature	103

G

general icons	12
general settings	182
glossary	258
google cloud printing	173

J

jam	
clearing paper	80
tips for avoiding paper jams	79

L

layout	179
Linux	
common Linux problems	251
driver installation for network connected	138
driver installation for USB cable connected	126
driver reinstallation for USB cable connected	127
printer properties	205
printing	204
system requirements	106
unified driver configurator	230
using SetIP	132
loading	
paper in multi-purpose (or manual feeder)	
tray	38
paper in the tray1	36
paper in the tray1 / optional trays	37

Index

special media	40	menu map	178	O	
M		menu overview	30	optional tray	56
Mac		multi-purpose (or manual feeder) tray		ordering	56
common Mac problems	250	loading	38	output support	45
driver installation for network connected	137	tips on using	38	overlay printing	
driver installation for USB cable connected	124	using special media	40	create	198
driver reinstatement for USB cable connected	125	N		delete	198
printing	202	network		print	198
system requirements	106	driver installation		P	
using SetIP	131	Linux	138	paper	180
machine overview		Mac	137	Parallel	
front view	20	UNIX	139	ordering	56
rear view	21	Windows	134	placing a machine	
maintenance parts	57	general setup	186	adjusting the altitude	190
memory		installing environment	108	postScript driver	
memory upgrading	69	introducing network programs	129	troubleshooting	252
memory/hard drive feature	208	IPv6 configuration	142	print	
menu		SetIP program	130, 131, 132, 161	mobile OS	170
emulation	185	wired network setup	130	mobileprint	170
information	178	wireless network setup	145	print media	
job management	188	numeric keypad	23	card stock	43
		n-up printing		envelope	41
		Mac	203	glossy paper	44

Index

labels	42	UNIX	206	secure printing	51
output support	103	using direct printing utility	201	service contact numbers	253
preprinted paper	43	printing a document		SetIP program	130, 161
setting the paper size	44	Linux	204	Special features	189
setting the paper type	44	Mac	202	specifications	101
special media	40	UNIX	206	print media	103
transparency	42	printing feature	192	status	22, 23
printer preferences		problem		supplies	
Linux	205	operating system problems	249	available supplies	54
printer status		problems		estimated toner cartridge life	59
general information	222	paper feeding problems	235	machine information	178
printing		power problems	236	monitoring the supplies life	71
changing the default print settings	192	printing problems	237	ordering	54
Linux	204	printing quality problems	241	replacing toner cartridge	62
Mac	202			SyncThru Web Service	
multiple pages on one sheet of paper		R		general information	215
Mac	203	regulatory information	109	SyncThru™ Web Service	215
printing a document		S			
Windows	46	safety		T	
printing on both sides of paper		information	13	toner cartridge	
Mac	203	symbols	13	estimated life	59
printing to a file	193	samsung printer experience	224	handling instructions	58
setting as a default machine	192	Samsung Printer Status	222	non-Samsung and refilled	58
special printer features	194			redistributing toner	60

Index

replacing the cartridge	62
storing	58
tray	
adjusting the width and length	35
changing the tray size	35
loading paper in multi-purpose (or manual feeder) tray	38
ordering an optional tray	56
ordering an parallel	56
setting the paper size and type	44

U

understanding the status LED	92
UNIX	
driver installation for network connected	139
printing	206
Unix	
system requirements	107
USB cable	
driver installation	25, 28, 124, 126
driver reinstallation	125, 127
using help	48, 204

W

watermark	
create	197
delete	197
edit	197
Windows	
common Windows problems	249
driver installation for network connected	134
driver installation for USB cable connected	25, 28
system requirements	105
using SetIP	130, 161
wireless	
ad hoc mode	145
Infrastructure mode	145
USB cable	152
WPS	
disconnecting	149
disconnectiong	
PBC mode	149
WPS (the machine does not have a display screen)	
PBC	150
PIN	150

wireless network	
network cable	160