

## 10/100/1000 Mbps VDSL2 Ethernet Extender Kit - 1km

### Product ID

VDSL-LAN-EXTENDER-1G

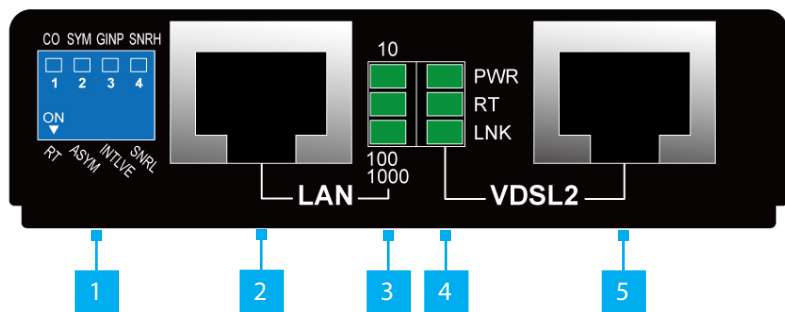

| Component | Function   |
|-----------|--|
| 1         | DIP Switches <ul style="list-style-type: none"> <li>Set the Mode or change settings on the VDSL Extenders</li> <li>Refer to DIP Switch Chart</li> </ul>  |
| 2         | LAN Port <ul style="list-style-type: none"> <li>Connect to an RJ45 Port on Local and Remote Equipment</li> </ul>   |
| 3         | LAN Status LEDs <ul style="list-style-type: none"> <li>Refer to the LED Chart</li> </ul>   |
| 4         | VDSL2 Status LEDs <ul style="list-style-type: none"> <li>Refer to the LED Chart</li> </ul>   |
| 5         | VDSL2 Port <ul style="list-style-type: none"> <li>Use a RJ45 or RJ11 Cable to connect the Local and Remote VDSL Extenders together</li> </ul>            |
| 6         | Power Input Port <ul style="list-style-type: none"> <li>Connect the included Power Adapter</li> <li>Located on the rear of each VDSL Extender</li> </ul> |

### Product Information

For the latest drivers/software, technical specifications, and declarations of conformance, please visit: [www.StarTech.com/VDSL-LAN-EXTENDER-1G](http://www.StarTech.com/VDSL-LAN-EXTENDER-1G)

### Requirements

- Ethernet Device x 2
- RJ45 Ethernet Cables x 2
- RJ45 or RJ11 Cable x 1

### Package Contents

- VDSL Extender x 2
- Mounting Bracket Kits x 2
- Power Supply x 2
- Quick-Start Guide x 1

### Installation

#### (Optional) Mounting the VDSL Extender

**Note:** Before mounting the VDSL Extender make sure that the surface you are mounting to is strong enough to support the VDSL Extender. It is recommended that the VDSL Extender is mounted on a wall stud to provide the correct support.

1. Determine the **Mounting Surface** for the **Local** and **Remote VDSL Extender**.
2. Place the **VDSL Extenders** upside down to expose the **Mounting Bracket Holes** on the **VDSL Extenders**. Align the **Holes** in the **Mounting Brackets** with the **Holes** on the bottom of the **VDSL Extenders**.
3. Insert four **Screws** through each **Mounting Bracket** and into the **VDSL Extender**.
4. Tighten each **Screw** using a **Phillips Head Screwdriver**.
5. Mount the **VDSL Extender** to the desired **Mounting Surface** using the appropriate **Mounting Hardware** (e.g. Wood Screws).

#### Install the VDSL Extender Kit

1. Position a **VDSL Extender** in each of the locations, local and remote.
2. Using **DIP Switch 1**, ensure that one **VDSL Extender** is in **Master Mode (CO)**, and the other is in **Remote Mode (RT)**.
 

**Note:** If the DIP switches need to be adjusted after the initial setup, both **VDSL Extenders** must be powered off before changing the DIP switch settings.
3. Plug in an **RJ45 Ethernet Cable** from the **LAN Port** on the local **VDSL Extender** to an **Ethernet Port** on the local **Ethernet Device**.
4. Plug in an **RJ45 Ethernet Cable** from the **LAN Port** on the remote **VDSL Extender** to an **Ethernet Port** on the remote **Ethernet Device**.
5. Plug in a **RJ45 or RJ11 Cable** from the **VDSL2 Port** of the local **VDSL Extender**, to the **VDSL2 Port** of the remote **VDSL Extender**.
6. Connect the included **Power Adapters** to each of the **VDSL Extenders**.

## LED Chart

| LED  | Colour | Blink                        | On            | Off             |
|------|--------|------------------------------|---------------|-----------------|
| PWR  | Green  | N/A                          | Powered On    | Powered Off     |
| RT   | Green  | N/A                          | RT (Remote)   | CO (Master)     |
| LNK  | Green  | Slow: Idle<br>Fast: Training | VDSL2 Link Up | VDSL2 Link Down |
| 10   | Green  | Data Activity                | 10Mbps        | Link Down       |
| 100  | Green  | Data Activity                | 100Mbps       | Link Down       |
| 1000 | Green  | Data Activity                | 1000Mbps      | Link Down       |

## VDSL2 Port Pinout

| Pin | Description         |
|-----|---------------------|
| 1   | N/A                 |
| 2   | N/A                 |
| 3   | N/A                 |
| 4   | Analog Input/Output |
| 5   | Analog Input/Output |
| 6   | N/A                 |
| 7   | N/A                 |
| 8   | N/A                 |

## Regulatory Compliance

### FCC - Part 15

This equipment has been tested and found to comply with the limits for a Class A digital device, pursuant to part 15 of the FCC Rules. These limits are designed to provide reasonable protection against harmful interference in a residential installation.

This equipment generates, uses and can radiate radio frequency energy and, if not installed and used in accordance with the instructions, may cause harmful interference to radio communications. However, there is no guarantee that interference will not occur in a particular installation. If this equipment does cause harmful interference to radio or television reception, which can be determined by turning the equipment off and on, the user is encouraged to try to correct the interference by one or more of the following measures:

- Connect the equipment into an outlet on a circuit different from that to which the receiver is connected.
- Consult the dealer or an experienced radio/TV technician for help

This device complies with part 15 of the FCC Rules. Operation is subject to the following two conditions:

- (1) This device may not cause harmful interference, and (2) this device must accept any interference received, including interference that may cause undesired operation. Changes or modifications not expressly approved by StarTech.com could void the user's authority to operate the equipment.

### Industry Canada Statement

This Class A digital apparatus complies with Canadian ICES-003.

Cet appareil numérique de la classe [A] est conforme à la norme NMB-003 du Canada.

CAN ICES-3 (A)/NMB-3(A)

This device complies with Industry Canada licence-exempt RSS standard(s). Operation is subject to the following two conditions:









- (1) This device may not cause interference, and (2) This device must accept any interference, including interference that may cause undesired operation of the device.

Le présent appareil est conforme aux CNR d'Industrie Canada applicables aux appareils radio exempts de licence. L'exploitation est autorisée aux deux conditions suivantes:

- (1) l'appareil ne doit pas produire de brouillage, et (2) l'utilisateur de l'appareil doit accepter tout brouillage radioélectrique subi, même si le brouillage est susceptible d'en compromettre le fonctionnement.

## DIP Switches

**Note:** The VDSL Extender that is set to Remote mode will always follow the settings set on the Master VDSL Extender. When set to Remote Mode, DIP Switches 2, 3, and 4 have no function.

| No | CO DIP Switch   | Symmetrical/<br>Asymmetrical | G.INP/<br>Interleaved<br>Mode | SNR High/Low | Max Line<br>Rate US/DS<br>(Mbps) |
|----|---|------------------------------|-------------------------------|--------------|----------------------------------|
| 1  |  | Symmetrical                  | G.INP                         | High         | 146/162                          |
| 2  |  | Symmetrical                  | G.INP                         | Low          | 152/162                          |
| 3  |  | Symmetrical                  | Interleaved                   | High         | 139/151                          |
| 4  |  | Symmetrical                  | Interleaved                   | Low          | 148/151                          |
| 5  |  | Asymmetrical                 | G.INP                         | High         | 66/341                           |
| 6  |  | Asymmetrical                 | G.INP                         | Low          | 66/341                           |
| 7  |  | Asymmetrical                 | Interleaved                   | High         | 63/329                           |
| 8  |  | Asymmetrical                 | Interleaved                   | Low          | 65/328                           |

## Warranty Information

This product is backed by a two year warranty.

For further information on product warranty terms and conditions, please refer to [www.startech.com/warranty](http://www.startech.com/warranty).

## Limitation of Liability

In no event shall the liability of StarTech.com Ltd. and StarTech.com USA LLP (or their officers, directors, employees or agents) for any damages (whether direct or indirect, special, punitive, incidental, consequential, or otherwise), loss of profits, loss of business, or any pecuniary loss, arising out of or related to the use of the product exceed the actual price paid for the product. Some states do not allow the exclusion or limitation of incidental or consequential damages. If such laws apply, the limitations or exclusions contained in this statement may not apply to you.

## Use of Trademarks, Registered Trademarks, and other Protected Names and Symbols

This manual may make reference to trademarks, registered trademarks, and other protected names and/or symbols of third-party companies not related in any way to StarTech.com. Where they occur these references are for illustrative purposes only and do not represent an endorsement of a product or service by StarTech.com, or an endorsement of the product(s) to which this manual applies by the third-party company in question. StarTech.com hereby acknowledges that all trademarks, registered trademarks, service marks, and other protected names and/or symbols contained in this manual and related documents are the property of their respective holders.

**StarTech.com Ltd.**

45 Artisans Cres  
London, Ontario  
N5V 5E9  
Canada

**StarTech.com LLP**

4490 South Hamilton  
Road  
Groveport, Ohio  
43125  
U.S.A.

**StarTech.com Ltd.**

Unit B, Pinnacle 15  
Gowerton Rd,  
Brackmills  
Northampton  
NN4 7BW  
United Kingdom

**StarTech.com Ltd.**

Siriusdreef 17-27  
2132 WT Hoofddorp  
The Netherlands

FR: [startech.com/fr](http://startech.com/fr)  
DE: [startech.com/de](http://startech.com/de)  
ES: [startech.com/es](http://startech.com/es)  
NL: [startech.com/nl](http://startech.com/nl)  
IT: [startech.com/it](http://startech.com/it)  
JP: [startech.com/jp](http://startech.com/jp)